

Specialties note

Matching instructions



This model adopts RF remote control. The remote controller shall be matched with the air conditioner before operation, otherwise the remote control will be invalid.

Before operation, please read the instructions in this page carefully and then do the corresponding matching operation.

• Note •

- ▶ Please do the following operation within 2m from the unit. Matching is not needed anymore once it is done.
- ▶ During matching, please keep the remote controller and air conditioner under standby status.
- ▶ When the signal of remote controller can't be received, please match the remote controller with the unit again.

Matching of remote controller

When the unit is under standby status, please get close to the air conditioner within 2m and then hold on pressing **Humidify/Health** button for 3s. The remote controller and air conditioner will enter matching automatically. If matching is done, the unit will give out three sounds; if matching is failed, please get closer to the unit and arrange matching again.

Explanation of Symbols



Indicates a hazardous situation that, if not avoided, will result in death or serious injury.



Indicates a hazardous situation that, if not avoided, could result in death or serious injury.



Indicates a hazardous situation that, if not avoided, may result in minor or moderate injury.



Indicates important but not hazard-related information, used to indicate risk of property damage.



Indicates a hazard that would be assigned a signal word WARNING or CAUTION.



WARNING

Operation and Maintenance

- This appliance is not intended for use by persons (including children) with reduced physical, sensory or mental capabilities, or lack of experience and knowledge, unless they have been given supervision or instruction concerning use of the appliance by a person responsible for their safety. Children should be supervised to ensure that they do not play with the appliance.
- Children shall not play with the appliance.
- Cleaning and user maintenance shall not be made by children without supervision.
- Do not connect air conditioner to multi-purpose socket. Otherwise, it may cause fire hazard.
- Do disconnect power supply when cleaning air conditioner. Otherwise, it may cause electric shock.
- If the supply cord is damaged, it must be replaced by the manufacturer, its service agent or similarly qualified persons in order to avoid a hazard.
- Do not wash the air conditioner with water to avoid electric shock.
- Do not spray water on indoor unit. It may cause electric shock or malfunction.
- After removing the filter, do not touch fins to avoid injury.
- Do not use fire or hair dryer to dry the filter to avoid deformation or fire hazard.

Precautions



WARNING

- Maintenance must be performed by qualified professionals. Otherwise, it may cause personal injury or damage.
- Do not repair air conditioner by yourself. It may cause electric shock or damage. Please contact dealer when you need to repair air conditioner.
- Do not extend fingers or objects into air inlet or air outlet. It may cause personal injury or damage.
- Do not block air outlet or air inlet. It may cause malfunction.
- Do not spill water on the remote controller, otherwise the remote controller may be broken.
- When below phenomenon occurs, please turn off air conditioner and disconnect power immediately, and then contact the dealer or qualified professionals for service.
 - Power cord is overheating or damaged.
 - There's abnormal sound during operation.
 - Circuit break trips off frequently.
 - Air conditioner gives off burning smell.
 - Indoor unit is leaking.
- If the air conditioner operates under abnormal conditions, it may cause malfunction, electric shock or fire hazard.
- When turning on or turning off the unit by emergency operation switch, please press this switch with an insulating object other than metal.
- Do not step on top panel of outdoor unit, or put heavy objects. It may cause damage or personal injury.

Precautions



WARNING

Attachment

- Installation must be performed by qualified professionals. Otherwise, it may cause personal injury or damage.
- Must follow the electric safety regulations when installing the unit.
- According to the local safety regulations, use qualified power supply circuit and circuit break.
- Do install the circuit break. If not, it may cause malfunction.
- An all-pole disconnection switch having a contact separation of at least 3mm in all poles should be connected in fixed wiring.
- Including an circuit break with suitable capacity, please note the following table. Air switch should be included magnet buckle and heating buckle function, it can protect the circuit-short and overload.
- Air Conditioner should be properly grounded. Incorrect grounding may cause electric shock.
- Don't use unqualified power cord.
- Make sure the power supply matches with the requirement of air conditioner. Unstable power supply or incorrect wiring or malfunction. Please install proper power supply cables before using the air conditioner.
- Properly connect the live wire, neutral wire and grounding wire of power socket.
- Be sure to cut off the power supply before proceeding any work related to electricity and safety.

Precautions



WARNING

- Do not put through the power before finishing installation.
- If the supply cord is damaged, it must be replaced by the manufacturer, its service agent or similarly qualified persons in order to avoid a hazard.
- The temperature of refrigerant circuit will be high, please keep the interconnection cable away from the copper tube.
- The appliance shall be installed in accordance with national wiring regulations.
- Installation must be performed in accordance with the requirement of NEC and CEC by authorized personnel only.
- The air conditioner is the first class electric appliance. It must be properly grounding with specialized grounding device by a professional. Please make sure it is always grounded effectively, otherwise it may cause electric shock.
- The yellow-green wire in air conditioner is grounding wire, which can't be used for other purposes.
- The grounding resistance should comply with national electric safety regulations.
- The appliance must be positioned so that the plug is accessible.
- All wires of indoor unit and outdoor unit should be connected by a professional.
- If the length of power connection wire is insufficient, please contact the supplier for a new one. Avoid extending the wire by yourself.

Precautions



WARNING

- For the air conditioner with plug, the plug should be reachable after finishing installation.
- For the air conditioner without plug, an circuit break must be installed in the line.
- If you need to relocate the air conditioner to another place, only the qualified person can perform the work. Otherwise, it may cause personal injury or damage.
- Select a location which is out of reach for children and far away from animals or plants. If it is unavoidable, please add the fence for safety purpose.
- The indoor unit should be installed close to the wall.
- Instructions for installation and use of this product are provided by the manufacturer.



FCC WARNING

WARNING: Changes or modifications to this unit not expressly approved by the party responsible for compliance could void the user's authority to operate the equipment.



FCC STATEMENT

This device complies with Part 15 of the FCC Rules. Operation is subject to the following two conditions :



FCC STATEMENT

(1) this device may not cause harmful interference, and (2) this device must accept any interference received, including interference that may cause undesired operation.

NOTE: This equipment has been tested and found to comply with the limits for a Class B digital device, pursuant to part 15 of the FCC Rules. These limits are designed to provide reasonable protection against harmful interference in a residential installation. This equipment generates, uses and can radiate radio frequency energy and, if not installed and used in accordance with the instructions, may cause harmful interference to radio communications.

However, there is no guarantee that interference will not occur in a particular installation. If this equipment does cause harmful interference to radio or television reception, which can be determined by turning the equipment off and on, the user is encouraged to try to correct the interference by one or more of the following measures:

- Reorient or relocate the receiving antenna.
- Increase the separation between the equipment and receiver.
- Connect the equipment into an outlet on a circuit different from that to which the receiver is connected.
- Consult the dealer or an experienced radio/TV technician for help.

Precautions



IC STATEMENT

This device complies with Industry Canada licence-exempt RSS standard(s). Operation is subject to the following two conditions: (1) this device may not cause interference, and (2) this device must accept any interference, including interference that may cause undesired operation of the device.

Le présent appareil est conforme aux CNR d'Industrie Canada applicables aux appareils radio exempts de licence. L'exploitation est autorisée aux deux conditions suivantes : (1) l'appareil ne doit pas produire de brouillage, et (2) l'utilisateur de l'appareil doit accepter tout brouillage radioélectrique subi, même si le brouillage est susceptible d'en compromettre le fonctionnement.

This equipment complies with FCC's and IC's RF radiation exposure limits set forth for an uncontrolled environment. The antenna(s) used for this transmitter must be installed and operated to provide a separation distance of at least 20 cm from all persons and must not be collocated or operating in conjunction with any other antenna or transmitter. Installers must ensure that 20cm separation distance will be maintained between the device (excluding its handset) and users.

Cet appareil est conforme aux limites d'exposition au rayonnement RF stipulées par la FCC et l'IC pour une utilisation dans un environnement non contrôlé. Les

Precautions



IC STATEMENT

antennes utilisées pour cet émetteur doivent être installées et doivent fonctionner à au moins 20 cm de distance des utilisateurs et ne doivent pas être placées près d'autres antennes ou émetteurs ou fonctionner avec ceux-ci. Les installateurs doivent s'assurer qu'une distance de 20 cm sépare l'appareil (à l'exception du combiné) des utilisateurs.

Working temperature range

	Indoor side DB/WB(°C)	Outdoor side DB/WB(°C)
Maximum cooling	26.7/19.4	46.1/23.9
Maximum heating	26.7/-	23.9/18.3

NOTICE:

- The operating temperature range (outdoor temperature) for cooling only unit is -18 °C ~54°C ; for heat pump unit is -30 °C ~ 54°C .

Buttons on remote controller

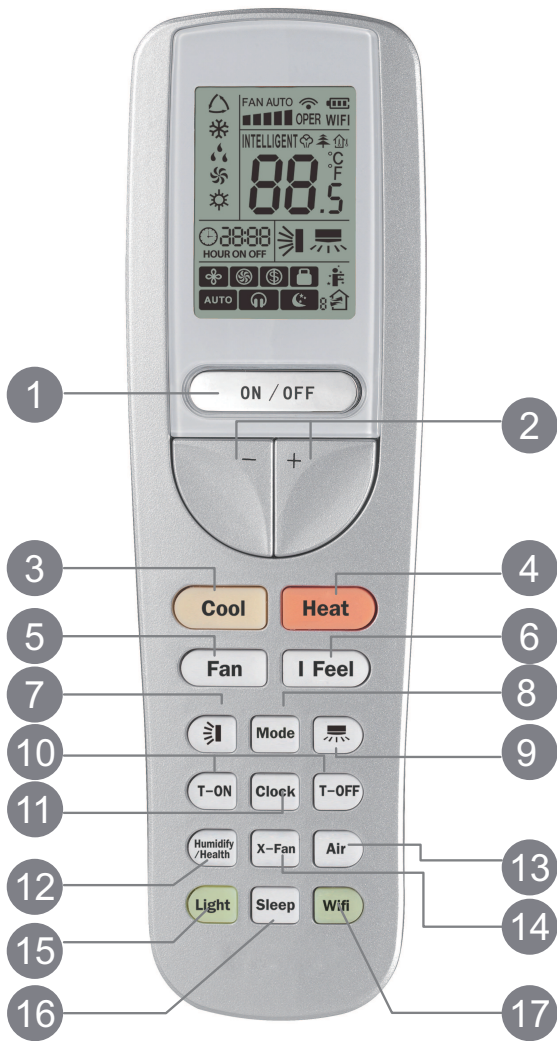

- 1 ON/OFF button
- 2 +/- button
- 3 Cool button
- 4 Heat button
- 5 Fan button
- 6 I FEEL button
- 7 up down swing button
- 8 Mode button
- 9 Left right swing button
- 10 T-ON/T-OFF button
- 11 Clock button
- 12 Humidity button/Health button
- 13 Air button
- 14 X-fan button
- 15 Light button
- 16 Sleep button
- 17 WIFI button

Introduction for icons on display screen

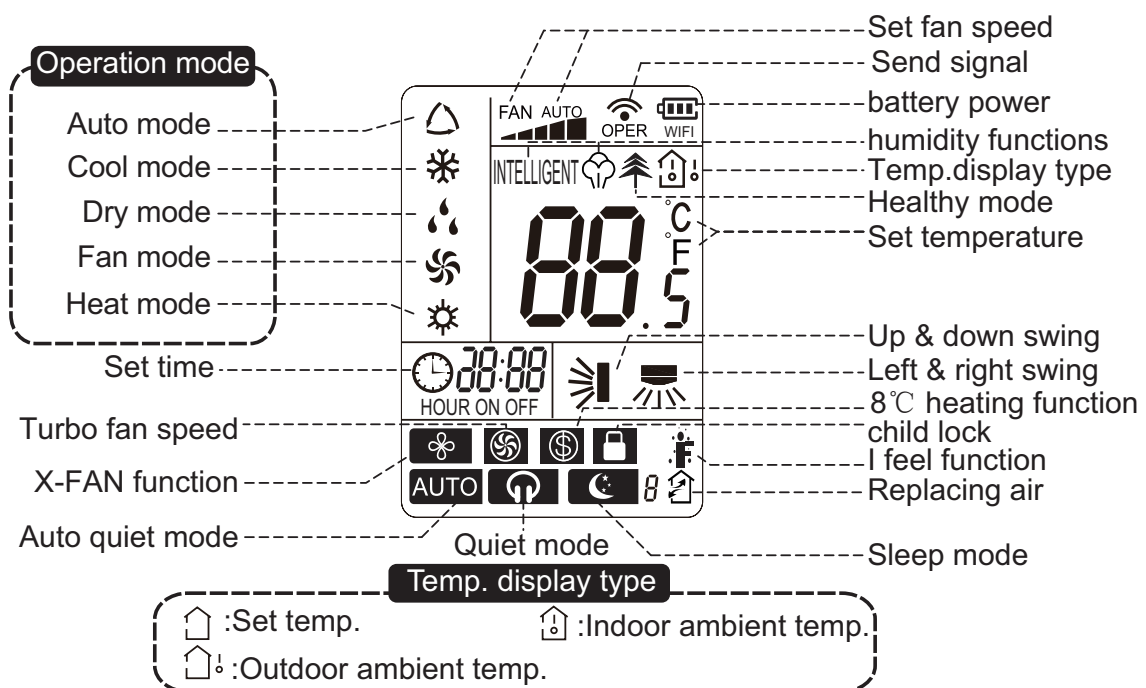

Introduction for buttons on remote controller

Note:

- After putting through the power, the air conditioner will give out a sound. Operation indicator "⏻" is ON (red indicator). After that, you can operate the air conditioner by using remote controller.
- Under on status, pressing the button on the remote controller, the signal icon "📶" on the display of remote controller will blink once and the air conditioner will give out a "de" sound, which means the signal has been sent to the air conditioner.

1 ON/OFF button

Press this button can turn on or turn off the air conditioner. After turning on the air conditioner, operation indicator "⏻" on indoor unit's display is ON (green indicator. The colour is different for different models), and indoor unit will give out a sound.

2 +/- button

- Press "+" or "-" button once increase or decrease set temperature 0.5 °C. Holding "+" or "-" button, 2s later, set temperature on remote controller will change quickly. On releasing button after setting is finished, temperature indicator on indoor unit will change accordingly. (Temperature can't be adjusted under auto mode)
- When setting TIMER, press "+" or "-" button to adjust time.

3 Cool button

- Press this button, unit will operate in cool mode.

4 Heat button

- Press this button, unit will operate in heat mode.

5 FAN button

Pressing this button can set fan speed circularly as: low(■), low medium(■■), medium (■■■), medium high(■■■■), high(■■■■■), super(⊕), auto(AUTO), quiet(🔇).



Note:

- Turbo function is not available under dry and auto mode.
- Automatically operate silent speed when starting sleep function.
- The unit operates at low speed under dry and auto dry mode. The speed can't be adjusted.
- Under AUTO speed, air conditioner will select proper fan speed automatically according to ambient temperature.





Introduction for buttons on remote controller

6 I FEEL button

Press this button to start I FEEL function and "⊞" will be displayed on the remote controller. After this function is set, the remote controller will send the detected ambient temperature to the controller and the unit will automatically adjust the indoor temperature according to the detected temperature. Press this button again to close I FEEL function and "⊞" will disappear.

- Please put the remote controller near user when this function is set. Do not put the remote controller near the object of high temperature or low temperature in order to avoid detecting inaccurate ambient temperature.

7 button

- Under simple swing mode, press this button can turn on (display "  " icon) or turn off (not display "  " icon) left&right swing function.
- Under OFF status, press "+" button and "  " button simultaneously can switch between simple swing mode and fixed swing mode. During switching time, "  " icon on remote controller will flash twice.
- Under fixed-angle swing mode, press this button and the left and right swing status will change in the sequence as below:

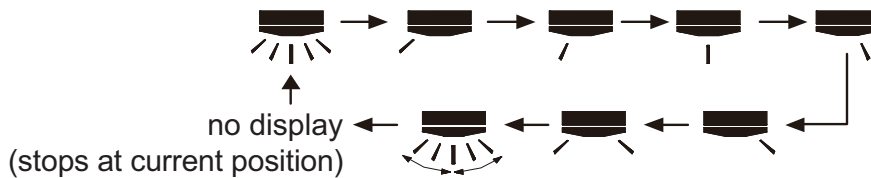

8 MODE button

Press this button to select your required operation mode.

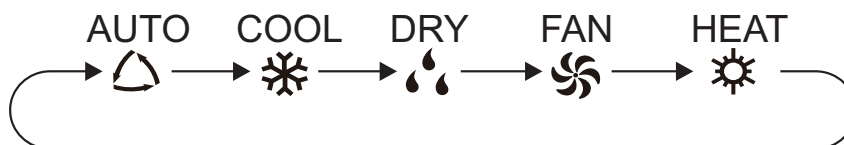

Introduction for buttons on remote controller

10 T-ON/T-OFF button

● T-ON button

“T-ON” button can set the time for timer on. After pressing this button, "🕒" icon disappears and the word “ON” on remote controller blinks. Press “+” or “-” button to adjust T-ON setting. After each pressing “+” or “-” button, T-ON setting will increase or decrease 1min. Hold “+” or “-” button, 2s later, the time will change quickly until reaching your required time. Press “T-ON” to confirm it. The word “ON” will stop blinking. "🕒" icon resumes displaying. Cancel TIMER ON: Under the condition that T-ON is started up, press “T-ON” button to cancel it.

● T-OFF button

“T-OFF” button can set the time for timer off. After pressing this button, "🕒" icon disappears and the word "OFF" on remote controller blinks. Press "+" or "-" button to adjust T-OFF setting. After each pressing "+" or "-" button, T-OFF setting will increase or decrease 1min. Hold "+" or "-" button, 2s later, the time will change until reaching your required time. Press “T-OFF” to confirm it. The word “ON” will "OFF" will stop blinking. "🕒" icon resumes displaying. Cancel T-OFF. Under the condition that T-OFF is started up, press “T-OFF” button to cancel it.

Note:

- Under on and off status, you can set T-OFF or T-ON simultaneously.
- Before setting T-ON or T-OFF, please adjust the clock time.
- After starting up T-ON or T-OFF, set the constant circulating valid. After that, air conditioner will be turned on or turned off according to setting time. ON/OFF button has no effect on setting. If you don't need this function, please use remote controller to cancel it.

11 CLOCK button

Press this button to set clock time. "🕒" icon on remote controller will blink. Press "+" or "-" button within 5s to set clock time. Each pressing of "+" or "-" button, clock time will increase or decrease 1 minute. Hold "+" or "-" button, 2s later, time will change quickly. Release this button when reaching your required time. Press “CLOCK” button to confirm the time. "🕒" icon stops blinking.

Note:

- Clock time adopts 24-hour mode.
- The interval between two operations can't exceeds 5s. Otherwise, remote controller will quit setting status. Operation for TIMER ON/TIMER OFF is the same.

Introduction for buttons on remote controller

12 Humidity/health button

Press this button to select your required operation mode.



Note:there is no this function for this unit. If press this button,the main unit will click, but it also runs under original status.

13 X-FAN button

Pressing this button in COOL or DRY mode, the icon "  " is displayed and the indoor fan will continue operation for 2 minutes in order to dry the indoor unit even though you have turned off the unit. After energization, X-FAN OFF is defaulted. X-FAN is not available in AUTO, FAN or HEAT mode.

This function indicates that moisture on evaporator of indoor unit will be blowed after the unit is stopped to avoid mould.

- Having set X-FAN function on: After turning off the unit by pressing ON/OFF button indoor fan will continue running for about 2 min. at low speed. In this period, press X-FAN button to stop indoor fan directly.
- Having set X-FAN function off: After turning off the unit by pressing ON/OFF button, the complete unit will be off directly.

14 Air button

Press this button to select your required operation mode.

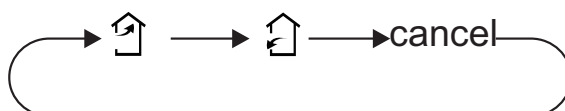

Note:there is no this function for this unit. If press this button,the main unit will click, but it also runs under original status.

15 LIGHT button

Pressing this button to turn off display light on indoor unit. Press this button again to turn on display light.

16 SLEEP button

- Pressing this button can select Sleep 1, Sleep 2,Sleep 3, Sleep 4 or cancel Sleep circularly as below:

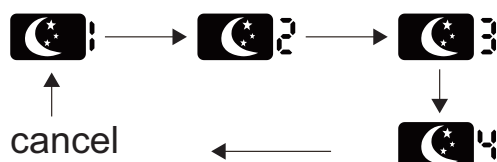

Introduction for buttons on remote controller

- In Sleep 1 and Sleep 2, the air conditioner will run according to a group of presetting temperature curves.
- Sleep 3 - the sleep curve setting under DIY Sleep mode:
 - (1) Under Sleep 3 mode, long press "AIR" button, the remote controller will enter the setting of personalized sleep. In this case, the timer zone of remote controller will display "1 hr" and the set temperature zone "88" will display the corresponding temperature of the last set sleep curve and blink (The first entering will display according to the initial curve setting value of manufacturer);
 - (2) Press "+" and "-" button to adjust the corresponding temperature. After adjusting, press "AIR" button to confirm it;
 - (3) At this time, the timer time on the remote controller will increase automatically by 1hr (that is "2 hr" or "3 hr" ... or "8 hr"). The set temperature zone "88" will display the corresponding temperature of the last set sleep curve and blink;
 - (4) Repeat step(2) and step (3) until 8-hour temperature setting is finished, then the sleep curve is set successfully. After that, remote controller will resume displaying the original timer time and temperature zone will resume displaying the original set temperature.
- Sleep 3 - the sleep curve inquiry under DIY Sleep mode:

User can inquire the set sleep curve according to the setting method of sleep curve. Enter the setting of personalized sleep but do not change the temperature. Then press "AIR" button to confirm the setting.

Note: In the above setting or inquiry procedure, if there is no button pressing within 10s, remote controller will automatically exit the sleep curve setting and resume the HEATING button is pressed during the setting or inquiry procedure, remote controller original display. If ON/OFF, MODE, TIMER, HUMIDIFY, SLEEP, COOLING or will also exit the sleep curve setting.
- Sleep 4 is Siesta mode. The set temperature will change automatically according to the features of siesta.
- Sleep function will be disabled if the air condition is restarted after power failure; when sleep function is turned on, quite fan speed will be also turned on.
- Sleep function can not be set in AUTO mode.

17 Wifi button

- Press this button 3s can set wifi function on or OFF.
- At OFF status, press mode button and wifi button, can reset wifi mode parameter. and open wifi function.

Function introduction for combination buttons

About X-FAN function

This function indicates that moisture on evaporator of indoor unit will be blowed after the unit is stopped to avoid mould.

1. Having set X-FAN function on: After turning off the unit by pressing ON/OFF button indoor fan will continue running for about 2 min. at low speed. In this period, press X-FAN button to stop indoor fan directly.
2. Having set X-FAN function off: After turning off the unit by pressing ON/OFF button, the complete unit will be off directly.

About AUTO RUN

When AUTO RUN mode is selected, the setting temperature will not be displayed on the LCD, the unit will be in accordance with the room temp. automatically to select the suitable running method and to make ambient comfortable.

About lock

Press + and - buttons simultaneously to lock or unlock the keyboard. If the remote controller is locked, the icon  will be displayed on it, in which case, press any button, the mark will flicker for three times. If the keyboard is unlocked, the mark will disappear.

About switch between Fahrenheit and Centigrade

Under status of unit off, press MODE and - buttons simultaneously to switch °C and °F.

Operation guide

1. After putting through the power, press "ON/OFF" button on remote controller to turn on the air conditioner.
2. Press "MODE" button to select your required mode: AUTO, COOL, DRY, FAN, HEAT.
3. Press "+" or "-" button to set your required temperature. (Temperature can't be adjusted under auto mode).
4. Press "FAN" button to set your required fan speed: auto, low, medium and high speed.
5. Press "SWING" button to select fan blowing angle.

Replacement of batteries in remote controller

1. Press the back side of remote controller marked with "OPEN", as shown in the fig, and then push out the cover of battery box along the arrow direction.
2. Replace two 7# (AAA 1.5V) dry batteries, and make sure the position of "+" polar and "-" polar are correct.
3. Reinstall the cover of battery box.

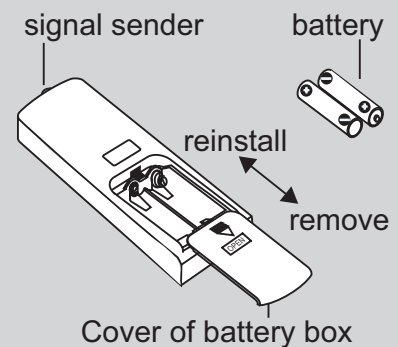

Battery level will be displayed on the remote controller. When "  " is flickering, please replace the batteries, otherwise, remote controller can't operate normally.

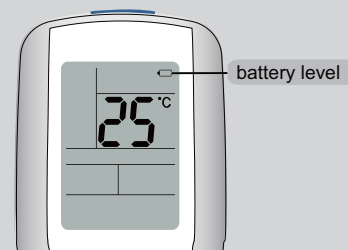

- During operation, point the remote control signal sender at the receiving window on indoor unit.
- The distance between signal sender and receiving window should be no more than 8m, and there should be no obstacles between them.
- Signal may be interfered easily in the room where there is fluorescent lamp or wireless telephone; remote controller should be close to indoor unit during operation.
- Replace new batteries of the same model when replacement is required.
- When you don't use remote controller for a long time, please take out the batteries.
- If the display on remote controller is fuzzy or there's no display, please replace batteries.

Operation of Smart Control (Smart Phone, Tablet PC)

Special Function

How to operate AC or auxiliary device with smart phone or tablet PC after matching:
First of all: before using smart connection function, please make sure your smart phone or tablet computer uses the standard Android or iOS operating system.
Please refer to the application program for the specific version. This air conditioner can connect 4 smart phones or tablet computers in maximum.

1. Install G-Life on your smart phone/ tablet PC

Method 1: Enter Gree official website to download http://www.gree.com/english/downloadcenter/ihome_jsp_catid_2840.shtml

Method 2: Scan the QR code and download the application directly (If your device is not compatible, please download the application in other ways.)



Method 3: Users of iOS system can search the application “G-Life” through Apple’s App Store. After it is successfully installed, you will see the picture below. Following is the example using iPhone 6. (The interface of the application may vary as it is upgraded or used in different operating systems. Please refer to actual application.)



Operation of Smart Control (Smart Phone, Tablet PC)

2. Turn on the AC WiFi:

Turn the AC on. First, make sure the remote controller is matched. Then, long-press “WiFi” button on the remote controller for at least 3 seconds. If WiFi icon is shown, it means the WiFi function is turned on.

3. Enter the WiFi setting of your phone and search for the wireless network named G-xxxxxxx. Take G-A0B40030 as an example. Connect the network.

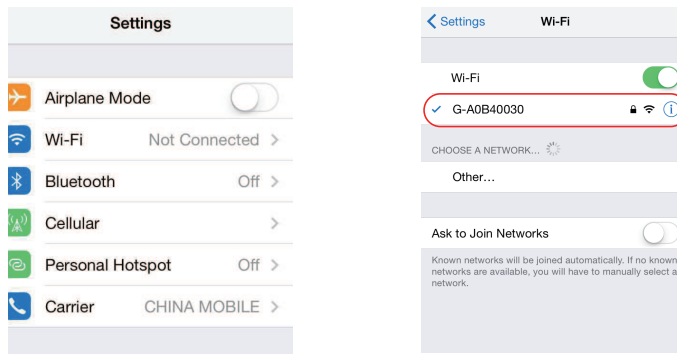

4. Input the original password 12345 or 12345678 to connect the network.

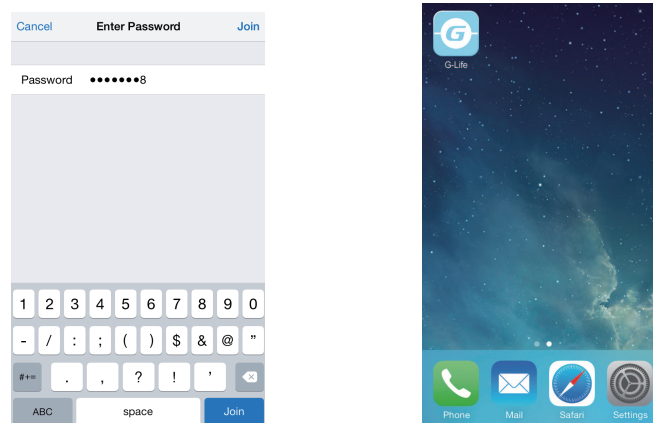

5. Open the application software and click “Refresh”, and then system will link with the air conditioner automatically. Click “⏻” to turn on the control function, and then click any position on the interface and then software will switch to the remote control interface.

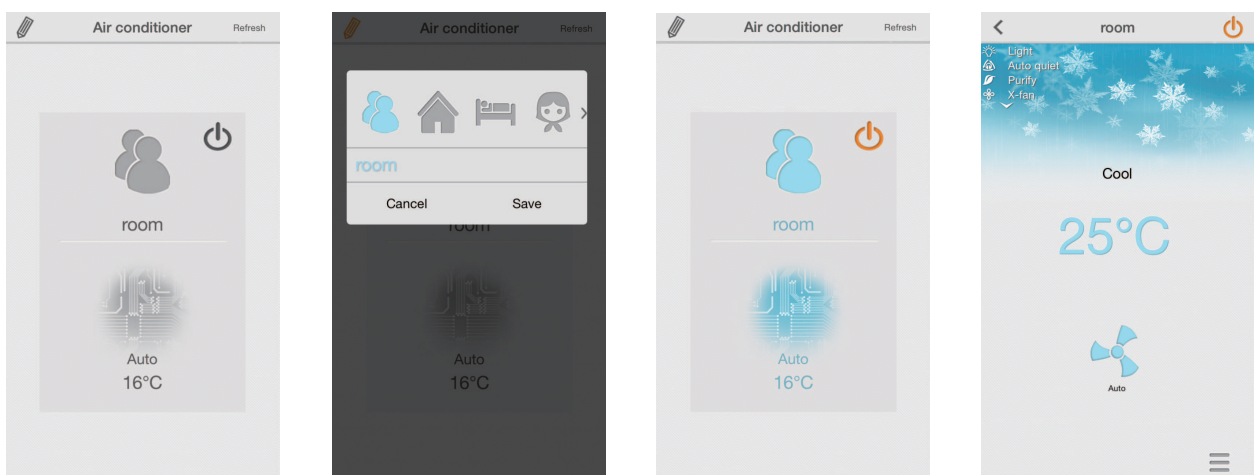

Operation of Smart Control (Smart Phone, Tablet PC)

Attention: please change the name and key of the network during the first setting!

6. Left-slide the bottom function bar to “Settings” and click it to enter into internet setting interface. Click “Network Setting”, and input user name and password (the defaulted user name and password is admin) in the “Login” dialog box to enter into “Network Setting” to modify network name (e.g. G-myhome) and password (refer to the attachment: safe mode and password instruction).

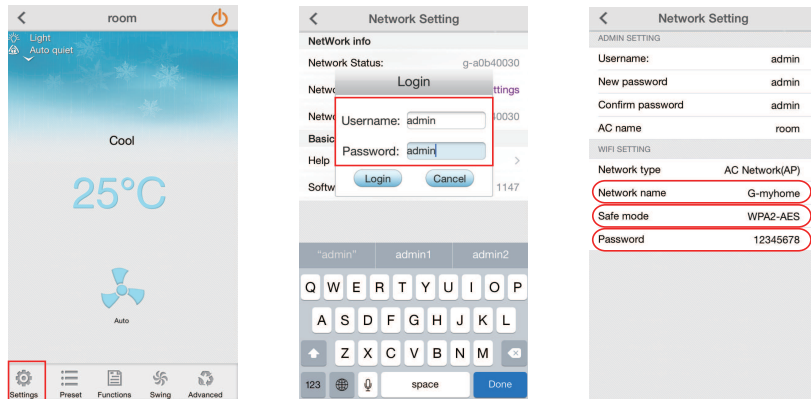

7. After modifying name and password, click it to return and there will be a prompt box, and then click “OK” to finish the modification. Meanwhile, the software will turn back to interface of “Air-Conditioner” and the AC list will be gone.

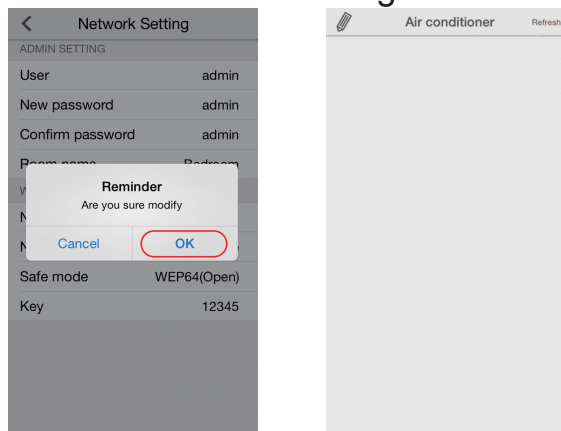

8. Exit the application and enter your phone’s WiFi Setting. Then you will see the network you just named “G-myhome”. Click it and input the password set in step 6 to join the network.

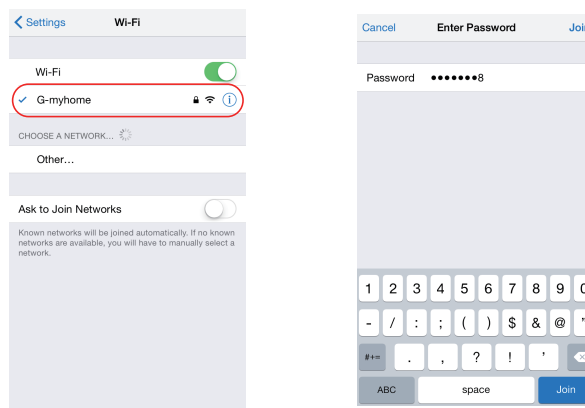

Operation of Smart Control (Smart Phone, Tablet PC)

9. Enter into the software interface again. Meanwhile, the short-distance remote control setting for your air conditioner is finished.

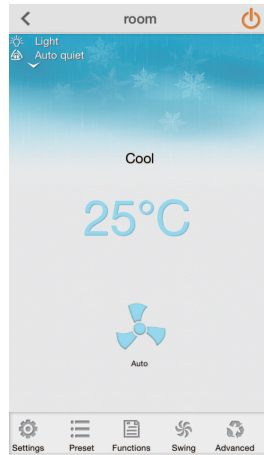

How to reset the AC WiFi module:

Turn unit off with the remote controller and disconnect the power of AC. Then re-connect the power. 1 minute later, press “WiFi” and “Mode” buttons simultaneously. If the AC gives out a beep sound, it means the WiFi module is successfully reset. Attention: Operation of the buttons is only effective in 2 minutes.

Analysis on Common Network Setting Failure:

1. If short-distance control fails, please check the following items one by one!
 - Make sure AC is power connected;
 - Make sure AC's WiFi function is turned on as normal;
 - Make sure your phone's WiFi selects the corresponding AC;
 - Reset with the remote controller and then start setting again from step 3.

Kindly remind:

1. The air conditioner WiFi function needs about 1 minute to start up.
2. The air conditioner has memory function.
3. Those models have no long-distance control.

Operation of Smart Control (Smart Phone, Tablet PC)

Function Introduction on Main Interface

1. Mode: It used for setting operation mode for air conditioner. You can select “Auto”, “Cooling”, “Drying”, “Fan” or “Heating” according to your requirement. Please refer to the part of remote controller for the detailed operation.

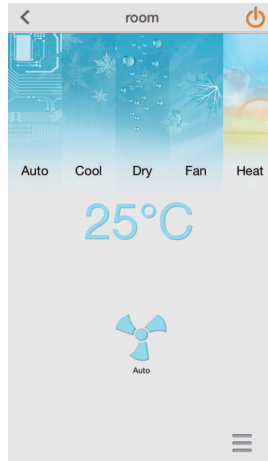

2. Temperature: It used for setting temperature. Set the indoor temperature according to your requirement.

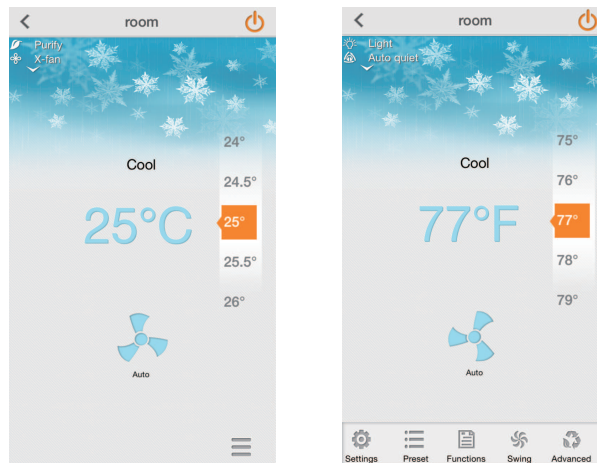

3. Fan Speed: It used for setting fan speed. Under cooling or heating mode, if the noise-customized function is turned on, adjust the fan speed and then the noise-customized function will be turned off automatically. Please refer to the part of remote controller for detailed operation.

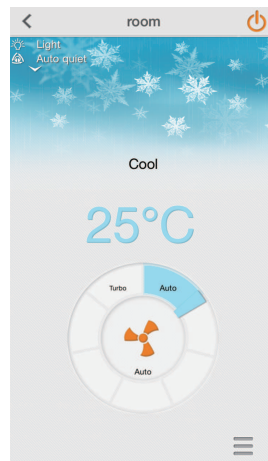

Operation of Smart Control (Smart Phone, Tablet PC)

Key Functions Instruction of Application Software

1. Preset: It's with Timer On and Timer Off function. User can set Timer On and Timer Off according to actual individual requirement.

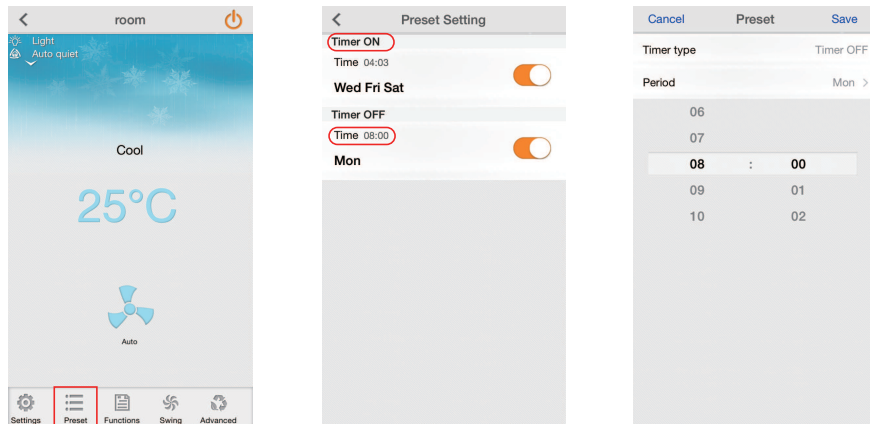

2. Functions: After entering setting interface, you can turn on or turn off Light, Purify, X-fan and Turbo functions and set Silent, Humidify, Air exchange and other modes. Please refer to the part of remote controller for the function instruction. Among that, Purify, Humidify, Air exchange functions can be set through equipping with special air purifier, humidifier. E-heater is not available for this unit.

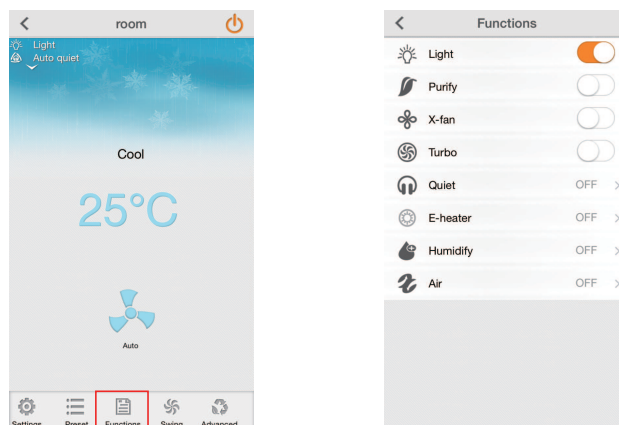

3. Swing: During up&down swing and left&right swing, it's the fixed angle swing when those two sliding blocks are combined together and full swing when they are separated. When setting up&down swing, the program will turn off regional swing function. However, no influence for regional swing when setting left&right swing.

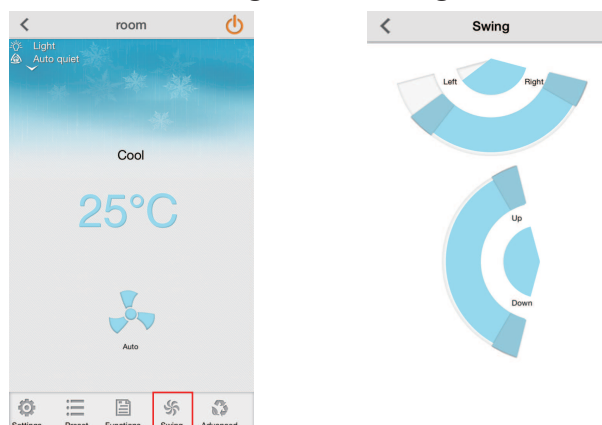

Operation of Smart Control (Smart Phone, Tablet PC)

4. Advanced: After entering advanced interface, you can set Sleep curve, Regional Swing, Noise and Power saving.

- Sleep curve: Sleep curve includes DIY mode, Traditional mode, Expert mode and Siesta mode. Under DIY mode, you can set temperature and time. Under auto mode and fan mode, sleep curve function can't be turned on. Only Traditional mode can be selected under dry mode.

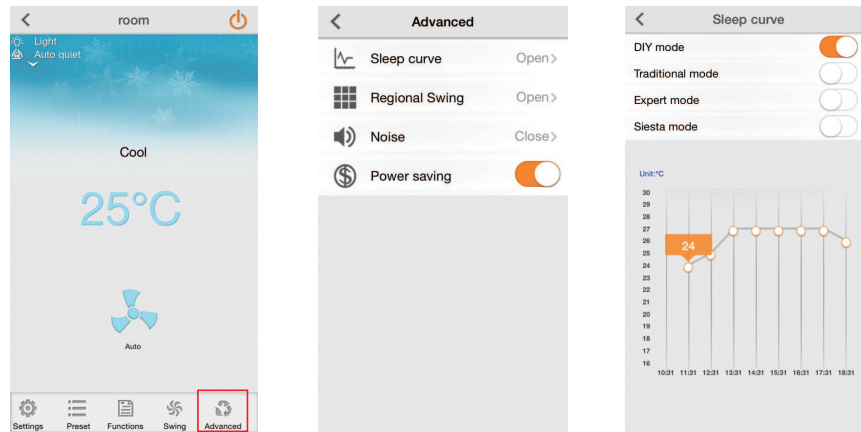

- Regional Swing: After entering Regional Swing, user can set it according to the room size. Press “Air flow position” button and the user can adjust the fan-blowing area through moving the icon of air conditioner left and right according to the actual installation position of the unit.

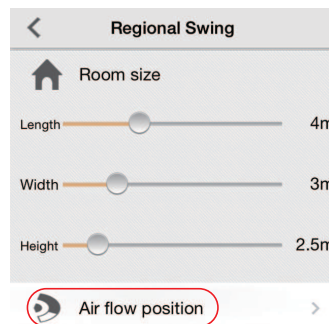

User can move the person icon among nine pane areas according to requirement to adjust the fan-blow area. The Regional Swing function can be turned off through up&down swing. The up&down swing in the Regional Swing is only valid under cooling and heating modes. The left&right swing area has relationship with the position of air conditioner set by mobile phone. The left&right swing position may be asymmetry, which is the normal phenomenon.

“Avoid people” function can be turned on or turned off according to user’s personal experience. There may be deviation because of the installation position of air conditioner and the setting of parameters, which is the normal phenomenon.

Operation of Smart Control (Smart Phone, Tablet PC)

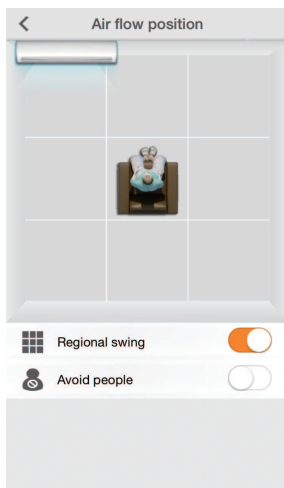

- **Noise:** The noise-customized function for indoor unit can be adjusted according to the actual individual requirement. The detailed adjustment range is different for different models, which is decided by indoor unit.

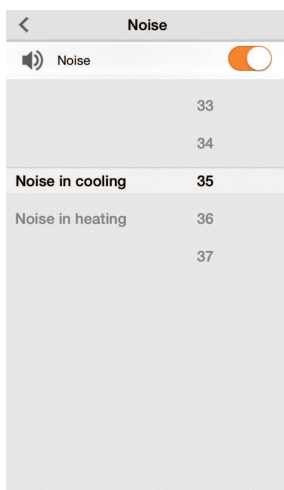

- **Power saving:** After energy saving navigation mode is turned on, the air conditioner will detect indoor temperature and outdoor temperature automatically. Meanwhile, the air conditioner will adjust frequency, fan speed and set temperature automatically according to the load status for saving energy.

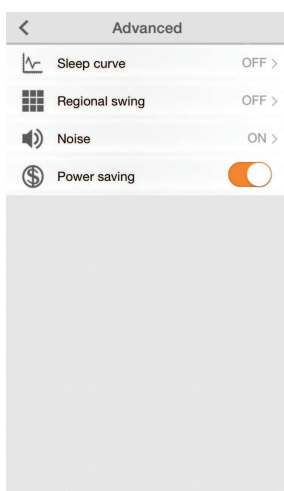

Emergency operation

If remote controller is lost or damaged, please use auxiliary button to turn on or turn off the air conditioner. The operation in details are as below:
As shown in the fig. Open panel, press aux. button to turn on or turn off the air conditioner. When the air conditioner is turned on, it will operate under auto mode.

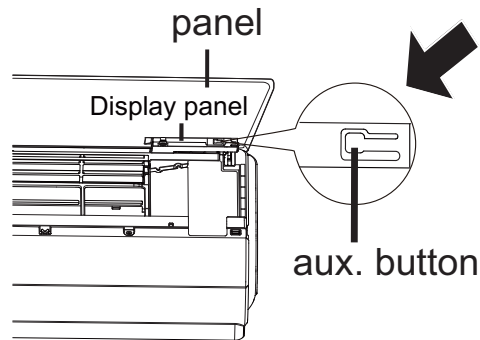

⚠ WARNING:
Use insulated object to press the auto button

Clean and maintenance

⚠ WARNING

- Turn off the air conditioner and disconnect the power before cleaning the air conditioner to avoid electric shock.
- Do not wash the air conditioner with water to avoid electric shock.
- Do not use volatile liquid to clean the air conditioner.

Clean surface of indoor unit

When the surface of indoor unit is dirty, it is recommended to use a soft dry cloth or wet cloth to wipe it.

NOTICE:

- Do not remove the panel when cleaning it.

Clean and maintenance

Checking before use-season

1. Check whether air inlets and air outlets are blocked.
2. Check whether circuit break, plug and socket are in good condition.
3. Check whether filter is clean.
4. Check whether drainage pipe is damaged.

Checking after use-season

1. Disconnect power supply.
2. Clean filter and indoor unit's panel.

Notice for recovery

1. Many packing materials are recyclable materials.
Please dispose them in appropriate recycling unit.
2. If you want to dispose the air conditioner, please contact local dealer or consultant service center for the correct disposal method.

Malfunction analysis

General phenomenon analysis

Please check below items before asking for maintenance. If the malfunction still can't be eliminated, please contact local dealer or qualified professionals.

Phenomenon	Check items	Solution
Indoor unit can't receive remote controller's signal or remote controller has no action.	<ul style="list-style-type: none"> Whether it's interfered severely (such as static electricity, stable voltage)? 	<ul style="list-style-type: none"> Pull out the plug. Reinsert the plug after about 3min, and then turn on the unit again.
	<ul style="list-style-type: none"> Whether remote controller is within the signal receiving range? 	<ul style="list-style-type: none"> Signal receiving range is 8m.
	<ul style="list-style-type: none"> Whether there are obstacles? 	<ul style="list-style-type: none"> Remove obstacles.
	<ul style="list-style-type: none"> Whether remote controller is pointing at the receiving window? 	<ul style="list-style-type: none"> Select proper angle and point the remote controller at the receiving window on indoor unit.
	<ul style="list-style-type: none"> Is sensitivity of remote controller low; fuzzy display and no display? 	<ul style="list-style-type: none"> Check the batteries. If the power of batteries is too low, please replace them.
	<ul style="list-style-type: none"> No display when operating remote controller? 	<ul style="list-style-type: none"> Check whether remote controller appears to be damaged. If yes, replace it.
	<ul style="list-style-type: none"> Fluorescent lamp in room? 	<ul style="list-style-type: none"> Take the remote controller close to indoor unit. Turn off the fluorescent lamp and then try it again.
No air emitted from indoor unit	<ul style="list-style-type: none"> Air inlet or air outlet of indoor unit is blocked? 	<ul style="list-style-type: none"> Eliminate obstacles.
	<ul style="list-style-type: none"> Under heating mode, indoor temperature is reached to set temperature? 	<ul style="list-style-type: none"> After reaching to set temperature, indoor unit will stop blowing out air.
	<ul style="list-style-type: none"> Heating mode is turned on just now? 	<ul style="list-style-type: none"> In order to prevent blowing out cold air, indoor unit will be started after delaying for several minutes, which is a normal phenomenon.

Malfunction analysis

Phenomenon	Check items	Solution
Air conditioner can't operate	● Power failure?	● Wait until power recovery.
	● Is plug loose?	● Reinsert the plug.
	● Air switch trips off or fuse is burnt out?	● Ask professional to replace air switch or fuse.
	● Wiring has malfunction?	● Ask professional to replace it.
	● Unit has restarted immediately after stopping operation?	● Wait for 3min, and then turn on the unit again.
	● Whether the function setting for remote controller is correct?	● Reset the function.
Mist is emitted from indoor unit's air outlet	● Indoor temperature and humidity is high?	● Because indoor air is cooled rapidly. After a while, indoor temperature and humidity will be decrease and mist will disappear.
Set temperature can't be adjusted	● Unit is operating under auto mode?	● Temperature can't be adjusted under auto mode. Please switch the operation mode if you need to adjust temperature.
	● Your required temperature exceeds the set temperature range?	● Set temperature range: 16°C ~30°C .
Cooling (heating) effect is not good.	● Voltage is too low?	● Wait until the voltage resumes normal.
	● Filter is dirty?	● Clean the filter.
	● Set temperature is in proper range?	● Adjust temperature to proper range.
	● Door and window are open?	● Close door and window.

Malfunction analysis

Phenomenon	Check items	Solution
Odours are emitted	<ul style="list-style-type: none">• Whether there's odour source, such as furniture and cigarette, etc.	<ul style="list-style-type: none">• Eliminate the odour source.• Clean the filter.
Air conditioner operates normally suddenly	<ul style="list-style-type: none">• Whether there's interference, such as thunder, wireless devices, etc.	<ul style="list-style-type: none">• Disconnect power, put back power, and then turn on the unit again.
Outdoor unit has vapor	<ul style="list-style-type: none">• Heating mode is turned on?	<ul style="list-style-type: none">• During defrosting under heating mode, it may generate vapor, which is a normal phenomenon.
"Water flowing" noise	<ul style="list-style-type: none">• Air conditioner is turned on or turned off just now?	<ul style="list-style-type: none">• The noise is the sound of refrigerant flowing inside the unit, which is a normal phenomenon.
Cracking noise	<ul style="list-style-type: none">• Air conditioner is turned on or turned off just now?	<ul style="list-style-type: none">• This is the sound of friction caused by expansion and/or contraction of panel or other parts due to the change of temperature.

Malfunction analysis

Error Code

- When air conditioner status is abnormal, temperature indicator on indoor unit will blink to display corresponding error code. Please refer to below list for identification of error code.

Error code	Troubleshooting
E5	It can be eliminated after restarting the unit. If not , please contact qualified professionals for service.
E6	It can be eliminated after restarting the unit. If not , please contact qualified professionals for service.
E8	It can be eliminated after restarting the unit. If not,please contact qualified professionals for service.
U8	It can be eliminated after restarting the unit. If not,please contact qualified professionals for service.
H6	It can be eliminated after restarting the unit. If not,please contact qualified professionals for service.
C5	Please contact qualified professionals for service.
F1	Please contact qualified professionals for service.
F2	Please contact qualified professionals for service.

Note: If there're other error codes, please contact qualified professionals for service.



WARNING

- When below phenomenon occurs, please turn off air conditioner and disconnect power immediately, and then contact the dealer or qualified professionals for service.
 - Power cord is overheating or damaged.
 - There's abnormal sound during operation.
 - Air switch trips off frequently.
 - Air conditioner gives off burning smell.
 - Indoor unit is leaking.
- Do not repair or refit the air conditioner by yourself.
- If the air conditioner operates under abnormal conditions, it may cause malfunction, electric shock or fire hazard.