

G 1100

OPERATION MANUAL



AM/FM/SHORTWAVE RADIO

GRUNDIG

GRUNDIG

DO YOU NEED HELP? Contact Us.

If you need help, please contact us, Monday-Friday, 8:30 a.m.-4:00 p.m., North American Pacific Time. 1-800-872-2228 from the U.S.; 1-800-637-1648 from Canada; 650-903-3866, worldwide; FAX: 650-903-3867; web site, www.etoncorp.com; Etón Corporation , 1015 Corporation Way, Palo Alto, CA 94303, USA

WARNING

- Do not expose this appliance to rain or moisture.
- Do not submerge or expose for extended period to water.
- Protect from high humidity and rain.
- Only operate within specified temperature range (0 °C to 40 °C).
- Unplug immediately if liquid has been spilled or object have fallen into the apparatus.
- Clean only with a dry cloth. Do not use detergents or chemical solvents as this might damage the finish.
- Unplug and disconnect external antennas during lightning storms.
- Do not remove cover [or back].
- Refer servicing to qualified service personnel.

ENVIRONMENT



Disposal

According to the European Directive 2002/96/EC all electrical and electronic products must be collected separately by a local collection system.

Please act according to your local rules and do not dispose of your old products with your normal household waste.

DIAGRAMS

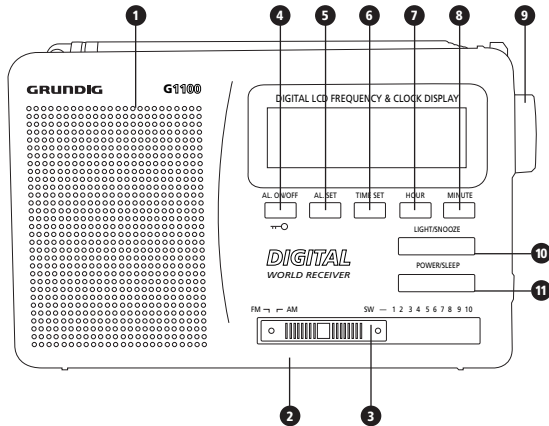

1. Speaker
2. Band Selector
3. SW Band Selector
4. Alarm ON/OFF/Lock
5. Alarm Set
6. Time Set
7. Hour Selector
8. Minute Selector
9. Tuning Control
10. Light/Snooze
11. Power/Sleep

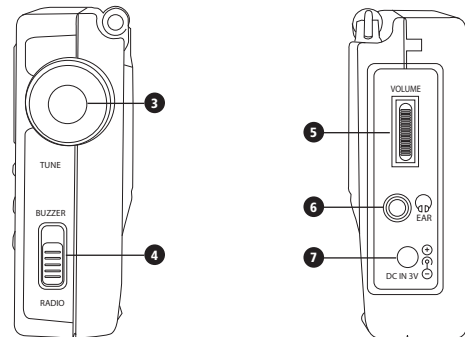
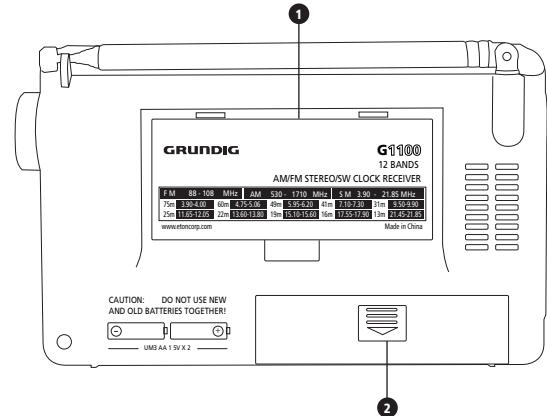

1. Kick-Stand Flap
2. Battery Compartment
3. Tuning Control
4. Buzzer/Radio
5. Volume Control
6. Earphone
7. AC Adaptor

BATTERIES

Remove the battery compartment cover by pushing it in the direction of the arrow. Install two 'AA' batteries according to the polarity symbols (+ and -) marked next to the compartment. For easy removal, place the batteries on top of the lift-out ribbon.

POWER ON/OFF AND SLEEP TIMER

Turn the radio on with the POWER/SLEEP button, on the right side of the radio. A quick, short press engages the sleep timer with 60 minutes of playtime and the sleep timer symbol appears in the upper right corner of the display. To select a different time, press the POWER/SLEEP button immediately after the radio turns on, selecting 60, 45, 30, 15, 10, 05, 120, 90 or 75 minutes.

To defeat the sleep timer, turn on the radio by pressing the POWER/SLEEP for about two seconds. To turn it off, press the POWER/SLEEP button.

It's normal for the display to become lit for about 5 seconds, every time that a button is pressed, except with the RADIO/BUZZER button, on the right side of the radio.

VOLUME

Use the volume knob, on the left side, to adjust the volume.

LISTENING TO FM, AM OR SW1-10

Select the FM, AM or SW1-10 band by using the band selector switch. AM is shown as MW. Use the TUNE knob to tune the radio to the desired frequency. If you are using an earphone to listen to FM-stereo, the FM-stereo LED will light in the upper left corner. Note that the frequency of the station appears in the display.

LISTENING TO SHORTWAVE

Shortwave allows listening to stations from around the world. During the day, listen above 13 mHz. At night, listen below 13 mHz. To learn more use the Internet or the two books below:

PASSPORT TO WORLD BAND RADIO Published by International Broadcasting Services (IBS); IBS North America, Box 300, Penn's Park PA 18943. Phone: (215) 598-9018. www.passband.com.

WORLD RADIO TV HANDBOOK Published in the USA by Watson-Guption Publications, 770 Broadway, 7th Floor, New York, NY 10003-9595. www.watsonguption.com.

ANTENNA

For AM (MW) the radio uses an internal, directional, ferrite bar antenna. Rotate the radio for best reception.

For FM/SW, fully extend the telescopic antenna.

AC ADAPTOR (INCLUDED)

The E1100 can be used with an AC adaptor that supplies an output of 3 volts DC, negative polarity, 100 milliamperes or greater current. To purchase this, visit www.etoncorp.com.

SETTING THE CLOCK

The clock displays time in 12-hour format. With the radio turned on or off, press TIME SET for two seconds. Within three seconds press the HOUR and MINUTE buttons to set the correct hour and minutes. They can be pressed with quick, short presses to advance slowly or they can be kept pressed down to advance rapidly. When finished, release the TIME SET button or wait until the digits stop flashing.

SETTING THE ALARM

Select the BUZZER or RADIO setting on the right side of the radio. With the radio turned on or off, press AL.SET for two seconds. Within three seconds press the HOUR and MINUTE buttons to set the correct hour and minutes. They can be pressed with quick, short presses to advance slowly or they can be kept pressed down to advance rapidly. When finished, release the AL.SET button or wait until the digits stop flashing.

SWITCHING THE ALARM ON/OFF

With the radio turned on or off, press the AL. ON/OFF button. The alarm activation symbol appears in the upper right corner of the LCD and looks like a loudspeaker. Turn it off by pressing the AL. ON/OFF button again and the symbol disappears.

When the activated alarm turns the buzzer or the radio on, it can be turned off by pressing the AL. ON/OFF button. This will cause the loudspeaker symbol to disappear from the display.

LIGHT/SNOOZE

A quick press of the LIGHT button causes the display to be illuminated for about 5 seconds. Use a long press to permanently light the display (note that this causes increased battery usage). Press LIGHT/SNOOZE again to turn it off.

While the alarm is on, pressing the SNOOZE button causes the alarm to pause for about 10 minutes, and then continue. This can be repeated three times.

LOCK BUTTON

With the radio turned off, press this button for two seconds to lock it; 'Hold' appears in the display. Press the button again to unlock it; 'Un-H' appears in the display.

IMPORTANT BATTERY INFORMATION

To minimize the possibility of battery acid leakage, only use high quality alkaline, lithium or rechargeable nickel-metal-hydride batteries. Never intermix old with new, or different brands or types of batteries. Damage caused by battery acid leakage is not covered by this product's warranty.

REGISTREMENT DE GARANTIE

L'enregistrement de votre produit doit être complété aussitôt que possible après achat ou réception pour s'assurer une couverture de garantie complète ou des mises à jour de produit. Vous pouvez utiliser une des options suivantes pour enregistrer votre produit :

1. En visitant notre site web <http://www.etoncorp.com>.
2. En envoyant la carte de garantie incluse par la poste.
3. Envoyez votre carte d'enregistrement ou information à l'adresse suivante ; Incluez votre nom, adresse postale complète, numéro de téléphone, modèle acheté, date d'achat, nom de détaillant et numéro de série du produit (typiquement mis dans ou près du compartiment de piles) :

Etón Corporation
1015 Corporation Way
Palo Alto, CA 94303 USA

GARANTIE LIMITÉE

Gardez l'information de garantie de votre carte de garantie avec votre preuve d'achat ou l'information de Garantie limitée peut être aussi vue sur www.etoncorp.com.

ASSISTENZA PER IL PRODOTTO ACQUISTATO

Pour obtenir du service de votre produit, on recommande de contacter avant tout un représentant de service Etón au 800-872-2228 ÉU, 800-637-1648 Canada ou (650) 903-3866 pour déterminer le problème et trouver les pannes. Si du service additionnel est requis, le personnel technique vous informera comment procéder dépendamment si la radio est toujours sous garantie ou a besoin de service hors garantie.

GARANTIE – Une autorisation de retour sera émise avec des instructions pour l'expédition à un établissement de réparations de garanties autorisé si votre produit est toujours sous garantie et que le représentant de service Etón détermine que du service sous garantie est requis. Ne renvoyez pas votre radio sans obtenir le numéro d'autorisation de retour.

HORS-GARANTIE – Si votre produit n'est plus sous garantie et nécessite du service, notre personnel technique vous référera à l'établissement de réparations le plus proche qui pourra réparer votre produit le mieux.

Pour le service hors de l'Amérique du nord, référez-vous SVP à l'information de distributeur incluse au moment de l'achat/réception.

***etón* Corporation**

Corporate Headquarters
1015 Corporation Way
Palo Alto, California 94303 USA
tel +1 650-903-3866
tel +1 800-872-2228
fax +1 650-903-3867

***etón* Europe/Lextronix Germany**

Rosenstrasse 2
D-10178 Berlin, Germany
tel +49 [0]30 243102149

***etón* Canada**

1 Yonge Street, Suite 1801
Toronto, Ontario M5E 1W7 Canada
tel +1 416-214-6885