

# RODEO 110

QUICK START GUIDE **V1.0**

6th-DEC-2016

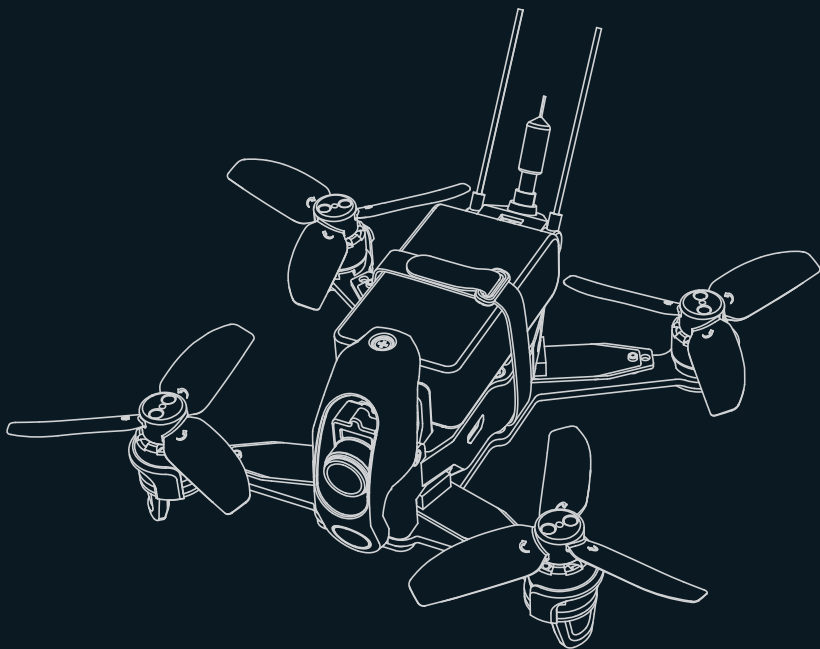

# Contents

|   |       |
|---|-------|
| 1.0 Get to know your aircraft                             | 3     |
| 2.0 Get to know your Remote Controller                    | 4     |
| 3.0 Specifications  | 5     |
| 4.0 Attention before flight                               | 6     |
| 5.0 Charge the Battery                                    | 6     |
| 6.0 Prepare the aircraft                                  | 6     |
| 7.0 Prepare the Remote Controller                         | 7     |
| 8.0 Ready to fly  | 7     |
| 8.1 Binding of the Rodeo 110                              | 7     |
| 8.2 Motor Unlock / Lock                                   | 8     |
| 9.0 Operation Instruction                                 | 9-10  |
| 10.0 End flight   | 10    |
| 11.0 Additional remark                                    | 11    |
| 11.1 DEVO 7 Remote Controller Setting                     | 11-12 |
| 11.2 TX5836/TX5837 Video transmitting channel selection   | 13    |
| 11.3 Brushless ESC and Brushless Motor connection diagram | 13    |
| 12.0 In the Box / List of Articles                        | 14    |

## 1.0 Get to know your aircraft

- The Rodeo 110 body is created using CFP for outstanding crash survivability.
- Modern industrial and modular design, improves the product performance and permit easy maintenance and upgrades.
- Advanced 5.8ghz live video, for a unforgettable visual FPV experience.
- The Rodeo 110 employ a modern flight control system for acrobatic flight routines such as roll, flip and race courstte moves.

1. Camera
2. Lighting Lamp
3. Upgrade port
4. Receiving red indicator
5. Status red indicator

6. Propeller(CW)
7. Propeller(CCW)
8. Motor x4
9. Li-Po Battery
10. Power port
11. 5.8G transmitter antenna
12. DUAL reciever antennas

for best performance  
\* always extend before flying

13. Fixed ID clearance button
14. Power red indicator
15. External receiver port
16. PPM and SBUS receiver switch  
Factory default --PPM Port  
External receiver --SBUS Port

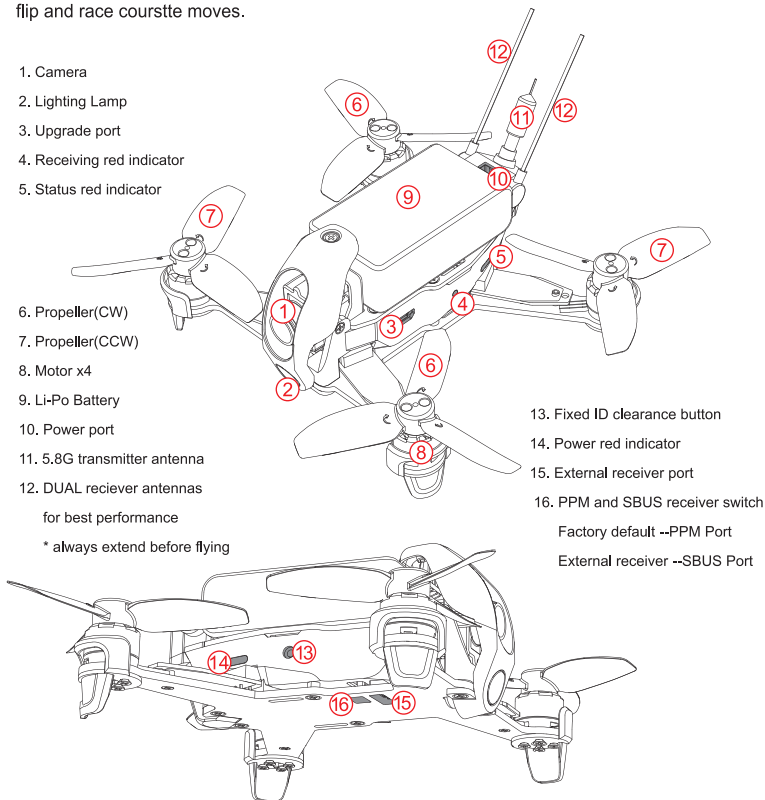



\* To avoid property loss and personal injury caused by wrong operation, please read the manual carefully and watch the tutorial videos at [www.walkera.com](http://www.walkera.com) before flight.

## 2.0 Get to know your Remote Controller

The Rodeo 110 features 3 useful flight modes, STABILIZE / INTERMEDIATE / ADVANCED Flight modes are selected by the MIX switch. (Select the appropriate mode according to your flight skills.)

- ※ STABILIZE Flight mode: the main flight controller system comes with stabilization function, its operation is relatively stable, it can not roll, it is suitable for beginners.
- ※ INTERMEDIATE flight mode: the main flight controller system comes with partial stabilization function, its operation is relatively flexible, it can roll.
- ※ ADVANCED Flight Mode: the main flight controller system without stabilization function, its operation is very flexible, it can roll.

| STABILIZE Flight Mode   | INTERMEDIATE Flight Mode  | ADVANCED Flight Mode  |
|---|---|---|
|  |  |  |
| MIX Switch to "0"   | MIX Switch to "1"   | MIX Switch to "2"   |

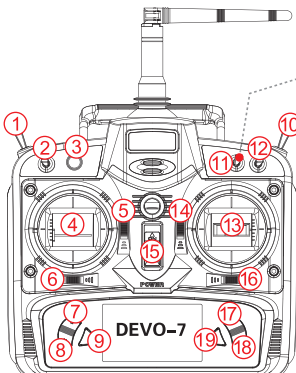
1. HOLD TRN switch
2. GEAR switch
3. AUX2 control
4. Left stick
5. Left trim
6. RUDD trim
7. UP+ key
8. DN- key
9. EXT key
10. FMD Switch

11. MIX - Flight Mode Switch
12. ELEV/AILE/RUDD D/R Switch
13. Right stick
14. Right trim
15. Power switch
16. AILE trim
17. R+ key
18. L- key
19. ENT key

Take the "MODE 2" as an example. The left stick controls the aircraft's altitude and heading, while the right stick controls its forward, backward, left and right movements.

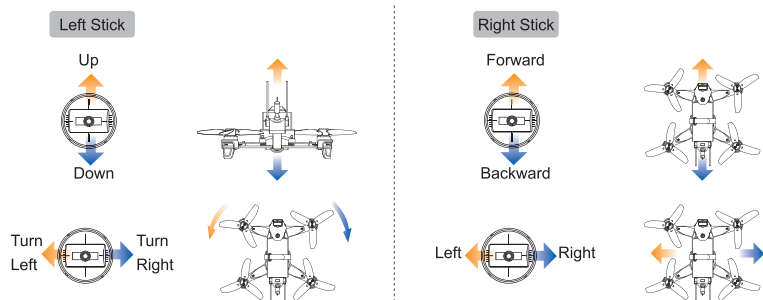

- \* 1) MODE 2 (Throttle stick on the left): Left stick- THRO / RUDD; Right stick - ELEV / AILE.
- 2) MODE 1 (Throttle stick on the right): Left stick- ELEV / RUDD; Right stick - THRO / AILE.

## 3.0 Specifications

### • Aircraft

|                           |                          |
|---------------------------|--------------------------|
| Main Rotor Dia.:          | 70mm                     |
| Overall (L x W x H):      | 101 x 117 x 55mm         |
| Weight:                   | 101g (Battery excluded)  |
| Remote Controller:        | DEVO 7                   |
| Receiver/Main Controller: | Rodeo 110                |
| Transmitter:              | TX5836(FCC)/TX5837(CE)   |
| Brushless Motor:          | WK-WS-13-002             |
| Brushless ESC:            | Rodeo 110                |
| Battery:                  | 7.4V 850mAh 25C 2S Li-Po |
| Flight Time:              | 7~8mins                  |
| Working Temperature:      | -10 C ~ +40 C            |

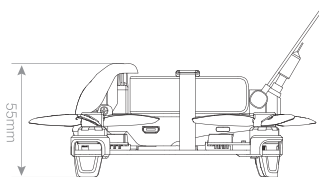
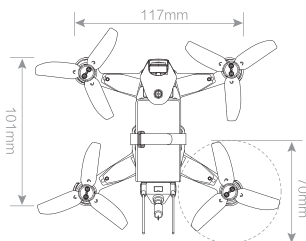

### • Camera(600TVL)

|                        |             |
|------------------------|-------------|
| Horizontal Resolution: | 600TVL      |
| System Committee:      | PAL/NTSC    |
| Video Out:             | 1.0Vp-p/75Ω |
| Power Input:           | DC 5-12V    |

### • DEVO 7 remote controller

|                |   |
|----------------|---|
| Frequency:     | 2.4GHz DSSS                                   |
| Output Power:  | ≤100mW  |
| Current drain: | ≤230mA(100mW)                                 |
| Power Supply:  | 5# Battery 8x1.5V or NiMH 8x1.2V 1600-2000mAh |
| Output Pulse:  | 1000-2000mS(1500Ms Neutral)                   |

### • TX5836(FCC) / TX5837(CE) transmitter

|  |
|--|
| 5.8G wireless image transmission       |
| TX5836(FCC) Bind B section: 8 channels |
| TX5837(CE) B section: 8 channels       |
| TX5836(FCC) output power ≤200mW        |
| TX5837(CE) output power ≤25mW          |

## 4.0 Attention before flight

- 1) The Rodeo 110 mini-quad is recommended for pilots, 14 years or older, with RC hobby experience.
- 2) Only fly the Rodeo 110 in dry weather, with low wind, please do not fly in rain or heavy foggy conditions.
- 3) Always choose large open fields for flying. Check local LAW and ordinances for legal flying areas.
- 4) Always keep at least 10 feet distance to the aircraft when armed, to avoid injury from high-speed propellers on the ground or while flying. Always disarm before handling the aircraft.
- 5) Do not fly close to high-voltage power lines, cellphone towers, or radio towers, as these may disrupt your control signal.
- 6) ALWAYS check local laws BEFORE flying. NEVER fly over crowds, concerts or sports stadiums.

## 5.0 Charge the Battery

- ① Connect the charger to the AC power (100 ~ 240v 50/60hz).
- ② Charging indicator status:  
Stable red—charging;  
Stable green—finished charge.

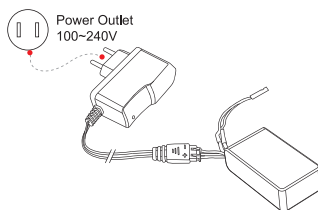

## 6.0 Prepare the aircraft

### Battery installation

First put the battery anti-slip mat into the battery compartment. Put the battery on top and move it forward-backwards as required for perfect balance, then firmly secure the battery with the velcro strap.

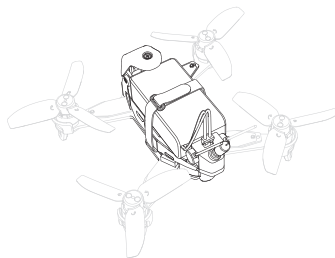

### Gravity center adjustment

Grab the Rodeo 110 mini-quad by the COG line (center of gravity).

See the illustration for the COG.

Adjust the battery forward-backwards until the quad balances.

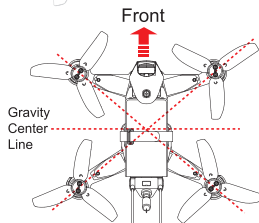

## 7.0 Prepare the Remote Controller

Open the battery cover and remove the battery box. According to the battery positive and negative polarity, install 8pcs 5# batteries or 8pcs NiMH batteries with same volume.

**Warning:** Battery polarities must be correctly installed. When insert the plug of battery box into power socket of remote controller, the fool-proofing port must be inserted into fool-proofing port.

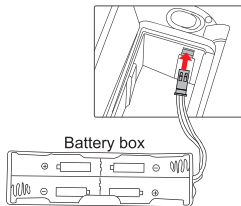

## 8.0 Ready to fly



Attention:

- Place the aircraft in a wide open space, with the rear facing you. (This position is known as "TAIL IN")
- Put all the function switches to the 0 position, put all trims and dials to the Middle position, move the throttle to the lowest position, then turn on the Remote Controller.
- A video receiving equipment is needed (Goggles glasses, etc. ) to display an image. (Setting method please refer to P13)
- The Rodeo 110 mini-quad have a low-voltage alarm beeper.  
When voltage reach below 7.0 volts the Power red LED light will flash quickly and the beeper will sound alarm.  
**WARNING:** Do not hesitate to land when you hear the alarm.

## 8.1 Binding of the Rodeo 110

- ① Turn on the Remote Controller.
- ② Connect the aircraft power, then put the aircraft on a horizontal position place, the buzzer will send out the voice of "BB". (make sure the positive and negtive connected correctly )
- ③ In the process of binding, the status red LED light indicates slowly to run out means binding finished successfully. If your aircraft is keeping making a BB sound, it means binding failed.

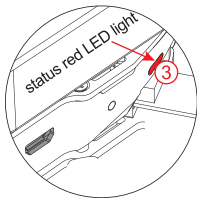
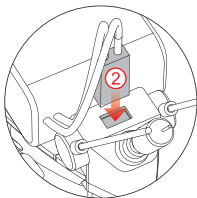
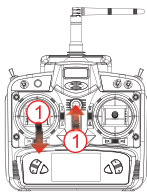

Tips:

- Do not move the Rodeo 110 during binding.
- ALWAYS unfold the two receiver antennas to their correct STRAIGHT UP position before flying. Do not fly without properly unfolding the antennas.

## 8.2 Motor Unlock / Lock

### Motor Unlock

After binding the DEVO 7 to the Rodeo 110, Check that all trims are neutral, the throttle stick is ALL the way Down with the display indicating 0% throttle. Check that ALL switches are in the UP position.

Gently push the throttle stick down and move the rudder (YAW) stick to the left side and hold for more than 2 seconds. (on mode 2 radios throttle and rudder is the same stick).

You will see the status red LED light keeps on and buzzer issues a "B B" sound, indicating that motors are unlocked.

Be very careful at this point, as pushing the throttle up will start the motors.

You can test by pushing the stick up a little, the motors should start.

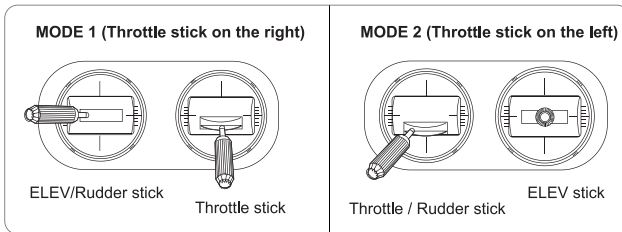

### Motor Lock

Lock the motors by moving the throttle stick all the way down and the rudder (YAW) stick all the way to the right.

The status red LED light turns off and buzzer issues a "B B" sound when the motors are disarmed.

**TEST:** Push the throttle stick up a little, the motors will not start when locked.

**NOTICE:** The motors are LOCKED by default after successful binding.

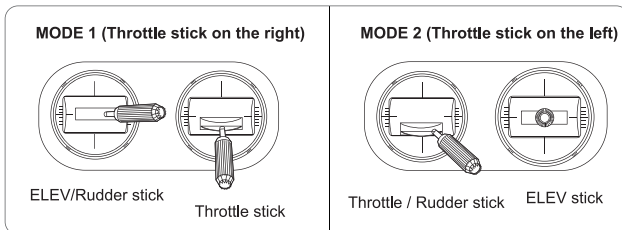



## 9.0 Operation Instruction

### The aircraft roll forward

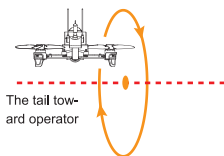

### The aircraft roll backward

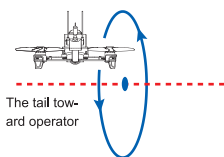

### The aircraft roll left

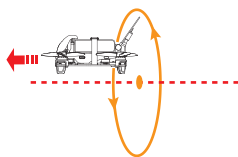

### The aircraft roll right

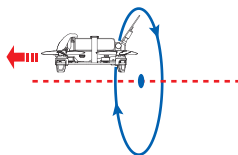

### FLIP & ROLL'S

Are only available in the intermediate & Advanced flight mode.  
Set MIX switch to position 1 or 2, to select the appropriate flight mode.

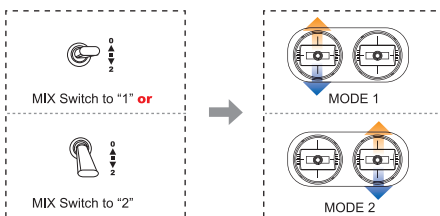

#### Attention:

- 1) Always select large open spaces with soft ground for flying.
- 2) Rolls and flips are best suited for experienced pilots.
- 3) Match throttle power to the flight to manage altitude.

### FLIP & ROLL'S

Are only available in the intermediate & Advanced flight mode.  
Set MIX switch to position 1 or 2, to select the appropriate flight mode.

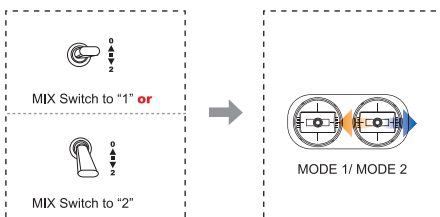

#### Attention:

- 1) Always select large open spaces with soft ground for flying.
- 2) Rolls and flips are best suited for experienced pilots.
- 3) Match throttle power to the flight to manage altitude.

### DERAM Baron AKA Proximity FPV obstacle flying

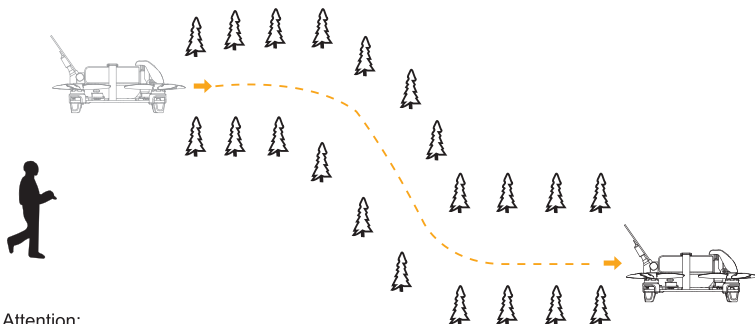

**Attention:**

- 1) Dream Baron is more suitable for experienced pilots, highspeed obstacle avoidance flights require advanced skills.
  - 2) Recommended FPV range 300m depending on environment.
  - 3) Avoid flying over people, animals, do not fly over crowds, concerts or sports stadiums.  
Avoid flying close to powerlines and cellphone towers as these may crash you.  
Visit [walkera.com](http://walkera.com) for more suggestions and for WALKERA racing gates.
- 

## 10.0 End flight

- ① Land the aircraft, disarm(lock) the aircraft.
- ② First Power off the aircraft by unplugging the battery, then turn off the radio.
- ③ Finally, remove the battery from the aircraft.

## 11.0 Additional remark

### 11.1 DEVO 7 Remote Controller Setting

#### Boot Screen(Main interface)

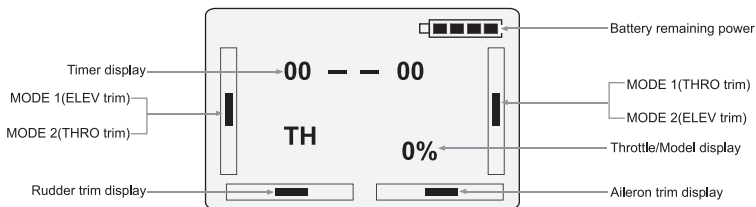

#### Model Select(SELEC)

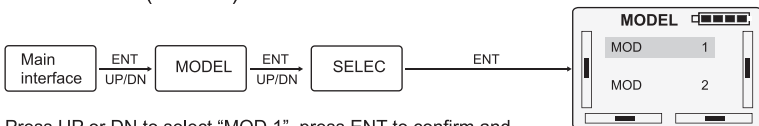

Press UP or DN to select "MOD 1", press ENT to confirm and then press EXT to return to MODEL.

#### Model Name(NAME)

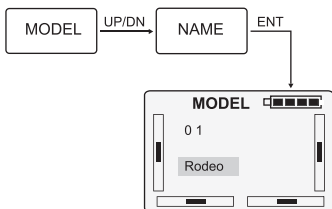

Press R or L button to change the character and figure, named model as Rodeo. Press ENT to confirm and then press EXT to return to MODEL.

#### Type Select(TYPE)

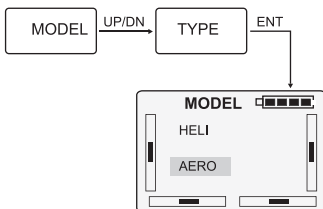

Press UP or DN to select AERO, Press ENT to confirm and then press EXT to return to MODEL.

### Wing Type(WING)

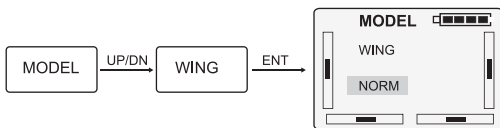

Press R or L to select NORM, Press ENT to confirm and then press EXT to return to MODEL.

### Device Output(OUTPUT)

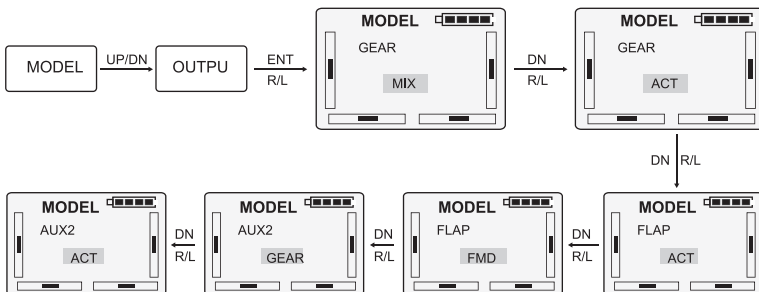

After setup, press ENT to confirm and then press EXT to return to Main interface.

### Reverse Switch(REVSW)

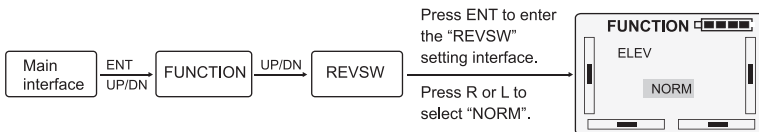

Press ENT to enter the "REVSW" setting interface.

Press R or L to select "NORM".

|      |      |      |      |      |      |      |
|------|------|------|------|------|------|------|
| ELEV | AILE | THRO | RUDD | GEAR | FLAP | AUX2 |
| NORM | NORM | NORM | NORM | NORM | NORM | NORM |

After settings, press ENT to confirm and then press EXT to return to Main interface.

## 11.2 TX5836/TX5837 Video transmitting channel selection

There are 8 channels available, choose the best channel based on the image quality on your screen. Select the channel by adjusting the dip-switches on the video-transmitter according to the diagram.

| Channel                | 1                           | 2       | 3       | 4       | 5       | 6       | 7       | 8       |
|------------------------|-----------------------------|---------|---------|---------|---------|---------|---------|---------|
| Frequency              | 5866MHz(CE)<br>5847MHz(FCC) | 5847MHz | 5828MHz | 5809MHz | 5790MHz | 5771MHz | 5752MHz | 5733MHz |
| Code position (on/off) |                             |         |         |         |         |         |         |         |



**Attention:**

- Video transmitter channel must match the receiver channel.

## 11.3 Brushless ESC and Brushless Motor connection diagram

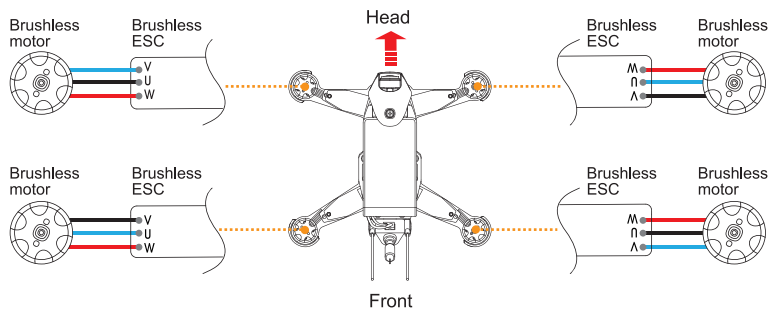

**Attention:**

- The red, blue and black wires of the brushless motors must be soldering to the brushless ESC according to the illustration.

## 12.0 In the Box / List of Articles

Check all the following items in your package. If any of them is missing, please contact walkera or your local dealer.

Aircraft Body x1

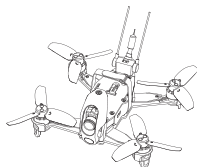

Remote Controller x1



Charger x1



Propellers (Pair) x2

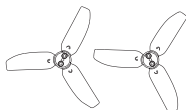

Aircraft Battery x1

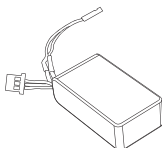

Training cable x1



Micro-USB Cable x1

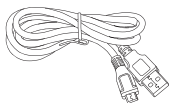

Manuals

«QUICK START GUIDE»



Manual of DEVO 7(DVD)



- Tips:
- Rodeo 110 BNF Package: no remote controller, Training Cable, Manual of DEVO 7(DVD)



 Tel: 400-9318-878

User manual is subject to change without prior notice.

Please go to Walkera official website to get the latest version.



## **FCC WARNING**

This device complies with Part 15 of the FCC Rules. Operation is subject to the following two conditions:

- (1) This device may not cause harmful interference, and
- (2) this device must accept any interference received, including interference that may cause undesired operation.

NOTE 1: This equipment has been tested and found to comply with the limits for a Class B digital device, pursuant to part 15 of the FCC Rules. These limits are designed to provide reasonable protection against harmful interference in a residential installation. This equipment generates, uses and can radiate radio frequency energy and, if not installed and used in accordance with the instructions, may cause harmful interference to radio communications. However, there is no guarantee that interference will not occur in a particular installation. If this equipment does cause harmful interference to radio or television reception, which can be determined by turning the equipment off and on, the user is encouraged to try to correct the interference by one or more of the following measures:

- Reorient or relocate the receiving antenna.
- Increase the separation between the equipment and receiver.
- Connect the equipment into an outlet on a circuit different from that to which the receiver is connected.
- Consult the dealer or an experienced radio/TV technician for help.

NOTE 2: Any changes or modifications to this unit not expressly approved by the party responsible for compliance could void the user's authority to operate the equipment.