

Heli-Max™

NOVUS™
CP



Novus CP Specifications

Length: 10.7 in [272mm]	Flying Weight: 2.41 oz [68.4g]
Width: 2 in [50mm]	(with supplied flight battery)
Height: 3.74 in [95mm]	
Rotor Span: 12 in [305mm]	



Heli-Max™

IMPORTANT PRECAUTIONS

- Only use the included charger with the included battery or replacement battery (GPMP0408).
- Do not attempt to use this charger with NiCd or NiMH battery packs.
- Never charge in excess of 4.20V per cell.
- If the battery should become damaged, discard the battery. Do not attempt to use a damaged battery.
- Do not leave the charger unattended while charging. Disconnect the battery and remove input power from the charger immediately if either becomes hot! However, it is normal for the charger to get warm.
- Disconnect the battery from the charger and carefully move the battery to a fireproof location if the battery begins to swell or smoke!
- Never charge at currents greater than 1C.
- Always charge in a fireproof location.
- Never trickle charge.
- Never allow the battery temperature to exceed 140° F [60° C].
- Never disassemble or modify pack wiring in any way or puncture cells.
- Never discharge below 2.75V per cell.
- Do not allow water, moisture or foreign objects into the charger.
- Do not block the air intake holes, which could cause the charger to overheat.
- Do not place the charger or any battery on a flammable surface or near a combustible material while in use.
- Do not charge on a carpet, cluttered workbench, paper, plastic, vinyl, leather, wood, or inside an R/C model.
- Never charge inside a full-sized vehicle.
- Always disconnect the battery from the charger and the power supply from the charger when not in use.
- Do not attempt to charge a battery if it is swollen or hot.
- **ALWAYS KEEP OUT OF REACH OF CHILDREN.**



Heli-Max™ guarantees this kit to be free from defects in both material and workmanship at the date of purchase. This warranty does not cover any component parts damaged by use or modification. In no case shall Heli-Max's liability exceed the original cost of the purchased kit. Further, Heli-Max reserves the right to change or modify this warranty without notice.

In that Heli-Max has no control over the final assembly or material used for final assembly, no liability shall be assumed nor accepted for any damage resulting from the use by the user of the final user-assembled product. By the act of using the user-assembled product, the user accepts all resulting liability.

If the buyer is not prepared to accept the liability associated with the use of this product, the buyer is advised to return this kit immediately in new and unused condition to the place of purchase.

To make a warranty claim, send the defective part or item to Hobby Services at this address.

Hobby Services

3002 N. Apollo Dr., Suite 1
Champaign, IL 61822
USA

Include a letter stating your name, return shipping address, as much contact information as possible (daytime telephone number, fax number, e-mail address), a detailed description of the problem and a photocopy of the purchase receipt. Upon receipt of the package the problem will be evaluated as quickly as possible.

READ THROUGH THIS INSTRUCTION MANUAL FIRST. IT CONTAINS IMPORTANT INSTRUCTIONS AND WARNINGS CONCERNING THE ASSEMBLY AND USE OF THIS MODEL.



TABLE OF CONTENTS

INTRODUCTION	4
SAFETY PRECAUTIONS	4
ADDITIONAL ITEMS REQUIRED	6
ORDERING REPLACEMENT PARTS	6
KIT INSPECTION	7
KIT CONTENTS	7
ASSEMBLY INSTRUCTIONS	8
GET THE MODEL READY TO FLY	9
LITHIUM BATTERY HANDLING & USAGE	10
PREFLIGHT	12
CONTROLS	13
FLYING	17
MAINTENANCE & REPAIR	19
TRANSMITTER SETTINGS	22
E-BOARD ADJUSTMENTS	24
EXPLODED VIEW	26
PARTS LIST & OPTIONAL PARTS	27



INTRODUCTION

Thank you for purchasing the Heli-Max™ Novus CP. We are certain you will get many hours of enjoyment out of this model. If you should have any questions or concerns please feel free to contact us at helihotline@hobbico.com. For the latest technical updates or manual corrections to the Novus CP visit the Heli-Max web site at:

www.helimax-rc.com

Open the “Helicopters” link, and then select the Novus CP link. If there is new technical information or changes to this model a “tech notice” box will appear in the upper left corner of the page.



SAFETY PRECAUTIONS

- Failure to follow these safety precautions may result in severe injury to yourself and others.
- Keep your face and body as well as all spectators away from the plane of rotation of the rotors whenever the battery is connected.

- Keep these items away from the rotors: loose clothing, shirt sleeves, ties, scarfs, long hair or loose objects such as pencils or screwdrivers that may fall out of shirt or jacket pockets into the rotors.
- The spinning blades of a model helicopter can cause serious injury. When choosing a flying site for your Novus CP Helicopter, stay clear of buildings, trees and power lines. **AVOID** flying in or near crowded areas. **DO NOT** fly close to people, children or pets. Maintain a safe pilot-to-helicopter distance while flying.

1. Your Novus CP Helicopter should not be considered a toy, but rather a sophisticated, working model that functions very much like a full-size helicopter. Because of its performance capabilities, the Novus CP Helicopter, if not assembled and operated correctly, could possibly cause injury to yourself or spectators and damage to property.

2. You must assemble the model **according to the instructions**. Do not alter or modify the model, as doing so may result in an unsafe or unflyable model. In a few cases the instructions may differ slightly from the photos. In those instances the written instructions should be considered as correct.

3. You must correctly install all R/C and other components so that the model operates correctly on the ground and in the air.

4. You must check the operation of the model before **every** flight to insure that all equipment is operating and that the model has remained structurally sound. Be sure to check linkages or other connectors often and replace them if they show any signs of wear or fatigue.

5. If you are not an experienced pilot or have not flown this type of model before, we recommend that you get the assistance of an experienced pilot in your R/C club for your first flights. If you're not a member of a club, your local hobby shop has information about clubs in your area whose membership includes experienced pilots.

We, as the manufacturer, provide you with a top quality, thoroughly tested helicopter and instructions, but ultimately the quality and flyability of your finished model depends on how you build it; therefore, we cannot in any way guarantee the performance of your completed model, and no representations are expressed or implied as to the performance or safety of your completed model.

Remember: Take your time and follow the instructions to build a safe and enjoyable model.



Heli-Max™
ADDITIONAL ITEMS REQUIRED

Eight "AA" Alkaline Batteries for the Transmitter

- (2) SANP3500 Sanyo AA Alkaline Battery (4 pack)



Heli-Max™
ORDERING REPLACEMENT PARTS

Replacement parts for the Heli-Max Novus CP Helicopter are available using the order numbers in the Parts List on page 27. The fastest, most economical service can be provided by your hobby dealer.

To locate a hobby dealer, visit the Hobbico web site at www.hobbico.com. Choose "Where to Buy" at the bottom of the menu on the left side of the page. Follow the instructions provided on the page to locate a U.S., Canadian or International dealer.

Parts may also be ordered directly from Hobby Services by calling (217) 398-0007, or via facsimile at (217) 398-7721, but full retail prices and shipping and handling charges will apply. Illinois and Nevada residents will also be charged sales tax. If ordering via fax, include a Visa® or MasterCard® number and expiration date for payment. Mail parts orders and payments by personal check to:

Hobby Services

3002 N. Apollo Drive, Suite 1
Champaign, IL 61822

Be certain to specify the order number exactly as listed in the **Parts List**. Payment by credit card or personal check only; no C.O.D.

If additional assistance is required for any reason contact:

Product Support

by e-mail at helihotline@hobbico.com,
or by telephone at (217) 398-8970.

Heli-Max™ ***KIT INSPECTION***

Before starting assembly, take an inventory of the Novus CP to make sure it is complete, and inspect the parts to make sure they are of acceptable quality. If any parts are missing or are not of acceptable quality, or if you need assistance with assembly, contact Product Support. When reporting defective or missing parts, use the part names exactly as they are written in the **Kit Contents** list.

Heli-Max Product Support

3002 N. Apollo Drive, Suite 1
Champaign, IL 61822

Telephone: (217) 398-8970

Fax: (217) 398-7721

E-mail: helihotline@hobbico.com

Heli-Max™ ***KIT CONTENTS***



1. Novus CP Helicopter

2. 3.7V LiPo Battery

3. 4-Channel 2.4GHz Transmitter

4. 110V Wall Charger

Heli-Max™ **ASSEMBLY INSTRUCTIONS**

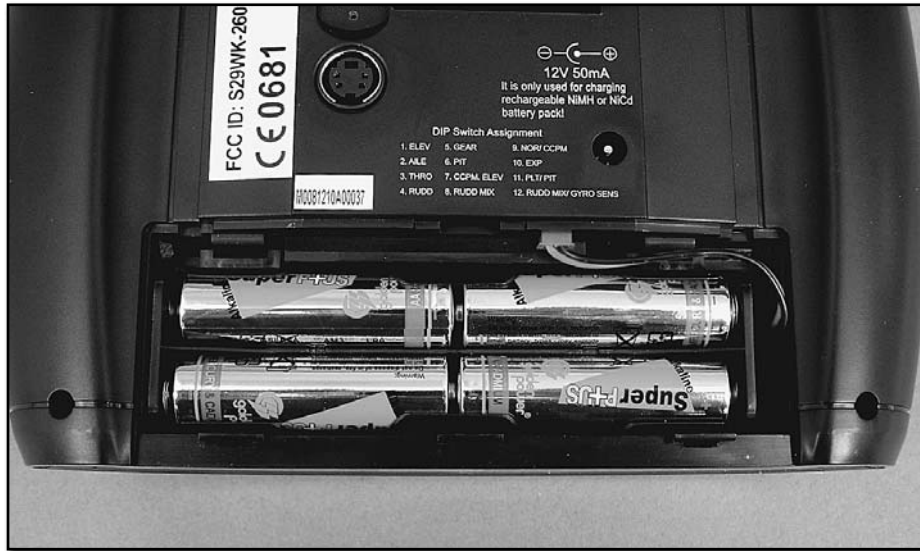

❑ Remove the battery cover from the back of the transmitter and remove the battery box. Install eight (8) “AA” batteries into the battery box. Double-check the polarity of each battery before placing the battery box back into the transmitter and replacing the battery cover.

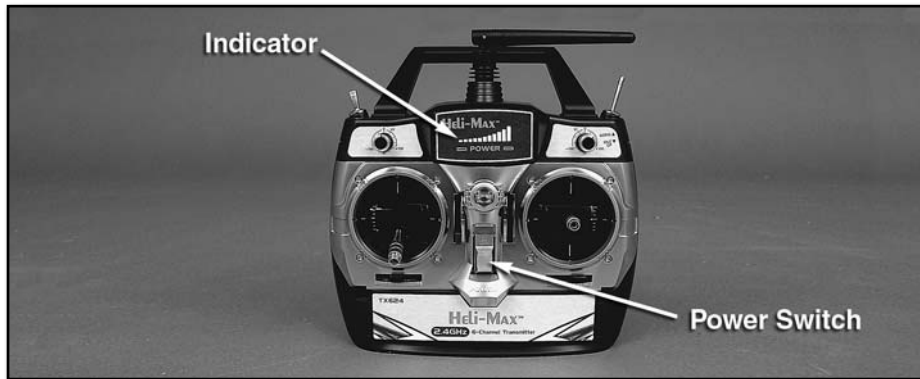

❑ Turn on the transmitter using the power switch as shown above and verify that the indicator illuminates. Turn the transmitter off for now. If the indicator did not illuminate, remove the battery box from the transmitter and verify that the batteries were installed correctly.

Heli-Max™ *GET THE MODEL READY TO FLY*

Charging the Flight Battery

WARNING!! The charger supplied with the Heli-Max Novus CP Helicopter contains protective circuitry. If you experience any difficulties while charging the battery, please disconnect the battery from the charger and unplug the charger from the power source. Allow the battery and charger to rest for two hours as this will allow the charge protection circuit to reset. If this issue re-occurs during normal use, please contact technical support for further assistance.

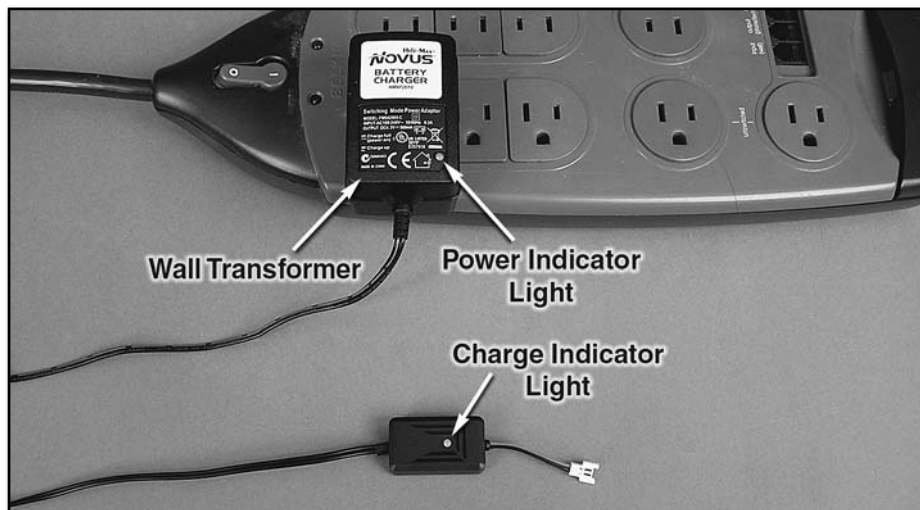

☐ Plug the wall transformer into an AC outlet. The *power indicator light* on the wall transformer will be green and the *charge indicator light* will be solid red.

Charge Indicator Light		
Fast Flashing Red	The battery is being charged.	* Once the battery has been disconnected from the charger contact technical support for further assistance.
Green (Solid or Flashing)	The battery is fully charged.	
*Slow Flashing Red	A time-out has occurred.	
*Solid Red with Battery Connected	The battery voltage is too low or the charger is not powered.	
Solid Red without Battery Connected	The charger is ready.	

WARNING!! Do not leave the battery connected to the charger if the charge indicator is solid red. This may over-discharge the battery, possibly causing damage to the battery or the charger. Once the battery has been disconnected from the charger, contact technical support immediately for further assistance.

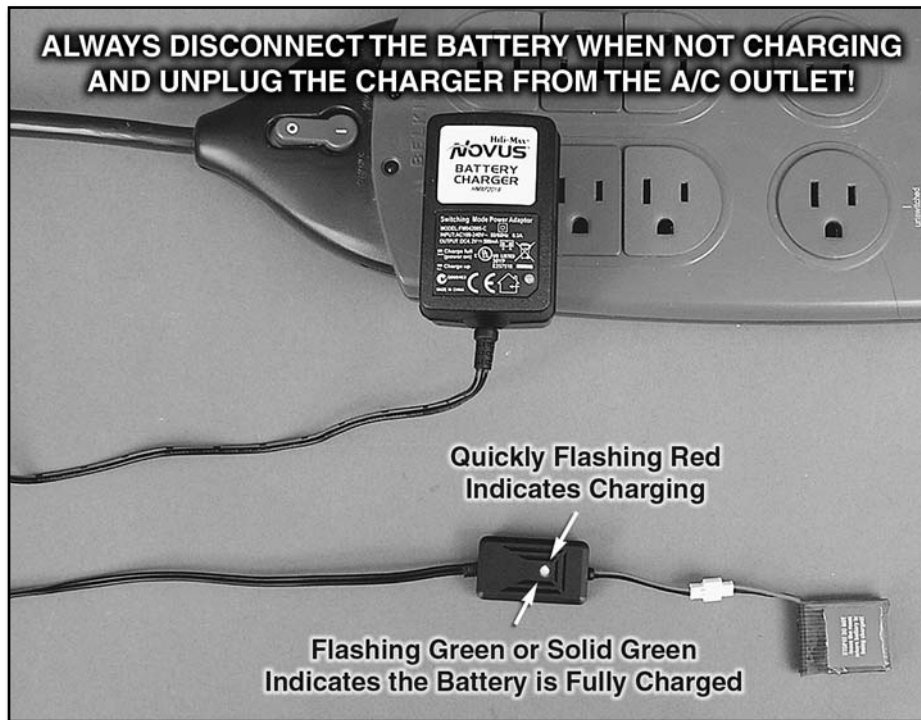

☐ Plug the battery into the charger. The charge indicator light will start flashing red quickly; this indicates that the battery is being charged. Once the battery is completely charged, the charge indicator light will turn green (solid or flashing). Under normal operating conditions, the battery may take up to one hour to recharge.

Heli-Max™ **LITHIUM BATTERY HANDLING & USAGE**



WARNING!! Read the entire instruction sheet included with this battery. Failure to follow all instructions could cause permanent damage to the battery and its surroundings, and may cause bodily harm!



Land your model immediately when the battery begins to lose power. Recharge the battery before attempting another flight. A dangerous situation can occur when attempting to recharge an over-discharged battery!

- ALWAYS charge the battery inside a fireproof container placed in a fireproof location clear of combustible materials. Failure to do so can result in property damage and/or bodily harm!
- ALWAYS keep charging batteries within eyesight. Leaving the battery unattended is dangerous!
- ALWAYS keep a supply of sand accessible when charging. Dumping sand on the battery will extinguish the LiPo chemical fire.
- NEVER use anything EXCEPT a LiPo approved charger.
- NEVER charge over 4.20V per cell.
- NEVER charge at currents greater than 1C.
- NEVER charge through the “To ESC” or “DISCHARGE” lead.
- NEVER trickle charge, or allow the battery to discharge below 2.75V per cell.
- NEVER allow the battery temperature to exceed 140° F [60° C].
- NEVER disassemble or modify the pack wiring in any way or puncture cells.
- ALWAYS KEEP OUT OF REACH OF CHILDREN.

Electric Motor Warning

Electric motors are very dangerous. Do not work on the model while the flight battery is plugged in as interference may cause the main rotor blades to spin, possibly causing injury to yourself.

WARNING!! Once the flight battery is connected the helicopter will have full power available. You must take proper measures to ensure that the throttle stick is not moved and that the idle up switch is not turned on while handling the model.

Installing the Flight Battery



- Slide the flight battery into the Novus CP Helicopter as shown.



Turning the Model On

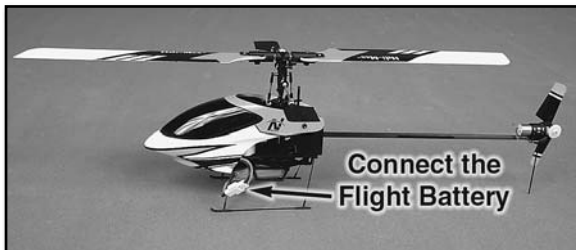

- The Novus CP Helicopter uses a 2.4GHz system that requires a binding process when the unit is powered up. This process involves connecting the flight battery to the ESC with the transmitter turned off. Ensure that the throttle stick is at its **lowest** position, and the idle up switch is **off**. Then turn the transmitter on. You will notice that the transmitter indicator begins to flash, indicating that the binding process is taking place.

Once the indicator quits flashing you should see the servos move, signifying that the receiver is now bound to the transmitter. The helicopter must be left still for 5 seconds so the gyro can perform the initialization process. The Novus

CP Helicopter is now ready for flight. Always step 15 feet [4.5m] away from the Novus CP Helicopter before operating the throttle. Do not hold the model while operating the throttle.

A safe start is built into the Novus CP Helicopter that prevents the motor from activating unless the collective stick has been lowered to the lowest position. If the motor won't run and turn the main blades, please make sure the collective stick is all the way down with the trim in its lowest position and leave it there for a couple of seconds. Then try moving the stick up slowly.

Balance the Main Blades

The Novus CP Helicopter main rotor blades are already balanced and ready to fly.



Transmitter Controls

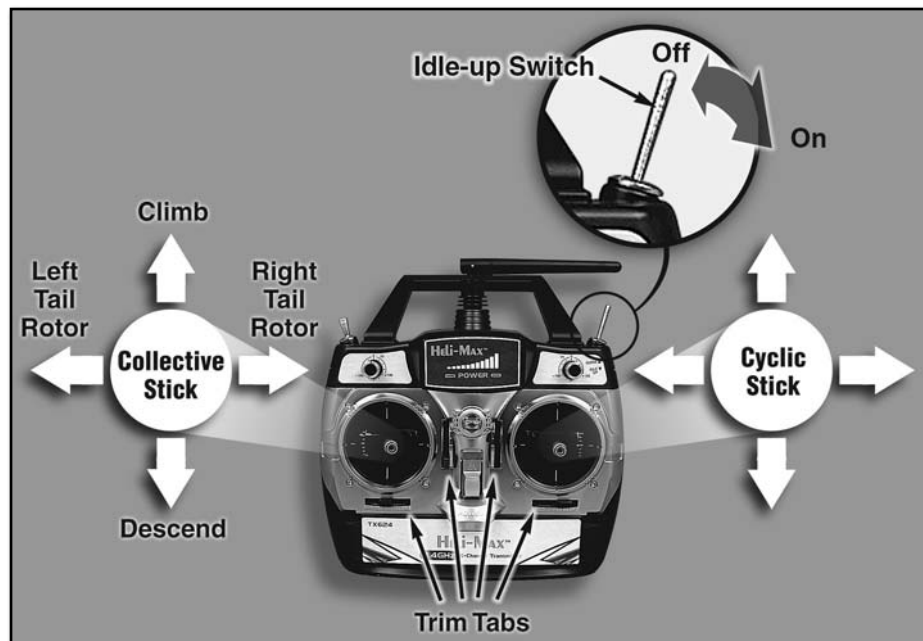

All controls described as follows are with the tail pointing directly towards you. This is the best way to start out since it keeps the control inputs oriented the same. Once you start getting comfortable you can work on side hovering and nose-in.

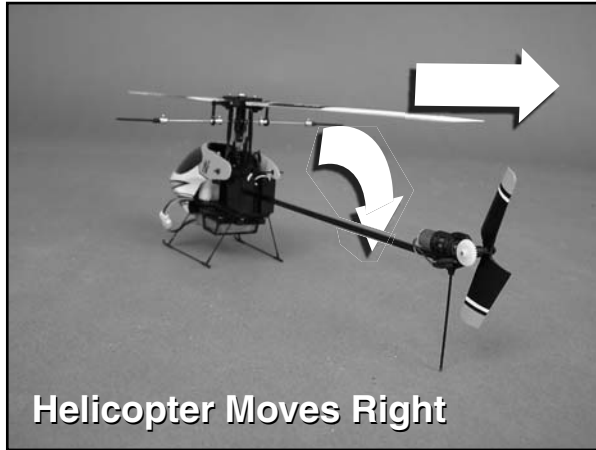

Moving the **cyclic stick right** will cause the helicopter to tilt right and start moving that direction.

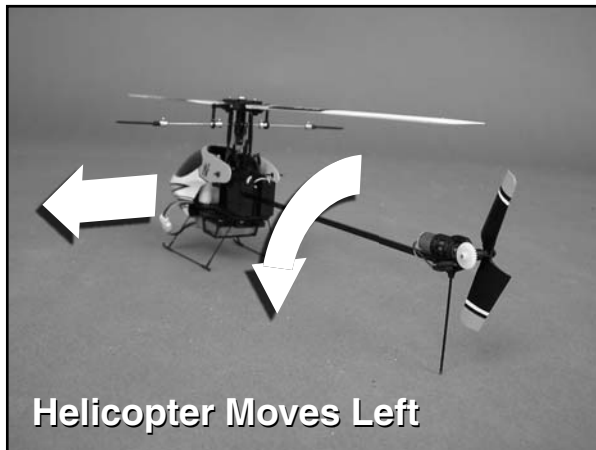

Moving the **cyclic stick left** will cause the helicopter to tilt left and start moving that direction.

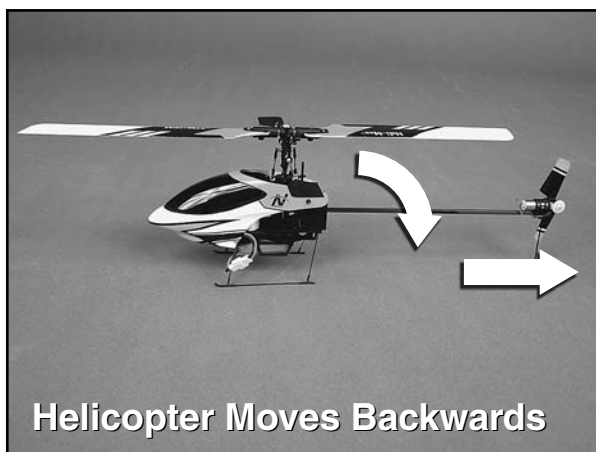

Moving the **cyclic stick backwards** (towards you) will cause the helicopter to tilt backwards and start moving that direction.



Moving the **cyclic stick forward** (away from you) will cause the helicopter to tilt forward and start moving that direction.

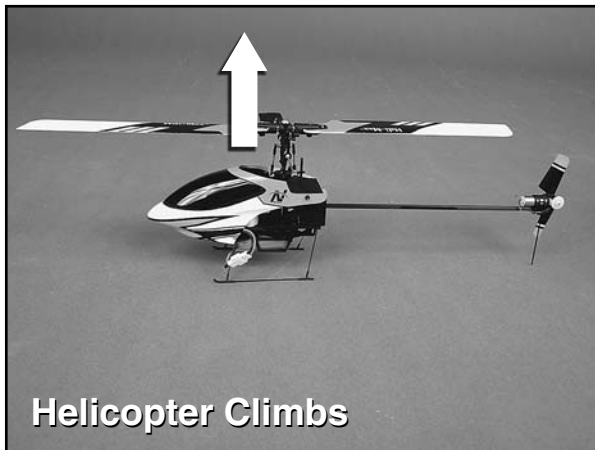

Moving the **collective stick up** (away from you) will cause the helicopter to climb higher.

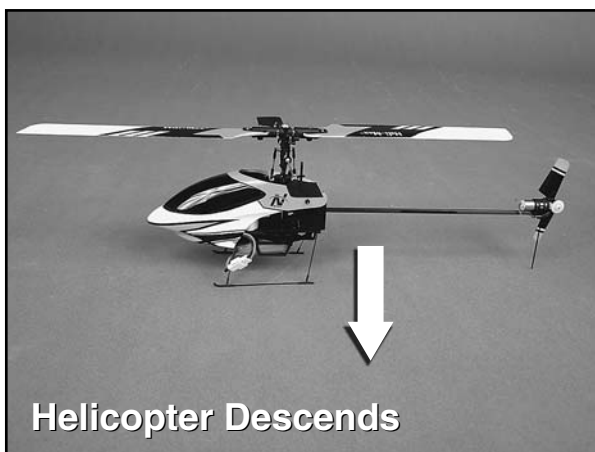

Moving the **collective stick down** (towards you) will cause the helicopter to descend.

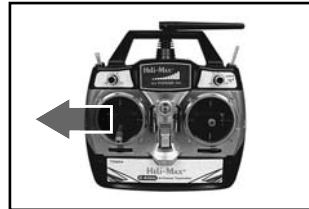
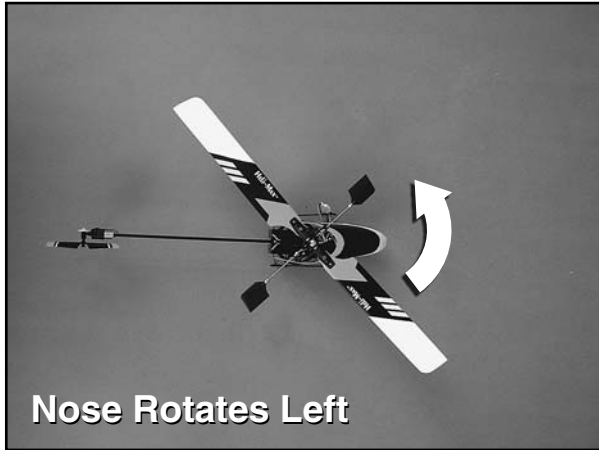

Moving the **tail rotor stick** towards the **left** will cause the helicopter nose to rotate left (counterclockwise).

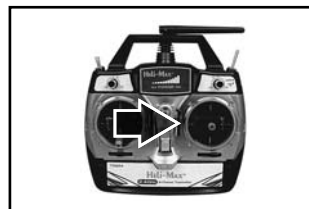
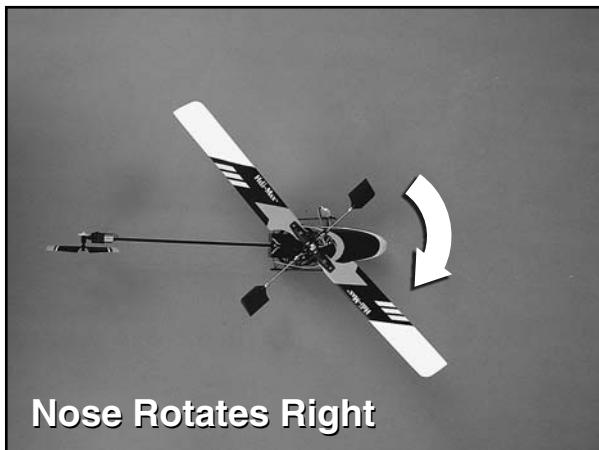

Moving the **tail rotor stick** towards the **right** will cause the helicopter nose to rotate right (clockwise).



The Heli-Max Novus CP is an extremely lightweight helicopter. Taking that into consideration, you should only fly the helicopter indoors or in calm winds less than 1mph. Until you become accustomed to the Novus CP helicopter we highly recommend flying it in a large area of at least 35 feet [10.5m] square with no obstacles. The Novus CP will not fly well in ground effect (air disturbance when the model is hovered below 1 foot [30cm]). Please maintain a minimum altitude of 1foot [30cm] to avoid ground effect.

Crashing

We already know that crashing is going to occur. Once you realize the model is going to collide with something or crash into the ground, you should always turn the idle up switch off and bring the throttle stick all the way down to stop the main rotor blades from rotating. If you can remember to do this, chances are you will not damage the helicopter in the crash. The main rotor blades carry a lot of RPM and inertia during flight. Cutting the power to the main rotor blades will prevent most of the crash damage.

Takeoff

Slowly add power and observe the model. If you feel it needs trimming, do so before lift off. You will find that model helicopters never allow you to return the sticks to center. You just need to position the stick as needed to maintain a steady hover.

You will notice the cyclic controls lag behind your inputs. This is perfectly normal and something you get the feel for with time. It's normal to drift around a little in a hover until you get used to flying the model. The cyclic controls are fairly sensitive so only small movements are necessary.

Hovering

Once the helicopter is up in the air, simply try to hold it in one spot. This can take some practice. Wind or air currents have a big effect on the stability of the helicopter as well. Be patient and slowly work forward, as trying to rush the learning process can be costly.

Landing

Level the helicopter into a steady hover and slowly decrease power until the helicopter settles onto the ground.

Basic Maneuvers

Once you become comfortable with hovering at different orientations and landing, it's time to move on to more advanced maneuvers.

Slow Pirouettes – Add a small amount of tail rotor (left or right) and try rotating the helicopter slightly sideways and see if you can hold it there. If you feel uncomfortable, then bring the tail back toward you. Once you start getting comfortable, try moving the helicopter to the side. Then turn back and fly back to the other side in straight lines. Once you get that down you can try rotating the helicopter around 360 degrees, which is called a pirouette. The helicopter can drift during these so make sure you have plenty of room when you first start practicing.

Nose-in Hovering – After pirouettes it's time to move on to nose-in hovering. Take off and climb to 10 feet [3m]. Practice half pirouettes from tail in to nose-in hovering and try to lengthen the delay in between. This will give you a little practice nose-in and still give you a chance to get out of trouble. As you improve you'll remain nose-in for longer periods of time.

GOOD LUCK AND GREAT FLYING!

Heli-Max™

MAINTENANCE & REPAIR

Working on the Heli-Max™ Novus CP will require small tools. The DTXR0170 DuraTrax® Precision Phillips Screwdriver 00x75mm is recommended for the Novus CP.

Although the Novus CP is a sturdy helicopter, on occasion it will be necessary to replace damaged parts after a crash. Please use this section as a guide to performing these steps.

NOVUS CP – MAIN ROTOR BLADE REPLACEMENT

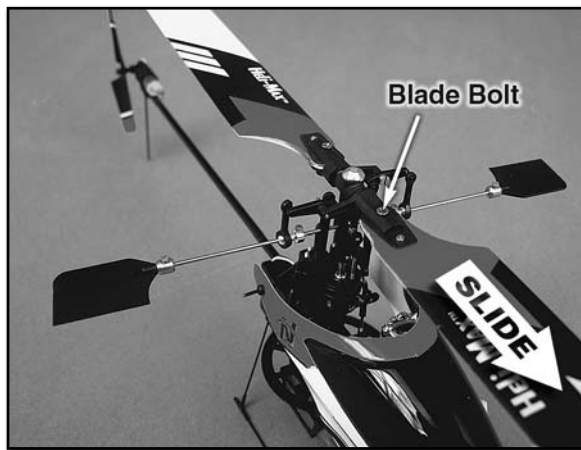

Remove the blade bolt using a #00 phillips screwdriver. After the blade bolt has been removed, slide the rotor blade out of the blade grip. Reinstall the new blade, ensuring that the holes within the blade and blade grip are aligned properly. Reinstall the blade bolt.

NOVUS CP – MAIN ROTOR GRIP REPLACEMENT

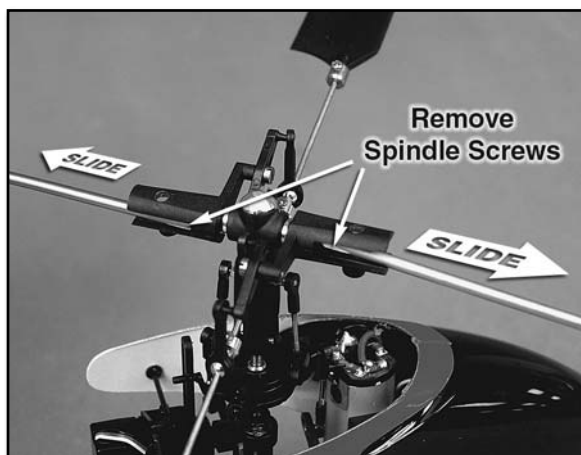

Remove both blade bolts and main rotor blades. Remove the linkages from both blade grip mixers. Remove the two spindle screws and the blade grips can be easily removed. Reinstall the parts in the reverse order listed above.

NOVUS CP – REPLACING THE FLYBAR

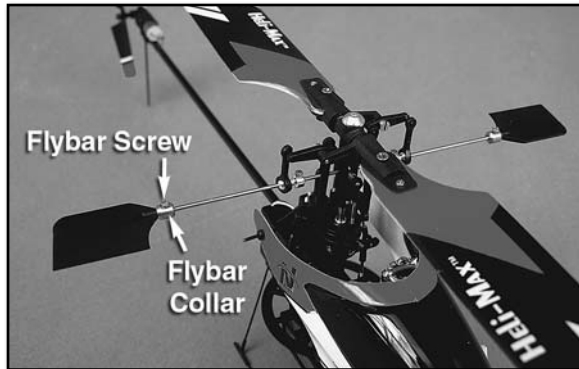

Loosen the screws on both flybar paddle collars. Rotate the paddles counter clockwise to remove the paddle and the collar from the flybar. Loosen the screws on the flybar carrier (both sides). At this point the flybar can be slid out of the flybar carrier. Slide the new flybar into the flybar carrier and ensure that

the new flybar is centered. Tighten the flybar carrier screws and reinstall the paddles. Ensure that the paddles are equal distances out on the flybar and tighten the flybar paddle collar screws.

NOVUS CP – REPLACING THE MAIN GEAR

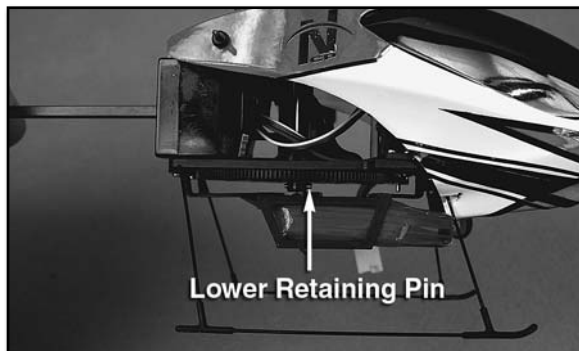

Remove the lower retaining pin from the main gear using needle nose pliers. Remove the old main gear from the model and install the new main gear. Align the hole in the main shaft with the hole in the main gear and press the small pin back through the hole.

NOVUS CP – REPLACING THE MAINSHAFT

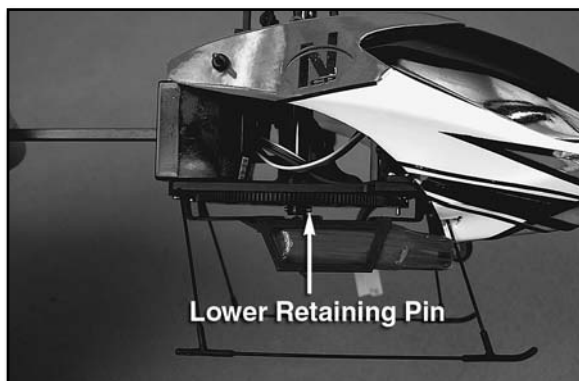

Remove the lower retaining pin from the main gear using needle nose pliers. Disconnect the servo linkages from the swashplate. Slide the main shaft straight up and out of the main frame. Remove and transfer necessary parts to the new main shaft and reinstall by reversing the order listed above.

NOVUS CP – REPLACING THE TAIL SHAFT AND TAIL ROTOR

Use a flat blade screw driver to carefully pry the tail rotor retainer from the

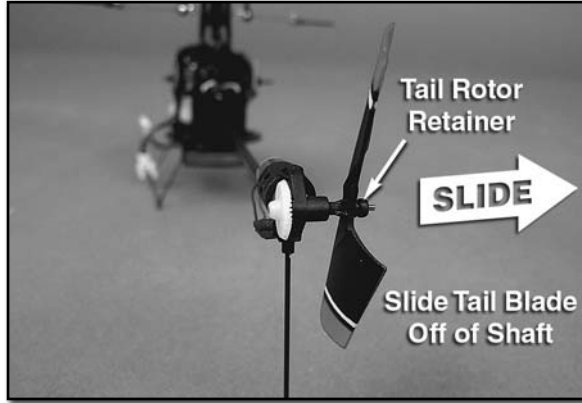

tail rotor shaft. Slide the tail rotor off of the shaft. Slide the tail rotor shaft out the opposite side of the tail rotor case. Slide the new tail rotor shaft into the tail rotor housing. Please note that the tail rotor shaft has a flat spot. Carefully align the tail rotor blade to this flat spot and slide the tail rotor onto the shaft. Install the tail rotor retainer.

NOVUS CP – REPLACE THE TAILBOOM

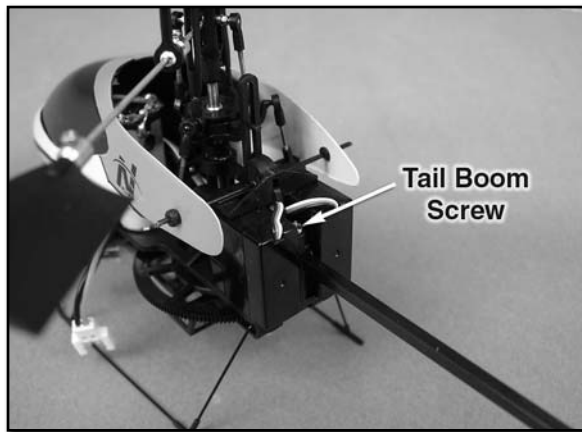

Loosen the tail boom screw and unplug the tail motor wire from the E-Board. It will be necessary to cut the motor wires near the tail motor where the heat shrink tubing has been applied. While holding onto the tail motor connector at the front, slowly slide the tail boom out of the frame and off the tail motor wires. If you notice any damage to the tail motor wires it will

be necessary to replace the tail motor wire harness. Slide the tail motor wires into the tail boom and reinstall the tail boom onto the helicopter. On the old tail boom, remove the lower tail motor retention screw and remove the tail motor gear box assembly. Run the tail motor wires through the tail motor gear box assembly. Ensure that the tail boom is pressed far enough into the main frame and tighten the tail boom screw on the main frame. Ensure that the tail gear box assembly is pressed far enough onto the tail boom and ensure that the tail rotor is vertically aligned with the main shaft. Tighten the lower tail gear box retention screw once you are certain that everything is correct. Re-solder the tail motor wires to the tail rotor wire harness and install heat shrink tubing. Ensure everything is correctly installed and all bolts have been tightened.

NOVUS CP – REPLACING A MOTOR

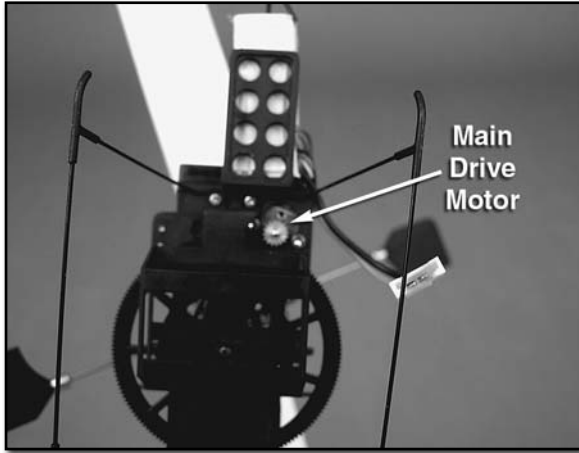

Unplug the motor from the E-Board and remove the motor mounting screws. Remove the old motor and install the new motor. Reinstall the motor mounting screws and plug the motor connector back into the E-Board.

NOVUS CP – E-BOARD CONNECTIONS

Transmitter Settings

WARNING!!

The Heli-Max Novus CP has been factory-set and test flown. Do not make adjustments to the transmitter settings until you have flown the model a few times.

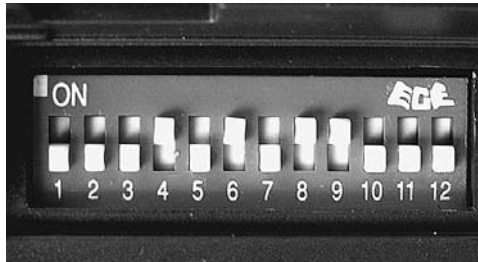

Switch	Function	Default
1	Elevator Reversing Switch	Off
2	Aileron Reversing Switch	Off
3	Throttle Reversing Switch	Off
4	Rudder Reversing Switch	On
5	Gear Reversing Switch	Off
6	Pitch Reversing Switch	On
7	CCPM Elevator Reversing Switch	Off
8	Revolution Mixing Reversing Switch	On
9	CCPM Mixing / Normal Mixing	On
10	Throttle Position and Servo Exponential Adjustment	Off
11	Pitch Curve Adjustment	Off
12	Gyro Gain and Revolution Mixing	Off

Throttle Position and Servo Exponential Adjustment

Remove the switch cover from the back of the transmitter. With the transmitter turned off and the flight battery disconnected from the helicopter, set both the V1 and V2 dials to 0. Set the Flight Mode Switch to NORM. Set switch 10 to On and turn the transmitter on to enable Throttle Curve and Servo Exponential Adjustment.

The V1 dial is used to set the throttle % at mid stick for either normal flight mode or idle up flight mode. Set the flight mode switch to the flight mode you would like to adjust. Turn the dial towards “-100” to reduce the throttle position at mid stick. Turn the dial towards “+100” to increase the throttle at mid stick. The recommended throttle position for normal flight mode is +15 and the recommended throttle position for idle up flight mode is +30.

The servo exponential is set by using the V2 dial. Set the dial to 0 for linear travel, use +1 to +100 to decrease the sensitivity of the cyclic controls and -1 to -100 to increase the sensitivity of the cyclic controls. The factory setting is 0 which provides a linear feel. If you feel the controls are overly sensitive then we would recommend trying +40.

When you are done making adjustments, set switch 10 to Off.

Pitch Curve Adjustment

Remove the switch cover from the back of the transmitter. With the transmitter turned off and the flight battery disconnected from the helicopter, set both the V1 and V2 dials to 0. Set the Flight Mode Switch to NORM. Set switch 11 to On and turn the transmitter on to enable Pitch Curve Adjustment.

The V1 dial is used to adjust NORM flight mode hovering pitch. Turn V1 towards +100 to add more pitch at mid stick. Turn V1 towards -100 to decrease pitch at mid stick. Adding more pitch will decrease the hovering head speed. Less pitch will increase the hovering head speed. The V2 dial is used to adjust the maximum pitch range. If you feel the model needs less pitch at full positive or negative collective then turn the dial towards -100. If you feel the model needs more pitch at full positive or negative collective then turn the dial towards +100. Too much pitch may overpower the tail rotor's ability to maintain heading. It is best to make small adjustments and perform a test flights between adjustments.

When you are done making adjustments, set switch 11 to Off.

Gyro gain and Revolution Mixing Adjustment

Remove the switch cover from the back of the transmitter. With the transmitter turned off and the flight battery disconnected from the helicopter, set both the V1 and V2 dials to 0. Set switch 12 to On and turn the transmitter on to enable Gyro gain and Revolution Mixing Adjustment.

The V1 dial is used to set the gyro gain. Simply set the gain by turning the dial towards "+100". The recommended starting gain is +80. If you notice that the tail is slow drifting then a higher gain value should be used. If you notice that the tail rotor quickly oscillates back and forth then lowering the gain value should help.

The revolution mixing is set by using the V2 dial. Set the dial to 0, use +1 to +100 to set the amount of revolution mixing. The factory setting is +30. If you notice the nose of the helicopter is rotating to the left during a climb out then simply increase the revolution mixing. If you notice the nose of the helicopter rotating to the right during a climb out then the revolution mixing is too high and simply decrease the value.

When you are done making adjustments, set switch 12 to Off.

E-Board Adjustments

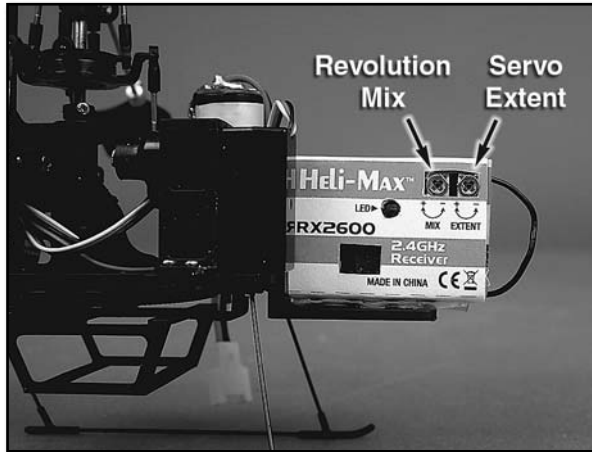

The Revolution Mix adjustment controls how much tail rotor is mixed when throttle is increased or decreased. If you find the model rotates to the left when climbing please increase the adjustment by turning the dial towards the "+". If the model rotates to the right when climbing then decrease the adjustment by turning the dial towards the "-".

The Servo Extent adjustment is used to increase the cyclic control throws. If you feel the cyclic controls are not adequate then please turn the extent adjuster towards the "+". If you feel the cyclic controls are too aggressive then turn the extent adjuster towards the "-". It is best to make several small adjustments to determine the best setting for you.

Heli-Max™ Novus CP Exploded View

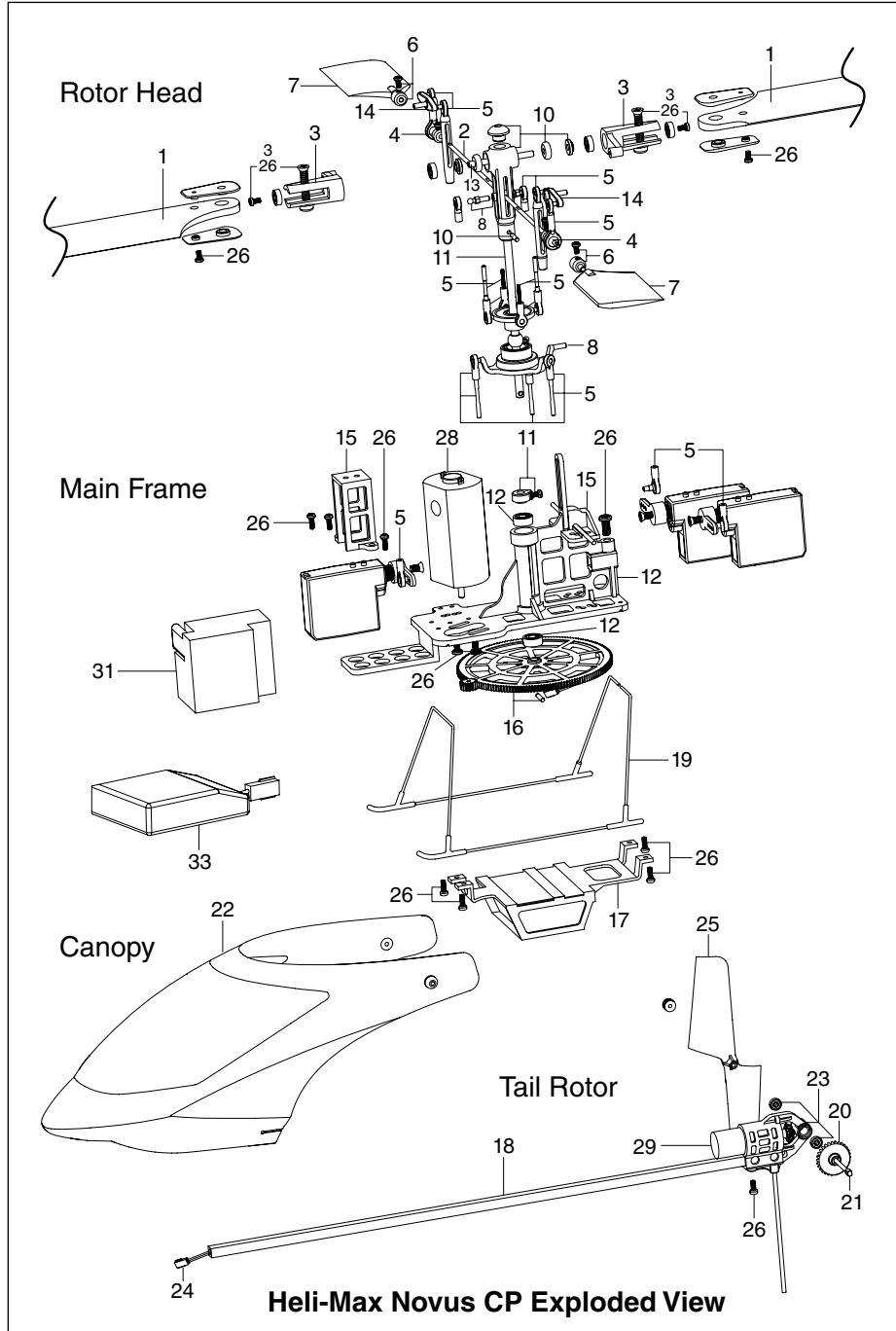

Heli-Max™ Novus CP Parts List

1. HMXE8326 Main Rotor Blades Novus CP
2. HMXE8552 FlyBar Novus CP
3. HMXE8553 Main Blade Grips Novus CP
4. HMXE8554 Flybar Bell Mixer Ball Carrier Novus CP
5. HMXE8555 Complete Linkage Set Novus CP
6. HMXE8556 Flybar Paddle Mounts Novus CP
7. HMXE8557 Flybar Paddles Novus CP
8. HMXE8558 Swashplate Assembly Novus CP
9. HMXE8559 Flybar Pivot Assembly Novus CP
10. HMXE8560 Head Block Assembly Novus CP
11. HMXE8561 Main Shaft Novus CP
12. HMXE7948 Main Frame Assembly Novus CP
13. HMXE8562 Feathering Spindle Novus CP
14. HMXE8563 Bell Hiller Mixing Arms Novus CP
15. HMXE7953 Servo Mount Novus CP
16. HMXE8034 Main Drive Gear Novus CP
17. HMXE7949 Battery Frame Mount Novus CP
18. HMXE8436 Tail Boom Novus CP
19. HMXE7954 Landing Gear Novus CP
20. HMXE8437 Tail Bevel Drive Gear Novus CP
21. HMXE8438 Tail Rotor Shaft Novus CP
22. HMXE7396 Printed Canopy Novus CP
23. HMXE8439 Tail Motor Mount Novus CP
24. HMXE9538 Tail Motor Wire Novus CP
25. HMXE8440 Tail Rotor Blade Novus CP
26. HMXE7331 Complete Screw Set Novus CP
27. HMXE8831 Complete Ball Bearing Set Novus CP
28. HMXG8011 Main Drive Motor Novus CP
29. HMXG8012 Tail Drive Motor Novus CP
30. HMXM2024 Servos 3g (3) Novus CP
31. HMXM2025 3 in 1 E-Board Novus CP
32. HMXJ2026 6 Channel Transmitter Novus CP
33. GPMP0408 1S LiPo 400 mAh Battery Novus CX/FP/CP

Heli-Max™ Novus CP Option Part

- HMXE7476 CNC Aluminum Head Conversion Kit Novus CP
- HMXE7472 CNC Main Blade Grips Novus CP
- HMXE7473 CNC Head Block Novus CP
- HMXE7474 CNC Swashplate Assembly Novus CP
- HMXE7475 CNC Bell Mixer Novus CP
- HMXG8015 Brushless Upgrade Kit RX, ESC, Motor Novus CP
- GPMM3150 Charge Lead Banana to HMX Micro Plug

Optional products available for the Novus CP

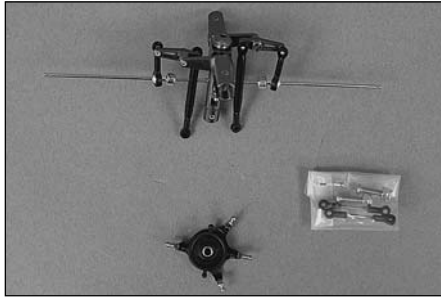

**CNC Aluminum Head
Conversion Kit - Novus CP**
HMXE7476

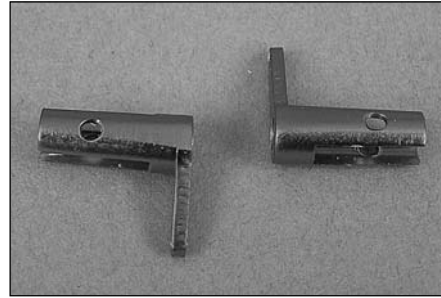

**CNC Main Blade Grips
Novus CP**
HMXE7472



**CNC Head Block
Novus CP**
HMXE7473

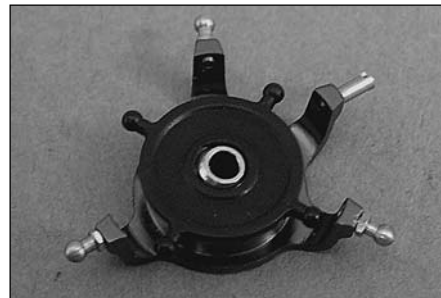

**CNC Swashplate Assembly
Novus CP**
HMXE7474

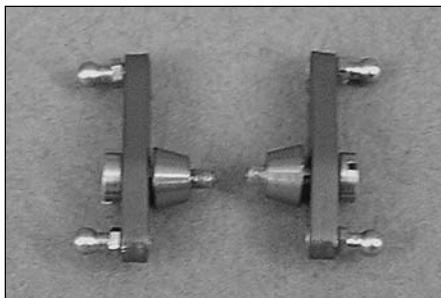

**CNC Bell Mixer
Novus CP**
HMXE7475

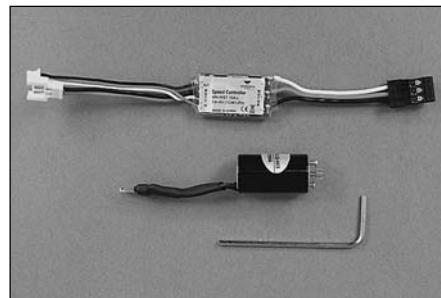

**Brushless Upgrade Kit RX,
ESC, Motor - Novus CP**
HMXG8015

Other fine products



Heli-Max Axe™ EZ EP Mini RTF

HMXE05**



Heli-Max Novus CX

HMXE0803



Heli-Max AXE CPv3 Micro RTF

HMXE07**



Heli-Max Axe CX Micro Coaxial RTF

HMXE09**

available from **Heli-Max™**

**Heli-Max
Kinetic™ 50 ARF**

HMXE0250



**Heli-Max
Novus FP**

HMXE0802



**Heli-Max AXE
400 3D RTF**

HMXE0800



**Heli-Max AXE
400 3D RxR**

HMXE0801



This device complies with Part 15 of the FCC Rules.

Operation is subject to the following two conditions;

(1)、 This device may not cause interference, and

(2)、 This device must accept any interference received, including interference that may cause undesired operation of the device.

Any changes or modifications not expressly approved by the party responsible for compliance could void the user's authority to operate the equipment.