

Hisense

2.1 ch Soundbar With Wireless Subwoofer

Model: HS212



USER MANUAL



Read all the safety instructions carefully before use and keep this instruction manual for future reference.

Contents

Important Safety Instructions	2
Package Contents	4
Product Diagram	5
Main Unit	5
Remote Control.....	6
Instructions	6
Prepare the Remote Control.....	6
Replace the Remote Control Battery.....	6
Placement and Mounting.....	7
Wall Mounting	7
Connections	8
HDMI socket	8
Use the OPTICAL Socket	8
RCA(AUX)Socket	9
Use the LINE INSocket	9
Connect Power	9
Subwoofer Connection.....	9
Basic Operation	10
Standby/ON.....	10
Select Modes.....	10
Adjust the Volume.....	10
Select a Preset Sound Effect	10
AUX / LINE IN / OPTICAL / HDMI ARC Operation	10
Bluetooth Operation	11
Pair Bluetooth-enabled Devices.....	11
Listen to Music from Bluetooth Device	11
USB Operation	12
Troubleshooting	12
Specifications	13

EN

Important Safety Instructions

EN

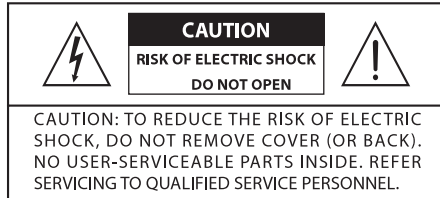

The lightning flash with arrowhead symbol, within an equilateral triangle, is intended to alert the user to the presence of uninsulated "dangerous voltage" within the product's enclosure that may be of sufficient magnitude to constitute a risk of electric shock to persons.



The exclamation point within an equilateral triangle is intended to alert the user to the presence of important operating and maintenance (servicing) instructions in the literature accompanying the appliance.

Safety

- 1 Read these instructions – All the safety and operating instructions should be read before this product is operated.
- 2 Keep these instructions – The safety and operating instructions should be retained for future reference.
- 3 Heed all warnings – All warnings on the appliance and in the operating instructions should be adhered to.
- 4 Follow all instructions – All operating and use instructions should be followed.
- 5 Do not use this apparatus near water – The appliance should not be used near water or moisture – for example, in a wet basement or near a swimming pool, and the like.
- 6 Clean only with dry cloth.
- 7 Do not block any ventilation openings. Install in accordance with the manufacture's instructions.
- 8 Do not install near any heat sources such as radiators, heat registers, stoves, or other apparatus (including amplifiers) that produce heat.
- 9 Danger of explosion if battery is incorrectly replaced. Replace only with the same or equivalent type.
- 10 Do not defeat the safety purpose of the polarized or grounding plug. A polarized

plug has two blades with one wider than the other. A grounding plug has two blades and a third grounding prong. The wide blade or the third prong is provided for your safety. If the provided plug does not fit into your outlet, consult an electrician for replacement of the obsolete outlet.

- 11 Protect the power cord from being walked on or pinched particularly at the plugs, convenience receptacles, and at the point where they exit from the apparatus.
- 12 Only use attachments/accessories specified by the manufacturer.
- 13 Use only with the cart, stand, tripod, bracket, or table specified by the manufacturer, or sold with the apparatus. When a cart or rack is used, use caution when moving the cart/apparatus combination to avoid injury from tip-over.
- 14 Unplug the apparatus during lightning storms or when unused for long periods of time.
- 15 Refer all servicing to qualified personnel. Servicing is required when the apparatus has been damaged in any way, such as power supply cord or plug is damaged, liquid has been spilled or objects have fallen into the apparatus has been exposed to rain or moisture, does not operate normally, or has been dropped.
- 16 This equipment is a Class II or double insulated electrical appliance. It has been designed in such a way that it does not require a safety connection to electrical earth.
- 17 To reduce the risk of fire or electric shock, do not expose this apparatus to rain or moisture. The apparatus must not be exposed to dripping or splashing and objects filled with liquids, such as vases, must not be placed on apparatus.
- 18 The mains plug is used as the disconnect device, the disconnect device shall remain readily operable.

Warning

- The battery (batteries or battery pack) shall not be exposed to excessive heat such as sunshine, fire or the like.
- These servicing instructions are for use by qualified service personnel only. To reduce the risk of electric shock, do not perform

Important Safety Instructions

any servicing other than that contained in the operating instructions unless you are qualified to do so.

- Avoid foreign bodies and liquids entering the device.
- Do not place open e.g. lit candles, on or directly adjacent to the device.
- Do not use any corrosive or abrasive cleaning agents. These could damage the surface of the device.
- Please refer the information on exterior bottom or rear enclosure for electrical and safety information before installing or operating the apparatus.
- Minimum distance around the apparatus for sufficient ventilation is 5cm;
- The ventilation should not be impeded by covering the ventilation openings with items such as newspaper, table-cloths, curtains etc.
- No naked flame sources such as lighted candles should be placed on the apparatus;
- Batteries should be recycled or disposed of as per state and local guidelines;
- The use of apparatus in moderate climates.
- The marking label is pasted on the bottom or back of the equipment.

WARNING

DO NOT INGEST BATTERY, CHEMICAL BURN HAZARD

If you think batteries might have been swallowed or placed inside any part of the body, seek immediate medical attention. Keep new and used batteries away from children. If the battery compartment does not close securely, stop using the product and keep it away from children. The remote control supplied with this product contains a coin/button cell battery. If the coin/button cell battery is swallowed, it can cause severe internal burns in just 2 hours and lead to death.



Correct Disposal of this product. This marking indicates that this product should not be disposed with other household wastes throughout the EU.

To prevent possible harm to the environment or human health from uncontrolled waste disposal, recycle it responsibly to promote the sustainable reuse of material resources. To return your used device, please use the return and collection systems or contact the retailer where the product was purchased. They can take this product for environmental safe recycling.



The Bluetooth® word mark and logos are registered trademarks owned by Bluetooth SIG, Inc. We are the licensee to use such marks. Other trademarks and trade names are those of their respective owners.



Manufactured under license from Dolby laboratories. Dolby and the double-D symbol are trademarks of Dolby Laboratories.

FCC INFORMATION (for US customers)

Warning:

Changes or modifications to this unit not expressly approved by the party responsible for compliance could void the user's authority to operate the equipment."

NOTE:

- This equipment has been tested and found to comply with the limits for a Class B digital device, pursuant to Part 15 of the FCC Rules. These limits are designed to provide reasonable protection against harmful interference in a residential installation. This equipment generates, uses and can radiate radio frequency energy and, if not installed and used in accordance with the instructions, may cause harmful interference to radio communications.
- However, there is no guarantee that interference will not occur in a particular installation. If this equipment does cause harmful interference to radio or television reception, which can be determined by turning the equipment off and on, the user is encouraged to try to correct the interference by one or more of the following measures:
 - Reorient or relocate the receiving antenna.
 - Increase the separation between the equipment and receiver.
 - Connect the equipment into an outlet on a circuit different from that to which the receiver is connected.
 - Consult the dealer or an experienced radio / TV technician for help.
- This device complies with Part 15 of the FCC Rules. Operation is subject to the following two conditions:
 - (1) this device may not cause harmful interference, and
 - (2) this device must accept any interference received, including interference that may cause undesired operation.
- Shielded cables must be used with this unit to ensure compliance with the Class B FCC limits.

EN

Important Safety Instructions

IC warning

This device complies with Industry Canada licence-exempt RSS standard(s).

Operation is subject to the following two conditions: (1) This device may not cause interference, and (2) This device must accept any interference, including interference that may cause undesired operation of the device.

FCC Radiation Exposure Statement

This equipment complies with FCC radiation exposure limits set forth for an uncontrolled environment. This equipment should be installed and operated with minimum distance 20CM between the radiator & your body.

Package Contents

EN

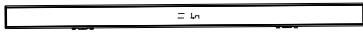

Main Unit



Remote Control

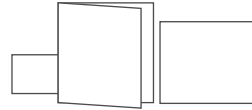

User Manual
Quick Start Guide
Pattern Paper

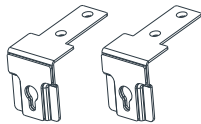

Bracket(2x)

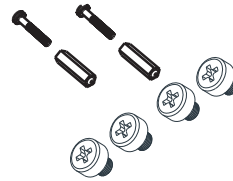

Wall plug(2x) and screw(2x) and bracket screw(4x)

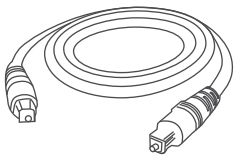

Optical Cable

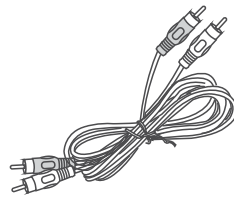

RCA audio Cable

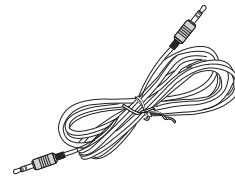

3.5mm to 3.5mm audio Cable

Product Diagram

Front View

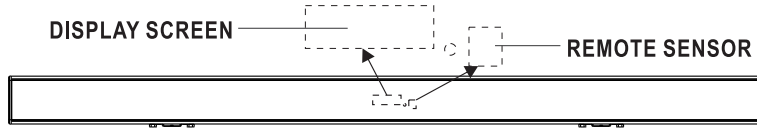

Rear View

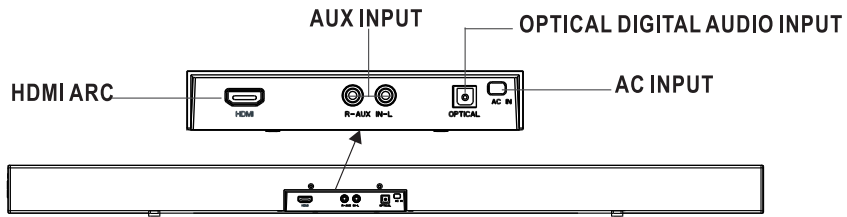

EN

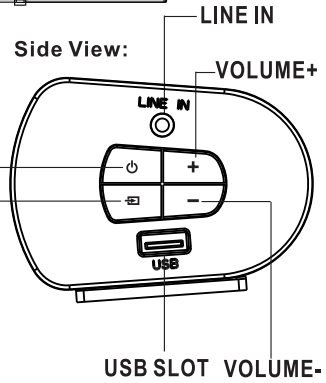

HS 212 Remote Control and LED Display and Port

Remote Control	LED Display	Port	Functional Mode
OPT	OPT	OPTICAL	Switch to OPTICAL mode
BT	bt	/	Switch to Bluetooth mode
LINE IN	LInE	LINE IN	Switch to LINE IN mode
RCA	rCA	R-AUX,IN-L	Switch to RCA(AUX) mode
USB	USb	USB	Switch to USB mode
HDMI ARC	ArC	HDMI	Audio Return Channel from TV/AV to Sound bar
VOL+/VOL-	U 0~45	Inside	Increase/Decrease the volume level
▶II/PAIR	PLAy/PAUS	Inside	Play/pause/resume playback in Bluetooth mode Press and Hold to active the pairing function in Bluetooth mode or disconnect the existing paired Bluetooth device
⏮/⏭	001	Inside	In Bluetooth mode/USB mode:Skip to previous/next track
MOVIE	eq2	Inside	Viewing in MOVIE mode
NEWS	eq3	Inside	listening in NEWS mode
MUSIC	eq1	Inside	listening in MUSIC mode
MUTE	U 0 0	Inside	Mute or resume volume
STANDBY	on/byE	Inside	Switch the unit between ON and STANDBY mode

Remote Control

1 STANDBY Switch the unit between ON and STANDBY mode.

2 OPT Switch to OPTICAL IN mode.

3 BT Switch to BLUETOOTH mode.

4 USB Switch to USB mode.

5 VOLUME+ Increase the volume level.

6 PREVIOUS Skip to previous track.

7 PLAY/PAUSE/PAIR Play/pause/resume playback.
In bluetooth connection, press and hold to disconnect the existing paired bluetooth device.

8 VOLUME- Decrease the volume level.

9 EQ Select a preset sound effect mode.

10 MUTE Mute or resume volume.

11 RCA/LINE IN Switch the unit between RCA and LINE IN mode.

12 HDMI ARC Switch to HDMI ARC mode.

13 NEXT Skip to next track.

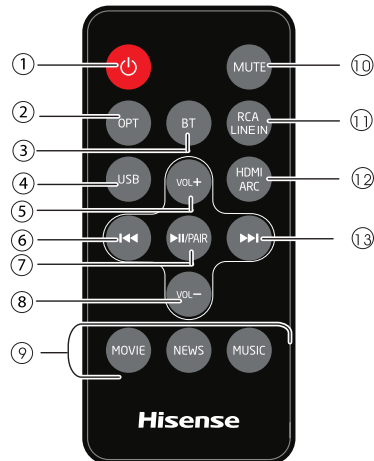

Instructions

Prepare the Remote Control

The Remote Control allows the unit to be operated from a distance.

- Even if the Remote Control is operated within the effective range 19.7 feet (6m) inch, remote control operations may be disrupted if there are any obstacles between the unit and the remote control.
- If the Remote Control is operated near other products that generate infrared rays, or if other remote control devices using infrared rays are used near the unit, it may operate incorrectly. Conversely, the other products may operate incorrectly.

First-time use:

The unit has a pre-installed lithium CR2025 battery. Remove the protective tab to activate the remote control battery.

Replace the Remote Control Battery

1. Pull out the battery tray and remove the old battery.
2. Place a new CR2025 battery into the battery tray with correct polarity (+/-) as indicated.
3. Insert the battery tray back into the slot.

Precautions Concerning Batteries

- When the Remote Control is not to be used for a long time (more than a month), remove the battery from the Remote Control to prevent it from leaking.
- If the batteries leak, wipe away the leakage inside the battery compartment and replace the batteries with new ones.
- Do not use any batteries other than those specified.
- Do not heat or disassemble batteries.
- Keep away from heat or moisture.
- Do not carry or store batteries with other metallic objects. Doing so could cause batteries to short circuit, leak or explode.
- Never recharge a battery unless it is confirmed to be a rechargeable type.

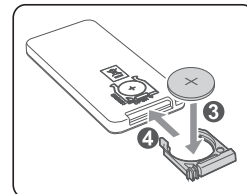
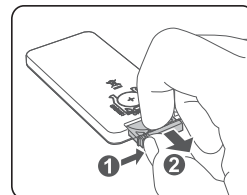
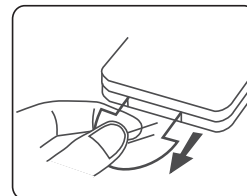

Placement and Mounting

Mounting soundbar on a wall

In order to prevent injuries, the sound base device must be securely fastened to the wall in accordance with the below installation instructions.

1. Drill the two holes (about 6mm diameter) in the wall and keep the distance between drill holes of the sound base is 500mm. As shown in the picture on the right (diagram 1).

2. Insert the two plugs supplied into two drilled holes and then insert two screws supplied into two holes and tighten. As shown in the picture on the right (diagram 2).

3. Take care to leave 4 mm between the screw heads and wall. As shown in the picture on the right (diagram 3).

4. Insert the wall-mounting bracket supplied into the pedestal of the sound base. As shown in the picture on the right (diagram 4).

5. Use the bracket screws supplied to insert the wall-mounting bracket hole and tighten. As shown in the picture on the right (diagram 5).

6. Use the assembled sound base to hang on the setscrews on the wall. As shown in the picture on the right (diagram 6).

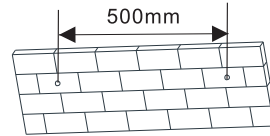

Diagram 1

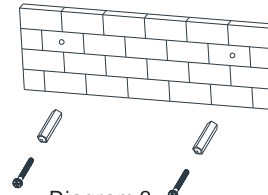

Diagram 2

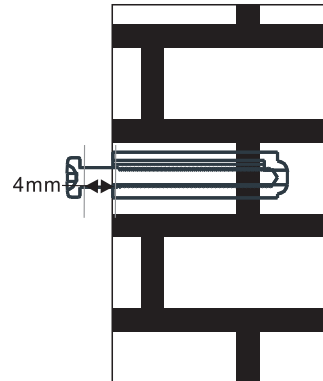

Diagram 3

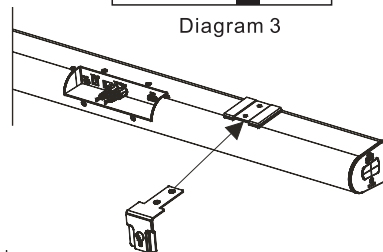

Diagram 4

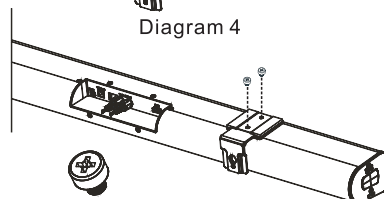

Diagram 5

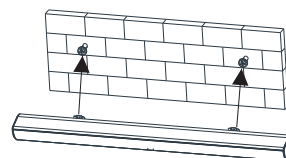

Diagram 6

EN

Connections

HDMI socket

EN

Use HDMI to connect the Soundbar, AV equipment and TV:

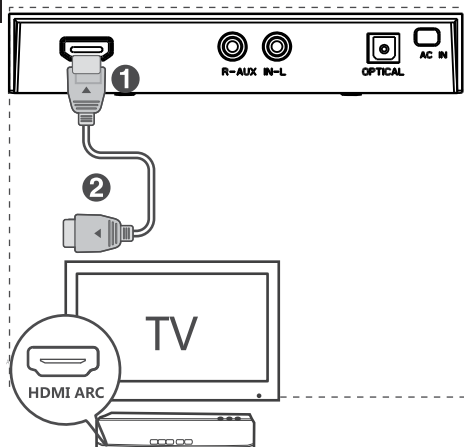

ARC (Audio Return Channel)

The ARC (Audio Return Channel) function allows you to send audio from your ARC-compliant TV to your sound bar through a single HDMI connection. To enjoy the ARC function, please ensure your TV is both HDMI-CEC and ARC compliant and set up accordingly. When correctly set up, you can use your TV remote control to adjust the volume output (VOL +/- and MUTE) of the sound bar.

- Connect the HDMI cable (not included) from unit's **HDMI (ARC)** socket to the HDMI (ARC) socket on your ARC compliant TV. Then press the remote control to select **HDMI ARC**.

Tips:

- Your TV must support the HDMI-CEC and ARC function. HDMI-CEC and ARC must be set to On.
- The setting method of HDMI-CEC and ARC may differ depending on the TV. For details about ARC function, please refer to your TV owner's manual.
- Only HDMI 1.4 cables can support the ARC function.

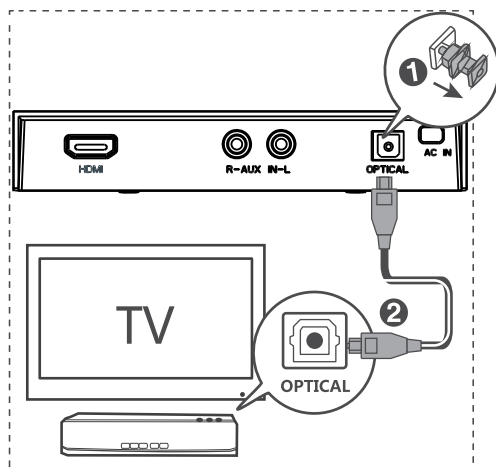

Use the OPTICAL Socket

Remove the protective cap of the OPTICAL socket, then connect an OPTICAL cable to the TV's OPTICAL OUT socket and the OPTICAL socket on the unit.

Tip: While in **OPTICAL** or **HDMI ARC** mode, if there's no sound output from the unit, you may need to activate **PCM** Signal output on your source device (eg. TV, DVD or Blu-ray player).

Connections

RCA(AUX) Socket

You also can use the **RCA(L,R)** cable to connect the **DVD's Audio out(L,R)** socket and **RCA(AUX)** socket on the unit.

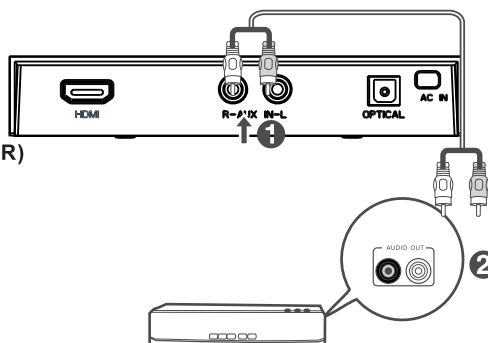

EN

Use the LINE IN Socket

- Use a RCA to 3.5mm audio cable to connect the TV's audio output sockets to the **LINE IN** socket on the unit.
- Use a 3.5mm to 3.5mm audio cable to connect the TV's or external audio device headphone socket to the **LINE IN** socket on the unit.

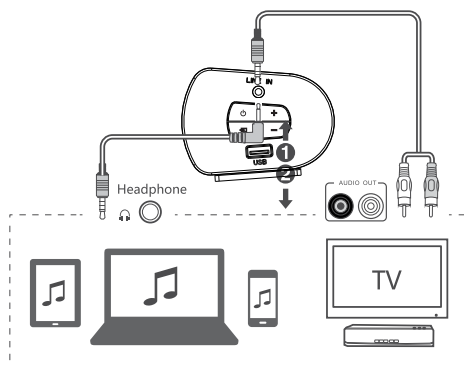

Connect Power

Risk of product damage!

Ensure that the power supply voltage corresponds to the voltage printed on the back or the underside of the unit.

- Before connecting the AC power cord, ensure you have completed all other connections.
- Insert the AC power cord into a mains socket.

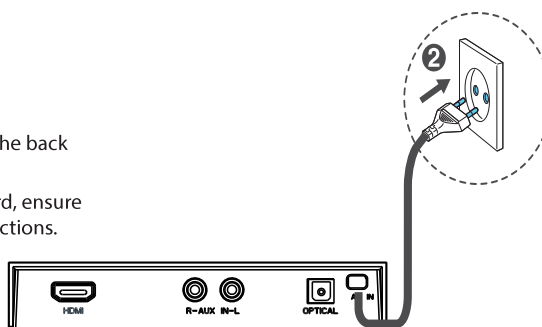

Subwoofer Connection

Make sure the AC power cord is connected to a power supply securely. subwoofer have the wireless bluetooth to receive the audio signal from the sound bar.when the blue indicator flashing , the subwoofer is in searching bluetooth signal status, the blue indicator keeps lighting means bluetooth was connected,if the subwoofer can not connect with the soundbase automatically,please press pair button on the rear panel of subwoofer to reconnect . The subwoofer will memories the sound bar and repaired automatically when you power off the subwoofer then power on.

REAR PANEL OF THE SUBWOOFER

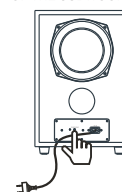

Basic Operation

Standby/ON

EN

- When you first connect the unit to the main socket, the unit will be in STANDBY mode. The POWER indicator will light up red.
- Press the  button on the remote control to switch the main unit ON or OFF.
- Disconnect the main plug from the main socket if you want to switch the unit off completely.
- If a TV or an external device is connected, the unit will switch on automatically when the TV or the external device is switched on.
- When there is no input signal from the unit in over 15 minutes, then it will automatically switch to Standby mode.

Select Modes

Press the  button on the unit or the **HDMI ARC, BT, OPTICAL, USB** and **RCA/LINE IN** buttons on the remote control to select the desired mode.

Adjust the Volume

- Press the **VOL+ / VOL-** buttons on the unit or on the remote control to adjust the volume.
- If you wish to turn the sound off, press the **MUTE** button on the remote control. Press the **MUTE** button again or press the **VOL+ / VOL-** buttons on the unit or on the remote control to resume normal listening. While adjusting the volume, LED display digit: from 01 to 45 or from 45 to 01.

Select a Preset Sound Effect

While playing, press the **NEWS** or **MOVIE** or **MUSIC** buttons on the remote control to select between preset equalizers: **Movie** (recommended for viewing movies), **Music** (recommended for listening to music), **NEWS** (recommended for listening to NEWS).

AUX / LINE IN / OPTICAL / HDMI ARC Operation

- 1 Ensure that the unit is connected to the TV or audio device.
- 2 Press the  button on the unit or the **AUX / LINE IN / OPTICAL / HDMI ARC** button on the remote control to select the desired mode.
- 3 Operate your audio device directly for playback features.
- 4 Press the **VOL +/-** button to adjust the volume to your desired level.

Tip: While in **OPTICAL** or **HDMI ARC** mode, if there's no sound output from the unit, you may need to activate **PCM** Signal output on your source device (eg. TV, DVD or Blu-ray player).

Bluetooth Operation

Pair Bluetooth-enabled Devices

The first time you connect your Bluetooth device to this player, you need to pair your device to this player.

Note:

- The operational range between this player and a Bluetooth device is approximately 8 meters (without any object between the Bluetooth device and the unit).
 - Before you connect a Bluetooth device to this unit, ensure you know the device's capabilities.
 - Compatibility with all Bluetooth devices is not guaranteed.
 - Any obstacle between this unit and a Bluetooth device can reduce the operational range.
 - If the signal strength is weak, your Bluetooth receiver may disconnect, but it will re-enter pairing mode automatically.
- 1 Press the "**BT**" button on the remote control or " " button on the unit to select Bluetooth mode.
 - 2 The word "bt" will be shown on the display screen and blink, the system has entered pairing mode.
 - 3 Activate your Bluetooth device and select the search mode. "**HS212**" will appear on your Bluetooth device list.
 - 4 Select "**HS212**" in the pairing list. the system is successfully connected and the "bt" will light up solidly.
 - 5 Begin playing music from the connected Bluetooth device.



To disconnect the Bluetooth function, you can :

- Switch to another function on the unit.
- Disable the Bluetooth function on your device.
- Press and hold the " **II/PAIR**" button on the remote control.

Tips:

- Enter "0000" for the password if necessary.
- If no other Bluetooth device pairs with this player in 2 minutes, the player will reconnect to the previous connection.
- The player will also be disconnected when your device is moved beyond the operational range.
- If you want to reconnect your device to this player, place it within the operational range.
- If the device is moved beyond the operational range, when it is brought back, please check if the device is still connected to the player.
- If the connection is lost, follow the instructions above to pair your device to the player again.

Listen to Music from Bluetooth Device

- If the connected Bluetooth device supports Advanced Audio Distribution Profile (A2DP), you can listen to the music stored on the device through the soundbar'.
- If the device also supports Audio Video Remote Control Profile (AVRCP), you can use the soundbar's remote control to play music stored on the device.
 1. Pair your device with the player.
 2. Play music via your device (if it supports A2DP).
 3. Use supplied remote control to control play (if it supports AVRCP).
 - To pause/resume play, press the  **II/PAIR** button on the remote control.
 - To skip to a track, press the   buttons on the remote control.

EN

USB Operation

EN

- 1 Insert the USB device.
- 2 Press the  button on the unit or the **USB** button on the remote control to select **USB** mode.
- 3 Play starts automatically. If play does not start automatically, press **▶||/PAIR** button.
 - To skip to the previous/next track, press the **◀◀/▶▶** buttons on the remote control.

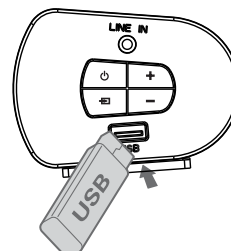

Troubleshooting

To keep the warranty valid, never try to repair the system yourself. If you encounter problems when using this unit, review the following before requesting service.

No power

- Ensure that the AC cord is properly connected.
- Ensure that there is power at the AC outlet.
- Press standby button on the remote control or soundbar to turn the soundbar on.

No sound

- Increase the volume. Press Volume Up on the remote control or on the right side of the soundbar.
- Press MUTE on the remote control to ensure the soundbar is not muted.
- Press source buttons to select a different input source.
- When using either of the Digital input, if there is no audio:
 - Try setting the TV output to PCM or
 - Connect directly to your Blu-ray/other source, some TVs do not pass through digital audio.
- Your TV may be set to variable audio output. Confirm that the audio output setting is set to FIXED or STANDARD, not VARIABLE. Consult your TV's user manual for more detailed information.
- If using Bluetooth, ensure that the volume on your source device is turned up and that the device is not muted.

Remote control does not work

- Before you press any playback control button, first select the correct source.
- Reduce the distance between the remote control and the unit.
- Insert the battery with its polarities (+/-) aligned as indicated.
- Replace the battery.
- Aim the remote control directly at the sensor on the front of the unit.

I hear buzzing or humming

- Ensure all cables and wires are securely connected.
- Connect a different source device (TV, Blu-ray player, etc) to see if the buzzing persists. If it does not, the problem may be with the original device.
- Connect your device to a different input on the soundbar.

I can't find the Bluetooth name of this unit on my Bluetooth device

- Ensure the Bluetooth function is activated on your Bluetooth device.
- Re-pair the unit with your Bluetooth device.

Specifications

Model name	HS212
General	
Bar Power Supply	AC 100-240V~50/60Hz
USB	5V/0.5A
Main Unit Dimension(WxHxD)	960x55x80mm (37.7x2.1x3.1 inch)
Soundbar Net weight	1.9Kg (4.18lbs)
Audio Input sensitivity	500mV
Frequency Response	40Hz-20KHz
Amplifier(RMS Output power)	
Total	120W
Main Unit	30 W + 30 W (6Ωx2 at 1 KHz,10%THD)
Subwoofer	60 W (4Ω at 80 Hz,10%THD)
Wireless Subwoofer	
Size	6.5 inch woofer *1
Dimension(WxHxD)	210x325x248mm(8.3x12.8x9.7 inch)
Net weight	4.8Kg(10.58lbs)
Remote Control	
Distance/Angle	19.7feet(6m) /30°
Battery Type	CR2025

EN

- Design and specifications are subject to change without notice.

Hisense

HS212

Model: 2.1 ch Soundbar With Wireless Subwoofer

Hisense

Barre de son de chaîne 2.1.avec caisson de basses sans fil

Modèle : HS212



MANUEL DE L'UTILISATEUR



Lisez toutes les consignes de sécurité avant utilisation et conservez ce manuel d'utilisation pour le consulter ultérieurement.



Table des matières

Consignes de sécurité	2
Contenu de l'emballage	4
Diagramme du produit	5
Unité principale	5
Télécommande	6
Instructions	6
Préparer la télécommande	6
Remplacer la pile de la télécommande	6
Placement et montage	7
Support mural	7
Connexions	8
Prise HDMI	8
Prise Optique	8
Prise RCA (AUX)	9
Utiliser la prise LINE IN	9
Branchement électrique	9
Connexion du caisson de basses (subwoofer)	9
Réglages de base	10
Veille / ALLUMÉ	10
Sélection des modes	10
Régler le volume	10
Sélectionner un effet sonore prédéfini	10
Fonctionnement AUX / LINE IN / OPTICAL / HDMI ARC	10
Fonctionnement avec source Bluetooth	11
Associer des appareils compatibles Bluetooth	11
Écouter de la musique à partir d'un périphérique Bluetooth	11
Fonctionnement USB	12
Dépannage	12
Caractéristiques	13

FR

Consignes de sécurité

FR

	ATTENTION RISQUE D'ELECTROCUTION NE PAS OUVRIR	
ATTENTION : POUR RÉDUIRE LE RISQUE D'ÉLECTROCUTION, NE PAS ENLEVER LE COUVERCLE (OU FACE ARRIÈRE) IL N'Y A AUCUNE PIÈCE RÉPARABLE PAR L'UTILISATEUR À L'INTÉRIEUR. CONFIEZ LA RÉPARATION À UN TECHNICIEN QUALIFIÉ.		



Le symbole éclair avec une flèche dans un triangle équilatéral est destiné à alerter l'utilisateur de la présence d'une tension dangereuse non isolée dans le capot du produit qui peut être d'une ampleur suffisante pour constituer un risque de décharge électrique pour les personnes.



Le point d'exclamation dans un triangle équilatéral est destiné à alerter l'utilisateur de la présence d'instructions importantes d'utilisation et de maintenance dans la documentation accompagnant l'appareil.

Sécurité

- 1 Lisez ces instructions – toutes les consignes de sécurité et de fonctionnement doivent être lues avant d'utiliser ce produit.
- 2 Conservez ces instructions – les instructions de sécurité et de fonctionnement doivent être conservées pour référence ultérieure.
- 3 Respectez tous les avertissements - Tous les avertissements sur cet appareil et dans les instructions d'utilisation doivent être respectés.
- 4 Suivez toutes les instructions – Toutes les instructions et consignes d'utilisation doivent être suivies.
- 5 N'utilisez pas cet appareil près de l'eau. L'appareil ne doit jamais être utilisé près de l'eau ou de l'humidité, tel que dans un sous-sol humide ou près d'une piscine ou similaires.
- 6 Nettoyez l'appareil uniquement à l'aide d'un chiffon sec.
- 7 Ne bloquez pas les ouvertures de ventilation. Installez l'appareil en suivant les instructions du fabricant.
- 8 Ne placez pas l'appareil près d'une source de chaleur, tels que des radiateurs, des bouches d'air chaud, des gazinières ou tout autre appareil (y compris des amplificateurs) qui produisent de la chaleur.
- 9 Il existe un danger d'explosion en cas de remplacement incorrect de la pile. Remplacez la pile uniquement avec des modèles identiques ou équivalents.
- 10 N'éliminez pas la fonction de sécurité de la fiche polarisée ni de la prise de terre. Une prise polarisée possède deux lames avec une plus large que l'autre. Une prise avec terre possède deux

lames et une troisième broche pour la masse. La lame plus large et la troisième broche sont là pour votre sécurité. Si la prise fournie ne rentre pas dans votre prise murale, prenez contact avec un électricien pour le remplacement de la prise.

- 11 Protégez le cordon d'alimentation de tout piétinement et empêchez qu'il soit pincé, et plus particulièrement au niveau des prises de courant et de l'endroit où il est branché à l'appareil.
- 12 Utilisez uniquement des fixations/accessoires recommandés par le fabricant.
- 13 Utilisez uniquement un chariot, socle, trépied, support ou table spécifiés par le fabricant ou vendu avec l'appareil. Lorsqu'un chariot ou rack est utilisé, soyez prudent quand vous déplacez l'ensemble chariot/appareil de manière à éviter les blessures en cas de chute.
- 14 Débranchez l'appareil en cas d'orage ou lorsqu'il est inutilisé pendant de longues périodes.
- 15 Confiez toute réparation à un personnel qualifié. Une réparation est nécessaire lorsque l'appareil a été endommagé d'une manière ou d'une autre, tels que lorsque le cordon d'alimentation ou la fiche sont endommagés, du liquide a été renversé, des objets sont tombés à l'intérieur, l'appareil a été exposé à la pluie ou à l'humidité, qu'il ne fonctionne pas correctement ou qu'il est tombé.
- 16 Cette unité est un appareil électrique à double isolation de Classe II. Il a été conçu de telle sorte qu'il ne nécessite pas une connexion à la terre pour la sécurité électrique.
- 17 Pour réduire le risque d'incendie ou d'électrocution, n'exposez pas cet appareil à la pluie ou à l'humidité. L'appareil ne doit pas être exposé aux éclaboussures et aucun objet rempli de liquides, comme des vases, ne doit être posé sur celui-ci.
- 18 La prise principale est utilisée comme dispositif de déconnexion et il doit toujours être possible de l'atteindre.

Avertissement

- La pile (piles ou un ensemble de piles) ne doit pas être exposée à une chaleur excessive, tel que le soleil, le feu ou similaire.
- Ces instructions de service sont uniquement à l'attention d'un technicien qualifié. Pour réduire le risque d'électrocution, n'effectuez aucune opération d'entretien autre que celles contenues dans les instructions de fonctionnement, à moins que vous soyez un technicien qualifié.
- Évitez les corps étrangers et les liquides à l'intérieur de l'appareil.
- Ne placez pas de bougies allumées et sans protection sur ou à côté de l'appareil.

Consignes de sécurité

- N'utilisez pas des produits de nettoyage corrosifs ou abrasifs. Ils pourraient endommager la surface de l'appareil.
- Veuillez-vous reporter aux consignes de sécurité et d'électricité en bas et derrière l'unité avant d'installer ou de faire fonctionner l'appareil.
- Une distance minimum de 5 cm autour de l'appareil doit être préservée pour assurer une ventilation adéquate ;
- La ventilation ne doit pas être empêchée en couvrant les ouvertures de ventilation avec des objets tels que journaux, nappes, rideaux, etc.
- Aucune source de flamme directe telles que des bougies allumées ne doit être placée à proximité de l'appareil ;
- Les piles doivent être recyclées ou éliminées conformément aux lignes directrices locales et du pays ;
- Utilisez l'appareil dans les climats tempérés.
- L'étiquette de marquage est collée en bas ou à l'arrière de l'appareil.

AVERTISSEMENT

NE PAS AVALER LA PILE, RISQUE DE BRÛLURES CHIMIQUES

Si vous pensez que les piles ont été avalées ou insérées à l'intérieur d'une partie du corps humain, consultez immédiatement avec un médecin. Gardez les piles neuves et usagées hors de la portée des enfants. Si le compartiment de la batterie ne se ferme pas correctement, cessez d'utiliser le produit et gardez-le hors de la portée des enfants. La télécommande fournie avec ce produit contient une pile de type bouton. Si la pile bouton est avalée, elle peut provoquer de graves brûlures internes en à peine deux heures et peut provoquer la mort.



Mise au rebut de ce produit. Ce pictogramme indique que ce produit ne doit pas être jeté avec les autres déchets ménagers dans toute l'Europe.

Afin de prévenir toute nuisance possible à l'environnement ou à la santé humaine causée par une élimination incontrôlée des déchets, recyclez ce produit de manière responsable pour promouvoir la réutilisation durable des ressources matérielles. Pour retourner votre appareil usagé, veuillez utiliser les systèmes de reprise et de collecte ou contactez le revendeur où vous avez acheté le produit. Le revendeur peut emmener ce produit pour son recyclage propre et sûr.



Les marques et logos Bluetooth® sont des marques déposées appartenant à Bluetooth SIG, Inc. Nous sommes autorisés à utiliser ces marques. Les autres

noms de marques et de produits déposés sont des marques commerciales de leurs propriétaires respectifs.



FR

Fabriqué sous licence de Dolby Laboratories. Dolby et le symbole à deux D sont des marques déposées de Dolby Laboratories.

INFORMATION FCC (pour les clients américains)

Avertissement :

Les changements ou modifications de cet appareil non expressément approuvées par la partie responsable de la conformité pourraient annuler l'autorisation de l'utilisateur à utiliser l'équipement.

REMARQUE :

- Ce dispositif a été testé et déclaré conforme aux limites d'un dispositif numérique de classe B, conformément à la partie 15 des règles de la FCC. Ces limites sont conçues pour fournir une protection raisonnable contre les interférences nuisibles dans une installation résidentielle. Cet appareil génère, utilise et peut émettre de l'énergie radiofréquence et, s'il n'est pas installé et utilisé conformément aux instructions, il peut causer des interférences nuisibles aux communications radio.
- Cependant, il n'est pas garanti que des interférences ne se produiront pas dans une installation particulière. Si cet appareil provoque des interférences nuisibles à la réception radio ou de télévision, ce qui peut être déterminé en mettant l'appareil hors tension, l'utilisateur est encouragé à essayer de corriger l'interférence par une ou plusieurs des mesures suivantes :
 - Réorienter ou déplacer l'antenne de réception.
 - Augmenter la distance entre l'appareil et le récepteur.
 - Brancher l'appareil à une prise sur un circuit différent de celui sur lequel le récepteur est branché.
 - Consulter le revendeur ou un technicien radio/TV expérimenté.
- Cet appareil est conforme à la partie 15 des règles de la FCC. Son fonctionnement est soumis aux deux conditions suivantes :
 - (1) ce dispositif ne peut pas causer d'interférences nuisibles et
 - (2) cet appareil doit accepter toute interférence reçue, y compris les interférences qui peuvent causer un mauvais fonctionnement.
- Des câbles blindés doivent être utilisés avec cet appareil pour assurer la conformité avec les limites de la classe B de la FCC.

Consignes de sécurité

IC warning

Le présent appareil est conforme aux CNR d'Industrie Canada applicables aux appareils radio exempts de licence. L'exploitation est autorisée aux deux conditions suivantes:

- (1) l'appareil ne doit pas produire de brouillage, et
- (2) l'utilisateur de l'appareil doit accepter tout brouillage radioélectrique subi, même si le brouillage est susceptible d'en compromettre le fonctionnement.

Déclaration d'exposition aux radiations FCC

Cet équipement est conforme aux limites d'exposition aux rayonnements de la FCC établies pour un environnement non contrôlé. Cet équipement doit être installé et utilisé avec une distance minimale de 20 cm entre le radiateur et votre corps.

Contenu de l'emballage

FR

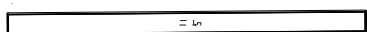

Unité principale



Télécommande

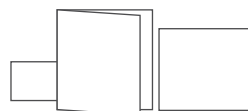

Manuel de l'utilisateur
Guide de configuration rapide
Gabarit en papier

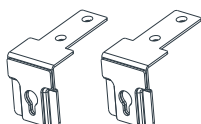

Supports (2×)

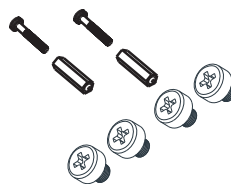

Chevilles murales (2×), vis (2×) et écrous du support (4×)

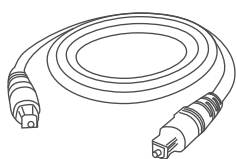

Câble optique

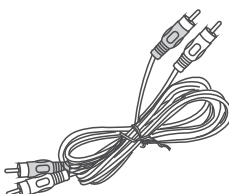

Câble audio RCA

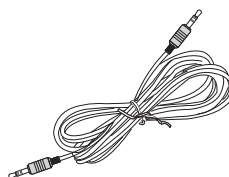

Câble audio 3,5 mm vers 3,5 mm