



OWNER'S MANUAL

Multimedia Speaker System

Please read this manual carefully before operating your set and retain it for future reference.

MODEL

LH62B, LH62G

LH64B, LH64G



www.lg.com

Safety Information



CAUTION: TO REDUCE THE RISK OF ELECTRIC SHOCK DO NOT REMOVE COVER (OR BACK) NO USER-SERVICEABLE PARTS INSIDE REFER SERVICING TO QUALIFIED SERVICE PERSONNEL.



This lightning flash with arrowhead symbol within an equilateral triangle is intended to alert the user to the presence of uninsulated dangerous voltage within the product's

enclosure that may be of sufficient magnitude to constitute a risk of electric shock to persons.



The exclamation point within an equilateral triangle is intended to alert the user to the presence of important operating and maintenance (servicing) instructions in the literature accompanying the product.

WARNING: TO PREVENT FIRE OR ELECTRIC SHOCK HAZARD, DO NOT EXPOSE THIS PRODUCT TO RAIN OR MOISTURE.

WARNING: Do not install this equipment in a confined space such as a book case or similar unit.

CAUTION: Do not use high voltage products around this product. (ex. Electrical swatter) This product may malfunction due to electrical shock.

CAUTION: The apparatus should not be exposed to water (dripping or splashing) and no objects filled with liquids, such as vases, shall be placed on the apparatus.

CAUTION: Do not block any ventilation openings. Install in accordance with the manufacturer's instructions.

Slots and openings in the cabinet are provided for ventilation and to ensure reliable operation of the product and to protect it from over heating. The openings shall be never be blocked by placing the product on a bed, sofa, rug or other similar surface. This product shall not be placed in a built-in installation such as a bookcase or rack unless proper ventilation is provided or the manufacturer's instruction has been adhered to.

CAUTION: No naked flame sources, such as lighted candles, should be placed on the device.

NOTICE: For safety marking information including product identification and supply ratings, please refer to the main label on the bottom or the other surface of the product.

CAUTION

Only use the AC adapter supplied with this device. Do not use a power supply from another device or another manufacturer. Using any other power cable or power supply may cause damage to the device and void your warranty.

CAUTION concerning the Power Cord

Most appliances recommend they be placed upon a dedicated circuit;

That is, a single outlet circuit which powers only that appliance and has no additional outlets or branch circuits. Check the specification page of this owner's manual to be certain. Do not overload wall outlets. Overloaded wall outlets, loose or damaged wall outlets, extension cords, frayed power cords, or damaged or cracked wire insulation are dangerous. Any of these conditions could result in electric shock or fire. Periodically examine the cord of your appliance, and if its appearance indicates damage or deterioration, unplug it, discontinue use of the appliance, and have the cord replaced with an exact replacement part by an authorized service center. Protect the power cord from physical or mechanical abuse, such as being twisted, kinked, pinched, closed in a door, or walked upon. Pay particular attention to plugs, wall outlets, and the point where the cord exits the appliance. The Power Plug is the disconnecting device. In case of an emergency, the Power Plug must remain readily accessible.

This device is equipped with a portable battery or accumulator.

Safety way to remove the battery from the

equipment: Remove the old battery or battery pack, follow the steps in reverse order than the assembly. To prevent contamination of the environment and bring on possible threat to human and animal health, the old battery or the battery put it in the appropriate container at designated collection points. Do not dispose of batteries or battery together with other waste. It is recommended that you use local, free reimbursement systems batteries and accumulators. The battery should not be exposed to excessive heat such as sunshine, fire or the like.

FCC Compliance Statement

This equipment has been tested and found to comply with the limits for a Class B digital device, pursuant to Part 15 of the FCC Rules. These limits are designed to provide reasonable protection against harmful interference in a residential installation. This equipment generates, uses, and can radiate radio frequency energy and, if not installed and used in accordance with the instructions, may cause harmful interference to radio communications. However, there is no guarantee that interference will not occur in a particular installation. If this equipment does cause harmful interference to radio or television reception, which can be determined by turning the equipment off and on, the user is encouraged to try to correct the interference by one or more of the following measures:

- Reorient or relocate the receiving antenna.
- Increase the separation between the equipment and the receiver.
- Connect the equipment to an outlet on a circuit different from that to which the receiver is connected.
- Consult the dealer or an experienced radio/TV technician for help.

This device complies with part 15 of the FCC Rules. Operation is subject to the following two conditions: (1) this device may not cause harmful interference and (2) this device must accept any interference received, including interference that may cause undesired operation of the device. Any changes or modifications in construction of this device which are not expressly approved by the party responsible for compliance could void the user's authority to operate the equipment.

FCC RF Radiation Exposure Statement : This equipment complies with FCC radiation exposure limits set forth for an uncontrolled environment. This transmitter must not be co-located or operating in conjunction with any other antenna or transmitter.

This equipment should be installed and operated with minimum distance 20 cm (7.8 inches) between the antenna and your body. Users must follow the specific operating instructions for satisfying RF exposure compliance.

Responsible Party :

LG Electronics USA, Inc.
1000 Sylvan Ave
Englewood Cliffs, NJ 07632
Tel: 1-800-243-0000

Table of Contents

1 Getting Started

- 3 Safety Information
- 6 Unpacking
- 6 Front of the unit
- 7 Back of the unit
- 8 Remote control

2 Connection

- 9 Speaker Connection
- 9 AUX IN Connection
- 10 PORT. IN Connection

3 Operation

- 11 Radio Operation
 - 11 – Listening to the radio
 - 11 – Presetting Radio Station
- 12 Sound Adjustment
 - 12 – Setting the surround mode

4 Using External device

- 13 USB MP3 Playback
 - 14 – Selecting a folder
- 15 BLUETOOTH® Connection

5 Troubleshooting

- 16 Troubleshooting

6 Appendix

- 17 Specification

1

2

3

4

5

6

Unpacking

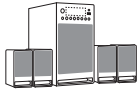

Unit and Speakers
(LH62B, LH62G: 2EA)

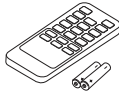

Remote Control
and Batteries



Audio Cable

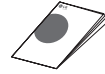

Owner's Manual

Front of the unit

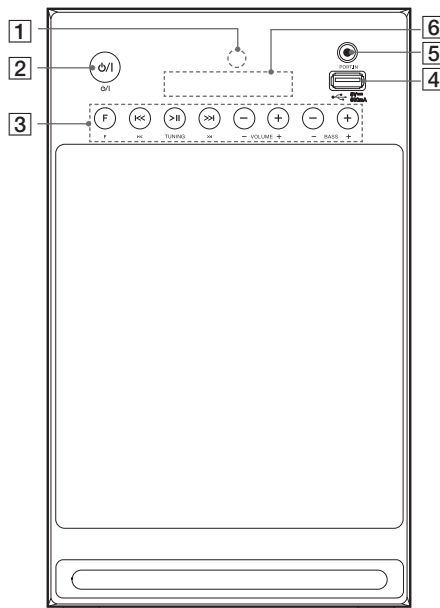

1 Remote sensor

2 ϕ /I (Standby/On)

3 F (Function) : Selects the function and input source. (USB / AUX / PORT IN / BT / FM)

|<< TUNING >>|

- Skips backward or Forward.
- Searches for a section within a file.
- Scans the radio station.

>|| : Starts playback or pauses playback.

VOLUME(-/+) : Adjusts speaker volume.

BASS (-/+) : Adjusts bass volume.

4 USB Port (5 V \equiv 500 mA)

5 PORT. IN : Portable input

6 Display window

Back of the unit

LH64B, LH64G

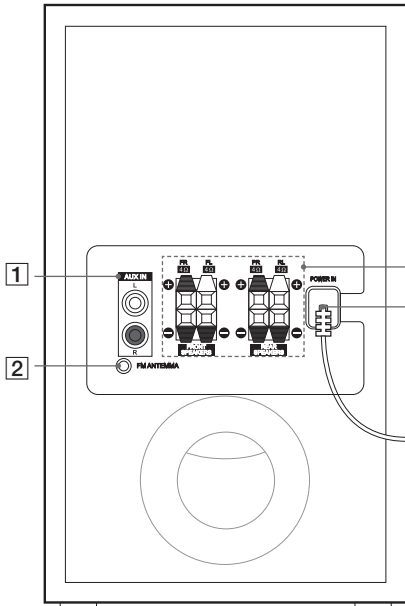

LH62B, LH62G

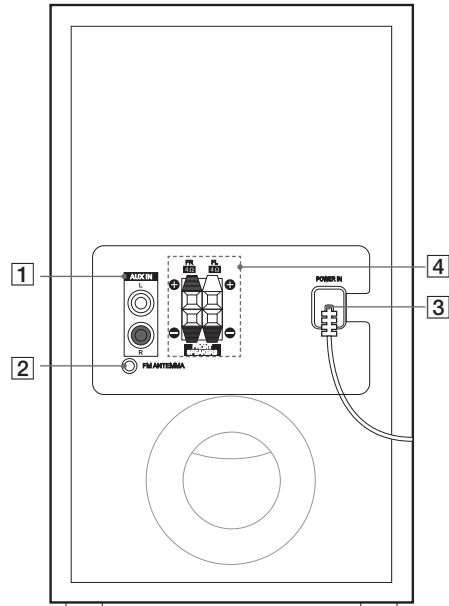

- 1 AUX IN connector (L/R)
- 2 FM ANTENNA
- 3 POWER IN cable
- 4 LH64B, LH64G: FRONT / REAR SPEAKERS Terminal
LH62B, LH62G: FRONT SPEAKERS Terminal

Remote control

1 Getting Started

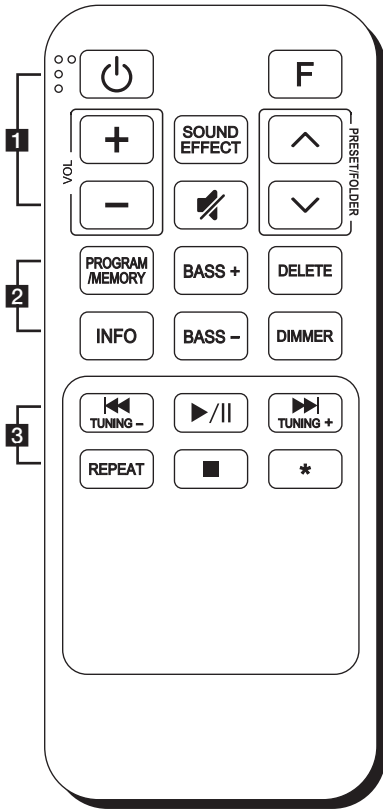

Replacement of battery

Remove the battery cover on the rear of the remote control, and insert the battery with **+** and **-** matched correctly.

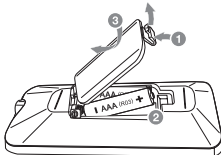

..... **1**

⏻ (Power) : Switches the unit ON or OFF (standby mode).

F (Function) : Selects the function and the input source. (USB / AUX / POR.IN / BT / FM)

+/- (VOL) : Adjusts speaker volume.

SOUND EFFECT : Selects a sound effect mode.

🔇 (Mute) : Mutes the sound.

PRESET/FOLDER \wedge / \vee :

- Searches for a folder of MP3 files.
- Chooses a preset number for a radio station.

..... **2**

PROGRAM/MEMORY : Presets radio stations and stores.

INFO : Shows information about your music.

- Press **INFO** on the remote control during mp3 playback, ID3 Tag's name is scrolled.

BASS (+/-) : Adjusts bass volume.

DELETE : Deletes saved radio stations.

DIMMER : Press **DIMMER** on the remote control. The display window will be darkened by half. (Up to twice)

- To cancel it, press **DIMMER** on the remote control repeatedly until dim off.

..... **3**

⏮(TUNING -) / ⏭(TUNING +)

- Skips backward or Forward.
- Searches for a section within a file.
- Scans the radio stations.

▶ / ⏸ : (Play/Pause)

- Starts or pauses playback.
- Selects STEREO/MONO. (FM function only)

REPEAT : Plays to your files repeatedly or randomly.

■ : Stops playback.

***** : The button is not available for any function.

Speaker Connection

Connect the wires to the unit.

LH64B, LH64G

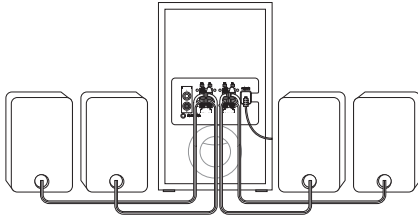

LH62B, LH62G

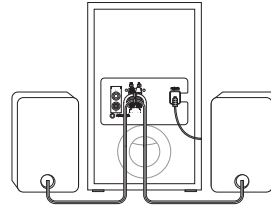

1. Press each plastic finger pad to open speaker terminals.
2. Insert the wire and release the finger pad.
3. Connect the black stripe of each wire to the terminal marked - (minus) and the other end to the terminal (red tube) marked + (plus).

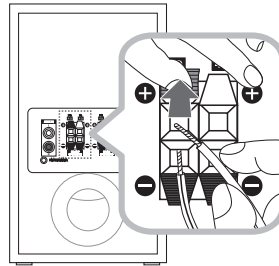

AUX IN Connection

Connect an output of auxiliary device (Camcorder, TV, Player, etc) to the AUX IN (L/R) connector.

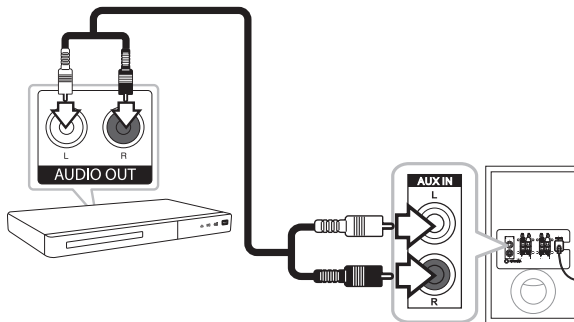

PORT. IN Connection

2

Connection

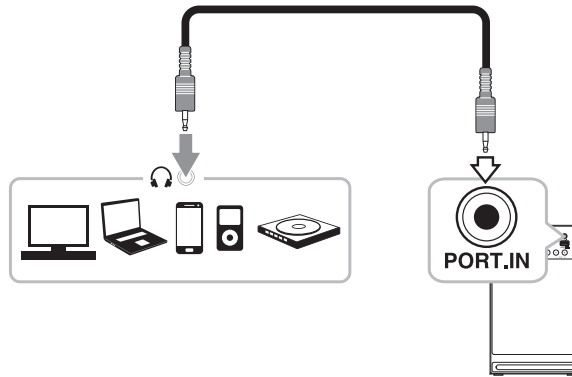

Listening to music from your portable player or external device

The unit can be used to play the music from many types of portable player or external device.

1. Connect the portable player to the PORT.IN connector of the unit.

Or

Connect the external device to the AUX IN connector of the unit.

2. Turn the power on by pressing  on the remote control.
3. Select POR.IN function by using **F** on the remote control or **F** on the unit until the function is selected.
4. Turn on the portable player or external device and start playing it.

Note

- To prevent hearing damage when turning on the unit, always turn down the VOLUME and BASS before turning off the unit.
- If you do not intend to use the speakers for a long time, turn off the power.

Radio Operation

Listening to the radio

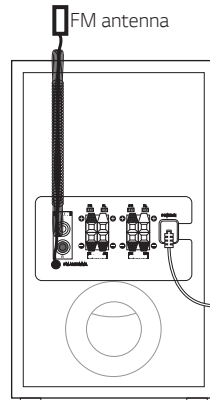

1. Press **F** on the remote control or **F** on the unit until FM appears on the display window. The last received station is tuned in.
2. **Auto tuning:** Press **TUNING -/+ (I<<</>>>I)** on the remote control or **TUNING (I<<</>>>I)** on the unit for about 1 second until the frequency indication starts changing, then release. scanning stops when the unit tunes in a station.

Manual tuning: Press **TUNING -/+ (I<<</>>>I)** on the remote control or **TUNING (I<<</>>>I)** on the unit repeatedly.

3. Adjust the volume by using **VOL +/-** on the remote control or the unit.

Note

- Before tuning, make sure to turn down the volume.
- Press **▶/||** on the remote control. This will change the tuner from mono to stereo. Then the FM reception will be better than before.

Presetting Radio Station

1. Press **F** on the remote control or **F** on the unit until FM appears on the display window.
2. Select the desired frequency by pressing **TUNING -/+ (I<<</>>>I)** on the remote control or **TUNING (I<<</>>>I)** on the unit.
3. Press **PROGRAM/MEMORY**. After a preset number will blink in the display window, press **PROGRAM/MEMORY** again. The station is saved.
4. Repeat steps 2 to 3 to store other stations. You can preset up to 50 stations for FM.
5. To listen a preset station, press **PRESET/FOLDER ^ / V**

Sound Adjustment

Setting the surround mode

This system has a number of pre-set surround sound fields. The displayed items for the Equalizer may be different depending on sound sources and effects.

You can select a desired sound mode by using **SOUND EFFECT** on the remote control.

On Display	Description
BASS	Reinforces the treble, bass and surround sound effect.
POP	
CLASSIC	This program lends an enthusiastic atmosphere to the sound, giving you the feeling you are at an actual rock, pop, jazz or classic concert.
ROCK	
JAZZ	
STANDARD	You can enjoy optimized sound.

Note

On some speakers, sound may not be heard or heard in low sound depending on the sound mode.

USB MP3 Playback

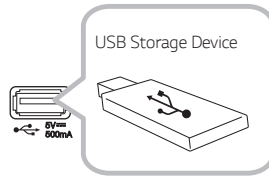

1. Insert the USB storage device to the USB port on the unit.
2. Select the USB function by pressing **F** on the unit or **F** on the remote control. When you select USB function, the USB storage device will be played automatically.
3. Select a file you want to play by pressing **⏪ / ⏩** on the unit or **⏪ / ⏩** on the remote control.

ⓘ MP3 Playback Requirement

- Bitrate : 32 kbps - 448 kbps
- Sampling Frequency : 8 KHz - 48 KHz

Removing the USB Device from the unit :

1. Choose a different function or press **■** on the remote control.
2. Remove the USB device from the unit.

To	Do this
Stop	Press ■ on the remote control.
Playback	Press > on the unit or ▶/ on the remote control.
Skipping to the next/previous file	Press ⏪ / ⏩ on the unit or ⏪ / ⏩ on the remote control to skip the file in stop state. During playback, press >> on the unit or ▶▶ on the remote control to go to the next file. Playing less than 3 seconds, press ⏪ on the unit or ⏪ on the remote control to go to the previous file. Playing after 3 seconds, press ⏪ on the unit or ⏪ on the remote control to go to the beginning of the file.
Pause	During playback, press > on the unit or ▶/ on the remote control.
Playing repeatedly or randomly	Press REPEAT on the remote control repeatedly, the display changes in the following order: 1 ↻ → ALL ↻ → RAN ↻ → OFF

ⓘ Note

- If you use an USB extension cable or USB hub, the USB device is not recognized.
- Some USB device may not work with this unit.
- During random playback, a same file that was being played may be played again.

Selecting a folder

When a USB containing MP3 files in several folders is being played,

1. Press **PRESET/FOLDER** \wedge/V on the remote control repeatedly. Index of the first played file in the folder is displayed.
2. Press **>||** on the unit or **▶/||** on the remote control to play it. The first file of the folder will play.

Note

- USB Folders/Files are recognized as below.

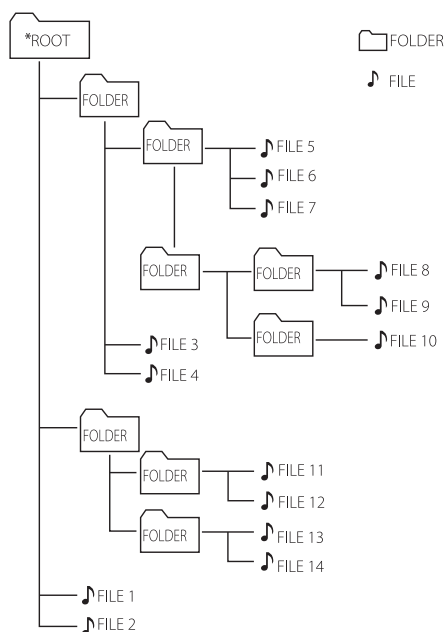

- The Index number of folder will be presented in order recorded and may be presented differently according to the recording circumstances.
- ROOT : The first screen you can see when a computer recognizes the USB is "ROOT".

Deleting a saved Preset station

1. Select a desired preset by pressing **PRESET/FOLDER** \wedge/V and press **DELETE** on the remote control.
2. The selected preset number will be blinked.
3. Press **DELETE** on the remote control to erase the saved preset number.

Note

Press and hold **DELETE** to erase all saved radio stations.

BLUETOOTH® Connection

Bluetooth is wireless communication technology for short range connection.



Before you start the pairing procedure, make sure that the **Bluetooth** feature is turned on in your **Bluetooth** device.

1. Press **⏻/I** on the unit or **⏻** on the remote control to turn on the unit.
2. Press **F** on the remote control or **F** on the unit until "BT" appears on the display window.
3. "READY" appears to find a **Bluetooth** device on the display window.
4. Select "LG LH64B, LH64G or LG LH62B, LH62G" on your **Bluetooth** device for pairing.
5. When this unit successfully paired with your **Bluetooth** device, "PAIR" appears on the display window.
6. Play music on your **Bluetooth** device.

📌 Note

- This unit supports **Bluetooth** auto pairing. However it does not operate in the case below:
 - When you restart this unit.
 - When you disconnect this unit by yourself.
 - When you disconnect this unit on the connected **Bluetooth** device.
- The sound may be interrupted when the connection is interfered with by the some other electronic wave.
- Pairing is limited to "One" **Bluetooth** device. Multi-Pairing is not supported.
- Depending on the type of the device, you may not be able to use the **Bluetooth** function.
- You can enjoy using **Bluetooth** when using Phone, MP3, Notebook, etc..
- The more distance between the unit and the **Bluetooth** device, the lower the sound quality becomes.
- The **Bluetooth** connection will be disconnected when the unit is turned off or the **Bluetooth** device gets too far from the unit.
- If the **Bluetooth** connection is disconnected, connect the **Bluetooth** device again.
- When a **Bluetooth** device is not connected, "READY" appears on the display window.

Troubleshooting

No Power

- The power cord is not plugged in. Plug in the power cord.
- Check whether electricity failed. Check the condition by operating other electronic devices.

No sound and sound distortion

- The unit or your external device's volume is set to minimum. Check and adjust the volume of the unit.
- When you use external device at high volume, the sound quality may be deteriorated. Lower the volume of device.
- If you use the unit for purposes other than listening to music, the sound quality may be lowered or the unit may not work properly.

The USB device does not start playback

- An unplayable USB device is inserted. Check the USB device.
- Check whether you selected right function. Pressing **F** button and check the selected function.

Radio stations cannot be tuned in properly.

- The antenna is positioned poorly. Adjust its position.
- The signal strength of the radio station is too weak. Tune to the station manually.
- No stations have been preset or preset stations have been cleared (when being tuned by scanning preset channels). Refer to Presetting Radio Station.

The remote control does not work properly.

- The remote control is not pointed at the remote sensor of the unit. Point the remote control at the remote sensor of the unit.
- The remote control is too far from the unit. Operate the remote control within about 7 m.
- There is an obstacle in the path of the remote control and the unit. Remove the obstacle.
- The battery in the remote control is exhausted. Replace the battery with new one.

Bluetooth pairing does not work well.

- Switch **Bluetooth** off and on again on your **Bluetooth** device, then try pairing again.
- Be sure your **Bluetooth** device is on.
- Remove the obstacle in the path of the **Bluetooth** device and the unit.
- Depending on the type of the **Bluetooth** device or surrounding environment, your device may not be paired with the unit.
- When your **Bluetooth** device have been already connected with other unit, disconnect the **Bluetooth** connection first.

Cleaning the unit

- To clean the player, use a soft, dry cloth.
If the surfaces are extremely dirty, use a soft cloth lightly moistened with a mild detergent solution.
Do not use strong solvents such as alcohol, benzine, or thinner, as these might damage the surface of the unit.

Specification

		LH62B, LH62G	LH64B, LH64G
Product type		2.1 speaker system	4.1 speaker system
Power Supply		Refer to the main label.	
Power Consumption		30 W	38 W
Dimensions (W x H x D)	Unit	Approx. 160 mm x 260 mm x 258 mm	
	Speaker	Approx. 78 mm x 130 mm x 91 mm	
Net Weight	Unit	Approx. 2.82 kg	Approx. 2.82 kg
	Speaker	Approx. 0.6 kg	Approx. 1.2 kg
Operating Temperature		5 °C to 35 °C	
Connectivity		3.5mm stereo jack-male input jack	
Tuner		FM Tuning Range : 87.5 to 108.0 MHz or 87.50 to 108.00 MHz	
Impedance		<ul style="list-style-type: none"> • L/R : 4 (Ω) • SW : 8 (Ω) 	
Frequency response		20Hz ~ 20kHz \pm 3DB	
Total Max. power		36 W (THD : 10 %)	54 W (THD : 10 %)
Signal to noise ratio		\geq 70 dB	

- Design and specifications are subject to change without notice.

Auto power down

This unit will turn itself off to save electricity in the case were the main unit is not connected to an external device and is not used for 20 minutes.

The unit will also turn itself off after six hours if the Main unit has been connected to another device using the analog inputs.

How to disconnect the wireless network connection or the wireless device.

Turn off the unit.

