

# MAXHUB

# User Manual

Interactive Flat Panel

Model: C65CA/C75CA/C86CA

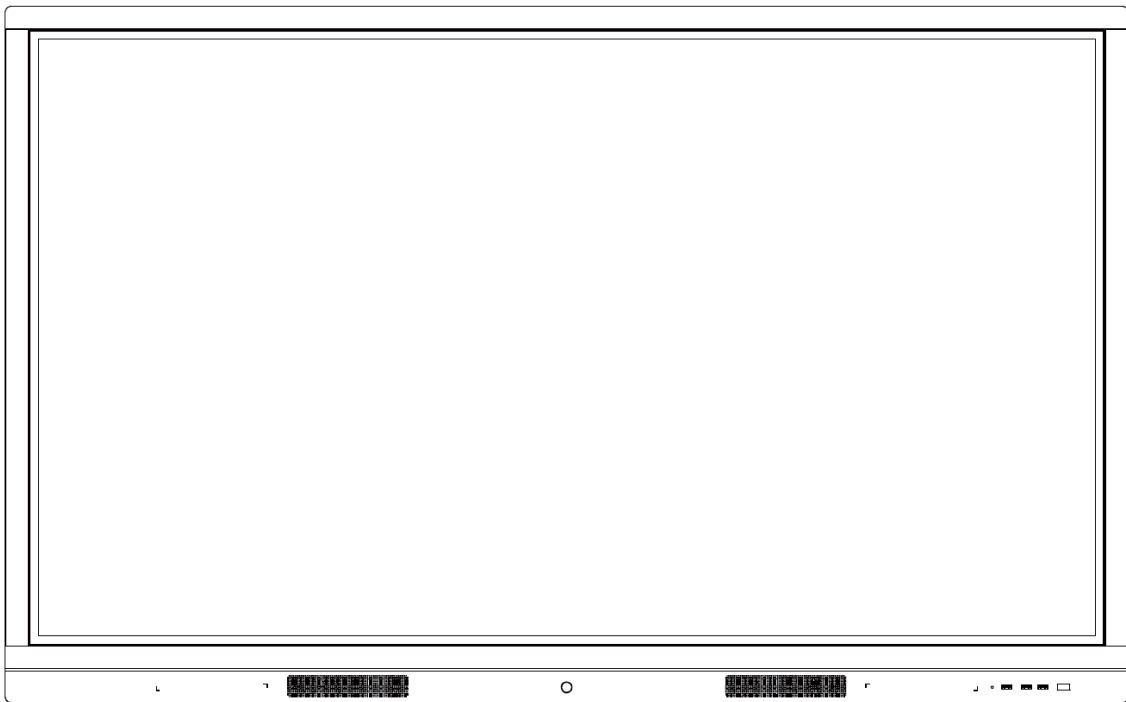

# Content

1.Safety Warning .....	01
2.Control Panel & Terminal .....	03
3.Connection & Setting .....	05
4.Menu Operation .....	09
5.FAQ .....	12
6.Simple Troubleshooting .....	13
7.Maintenance .....	14
8.Statement .....	15

## Placement

Do not place the unit on an unstable cart, stand, tripod, bracket, table, or shelf.

Do not expose the unit to direct sunlight and other sources of heat.

Do not put the unit near appliances that generate magnetic fields.

Do not put any liquid near or on the unit, make sure do not spill any liquid inside the unit.

Do not put heavy objects on top of the unit.

## Power Supply

Check that the unit's operating voltage is identical with your local power supply.

Please unplug power supply and antenna plug when the weather is thunder-storm or lightning.

Please unplug power supply, when there is nobody home or the unit will be in idle for a long time.

Please keep power cable from physical or mechanical damage.

Please use the original power cable from the accessory bag, don't modify or lengthen it.

Please check and ensure AC source is connected with the ground.

This power cable comes with the device exclusively for this device only.

## LED Screen

Never use any other hard or sharp object to replace the touch pen.

Unplug the power cable before cleaning.

Clean the screen with a soft, dustless and dry cloth.

Never use water or the spray type detergent to clean the unit.

For deep clean, please contact an authorized service center.

Better for the panel lifetime and the display performance, do not display high brightness image for long time.

## Temperature

Do not place the unit near or over a radiator or a heater.

If your unit is suddenly moved from a cold to a warm place, please unplug the power cable and do not turn it on at least 2 hours,

making sure the moisture inside the unit is all evaporated.

Normal operating temperature is 0 ~ 40°C.

## Humidity

Do not expose the unit in rain, or place in high humidity area.

Please make sure indoor environment is dry and cool. Normal operating humidity is 10~90%.

## Ventilation

Please put the unit in a well ventilated place, so the heating can be released easily.

Ensure that the unit has enough space for ventilation. Space requirement: left, right and back >10cm, top > 20cm.

## Earphone

Using the earphone to listen loud sound for a long time might effect the hearing.

Before using earphone, please turn down the volume in advance.

## **Standby**

It will enter standby mode but not turn off the unit after press the standby key.

## **Battery**

Please make sure the battery get proper disposal or recycle after using.

Please keep the battery away from kids and don't throw the battery into fire.

## **Notes for Cleaning**

There are vents on back cover, please do not use any liquid or spray directly during cleaning.

## **Power Switch Status Signs**



“I” means power on, “O” means power off.

## **Notes for Maintenance**

This machine can only be maintained by certified engineer.

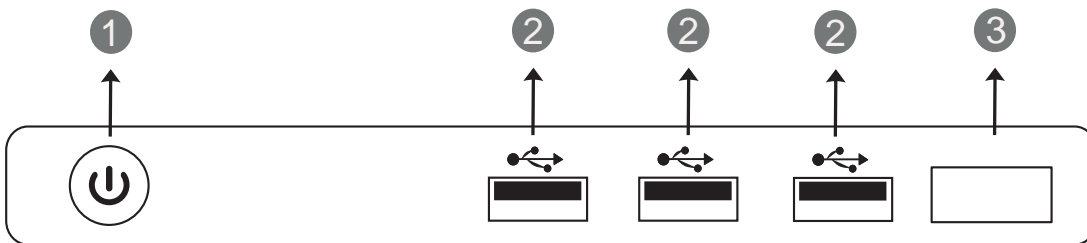
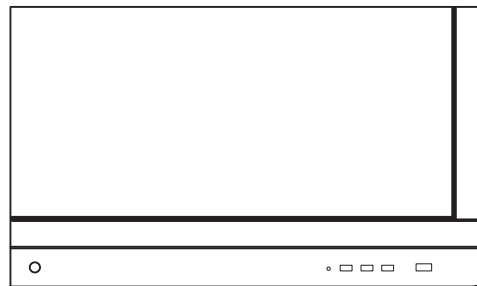
## 1. Control Panel



Key	Function
① 	Tap to enter EnergySaving function. Press at least 2 seconds to enter standby mode.
② 	USB Interface
③ Remote Control Signal Receiver	Receiving remote control signal

## 2.Terminal

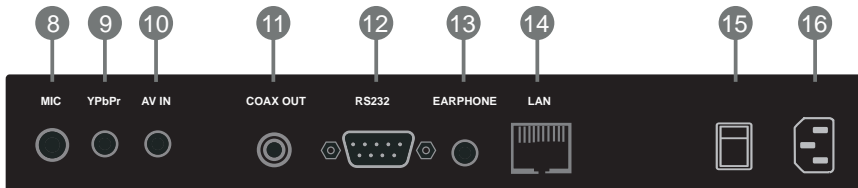
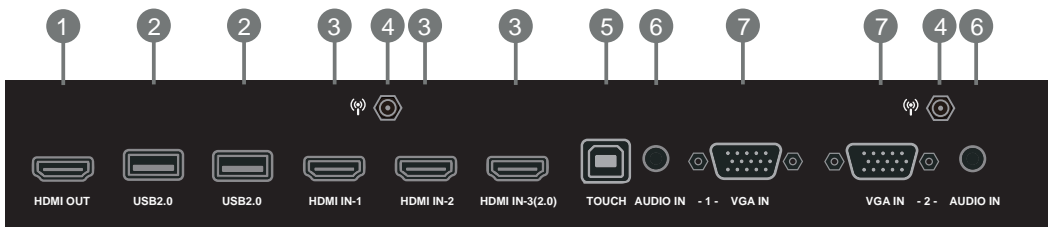

Terminal	Function
① HDMI OUT	High-definition multimedia interface signal output
② USB	Connect USB devices such as mobile hard disk, U disk, USB drives, USB keyboard and mouse, etc
③ HDMI IN	High-definition multimedia interface signal input
④ (📶)	Antenna
⑤ TOUCH	External computer touch signal input
⑥ AUDIO IN	External computer audio input
⑦ VGA IN	Connected to display devices with VGA input function
⑧ MIC	Microphone input
⑨ YPbPr	Component input
⑩ AV IN	Composite video and audio input
⑪ COAX OUT	Coaxial output
⑫ RS232	Serial interface, used for mutual transfer of data between devices
⑬ EARPHONE	Connected to device with headphone input function
⑭ LAN	LAN interface, connecting RJ45 terminals
⑮ Power Switch	To open and shut down AC power supply. "I" means power on, "O" means power off
⑯ AC IN	AC power input, connecting AC power supply

⚠ For the safety of you and the machine, please do not connect any power plug before connection.

1.External Computer and Touch Connection

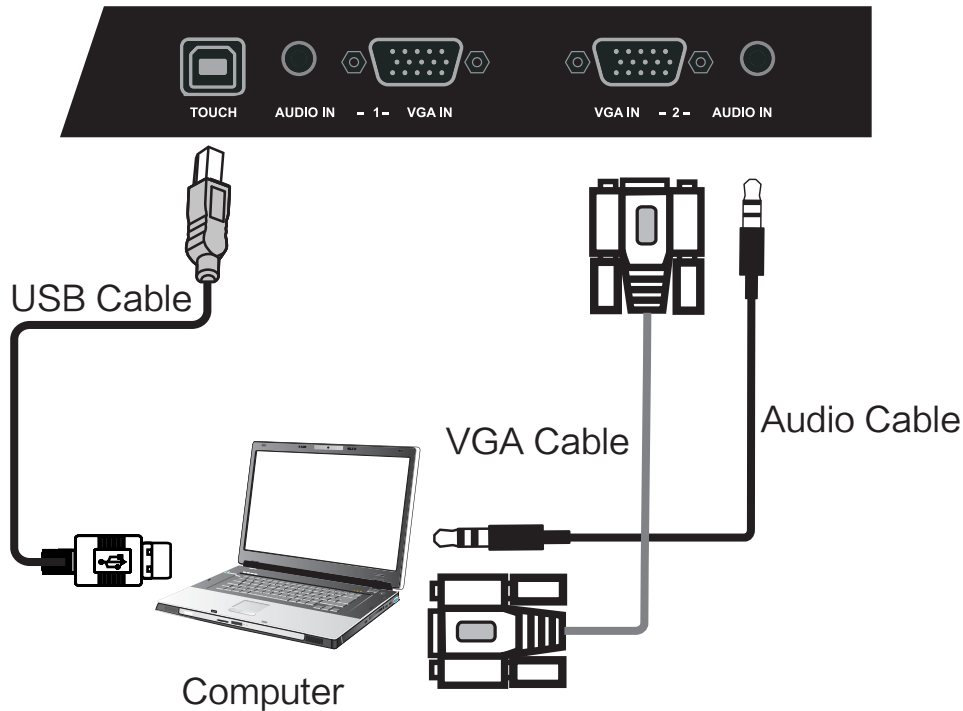

- (1) Use VGA cable to connect to VGA output port of external computer, and meanwhile use headphone audio cable to connect to external computer audio output interface
- (2) Use USB cable to connect to external computer USB port
- (3) After cable connection, plug in power cord, and switch power on
- (4) Start external computer
- (5) Press  to turn equipment on
- (6) Press INPUT key to switch to VGA channel

Recommended computer configuration:  
 2.0GHz above Processor, 2GB above Memory  
 More than 256 color display card  
 VGA-OUT/HDMI-OUT, Audio-OUT, USB Interface  
 Support Resolution 800\*600, 1024\*768, 1920\*1080

Note:

External computer input, equipment's best resolution is 1920\*1080.  
 External computer can also connect to the equipment through the HDMI cable.

## 2. Audio and Video Equipment

### 1) AV IN

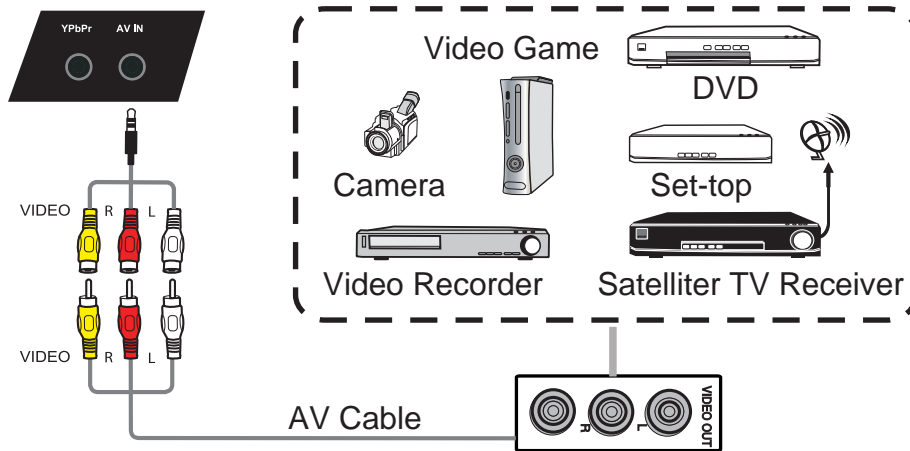

- (1) Use AV audio and video cables to connect audio and video equipments with AV output (yellow for video, red for right sound channel, and white for left sound channel)
- (2) After cable connection, plug in power cord, and switch power on
- (3) Press  to turn equipment on
- (4) Press INPUT key to switch to AV channel

### 2) HDMI IN

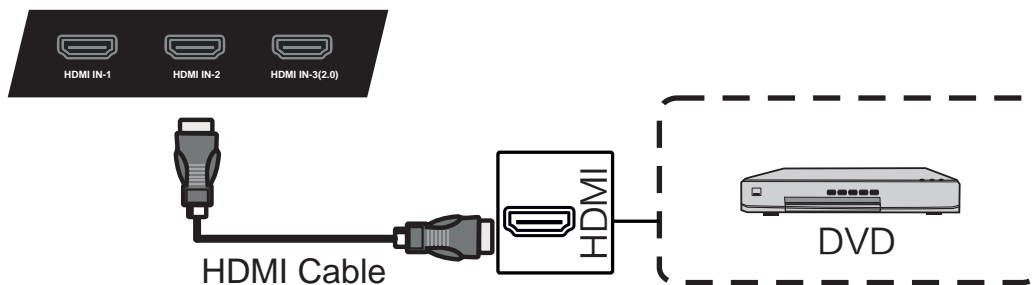

- (1) Use HDMI cable to connect audio and video equipments with HDMI output
- (2) After cable connection, plug in power cord, and switch power on
- (3) Press  to turn equipment on
- (4) Press INPUT key to switch to HDMI channel



## 3.Coaxial Connection

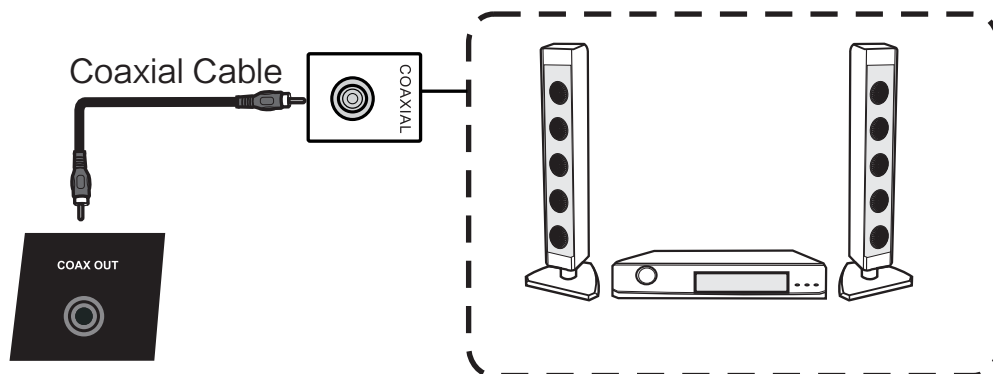

- (1) Use coaxial cable to connect audio equipments with coaxial input
- (2) After cable connection, plug in power cord, and switch power on
- (3) Press  to turn equipment on

## 4.USB Connection

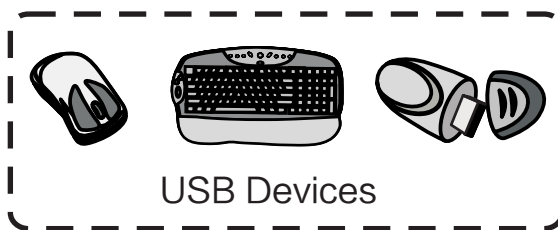

## 5.LAN Connection

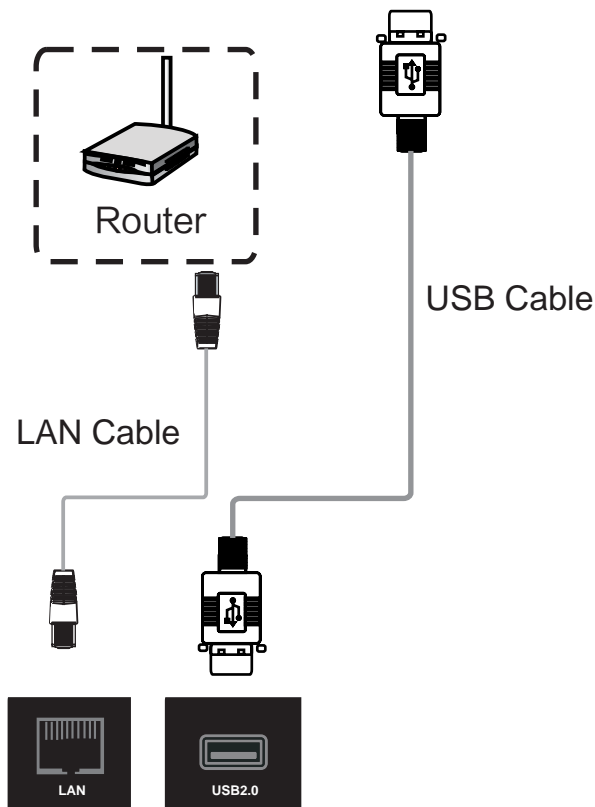

## 6.RS232 Connection

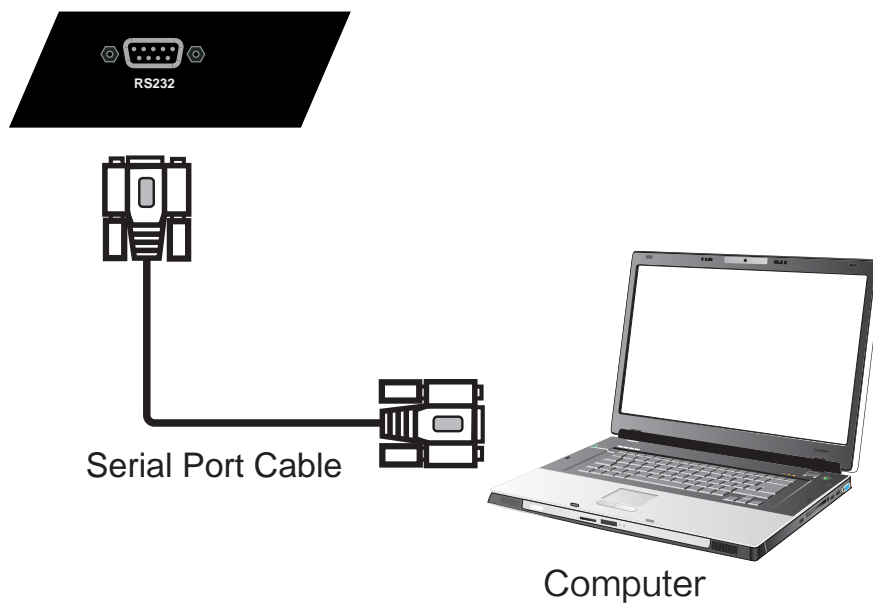

After using serial port cable to connect central control computer and equipment, certain function of the equipment can be controlled via central control computer, such as: turn on/off the equipment, and adjustment of sound volume, etc.

## Quick Setting

Use touchpen to drag from the left or right of the screen to the middle, can call up the following quik setting menu.

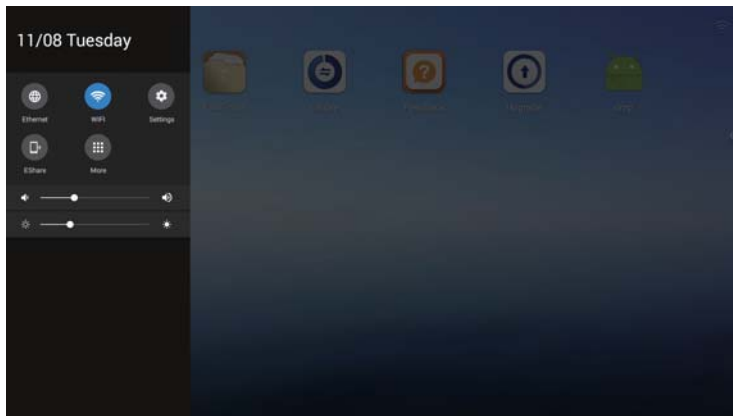

- In the quick setting, use touchpen can adjust brightness and voice.
- Klick “Settings” with touchpen to enter Android Setting Menu.

## Android Setting

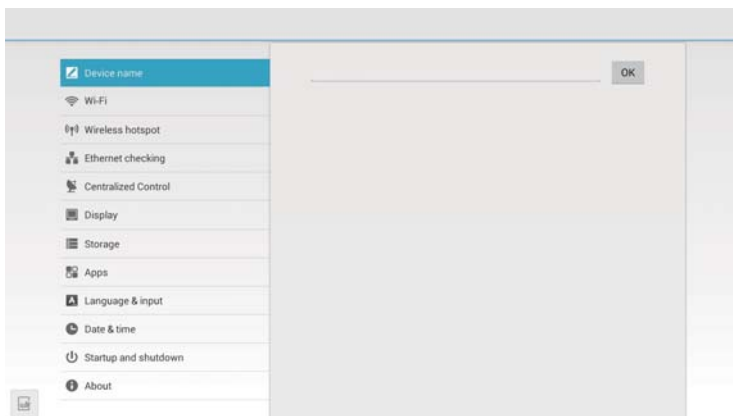

- In “Device name”, you can freely change the device name. The “Enter the name displayed in the meeting you create” in the remote meeting will be synchronously updated with the change of the device name.

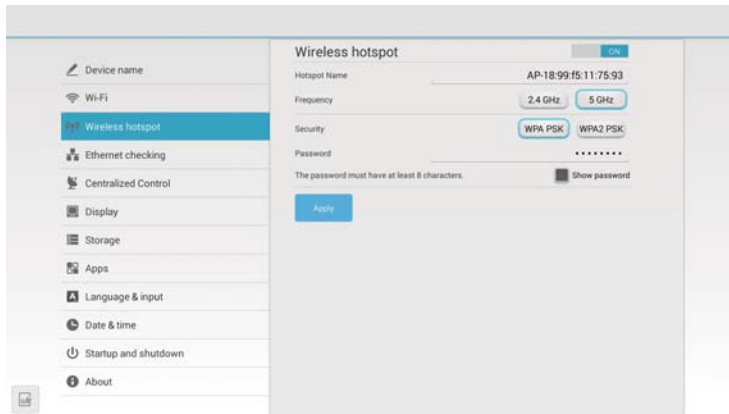

- In “Wireless hotspot”, you can turn on/off wireless hotspot, adjust the frequency band and security, and set the wireless hotspot password.

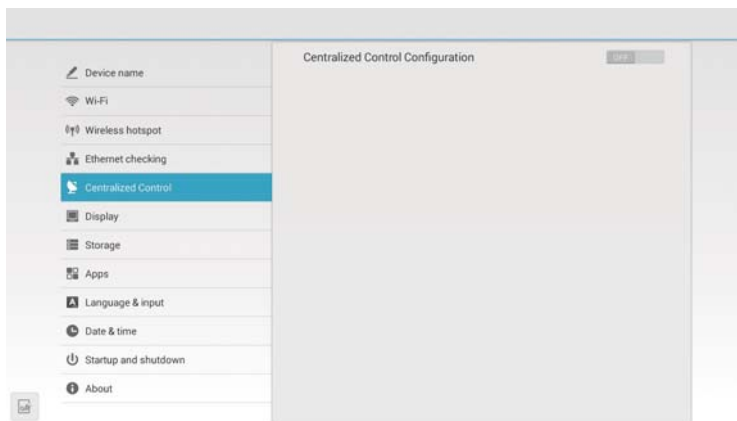

- In “Centralized Control”, you can open the configuration control address. After finish configuration, you can remotely check the IFP’s status and turn it on/off.

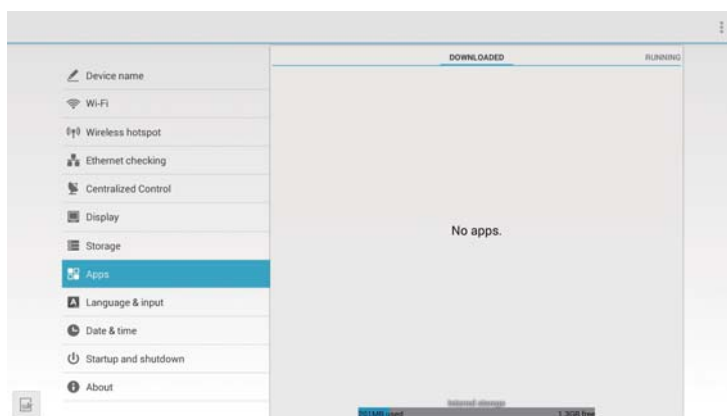

- In “Apps”, you can look over the downloaded applications, running programs, and all applications.

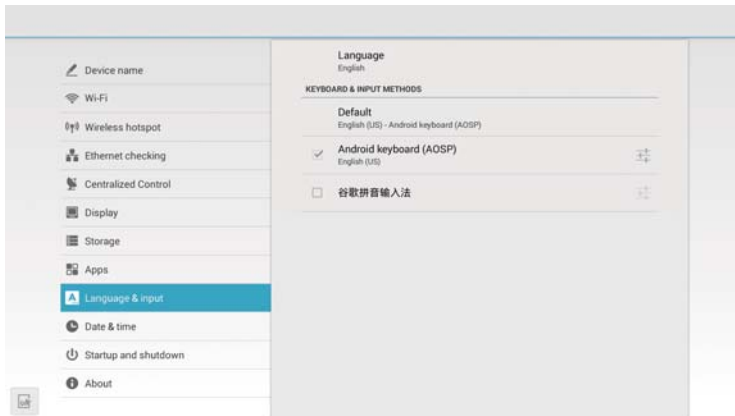

- In “Language & Input”, you can select the system language. Click the language, you can choose the Chinese/English language, and also can select the keyboard & input method.

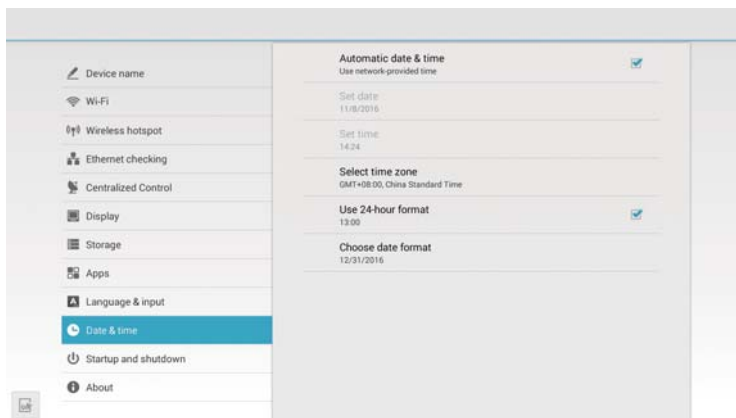

- In “Date & time”, turn on the "Automatic date & time", the system time will be automatically synchronized with the time zone you select in the time zone setting. This function is available only when the network is connected.
- Turn off the "Automatic date & time", you can click the “Set date” and “Set time” to manually set the date and time.

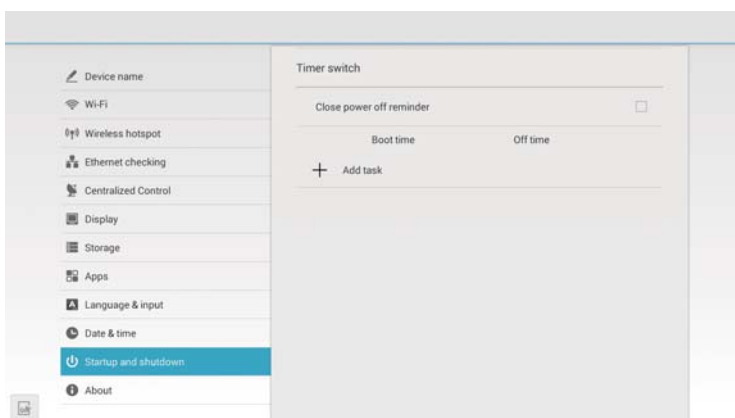

- In “Startup and shutdown”, you can turn on/off the power off reminder. Click “Add task” to set the time on/off.

1. Why does fog often appear on the screen?

To ensure the safety of the screen, a layer of tempered glass is added to the external of the screen. Moreover, to ensure heat radiation, there needs to be some gap between the two to reserve an air passage for ease of the convection of the air. The reason why fog appears is that there is a temperature difference between the screen temperature and the external temperature, and the hot air condenses and generates fog due to the glass surface with lower temperature. The fog does not affect the normal use, and it will evaporate and disappear after the machine is used for several hours.

2. Why are the boot times of the devices in different meeting rooms are different?

Generally, the external U disk or surfing online will let the device get virus. As a result, the disk space is fully occupied, or the system disk is damaged. Therefore, the boot of the device will get slower.

3. Why there is no sound for the external notebook computer?

In case of the VGA wire connection where only pictures are transmitted, you need to further connect the audio wire. Likewise, if only the audio wire is connected, the sound cannot be produced, and you need to connect the VGA wire to identify the VGA channel, or you can select the HDMI wire connection.

4. The attached touchpens are limited. Is there any object that can replace the touchpen for flexible writing and at the same time does not damage the screen?

Fingers can be temporarily used for writing. In addition, if necessary, you can buy more writing pens.

5. After used for some time, the screen is overheated. Is it normal? Will it bring any bad influence?

It is normal that the screen is overheated, which will not bring any bad influence. Currently, the heat radiation design of our machine is advantageous in the industry. We are the maker of the industry standard, which complies with the international health standard.

6. Will it be harmful for eyes in case of use for a long time?

The identification of human eyes to the twinkling is 50 Hz, and the human eyes can feel the twinkling if the frequency is below 50 Hz. The eye muscles need to continuously adjust to adapt to the twinkling, which results in the fatigue of eyes. The frequency of the LCD we use is 60 Hz and 120 Hz. Therefore, human eyes cannot feel the twinkling of our screen, which can reduce the fatigue of eyes to a large extent compared with other similar products.

## Abnormality of Booting

### I. Automatic power off

1. Is the sleep function enabled? Troubleshoot according to the general checking items of the computer.
2. Check whether there is a signal on the channel where the input source is in. If there is no signal, the meeting machine will automatically enable the energy saving mode to power off.
3. Check the stability of the power supply.

### II. The indicator is off.

1. Check whether the power supply is normal.
2. Check whether the rocker switch of the tablet computer is turned on.

### III. The indicator turns red, and booting is unavailable.

1. If pressing the button cannot turn on the IFP, unplug all the external wires, and turn on the IFP again after cutting off the power for 15 minutes.

## Abnormality of Computer Functions

### I. The IFP cannot display the content of the interface of the external computer.

1. Check whether the current channel is VGA channel.
2. Check whether the VGA wire of the tablet computer or external computer is loose or poor.

### II. The pictures lack colors, or the color is abnormal.

1. Check whether the VGA wire is well connected or whether it is the quality problem.

## Abnormality of Sound Function

### I. There are pictures but no sounds for the device.

1. Try adjusting the volume by using VOL +/-.
2. If the tablet computer is connected to the external computer, check whether the audio wire is correctly connected.
3. If the problem still persists, please contact professional after-sale maintenance personnel for your service.

## Abnormality Touch Function

### I. Inaccurate touch positioning.

1. Check whether the touchpen or the finger is 90 degrees vertical to the screen.
2. Check whether there are other objects touching the screen, for example, little tape or sleeve.

Proper maintenance can avoid some simple faults.

Regular careful cleaning can maintain a good appearance and running state.

Please unplug power plug before cleaning and maintenance, to prevent electric shock.

### Clean Screen

Please mix and stir even a little fabric softener or tableware detergent with warm water.

Please use a soft cloth to be completely soaked in the mixture.

Please take out cloth and twist to half dry state to wipe product's screen.

Repeat for several times, pay attention not to squeeze water flow into product when wiping it.



### Clean Face Frame

Please use dry, soft, lint-free cloth to wipe front frame.

### No Use of Machine for A Long Time

In case of no use of product for a long time, such as holiday, please make sure to unplug the plug to prevent any possible dangers caused by power supply ripple from lightning.



Copyright ownership of hardware and software design belongs to Guangzhou Shirui Electronics Co., Ltd., shall not be reproduced, copied, or used in other ways without permission. Otherwise Guangzhou Shirui Electronics Co., Ltd. will have the right to pursue legal responsibilities. The image shown in this manual is indicative only. If there is inconsistency between the image and the actual product, the actual product shall govern.

Hereby, Guangzhou Shirui Electronics Co., Ltd. declares that the radio equipment type C65CA/C75CA/C86CA is in compliance with Directive 2014/53/EU.

The full text of the EU declaration of conformity is available at the following internet address: [www.seewo.com](http://www.seewo.com).

### FCC Statement

This equipment has been tested and found to comply with the limits for a Class B digital device, pursuant to part 15 of the FCC Rules. These limits are designed to provide reasonable protection against harmful interference in a residential installation. This equipment generates, uses and can radiate radio frequency energy and, if not installed and used in accordance with the instructions, may cause harmful interference to radio communications. However, there is no guarantee that interference will not occur in a particular installation. If this equipment does cause harmful interference to radio or television reception, which can be determined by turning the equipment off and on, the user is encouraged to try to correct the interference by one or more of the following measures:

- Reorient or relocate the receiving antenna.
- Increase the separation between the equipment and receiver.
- Connect the equipment into an outlet on a circuit different from that to which the receiver is connected.
- Consult the dealer or an experienced radio/TV technician for help.

## FCC Radiation Exposure Statement

This device complies with FCC radiation exposure limits set forth for an uncontrolled environment and it also complies with Part 15 of the FCC RF Rules. This equipment must be installed and operated in accordance with provided instructions and the antenna(s) used for this transmitter must be installed to provide a separation distance of at least 20 cm from all persons and must not be co-located or operating in conjunction with any other antenna or transmitter. End-users and installers must be provide with antenna installation instructions and consider removing the no-collocation statement.

This device complies with Part 15 of the FCC Rules. Operation is subject to the following two conditions: (1) this device may not cause harmful interference, and (2) this device must accept any interference received, including interference that may cause undesired operation.

## Caution!

Any changes or modifications not expressly approved by the party responsible for compliance could void the user's authority to operate the equipment.