

**APPENDIX G:   MANUAL**

Please refer to the following pages.

# Operators Manual

MM101332V1 R3A



## P7100<sup>IP</sup> Series Portable Radios

**tyco**  
Electronics

**MACOM**

## TABLE OF CONTENTS

	<i>Page</i>
SAFETY TRAINING INFORMATION .....	3
OPERATING RULES AND REGULATIONS .....	7
OPERATING TIPS.....	9
BATTERY DISPOSAL .....	13
SCOPE OF THIS MANUAL .....	14
OPTIONS AND ACCESSORIES .....	15
USER INTERFACE .....	18
STATUS MESSAGES.....	25
BASIC OPERATION .....	28
TRANSMITTING A CALL IN TRUNKED MODE.....	34
RECEIVING A CALL IN TRUNKED MODE .....	35
CONVENTIONAL OPERATION .....	36
OPERATION FOLLOWING WATER CONTACT.....	37
CHANGING THE BATTERY PACK .....	43
BATTERY WARRANTY .....	45
WARRANTY .....	46

### NOTICE!

The software contained in this device is copyrighted by M/A-COM, Inc. Unpublished rights are reserved under the copyright laws of the United States.

This manual is published by **M/A-COM, Inc.**, without any warranty. Improvements and changes to this manual necessitated by typographical errors, inaccuracies of current information, or improvements to programs and/or equipment, may be made by **M/A-COM, Inc.**, at any time and without notice. Such changes will be incorporated into new editions of this manual. No part of this manual may be reproduced or transmitted in any form or by any means, electronic or mechanical, including photocopying and recording, for any purpose, without the express written permission of **M/A-COM, Inc.**

Copyright © 2003 M/A-COM, Inc. All rights reserved.

## SAFETY TRAINING INFORMATION



The M/A-COM P7100<sup>IP</sup> portable radio generates RF electromagnetic energy during transmit mode. This radio is designed for and classified as “Occupational Use Only,” meaning it must be used only during the course of employment by individuals aware of the hazards and the ways to minimize such hazards. This radio is NOT intended for use by the “General Population” in an uncontrolled environment.

The P7100<sup>IP</sup> portable radio has been tested and complies with the FCC RF exposure limits for “Occupational Use Only.” In addition, this M/A-COM radio complies with the following Standards and Guidelines with regard to RF energy and electromagnetic energy levels and evaluation of such levels for exposure to humans:

- FCC OET Bulletin 65 Edition 97-01 Supplement C, Evaluating Compliance with FCC Guidelines for Human Exposure to Radio Frequency Electromagnetic Fields.
- American National Standards Institute (C95.1 – 1992), IEEE Standard for Safety Levels with Respect to Human Exposure to Radio Frequency Electromagnetic Fields, 3 kHz to 300 GHz.

- American National Standards Institute (C95.3 – 1992), IEEE Recommended Practice for the Measurement of Potentially Hazardous Electromagnetic Fields – RF and Microwave.

### **RF EXPOSURE GUIDELINES**



**To ensure that exposure to RF electromagnetic energy is within the FCC allowable limits for occupational use, always adhere to the following guidelines:**

- DO NOT operate the radio without a proper antenna attached, as this may damage the radio and may also cause the FCC RF exposure limits to be exceeded. A proper antenna is the antenna supplied with this radio by M/A-COM or an antenna specifically authorized by M/A-COM for use with this radio. (Refer to Table 2 – Options and Accessories.)
- DO NOT transmit for more than 50% of total radio use time (“50% duty cycle”). Transmitting more than 50% of the time can cause FCC RF exposure compliance requirements to be exceeded. The radio is transmitting when the “TX” indicator appears in the display. The radio will transmit by pressing the “PTT” button.

- Always transmit using low power (refer to High/Low Power Adjustment section) when possible. In addition to conserving battery charge, low power can reduce RF exposure.
- ALWAYS use M/A-COM authorized accessories (antennas, batteries, belt clips, speaker/mics, etc). Use of unauthorized accessories may cause the FCC Occupational/Controlled Exposure RF compliance requirements to be exceeded. (Refer to Table 2 – Options and Accessories.)
- ALWAYS keep the device and its antenna at least 2 cm (0.8 inches) from the body and at least 5 cm (2 inches) from the face when transmitting to ensure FCC RF exposure compliance requirements are not exceeded. This radio has been tested for RF exposure compliance at the distances listed in Table 1. However, to provide the recipients of your transmission the best sound quality, hold the antenna at least 5 cm (2 inches) from mouth, and slightly off to one side.

**Table 1 - RF Exposure Compliance Testing Distances**

RADIO FREQUENCY	TESTED DISTANCES <i>(worst case scenario)</i>	
	Body	Face
800 MHz	1.6 cm	2.5 cm
VHF (136-174 MHz)	1.1 cm	2.5 cm
UHF-H (450-512 MHz)	1.1 cm	2.5 cm
UHF-L (378-430 MHz)	1.1 cm	2.5 cm

The information in this section provides the information needed to make the user aware of a RF exposure, and what to do to assure that this radio operates within the FCC RF exposure limits of this radio.

**ELECTROMAGNETIC INTERFERENCE/COMPATIBILITY**

During transmissions, this M/A-COM radio generates RF energy that can possibly cause interference with other devices or systems. To avoid such interference, turn off the radio in areas where signs are posted to do so. DO NOT operate the transmitter in areas that are sensitive to electromagnetic radiation such as hospitals, aircraft, and blasting sites.

## **OPERATING RULES AND REGULATIONS**

Two-way FM radio systems must be operated in accordance with the rules and regulations of the Federal Communications Commission (FCC). As an operator of two-way radio equipment, you must be thoroughly familiar with the rules that apply to your particular type of radio operation. Following these rules will help eliminate confusion and will assure the most efficient use of existing radio channels. This will provide a smooth operating radio network.

When using the radio, remember these rules:

1. It is a violation of FCC rules to interrupt any distress or emergency message. As the radio operates in much the same way as a telephone "party line" when in conventional mode, always listen and/or observe the absence of the "busy" display (refer to Table 3 – Display for display character) to make sure that the line is clear before sending any messages. If someone is sending an emergency message, such as reporting a fire or asking for help in an accident, KEEP OFF THE AIR! Emergency calls have priority over all other messages.
2. Use of profane or obscene language is prohibited by Federal Law.
3. It is against the law to send false call letters or a false distress or emergency message.



4. The FCC requires that conversations be brief and confined to business. To save time, use coded messages whenever possible.
5. Using the radio to send personal messages (except in an emergency) is a violation of FCC rules. Send only those messages essential for the business operation.
6. It is against Federal Law to repeat or otherwise make known anything overheard on the radio. Conversations between others sharing your channel must be regarded as confidential.

## **OPERATING TIPS**

Antenna location and condition are important when operating a portable radio. Operating the radio in low lying areas or terrain, under power lines or bridges, inside of a vehicle or in a metal framed building can severely reduce the range of the unit. Mountains can also reduce the range of the unit.

In areas where transmission or reception is poor, some improvement may be obtained by ensuring that the antenna is vertical. Moving a few yards in another direction or moving to a higher elevation may also improve communications. Vehicular operation can be aided with the use of an externally mounted antenna.

Battery condition is another important factor in the trouble free operation of a portable radio. Always properly charge the batteries.

## **EFFICIENT RADIO OPERATION**

Hold the portable radio approximately three inches from your mouth and speak into the microphone at a normal voice level.

Keep the antenna in a vertical position when receiving or transmitting a message.

Do not hold the antenna when receiving a message and, especially, do not hold when transmitting a message.



Do NOT hold onto the antenna when transmitting!

### **Antenna Care and Replacement**



Always keep the antenna at least 0.8 inches (2 cm.) away from the body and 2 inches (5 cm.) from the face when transmitting to ensure FCC RF exposure compliance requirements are not exceeded.



Do not use the portable radio with a damaged or missing antenna. A minor burn may result if a damaged antenna comes into contact with the skin. Replace a damaged antenna immediately. Operating a portable radio with the antenna missing could cause personal injury, damage the radio, and may violate FCC regulations.



Use only the supplied or approved antenna. Unauthorized antennas, modifications or attachments could cause damage to the radio unit and may violate FCC regulations. (Refer to Table 2 – Options and Accessories.)

### Electronic Devices



RF energy from portable radios may affect some electronic equipment. Most modern electronic equipment in cars, hospitals, homes, etc. are shielded from RF energy. However, in areas in which you are instructed to turn off two-way radio equipment, always observe the rules. ***If in doubt, turn it off!***

### Aircraft



Always turn off a portable radio before boarding any aircraft!

- Use it on the ground only with crew permission.
- DO NOT use while in-flight!!

### **Blasting Areas**



Turn two-way radios OFF when in a "blasting area" or in areas posted "turn off two-way radio." Remote control RF devices are used by some construction crews to detonate explosives.

### **Potentially Explosive Atmospheres**



Areas with potentially explosive atmosphere are often, but not always, clearly marked. These may be fueling areas, such as gas stations, fuel or chemical transfer or storage facilities, and areas where the air contains chemicals or particles, such as grain, dust, or metal powders.

Sparks in such areas could cause an explosion or fire resulting in bodily injury or even death.

Turn OFF two-way radios when in any area with a potentially explosive atmosphere. It is rare, but not impossible that a radio or its accessories could generate sparks.

## BATTERY DISPOSAL

The P7100<sup>IP</sup> series portable radios use rechargeable, recyclable Nickel Cadmium (NiCd) or Nickel Metal Hydride (NiMH) batteries.

### NICKEL CADMIUM BATTERY



At the end of its useful life, under various state and local laws, it may be illegal to dispose of Nickel Cadmium batteries into the municipal waste stream. Check with local solid waste officials for recycling options and proper disposal. Call Toll Free 1-800-8BATTERY for information and/or procedures for returning rechargeable batteries in your state.

### NICKEL METAL HYDRIDE BATTERY

There are no special requirements concerning the disposal of NiMH batteries. Batteries can be recycled. Call Toll Free 1-800-8BATTERY for information.

### **SCOPE OF THIS MANUAL**

This manual describes the basic functions and operation of the P7100<sup>IP</sup> series portable radios. For further detail about features and operation refer to the appropriate Maintenance Manual or contact the System Administrator.

### **WATER RESISTANCE**

The P7100<sup>IP</sup> series portable radios operate reliably even under adverse conditions. These radios meet MIL-STD-810F specifications for driven rain, humidity, and salt fog.

## OPTIONS AND ACCESSORIES

Table 2 lists options and accessories tested for use with the P7100<sup>IP</sup> series portable radios. Items for use with a specific band split are noted.

Refer to the maintenance manual or to M/A-COM's Products and Services Catalog for a complete list of options and accessories that includes those items that do not adversely affect the RF energy exposure.



**Always** use M/A-COM authorized accessories (antennas, batteries, belt clips, speaker/mics, etc). Use of unauthorized accessories may cause the FCC Occupational/Controlled Exposure RF compliance requirements to be exceeded. Refer to Table 2 – Options and Accessories.)



**Always** use the correct options and accessories (battery, antenna, speaker/mic, etc.) for the radio. Immersion rated options must be used with an immersion rated radio. Intrinsically safe options must be used with intrinsically safe radios. (Refer to Table 2 – Options and Accessories.)

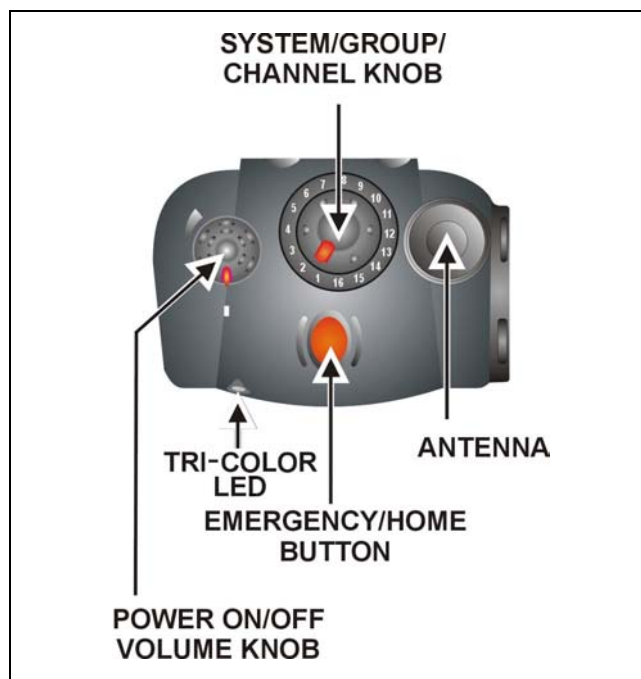

**Table 2 – Options and Accessories**

DESCRIPTION	PART NUMBER
<b>ANTENNAS</b>	
Antenna (136-151 MHz)	KRE 101 1219/1
Antenna (150-162 MHz)	KRE 101 1219/2
Antenna (162-174 MHz)	KRE 101 1219/3
Antenna (378-403 MHz)	KRE 101 1219/9
Antenna (403-430 MHz)	KRE 101 1219/10
Antenna (378-430 MHz)	KRE 101 1223/10
Antenna, Spring Whip (450-470 MHz)	KRE 101 1219/12
Antenna, Spring Whip (470-512 MHz)	KRE 101 1219/13
Antenna, Quarter Wave (450-512 MHz)	KRE 101 1223/12
Flexible Gain Antenna (800 MHz)	KRE 101 1506/1
Whip Antenna (800 MHz)	KRE 101 1223/01
<b>BATTERIES (IMMERSION-RATED)</b>	
7.5V Nickel Cadmium (NiCd) Battery	BKB 191 210/3
7.5V Nickel Metal Hydride (NiMH) Battery	BKB 191 210/4
7.5V NiCd Battery-Intrinsically Safe <IS>	BKB 191 210/5
7.5V NiMH Battery-Intrinsically Safe <IS>	BKB 191 210/6
<b>BATTERIES (WIND DRIVEN RAIN)</b>	
7.5V NiCd Battery	BKB 191 210/23
7.5V NiMH Battery	BKB 191 210/24
7.5V NiCd Battery - <IS>	BKB 191 210/25
7.5V NiMH Battery - <IS>	BKB 191 210/26

DESCRIPTION	PART NUMBER
<b>MISCELLANEOUS ACCESSORIES</b>	
Speaker Microphone Antenna Version Plus <IS>	KRY 101 1617/184
Speaker Microphone <IS>	KRY 101 1617/183
Metal Belt Clip	KRY 101 1647/1
Belt Loop with Swivel	KRY 101 1609/1
Swivel (part of KRY 101 1639 and 1648)	KRY 101 1608/2
Leather Case (Belt Loop type)	KRY 101 1638/1
Leather Case with Swivel & Belt Loop	KRY 101 1639/1
Nylon Case with Swivel & Belt Loop	KRY 101 1648/1
Nylon T-Strap	KRY 101 1656/1

**USER INTERFACE**



**Figure 1 – Top View**

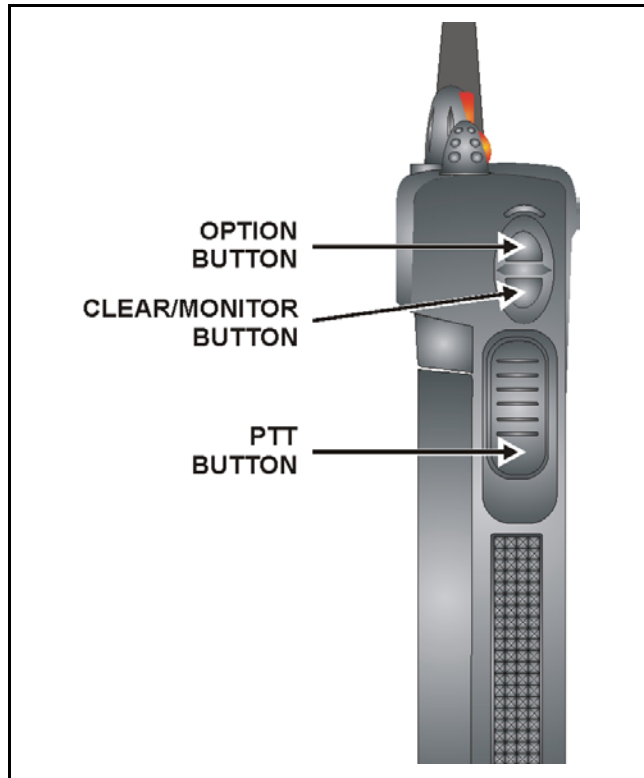

**Figure 2 – Side View**



Figure 3 – System Model

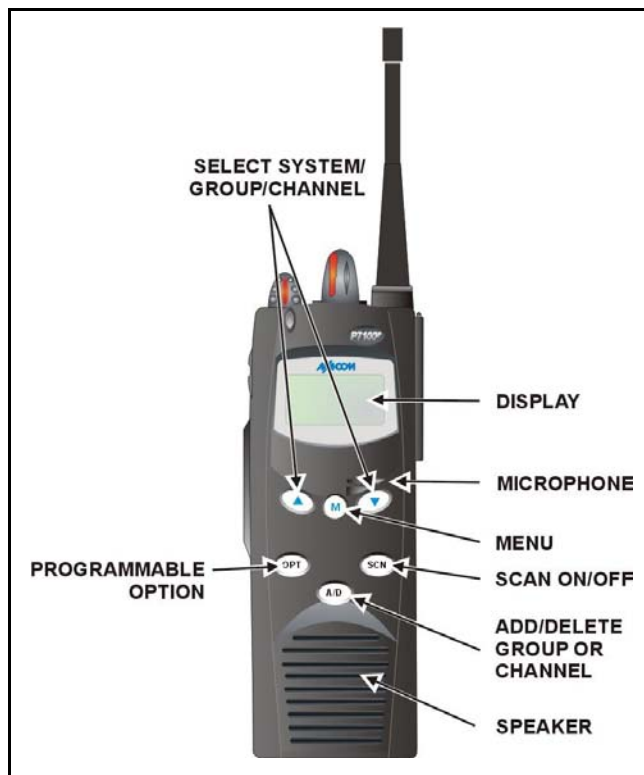

















Figure 4 – Scan Model

**Table 3 – Display Icons**

**Icon Descriptions**

	<b>Steady</b> – “Busy” transmitting or receiving <b>Flashing</b> – call queued
	<b>Steady</b> – special call mode (individual or telephone)
	<b>Steady</b> – during all radio transmissions
	<b>Steady</b> – transmit at low power <b>If icon is not visible</b> – transmit at high power
	<b>Steady</b> – battery charge indicator (refer to Figure 5)
	<b>Flashing</b> – Low battery indicator (refer to Figure 5)
	<b>Steady</b> – Indicates the current channel is set up as an analog channel.
	<b>Steady</b> – trunked system in Failsoft mode
	<b>Steady</b> – group or channel in scan list

	<b>Steady</b> – priority 2 group or channel
	<b>Steady</b> – priority 1 group or channel
	<b>Steady</b> ( <i>rotates clockwise</i> ) – scan mode enabled <b>If icon is not visible</b> – scan is disabled
	<b>Steady</b> – transmit in encrypt mode <b>Flashing</b> – receiving an encrypted call
	<b>Steady</b> – Channel Guard enabled <b>If icon is not visible</b> – Channel Guard is disabled
	<b>Steady</b> – Indicates the current channel is set up as a Project 25 (P25) channel.

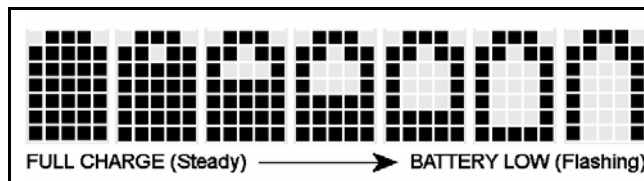

**Figure 5 - Battery Charge Icons (Full Cycle)**

The battery icons (as illustrated in Figure 5) indicate approximate level only, based on battery voltage.



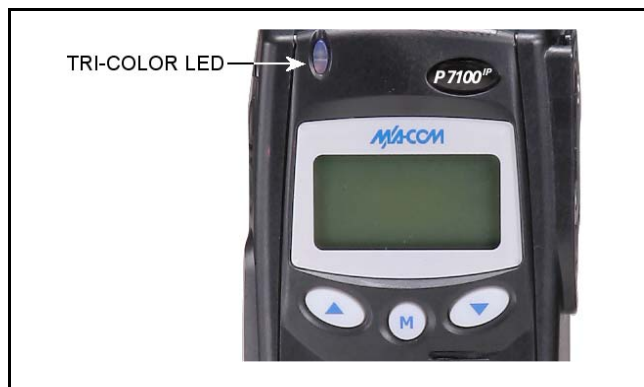

**Figure 6 – Tri-Color LED**

### **TRI-COLOR LED**

The tri-color LED changes color to indicate radio status and is visible from both the front and top of the radio. The three colors of the LED and the status they represent are:

Green: Receiving

Red: Unencrypted transmission

Orange: Encrypted transmission

## STATUS MESSAGES

During radio operation, various radio status messages can be displayed. The messages are described below.



<b><u>MESSAGE</u></b>	<b><u>NAME</u></b>	<b><u>DESCRIPTION</u></b>
<b><u>QUEUED</u></b>	Call Queued	<b>Trunked mode only.</b> Indicates the system has placed the call in a request queue.
<b><u>SYS BUSY</u></b>	System Busy	<b>Trunked mode only.</b> Indicates the system is busy, no channels are currently available, the queue is full, or an individual call is being attempted to a radio that is currently transmitting.
<b><u>DENIED</u></b>	Call Denied	<b>Trunked mode only.</b> Indicates the radio or talkgroup is not authorized to operate on the selected system and/or talkgroup.
<b><u>CC SCAN</u></b>	Control Channel Scan	<b>Trunked mode only.</b> Indicates the control channel is lost and the radio has entered the Control Channel Scan mode to search for the control channel (usually out of range indication).

<u>MESSAGE</u>	<u>NAME</u>	<u>DESCRIPTION</u>
<b>WA SCAN</b>	Wide Area Scan	<b>Trunked mode only.</b> Indicates the radio has entered the Wide Area Scan mode to search for a new system (if enabled through programming).
<b>TALKARND</b>	Talkaround	<b>Conventional mode only.</b> Indicates the radio is operating on conventional channels in talkaround mode (no repeater).
<b>SYSC ON</b>	System Scan Features On	<b>Trunked mode only.</b> Indicates the System Scan features are enabled.
<b>SYSC OFF</b>	System Scan Features Off	<b>Trunked mode only.</b> Indicates the System Scan features are disabled.
<b>LOW BATT</b>	Low Battery	Battery voltage has dropped below the point to where the radio is no longer able to transmit. The radio will still be receive calls until the battery is discharged beyond the point of operation upon which the radio will automatically shutdown.
<b>RXEMER</b>	Receive Emergency	<b>Trunked and P25 modes only.</b> Indicates an emergency call is being received. This message will be flashing on line two.

<u>MESSAGE</u>	<u>NAME</u>	<u>DESCRIPTION</u>
<b><i>TXEMER</i></b>	Transmit Emergency	<b>Trunked and P25 modes only.</b> Indicates an emergency call has been transmitted on this radio. This message will be flashing on line two.
<b><i>VOL=31</i></b>	Volume Level	Indicates the current volume level. The volume level display ranges from OFF (silent) to 31 (loudest).
<b><i>WHC</i></b>	Who Has Called	<b>Trunked and P25 modes only.</b> Indicates an individual call has been received, but not responded to. The indicator turns OFF if the individual call mode is entered, the system is changed, or the radio is turned off and then on again.
<b><i>UNKNOWN</i></b>	Unknown ID	<b>Trunked and P25 modes only.</b> Indicates an individual call is being received from an unknown ID.



## BASIC OPERATION

### SYSTEM SELECT – METHOD 1 (SYSTEM)





1. Press  to access system list.
2. Enter system ID number from keypad.
3. Press  to select desired system.

### SYSTEM SELECT – METHOD 2

Rotate System/Group/Channel knob, or

If this knob is not programmed for systems, press the   
 buttons to change systems.

### GROUP SELECT – METHOD 1 (SYSTEM)

1. Press  to access group list.
2. Press   to scroll through the list of groups.
3. Press  to select desired group.

### GROUP SELECT – METHOD 2



1. Rotate System/Group/Channel knob.

If this knob is not programmed for groups:







2. Press the   buttons to change groups.

## CHANNEL SELECT



Rotate System/Group/Channel knob, or

If this knob is not programmed for channels, press the   buttons to change channels.

## MODIFY SCAN LIST (SYSTEM)

1. Press  to toggle scan OFF and verify  is **not** displayed.
2. Select group or channel.
3. Press  once to remove group or channel from list.
4. Press  once to add as a normal group or channel.  
Press  twice to add as a Priority 2 group.  
Press  three times to add as a Priority 1 group.
5. Press  to re-start scanning.

## MODIFY SCAN LIST (SCAN MODEL)

1. Press  to toggle scan OFF and verify  is **not** displayed.
2. Select group or channel.
3. Press  once to remove group or channel from the list.

4. Press **(A/D)** once to add as a normal group or channel.  
Press **(A/D)** twice to add as a Priority 2 group.  
Press **(A/D)** three times to add as a Priority 1 group.
5. Press **(SCN)** to re-start scanning.

#### **NUISANCE DELETE (SYSTEM MODEL)**







A channel can temporarily be deleted from the scan list if it is not the currently selected channel.

1. Turn Scan ON.
2. When the radio receives a call on the channel, press the **(DEL)**. The channel is removed from the scan list until the radio is power cycled.





#### **BACKLIGHT ON/OFF**

1. Press **(M)** to access the menu.
2. Press **(▲)** **(▼)** to scroll through menu until "BCKLGHT" appears.
3. Press **(M)** to select Backlight menu.
4. Press **(▲)** **(▼)** to toggle backlight ON and OFF.
5. Press **(M)** to select new backlight setting.

### CONTRAST ADJUST

1. Press  to access the menu.
2. Press   to scroll through menu until "CONTRAST" appears.
3. Press  to select Contrast menu.
4. Press   to adjust contrast setting from 1 - 4.
5. Press  to select new contrast setting.

### DECLARING AN EMERGENCY

1. Press and hold the red Emergency/Home button (the length of time is programmable; check with the system administrator).
2. **\*TXEMER\*** will flash in the display, plus  and  will be displayed. After 2-3 seconds the transmit icon  will turn off.
3. **\*TXEMER\*** and  will remain until the emergency is cleared.
4. Press the PTT and  will reappear.



5. Release PTT when the transmission is complete.

### **LOCKING/UNLOCKING KEYPAD**





1. Press  button.
2. Within 1 second, press the Option button on the side of the radio.

### **HIGH/LOW POWER ADJUSTMENT**

Transmit power adjustment is possible if enabled through programming. Within conventional systems, transmit power is adjustable on a per channel basis. Within EDACS trunking systems, transmit power is adjustable on a per system basis.

There are two ways to toggle between high and low power:

#### **Using the Menu Button:**

1. Press .
2. Using the  and  keys, scroll until the cursor (>) appears to the left of "TX POWER" in the display.
3. Press  again to toggle between High and Low power.
4. "POWER = HIGH" or "POWER = LOW" will appear momentarily on the top line of the display.

**Using the Pre-Programmed Option Button:**

1. Press the Option button. "POWER = HIGH" or "POWER = LOW" will appear momentarily on the top line of the display.

**Table 4 - Alert Tones**

NAME	TONE	DESCRIPTION
Call Originate (B)	one short mid-pitched	<i>OK to talk after pressing the push-to-talk button</i>
Call Queued (T)	one high-pitched	<i>Call queued for processing</i>
Autokey (T)	one mid-pitched	<i>Queued call received channel assignment</i>
System Busy (T)	three low-pitched	<i>System busy or unable to complete call</i>
Call Denied (T)	one low-pitched	<i>Radio is not authorized on the system or group</i>
Carrier Control Timer (B)	five high-pitched / one long low-pitched	<i>PTT depressed for maximum length of time</i>
Low Battery (B)	one low-pitched / one short mid-pitched	<i>Low battery</i>
TX Low Battery Alert (B)	one low-pitched	<i>After PTT - battery too low to transmit</i>

(T) = trunked mode only (B) = both trunked and conventional modes







## TRUNKED OPERATION

### TRANSMITTING A CALL IN TRUNKED MODE







#### Group Call

1. Select desired group.
2. Press Push-To-Talk button.
3. The  and  icons will appear.

#### Individual Call (System)

1. Press  to access the individual call list.
2. The  icon will appear.
3. Press   to scroll through individual call list or Enter LID from keypad.
4. When the desired ID appears in the display press the Push-To-Talk button.
5. The  and  icons will appear.

#### Phone Call (System)

1. Press  to access the phone call list.
2. The  icon will appear.
3. Press   to scroll through phone call list or Enter number from keypad.
4. When the desired phone number appears in the display press the Push-To-Talk button.
5. The  and  icons will appear.

## RECEIVING A CALL IN TRUNKED MODE

### Group Calls

1. Select a group or turn scan ON and make sure group is in scan list.
2. The group name or “GR xxxx” will appear to indicate a call.

### Phone Calls

1. When the call is received, the receive audio sounds and the display reads: \*PHONE\*
2. Respond by pressing PTT. If you do not respond, radio will continue to ring to indicate an incoming call.

### Individual Calls

1. When the call is received, the receive audio sounds and the display reads : ID xxxxx  
\*INDV\*
2. Respond by pressing PTT. If you do not respond, radio will continue to ring to indicate an incoming call.
3. If the call is cleared with no response, the radio will store **Who Has Called** and display: \*WHC\*
4. Press the  key to display the ID.
5. Press the Push-To-Talk button to return the call or press the Clear/Monitor button to clear the \*WHC\*.

## CONVENTIONAL OPERATION

### RECEIVING A CALL

1. Select desired conventional system and channel or turn scan ON and make sure desired channel is in scan list.
2. When the radio receives a call, the radio will unmute and the channel name will appear in the display.

### SENDING A CALL

1. Select desired system and channel.
2. Ensure the channel is not busy by pressing the **Monitor/Clear** button momentarily. If audio is heard or if the  icon is on, the channel is busy.
3. When sure that the channel is not busy, press the Push-To-Talk button and speak into the microphone.

## **PROJECT 25 (P25) CONVENTIONAL OPERATION**

### **GROUP CALLS IN P25 MODE**

#### **Transmitting a Group Call**

1. Select the desired P25 system. (P25 icon will appear in display.)
2. Select the Talk Group/Conventional Channel. (Selected simultaneously using either the system/group/channel knob or the group key.)
3. Press and hold the PTT.
4. When a grant tone is received (if enabled through programming) speak into the microphone.
5. Release PTT and wait for response.

#### **Receiving a Group Call**

The radio will unmute according to the squelch mode defined in the radio personality (monitor, normal, selective).

1. Select the desired P25 system and Talk Group/Channel or turn scan on and make sure the desired channel is in the scan list.
2. When the radio receives a P25 call, the radio will unmute and the channel name will appear in the display.
3. Press the PTT button to respond.

## **INDIVIDUAL CALLS IN P25 MODE**

### **Transmitting an Individual Call**

1. Select the desired P25 system. (The P25 icon will appear in the display.)
2. Select the radio unit to call (callee source ID) from the pre-programmed individual call list or enter the ID number on the radio keypad.
3. Press and hold the PTT.
4. When grant tone is received (if enabled through programming) speak into the microphone.
5. Release the PTT.

### **Receiving an Individual Call**

The radio will unmute according to the squelch mode defined in the radio personality (monitor, normal, selective).

1. Select the desired P25 system and Talk Group/Channel or turn scan on and make sure the desired channel is in the scan list.
2. When the radio receives a P25 call, the radio will unmute and the ID of the transmitting radio will appear in the display.
3. Press the PTT button to respond.

Unanswered calls will appear in the Who Has Called (WHC) list.

## EMERGENCY GROUP CALLS IN P25 MODE



### NOTE

There is no method available for a system-wide Emergency clear. An emergency group call must be cleared on each individual radio.

### **Declaring an Emergency Group Call**

1. Select the desired P25 system and Talk Group/Channel.
2. Press the red emergency button on the top of the radio. The radio will broadcast a short emergency transmission with the emergency bit set. "TXEMER" will appear in the display of the transmitting radio.
3. While the PTT is NOT pressed, the mic will be open and the radio will broadcast an approximately 2 second transmission (e.g., background noise) which will be repeated at 10-30 second intervals.
4. Press the PTT to stop the short transmissions.
5. To send a voice message, press the PTT and speak into the microphone.
6. To clear an emergency from the transmitting radio, perform one of the following steps:
  - a) Change systems.



- b) Change channels (if not prohibited by programming).
- c) Cycle power by turning radio off and then back on.
- d) Press the Clear and Emergency buttons simultaneously, providing the Clear Emergency option is enabled in the Supervisory Options in the personality.

#### **Receiving an Emergency Group Call**

1. Select the desired P25 System and Talk Group/Channel.
2. When the radio detects an incoming Emergency Group Call, the radio will sound an alert tone and "RXEMER" will appear in the display.
3. Voice or emergency transmissions will be heard at the receiving radio.
4. To clear an emergency from the receiving radio, perform one of the following steps:
  - a) Change systems.
  - b) Change channels (if not prohibited by programming).
  - c) Cycle power by turning radio off and then back on.
  - d) Press the Clear and Emergency buttons simultaneously, providing the Clear Emergency option is enabled in the Supervisory Options in the personality.

### **OPERATION FOLLOWING WATER CONTACT**

If the P7100<sup>IP</sup> model radio has been immersed in water or if the microphone air path or speaker grill become clogged with water, follow instructions under “Radio Microphone” and “Radio Speaker” sections to assure the highest quality transmitted and received messages.

### **RADIO MICROPHONE**

In the event the P7100<sup>IP</sup> microphone air path becomes clogged with water, blow two quick successive breaths of air directly into the radio microphone air hole. Refer to Figure 7. This will help to clear any water trapped in the microphone air path and allow the microphone to function properly.

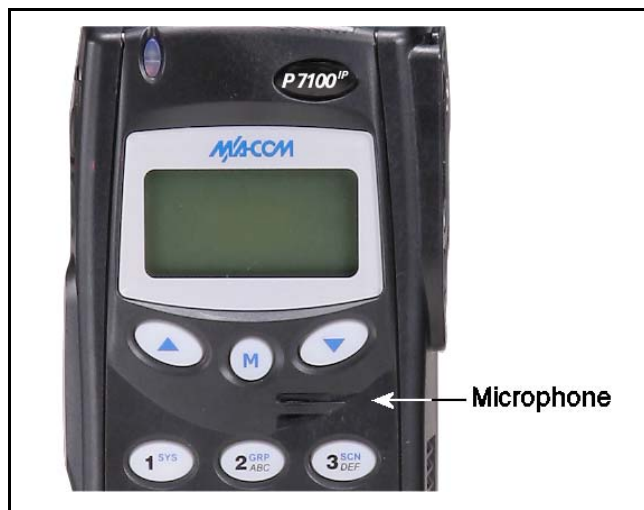

**Figure 7 – Radio Microphone**

### **RADIO SPEAKER**

To assure the user receives the highest quality receive audio possible after the radio has contacted water or been immersed, it may be necessary to clear excess water from the speaker cavity and grill. The speaker grill has been designed for easy drainage. To facilitate maximum drainage and the highest quality speaker output, shake the radio vigorously with speaker grill face down.

## CHANGING THE BATTERY PACK

### REMOVING THE BATTERY PACK

Make sure the power to the radio is turned OFF.

1. Press the latch at the bottom of the battery pack.
2. Lift the battery pack from the bottom.
3. Remove the battery pack from the radio.

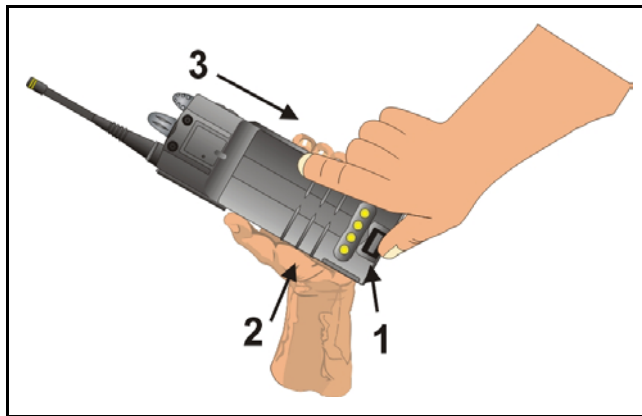
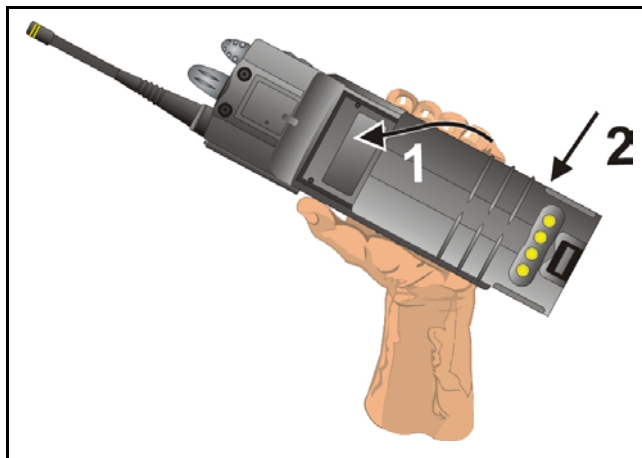

Figure 8 – Removing the Battery Pack

### **ATTACHING THE BATTERY PACK**

Make sure the power to the radio is turned OFF.

1. Align the tab on the top of the battery pack with the slot at the top of the battery cavity.
2. Push the battery pack down to attach the battery to the radio.
3. Verify that the battery pack is properly latched to the radio.



**Figure 9 – Attaching the Battery Pack**

## BATTERY WARRANTY

- A. M/A-COM, Inc. (hereinafter "Seller") warrants to the original purchaser for use (hereinafter "Buyer") that nickel-cadmium and nickel-metal hydride batteries supplied by Seller shall be free from defects in material and workmanship, and shall conform to its published specifications for a period of twelve (12) months from the date of purchase.
- B. For purposes of this warranty, batteries shall be deemed defective if (1) the battery capacity is less than 80% rated capacity, or (2) the battery develops leakage.
- C. If any battery fails to meet the foregoing warranty, Seller shall correct the failure by issuing a replacement battery upon receipt of the defective battery at an Authorized Service Center (ASC) or M/A-COM factory (for OpenSky® Equipment only).
- D. Replacement batteries shall be warranted only for the remaining unexpired warranty period of the original battery. This warranty becomes void if:
1. The battery has been subjected to any kind of misuse, detrimental exposure, or has been involved in an accident.
  2. The battery is used in equipment or service other than the radio equipment for which it is specified.
- E. The preceding paragraphs set forth the exclusive remedies for claims based upon defects in or non-conformity of any battery, whether the claim is in contract, warranty, tort (including negligence), strict liability or otherwise, and however instituted. Upon the expiration of the warranty period, all such liability shall terminate. The foregoing warranties are exclusive and in lieu of all other warranties, whether oral, written, expressed, implied or statutory. NO IMPLIED OR STATUTORY WARRANTIES OF MERCHANTABILITY OR FITNESS FOR PARTICULAR PURPOSE SHALL APPLY. IN NO EVENT SHALL THE COMPANY BE LIABLE FOR ANY INCIDENTAL, CONSEQUENTIAL, SPECIAL, INDIRECT OR EXEMPLARY DAMAGES.

This warranty applies only within the United States.

**M/A-COM, Inc.**  
1011 Pawtucket Blvd.  
Lowell, MA 01853  
1-877-OPENSKY

**M/A-COM, Inc.**  
221 Jefferson Ridge Parkway  
Lynchburg, VA 24501  
1-800-528-7711

ECR-7048B

## WARRANTY

- A. M/A-COM, Inc. (hereinafter "Seller") warrants to the original purchaser for use (hereinafter "Buyer") that Equipment manufactured by or for the Seller shall be free from defects in material and workmanship, and shall conform to its published specifications. With respect to all non-M/A-COM Equipment, Seller gives no warranty, and only the warranty, if any, given by the manufacturer shall apply. Rechargeable batteries are excluded from this warranty but are warranted under a separate Rechargeable Battery Warranty (ECR-7048).
- B. Seller's obligations set forth in Paragraph C below shall apply only to failures to meet the above warranties occurring within the following periods of time from date of sale to the Buyer and are conditioned on Buyer's giving written notice to Seller within thirty (30) days of such occurrence:
1. for fuses and non-rechargeable batteries, operable on arrival only.
  2. for parts and accessories (except as noted in B.1) sold by Seller's Service Parts Operation, ninety (90) days.
  3. for PANTHER™ Series handportable and mobile radios, two (2) years.
  4. for Cougar™ Series handportable and mobile radios, two (2) years.
  5. for OpenSky®, ProVoice™, and EDACS® Equipment of Seller's manufacture, one (1) year.
- C. If any Equipment fails to meet the foregoing warranties, Seller shall correct the failure at its option (i) by repairing any defective or damaged part or parts thereof, (ii) by making available at Seller's factory any necessary repaired or replacement parts, or (iii) by replacing the failed Equipment with equivalent new or refurbished Equipment. Any repaired or replacement part furnished hereunder shall be warranted for the remainder of the warranty period of the Equipment in which it is installed. Where such failure cannot be corrected by Seller's reasonable efforts, the parties will negotiate an equitable adjustment in price. Labor to perform warranty service will be provided at no charge during the warranty period only for the Equipment covered under Paragraph B.3-B.5. To be eligible for no-charge labor,

service must be performed at a M/A-COM factory (for OpenSky® Equipment only), by an Authorized Service Center (ASC) or other Servicer approved for these purposes either at its place of business during normal business hours, for mobile or personal equipment, or at the Buyer's location, for fixed location equipment. Service on fixed location equipment more than thirty (30) miles from the Service Center or other approved Servicer's place of business will include a charge for transportation.

- D. Seller's obligations under Paragraph C shall not apply to any Equipment, or part thereof, which (i) has been modified or otherwise altered other than pursuant to Seller's written instructions or written approval or, (ii) is normally consumed in operation or, (iii) has a normal life inherently shorter than the warranty periods specified in Paragraph B, or (iv) is not properly stored, installed, used, maintained or repaired, or, (v) has been subjected to any other kind of misuse or detrimental exposure, or has been involved in an accident.
- E. The preceding paragraphs set forth the exclusive remedies for claims based upon defects in or nonconformity of the Equipment, whether the claim is in contract, warranty, tort (including negligence), strict liability or otherwise, and however instituted. Upon the expiration of the warranty period, all such liability shall terminate. The foregoing warranties are exclusive and in lieu of all other warranties, whether oral, written, expressed, implied or statutory. NO IMPLIED OR STATUTORY WARRANTIES OF MERCHANTABILITY OR FITNESS FOR PARTICULAR PURPOSE SHALL APPLY. IN NO EVENT SHALL THE SELLER BE LIABLE FOR ANY INCIDENTAL, CONSEQUENTIAL, SPECIAL, INDIRECT OR EXEMPLARY DAMAGES.

This warranty applies only within the United States.

**M/A-COM, Inc.**  
1011 Pawtucket Blvd.  
Lowell, MA 01853  
1-877-OPENSKY

**M/A-COM, Inc.**  
221 Jefferson Ridge Parkway  
Lynchburg, VA 24501  
1-800-528-7711

ECR-7047B





**M/A-COM, Inc.**

221 Jefferson Ridge Parkway

Lynchburg, Virginia 24501

(Outside USA, 434-385-2400) Toll Free 800-528-7711

[www.macom-wireless.com](http://www.macom-wireless.com)

Printed in U.S.A.