

APPENDIX I: MANUALS

Please refer to the following pages for user and installation manuals.

future
The Future of Mobile Radio



M7100^{IP} Series
Mobile Radio

MANUAL REVISION HISTORY

REVISION	DATE	REASON FOR CHANGE
A	February 2004	Initial release.
B	March 2004	Add MPE and FCC information for VHF M7100 ^{IP} radio.
C	March 2004	Append MPE and FCC information for UHF-L M7100 ^{IP} radio.

SUPPLEMENTARY INFORMATION:

At this time, the M7100^{IP} mobile radio may not be operated while in a desktop station in the European Community since it does not meet immunity requirements when operated in this mode. The M7100^{IP} mobile radio can be used in both trunked and conventional applications.

ACKNOWLEDGEMENTS

This device is made under license under one or more of the following US patents: 4,590,473; 4,636,791; 5,148,482; 5,185,796; 5,271,017; 5,377,229; 4,716,407; 5,502,767; 5,146,497; 5,164,986; 5,185,795.

The voice coding technology embodied in this product is protected by intellectual property rights including patent rights, copyrights, and trade secrets of Digital Voice Systems, Inc. The user of this technology is explicitly prohibited from attempting to decompile, reverse engineer, or disassemble the Object Code, or in any other way convert the Object Code into human-readable form.

EDACS is a registered trademark and ProGrammer, SCAT, Failsoft, ProSound, ProScan, Aegis, ProFile, ProVoice, and G-STAR are trademarks of M/A-COM, Inc.

IMBE is a registered trademark of Digital Voice Systems, Inc.

All other brand and product names are trademarks, registered trademarks, or service marks of their respective holders.

NOTICE!

This manual covers M/A-COM products manufactured and sold by M/A-COM, Inc.

Repairs to this equipment should be made only by an authorized service technician or facility designated by the supplier. Any repairs, alterations or substitution of recommended parts made by the user to this equipment not approved by the manufacturer could void the user's authority to operate the equipment in addition to the manufacturer's warranty.

The software contained in this device is copyrighted by M/A-COM, Inc. Unpublished rights are reserved under the copyright laws of the United States.

This manual is published by **M/A-COM, Inc.**, without any warranty. Improvements and changes to this manual necessitated by typographical errors, inaccuracies of current information, or improvements to programs and/or equipment, may be made by **M/A-COM, Inc.**, at any time and without notice. Such changes will be incorporated into new editions of this manual. No part of this manual may be reproduced or transmitted in any form or by any means, electronic or mechanical, including photocopying and recording, for any purpose, without the express written permission of **M/A-COM, Inc.**

TABLE OF CONTENTS

	<i>Page</i>
1 SAFETY SYMBOL CONVENTIONS.....	5
2 RF ENERGY EXPOSURE INFORMATION.....	6
2.1 RF ENERGY EXPOSURE INFORMATION	6
2.2 COMPLIANCE WITH RF EXPOSURE STANDARDS	6
3 OPERATION SAFETY RECOMMENDATIONS.....	9
3.1 TRANSMITTER HAZARDS	9
3.2 SAFE DRIVING RECOMMENDATIONS	9
4 OPERATING RULES AND REGULATIONS.....	10
4.1 OPERATING TIPS.....	10
5 INTRODUCTION	11
6 USER INTERFACE	12
7 CONTROLS.....	13
7.1 POWER ON-OFF VOLUME KNOB	13
7.2 SYSTEM/GROUP CHANNEL KNOB	13
7.3 RAMP CONTROL	13
7.4 SCAN ON/OFF.....	13
7.5 SCAN ADD/DELETE	14
7.6 INDICATORS	14
7.7 KEYPAD	14
8 DISPLAY 18	
8.1 RADIO STATUS ICONS	18
8.2 MESSAGES.....	19
9 ALERT TONES	22
9.1 CALL ORIGINATE	22
9.2 AUTOKEY (TRUNKED MODE ONLY).....	22
9.3 CALL QUEUED (TRUNKED MODE ONLY)	22
9.4 SYSTEM BUSY (TRUNKED MODE ONLY).....	22
9.5 CALL DENIED (TRUNKED MODE ONLY).....	22
9.6 CARRIER CONTROL TIMER	22
9.7 KEY PRESS ALERT	22
9.8 DUAL CONTROL SWITCHING	22
10 OPERATION	23
10.1 TURNING THE RADIO ON	23
10.2 SELECTION MODE RULES.....	23
10.3 DIRECT ACCESS	24
10.4 MENU	24
10.5 FEATURE ENCRYPTION DISPLAY.....	28
10.6 SYSTEM/GROUP/CHANNEL SELECTION	29
11 TRUNKED MODE OPERATION.....	31
11.1 RECEIVING A CALL.....	31
11.2 SENDING A CALL.....	31

TABLE OF CONTENTS

	<i>Page</i>
11.3 CONVENTIONAL FAILSOFT.....	31
11.4 EMERGENCY OPERATION	32
11.5 SYSTEM SCAN OPERATION	32
11.6 GROUP SCAN OPERATION	34
11.7 INDIVIDUAL CALLS	36
11.8 SCAT OPERATION	37
11.9 TELEPHONE INTERCONNECT CALLS.....	38
11.10 MOBILE DATA	39
11.11 STATUS/MESSAGE OPERATION.....	42
11.12 EDACS CONVENTIONAL P1 SCAN	43
11.13 DYNAMIC REGROUP OPERATION.....	43
12 CONVENTIONAL MODE OPERATION	44
12.1 RECEIVING A CALL	44
12.2 SENDING A CALL	44
12.3 EMERGENCY OPERATION	44
12.4 SCANNING CONVENTIONAL CHANNELS.....	45
12.5 TURNING SCAN ON	46
12.6 TURNING SCAN OFF	47
12.7 SQUELCH ADJUST.....	47
12.8 TYPE 99 DECODE (CONVENTIONAL ONLY).....	48
12.9 DIRECT MODE OPERATION (CONVENTIONAL ONLY).....	49
13 PROJECT 25 (P25) CONVENTIONAL OPERATION.....	50
13.1 GROUP CALLS IN P25 MODE.....	50
13.2 INDIVIDUAL CALLS IN P25 MODE	50
13.3 EMERGENCY GROUP CALLS IN P25 MODE.....	51
14 TRUNKED OR CONVENTIONAL MODE OPERATION	52
14.1 SIREN/LIGHT OPERATION.....	52
14.2 DIGITAL VOICE OPERATION	52
14.3 DUAL CONTROL OPERATION	57
14.4 MULTIPLE RADIO OPERATION	58
14.5 MACRO KEY OPERATION	59
14.6 INTERCONNECT CALL (SYSTEM MODEL ONLY)	60
14.7 KEYPAD REMAPPING.....	60
GLOSSARY	62
RADIO SETUP	64
WARRANTY	66

1 SAFETY SYMBOL CONVENTIONS

The following conventions are used throughout this manual to alert the user to general safety precautions that must be observed during all phases of operation, service, and repair of this product. Failure to comply with these precautions or with specific warnings elsewhere in this manual violates safety standards of design, manufacture, and intended use of the product. M/A-COM, Inc. assumes no liability for the customer's failure to comply with these standards.



The **WARNING** symbol calls attention to a procedure, practice, or the like, which, if not correctly performed or adhered to, could result in personal injury. Do not proceed beyond a **WARNING** symbol until the conditions identified are fully understood or met.



The **CAUTION** symbol calls attention to an operating procedure, practice, or the like, which, if not performed correctly or adhered to, could result in damage to the equipment or severely degrade the equipment performance.



The **NOTE** symbol calls attention to supplemental information, which may improve system performance or clarify a process or procedure.



The **ESD** symbol calls attention to procedures, practices, or the like, which could expose equipment to the effects of **Electro-Static Discharge**. Proper precautions must be taken to prevent ESD when handling circuit modules.

2 RF ENERGY EXPOSURE INFORMATION

2.1 RF ENERGY EXPOSURE AWARENESS, CONTROL INFORMATION, AND OPERATION INSTRUCTIONS FOR FCC OCCUPATIONAL USE REQUIREMENTS

Before using your mobile two-way radio, read this important RF energy awareness and control information and operational instructions to ensure compliance with the FCC's RF exposure guidelines.



NOTE

This radio is intended for use in occupational/controlled conditions, where users have full knowledge of their exposure and can exercise control over their exposure to meet FCC limits. This radio device is NOT authorized for general population, consumer, or any other use.

This two-way radio uses electromagnetic energy in the radio frequency (RF) spectrum to provide communications between two or more users over a distance. It uses RF energy or radio waves to send and receive calls. RF energy is one form of electromagnetic energy. Other forms include, but are not limited to, electric power, sunlight, and x-rays. RF energy, however, should not be confused with these other forms of electromagnetic energy, which, when used improperly, can cause biological damage. Very high levels of x-rays, for example, can damage tissues and genetic material.

Experts in science, engineering, medicine, health, and industry work with organizations to develop standards for exposure to RF energy. These standards provide recommended levels of RF exposure for both workers and the general public. These recommended RF exposure levels include substantial margins of protection. All two-way radios marketed in North America are designed, manufactured, and tested to ensure they meet government established RF exposure levels. In addition, manufacturers also recommend specific operating instructions to users of two-way radios. These instructions are important because they inform users about RF energy exposure and provide simple procedures on how to control it. Please refer to the following websites for more information on what RF energy exposure is and how to control your exposure to assure compliance with established RF exposure limits.

<http://www.fcc.gov/oet/rfsafety/rf-faqs.html>

<http://www.osha.gov/SLTC/radiofrequencyradiation/index.html>

2.1.1 Federal Communications Commission Regulations

Your M/A-COM, Inc. M7100^{IP} mobile two-way radio is designed and tested to comply with the FCC RF energy exposure limits for mobile two-way radios before it can be marketed in the United States. When two-way radios are used as a consequence of employment, the FCC requires users to be fully aware of and able to control their exposure to meet occupational requirements. Exposure awareness can be facilitated by the use of a label directing users to specific user awareness information. Your M/A-COM, Inc. M7100^{IP} two-way radio has an RF exposure product label. Also, your M7100^{IP} Installation and Operator's Manuals include information and operating instructions required to control your RF exposure and to satisfy compliance requirements.

2.2 COMPLIANCE WITH RF EXPOSURE STANDARDS

Your M/A-COM, Inc. M7100^{IP} mobile two-way radio is designed and tested to comply with a number of

national and international standards and guidelines (listed below) regarding human exposure to RF electromagnetic energy. This radio complies with the IEEE and ICNIRP exposure limits for occupational/controlled RF exposure environment at duty factors of up to 50% talk-50% listen and is authorized by the FCC for occupational use. In terms of measuring RF energy for compliance with the FCC exposure guidelines, your radio antenna radiates measurable RF energy only while it is transmitting (talking), not when it is receiving (listening) or in standby mode.

Your M/A-COM, Inc. M7100^{IP} mobile two-way radio complies with the following RF energy exposure standards and guidelines:

- United States Federal Communications Commission (FCC), Code of Federal Regulations; 47 CFR §§ 2 sub-part J.
- American National Standards Institute (ANSI)/Institute of Electrical and Electronic Engineers (IEEE) C95.1-1992.
- Institute of Electrical and Electronic Engineers (IEEE) C95.1-1999.



Table 2-1 lists the recommended minimum lateral distance for bystanders in an uncontrolled and controlled environment, from transmitting types of antennas (i.e., monopoles over a ground plane, or dipoles) at rated radio power for mobile radios installed in a vehicle.

Table 2-1: Rated Power and Recommended Minimum Lateral Distance

MOBILE RADIO FREQUENCY SPLIT	RATED POWER OF VEHICLE-INSTALLED MOBILE TWO-WAY RADIO	RECOMMENDED MINIMUM LATERAL DISTANCE FROM TRANSMITTING ANTENNA	
		Controlled	Uncontrolled
VHF	110 Watts	92.87 cm	207.67 cm
UHF-L	50 Watts (Antenna P/N: AN102800V1)	50.89 cm	113.79 cm

2.2.1 Mobile Antennas

Install the radio's antenna (M/A-COM part number 19B209568P6 for VHF radios and AN102800V1 for UHF-L radios) in the center of the vehicle's roof. These mobile antenna installation guidelines are limited to metal body motor vehicles or vehicles with appropriate ground planes. The antenna installation should additionally be in accordance with the following.

1. The requirements of the antenna manufacturer/supplier included with the antenna.
2. Instructions in the M7100^{IP} Radio Installation Manual, including minimum antenna cable lengths.
3. The installation manual providing specific information of how to install the antennas to facilitate recommended operating distances to all potentially exposed persons.

Use only the M/A-COM approved/supplied antenna(s) or approved replacement antenna. Unauthorized antennas, modifications, or attachments could damage the radio and may violate FCC regulations.

2.2.2 Approved Accessories

This radio has been tested and meets the FCC RF exposure guidelines when used with the M/A-COM accessories supplied or designated for use with this product. Use of other accessories may not ensure compliance with the FCC's RF exposure guidelines, and may violate FCC regulations.

For a list of M/A-COM approved accessories refer to the product manuals, M/A-COM's Products and Services Catalog, or contact M/A-COM at 1-800-368-3277.

2.2.3 Contact Information

For additional information on exposure requirements or other information, contact M/A-COM, Inc. at 1-800-528-7711 or at <http://www.macom-wireless.com>.

3 OPERATION SAFETY RECOMMENDATIONS

3.1 TRANSMITTER HAZARDS



The operator of any mobile radio should be aware of certain hazards common to the operation of vehicular radio transmitters. **A list of several possible hazards is given:**

- **Explosive Atmospheres** – Just as it is dangerous to fuel a vehicle with the motor running, similar hazards exist when operating a mobile radio. Be sure to turn the radio off while fueling a vehicle. Do not carry containers of fuel in the trunk of a vehicle if the radio is mounted in the trunk.

Areas with potentially explosive atmosphere are often, but not always, clearly marked. Turn OFF your radio when in any area with a potentially explosive atmosphere. It is rare, but not impossible that the radio or its accessories could generate sparks.
- **Interference to Vehicular Electronics Systems** – Electronic fuel injection systems, electronic anti-skid braking systems, electronic cruise control systems, etc., are typical electronic systems that can malfunction due to the lack of protection from radio frequency energy present when transmitting. If the vehicle contains such equipment, consult the dealer and enlist their aid in determining the expected performance of electronic circuits when the radio is transmitting.
- **Electric Blasting Caps** – To prevent accidental detonation of electric blasting caps, **DO NOT** use two-way radios within 1000 feet of blasting operations. Always obey the “**Turn Off Two-Way Radios**” signs posted where electric blasting caps are being used. (OSHA Standard: 1926-900)
- **Liquefied Petroleum (LP) Gas Powered Vehicles** – Mobile radio installations in vehicles powered by liquefied petroleum gas with the LP gas container in the trunk or other sealed-off space within the interior of the vehicle must conform to the National Fire Protection Association standard **NFPA 58** requiring:
 - The LP gas container and its fittings.
 - Outside filling connections shall be used for the LP gas container.
 - The LP gas container shall be vented to the outside of the vehicle.

3.2 SAFE DRIVING RECOMMENDATIONS

(Recommended by AAA)

- Read the literature on the safe operation of the radio.
- Keep both hands on the steering wheel and the microphone in its hanger whenever the vehicle is in motion.
- Place calls only when the vehicle is stopped.
- When talking from a moving vehicle is unavoidable, drive in the slower lane. Keep conversations brief.
- If a conversation requires taking notes or complex thought, stop the vehicle in a safe place and continue the call.
- Whenever using a mobile radio, exercise caution.

4 OPERATING RULES AND REGULATIONS

Two-way FM radio systems must be operated in accordance with the rules and regulations of the local, regional, or national government.

In the United States, the M7100^{IP} Series mobile radio must be operated in accordance with the rules and regulations of the Federal Communications Commission (FCC). As an operator of two-way radio equipment, you must be thoroughly familiar with the rules that apply to your particular type of radio operation. Following these rules helps eliminate confusion, assures the most efficient use of the existing radio channels, and results in a smoothly functioning radio network.

When using your two-way radio, remember these rules:

- It is a violation of FCC rules to interrupt any distress or emergency message. As your radio operates in much the same way as a telephone “**party line**,” always listen to make sure that the channel is clear before transmitting. Emergency calls have priority over all other messages. If someone is sending an emergency message – such as reporting a fire or asking for help in an accident – **KEEP OFF THE AIR!**
- The use of profane or obscene language is prohibited by Federal law.
- It is against the law to send false call letters or false distress or emergency messages. The FCC requires that you keep conversations brief and confine them to business. To save time, use coded messages whenever possible.
- Using your radio to send personal messages (except in an emergency) is a violation of FCC rules. You may send only those messages that are essential for the operation of your business.
- It is against Federal law to repeat or otherwise make known anything you overhear on your radio. Conversations between others sharing your channel must be regarded as confidential.
- The FCC requires that you identify yourself at certain specific times by means of your call letters. Refer to the rules that apply to your particular type of operation for the proper procedure.
- No changes or adjustments shall be made to the equipment except by an authorized or certified electronics technician.



NOTE

Under U.S. law, operation of an unlicensed radio transmitter within the jurisdiction of the United States may be punishable by a fine of up to \$10,000, imprisonment for up to two (2) years, or both.

4.1 OPERATING TIPS

The following conditions tend to reduce the effective range of two-way radios and should be avoided whenever possible:

- Operating the radio in areas of low terrain, or while under power lines or bridges.
- Obstructions such as mountains and buildings.
- In areas where transmission or reception is poor, some improvement can be obtained by moving a few yards in another direction or moving to a higher elevation.

5 INTRODUCTION

This manual describes how to use the M7100^{IP} Series Mobile Radio. The M7100^{IP} is a synthesized, microprocessor-based, high performance mobile FM radio providing reliable two-way communications in both the **Enhanced Digital Access Communications System** (EDACS[®]) trunking environment and conventional communication systems.

In the EDACS or trunked system mode, the user selects a communications system and group. In this mode, channel selection is transparent to the user and is controlled via digital communication with the system controller. This provides advanced programmable features and fast access to communication channels.

In the conventional mode, the user selects a channel and directly communicates on that channel. In this mode, a system refers to a set of channels. A channel is a transmit/receive radio frequency pair.

The exact operation of the radio will depend on the operating mode, the radio's programming and the particular radio system. Most features described in this manual can be enabled or disabled through programming. Consult the system administrator for the particular features that are programmed into the M7100^{IP}.

6 USER INTERFACE

The M7100^{IP} operating controls are located on the radio's front panel (see Figure 6-1 and Figure 6-2). A keypad, vacuum florescent display for radio status information and a microphone jack are on the front panel. The front panel also provides a rotary **SYSTEM/GROUP/CHANNEL** knob, **POWER ON-OFF/VOLUME** control, a ramp up/ramp down control, Scan add/delete control, and a **SCAN ON-OFF** control for scan operation.

The keypad is used for manual number entry for individual calls, access to a telephone interconnect system and activation of various EDACS or conventional features such as menu selection. Each key has an associated LED for status indication.

The display has two lines with eight alphanumeric-characters used to show the operational mode of the radio. There is one LED for indicating transmitter **ON** and one LED to indicate **CHANNEL BUSY** located below the **POWER ON-OFF/VOLUME** Control.

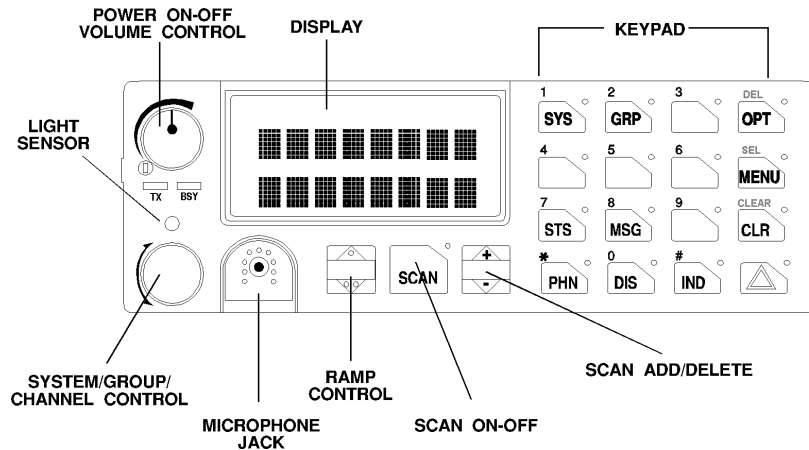

Figure 6-1: M7100^{IP} Series Mobile Radio System Model Front Panel

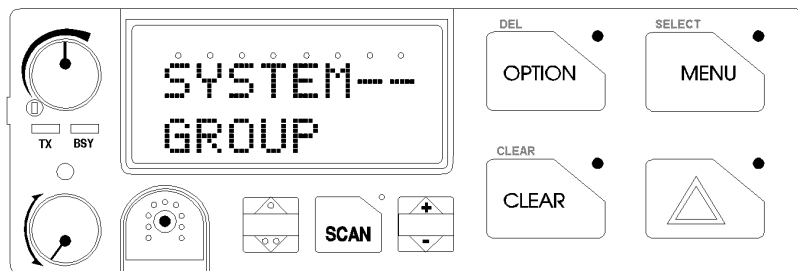

Figure 6-2: M7100^{IP} Series Mobile Radio Scan Model Front Panel

7 CONTROLS

This section describes the buttons, keys and rotary knobs used to control the M7100^{IP} Series Mobile Scan and System Model radios. All functions and controls of the Scan radio operate the same as the corresponding functions and controls on the System radio. The Scan radio is equipped with a 4-button keypad and the System radio is equipped with a 16-button keypad.

Many of the control buttons and keys have or can be programmed to have a primary function and a secondary function. The SCAN button can be programmed (as a secondary function) to toggle the keypad keys between their primary function and their secondary function.

7.1 POWER ON-OFF VOLUME KNOB

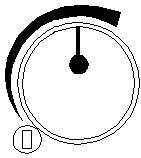

This rotary knob applies power to the radio and adjusts the receiver volume. Rotating the control clockwise out of detent applies power to the radio. A single alert tone sounds (if enabled through programming) to indicate the radio is operational.

Rotating the control clockwise increases the volume level. Minimum volume levels can be programmed into the radio to prevent missed calls due to a low volume setting. While adjusting the volume, the display will briefly indicate the volume level (i.e. VOL = 31). The volume range is from a minimum level of zero (displayed as OFF in the display) up to 31, which is the loudest level.

7.2 SYSTEM/GROUP CHANNEL KNOB

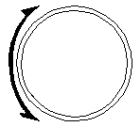

This rotary switch selects the systems or groups/channels, depending upon programming. This 16-position rotary switch has no stop or detent. See **SYSTEM/GROUP/CHANNEL SELECTION** section for more details.

7.3 RAMP CONTROL

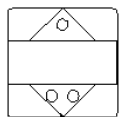

The primary function of this rocker type button is to scroll through the System list or the Group/Channel list depending upon programming. The secondary function is to increment or decrement items within a list (phone list for example). Press \triangle to scroll in increasing order and press ∇ to scroll in decreasing order. To auto-ramp, press and hold the button.

7.4 SCAN ON/OFF



The primary function of this button is to toggle scan operation ON and OFF. When the radio is scanning, the SCAN LED is on and all groups or channels in the scan list of the currently selected systems are scanned.

The secondary function of the SCAN button is to toggle the keypad buttons between their primary function and their secondary function.

7.5 SCAN ADD/DELETE

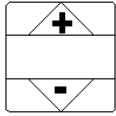

This rocker type button is used to display the current SCAN status for a group/channel and then either add or delete the group/channel from the system scan list.

7.6 INDICATORS



TX

Transmitter enabled - ON when the radio is transmitting.

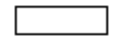

BSY

BuSY - On indicates a carrier is being received (the channel is busy). Note that if the selected channel is programmed for Channel Guard (CG), Digital Channel Guard (DCG) or Type 99 (T99) tone decode operation, the radio will not un-squelch if a valid tone or code is not received; the BSY indicator will be on.

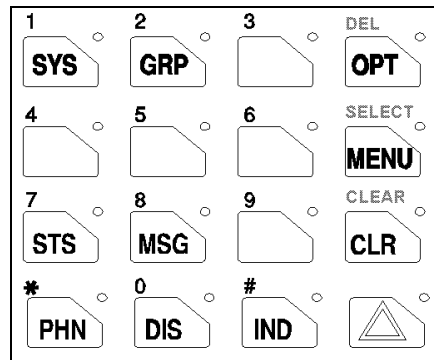

Figure 7-1: M7100^{IP} System Model Keypad

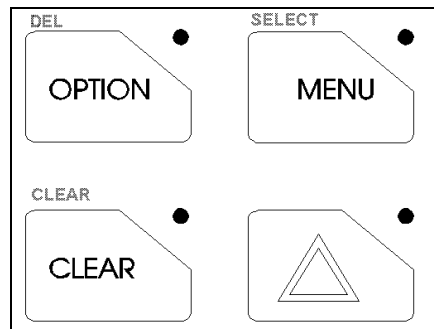

Figure 7-2: M7100^{IP} Scan Model Keypad

7.7 KEYPAD

The keypad is similar to a telephone keypad but with four (4) additional buttons on the side for a total of 16 keys. In addition to numbers (1-9, *, 0 and #), which is a secondary function, most of the keys have or can be programmed to have a primary function. A symbol or abbreviated word describing its primary function is labeled on the keycap. Each labeled keycap is associated with a radio feature (or primary function). The radio must be programmed to operate with the Standard or the Optional keycap configuration.

A keylight (LED) is associated with each key or button. This can light when the associated function is active. In some conditions, the keylight can blink to indicate an action status.

The keypad key functions can be remapped to any of the primary function keys using the PC programming software. It is suggested that the blank keypad (located at the back of this manual) be completed if the keypad key functions are changed.

7.7.1 Standard Keycap Configuration

The Standard keycap package for the System radio includes five (5) labeled keycaps (MODE, HOME, CHN, AUX1 and AUX2) and six (6) blank keycaps, which can be placed on any of the five key locations (numbers 3-6 and 9) shown in Figure 7-3. The keycap represents the primary function programmed for that key location. See Section 7.7.3 for a description of the primary function associated with these five (5) keycaps.

The standard keycap package for the Scan radio includes five (5) labeled keycaps [MENU, CLEAR, SELECT, EMERGENCY  or “E,” and OPTION] and five (5) blank keycaps, which can be placed on any of the four (4) keypad keys. The keycap represents the primary function programmed for that key location.

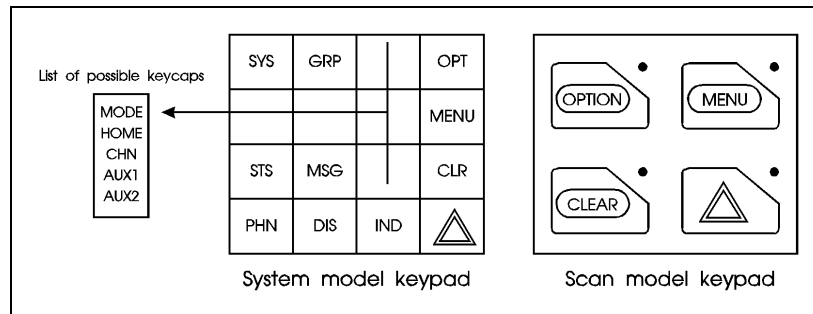

Figure 7-3: Standard M7100^{IP} Keycaps Configuration

7.7.2 Optional Keycap Configuration

The optional keycap package for the System radio includes sixty (60) additional keycaps (shown in Section 7.7.3), which can be placed on any key location desired. Keep in mind, the keycap represents the primary function programmed for that key location.

7.7.3 Key Descriptions

- MODE** This key is used to enter the Conventional System selection mode.
- HOME** This key returns the radio to the Home System/Group where it is programmed.
- CHN** This key is used to enter the Channel select mode.
- AUX1 & 2** These keys are used to control output 1 or 2. Their definition is PC programmable.



This key is used to enter the System select mode.













This key is used to enter the Group select mode.



or











The “**OPT**” or “**OPTION**” key is used to toggle a PC programmable feature ON and OFF.

DEL	Secondary function - used to delete a digit during numeric entry (see Section 10.2).
	Primary function - accesses the menu list. This is a list of additional features that are not available directly from the keypad. See Section 10.4 for details.
SELECT	Secondary function - activates a selected item within a list. After the menu list is accessed, select a menu item from the list via RAMP controls, \triangle or ∇ , and activate it with this key. Once activated, MENU continues its secondary function for activating a selected parameter setting until the radio returns to its normal receive state. This is similar to an enter key.
	The Status key permits the transmission of a pre-programmed status message to an EDACS site.
	The Message key permits the transmission of a pre-programmed message to an EDACS site.
	Serves several purposes depending on the operating mode. In trunked mode, the CLR button exits the current operation and removes all displays associated with it. The radio and display then return to the group receive state. In Conventional mode, pressing this button unmutes the receiver so activity on the selected channel can be monitored. When pressed and held for approximately 3 seconds, this button toggles conventional channel decoding (Channel Guard, Digital Channel Guard, T99) ON and OFF if programmed for the selected channel.
	
	Used to place telephone calls through the radio by selecting the interconnect special call function. See TELEPHONE INTERCONNECT CALLS for details.
	Used to adjust the current display intensity and the keypad backlight level.
	Used to call an individual or make an all-call by selecting the individual call function. See INDIVIDUAL CALLS for details.
	The Emergency key is used to declare emergencies.
or	
	
ALM	This key toggles the external alarm ON/OFF. The external alarm is used to indicate the radio is receiving an Individual Call. Press the key once to enable external alarm and press again to disable external alarm.
SG1-SG5	This key corresponds to five (5) pre-programmed System/Groups. Pressing a key programmed for SG1 would switch the radio to the pre-programmed System/Group 1. Pressing a key programmed for SG2 would switch the radio to the pre-programmed System/Group 2, etc.
WAIL, YLP, RST, SL1-SL8	The WAIL and YLP (Yelp) keys are designed to control an optional Siren package. The SL1-SL8 (Siren/Light) keys are designed to control an optional Siren/Light package. The RST (Reset) key is used to turn all sirens and lights OFF.
SPK	This key function is used to toggle the external speaker ON/OFF.

STO-ST9	The status 0-9 keys are used to send a pre-programmed status message to the EDACS site.
PVT	The PVT key enables or disables Private Mode for the System/Group displayed. See the Private Operation section.
KEY	Displays the Encrypted Keys. This selects the DISP KEY operation from the menu functions.
G*	This key function is used in Conventional Mode to send G-STAR emergency signaling.
PA	This key function enables and disables the Public Address feature.
#	DTMF keypad function.
1 thru 9	Keypad numbers.
*	DTMF Keypad function.

7.7.4 Primary Functions (Quick Access)

The secondary function of the  button is to toggle the keypad buttons between their primary function and their secondary function. When the secondary keypad is active, i.e. entering phone digits for an interconnect call, the  button can be used to toggle the keypad buttons back to their primary function, perform a task (siren/light enable), and then toggle back to finish entering the digits for the phone number. **PRIMARY** is displayed when the  button is used to toggle the keypad keys back to their primary functions. This provides quick access to the primary functions of the keypad. This is a programmable feature of the  button only. Careful consideration should be given to possible operational conflicts before enabling this feature.

Several keys on the Scan version have a secondary function. The  key is the SELECT secondary function with the  key remaining the same for the secondary function. On the System version, the  has a secondary function for DELETE,  is SELECT, and  retains its CLEAR function.

8 DISPLAY

The radio's display is shown in Figure 8-1. The two character lines are used to display system, group and channel names and also operational messages. Each line contains eight alphanumeric character blocks. See Figure 6-2 for a typical display.

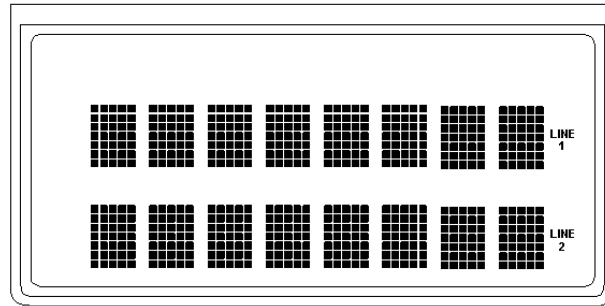
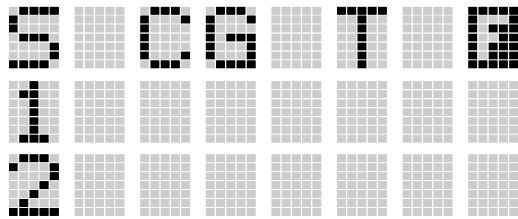

Figure 8-1: M7100^{IP} Series Mobile Radio Display

8.1 RADIO STATUS ICONS

Status icons are indicators that show the various operating characteristics of the radio. The icons appear on the first line of the display.



	<ul style="list-style-type: none"> • indicates selected group or channel is in scan list.
	<ul style="list-style-type: none"> • indicates selected group or channel is programmed as Priority 1 in scan list.
	<ul style="list-style-type: none"> • indicates selected group or channel is programmed as Priority 2 in scan list.
	<ul style="list-style-type: none"> • indicates conventional channel enabled with Channel Guard function.
	<ul style="list-style-type: none"> • indicates the EDACS system is in Failsoft™ mode (if enabled through programming).
	<ul style="list-style-type: none"> • indicates Type 99 Decode is enabled on a conventional channel.

8.2 MESSAGES

During radio operation, various messages are displayed on either line 1 or line 2. Typical messages include control channel status information, such as system busy or call denied, or messages associated with the radio's operation, (i.e. volume adjust). These messages are described as follows:

Table 8-1: Display Messages

MESSAGE	NAME	DESCRIPTION
QUEUED	Call Queued	Trunked mode only. Indicates the system has placed the call in a request queue.
SYS BUSY	System Busy	Trunked mode only. Indicates the system is busy, no channels are currently available, the queue is full or an individual call is being attempted to a radio that is currently transmitting.
DENIED	Call Denied	Trunked mode only. Indicates the radio is not authorized to operate on the selected system.
CC SCAN	Control Channel Scan	Trunked mode only. Indicates the control channel is lost and the radio has entered the Control Channel Scan mode to search for the control channel.
WA SCAN	Wide Area Scan	Trunked mode only. Indicates the control channel is lost and the radio has entered the Wide Area Scan mode to search for a new system (if enabled through programming).
TALKARND	Talk-around	Conventional mode only. Indicates the radio is operating on conventional channels in talk-around mode (no repeater).
RXEMER	Receive Emergency	Trunked mode only. Indicates an emergency call is being received. This message will be flashing on line 2.
TXEMER	Transmit Emergency	Trunked mode only. Indicates an emergency call has been transmitted. This message will be flashing on line 2.
VOL=31	Volume Level	Indicates the current volume level. The volume level display ranges from OFF (silent) to 31 (loudest).
UNKNOWN	Caller's ID Not Received	Indicates that an individual call is being received, but the caller's ID was not received.
TX DATA	Transmit Data	Trunked mode only. Indicates the radio is transmitting a data call.
RX DATA	Receive Data	Trunked mode only. Indicates the radio is receiving a data call. Displayed on line 2.
DATA OFF	Data OFF	Trunked mode only. Indicates the radio is in the data disabled state. Displayed on line 1.
DATA ON	Data ON	Trunked mode only. Indicates the radio has been toggled to the data enable state. Displayed for two seconds on line 1 when toggled to enable state.
SYSC ON	System Scan Features ON	Trunked mode only. Indicates the System Scan features are enabled.
SYSC OFF	System Scan Features OFF	Trunked mode only. Indicates the System Scan features are disabled.
T99 ON	Type 99 Decode ON	Conventional mode only. Indicates the Type 99 Decode feature is enabled.
T99 OFF	Type 99 Decode OFF	Conventional mode only. Indicates the Type 99 Decode feature is disabled.
PA ON	Public Address ON	Indicates that the public address function of the radio is enabled.
PA OFF	Public Address OFF	Momentary (2 seconds) indicates that public address function of the radio was disabled.
ALRM ON	External Alarm Enabled	Indicates that the external alarm function of the radio is enabled.
ALRM OFF	External Alarm Disabled	Momentary (2 seconds) indicates that the external alarm function of the radio was disabled.
PVT DIS	Private Mode Disabled	Indicates that private mode is disabled or no encryption key has been programmed for the selected group/channel or special call.
FRCD PVT	Forced Private Operation	Indicates that forced private operation has been pre-programmed into radio.

MESSAGE	NAME	DESCRIPTION
NO KEY #	Encryption Key Missing	Flashing indicator indicates that no encryption key or an incorrect encryption key is programmed into the radio.
BCKL=1-6	Backlight	Indicates the display intensity and keypad backlight level.
GR	Group ID	Indicates that the call is a group call and is followed by the GID of the caller (trunked mode only).
ID	Individual ID	Indicates the call is an individual call and the ID number of the caller, example "ID 2725" (trunked mode only).
WHC=1	Who Has Called	This display indicates the number from the <i>Who Has Called</i> list. Individual calls received but not responded to are stored in a <i>Who Has Called</i> list. This list is accessible by pressing the # key and then the INDV key after the Individual call has timed out or the Clear button is pressed. This display is on line 2 and the LID of the caller is displayed on the top line. Currently the list is not implemented and the display will always be WHC=1.
PHONE	Phone Call	Displayed when a phone call is received from the site. It is displayed in line 1 of the display. Line 2 of the display will contain the display *INDV* when line 1 contains this message. The radio interprets a received phone call as an individual call.
CONV FS	Conventional Failsoft	Displayed when a failure of the EDACS system occurs. All communication will be in conventional mode (trunked mode only).
MENU		Displayed when the menu key is pressed and remains displayed in line 1 until a menu item is selected.
SYS=1-64	System = 1 - 64	The system number for the current base station of the system displayed in line 1. It is displayed in line 2 of the display. Press the system key to obtain this display.
GRP=1-64	Group = 1 - 64	The group number of the group displayed in line 2 of display. It is displayed in line 1 of the display. Press the group key to obtain this display. There are up to 48 groups available (i.e. 3 banks of 16). The maximum number of groups programmed in a radio is determined by the personality.
INDV=1-99	Individual = 1 - 99	Indicates which item in the individual call list is being displayed. It is displayed in line 2 of the display. The name or ID of the item in the list is displayed in line 1 of the display.
PHN=1-99	Phone = 1 - 99	Indicates which item in the phone list is being displayed. It is displayed in line 2 of the display. Line 1 of the display will be the last 3 characters of the list item contents.
SEL PHN	Select Phone	After pressing the PHN key, selecting an entry from the phone list by typing the entry number will display this message on Line 1.
SEL INDV	Select Individual ID	Displayed on line 1 when an entry from the individual ID list is selected after pressing the INDV key. The entry is a number between 1 and 32 inclusive (trunked mode only).
SYS ALL	System All Call	Displayed on line 1 to indicate a system all-call has been received (trunked mode only).
Ggg-v.vv	Code Group and Revision Number	This is code group and revision number that is displayed in line 2 when the menu item "REVISION" is selected. The 'gg' is the group number of the software. The first 'v' is the hardware version and 'vv' is the revision of the software.
PHONE	Phone Call	Displayed when an initiated phone call is in progress. This is displayed on line 2 of the display.
DUAL	Dual Control Operation	Displayed on an idle control unit when configured as dual control operation.
NO ENTRY		Indicates that there is no data stored in one of the programmable items in either the phone list or individual call list. The user programmable items are items 1 through 10 in each list.
INV SYS	Invalid System	Displayed when the current system is an invalid type.
CHN=1-99	Channel = 1 - 99	Displayed on line 1 of the display. This is a conventional channel index displayed when the group key is depressed.
FIX LIST	Fixed List	The Priority scan list is fixed and cannot be changed using the add or delete keys.
FIXED P1	Fixed Priority 1	The Priority 1 scan channel is fixed and cannot be changed using the add or delete keys.

MESSAGE	NAME	DESCRIPTION
(c) 2004		Displayed in line 2 when the message 'M/A-COM' is displayed in line 1 while displaying different items under the menu when "REVISION" is selected by the operator.
EM	Emergency	Indicates an emergency has been declared by the LID that follows the display, "EM." An example of this is "EM 01201."
INDV	Individual Call	Displayed in line 2 of the display when an individual call is in progress (trunked and T99 modes only).
GROUP	Group Call	Indicates a group call is in progress and is displayed on line 1 of the display (trunked and T99 modes only).
SPKR ON	External Speaker ON	Displayed when the external speaker is enabled.
SPKR OFF	External Speaker OFF	Displayed when the external speaker is disabled.
BANK=1-8		The bank of keys that are going to be loaded when the keyloader loads encryption keys. This is only valid for radios that support VGS, VGE, or DES encryption. It is displayed on line 2 of the display when the encryption keyloader is connected.
REGR_0x	Dynamic Regroup	Indicates which group in the dynamic regroup operation has been enabled, where "x" is a digit of 1 to 8 (trunked mode only).
KEY LOAD		Displayed on line 1 of the display when the encryption keyloader is connected.
KEY ZERO		Displayed on line 2 of the display when the reset and option buttons are pressed simultaneously for approximately two seconds. The encryption keys are zeroed.
SYS KEY	System Key	Displayed on line 1 of the display in the display key mode of the menu. It is followed in the second line with a key number "KEY = <1..7>".
GRP KEY	Group Key	Displayed on line 1 of the display in the display key mode of the menu for trunked systems only. It is followed in the second line with a key number "KEY = <1..7>."
CHN KEY	Channel Key	Displayed on line 1 of the display in the display key mode of the menu for conventional systems only. It is followed in the second line with a key number "KEY = <1..7>."
KEY=1-7		Displayed on line 2 of the display in the display key mode of the menu for conventional systems when the "SYS KEY" or "CHN KEY" is displayed in line 1 and for trunked systems when the "SYS KEY" or "GRP KEY" is displayed in line 1.
PRIMARY		Displayed on line 1 of the display when the primary keys are enabled.
PRS NAME	Personality Name	Displayed on line 1 of the display under the revision selection of the menu. The personality name is displayed on line 2 at the same time.
M/A-COM		Displayed on line 1 of the display under the revision selection of the menu. The copyright year is shown in line 2 of display at the same time "(c) 2004."

9 ALERT TONES

The M7100^{IP} Series mobile radio also provides audible alert tones or "beeps" to indicate the various operating conditions. These alert tones can be enabled or disabled through programming.

9.1 CALL ORIGINATE

A short mid-pitched alert tone sounds after keying the radio (Push-To-Talk button is pressed). This tone indicates the radio has been assigned a working channel or that the radio is transmitting on a conventional channel and voice communication can begin immediately. In conventional mode, this tone may be delayed after the PTT button is pressed due to G-STAR™ signaling (if enabled through programming).

9.2 AUTOKEY (TRUNKED MODE ONLY)

After being placed in a queue or releasing the PTT button prior to a working channel assignment, the site calls the radio when a channel becomes available. At this point, the radio automatically keys the transmitter (autokey) for a short period to hold the channel. The radio sounds a mid-pitched tone when it is clear to talk. Immediately press the PTT button to keep the assigned channel.

9.3 CALL QUEUED (TRUNKED MODE ONLY)

A high-pitched tone after pressing the PTT button indicates the system has placed the call request in the queue. The receiving unit(s) also hear(s) the tones to indicate they will receive a call shortly. If the PTT button is released, the radio will autokey whenever a channel becomes available (see Autokey).

9.4 SYSTEM BUSY (TRUNKED MODE ONLY)

Three low-pitched beeps will be heard if the radio is keyed when the system is busy, if no channels are available for sending the message, if the call queue is full, or if an individual call is being attempted to a radio that is transmitting. Releasing the PTT button and re-keying initiates a new channel request.

9.5 CALL DENIED (TRUNKED MODE ONLY)

If the radio is keyed and a low-pitched tone is heard, the radio is not authorized on the system that has been selected.

9.6 CARRIER CONTROL TIMER

If the programmed time for continuous transmission is exceeded, the radio will issue five short high-pitched warning tones followed by a long low-pitched tone. The transmitter will shut down shortly after the alert, interrupting communications. Release and re-key the PTT button to maintain communications. This will reset the carrier control timer and turn the transmitter back on.

9.7 KEY PRESS ALERT

A short tone or "beep" will sound to indicate a key has been pressed. A short low-pitched tone indicates no action was taken because the key is not active in the current mode.

9.8 DUAL CONTROL SWITCHING

When control is switched to a previously idle control unit, two short high-pitched tones will sound at the control unit where the PTT was pressed (now the active controller).

10 OPERATION

The M7100^{IP} Series mobile radio unit can be programmed to operate in a trunked system, a conventional system, a Project 25 (P25) conventional system, or any combination of the three. Operating features and functions have been grouped according to the type of system the radio is operating in. This section contains general operating procedures (e.g., Turning the Radio On). Section 11, **TRUNKED MODE OPERATION**, covers those operating procedures that are only used in a trunked system (e.g., Group Scan). Section 12, **CONVENTIONAL MODE OPERATION**, covers those operating procedures that are only used in a conventional system (e.g., Squelch Adjust). Section 13, **PROJECT 25 (P25) CONVENTIONAL OPERATION**, covers those operating procedures that are only used in a P25 conventional system. Section 14, **TRUNKED OR CONVENTIONAL MODE OPERATION**, covers those operating procedures that can be used in either a trunked or a conventional system (e.g., Multiple Radio Operation).

10.1 TURNING THE RADIO ON

Rotate the **POWER ON-OFF/VOLUME** knob clockwise, out of detent to turn the radio on. A short beep (if enabled through programming) indicates the radio is ready for operation. The display indicates, if programmed, the last selected system name on line 1 and the last selected group or channel name on line 2.

In the EDACS trunked environment, if communication with the system's control channel cannot be established, the **CC SCAN** message will be displayed. This can occur if, for example, the radio is out of range of the trunking site. It may be necessary to move to another location or select another trunking system to re-establish the control channel link for trunked mode operations.

10.2 SELECTION MODE RULES

Many operations require selection from a list such as system, group or phone number. This selection process is handled in the same manner for all lists. The RAMP controls, \triangle and ∇ , **SEL**, **0-9**, *****, **#**, the **DEL** button, and the **CLR** button are used during the selection process. The following example systems list is used to explain the process:



NOTE

The hookswitch functions the same as the **CLR** key in I-Call, phone call, and menu modes.

<u>SYSTEM</u>	
1	NORTH
2	SOUTH
3	EAST
4	WEST

After entering a selection mode, the following generic display format will appear:

X X X X X X X X
Y Y Y = Z Z Z

Line 1 shows the currently selected item name (XXXXXXXX) from the list. Line 2 indicates the list (YYY) that the selection is to be made from and the number of the selected item (ZZZ) within the list. (In some cases the information on lines 1 and 2 will be exchanged.) Enter the system selection mode by pressing the **sys** key. If SYSTEM 2 is the current selection, the display appears as follows:

```
SOUTH
SYS = 2
```

Line 1 contains the current system name, SOUTH; and line 2, SYS = 2, indicates that selection is from the system list and it is the second system within the list.

A new system from the list is selected by using the RAMP control, \triangle or ∇ , or by directly entering the system number with the numeric keys. The RAMP controls, \triangle or ∇ , scroll through the list in increasing and decreasing order. In the previous example, pressing the RAMP control \triangle selects the EAST system as shown in the next display.

```
EAST
SYS = 3
```

The radio can be programmed to wrap around from one end of a list to the other end or to stop at the ends.

10.3 DIRECT ACCESS

To directly access a selection, enter the corresponding number (e.g. 4) followed by **SEL** to activate the selection. The entered number is displayed on line 2 as shown below. Line 1 shows the current list being used for selection.

```
SEL SYS
4
```

If a mistake is made while entering the number, press the **DEL** button to backspace once and correct the entry. If an invalid number is entered, a short low-pitched tone sounds when **SEL** is pressed.

To exit the selection mode, press the **CLR** button or wait for the time-out. If the selection mode is cleared while an entry is pending (i.e., numbers are entered on line 2, but **SEL** has not been pressed), the entry on line 2 will be disregarded and the previous selection will remain active. If the time-out activates while an entry is pending, the entry on line 2 will be selected if it is within the valid range; if it is out of range, the entry on line 2 will be disregarded and the previous selection will remain active.



NOTE

While in system, group or channel selection mode, the radio continues to receive calls normally and continues scanning, if it is enabled. If a call is received during the selection mode process the radio will return to the normal receive mode display. Continuing with the selection process will return the display to the same point in the selection process if the selection mode time out has not yet expired. Any press of the PTT button during the selection mode process will initiate transmission and exit the selection mode.

10.4 MENU

The menu function accesses features that are not available directly from the keypad. The order and specific number of menu items available is configurable through programming. Upon radio power up, the menu item at the beginning of the menu list will always be displayed first. Subsequent access to the menu function will return the last menu item that was shown in the display. To enter the menu mode, press **MENU**.

The RAMP controls, \triangle and ∇ , the **SEL** and the **CLR** buttons are used during the selection process. All of the selection mode rules previously detailed apply to the menu item selection process with the exception of direct access. The radio will continue to receive and transmit normally while in the menu function.

A new item is displayed by using the RAMP controls, \triangle and ∇ , to scroll through the list in increasing and decreasing order. The displayed menu item is made active by pressing **SEL**.

After entering the menu selection mode, the following generic display format will appear.

M E N U
Y Y Y Y Y Y Y Y

Line 1 indicates the radio is in the menu selection mode. Line 2 indicates the menu item (YYYYYYYY) that is to be viewed or changed (some menu items provide radio information and do not have changeable parameters).

An example of the menu item selection process and menu item parameter change is detailed below for the backlight menu item.

PRESS: 

The menu mode is entered.

PRESS: The RAMP controls, \triangle or ∇ , until the display shows:

M E N U
B C K L G H T

PRESS: **SEL**

The backlight menu item is activated and the display will be similar to the following:

B C K = X X X
Y Y Y Y Y Y Y Y

Line 1 shows the active menu item and its current parameter setting (XXX). Line 2 shows the currently selected system or group name (YYYYYYYY).

The menu item's parameter setting shown in the display can now be changed by using the RAMP controls, \triangle and ∇ , to scroll through the list of parameter values. Once the desired setting is reached press **SEL** to store the value and return to the normal display. For menu items that display radio information, pressing \triangle and ∇ will scroll through a list of informational displays. The menu items are listed in Table 10-1.

Table 10-1: Menu Item Information

FEATURE	DISPLAY	PARAMETER SETTINGS	COMMENT
Backlight Adjust	Menu Item: BCKLIGHT Once selected: BCKL=	OFF, 1, 2, 3, 4	Selects the light level for backlighting.
Radio Revision Information	Menu item: REVISION	Informational displays only (see radio); no user selectable settings.	Selects the information display to view.
PHONE CALL	Menu item: PHN CALL Once selected: See Telephone Interconnect Call Section		Allows access to the Phone Call Feature.
Individual Call (Trunked Systems Only)	Menu Item: IND CALL Once Selected: See Individual Call Section		Allows access to the Individual Call Feature.
External Alarm	Menu Item: EXTALARM Once Selected: EXTALARM	ON, OFF	EXTALARM replaces the system name on the display as long as the external alarm feature is enabled.
PUBLIC ADDRESS	Menu item: PUB ADDR Once selected: PA ON or PA OFF	ON, OFF	Public Address is toggled ON and OFF.
EXTERNAL SPEAKER	Menu item: EXT SPKR Once selected: SPKR ON or SPKR OFF	ON, OFF	External Speaker is toggled ON and OFF.
Encryption Key Loading	Menu item: KEYLOAD Once selected: KEY LOAD BANK = N	Up to 8 banks of 7 keys	Enables the radio to accept the loading of encryption keys.
Display Current Encryption Key(s)	Menu item: DISP KEY Once selected: SYS KEY, GRP KEY or CHN KEY and KEY = N		Displays current encryption key number.
Front Panel Squelch Adjust (Conventional Only)	Menu item: SQUELCH Once selected: SQLCH=xx	1-16	Allows setting of squelch.
Scan	Menu item: SCAN	ON, OFF	Toggles scan function ON or OFF.
Private Mode	Menu Item: PRIVATE Once selected: PVT or key light.	ON, OFF	Toggles private function ON or OFF.
Scan Add	Menu item: SCAN ADD Once selected: Proper scan icon displayed .	S, 2 or 1	Adds group or channel to scan list.
Scan Delete	Menu item: SCAN DEL Once selected: Scan icon goes out.		Deletes group or channel from scan list.
Scan Add/Delete	Menu item: SCAN A/D When selected: Toggles through scan selections	Toggle sequence S, 2, 1, S, ...	Changes present group or channel to next scan choice in scan list.

FEATURE	DISPLAY	PARAMETER SETTINGS	COMMENT
Home group or channel selection	Menu item: HOME Once selected: Home group or channel displayed.		Changes to the group or channel defined for Home function.
System select	Menu item: SYS SEL Once selected: SYS = n	1-64 = (n)umber of desired system	Displays the system selected.
External alarm #2	Menu item: EXTALRM2	ON, OFF	Toggles external alarm #2 feature ON or OFF.
System and group selection	Menu item: SYSGRP 1 Menu item: SYSGRP 2 Menu item: SYSGRP 3 Menu item: SYSGRP 4 Menu item: SYSGRP 5		Changes to the System & Group/Channel programmed for SYSGRP 1-5.
Mute	Menu item: MUTE	ON, OFF	Toggles the mute function ON or OFF to control the audio output from the selected radio.
Mute #1	Menu item: MUTE 1	ON, OFF	Toggles the mute 1 function ON or OFF on radio #1.
Mute #2	Menu item: MUTE 2	ON, OFF	Toggles the mute 2 function ON or OFF on radio #2.
Multiple radio operation	Menu item: RADIO	ON, OFF	Toggles the currently selected radio.
Radio selection	Menu item: RADIO 1	ON, OFF	Changes to radio #1.
	Menu item: RADIO 2	ON, OFF	Changes to radio #2.
No Data (Trunked System Only)	Menu item: NO DATA	ON, OFF	Toggles data feature ON or OFF.
EDACS Conventional Priority 1 Scan (Trunked System Only)	Menu item: ECP1SCAN	ON, OFF	Toggles this feature ON or OFF.
Group selection (Trunked System Only)	Menu item: GRP SEL Once selected: GRP = n	1-64 = (n)umber of desired group	Displays the group selected.
Status Condition (Trunked System Only)	Menu item: STATUS Once selected: ST =n	0-9 = (n)umber of pre-programmed status	Transmits the pre-programmed status message.
Message Condition (Trunked System Only)	Menu item: MESSAGE Once selected: MSG =n	0-9 = (n)umber of pre-programmed messages	Transmits the pre-programmed message.
Talkaround feature (Conventional System Only)	Menu item: TALKARND Once selected: TALKARND on line 1	ON, OFF	Toggles talkaround ON or OFF. (transmit frequency changed to receive frequency)
Channel selection (Conventional System Only)	Menu item: CHN SEL Once selected: CHN = n	1-99 = (n)umber of desired channel	Displays the conventional channel selected.
Feature Encryption Display	Menu Item: FEATURES Once selected: See Feature Encryption Display section	Informational displays only; no user selectable settings	Indicates current features programmed into the radio as well as certain information required to add features to the radio (refer to the Table of Contents for Feature Encryption Display.
System Scan Enable	Menu Item: SYS SCAN Once selected: SYSC ON or SYSC OFF	ON, OFF	System Scan features like ProScan are toggled ON and OFF.
Type 99 Decode Enable	Menu Item: T99 ENAB Once selected: T99 ON or T99 OFF	ON, OFF	Type 99 Decode is toggled ON and OFF.

10.5 FEATURE ENCRYPTION DISPLAY

Feature Encryption Display is available through the menu function and, if programmed, appears in the menu as "FEATURES." This data indicates current features programmed into the radio as well as information required to add features to the radio. This feature applies to 512K RAM radios only.

Once the feature has been accessed, all normal menu functions work. The user can scroll up or down through all of the entries.

Feature Encryption Display provides the ability to view, in the order displayed, the following:

- Serial number ROM data - serial number of the ROM
- Feature encryption data stream - used to enable features
- Number Fields - defines limits
- Features enabled - displays bit fields of enabled features

10.5.1 Serial Number ROM (12 Hex Digits)

Example:

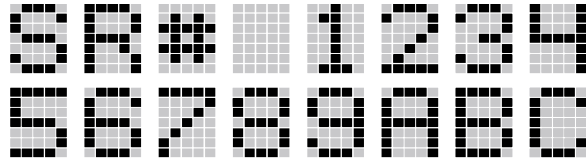

When the user wants to enable a feature in his radio, he will need to call M/A-COM, Inc. They will ask for the ROM serial number. The serial number shown here is for example only.

10.5.2 Feature Encryption Data Stream

Example:

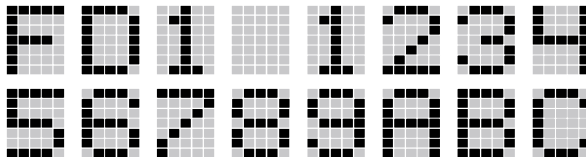

These data streams define the features the user has enabled in his radio and are required by M/A-COM, Inc. to enable other features. The data streams shown here are for example only. **Note:** There are three displays: FD1, FD2, FD3. All three are required.

Number Fields

Example:

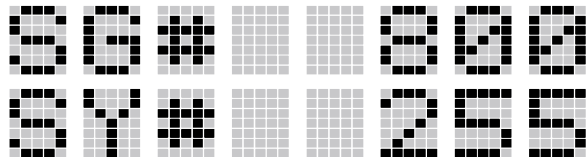

These number fields show the set limits of the of the user's radio as:

- SG# XXX - Maximum number of system/groups combination available
- SY# XXX - EDACS maximum trunked system limit

- CH# XXX - Maximum number of conventional channels available

The user needs to know the limits of his radio before attempting to enable other features. The numbers shown here are for example only.

10.5.3 Features Enabled

These numbers indicate which features are enabled.

Example:

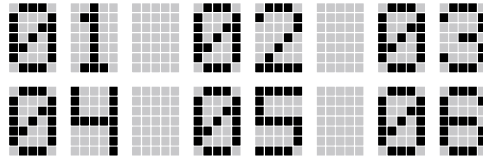







Table 10-2 lists possible features available in the user's radio.





Table 10-2: Available Feature Numbers

FEATURE NUMBER	POSSIBLE FEATURES	STANDARD OR OPTIONAL
01	Conventional Priority Scan	Standard
04	Group Scan (EDACS only)	Standard
05	Priority System Scan (EDACS only)	Optional
06	WAscan/ProSound™/ProScan (EDACS only)	Optional
07	Dynamic Regroup (EDACS only)	Optional
08	EDACS Emergency (EDACS only)	Optional
09	Type 99 Encode	Standard
10	Conventional Emergency	Standard
12	Aegis™ Digital Voice Encryption	Optional
14	DES Encryption	Optional
16	Mobile Data	EDACS – Standard P25 Conventional – Optional
17	Status/Message (EDACS only)	Optional
21	EDACS Security Key (ESK)	Optional
22	ProFile™ (EDACS only)	Optional
23	Narrowband	Standard
29	ProVoice™	Optional
32	FIPS-140-2	Optional
33	P25 Common Air Interface	Optional
34	Direct Frequency Entry	Optional

10.6 SYSTEM/GROUP/CHANNEL SELECTION

In the following description of **SYSTEM/GROUP/CHANNEL SELECTION**, the term group is used for both group and channel.





The M7100^{IP} **SYSTEM/GROUP/CHANNEL** knob and the RAMP controls,  and , are programmable for maximum flexibility. If the SYSTEM/GROUP/CHANNEL knob is assigned to select groups, then the RAMP controls,  and , are assigned to select systems. If the SYSTEM/GROUP/CHANNEL knob is assigned to select systems, then the RAMP controls,  and , are assigned to select groups. System, group, and channel selection is the primary function for these controls.



Either systems or groups can also be selected by entering the select mode and following the selection mode rules described earlier. The system select or group select modes are entered by pressing  or , respectively, from the standard receive mode. Using the RAMP controls,  or , after entering a particular selection mode in this manner is the secondary function of these keys.

10.6.1 System Selection

Several methods, some of which depend on programming, can be used to select a new system. These procedures are presumed to be starting from the normal receive display.

METHOD 1 If system selection is programmed to the SYSTEM/GROUP/CHANNEL knob, select a system by turning the SYSTEM/GROUP/CHANNEL knob to the desired system position. The display registers the new system name on line 1. If the wrap option is OFF and the knob is moved to a position greater than the number of programmed systems, the highest programmed system will remain selected.





METHOD 2 If system selection is programmed as the primary function of the RAMP control  and , select a system by pressing  or  to scroll through the system list. The display registers the new system name on line 1.

METHOD 3 Press  to enter the system select mode and follow the selection mode rules detailed earlier. Press the RAMP controls,  or , to scroll through the systems.

10.6.2 Group and Channel Selection

Several methods, some of which depend on programming, can be used to select a new group or channel. These procedures assume starting from the normal receive display.

METHOD 1 If group selection is programmed to the SYSTEM/GROUP/CHANNEL knob, select a group by turning the SYSTEM/GROUP/CHANNEL knob to the desired group. The display registers the new group name on line 2. If the wrap option is OFF and the knob is moved to a position greater than the number of programmed groups, the highest programmed group will remain selected.

METHOD 2 If group selection is programmed as the primary function of the RAMP controls,  and , select a group by pressing  or , to scroll through the group list. The display registers the new group name on line 2.

METHOD 3 Press  to enter the group select mode and follow the selection mode rules detailed earlier. Pressing the RAMP controls will now scroll through different groups.

11 TRUNKED MODE OPERATION

Digital trunking provides fast communication access at all times, even during busy hours. In this mode, the operator selects a communications system and group and the audio communication or working channel (WC) is allocated through digital signaling with the site.

11.1 RECEIVING A CALL

1. Turn the radio on by rotating the POWER ON-OFF/VOLUME knob clockwise (out of detent). A short alert signal (if enabled through programming) indicates the radio is ready to use.
2. The display shows the last selected or the power up (depending on programming) system and group names. If the radio is unable to obtain a control channel, line 2 shows **CC SCAN**.
3. Adjust the POWER ON-OFF/VOLUME knob to the desired volume level.
4. Select the desired system and group. The display indicates the current system and group names.
5. The radio is now ready to receive calls.
6. When the radio receives a group call, it unmutes on the assigned working channel and the **BSY** indicator comes on. Line 1 shows **GR** followed by the logical ID number (if received) of the unit sending the message, or the associated name if the ID number is found in the individual call list.

11.2 SENDING A CALL

1. Turn the radio on and set the POWER ON-OFF/VOLUME knob to the desired volume level. Select the desired system and group.
2. Press and hold the PTT button. The radio will display the system and group names and perform the necessary signaling required to obtain a communication channel.
3. When the working channel is assigned, **TX** and **BSY** indicators are turned ON and a short beep is sounded indicating communication can begin.



NOTE

If two or more tones, or a high-pitched tone is heard, the system may be busy and the call request has been placed in queue or the request has been denied for some reason. Refer to the Section 9 for more details.

4. Hold the microphone approximately three inches from the mouth and speak in a normal voice.
5. Release the PTT button when the transmission is complete and listen for a reply.

11.3 CONVENTIONAL FAILSOFT

In the unlikely event of a failure of the EDACS system, communications can take place in conventional failsoft mode. The radio will be automatically directed to a communications channel set up for this purpose. During this mode of operation, the control unit will display **CONV FS** in the alphanumeric display. An increase in activity on the channel during conventional failsoft operation may be noticed, so be careful not to transmit until the channel is clear.

Operation during conventional failsoft will be the same as operation on a conventional system, except that it will not be possible to select a communications channel, or use emergency and special call. When trunking is restored, the radio will automatically be returned to normal operation.



NOTE

Emergency and Special Call are not operational during conventional failsoft. In addition, the  control will not operate.

11.4 EMERGENCY OPERATION



The radio's ability to declare an emergency, clear an emergency, remain locked on an emergency and group, and the emergency audio and display freeze can each be enabled or disabled through programming. When an emergency is declared scanning will stop and will restart only after the emergency has been cleared.

11.4.1 Receiving an Emergency Call

When receiving an emergency call from the selected group and system, an alert beep is heard and the **BSY** indicator lights. The message ***RXEMER*** flashes in the display on line 2 until the emergency condition is cleared. Follow standard emergency procedures.

11.4.2 Declaring an Emergency

To send an emergency call to the selected system and group (or on an optionally pre-programmed emergency group), proceed as follows:

1. Press and hold the red  or "E" emergency button for approximately one second. (This time is programmable and therefore could be longer or shorter. Check with the system administrator.) The radio will transmit an emergency call request with the radio ID until an emergency channel assignment is received.
2. When the working channel assignment is received, the radio sounds a single beep (Autokey alert tone) indicating it is ready for voice transmission. ***TXEMER*** flashes on line 2 in the display until the emergency is cleared.
3. Press PTT and speak into the microphone in a normal voice.
4. Release PTT when the transmission is complete and listen for a reply.
5. The emergency can be cleared by pressing and holding the  button followed by pressing the  or "E" emergency button then releasing both buttons.

11.5 SYSTEM SCAN OPERATION

The radio can be programmed with the following System Scan features. These features are automatically enabled upon radio power up. A key or menu option is also defined to allow the System Scan features to be toggled during radio operation. This is covered in the Menu Selection and Pre-Programmed Keypad Key sections. The System Scan state will be maintained through system changes but will default to ON at power up.

11.5.1 Wide Area System Scan

The M7100^{IP} Series mobile radio can be programmed for wide area system scan operation for multi-site applications. Upon the loss of the currently selected system's control channel, radios can be programmed to automatically scan the control channels of other systems. If a new control channel is found, the radio will switch to the new system and sound an alert tone.

11.5.2 ProScan

The radio can be programmed for ProScan™ system scan operation for multi-site applications depending on the version of radio flash code. ProScan provides the radio with the ability to select a new system for the radio to communicate on, when the selected system drops below a predefined level. This is accomplished by enabling each radio to analyze the signal quality of its current control channel and compare it with the signal quality of the control channel for each site in its adjacency scan list. (The signal quality metric used for the ProScan algorithm is based on a combination of both Received Signal Strength Indicator [RSSI] and Control Channel Verification [CCV] measurements.) When the selected system's signal quality level degrades below a pre-programmed level, the radio will begin to look for a better control channel. Once a control channel that exceeds the pre-programmed parameters is found, the radio will change to the new system and emit a tone. If the control channel is completely lost the radio, will enter Wide Area System Scanning and search the programmed adjacent systems until a suitable control channel is found.

11.5.3 Priority System Scan

The radio can also be programmed for Priority System Scan. (To ensure that this feature operates correctly, the control channel of the priority system must be located on channel one unless you are using the ProScan algorithm.) The priority system is the desired or preferred system. While receiving the control channel of the selected system, the radio will periodically leave the selected system and search for the control channel of the priority system at a programmable rate. The programmable rate is defined by the value in the Priority Scan Time control, (unless the ProSound/ProScan algorithm is enabled as explained below). This priority scan timer is reset each time the PTT button is pressed or when a call is received. If the priority system control channel is found, or meets the predefined ProScan criteria, the radio will automatically switch to the priority system.





11.5.4 When Wide Area System Scan Is Enabled

If the radio cannot find the control channel of the selected system and begins Wide Area System Scan (WA Scan), the radio will only scan for the priority system control channel if the priority system is in the WA Scan list.

11.5.5 When ProScan Is Enabled

The radio monitors the priority system and will switch to the priority system if the priority system meets the criteria defined in the "ProSound/ProScan Options" dialog box. If ProScan is enabled, the rate at which the radio will scan for the priority system is defined by the System Sample Time control.

11.5.6 Menu Selection

Press  and then use the RAMP controls,  and , to scroll through the selections until **SYSC SCAN** is displayed. Then press  to toggle the System Scan state. The **SYSC ON** or **SYSC OFF** display message is displayed for two seconds to show the new state.

11.5.7 Pre-Programmed Keypad Key

Press the pre-programmed key and the **SYSC ON** or **SYSC OFF** display message is displayed for two seconds to show the new state.

11.6 GROUP SCAN OPERATION

Only Groups that are part of the radio's scan list will be scanned. Groups are added to the scan list on a per system basis through programming, the radio keypad, or both, dependent upon programming. This scan list can be changed by the user from the keypad unless programmed otherwise. Each system's group scan list is retained in memory when the radio is turned off. The M7100^{IP} Series mobile radio can also be programmed to provide Trunked Priority Group Scan capability, which operates similar to priority scan in Conventional mode.

The following is a description of programmable scan features that should be helpful in understanding the Group Scan Operation of the radio:

Scan Hang Time - the delay time the radio waits before resuming scan after the push-to-talk is released or after the carrier has dropped a channel.

TX Select - the group the radio will transmit on while scanning. The radio is programmed to transmit on either the scanned group or the selected group.





Scan List (privileges) - this feature allows or prohibits scan list changes by the user.

PI Programming - priority group programming is accomplished by one (and only one) of three methods:

- From the keypad, where the Priority programming is not fixed and does not follow the selected channel,
- Priority 1 group programming follows the selected channel, or
- Priority 1 group programming is fixed during PC programming and cannot be changed by the user.



PI Always Scan - determines if the Priority 1 Group will always be scanned, regardless of the scan state set by the user.

11.6.1 Adding Groups to a Scan List

1. With scan operation turned off, select the desired group to add to the selected Trunked system group scan list.
2. Press  or  on the SCAN add/delete control. The current priority status of the group will be displayed in column 1 of line 1 for a time-out period. If the group is not part of the scan list the status will be blank.
3. While the status is displayed, press  to add the group to the scan list. "S" is displayed in column 1, line 1.
4. Press  a second time to set the group to Priority 2. A "2" is displayed in column 1, line 1.
5. Press  a third time to set the group to Priority 1. A "1" is displayed in column 1, line 1. The priority level selection sequence only advances the group to next higher priority level and stops at priority level 1. To select a lower priority level, the group must be deleted from the scan list and then added back to the scan list. Each new group added to the scan list starts at the lowest priority. If the Priority 1 and Priority 2 groups are already set and a new group is assigned as Priority 1 or Priority 2, the previously assigned group will change to non-priority scanning.

11.6.2 Deleting Groups from a Scan List

1. With scan operation turned off, select the desired group to delete from the selected trunked system's group scan list.

2. Press  or  on the SCAN add/delete control. The current status of the group is displayed for a time-out period.
3. Press  to delete the group from the scan list. "S", "2" or "1" turns off. Any group that is not in a trunked system group scan list will show a "blank" for the time period when it is the selected channel.

11.6.3 Nuisance Delete

A group can also be deleted from the scan list, if it is not the currently selected group, by pressing  during scan operation while the radio is displaying the unwanted group. The group will be deleted from the system's group scan list in the same manner as if done using the steps above. Deletions performed in this manner will not remain deleted if the radio is turned off and then back on.

11.6.4 Turning Scan On

1. Toggle scan operation by pressing . The SCAN indicator will turn on when the radio is scanning.



NOTE

The  key light will blink when temporarily disabled. Scanning will stop while microphone is off-hook if the hookswitch feature is enabled through programming.

2. When a group on the scan list receives a channel assignment, the radio unmutes on the assigned channel, the **BSY** indicator comes on and the received scan group is displayed.
 - The radio will continue scanning if a new group is selected when scan is on.
 - Pressing the PTT button when scan is on will cause the radio to transmit on the displayed group or on the currently selected group depending on programming.
 - Pressing  when scan is on will cause the radio to recall the scanned group that was last received. This group is recalled for a period equal to the scan hang time.

11.6.5 Priority Group Scanning

When scan is enabled and the Priority 1 and Priority 2 groups have been identified, the radio will listen to calls on those groups and the selected group. While receiving a scanned group call, the radio will continue to monitor the selected Priority 1 and Priority 2 groups and will drop the call if the selected group or other higher priority call becomes active. During a Priority 2 call the radio will continue to monitor for a Priority 1 group call.

The radio will monitor for Agency and Fleet calls that correspond to the Agency and Fleet associated with the Priority 1 and Priority 2 groups. Priority Agency and Fleet calls will be indicated by displaying **AGENCY** or **FLEET** on the System line of the display and associated Priority 1 or 2 group on the Group line of the display.

11.6.6 Turning Scan Off

Toggle scan operation off by pressing . The radio will resume operation on the selected group.

11.7 INDIVIDUAL CALLS

11.7.1 Receiving and Responding to an Individual Call

When the radio receives an individual call (a call directed only to the user's radio), it unmutes on the assigned working channel and turns on the **BSY** indicator. Line 1 shows "ID" followed by the logical ID number of the radio sending the message, or the associated name if the ID number is found in the individual call list. The individual call indicator will display ***INDV*** on line 2. The radio can be programmed to ring when an individual call is received. If enabled, the ring begins five seconds after the caller unkeys and will continue until the PTT button, the **CLR** button, or **IND** is pressed.



NOTE

Hookswitch functions the same as **CLR** key in I-CALL, phone call, and menu modes.

If a response is made to the call prior to the programmed call-back time-out, the call will automatically be directed to the originating unit. If a response is not made before the call-back time-out, the radio will return to normal receive mode, but ***WHC*** will be displayed. If the caller's ID is not received, **UNKNOWN** will display for the duration of the call and there will be no call-back hangtime.

To respond after the call-back time-out, press the **IND** key. The radio's display will show the callers ID on the first line and **WHCI=1** on the second line. Pressing the PTT button at this point will initiate an individual call back to the original caller. (If the last call was a group call, the display will show **WHCG=1**. Pressing the PTT button will place the call as an individual call.)

The radio stores the IDs of the last 10 callers in the Calls Received List as shown. Individual calls are stored in the top half of the list (1-10) and group calls are stored in the bottom half of the list (1-10). The most recent call is stored in position 1, the second most recent call is stored in position 2, etc.

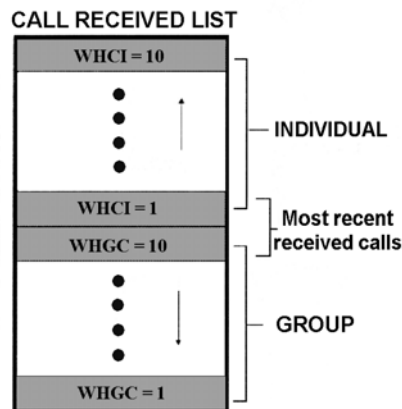

To access the list, press the **IND** key twice. Use the \triangle or ∇ keys to scroll through the list. Pressing the **MENU** key will display the time elapsed since the call was received.

11.7.2 Call Storage Lists

There are two lists available for call storage in the radio, the calls received list (1-10) and the personality list (1-99 as defined by the user). When the individual call mode is entered by pressing **IND**, the calls received list is available. The user can toggle to the personality list by selecting any key other than **DIS** or toggle between the two lists by pressing the **IND** key. If wrap is enabled, the calls received list wraps on itself and not into the other list.

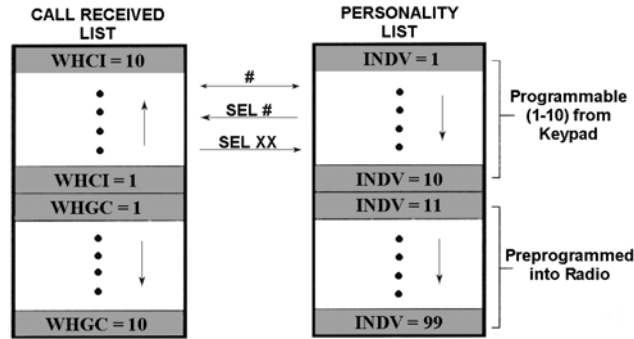

The saved call list shows all ten storage locations. If no calls have been received, the saved call list will be empty and the pre-stored list will be available upon entering the individual call mode.

When in the saved call list, pressing **MENU** toggles the time stamp ON and OFF. The time stamp indicates how long ago the call was received. The display indicates this information as HH:MM:SS where HH = hours, MM = minutes and SS = seconds.

When in the pre-stored list, pressing **MENU** toggles the Logical IDentification (LID) ON and OFF.

11.7.3 Sending An Individual Call

The following procedures describe how to initiate and complete an individual call.

- To select a previously stored individual, select the I-Call mode from the menu or press **IND** followed by the RAMP control \triangle or ∇ to scroll through the list of stored individuals. The selection mode rules apply. While in the individual call list, the menu key will toggle the display between the call name and the unit ID number. If the individual is not stored in this list but the individual's unit ID is known, it can be entered directly from the keypad.
- Press the PTT button; the radio performs the necessary signaling to obtain a communication channel. When the signaling is complete and the radio is clear to transmit, **TX** indicator turns ON and the channel access tone sounds. Line 1 shows the called individual's name if found in the list of stored individuals or ID followed by the logical ID number of the unit being called. The message ***INDV*** displays on line 2. Proceed with the message.

11.8 SCAT OPERATION

A SCAT™ (Single Channel Autonomous Trunking) System operates with the same set of features as a standard EDACS system. The only significant user change relates to the **BSY** indicator. Since only one channel, operating as both control and working channel, exists in a SCAT System, the **BSY** indicator will be ON when the SCAT channel is in the working channel mode. When the transmission on the channel is completed, the indicator turns OFF and indicates the return of SCAT control channel signaling.







11.9 TELEPHONE INTERCONNECT CALLS

11.9.1 Receiving a Telephone Interconnect Call (Trunked Mode Only)

Receiving a telephone interconnect call is identical to receiving an individual call. See the DTMF Overdial Operation section if access to services requiring "over-dial" is needed. Overdial operations are available for any special call whether it is an individual call or a telephone interconnect call.

11.9.2 Sending a Telephone Interconnect Call (Trunked Mode Only)

Use the following procedures to initiate and complete a Telephone Interconnect call:

1. To select a previously stored phone number, select phone call mode from the menu, press  and use the RAMP controls,  or , to scroll through the list of stored phone numbers. The selection mode rules apply. While in the phone call list, the  key will toggle the display between the phone call name and the phone call number. If the phone number is not stored in this list but the phone number is known, it can be entered directly from the keypad. If necessary, a pause can be entered by pressing and holding **0-9**, *****, or **#** until an underscore appears in the display.
2. Press and release the PTT button; the radio performs the necessary signaling to obtain a communication channel. When the signaling is complete and the radio is clear to transmit, **TX** indicator turns on and the channel access tone sounds. Line 1 shows the accompanying name if selected from the list of stored numbers or the phone number if entered directly. The message ***PHONE*** is displayed on line 2. The radio then automatically transmits the programmed number stored in the special call queue.
3. Telephone ringing will be heard. When someone answers the phone, press the PTT button and speak into the microphone. Release the PTT button to listen to the caller. Unsuccessful interconnect signaling returns the radio to the normal receive mode and the number remains displayed until the special call is cleared by pressing the  button or the time-out expires or another group or system is selected.
4. To terminate the call, momentarily press the  button.



The M7100^{IP} Series mobile radio is capable of half-duplex conversation only. The caller's message can only be sent if the PTT button is pressed (the radio is transmitting) and the caller can only be heard by the person being called when the PTT is released (the radio is receiving).

11.9.3 DTMF Overdial/Conventional Mode Telephone Interconnect

Once the radio has established a connection to the public telephone system, it may be necessary to "over-dial" more digits to access banking services, answering machines, credit card calls or other types of systems that require DTMF (Dual-Tone Multi-Frequency) access digits. Overdial operation can also be used to initiate a telephone interconnect call via DTMF signaling if a dial tone has already been accessed on the system. This is the method that is used for making a telephone interconnect call while operating in the conventional mode but will also function in trunked mode if a dial tone is directly accessible. Telephone numbers and other number sequences for over dialing can be stored in the phone list when programming the radio or stored by the

operator in the first ten phone list entries. These numbers are accessed by pressing **PHN** then following the selection mode rules.

The following steps are required to dial these numbers:

1. Follow the procedure in **Sending a Telephone Interconnect Call (Trunked Mode Only)** to establish a connection to the telephone system or consult the system administrator for the procedure to access a dial tone on the trunked or conventional system.
2. Overdial numbers are transmitted using either method as follows:

METHOD 1: Press and hold PTT while entering the overdial number sequence from the keypad. This method sends DTMF tones during individual, telephone interconnect, trunked group, or conventional channel calls. Anytime the PTT button is pressed and held, the keypad is enabled for DTMF entry.

METHOD 2: Press **PHN** to enter the overdial select/entry mode and follow the selection mode rules to call up a stored number from the phone list or to directly enter the overdial digits. Press PTT to send the overdial sequence once. If the number needs to be transmitted again it must be selected or entered again (this prevents unwanted numbers from being sent the next time the PTT button is pressed during the call).

This overdial select/entry mode remains active until the call is dropped, cleared, or **MENU** is pressed. The overdial select/entry mode can be re-entered if the call is still active by pressing **PHN**.

11.9.4 Programmable Entries

Individual call ID numbers, telephone numbers and other number sequences for overdialing are stored in the special call lists when programming the radio. The first ten entry locations of these lists can be changed by the radio operator. The keypad is used when adding, changing and storing numbers in these entry locations.

Use the following procedure to store a number in one of the first ten entries of a special call list:

1. Press **IND** or **PHN** to enter the individual call list or the phone call list. The selection mode rules apply.
2. Scroll through the list using the RAMP controls, \triangle or ∇ , until one of the first ten entries is reached. **NO ENTRY** is displayed if the location is empty.
3. Enter the desired number. If necessary, a pause can be entered by pressing and holding **0-9**, *****, or **#** until an underscore appears in the display. The individual call list entries will accept up to 5 digits. The phone call list entries accept a combination of up to 31 digits and pauses.
4. Press and hold **MENU** until the display changes indicating that the number has been stored.
5. Repeat the steps above if the number stored in an entry location needs to be changed.

11.10 MOBILE DATA

The M7100^{IP} Series mobile radios, when operating in the EDACS configuration, permit either voice or data calls to be transmitted or received. The radio can handle only one type of call at a time; however, selection of either data or voice is selected transparently by the operator through normal usage of the radio. Data communications is not supported in the conventional mode.

The mobile radios can be connected to Mobile Data Terminals (MDT) or to a host computer. Any RS-232 compatible device that supports the Radio Data Interface (RDI) protocol (Version 1.91 or greater) can be connected to the mobile radio. Support for MDTs or host computers is a programmable option per radio. Additionally, radios programmed for host computers can also be programmed for data only operation (no voice calls transmitted or received).



NOTE

Turn power to the radio OFF before connecting or disconnecting any cables, including the data cable. Also, turn power to the radio OFF when docking or undocking a connected laptop computer. Failure to turn the power OFF can damage the radio, requiring service by a M/A-COM approved service center.



11.10.1 Displays

The following will be displayed on the control unit during the various states of data mode of operation.

- TX DATA** Displayed on bottom line of display when the radio is transmitting a data call.
- RX DATA** Displayed on bottom line of display when the radio is receiving a data call.
- DATA OFF** Displayed on top line of display when the radio is in the data disabled state.
- DATA ON** Displayed for two seconds on top line of display when the radio is toggled to the data enabled state.

11.10.2 DATA OFF Operation

The radio can be placed in the data disable state by any of the following methods. When the data state is disabled, the control unit displays "**DATA OFF**" on the top line. An ongoing data call is allowed to complete except when an emergency is declared.

- Removing the microphone from the hookswitch (hookswitch option must be enabled by pre-programming).
- Declaring an emergency (not to be used unless an actual emergency condition exists). Alert tone will sound.
- Pressing the  button (System Model) or  (Scan Model) (pre-programmed). Alert tone will sound.
- Selecting the function using the  button (pre-programmed).
- Pressing the **ND** button (System Model Only) (pre-programmed).

11.10.3 DATA ON Operation

The data state is enabled by one of the following (depending on how it was disabled). "**DATA ON**" will be displayed top line of display for 2 seconds then the display returns to normal.

- Replacing the microphone into the hookswitch (going on-hook). Only valid if the "**DATA OFF**" operation was entered by removing the microphone from the hookswitch (going off-hook).
- Pressing the **ND** key toggles data state ON or OFF.
- Clearing an emergency, but valid only if an emergency caused "**DATA OFF**" operation.



11.10.4 Exiting Data Calls

Under normal conditions, the radio enters the scan lockout mode and returns to the control channel after completion of a data call (transmit or receive). If, during a data call, one of the following conditions occurs, the data call is immediately terminated and the radio performs the desired function:

- The PTT is activated.
- The PTT is in Public Address mode.
- An emergency is declared by pressing the pre-programmed emergency button.
- A group or system change is made.



11.10.5 Scan Lockout Mode

Following the transmission or reception of a data call, if scan is enabled, scanning will stop temporarily (duration pre-programmed). During this time the scan LED will flash to indicate that scan is enabled but temporarily suspended. This mode is normally exited when the pre-programmed time expires; however, the following actions will terminate the scan lockout mode before the timeout is completed.

- The  (System Model) or  (Scan Model) button is pressed.
- The PTT is pressed.
- A group or system change is made.
- Enter phone call mode.
- Enter individual call mode.
- A new emergency assignment has been received.
- The PTT is pressed in Public Address Mode.
- An emergency is declared or cleared.
- Microphone is removed from hookswitch (OFF-hook).
- Receiving an individual or phone call.
- Receiving an Agency, Fleet or System All Call.
- Pressing the  button to turn scan ON or OFF.

11.10.6 Data Lockout Mode

The data lockout mode is a pre-programmed mode when the radio will not respond to any data channel assignments and prevents receive data calls from interrupting voice calls. Transmit data calls will still be initiated when needed by the operator. After a pre-programmed time, the radio will respond to receive data calls; however, the following conditions will clear the data lockout mode:

- The  (System Model) or  (Scan Model) button is pressed.
- Transmitting a data call.
- Changing a system.
- An emergency is declared.

- Pressing the PTT while in Public Address mode.
- Turning scan ON with the SCAN button.

11.11 STATUS/MESSAGE OPERATION

Status and message operation is possible with either the Scan or System version of the M7100^{IP} Series mobile radio unit. The following procedure is applicable for the System version. For operation with the Scan version, the four primary keycaps must be reconfigured and pre-programmed for status/message operation.

11.11.1 Status Operation

Status operation permits the transmission of a pre-programmed status condition to the EDACS site.

To send a status condition, press the **STS** button (keylight comes on) then press one of the number buttons (**0-9**) to select the pre-programmed status. If no status has been programmed for the selected number button, the radio will display **NO ENTRY** and the radio will sound a low tone. A valid selection will permit the status text to appear in the display for a pre-programmed time. After the time-out expires or the **MENU** button has been pressed (the **MENU** button will override the time-out period), the status is selected and will be transmitted to the site or stored in the radio memory where it can be polled by the site at a future time. If the site receives the status properly, when transmitted or polled by the site, a high-pitched tone sounds and the keylight associated with that status will remain lit. If the site does not receive the status properly, a low-pitched tone sounds and the keylight associated with the status will blink.

If an incorrect status was selected or the incorrect number button was pressed, the status can be changed during the pre-programmed time-out period by pressing another number button. The status selection can also be cancelled by pressing the **CLR** button prior to the time-out period.

To view the currently selected status after it has been transmitted, press the **STS** button. If the status was not sent successfully to the site, the text associated with the status will flash in the display.

The radio can also be pre-programmed to redesignate the keypad buttons for **ST0** thru **ST9** to send status condition. In this configuration the radio status operation will operate as previously described except the **STS** button is not required. The keylight associated with **ST0** thru **ST9** will indicate which status is selected.

11.11.2 Message Operation

Message operation permits the transmission of a pre-programmed message text to an EDACS site.

To send a message, press the **MSG** button (keylight comes on) then press one of the number buttons (**0-9**) to select the pre-programmed message text. If no message text has been programmed for the selected number button, the radio will display **NO ENTRY** and a low-pitched tone sounds. A valid selection will permit the message text to appear in the display for a pre-programmed time. After the time-out expires or the **MENU** button has been pressed (the **MENU** button will override the time-out period), the message text is selected and will be transmitted to the site. If the site receives the message properly when transmitted, a high pitched tone sounds and the **MSG** keylight remains lit. If the site does not receive the message properly, a low-pitched tone sounds and the **MSG** keylight will blink.

If an incorrect message text was selected or the incorrect number button was pressed, the message text can be changed during the pre-programmed time-out period by pressing another number button. The message text selection can also be cancelled by pressing the **CLR** button prior to the time-out period.

To view the currently selected message text after it has been transmitted, press the **MSG** button and then the **CLR** button prior to the time-out period. If the message text was not sent successfully to the site, the text associated with the message will flash in the display.

11.12 EDACS CONVENTIONAL P1 SCAN

This feature permits the radio user to scan a pre-programmed conventional system and channel as a Priority 1 (**P1**) channel while the radio is selected for EDACS trunked system. If activity is detected on the conventional P1 channel, the radio will unmute and remain on this conventional channel for the programmable hang time.

The radio must be pre-programmed to designate a button for scan ON/OFF operation.

11.13 DYNAMIC REGROUP OPERATION

Dynamic regroup operation permits multiple talk groups (up to eight) to be added to a radio via the Communications Systems Director (CSD). The radio must be pre-programmed to respond to regrouping. Dynamic regrouping will not be activated in a radio until an activation message is sent by the system manager. Each radio that receives and acknowledges regrouping instructions is successfully regrouped.

Pressing and holding the **CLEAR** (Scan Model) or **CLR** (System Model) button for 2.5 seconds toggles the user into and out of the dynamic regroup group set. A double beep will sound for entry or exit. The display will indicate **REGR_0x** where "x" is a digit of 1 to 8 indicating the group when dynamic regroup has been enabled by the user. If the radio is in dynamic regroup and the user selects a group that has not been regrouped, the display will show **NO ENTRY**. The radio will be prevented from transmitting and receiving calls in this condition except for scanned groups.

11.13.1 Emergency Operation

If the pre-programmed group set on the currently selected system contains an EMER/HOME group and the radio is in dynamic regroup, the radio will exit dynamic regroup and declare the emergency on the HOME group. If no EMER/HOME group is present, the radio will declare the emergency on the currently selected dynamic regroup group.

12 CONVENTIONAL MODE OPERATION

The radio functions in the conventional mode when using conventional communications channels (non-trunked). Each channel consists of a preset frequency pair for transmit and receive during repeater operation or a single frequency for both transmit and receive during talk-around (no repeater) operation. To use this mode, the operator selects a conventional system that includes one or more conventional channels. Each conventional channel may have one or more features, such as Channel Guard, programmed when the channel is selected.

The  button unmutes the receiver so activity on the selected channel can be monitored. When pressed and held for approximately 3 seconds this button toggles conventional channel decoding (Channel Guard, Digital Channel Guard or T99) ON and OFF, if programmed for the selected channel.

12.1 RECEIVING A CALL

1. Turn the radio on by rotating the **POWER ON-OFF/VOLUME** knob clockwise (out of detent). A short alert signal (if enabled through programming) indicates the radio is ready to use.
2. Adjust the **POWER ON-OFF/VOLUME** knob to the desired volume level.
3. Select the desired conventional system and channel. The display indicates the current conventional system and channel names.
4. The radio is now ready to receive calls.
5. When the radio receives a call (and the correct encoding is decoded, if programmed and enabled), it unmutes on the channel and the **BSY** indicator comes on.

12.2 SENDING A CALL

1. Turn ON the radio and set the **POWER ON-OFF/VOLUME** knob to the desired volume level. Select the desired conventional system and channel.
2. Ensure that the channel is not busy by pressing the  button to briefly disable any channel decoding and unmute the receiver or observe the unlit **BSY** indicator. If the Channel Busy Lockout feature is programmed for the selected channel, the radio will not transmit when the channel is busy.
3. Press and hold the PTT button. The **TX** indicator will turn on and a short beep sounds (if programmed) indicating that communication can begin.
4. Hold the microphone approximately three inches from the mouth and speak in a normal voice.
5. Release the PTT button when the transmission is complete and listen for a reply.

12.3 EMERGENCY OPERATION

If enabled, G-STAR emergency signaling can be transmitted when operating in the conventional mode. This G-STAR signaling will transmit 5 times with a delay between each transmission. To send an emergency call on the selected conventional system and channel (or on an optionally pre-programmed conventional emergency system and channel), proceed as follows:

Press and hold the red  or “E” button for approximately one second (this time is programmable and, therefore, could be longer or shorter; check with the system administrator). The radio turns on the **TX** indicator and proceeds to transmit the pre-programmed G-STAR emergency signaling sequence.

G-STAR is programmed to transmit in one of the following methods:

- METHOD 1:** G-STAR is transmitted on the selected channel. If the channel is changed the emergency signaling will continue to be transmitted on the newly selected channel.
- METHOD 2:** Same as METHOD 1 but the radio will lock on to the currently selected channel. Any attempts to change the system or channel will be disabled.
- METHOD 3:** G-STAR is transmitted on a pre-programmed conventional emergency system and channel regardless of the selected channel. In this case the selected channel is available for voice transmission and the radio will periodically change to the pre-programmed emergency system and channel to send the emergency signaling and then change back to the selected channel.
- METHOD 4:** Same as METHOD 3 but the radio will lock on to the pre-programmed emergency system and channel. Any attempts to change the system or channel will be disabled.

The emergency state can be cleared by turning the radio OFF and then back ON.

12.3.1 Using 5-Tone Signaling to Declare an Emergency

If 5-Tone signaling is defined for emergency declaration in place of G-STAR emergency signaling, a pre-programmed tone sequence will be transmitted instead of the G-STAR sequence. This emergency declaration functions as the G-STAR emergency in all other respects.

12.3.2 Tone Encode Transmission

In conventional mode two keys can be defined to be tone encode triggers. If either one of the pre-programmed tone encode triggers is pressed, a pre-programmed tone sequence will be transmitted on the current system and channel. (See Section 12.3 if  or “E” key is used.) The **TX** indicator will light during tone transmission and a beep will sound at the end of the transmission. If enabled, audible side tones will be heard in the radio speaker as well. If PTT is pre-programmed as one of the triggers, the microphone will become active for voice communication after the tone sequence is complete.

Tone encode will be transmitted with Channel Guard if one is defined, and tones are always transmitted in clear voice mode, even if the channel is set for digital or private (see **VOICE MODES**). Digital or private voice transmission will resume normally after the tone transmission.

12.4 SCANNING CONVENTIONAL CHANNELS







Channels, which have been previously added to the scan list on a per system basis, can be scanned. The selected channel is scanned (if enabled through programming) whether or not it is in the scan list. Each conventional system's channel scan list is retained in memory when the radio is turned OFF.

The scan rate will vary depending upon the number of channels in the scan list and whether or not the radio is programmed to scan for channels with decoding enabled. Fewer channels will result in a faster scan rate. If programmed for dual-priority scan operation, the priority-one, priority-two and the remaining scan list channels are scanned. Once a signal is detected and the correct encoded squelch signal is decoded (if programmed), the radio receives the message and displays the received scan channel. At the same time, scanning continues on the priority-one and priority-two channels. If a priority-one or priority-two channel carrier, regardless of encoded squelch decoding, is detected while a non-priority channel is being received, the display name is updated and the received channel is switched to the priority channel. Scanning of the priority-one channel will continue if a message is being received on the priority-two channel.



While receiving a call on a non-priority or a priority two channel, the radio periodically checks the priority one and two channels. If Scan with Channel Guard is enabled, the radio will use Channel Guard to decide whether to unmute on a priority channel. The radio will stop, on squelch detection, on a priority channel. In normal operation, the radio will unmute only on detecting the correct Channel Guard; otherwise, it will remain muted until the priority channel call and hang time have ended. An optional feature allows the radio

to continue scanning upon the detection of the wrong Channel Guard on a priority channel. The user can then select the rate at which this channel is scanned until the call ends.

12.4.1 Adding Channels To A Scan List

1. With scan operation turned OFF select the desired channel to add to the selected conventional system channel scan list.
2. Press  or  on the **SCAN** add/delete control. The current status will be displayed in column 1 of line 1 for a time-out period. Press  to add the channel to the scan list. **S** is displayed on the line. This sets the selected channel for non-priority scanning. A second press of  sets the channel for Priority 2 (P2) scanning and **2** is displayed on line 1. An additional press of  sets the channel for Priority 1 (P1) scanning and **1** is displayed on line 1. If the P1 or P2 channels are already set and a new channel is then assigned as the P1 or P2 channel, the previously assigned priority channel will change to non-priority scanning. The priority setting selection sequence is set and stops at P1, therefore the channel must be deleted from the scan list by pressing  before the channel is set to a previous priority setting. Any channel that is in a system's channel scan list will show **S**, **2**, or **1** for the time-out period when it is the selected channel.

12.4.2 Deleting Channels From A Scan List

1. With scan operation turned OFF select the desired channel to delete from the selected conventional system's channel scan list.
2. Press  or  on the **SCAN** add/delete control. The current status is displayed for a time-out period. Press  to delete the channel from the scan list. **S**, **2**, or **1** will turn OFF. Any channel that is not in a conventional system channel scan list will show a "**blank**" for the time-out period when it is the selected channel.

12.4.3 Nuisance Delete

A channel can also be deleted from the scan list, if it is not the currently selected channel, by pressing  during scan operation while the radio is displaying the unwanted channel. The channel will be deleted from the conventional system's channel scan list in the same manner as if done using the steps above. Deletions done in this manner will not remain deleted if the radio is turned OFF and then back ON.

12.5 TURNING SCAN ON

1. Toggle the scan operation ON by pressing . The SCAN indicator will turn ON when the radio is scanning.



NOTE

Scanning will stop while the microphone is off-hook if the hookswitch feature is enabled through programming.

2. When a channel on the scan list receives a channel assignment, the radio unmutes on the assigned channel, **BSY** indicator comes ON and the received scan channel is displayed.
 - The radio will continue scanning if a new channel is selected when scan is ON.

- Pressing the PTT button when scan is ON will cause the radio to transmit on the displayed channel or to the currently selected channel depending on programming.
- Pressing  when scan is ON will cause the radio to recall the scanned channel that was last received. This channel is recalled for a period equal to the scan hang time.

12.6 TURNING SCAN OFF

Toggle the scan operation OFF by pressing . The radio will resume operation on the selected channel.

12.7 SQUELCH ADJUST

In the conventional mode of operation, the squelch can be re-adjusted in the MENU selection mode or from a front panel key on the keypad that has been pre-programmed using ProGrammer™ software. A default value of 9, or any user level between 1 and 16, can be selected using ProGrammer software. The user can change this setting either of two ways from the front panel keys.



NOTE









A value of 16 requires a strong signal to open squelch, a value of 2 requires a very weak signal to open squelch, and a value of 1 is open squelch.





NOTE

When the squelch adjust feature is activated, Channel Guard, T99 decode, and Scan are disabled. When the squelch adjust feature is exited, Channel Guard, T99 decode, and Scan are restored to their previous states.

12.7.1 Menu Selection

1. Press the  key and then use the RAMP control  or  to scroll through the selections until **SQUELCH** is displayed. Then press  (select) again.
2. The display will show **SQLCH=xx**, where "xx" is the value between 1 and 16.
3. Use the RAMP control  or  to scroll through the values. Then press the  (select) key to save the new value after the display time-out (2 seconds). The displayed value will be selected and saved.
4. If the  or  key is pressed before the time-out, the menu feature will exit and the squelch level will not be updated. The original value will be restored.

12.7.2 Pre-Programmed Keypad Key



1. Press the pre-programmed key and the display will indicate **SQLCH=xx**, where "xx" is the value between 1 and 16.
2. Use the RAMP control  or  to scroll through the values. Then press the  (select) key to save the new value or wait for the display time-out (2 seconds). The displayed value will be selected and saved.



3. If the  key is pressed before the time-out, the squelch level will not be updated and the original value will be restored.

12.8 TYPE 99 DECODE (CONVENTIONAL ONLY)

If the Type 99 Decode Option has been pre-programmed, individual selective calling is possible. The radio can now decode individual, group or supergroup paging calls. Two sets of Type 99 paging codes must be pre-programmed into the radio. When the radio decodes an appropriate Type 99 code sequence, an alert tone and visual indicator is provided to the user. The receiver then operates as a noise squelched unit until Type 99 is reset. Type 99 decode continues to operate during this noise squelched period. The appropriate Type 99 alert tone will sound again if it detects a valid two-tone sequence.

Type 99 operation can be reset manually or automatically (pre-programmed). Manual reset is achieved by briefly pressing , if programmed. Automatic reset, if enabled, occurs after a 30 second interval following the most recent decode of a Type 99 tone sequence. Hookswitch (pre-programmed) can also enable or disable Type 99 decode. The pre-programmed key light will blink when Type 99 is disabled by the hookswitch.

Type 99 decode will continue to be active while the radio's  button is pressed. This allows the user to monitor calls and still be alerted when a call is directed to the user. While the user continues to press , the user will hear both calls and all Type 99 tone signals. If  is pressed for longer than two (2) seconds, Type 99 decode will either be disabled or re-enabled depending upon its present state.

To check the Type 99 enable status, press the Scan Add/Delete  or . The current status of Type 99 decode will be displayed for a time-out period. Type 99 is enabled when the letter **T** is displayed in the third segment from right on the first line of the LCD.





If a Horn Alert Option is installed and enabled with the Type 99 Decode Option, the radio can beep the vehicle horn when a Type 99 call is received. This option permits alerting persons out of the vehicle when a call is received.



NOTE

Type 99 is automatically disabled when Scan is enabled.

12.8.1 Menu Selection



Press  and then use  or  controls to scroll through the selections until **T99 ENAB** is displayed. Then press  to toggle the Type 99 decode state. The **T99 ON** or **T99 OFF** display message is displayed for two seconds to show the new state.

12.8.2 Pre-Programmed Keypad Key

Press the pre-programmed key and the **T99 ON** or **T99 OFF** display message is displayed for two seconds to show the new state.

12.9 DIRECT MODE OPERATION (CONVENTIONAL ONLY)

The direct mode (or talk-around) provides short range, line of sight communications. One of the buttons on the control unit must be pre-programmed for this feature to function.

1. Make sure the radio is ON and then select the desired conventional system and channel.
2. Press the pre-programmed button to toggle the talk-around function ON.
3. Ensure that the channel is not busy by pressing the  (System version) or  (Scan version) to briefly disable any channel decoding and unmute the receiver or observe the unlit **BSY** indicator. If the Channel Busy Lockout feature is programmed for the selected channel, the radio will not transmit when the channel is busy.
4. Press and hold the PTT button. The **TX** indicator will light and a short beep sounds (if pre-programmed) indicating that communication can begin.
5. Release the PTT button when the transmission is complete and listen for a reply.
6. When the communications is completed, press the pre-programmed button to toggle the talk-around function OFF.

13 PROJECT 25 (P25) CONVENTIONAL OPERATION

13.1 GROUP CALLS IN P25 MODE

13.1.1 Transmitting a Group Call

1. Select the desired P25 system. (P25 icon will appear in display.)
2. Select the Talk Group/Conventional Channel. (Selected simultaneously using either the system/group/channel knob or the group key.)
3. Press and hold the PTT.
4. When a grant tone is received (if enabled through programming), speak into the microphone.
5. Release PTT and wait for response.

13.1.2 Receiving a Group Call

The radio will unmute according to the squelch mode defined in the radio personality (monitor, normal, selective).

1. Select the desired P25 system and Talk Group/Channel or turn scan on and make sure the desired channel is in the scan list.
2. When the radio receives a P25 call, the radio will unmute and the channel name will appear in the display.
3. Press the PTT button to respond.

13.2 INDIVIDUAL CALLS IN P25 MODE

13.2.1 Transmitting an Individual Call

1. Select the desired P25 system. (The P25 icon will appear in the display.)
2. Select the radio unit to call (callee source ID) from the pre-programmed individual call list or enter the ID number on the radio keypad.
3. Press and hold the PTT.
4. When grant tone is received (if enabled through programming) speak into the microphone.
5. Release the PTT.

13.2.2 Receiving an Individual Call

The radio will unmute according to the squelch mode defined in the radio personality (monitor, normal, selective).

1. Select the desired P25 system and Talk Group/Channel or turn scan on and make sure the desired channel is in the scan list.
2. When the radio receives a P25 call, the radio will unmute and the ID of the transmitting radio will appear in the display.
3. Press the PTT button to respond.

Unanswered calls will appear in the Who Has Called (WHC) list.

13.3 EMERGENCY GROUP CALLS IN P25 MODE



NOTE

There is no method available for a system-wide Emergency clear. An emergency group call must be cleared on each individual radio.

13.3.1 Declaring an Emergency Group Call

1. Select the desired P25 system and Talk Group/Channel.
2. Press the red emergency button on the top of the radio. The radio will broadcast a short emergency transmission with the emergency bit set. “**TXEMER**” will appear in the display of the transmitting radio.
3. To send a voice message, press the PTT and speak into the microphone.
4. To clear an emergency from the transmitting radio, perform one of the following steps:
 - a) Change systems.
 - b) Change channels (if not prohibited by programming).
 - c) Cycle power by turning radio off and then back on.
 - d) Press the Clear and Emergency buttons simultaneously, providing the Clear Emergency option is enabled in the Supervisory Options in the personality.

13.3.2 Receiving an Emergency Group Call

1. Select the desired P25 System and Talk Group/Channel.
2. When the radio detects an incoming Emergency Group Call, the radio will sound an alert tone and “**RXEMER**” will appear in the display.
3. Voice or emergency transmissions will be heard at the receiving radio.
4. To clear an emergency from the receiving radio, perform one of the following steps:
 - a) Change systems.
 - b) Change channels (if not prohibited by programming).
 - c) Cycle power by turning radio off and then back on.
 - d) Press the Clear and Emergency buttons simultaneously, providing the Clear Emergency option is enabled in the Supervisory Options in the personality.

14 TRUNKED OR CONVENTIONAL MODE OPERATION

14.1 SIREN/LIGHT OPERATION

Each siren/light key is designed to control an optional siren/light package. Pressing a siren/light key will light the key indicator. Each siren/light key (except RESET) can be programmed for either CANCEL or ADDITIVE operation. If programmed for CANCEL, then all other siren/light activity is cancelled except for the activity associated with this key. If programmed for ADDITIVE, then a key press will add its respective siren/light activity to the current siren/light activity. It is important to note that while the lights are additive, only a single siren can be active at a time. The current siren will be determined from the recently pressed key that contains a siren assignment.

Each siren/light key (except RESET) can be programmed for Toggle, Momentary, or Timed. In **Toggle**, each key press will toggle the state of the key between ON and OFF. In **Momentary**, a key's respective feature will only be active while the key is pressed and held. When programmed for **Timed**, the siren/light key activity will only be active during the programmable time-out window. The duration of the time-out window is programmable between from .5-127.5 seconds. During the time-out window the respective key indicator will be ON. When the timer expires, the activity will be terminated and the indicator will turn OFF. If an additional time-out key (programmed for ADDITIVE) is pressed during the time-out window, then the time-out window is reset and both activities will terminate at the same time.

14.2 DIGITAL VOICE OPERATION

(ProVoice/Aegis/Voice Guard)

14.2.1 Voice Modes

Each system (trunked or conventional) in the radio is programmed for no digital voice operation (analog only) or one of the two digital voice formats supported (ProVoice or Aegis). Aegis or ProVoice programmed systems have three (3) different voice modes: clear (analog), digital, and private. The voice modes are programmed on a per-group basis within each trunked system and on a per-channel basis within each conventional system. A radio must be equipped with the encrypt/decrypt option before it will operate in private mode.



NOTE

Current ProVoice Conventional operation is for talk-around mode only.

Table 14-1: Transmit/Receive Mode Compatibility for Aegis/ProVoice Operation

GROUP/CHANNEL PROGRAMMING (TRANSMIT)	CLEAR RECEIVE	DIGITAL RECEIVE	PRIVATE RECEIVE
CLEAR	Yes	No	No
DIGITAL	Yes	Yes	No
PRIVATE	Yes	No	Yes



NOTE

Conventional Aegis or encrypted channels require Channel Guard on the channel to operate correctly.

14.2.2 Clear Modes

Aegis clear and ProVoice clear modes are identical voice modes in which the radio transmits and receives only clear (analog) voice signals. These analog signals are non-digitized and non-encrypted. Clear mode transmissions can easily be monitored by unauthorized persons. Groups or channels programmed for clear operation cannot transmit or receive unencrypted digital or private messages.

14.2.3 Aegis/ProVoice Digital Mode

Aegis/ProVoice digital mode allows the radio to transmit and receive digitized voice signals. These digital signals provide improved weak signal performance and they cannot be easily monitored with a standard receiver. Groups and channels programmed for Aegis or ProVoice digital operation transmit only digital signals. Private calls cannot be received or transmitted when the radio is in the Aegis or ProVoice digital mode because the radio does not know the cryptographic key used.

Message trunked group calls and individual calls will be answered back in the mode they were received, assuming the call or hang time is still active. Individual, phone, all and emergency calls will be transmitted clear if digital mode is disabled or inoperative.

- If receiving an analog message trunked call, the radio will respond in analog mode during the hang time on the working channel.
- If receiving an analog I-Call, the radio will respond in analog mode during the hang time.
- When using the "WHC" feature to respond to an I-Call (after the hang time has expired), the call will be transmitted in the mode defined by the system mode as programmed for the current system if the ID being called is not in the I-Call list. If the ID is in the I-Call list, then the call will be transmitted as defined by the I-Call mode programmed in the list for that ID.

DTMF

The overdial and hot keypad features for transmitting DTMF tones are not available while in the Aegis Digital Mode or ProVoice Digital Mode.

ERROR Messages

If any of the following error messages are displayed, the radio was either programmed incorrectly or needs servicing:

DSP ERR
ERR=xxxx

DSP ERR

DIGV ERR

Power Up Only

If the Aegis or ProVoice circuit board is not responding, correctly, one of the following error messages will be displayed and the radio needs servicing:

HARDWARE
ERR= 3X

3X will be a number between 30 and 38

14.2.4 Aegis Private, ProVoice Private, and Voice Guard¹ Private Modes

The Aegis and ProVoice private modes allow the radio to transmit encrypted messages and receive clear or private transmissions. The radio will transmit private if the group/channel is programmed for private operation and forced operation is pre-programmed.

If the radio was pre-programmed for auto-select, the radio will transmit in the following modes;

- If Private mode is enabled, transmissions are always in private mode.
- If Private mode is disabled and a private call is received, the Reply transmission will be in Private mode if the transmission is made during the scan hangtime. If the reply transmission occurs after the scan hangtime, the transmission will be in Clear mode.

Aegis or ProVoice transmissions cannot be received by any radio set to receive a Voice Guard[®] transmission. Accordingly, Voice Guard or ProVoice transmissions cannot be received by a radio set to receive an Aegis transmission and neither Aegis nor Voice Guard transmissions can be received by a radio set to receive ProVoice. Since the M7100^{IP} radios are not Voice Guard compatible, the M7100^{IP} cannot receive a Voice Guard transmission, nor can Aegis or ProVoice transmissions from an M7100^{IP} radio be heard by a radio set to receive Voice Guard transmissions.

Cryptographic keys are transferred to the radio using a cryptographic Keyloader. Up to seven (7) different cryptographic keys, numbered 1-7, can be transferred from a Keyloader and stored in the radio. An individual key is automatically selected on a per-group/channel basis according to the radio's programming. Groups and channels within Aegis or ProVoice systems can be programmed for keys 1-7. Up to 8 banks of 7 keys can be stored for Aegis systems.

DES radios require a DES Keyloader (Option V4025 with software version 3.n or later).









When operating on a group or channel programmed for private mode, all transmissions will be private transmissions and the radio will receive clear and private signals. The PVT keylight (System Model) or OPTION keylight (Scan Model) turns ON when the private mode is enabled. If the selected group or channel is programmed for auto-select capability, the mode can be toggled between private and clear with the PVT button (System Model) or o button (Scan Model). Radios programmed for forced private operation do not allow a change of the transmit mode; therefore, the PVT button (System Model) or o button (Scan Model) has no effect.

14.2.4.1 Transferring Keys to the Radio

The following procedure outlines basic key transferring steps:

1. Turn the radio OFF.
2. Ensure that the PC programming cables and adapter box are disconnected from radio unit.
3. Plug the modular connector of the Keyloader cable into the Keyloader modular jack.
4. Connect the Keyloader cable to the keyloader level converter and then to the extended options cable DB25 on the rear of the radio.
5. Press the PWR button on the Keyloader and wait for the Keyloader to display "**MASTER MODE.**"
6. Press the TRN button on the Keyloader. If necessary, select a different cryptographic key to be transferred into the radio.

¹ Voice Guard encryption is not supported by M7100^{IP} Series mobile radios.

7. Turn the radio ON. Use the  button to access the menu options then the RAMP  or  controls to select **KEYLOAD**.
8. Press  (select). Then use the RAMP  or  controls to select the bank location.
9. Press the EXE button on the Keyloader to transfer the key. The Keyloader will display "**GOOD 1.x TRANSFER**" where "x" is the selected cryptographic key number.
10. Disconnect the cable from the extended option cable. Press the  (Scan Model) or  (System Model) button to exit the keyload operation. The radio will change to the selected group or channel as indicated in the display.

14.2.4.2 Displaying the Currently Used Cryptographic Key Number

To display the cryptographic key currently in use for either the system encryption key (for special call such as individual, phone, all, agency or fleet) or the group/channel key (for group or conventional calls), perform the following procedure:











1. Press the  button.
2. Use the  or  button (ramp control) to select **DISP KEY**. Then press the  (select) button.
3. Then use the  or  buttons to toggle between displaying the system key or the group/channel key.

Table 14-2: Current Cryptographic Key Display

ENCRYPTION KEY DISPLAYED	MESSAGE DISPLAYED
System	"SYS KEY" "KEY = 1"
Group/Channel	"GRP KEY"/"CHN KEY" "KEY = 2"/"KEY = 2"

14.2.4.3 Key Zero

All cryptographic keys can be zeroed (erased from radio memory) by pressing the  button (System Model) or  (Scan Model) and while still pressing this button, press and hold the  button (System Model) or  (Scan Model). Press both buttons for 2 seconds. A series of warning beeps will begin at the start of this 2-second period and then switch to a solid tone after the keys have been zeroed. The display will indicate **KEY ZERO**.

If the cryptographic key(s) are zeroed, one or more keys must be transferred from the Keyloader into the radio before private communications can continue.



14.2.5 Private Operation

14.2.5.1 Receiving an Encrypted Call

When receiving, the radio automatically switches between clear or private operation. If the transmission being received is an encrypted transmission, it will be decrypted, the PVT keylight (System Model) or OPTION keylight (Scan Model) will flash, the receiver will unsquelch and the

message will be heard in the speaker. For this to occur the selected group or channel must be programmed for private operation and the correct cryptographic key must be loaded into the radio.

14.2.5.2 Transmitting an Encrypted Call

1. Select the desired group or channel.
2. Place the radio in private mode by pressing the **PVT** button (System Model) or  (Scan Model). When private mode is enabled, the **PVT** keylight (System Model) or  keylight (Scan Model) will be ON.

If the last state of the radio was private mode, the private mode will be enabled on power up. In addition, the private mode will be enabled if forced operation has been programmed in the radio

If a group or channel is not programmed for private mode operation, **PVT DIS** will be displayed if an attempt is made to enable private transmit mode. It is not possible to operate on this group/channel in private mode.

If the radio is programmed for forced private transmit operation, **FRC D PVT** will be displayed if an attempt is made to disable private transmit mode. It is not possible to transmit on this group/channel in clear mode.

If the radio does not have the correct encryption key loaded, **NO KEY #** will be displayed and the call will not be transmitted.

3. Continue with standard transmission procedures. A private mode access tone will be heard when the PTT button is pressed.

14.2.5.3 Scanned Group Calls

Receiving a scanned group call is the same as receiving a selected group call. During the scan hang time, if the radio was programmed for auto-select, it will transmit back in the same mode it received the call. For example, if a clear group is entered in the scan list, it will only receive clear calls. If the same group was available in private and entered in the scan list, it can receive clear and private calls, provided auto-select was programmed in the radio. The user can select transmitting on the scanned or selected group. If a group is entered in the scan list more than once and in different modes (clear, digital, private), only the first occurrence of the group will be used.

14.2.6 Conventional Operation

14.2.6.1 Outside Address

The same outside address (works similar to Channel Guard operation) must be programmed in the transmitting and receiving radios when Aegis or ProVoice digital or private operation is enabled. If address is not correct, the radios will not communicate.

14.2.6.2 Channel Guard

Channel Guard encode is transmitted on analog clear channels only. Channel Guard decode will operate on either a clear or private channel. The exception is when G-STAR signaling is used (see G-STAR paragraph).

14.2.6.3 G-STAR

When G-STAR is programmed on a private channel, the radio will transmit G-STAR in clear mode and then switch to private for the voice portion of the call. If G-STAR is sent with Channel

Guard, then both are sent in clear mode and the radio switches to private mode. Emergency G-STAR data burst is transmitted in clear mode.

14.3 DUAL CONTROL OPERATION

The M7100^{IP} Series mobile radio can be programmed to operate from two separate Control Units. This permits radio operation from two separate locations in the vehicle. Dual control operation is available in both trunked and conventional modes. Only one control unit can control the mobile radio unit at a time. The control unit that controls the radio operation is called the active controller and the second unit is called the idle controller.

14.3.1 Switching Control

Control can be switched to the idle controller by pressing the push-to-talk (PTT) on the microphone associated with the idle controller. Once PTT is pressed, the radio will switch control to the idle controller unless the active controller is currently transmitting (i.e., PTT pressed on active controller), in which case the switch will not occur. When control is switched to the idle controller, two short high-pitched tones will sound at the controller where PTT was pressed to indicate that the idle controller is now the active controller and the previous active controller is now the idle controller.

14.3.2 Control Switching Modes

The radio can be pre-programmed for two modes of dual operation, Slaved and Independent. In the Slaved mode, the two controllers will use the same radio System and Group settings. The Independent mode permits each controller to have its own saved System and Group settings.

14.3.2.1 Slaved Mode Operation

In Slaved mode, either controller can operate the radio with no change in System and Group settings when control is switched. Both controllers display the current information. If a key is pressed at the idle controller, other than PTT, , "E," or siren and light keys as noted in following paragraphs, a low tone will sound and the display will temporarily show **DUAL** on line 1 of the idle controller.

When control is switched in a Slaved mode system, all of the radio settings and states will remain in effect that have been selected on the active controller.

14.3.2.2 Independent Mode Operation

In Independent mode, the radio system operates as if there are two radio units each controlled by a separate control unit. Each control unit maintains its own System and Group settings that are restored when control is switched.

The idle controller will display **DUAL** on line 1 to indicate that it is idle. If a key is pressed at the idle controller, other than PTT, , "E," or siren and light keys as noted in following paragraphs, a low tone will sound at the idle controller.

When control is switched in Independent mode, the idle controller will restore its own System and Group settings instead of using the settings of the previously active controller. Any pending operations at the active controller, other than , "E," or siren and light, will be terminated.

14.3.3 Emergency Operation

Either control unit (active or idle controller) can declare an emergency, provided radio has been pre-programmed to enable emergency declaration. If the idle controller declares an emergency,

control is switched to the idle controller and any current transmission from the previously active controller is terminated.

14.3.4 Siren & Light Control

Siren & Light control is only available from the control unit that is pre-programmed for these functions. Typically, the control unit at the driver's location would be programmed. The control unit that has these functions programmed can activate them regardless of whether it is an active or an idle controller.

14.3.5 Dual Control Audio

Audio output during dual control operation is a pre-programmed function. Default operation routes audio only to the active controller.

14.4 MULTIPLE RADIO OPERATION

The M7100^{IP} Series mobile radio can be configured to operate in multiple radio mode that permits more than one radio to be controlled from a single control unit or control location. The radios could be different frequency splits, trunked/conventional, etc.

In multiple radio operation, the radios continue to operate as individual radios except with a common control unit. The control unit is used for display and control. The control unit display is shared by the multiple radio units and, when selected, a radio can be controlled by the control unit.

For multiple radio operation, the control unit keypad must be pre-programmed for a variety of multiple radio buttons such as radio selection and radio mute.

14.4.1 Changing Selected Radio

A radio unit can be selected by pressing the radio selection button (pre-programmed) on the control unit. In addition, a button can be pre-programmed to rotate selection through the radio units; e.g., if radio #1 is selected, pressing the radio select button will select radio #2. Similarly, radio #2 will be selected if the radio select button is pressed when radio #1 was selected.

14.4.1.1 Shared Control Unit Display Modes

Radios in the multiple radio operation share the control unit display. Pre-programming the radios determines what the control unit displays. There are two modes of display: *alternating radio display* or *first-come first-serve display*. See also the following paragraph on Audio Modes.

14.4.1.1.1 *Alternating Radio Display*

In this mode, the control unit display will alternate between showing the call information for the radios when more than one call is being received. This mode is available only if audio is summed (see following paragraph on Audio Modes).

14.4.1.1.2 *First-Come First-Serve Display*

In this mode, the control unit display will show the call information of the radio that is providing the audio. A call in process prevents audio from other radios from being heard for the duration of the call. This mode corresponds with the first-come first-serve audio mode (see following paragraph on Audio Modes).

14.4.1.2 Audio Modes

In multiple radio operation, the audio from the mobile radio units can be pre-programmed to be summed or available on a first-come first-serve process.

14.4.1.2.1 Audio Summed

When audio is summed, the audio from all radios will be available whenever the radios receive a call. If two radios receive a call simultaneously, both calls will be heard in the speaker.

14.4.1.2.2 Audio First-Come First-Serve

When audio is pre-programmed for first-come first-serve, the audio from the radio that receives a call first will be heard from the speaker for the duration of the call. During this time, audio from the other mobile radios will be muted.

14.4.1.3 Muting a Specified Radio

Pressing the control unit mute button associated with a particular radio will mute its audio for a pre-programmed time period. The time period can be cleared by pressing the control unit mute button or the radio selection button.

14.4.1.4 Multiple Radio and Siren & Light Operation

For siren and lights to function correctly, both the master and slave radios must be programmed with the same siren and light information.



NOTE

Note that the PA and External Speaker functions operate only on the Master radio.

14.4.1.5 Multiple Radio and Data Operation

Only the master radio supports mobile data operation.

14.4.2 LAST SYSTEM/GROUP/CHANNEL RECALL

This feature, available for Master units only, enables the user to recall the last selected system/group after an EDACS emergency or home function, a conventional emergency or home function or system/group key function. This feature must be enabled through ProGrammer to function. For example, if the Home button (pre-programmed) is pressed, the radio will go to the designated Home system/group or channel. If the Home button is pressed again, the radio returns to the previous system/group or channel. At this time, the user can toggle between the Home system/group or channel and the previous system/group or channel. The operation is the same for the SG1-SG5 buttons.

14.5 MACRO KEY OPERATION



Macro key operation permits the user to accomplish a series of keystrokes with a single "macro" keystroke. Up to ten (10) macro keys can be defined, each capable of executing up to twenty (20) keystrokes, to any pushbutton input (i.e., keypad keys, buttons, etc.). Each macro key can be pre-programmed to activate when pressed or when released.

A macro key can also be pre-programmed to change the keystroke sequence the next time the macro key is activated.

For detail operation and assignment of macro keys, contact your communications supervisor or administrator.

14.6 INTERCONNECT CALL (SYSTEM MODEL ONLY)

To send a manually entered telephone interconnect call:

1. Select a channel in the radio system that has telephone interconnect capability. The radio should be programmed for DTMF operation on this channel.
2. Press the  button to toggle the keypad to the DTMF function (secondary function).
3. Press and hold PTT to key the transmitter. While holding the PTT, press the * or # key (as required by the radio system to obtain a telephone line). The radio will transmit the selected tone.
4. Release the PTT and listen for a dial tone. When the dial tone is heard, press and hold the PTT while entering the desired telephone number. As each digit is entered and transmitted, the DTMF side tone will be heard from the speaker, if programmed to do so through ProGrammer.
5. After all the digits have been entered and transmitted, release the PTT.
6. When the call is answered, press the PTT and speak directly into the microphone. Release the PTT immediately to receive a reply.
7. When the call is finished, press and hold PTT and then press the * or # key (as required by radio system) to terminate the interconnect call. Release the PTT.
8. To return to the primary function of the keypad, press . To continue with another interconnect call, repeat steps 3 through 8.

14.7 KEYPAD REMAPPING

If the keys have been remapped to provide new functions, fill in the following templates (Figure 14-1 and Figure 14-2) for future reference.

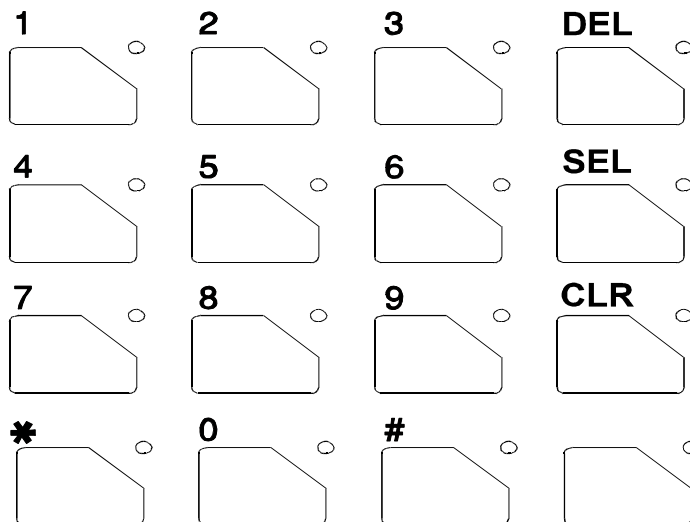

Figure 14-1: M7100^{IP} System Model Keypad

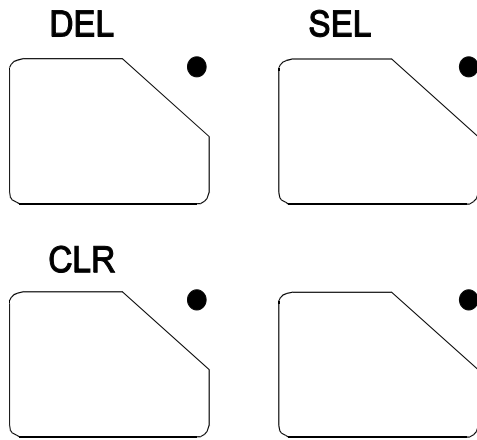

Figure 14-2: M7100^{IP} Scan Model Keypad

GLOSSARY

- Agency** - An agency is composed of multiple fleets. Units can be programmed to initiate agency calls to access multiple fleets (Trunked Mode Only).
- Base/Unit Operation** - A programmed option used in some fleets so units can only hear and talk to a base dispatch unit, not to other mobiles or personals in the group. In this mode of operation, when a unit in a particular group is talking to the base dispatch unit, all other mobile and personal radios in that group will receive a "System Busy" tone if they try to access the system (Trunked Mode Only).
- Control Channel** - A radio channel in a trunked system that is used to digitally communicate with the radios operating on the system when they are not engaged in active voice communications.
- Conventional Channel** - A radio channel (transmit/receive frequency pair) that is allocated for conventional (non-trunked) use and can be manually selected by the operator.
- Conventional Mode** - Communicating on radio channels allocated for conventional use (i.e. conventional system).
- CCT** - Carrier Controlled Timer - a programmable timer that will disable a transmission if the length is exceeded.
- CG** - Channel Guard - a method of controlling speaker mute with a tone or digital code.
- Fleet** - A fleet of users consists of multiple groups (sub-fleets). Radios can be programmed to make fleet calls to simultaneously access multiple user groups (Trunked Mode Only).
- Group or Sub-fleet** - A group of users share the same program group identification number in their mobile and portable radios. All units in the same group will receive a dispatch call placed by any one unit in the group (Trunked Mode only).
- Group Scan** - Programming that allows the radio to monitor many groups simultaneously (multi-group decode), permitting the user to both monitor and receive calls from these groups. The radio can be programmed with a scan hang time which causes the radio to remain on the scanned group for a pre-programmed amount of time, responding only to calls of a higher priority such as priority scan group calls, individual calls, fleet calls, agency calls, etc. When activity on the scan group ends, and the pre-programmed time has expired, the radio returns to monitoring multiple groups (Trunked Mode Only).
- Individual Call** - Every radio in the system is programmed with a unique individual identification code. A mobile or portable unit can be programmed to call another particular unit by selecting the individual by name or ID number (Trunked Mode Only).
- Queueing** - The process that occurs when all channels in a trunked system are busy and calls must be addressed on a priority basis.
- Site Controller** - The computer controlled radio equipment at the repeater site that controls a trunking system.
- System (area)** - The terms "system" and "area" are used interchangeably to refer to the particular group of station repeaters currently providing service to the radio.
- System Manager** - A computer that performs the databasing and system monitoring for the site controller.
- System Scan** - A programmed feature to scan (monitor activity on) separate trunked systems and receive calls on any of these systems (Trunked Mode Only).

- Talk-around Mode** - Also referred to as "direct mode," talk-around provides a direct unit-to-unit short-range communications link. It is intended to maintain communications outside of the main system coverage area.
- Telephone Inter-Connect** - This feature allows the user to initiate or receive telephone calls through the radio if the system is configured for this operation (Trunked Mode Only).
- Trunked Group** - A radio communications path shared by two or more users.
- Trunked Operation** - Trunked Operation refers to the use of a set of radio frequency channels by multiple user groups. By using high-speed digital data, the radio goes to an unused channel when a call is initiated and responds only to calls in the same user group. In this way, conversation privacy between user groups is assured.
- Trunked Radio System** - A radio system in which a limited number of radio channels are dynamically allocated to groups of people for communication purposes.
- Trunked System** - A set of one or more trunked groups.
- T99** - Type 99 - a method of opening mute for selective page operations using sequential tones.
- Wide Area Encode** - A programmed option that ensures all system-scanning mobile and portable radios have time to lock onto the call before the initiating unit is allowed to talk.
- Working Channel** - A radio channel (transmit/receive frequency pair) that is automatically assigned by the site controller for voice or data communications.

WARRANTY

- A. M/A-COM, Inc. (hereinafter "Seller") warrants to the original purchaser for use (hereinafter "Buyer") that Equipment manufactured by or for the Seller shall be free from defects in material and workmanship, and shall conform to its published specifications. With respect to all non-M/A-COM Equipment, Seller gives no warranty, and only the warranty, if any, given by the manufacturer shall apply. Rechargeable batteries are excluded from this warranty but are warranted under a separate Rechargeable Battery Warranty (ECR-7048).
- B. Seller's obligations set forth in Paragraph C below shall apply only to failures to meet the above warranties occurring within the following periods of time from date of sale to the Buyer and are conditioned on Buyer's giving written notice to Seller within thirty (30) days of such occurrence:
1. for fuses and non-rechargeable batteries, operable on arrival only.
 2. for parts and accessories (except as noted in B.1) sold by Seller's Service Parts Operation, ninety (90) days.
 3. for PANTHER™ Series handportable and mobile radios, two (2) years.
 4. for all other equipment of Seller's manufacture, one (1) year.
- C. If any Equipment fails to meet the foregoing warranties, Seller shall correct the failure at its option (i) by repairing any defective or damaged part or parts thereof, (ii) by making available at Seller's factory any necessary repaired or replacement parts, or (iii) by replacing the failed Equipment with equivalent new or refurbished Equipment. Any repaired or replacement part furnished hereunder shall be warranted for the remainder of the warranty period of the Equipment in which it is installed. Where such failure cannot be corrected by Seller's reasonable efforts, the parties will negotiate an equitable adjustment in price. Labor to perform warranty service will be provided at no charge during the warranty period only for the Equipment covered under Paragraph B.3 and B.4. To be eligible for no-charge labor, service must be performed at a M/A-COM factory, by an Authorized Service Center (ASC) or other Servicer approved for these purposes either at its place of business during normal business hours, for mobile or personal equipment, or at the Buyer's location, for fixed location equipment. Service on fixed location equipment more than thirty (30) miles from the Service Center or other approved Servicer's place of business will include a charge for transportation.
- D. Seller's obligations under Paragraph C shall not apply to any Equipment, or part thereof, which (i) has been modified or otherwise altered other than pursuant to Seller's written instructions or written approval or, (ii) is normally consumed in operation or, (iii) has a normal life inherently shorter than the warranty periods specified in Paragraph B, or (iv) is not properly stored, installed, used, maintained or repaired, or, (v) has been subjected to any other kind of misuse or detrimental exposure, or has been involved in an accident.
- E. The preceding paragraphs set forth the exclusive remedies for claims based upon defects in or nonconformity of the Equipment, whether the claim is in contract, warranty, tort (including negligence), strict liability or otherwise, and however instituted. Upon the expiration of the warranty period, all such liability shall terminate. The foregoing warranties are exclusive and in lieu of all other warranties, whether oral, written, expressed, implied or statutory. **NO IMPLIED OR STATUTORY WARRANTIES OF MERCHANTABILITY OR FITNESS FOR PARTICULAR PURPOSE SHALL APPLY. IN NO EVENT SHALL THE SELLER BE LIABLE FOR ANY INCIDENTAL, CONSEQUENTIAL, SPECIAL, INDIRECT OR EXEMPLARY DAMAGES.**

This warranty applies only within the United States.

M/A-COM, Inc.
1011 Pawtucket Blvd.
Lowell, MA 01853
1-877-OPENSKY

M/A-COM, Inc.
221 Jefferson Ridge Parkway
Lynchburg, VA 24501
1-800-528-7711

ECR-7047C

NOTES

Installation Manual

MM102342V1
Rev. Cp1, Mar-04

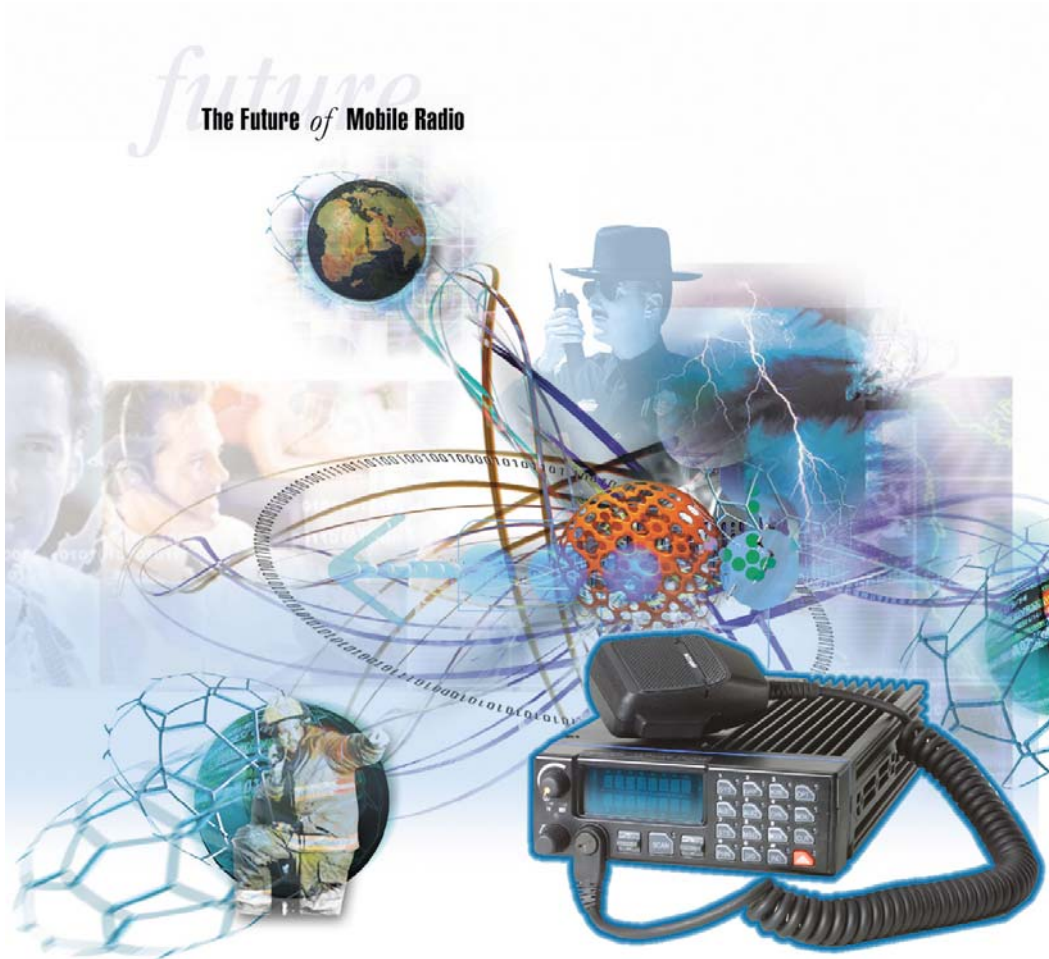

M7100^{IP} Series Mobile Radio

tyco
Electronics

M/A-COM

REVISION HISTORY

REV	DATE	SUMMARY OF CHANGES
A	Feb 2004	Initial release
B	Mar 2004	Add MPE and FCC information for VHF M7100 ^{IP} radio.
C	Mar. 2004	Append MPE and FCC information for UHF-L M7100 ^{IP} radio.

SUPPLEMENTARY INFORMATION

At this time, the M7100^{IP} mobile radio may not be operated while in a desktop station in the European Community since it does not meet immunity requirements when operated in this mode. The M7100^{IP} mobile radio can be used in both trunked and conventional applications.

ACKNOWLEDGEMENTS

This device is made under license under one or more of the following US patents: 4,590,473; 4,636,791; 5,148,482; 5,185,796; 5,271,017; 5,377,229; 4,716,407; 4,972,460; 5,502,767; 5,146,497; 5,164,986; 5,185,795.

The voice coding technology embodied in this product is protected by intellectual property rights including patent rights, copyrights, and trade secrets of Digital Voice Systems, Inc. The user of this technology is explicitly prohibited from attempting to decompile, reverse engineer, or disassemble the Object Code, or in any other way convert the Object Code into human-readable form.

CREDITS

EDACS is a registered trademark and ProGrammer, SCAT, Failsoft, ProSound, ProScan, Aegis, ProFile, ProVoice, and G-STAR are trademarks of M/A-COM, Inc.

Torx is a registered trademark of CAMCAR Division TEXTRON, Inc.

POZIDRIV is a registered trademark of Phillips International Company.

IMBE is a registered trademark of Digital Voice Systems, Inc.

Molex is a registered trademark of Molex Incorporated.

All other brand and product names are trademarks, registered trademarks, or service marks of their respective holders.

NOTICE!

This manual covers M/A-COM, Inc. products manufactured and sold by M/A-COM, Inc.

NOTICE!

Repairs to this equipment should be made only by an authorized service technician or facility designated by the supplier. Any repairs, alterations or substitution of recommended parts made by the user to this equipment not approved by the manufacturer could void the user's authority to operate the equipment in addition to the manufacturer's warranty.

This manual is published by **M/A-COM, Inc.**, without any warranty. Improvements and changes to this manual necessitated by typographical errors, inaccuracies of current information, or improvements to programs and/or equipment, may be made by **M/A-COM, Inc.**, at any time and without notice. Such changes will be incorporated into new editions of this manual. No part of this manual may be reproduced or transmitted in any form or by any means, electronic or mechanical, including photocopying and recording, for any purpose, without the express written permission of **M/A-COM, Inc.**

Copyright© 2004 M/A-COM, Inc. All rights reserved.

TABLE OF CONTENTS

	<i>Page</i>
TABLE OF CONTENTS	3
SAFETY SYMBOL CONVENTIONS	4
RF ENERGY EXPOSURE INFORMATION	5
RF ENERGY EXPOSURE INFORMATION.....	5
COMPLIANCE WITH RF EXPOSURE STANDARDS	6
OPERATION SAFETY RECOMMENDATIONS	9
TRANSMITTER HAZARDS	9
SAFE DRIVING RECOMMENDATIONS	10
OPERATING RULES AND REGULATIONS	11
OPERATING TIPS	12
INTRODUCTION	13
UNPACKING AND CHECKING EQUIPMENT	14
PLANNING THE INSTALLATION	19
EQUIPMENT REQUIRED	21
INSTALLATION	22
RUNNING CABLES	22
CONTROL UNIT MOUNTING	30
PIGTAIL BRACKET	30
SPEAKER	33
MICROPHONE HANGER AND/OR HOOKSWITCH	
MOUNTING.....	34
SIREN AND LIGHT	34
RADIO MOUNTING AND FINAL HOOK-UP	35
DUAL CONTROL UNITS	39
PRE-INSTALLATION PROGRAMMING PROCEDURE	
WITH PROGRAMMER - FRONT MOUNT	40
PRE-INSTALLATION PROGRAMMING PROCEDURE	
WITH PROGRAMMER - REMOTE MOUNT	42
INSTALLATION INSTRUCTIONS FOR FRONT MOUNT	
DUAL CONTROL UNITS	44
INSTALLATION INSTRUCTIONS FOR REMOTE MOUNT	
DUAL CONTROL UNITS	47
FIELD PROGRAMMING WITH PROGRAMMER – DUAL	
CONTROL UNITS	50
DUAL RADIO UNITS	56
PRE-INSTALLATION PROGRAMMING PROCEDURE	
WITH PROGRAMMER – DUAL RADIO UNITS	56
PROGRAMMING WITH PC PROGRAMMER – DUAL	
RADIO UNITS	60
ANTENNA	65
WARRANTY	66

SAFETY SYMBOL CONVENTIONS

The following conventions are used throughout this manual to alert the user to general safety precautions that must be observed during all phases of operation, service, and repair of this product. Failure to comply with these precautions or with specific warnings elsewhere in this manual violates safety standards of design, manufacture, and intended use of the product. M/A-COM, Inc. assumes no liability for the customer's failure to comply with these standards.



The **WARNING** symbol calls attention to a procedure, practice, or the like, which, if not correctly performed or adhered to, could result in personal injury. Do not proceed beyond a WARNING symbol until the conditions identified are fully understood or met.



The **CAUTION** symbol calls attention to an operating procedure, practice, or the like, which, if not performed correctly or adhered to, could result in damage to the equipment or severely degrade the equipment performance.



The **NOTE** symbol calls attention to supplemental information, which may improve system performance or clarify a process or procedure.



The **ESD** symbol calls attention to procedures, practices, or the like, which could expose equipment to the effects of Electro-Static Discharge. Proper precautions must be taken to prevent ESD when handling circuit modules.

RF ENERGY EXPOSURE INFORMATION

RF ENERGY EXPOSURE AWARENESS, CONTROL INFORMATION, AND OPERATION INSTRUCTIONS FOR FCC OCCUPATIONAL USE REQUIREMENTS

BEFORE USING YOUR MOBILE TWO-WAY RADIO, READ THIS IMPORTANT RF ENERGY AWARENESS AND CONTROL INFORMATION AND OPERATIONAL INSTRUCTIONS TO ENSURE COMPLIANCE WITH THE FCC'S RF EXPOSURE GUIDELINES.

NOTICE: This radio is intended for use in occupational/controlled conditions, where users have full knowledge of their exposure and can exercise control over their exposure to meet FCC limits. This radio device is NOT authorized for general population, consumer, or any other use.

This two-way radio uses electromagnetic energy in the radio frequency (RF) spectrum to provide communications between two or more users over a distance. It uses RF energy or radio waves to send and receive calls. RF energy is one form of electromagnetic energy. Other forms include, but are not limited to, electric power, sunlight, and x-rays. RF energy, however, should not be confused with these other forms of electromagnetic energy, which, when used improperly, can cause biological damage. Very high levels of x-rays, for example, can damage tissues and genetic material.

Experts in science, engineering, medicine, health, and industry work with organizations to develop standards for exposure to RF energy. These standards provide recommended levels of RF exposure for both workers and the general public. These recommended RF exposure levels include substantial margins of protection. All two-way radios marketed in North America are designed, manufactured, and tested to ensure they meet government established RF exposure levels. In addition, manufacturers also recommend specific operating instructions to users of two-way radios. These instructions are important because they inform users about RF energy exposure and provide simple procedures on how to control it. Please refer to the following websites for more information on what RF energy exposure is and how to control your exposure to assure compliance with established RF exposure limits.

<http://www.fcc.gov/oet/rfsafety/rf-faqs.html>

<http://www.osha.gov/SLTC/radiofrequencyradiation/index.html>

Federal Communications Commission Regulations

Your M/A-COM, Inc. M7100^{IP} mobile two-way radio is designed and tested to comply with the FCC RF energy exposure limits for mobile two-way radios before it can be marketed in the United States. When two-way radios are used as a consequence of employment, the FCC requires users to be fully aware of and able to control their exposure to meet occupational requirements. Exposure awareness can be facilitated by the use of a label directing users to specific user awareness information. Your M/A-COM, Inc. M7100^{IP} two-way radio has an RF exposure product label. Also, your M7100^{IP} Installation and Operator's Manuals include information and operating instructions required to control your RF exposure and to satisfy compliance requirements.

COMPLIANCE WITH RF EXPOSURE STANDARDS

Your M/A-COM, Inc. M7100^{IP} mobile two-way radio is designed and tested to comply with a number of national and international standards and guidelines (listed below) regarding human exposure to RF electromagnetic energy. This radio complies with the IEEE and ICNIRP exposure limits for occupational/controlled RF exposure environment at duty factors of up to 50% talk-50% listen and is authorized by the FCC for occupational use. In terms of measuring RF energy for compliance with the FCC exposure guidelines, your radio antenna radiates measurable RF energy only while it is transmitting (talking), not when it is receiving (listening) or in standby mode.

Your M/A-COM, Inc. M7100^{IP} mobile two-way radio complies with the following RF energy exposure standards and guidelines:

- United States Federal Communications Commission (FCC), Code of Federal Regulations; 47 CFR §§ 2 sub-part J.
- American National Standards Institute (ANSI)/Institute of Electrical and Electronic Engineers (IEEE) C95.1-1992.
- Institute of Electrical and Electronic Engineers (IEEE) C95.1-1999.

NOTE – Table 1 lists the recommended minimum lateral distance for bystanders in an uncontrolled and controlled environment, from transmitting types of antennas (i.e., monopoles over a ground plane, or dipoles) at rated radio power for mobile radios installed in a vehicle.

Table 1: Rated Power and Recommended Minimum Lateral Distance

MOBILE RADIO FREQUENCY SPLIT	RATED POWER OF VEHICLE-INSTALLED MOBILE TWO-WAY RADIO	RECOMMENDED MINIMUM LATERAL DISTANCE FROM TRANSMITTING ANTENNA	
		Controlled	Uncontrolled
VHF	110 Watts	92.87 cm	207.67 cm
UHF-L	50 Watts (Antenna P/N: AN102800V1)	50.89 cm	113.79 cm

Mobile Antennas

Install the radio’s antenna (M/A-COM part number 19B209568P6 for VHF radios and AN102800V1 for UHF-L radios) in the center of the vehicle’s roof. These mobile antenna installation guidelines are limited to metal body motor vehicles or vehicles with appropriate ground planes. The antenna installation should additionally be in accordance with the following.

1. The requirements of the antenna manufacturer/supplier included with the antenna.
2. Instructions in the M7100^{IP} Radio Installation Manual, including minimum antenna cable lengths.
3. The installation manual providing specific information of how to install the antennas to facilitate recommended operating distances to all potentially exposed persons.

Use only the M/A-COM approved/supplied antenna(s) or approved replacement antenna. Unauthorized antennas, modifications, or attachments could damage the radio and may violate FCC regulations.

Approved Accessories

This radio has been tested and meets the FCC RF exposure guidelines when used with the M/A-COM accessories supplied or designated for use with this product. Use of other accessories may not ensure compliance with the FCC’s RF exposure guidelines, and may violate FCC regulations.

For a list of M/A-COM approved accessories refer to the product manuals, M/A-COM’s Products and Services Catalog, or contact M/A-COM at 1-800-528-7711.

Contact Information

For additional information on exposure requirements or other information, contact M/A-COM, Inc. at 1-800-528-7711 or at <http://www.macom-wireless.com>.

OPERATION SAFETY RECOMMENDATIONS

TRANSMITTER HAZARDS



WARNING

The operator of any mobile radio should be aware of certain hazards common to the operation of vehicular radio transmitters. **A list of several possible hazards is given.**

- **Explosive Atmospheres** – Just as it is dangerous to fuel a vehicle with the motor running, similar hazards exist when operating a mobile radio. Be sure to turn the radio off while fueling a vehicle. Do not carry containers of fuel in the trunk of a vehicle if the radio is mounted in the trunk.

Areas with potentially explosive atmosphere are often, but not always, clearly marked. Turn OFF your radio when in any area with a potentially explosive atmosphere. It is rare, but not impossible that the radio or its accessories could generate sparks.

- **Interference to Vehicular Electronics Systems** – Electronic fuel injection systems, electronic anti-skid braking systems, electronic cruise control systems, etc., are typical electronic systems that can malfunction due to the lack of protection from radio frequency energy present when transmitting. If the vehicle contains such equipment, consult the dealer and enlist their aid in determining the expected performance of electronic circuits when the radio is transmitting.
- **Electric Blasting Caps** – To prevent accidental detonation of electric blasting caps, **DO NOT** use two-way radios within 1000 feet of blasting operations. Always obey the “**Turn Off Two-Way Radios**” signs posted where electric blasting caps are being used. (OSHA Standard: 1926-900)
- **Liquefied Petroleum (LP) Gas Powered Vehicles** – Mobile radio installations in vehicles powered by liquefied petroleum gas with the LP gas container in the trunk or other sealed-off space within the interior of the vehicle must conform to the **National Fire Protection Association** standard **NFPA 58** requiring:
 - The space containing the radio equipment shall be isolated by a seal from the space containing the LP gas container and its fittings.
 - Outside filling connections shall be used for the LP gas container.
 - The LP gas container shall be vented to the outside of the vehicle.

SAFE DRIVING RECOMMENDATIONS

(Recommended by AAA)

- Read the literature on the safe operation of the radio.
- Keep both hands on the steering wheel and the microphone in its hanger whenever the vehicle is in motion.
- Place calls only when the vehicle is stopped.
- When talking from a moving vehicle is unavoidable, drive in the slower lane. Keep conversations brief.
- If a conversation requires taking notes or complex thought, stop the vehicle in a safe place and continue the call.
- Whenever using a mobile radio, exercise caution.

OPERATING RULES AND REGULATIONS

Two-way FM radio systems must be operated in accordance with the rules and regulations of the local, regional, or national government.

In the United States, the M7100^{IP} Series mobile radio must be operated in accordance with the rules and regulations of the Federal Communications Commission (FCC). As an operator of two-way radio equipment, you must be thoroughly familiar with the rules that apply to your particular type of radio operation. Following these rules helps eliminate confusion, assures the most efficient use of the existing radio channels, and results in a smoothly functioning radio network.

When using your two-way radio, remember these rules:

- It is a violation of FCC rules to interrupt any distress or emergency message. As your radio operates in much the same way as a telephone “**party line**,” always listen to make sure that the channel is clear before transmitting. Emergency calls have priority over all other messages. If someone is sending an emergency message – such as reporting a fire or asking for help in an accident – **KEEP OFF THE AIR!**
- The use of profane or obscene language is prohibited by Federal law.
- It is against the law to send false call letters or false distress or emergency messages. The FCC requires that you keep conversations brief and confine them to business. To save time, use coded messages whenever possible.
- Using your radio to send personal messages (except in an emergency) is a violation of FCC rules. You may send only those messages that are essential for the operation of your business.
- It is against Federal law to repeat or otherwise make known anything you overhear on your radio. Conversations between others sharing your channel must be regarded as confidential.
- The FCC requires that you identify yourself at certain specific times by means of your call letters. Refer to the rules that apply to your particular type of operation for the proper procedure.
- No changes or adjustments shall be made to the equipment except by an authorized or certified electronics technician.

IMPORTANT!

Under U.S. law, operation of an unlicensed radio transmitter within the jurisdiction of the United States may be punishable by a fine of up to \$10,000, imprisonment for up to two (2) years, or both.

OPERATING TIPS

The following conditions tend to reduce the effective range of two-way radios and should be avoided whenever possible:

- Operating the radio in areas of low terrain, or while under power lines or bridges
- Obstructions such as mountains and buildings
- In areas where transmission or reception is poor, some improvement can be obtained by moving a few yards in another direction or moving to a higher elevation.

INTRODUCTION

This manual contains installation instructions for the M7100^{IP} Series Mobile Radio Unit and associated accessories. These instructions cover the mounting and cabling of the radio; interconnection and wiring diagrams are provided for reference.

The radio should be programmed prior to installation. Refer to the Software Release Notes with TQS3385 or TQS3389 for equipment and compatibility requirements.

Shop Programming Cable	TQ3409 (CA101288V15)
Field Programming Cable	TQ3410 (CA101287V1)
ProGrammer™ Software	TQS3389
	or
Conventional ProGrammer Software	TQS3385

UNPACKING AND CHECKING EQUIPMENT

Carefully unpack the radio and identify each item in the shipping container (some items that typically ship are listed below). If damage has occurred to the equipment during shipment, file a claim with the carrier immediately. Refer to Table 2 and Table 3 in this manual or to M/A-COM's Products and Services catalog for options and accessories for the M7100^{IP} Series Mobile Radio.

- M7100^{IP} Series Mobile Radio Unit
- Control Unit
- Microphone
- Speaker
- Power Cable
- Control Cable
- Front Mount Bracket Kit
or
- Remote Mount Bracket Kit
with
- Control Unit Mount Kit
- Operator's Manual (MM102341V1)
- Installation Manual (MM102342V1)



Figure 1 – M7100^{IP} Series Mobile Radio Components



Figure 2 – Rear Angle View of Radio

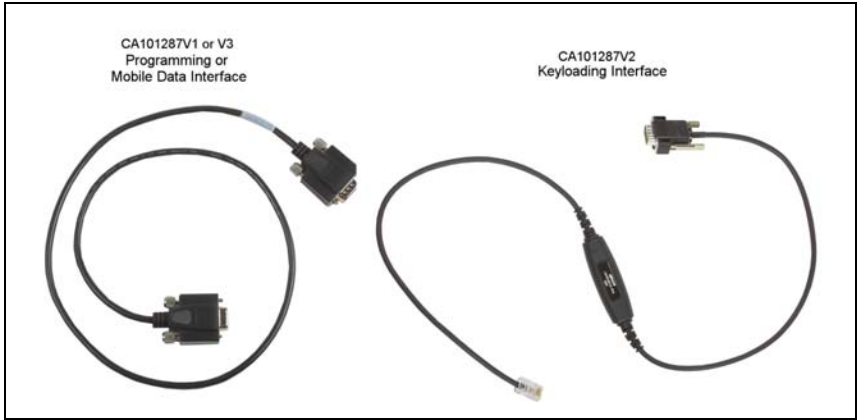

Figure 3 – Interface Cables



Figure 4 - Option Cables

Table 2: M7100^{IP} Option and Accessory Kits (60W TX and Above)

OPTION	DESCRIPTION
<i>ANTENNAS</i>	
MAHG-AN3G	Antenna, 136-870 MHz, ¼ Wave, TNC, Roof Mount (19B209568P6)
<i>REMOTE MOUNT ACCESSORIES (60W TX AND ABOVE)</i>	
MAHG-ZN5Y	Includes remote mount radio front cover, front cover logo label, remote mount accessory cable, remote mount control cable, 7.5M power cable, microphone hanger kit, remote mount radio mounting kit, control unit mounting kit, DB15-HD connector to control unit mounting kit, and mobile speaker.
<i>HAND HELD CONTROLLER (WITH SIREN) ACCESSORIES, REMOTE MOUNT (60W TX AND ABOVE)</i>	
MAHG-ZN6C	Includes Hand Held Controller (HHC) with mounting bracket, HHC interface cable (with siren interface), remote radio front cover, front cover logo label, remote mount accessory cable, remote mount control cable, 7.5M power cable, remote mount radio mounting kit, mobile speaker, and HHC operator and installation manuals.
<i>HAND HELD CONTROLLER (WITHOUT SIREN) ACCESSORIES, REMOTE MOUNT (60W TX AND ABOVE)</i>	
MAHG-ZN6A	Includes Hand Held Controller (HHC) with mounting bracket, HHC interface cable, remote radio front cover, front cover logo label, remote mount accessory cable, remote mount control cable, 7.5M power cable, remote mount radio mounting kit, mobile speaker, and HHC operator and installation manuals.
<i>DUAL CONTROL, SCAN CONTROL UNIT, LONG PACKAGE</i>	
MAHG-ZN6J	Includes scan control unit, control unit logo label, dual control cable (9M), accessory cable, control unit mounting kit, microphone hanger kit, relay kits (qty 2), mobile speaker, connector support bracket, and M7100 ^{IP} operator's manual.
<i>DUAL CONTROL, SYSTEM CONTROL UNIT, LONG PACKAGE</i>	
MAHG-ZN6K	Includes system control unit, system control unit keycap kit, control unit logo label, dual control cable (9M), accessory cable, control unit mounting kit, microphone hanger kit, relay kits (qty 2), mobile speaker, connector support bracket, and M7100 ^{IP} operator's manual.
<i>DUAL CONTROL, HHC (WITH SIREN), LONG PACKAGE</i>	
MAHG-ZN6M	Includes HHC with mounting bracket, HHC interface cable (with Siren interface), dual control cable (9M), accessory cable, relay kits (qty 2), mobile speaker, connector support bracket, and HHC installation and operator's manuals.
<i>DUAL CONTROL, HHC (WITHOUT SIREN), LONG PACKAGE</i>	
MAHG-ZN6L	Includes HHC with mounting bracket, HHC interface cable, dual control cable (9M), accessory cable, relay kits (qty 2), mobile speaker, connector support bracket, and HHC installation and operator's manuals.
<i>DUAL RADIO, HHC (WITHOUT SIREN), LONG PACKAGE</i>	
MAHG-ZN6P	Includes dual radio cable, programming extension cable, 7.5M power cable, remote radio front cover, front cover logo label, remote mount radio mounting kit, connector support bracket, DB15-HD connector to control unit mounting kit, and DB15-HD connector to radio mounting kit.

Refer to M/A-COM's Products and Services Catalog for the full line of options and accessories available for use with the M7100^{IP} mobile radio.

Table 3: M7100^{IP} Option and Accessory Kits – (50W TX and Below)

OPTION	DESCRIPTION
ANTENNAS	
MAHG-AN3G	Antenna, 136-870 MHz, ¼ Wave, TNC, Roof Mount, 19B209568P6
FRONT MOUNT ACCESSORIES (50W TX AND BELOW)	
MAHG-ZN5W	Includes front mount accessory cable assembly, 7.5M power cable, microphone hanger kit, front mount radio mounting kit, DB15-HD connector to radio mounting bracket kit, and mobile speaker.
REMOTE MOUNT ACCESSORIES (50W TX AND BELOW)	
MAHG-ZN5X	Includes remote mount radio front cover, front cover logo label, remote mount accessory cable, remote mount control cable, 7.5M power cable, microphone hanger kit, remote mount radio mounting kit, control unit mounting kit, DB15-HD connector to control unit mounting kit, and mobile speaker.
HAND HELD CONTROLLER (WITH SIREN) ACCESSORIES, REMOTE MOUNT (50W TX AND BELOW)	
MAHG-ZN6B	Includes Hand Held Controller (HHC) with mounting bracket, HHC interface cable (with siren interface), remote radio front cover, front cover logo label, remote mount accessory cable, remote mount control cable, 7.5M power cable, remote mount radio mounting kit, mobile speaker, and HHC operator and installation manuals.
HAND HELD CONTROLLER (WITHOUT SIREN) ACCESSORIES, REMOTE MOUNT (50W TX AND BELOW)	
MAHG-ZN5Z	Includes Hand Held Controller (HHC) with mounting bracket, HHC interface cable, remote radio front cover, front cover logo label, remote mount accessory cable, remote mount control cable, 7.5M power cable, remote mount radio mounting kit, mobile speaker, and HHC operator and installation manuals.
DUAL CONTROL, SCAN CONTROL UNIT, SHORT PACKAGE	
MAHG-ZN6S	Includes scan control unit, control unit logo label, dual control cable (9M), accessory cable, control unit mounting kit, microphone hanger kit, relay kits (qty 2), mobile speaker, connector support bracket, and M7100 ^{IP} operator's manual.
DUAL CONTROL, SYSTEM CONTROL UNIT, SHORT PACKAGE	
MAHG-ZN6T	Includes system control unit, system control unit keycap kit, control unit logo label, dual control cable (9M), accessory cable, control unit mounting kit, microphone hanger kit, relay kits (qty 2), mobile speaker, connector support bracket, and M7100 ^{IP} operator's manual.
DUAL CONTROL, HHC (WITH SIREN), SHORT PACKAGE	
MAHG-ZN6V	Includes HHC with mounting bracket, HHC interface cable (with Siren interface), dual control cable (9M), accessory cable, relay kits (qty 2), mobile speaker, connector support bracket, and HHC installation and operator's manuals.
DUAL CONTROL, HHC (WITHOUT SIREN), SHORT PACKAGE	
MAHG-ZN6U	Includes HHC with mounting bracket, HHC interface cable, dual control cable (9M), accessory cable, relay kits (qty 2), mobile speaker, connector support bracket, and HHC installation and operator's manuals.
DUAL RADIO, HHC (WITHOUT SIREN), SHORT PACKAGE	
MAHG-ZN6N	Includes dual radio cable, programming extension cable, 7.5M power cable, remote radio front cover, front cover logo label, remote mount radio mounting kit, connector support bracket, DB15-HD connector to control unit mounting kit, and DB15-HD connector to radio mounting kit.

Refer to M/A-COM's Products and Services Catalog for the full line of options and accessories available for use with the M7100^{IP} mobile radio.

PLANNING THE INSTALLATION

Figure 5 provides an example of a typical mobile radio remote mount installation. Before starting, plan the radio installation carefully so that it will be:

- Safe for the operator and passengers,
- Away from airbag deployment area,
- Convenient for the operator to use,
- Neat,
- Protected from water damage,
- Easy to service,
- Out of the way of auto mechanics, and
- Out of the way of passengers.

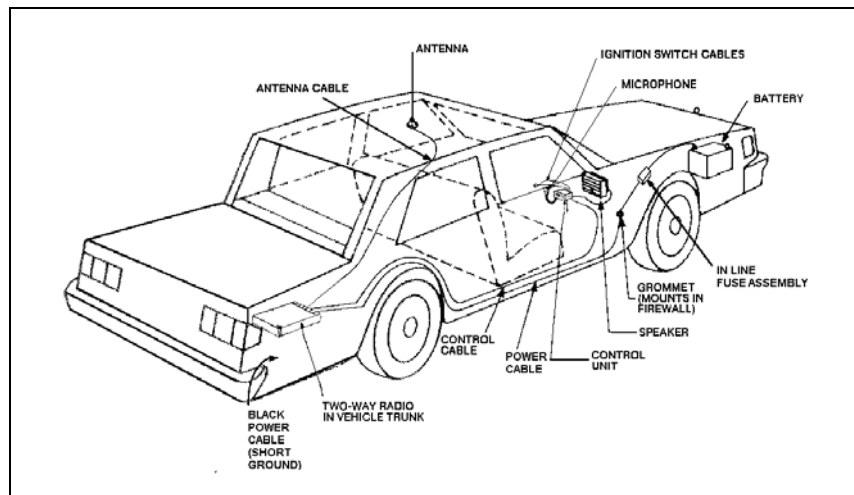

Figure 5 – Typical Installation (Remote Mount Shown)

It is suggested that the radio be installed by one of the many M/A-COM Authorized Service Centers located throughout the United States. Their experienced service personnel can provide a proper radio installation and make any final adjustments that may be needed.



Vehicular Electronics - Electronic fuel injection systems, electronic anti-skid braking systems, air bags, electronic cruise control systems, etc., are typical of the types of electronic devices which might be prone to malfunction due to the lack of protection from radio frequency energy present when a radio is transmitting. If the vehicle contains such equipment, consult the dealer to determine if such electronic equipment will perform normally when the radio is transmitting.



Air Bags – For driver and passenger safety, avoid mounting the radio above or near airbag deployment areas. Note that vehicles might contain front driver and passenger side airbags as well as side airbags. For occupant safety, verify the location of all airbags before installing radio equipment.



For passenger safety, mount the radio securely so that the unit will not break loose in the event of a collision. This is especially important in station wagons, vans and similar type installations where a loose radio could be extremely dangerous to the vehicle occupants.

EQUIPMENT REQUIRED

The equipment required for installing the M7100^{IP} Series Mobile Radio is listed below:

- Crimping tool for fuse holder
- Electric drill for drilling mounting holes
- Drills and circle cutters, as follows:
 - No. 31 (1/8-inch) drill
 - No. 27 (9/64-inch) drill
 - 5/8-inch drill or circle cutter
 - 3/4-inch circle cutter, hole saw or socket punch
- Phillips and flat-blade screwdrivers
- POZIDRIV[®] driver
- No. 20 Torx[®] driver



Be careful to avoid damaging some vital part (fuel tank, transmission housing, etc.) of the vehicle when drilling mounting holes. Always check to see how far the mounting screws will extend below the mounting surface before installing.



If pilot holes must be drilled, remove all metal shavings from drilling holes before installing screws.

INSTALLATION

RUNNING CABLES

To assure the feasibility of the planned cable routings, it is suggested that the cables be run before mounting the radio. The M7100^{IP} Series mobile radio may be installed as a Front Mount or a Remote Mount. The type of mount, the application and the options to be installed should be considered when planning the cable runs. Figure 6 and Figure 7 provide Interconnection Diagrams for typical installations. Figure 6 and Figure 7 should be referenced throughout this manual and throughout the installation.

Be sure to leave some slack in each cable going to the radio so that the radio may be pulled out for servicing with the power applied and antenna attached. Coil any surplus cables and secure them out of the way. Try to route the cables away from locations where they will be exposed to heat (exhaust pipes, mufflers, tailpipes, etc.), battery acid, sharp edges or mechanical damage or where they will be a nuisance or hazard to automobile mechanics, the driver or passengers. Keep wiring away from electronic computer modules, other electronic modules and ignition circuits to help prevent interference to these components and radio equipment.

In addition, try to utilize existing holes in the firewall, trunk wall and the channels above or beneath doors. Channels through door and window columns that are convenient for running cables may also be used, unless rigid or flexible conduit is to be installed for cable runs.

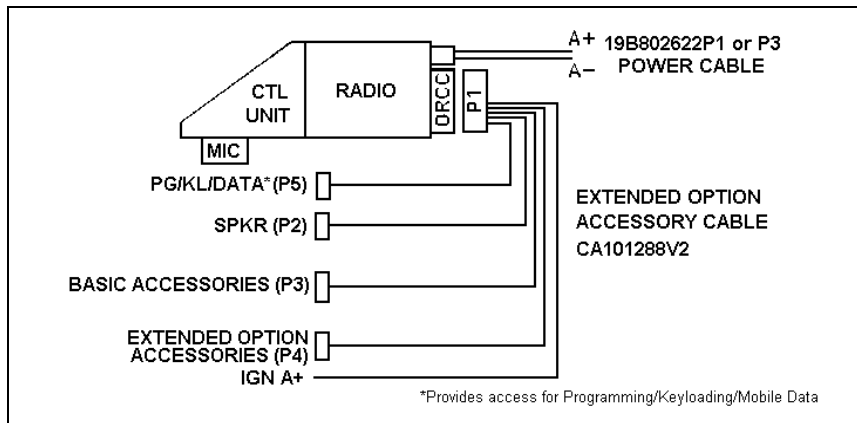

Figure 6 – Front Mount Extended Option Accessory Interconnections

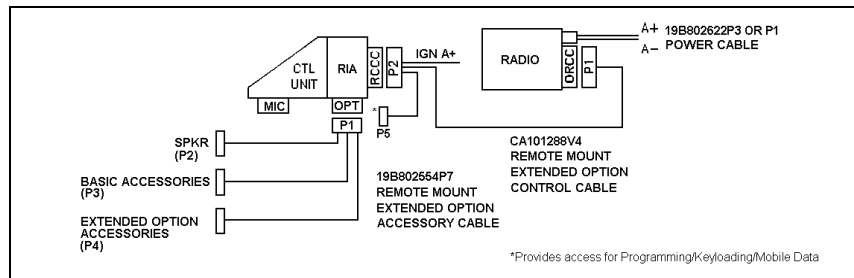

Figure 7 – Remote Mount Extended Option Accessory Interconnections

Power Cable

The power cable consists of a red lead A+ and a black lead A- connected to a molded 2-pin power connector and supplied with ring terminals (refer to Figure 8). To install the power cable:

1. Drill a 5/8-inch hole in the firewall for the cable run and insert the rubber grommet. Run the cable through this grommet to the battery location. Secure the cable at several locations within the engine compartment to prevent possible damage to cable.
2. Strip back the insulation approximately 3/8 of an inch from the end of the black lead. Slide one of the large heat shrink sleeves onto the wire and crimp a battery ring terminal onto this lead. Heat-shrink the sleeve over the crimp connection. Connect the black lead directly to the ground frame member.
3. Cut off 12-18 inches from the red lead. Strip back the insulation approximately 3/8 of an inch on each end of the wires. Insert the wire ends into the small openings at the end of each fuse holder section and crimp a fuse connector to each wire. Prepare the other end of the short wire in the same manner as in Step 2 of this procedure and connect to the positive (+) terminal of the battery.



NOTE

Do not install the fuse until the installation is completed and all connections have been checked.



NOTE

Power Cable 19B802622P3 is used only with radios with 50 watts or less RF power output. 19B802622P1 is used for radios with 60 watts or more RF power output.

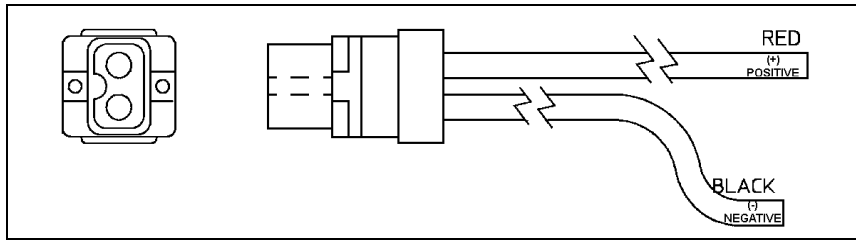

Figure 8 – Power Cable 19B802622P3

Accessory Cable

Front Mount

The Front Mount Extended Option Accessory Cable, at one end, consists of the extended options plug (P4); basic accessories connector (P3); connection for field programming, keyloading, and mobile data applications (P5); the speaker connector (P2); and the ignition sense lead. At the other end is plug P1. P1 connects to the Option/Remote Control Connector (ORCC) which is mounted on the back of the radio (refer to Figure 9).

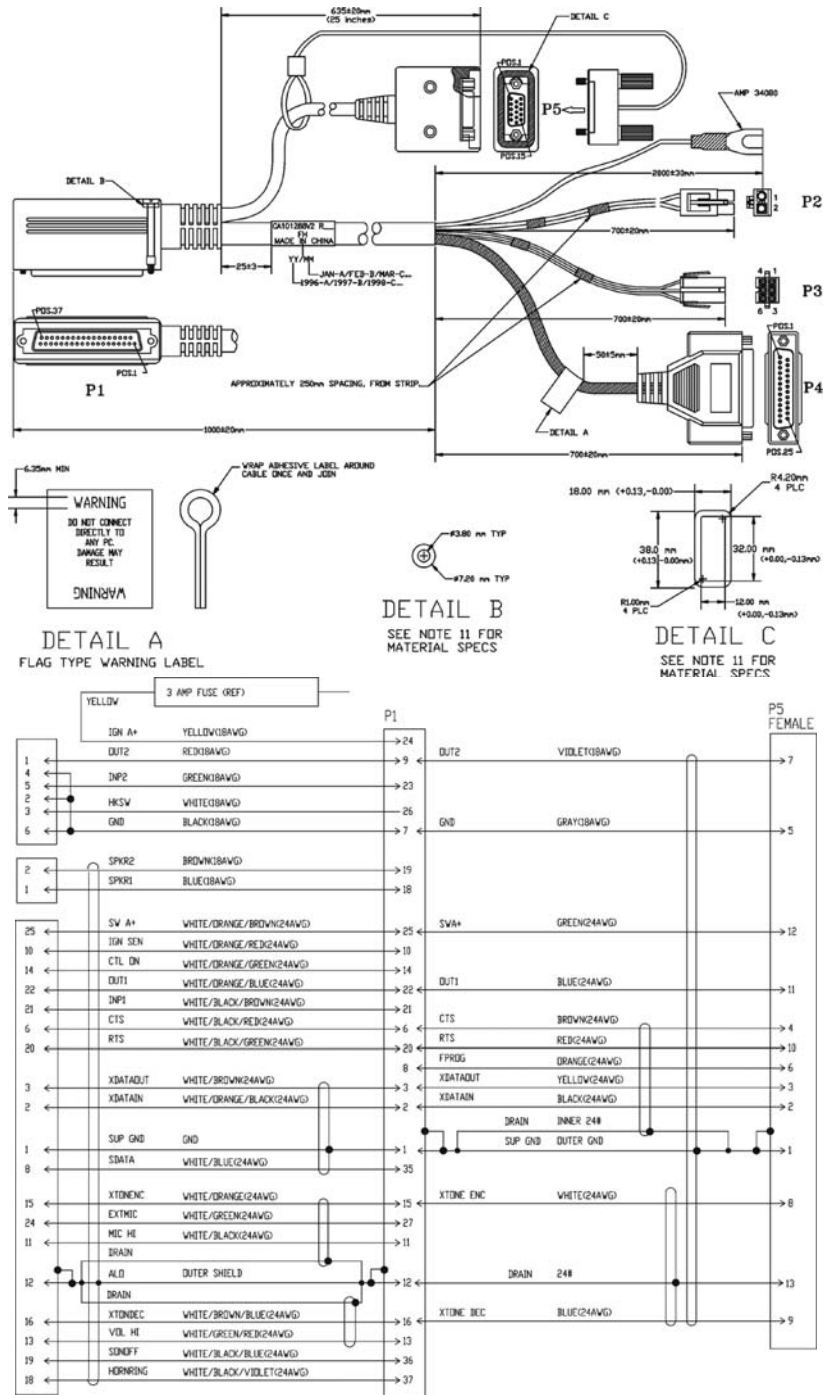

Figure 9 - Front Mount Extended Option Accessory Cable CA101288V2

Remote Mount

The Remote Mount Extended Option Accessory Cable, at one end, consists of the extended option plug (P4), the basic accessories connector (P3), and the speaker connector (P2). At the other end is the plug P1. P1 will connect to the Option Connector (OPT) which is mounted on the back of the Radio Interface Adapter (RIA). See Figure 10.

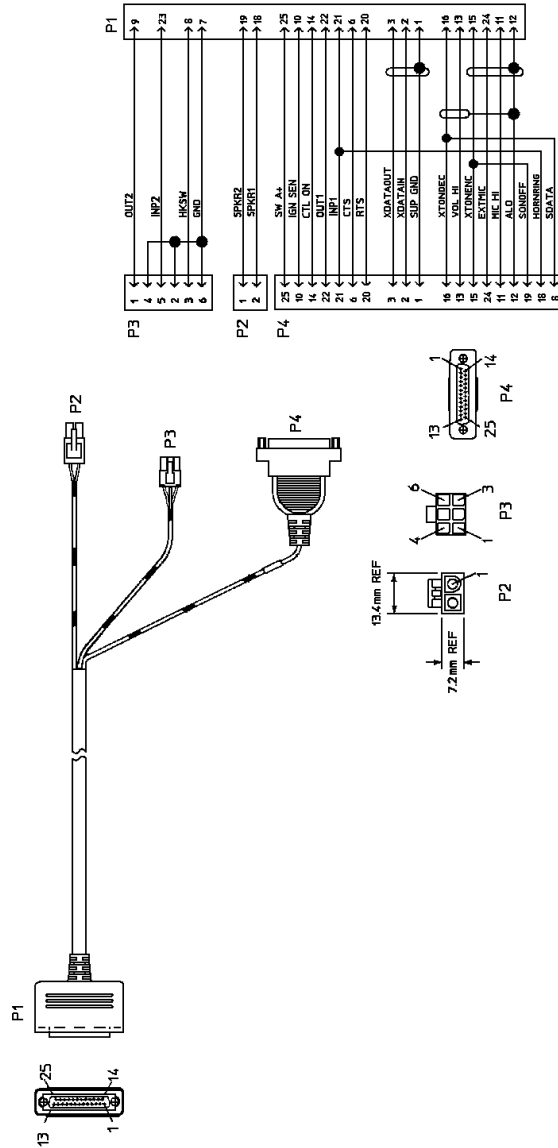

Figure 10 - Remote Mount Extended Option Accessory Cable
19B802554P7

Ignition Sense (All Applications)



NOTE

The radio, as shipped from the factory, has the "ignition sense" feature disabled. As such, the radio will be powered ON or OFF as determined by the front panel ON/OFF/VOLUME control only (assuming A+ and A- are connected). If it is desired to enable the "ignition sense" feature, open the top cover of the radio and remove the shield from logic PWB. Slide switch S951 from position 3-2 to 1-2. Replace shield and top cover. Be sure to apply correct torque to screws holding top cover in place (refer to the appropriate Maintenance Manual).



NOTE

The "Accessory" point should drop to ZERO volts when cranking the engine and return to +12 volts after the engine is started. If a point is chosen that drops to a voltage between zero and +12 volts, the radio might execute a power-up cycle several times during start up. It is recommended that the terminal be measured with a voltmeter to be sure it shuts off (goes to zero volts) during the cranking of the engine.

The fuse holder must be attached to the yellow sense lead along with the ring terminal as follows:

1. Cut the yellow sense lead approximately 6-12" from the end that will be connected to the ignition sense point.
2. Strip the insulation from each end of the short lead and from the end of the long lead at least 3/8".
3. Insert the stripped end of the long lead and one end of the short lead into the narrow end of each fuse holder half.
4. Crimp the leads in the fuse holder halves with a crimping tool.
5. Insert the 3-amp fuse into one end of the fuse holder and join the two fuse holder halves firmly together.
6. Attach the ring terminal to the end of the short lead and connect this lead to the ignition "ON" sense point [preferably an "Accessory" point (in the vehicle fuse panel) that is switched on when the vehicle ignition switch is in the ACCESSORY and RUN positions].



Certain problems might be encountered when accessory equipment is connected to the ignition or accessory lines of the vehicle, where these lines can have large filter capacitors and a leakage path present. If the radio does not turn off within a reasonable amount of time after the ignition is turned off, first try a different accessory or ignition sense pick-up point in the vehicle. Many vehicles have more than one circuit that is switched by the ignition switch, and one might be available that does not have large filter capacitors or a leakage path present.

If a different pick-up point cannot be found, add a 470-ohm, 1-watt resistor from the ignition sense pick-up point to ground. This will discharge the capacitor(s) or reduce the leakage voltage to a low value. Current drain through this resistor will be minimal (less than 0.03A) when the ignition is switched on.

Control Cable (Remote Mount Only)

The Control Cable is used to connect the Control Unit (through the RIA) to the Radio Transceiver in remote applications. Plug P2, at one end, connects to the Remote Control Cable Connector (RCCC) mounted on the back of the RIA. The Ignition Sense wire is also part of P2. The connection, P5, is available for field programming, keyloading, or mobile data applications. The other end of the Control Cable (P1) connects to the ORCC mounted on the back of the radio. See Figure 11.

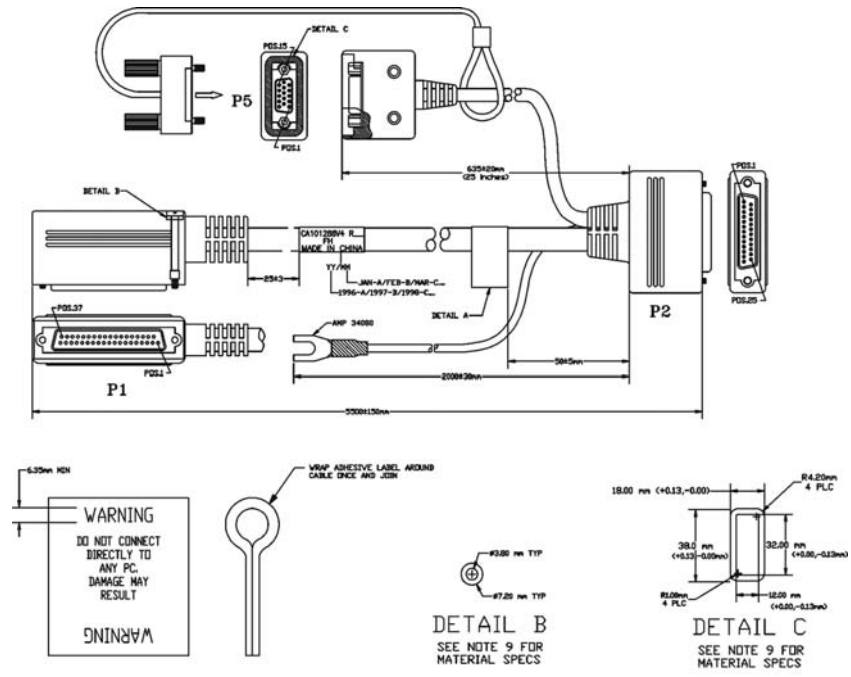

DETAIL A
FLAG TYPE WARNING LABEL

DETAIL B
SEE NOTE 9 FOR MATERIAL SPECS

DETAIL C
SEE NOTE 9 FOR MATERIAL SPECS

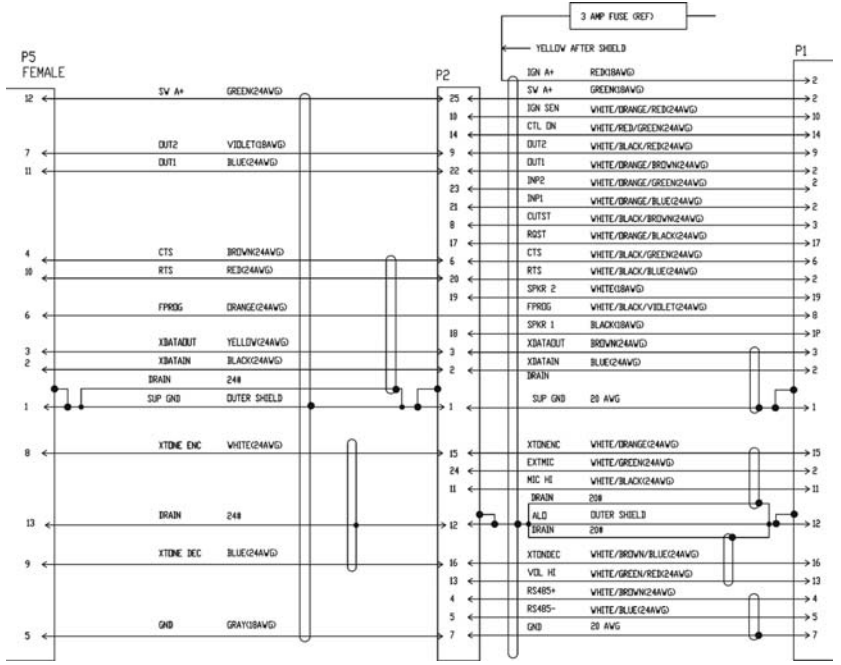

Figure 11 – Remote Extended Option Control Cable (CA101288V4)

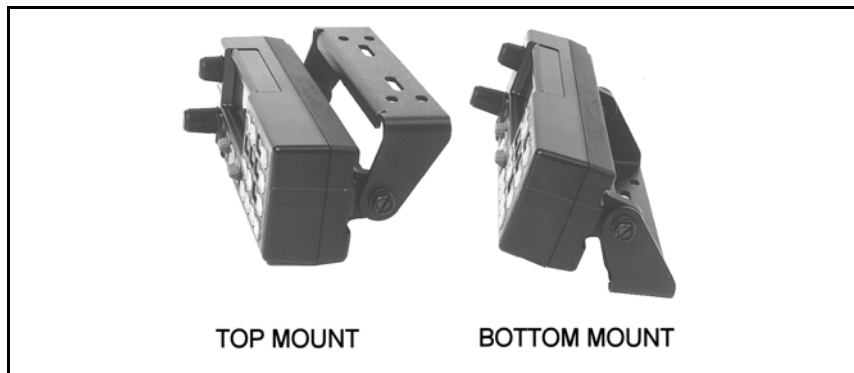

Figure 12 – Control Unit Mounting Bracket Installation

CONTROL UNIT MOUNTING

(Remote Applications Only)

1. Using the bracket as a template, mark and drill the mounting holes. Be sure to leave enough room at the rear of the control unit for the cable connector and to allow the unit to swivel. Refer to Figure 12 for control unit mounting bracket installation.
2. Secure the mounting bracket using the four No. 10 x 3/4 self-tapping screws supplied (use No. 10 x 1-1/2 if needed.).
3. Secure the control unit to the bracket with the two ¼ - 20 x ½ hex head screws and lock washers provided.

PIGTAIL BRACKET

The Pigtail Bracket is used to mount the DB15 connector for easier user access. The DB15 connector is used to make radio programming and keyloading by the customer easier, eliminating the need to dismantle the radio or Control Unit. There are two Pigtail brackets: one for use with the Control Unit and one for use with the radio mounting bracket. The following sections include procedures to mount the Pigtail brackets in each of these configurations.

Pigtail Bracket – Control Unit Mounting

For Control Unit mounting, the pigtail bracket is attached to the side of the Control Unit bracket using existing mounting bracket hardware. The Pigtail Bracket can be mounted to either the right or the left side of the Control Unit. Hardware Kit, KT101533V6, contains Pigtail mounting bracket and hardware required to attach Pigtail to bracket.



Figure 13 – Control Unit Mounting Bracket with Pigtail Bracket

1. Attach DB15 connector to the rectangular end of bracket with 2 pan head machine screws and washers. See Figure 14.



Figure 14 – DB15 Connector Mounted on Control Unit Pigtail Bracket

2. Remove the $\frac{1}{4}$ - 20 x $\frac{1}{2}$ hex head screw and washer from the side of the Control Unit bracket where the Pigtail installation is desired. Retain this hardware for Step 4.
3. Align the single hole at the end of the Pigtail Bracket with the holes in the Control Unit bracket and the Control Unit.
4. Replace washer, insert hex head screw, and tighten. See Figure 15.



Figure 15 – Pigtail Bracket Installed on Control Unit

Pigtail Bracket – Radio Mounting

For Radio mounting, the Pigtail Bracket is attached to either side of the Radio mounting bracket. Hardware Kit, KT101533V5, contains the Pigtail Bracket, and hardware to attach the Pigtail to the bracket.

1. Attach DB15 connector to rectangular end of the Pigtail Bracket using 2 pan head machine screws and washers. See Figure 16.



Figure 16 – DB15 Connector Mounted on Radio Pigtail Bracket

2. Position the Pigtail Bracket with the connector facing away from the side and towards the front of the radio. The Pigtail Bracket can be installed on either side of the radio.
3. Remove the first two radio mounting bracket screws and lockwashers located closest to the front of the radio. Retain this hardware for Step 5.
4. Align the bracket hole at the smaller end of the Pigtail Bracket with the middle hole on the radio bracket and the corresponding hole in the radio chassis. Insert an M5 x 10mm hex head screw and lockwasher.
5. The other slot in the Pigtail Bracket will enable flexible positioning of the pigtail. Position the bracket, and insert the remaining M5 x 10mm hex head screw and lockwasher. Tighten both of the hex head screws to 7 N-m (61 in-lb) to maintain the desired Pigtail position. See Figure 17.

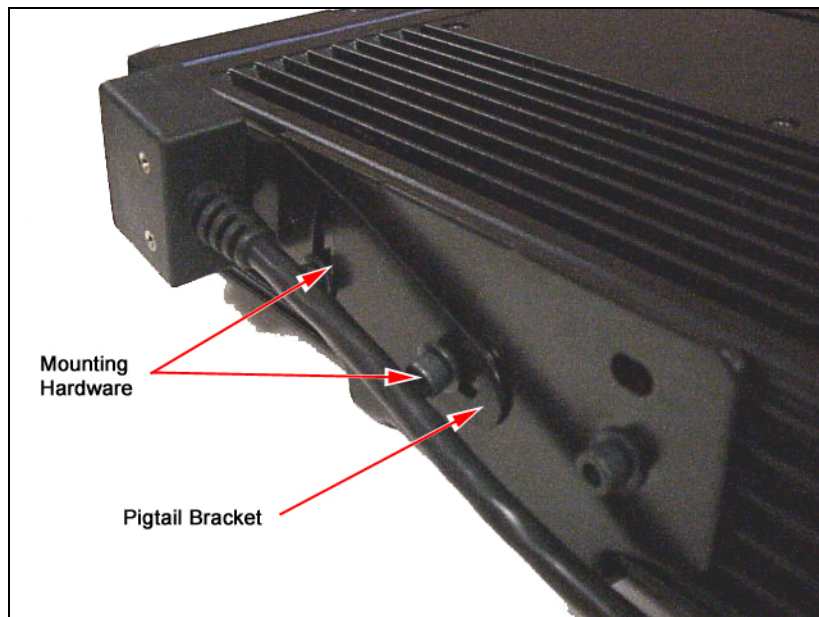

Figure 17 – Pigtail Bracket Mounted on Radio

SPEAKER

The speaker kit includes the speaker, mounting bracket and connecting cable. Position the speaker toward the operator but follow the guidelines presented on pages 4 through 12 to assure it does not present a hazard in the event of an accident. The speaker may be mounted on the lower edge of the instrument panel, the firewall or above the windshield in some trucks.

1. Use the mounting bracket as a template for locating the mounting holes and mount the speaker as shown in Figure 18.
2. Refer to the applicable installation procedures for connection of the speaker to the accessory cable.

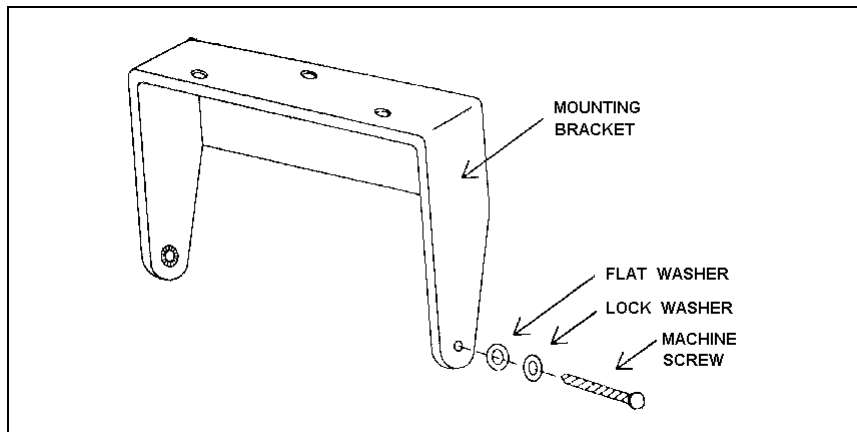

Figure 18 – Speaker Mounting Bracket

MICROPHONE HANGER AND/OR HOOKSWITCH MOUNTING

The microphone hanger or hookswitch should be mounted in a location convenient to the operator where it will not interfere with the safe operation of the vehicle or be a hazard to the vehicle passengers. The hanger and hookswitch are designed to be mounted with the open end of the mounting button slot pointed upward. Use the hanger or hookswitch as a template to mark and drill the mounting holes. Mount the hanger or hookswitch with the self-tapping screws provided.

SIREN AND LIGHT

For instructions about installing the Federal Signal Corporation Siren and Light Kit, refer to the Federal Signal Corporation Installation Instructions (Federal Systems part number 255287B, rev. B or higher).

Program the radio to work with the Federal Systems Siren and Light Kit, using the instructions outlined in the ProGrammer On-Line Help.

In a remote mount installation, three jumpers must be reconfigured in the remote control unit. These jumpers are located on the Remote Interface

Adapter (RIA), a PC board in the back half of the unit. To access these jumpers, the RIA must be removed from the control unit as follows:

1. Disassemble the Control Unit using steps given in LBI-39175.
2. Flex circuit PC2 does not need to be disengaged from J2, providing care is taken to avoid excessive bending.
3. Reconfigure jumper A/B to center/B, jumper C/D to center/D, and jumper E/F to center/F.
4. Carefully reassemble the RIA to front control panel, making sure that there is adequate alignment and lubricant for the black o-ring gasket at the mechanical interface between the RIA and the control panel. This maintains the moisture seal of the control panel.

NOTE: The following issues have been reported on some M7100^{IP} Siren/Light installations using the Federal Signal Corporation Siren and Light Kit:

- Occasional false activation of siren and light functions when the ignition is turned to the “on” position and/or when the vehicle is started.
- Occasional failure to enable siren or light functions via control head, which can be temporarily resolved by either power cycling the radio or turning the car ignition “off” and then “on” again.

To resolve these issues above, modify the Federal Systems control cable as follows:

1. Remove the outer shell from the DB25 side of the Federal Systems control cable.
2. Add a jumper from pin 1 to pin 19.

This modification to the SS2000 cable harness will disable the M7100^{IP}'s capability to turn on and off the SS2000 from the front of the control head. The SS2000 will now be turned on and off strictly by its own ignition switch trigger line (red wire from 12 pin Molex[®] connector on SS2000 siren box). Follow the SS2000 Federal Signal Corporation installation instructions to attach the red ignition line correctly.

RADIO MOUNTING AND FINAL HOOK-UP

Front Mount

Typically, the bracket shown in Figure 19 is used for Front Mount applications. The bracket can be mounted so that it is either above or below the radio for the user's convenience. The bracket pictured in Figure 12 can also be used for Remote Mount applications. The following instructions are for a Front Mount installation using the bracket shown in Figure 19.

1. Use the supplied mounting bracket as a template to locate the position for each of the drill holes. Be sure to leave enough room at the front and rear of the radio for cable connections. Drill No. 27 (9/64) pilot holes.
2. Mount bracket with four 1/4"-14 x 3/4" sheet metal screws (use 1/4"-14 x 1-1/2" screws if needed).
3. Place radio into mounting bracket and secure with the M5 x 10 mm hex head screws and M5 lock washers supplied using a No. 20 Torx driver.
4. Connect antenna coaxial cable to antenna connector (TNC).
5. Connect front mount accessory cable connector P1 to the Option/Remote Control Connector (ORCC) and secure with the two captive screws in the connector to the radio.

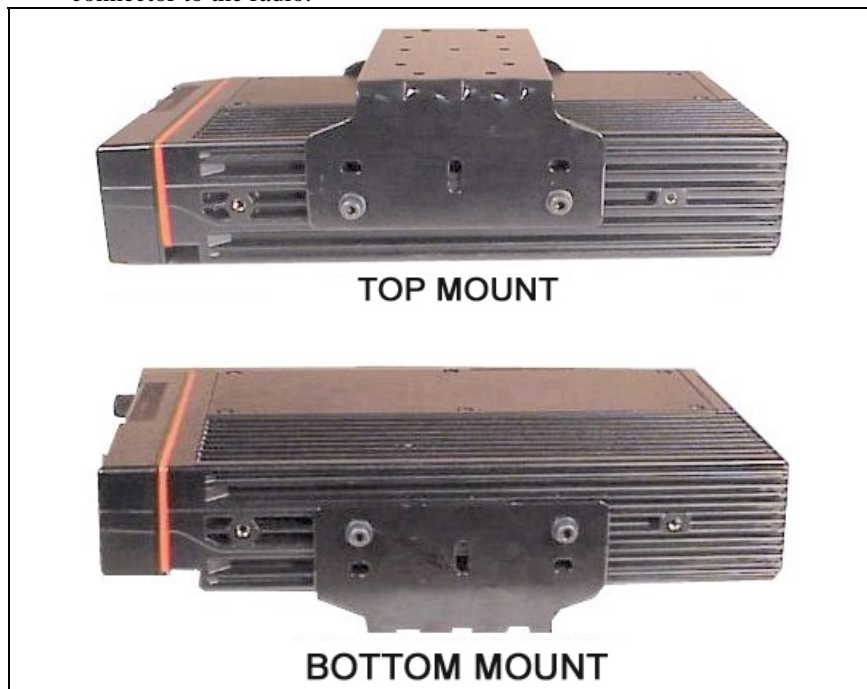

Figure 19 – Mounting Bracket Installation

6. Connect front mount accessory cable connector P2 to speaker cable connector.
7. Connect power cable to power connector on rear of radio unit and secure with the two captive screws to the radio unit.
8. Connect the microphone connector to the connector on the front panel and secure with the captive screw.



NOTE

Do not torque the microphone connector screw greater than 2 in-lb. Alternatively, “finger tight plus 1/4 turn” is acceptable.

9. If there are no other accessory connections, tie back plug P3 to main cable.
10. Recheck all connections before inserting fuse into transmit fuse assembly.

Remote Mount Installation

The bracket shown in Figure 20 is used in Remote Mount configurations. In some applications, the bracket shown in Figure 19 can also be used for Remote Mount installations. The following instructions are for a Remote Mount installation using the bracket shown in Figure 20.

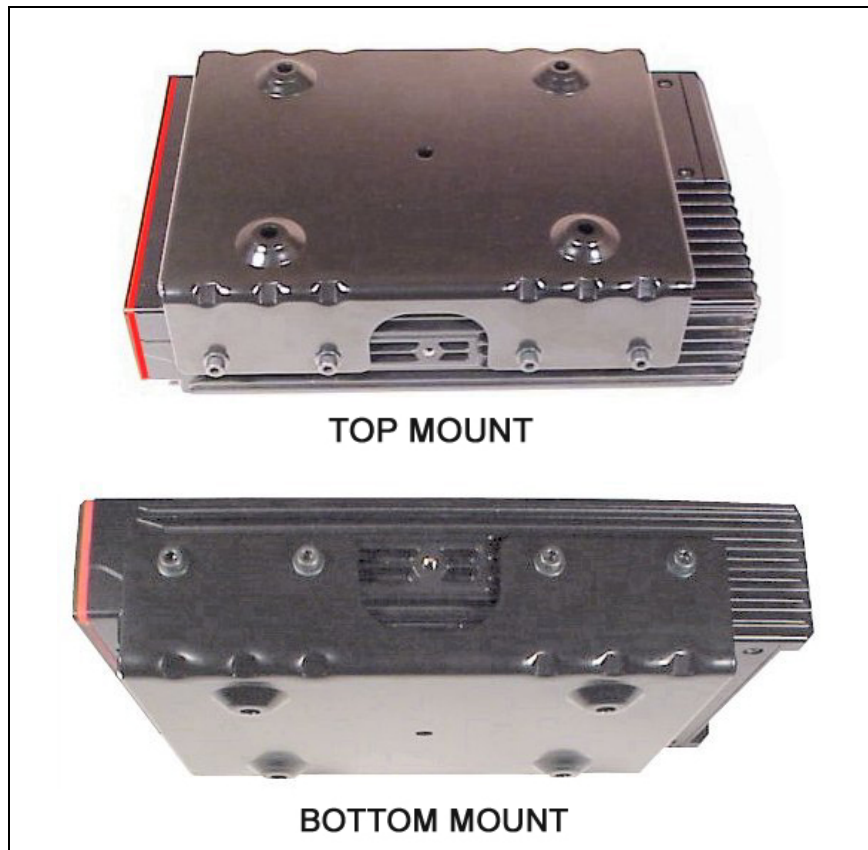

Figure 20 – Remote Mounting Bracket Installation

1. Using the bracket as a template, mark and drill the mounting holes using a No. 27 drill. Be sure to leave enough room at the rear of the radio unit for the cable connections.
2. Secure the mounting bracket using four 1/4"-14 x 3/4" sheet metal screws (use 1/4"-14 x 1" if needed.) The bracket can be mounted so that it is either above or below the radio for the user's convenience.
3. Slide the radio unit into the bracket by aligning bracket guides with grooves on each side of radio (rear of radio should be inserted first). Slide radio back until screw holes in front of bracket align with screw holes in side of radio. See Figure 20.
4. Secure radio to the bracket with two M5 x 10 mm socket head screws provided (7 N-m or 61 in-lb).
5. Connect antenna coaxial cable to antenna connector (TNC).
6. Connect remote control cable connector P1 to the ORCC connector on the radio unit and secure with the two captive screws.
7. Connect other end of remote control cable to the remote control cable connector (RCCC) on the remote control unit.
8. Connect remote mount accessory cable connector P1 to the option connector (OPT) on control unit. Then connect the speaker to connector P2 and accessory connector P3 to any options (hookswitch, etc.). If connector P3 is not used, insulate and tie back to main cable.
9. Recheck all connections and cables. Insert fuse into transmit fuse assembly.

DUAL CONTROL UNITS

The Dual Control feature can be configured for either front mount or remote mount radio units. Each configuration provides for a Main Control Unit and an Auxiliary Control Unit. In the front mount configuration, the Main Control Unit is on the Radio Unit itself, with the Auxiliary Control Unit located in a convenient location (see Figure 21A). In the remote mount configuration, the Main Control Unit is typically located in the vehicle cab, with the Auxiliary Control Unit located in a convenient location (see Figure 21B).

All radio units and control units in the Dual Control configuration **MUST BE PROGRAMMED** prior to final installation. It is recommended that the units be first programmed at an Authorized Service Center, and then transferred to the user's installation.

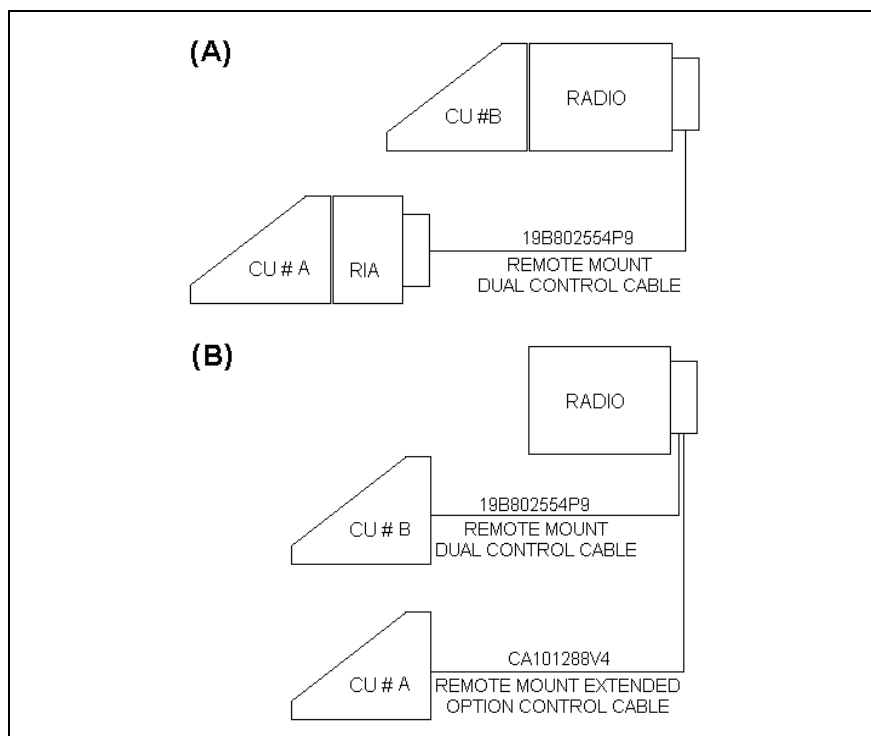

Figure 21 – Dual Control Unit – Basic Configurations for Front Mount and Remote Mount Installations

PRE-INSTALLATION PROGRAMMING PROCEDURE WITH PROGRAMMER - FRONT MOUNT

The Radio and Control Units must be programmed in a sequential procedure, in order to provide each Control Unit with the proper identification code.

1. Connect the M7100^{IP} Front Mount Radio with ProGrammer Assembly, as shown in Figure 22, Step 1. Program the radio with the following control configurations:

Network Options

Dual Control	Enable
Audio Mode	Active
Switching Mode	Independent
Siren Light Controller	Unit A
Siren Light Connection	Unit A
Speaker	Disable
Multiple Radio	Disable

Program Radio Setup

Mobile Options	Push Button
----------------	-------------

M7100^{IP} Options

Write System Keypad File	Enable (System control unit)
Write Scan Keypad File	Enable (Scan control unit)
Personality Name <USERPERS>	User's personality file Radio Code OGXXXXX Latest radio code file (G13 or later version)
ADI Code	<SAME>
Radio Unit ID	<SAME>
Keypad File	<CUBMAP> Keypad definition for Control Unit B
CU ID (CU B)	Must be Control Unit B

2. Connect the Front Mount Radio and the Auxiliary Control Unit together with ProGrammer, as shown in Figure 22, Step 2. Program this configuration with the following files:

Network Options

Dual Control	Enable
Audio Mode	Active
Switching Mode	Independent
Siren Light Controller	Unit A
Siren Light Connection	Unit A
Speaker	Disable
Multiple Radio	Disable

Program Radio Setup

Mobile Options	Push Button
----------------	-------------

M7100^{IP} Options

Write System Keypad File	Enable (System control unit)
Write Scan Keypad File	Enable (Scan control unit)
Personality Name	<USERPERS> User's personality file
Radio Code	<SAME>
ADI Code	<SAME>
Radio ID	<SAME>
Keypad Files	<CUAMAP> Keypad definition for Control Unit A
CU ID (CU A)	Must be Control Unit A

Note that the Main Control Unit has ID "B" and the Auxiliary Control Unit has ID "A" in this configuration.

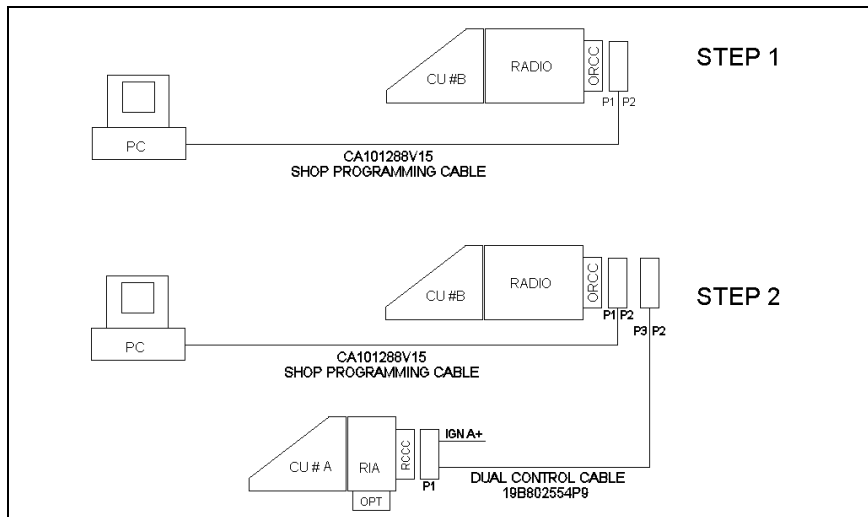

Figure 22 – M7100^{IP} Dual Control Unit PC Programming Configuration

PRE-INSTALLATION PROGRAMMING PROCEDURE WITH PROGRAMMER - REMOTE MOUNT

The Radio and Control Units must be programmed in a sequential procedure, in order to provide each Control Unit with the proper identification code.

1. Connect the M7100^{IP} Remote Mount Radio with ProGrammer Assembly, as shown in Figure 23, Step 1. Program the radio with the following control configurations:

Network Options

Dual Control	Enable
Audio Mode	Active
Switching Mode	Independent
Siren Light Controller	Unit A
Siren Light Connection	Unit A
Speaker	Disable
Multiple Radio	Disable

Program Radio Setup

Mobile Options	Push Button
----------------	-------------

M7100^{IP} Options

Write System Keypad File	Enable (System control unit)
Write Scan Keypad File	Enable (Scan control unit)
Personality name <USERPERS>	User's personality file
Radio Code OGXXXXX	Latest radio code file (G13 or later vintage)
ADI Code	<SAME>
Radio Unit ID	<SAME>
Keypad File	<CUBMAP> Keypad definition for Control Unit B
CU ID (CU B)	Must be Control Unit B

2. Connect the Remote Mount Radio and the Auxiliary Control Unit together with ProGrammer, as shown in Figure 23, Step 2. Program this configuration with the following files:

Network Options

Dual Control	Enable
Audio Mode	Active
Switching Mode	Independent
Siren Light Controller	Unit A
Siren Light Connection	Unit A
Speaker	Disable
Multiple Radio	Disable

Program Radio Setup

Mobile Options	Push Button
----------------	-------------

M7100^{IP} Options

Write System Keypad File	Enable (System control unit)
Write Scan Keypad File	Enable (Scan control unit)
Personality Name <USERPERS>	User's personality file
Radio Code	<SAME>
ADI Code	<SAME>
Radio ID	<SAME>

Keypad File <CUAMAP>

Keypad definition for
Control Unit A

CU ID (CU A)

Must be Control Unit A

Note that the Main Control Unit has ID “A” and Auxiliary Control Unit has ID “B” in this configuration.

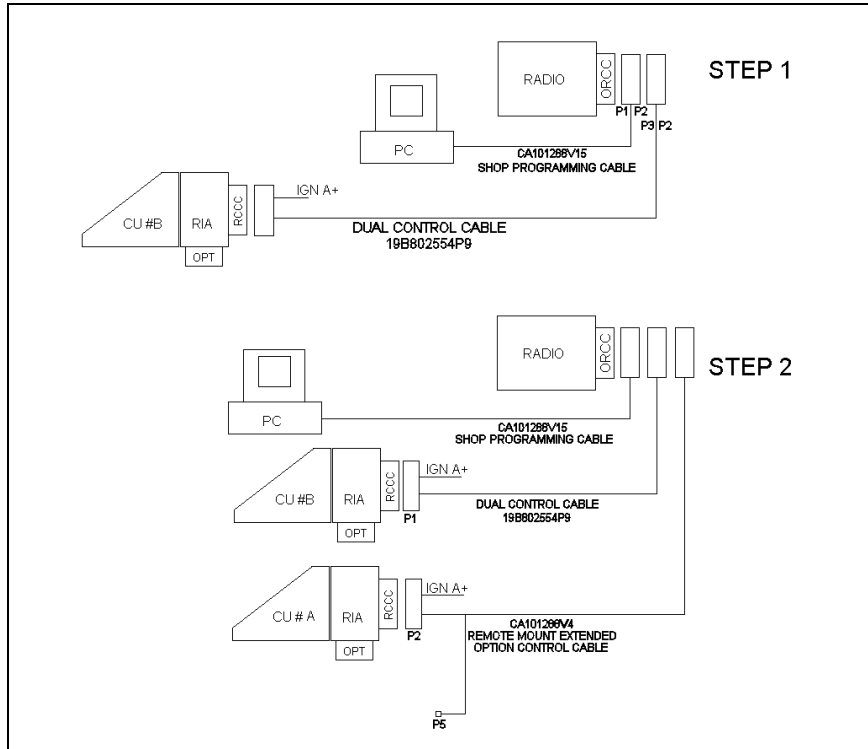

Figure 23 – M7100^{IP} Dual Control Unit PC Programming Configuration Remote Mount

INSTALLATION INSTRUCTIONS FOR FRONT MOUNT DUAL CONTROL UNITS

The Dual Control Unit feature is configured such that only one control unit can be used for Extended Option accessories. **All Extended Option functions are only available at the Main Control Unit.**

1. Referring to Figure 24, run the Dual Control Cable (19B802554P9) between locations for the Radio Unit and Auxiliary Control Unit. Be sure to locate the P2/P3 connector assembly at the Radio Unit.
2. After installing Radio Unit mounting hardware in the normal fashion, connect the Dual Control Cable connector (P3) to the Radio Unit. Tighten

the two jackscrews on P3. Next, connect the Accessory Cable (CA101288V2) Connector (P1) to the Dual Control Cable Connector (P2), and tighten the jackscrews on P2. Connect the power cable, and install Radio Unit in mounting bracket.

3. After installing the Auxiliary Control Unit in the normal fashion, connect the Dual Control Cable (P1) to Auxiliary Control Unit, and tighten jackscrews.
4. Connect the Remote Mount Accessory Cable (19B802554P7) to the Auxiliary Control Unit.
5. A yellow Ignition Sense lead is provided on the Dual Control Cable and the Front Mount Accessory Cable. If the **“Ignition Sense”** feature is enabled on the Radio Unit, it is necessary to connect only one of the yellow leads provided, whichever is convenient. Tape back the unused yellow lead (see Page 27 for details).
6. Install the Speakers in convenient locations near the Radio Unit and Auxiliary Control Unit.

Parallel Audio Installation Requirements

In special configurations that require both speakers to operate at the same time (simultaneous audio), install the speakers for parallel audio operation.

Refer to Figure 25 for the Parallel Audio Setup Installation. Perform the following steps to install parallel audio speakers:

- A. Use the two 8 Ω speakers, part number 19A149590P12, in place of the two 4 Ω speakers, part number LS102824V1.
- B. Hardwire each speaker directly (without relays) as shown in Figure 24.

NOTE

It is very important to use the correct speakers for this application. Wiring 4 Ω speakers in this configuration can cause damage to the radio.

7. Install a relay (19A149299P1), from the kits supplied, at a location near the leads from each speaker. For mounting, use the #8x3/4" sheet metal screw and nut plate supplied with each kit.
8. At a convenient point cut one of the wires in each of the 2-wire speaker cables, spread the leads, and strip the ends. Crimp a 1/4" tab receptacle to each end.
9. Radio Unit Speaker: Connect the lead nearest the speaker to Pin 87A of the relay. Connect the lead nearest the connector to Pin 30 of the relay. Connect the connector to the Accessory Cable P2 (Refer to Figure 24).

10. Auxiliary Control Unit Speaker: Connect the lead nearest the speaker to Pin 87 of the relay. Connect the lead nearest the connector to Pin 30 of the relay. Connect the connector to the Accessory Cable P2 (Refer to Figure 24).
11. For each relay: Connect a #18 AWG black wire between the relay, Pin 85 and Accessory Cable P3-1 (labeled “OUT2” on the schematic diagrams in the service manual). Use a 1/4” tab receptacle on the relay side and mating Molex connector and pins on the accessory cable side. Connect the mating Molex connector to the Accessory Cable P3 when finished (Refer to Figure 24).
12. For each relay: Connect a #18 AWG red wire to the relay, Pin 86. Cut to length, and connect to the 1A fuse holder (supplied). Use crimp on connectors supplied. Connect the other side of the 1 amp fuse holder to A+ battery source or vehicle A+ fuse block. Use #18 AWG red wire and ring lug supplied, if needed (see Figure 24).
13. Check dual control operation, using operator’s manual as a test guide. In ProGammer, make sure the “DUAL CONTROL SPEAKER” is programmed **ACTIVE LOW**.

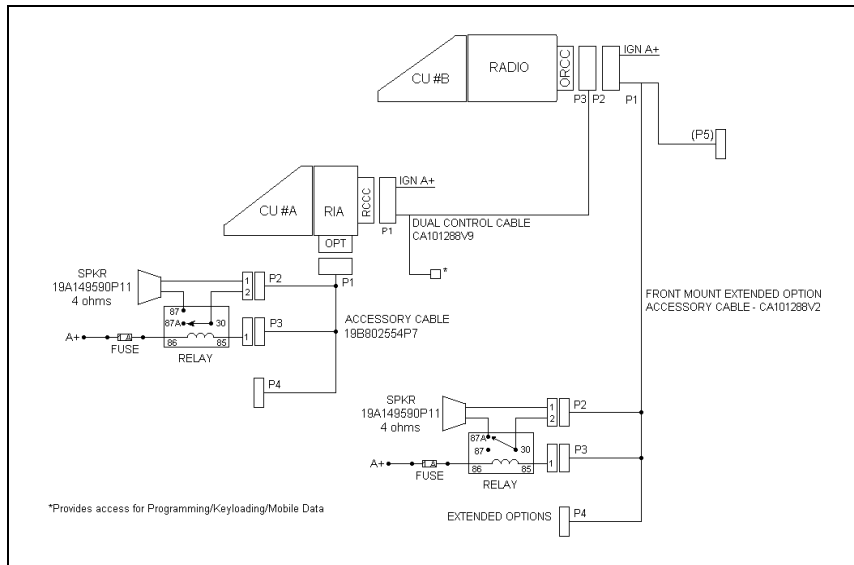

Figure 24 – M7100^{IP} Dual Control Unit Front Mount/Remote Mount Installation Configuration

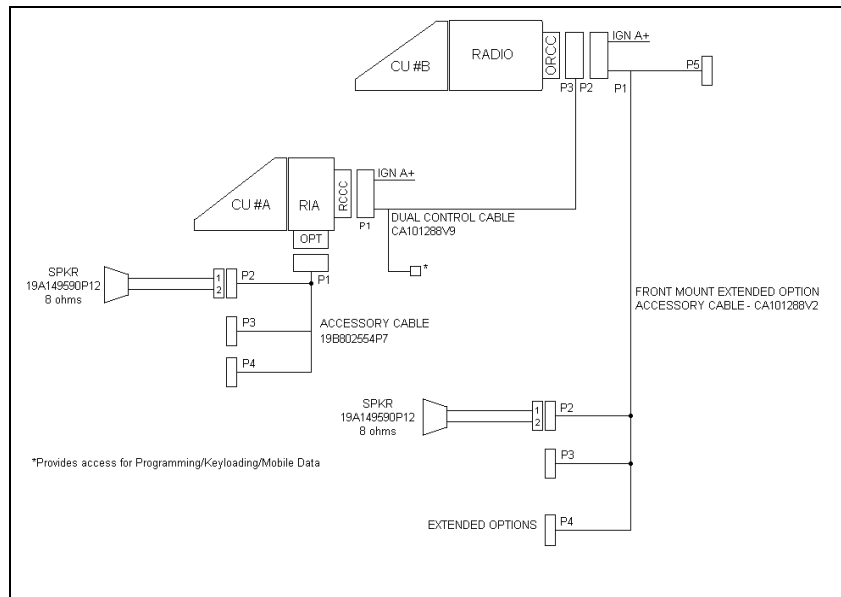

Figure 25 – M7100^{RP} Dual Control Unit Front Mount/Remote Mount Installation Configuration – Parallel Audio

INSTALLATION INSTRUCTIONS FOR REMOTE MOUNT DUAL CONTROL UNITS

1. Referring to Figure 26, run the Remote Control Cable (CA101288V4) between locations for the Radio Unit and Main Control Unit.
2. Run the Dual Control Cable (19B802554P9) between locations for the Radio Unit and Auxiliary Control Unit. Be sure to locate the P2/P3 connector assembly at the radio unit.
3. After installing the Radio Unit in the normal fashion, connect the dual control cable connector (P3) to the Radio Unit. Tighten the two jackscrews on P3. Next, connect the Remote Control Cable connector (P1) to the Dual Control Cable connector (P2), and tighten jackscrews on P2.
4. After installing the Main Control Unit in the normal fashion, connect the Remote Control Cable (P2) to the Main Control Unit, and tighten jackscrews.
5. After installing the auxiliary control unit in the normal fashion, connect the Dual Control Cable (P1) to the Auxiliary Control Unit, and tighten jackscrews.

6. Connect the Remote Mount Extended Option Accessory Cable (19B802554P7) to the Auxiliary Control Unit and the Main Control Unit. **Please note: All extended option functions are only available at the Main Control Unit.**
7. A yellow ignition sense lead is provided on each control cable. If the “**Ignition Sense**” feature is enabled on the Radio Unit, it is necessary to connect only one of the yellow leads provided, whichever is convenient. Tape back the unused yellow lead. See page 27 for details.
8. Install the speakers in convenient locations near each control unit.

Parallel Audio Installation Requirements

In special configurations that require both speakers to operate at the same time (simultaneous audio), install the speakers for parallel audio operation.

Refer to Figure 28 for the Parallel Audio Setup Installation. Perform the following steps to install parallel audio speakers:

- A. Use the two 8 Ω speakers, part number 19A149590P12, in place of the two 4 Ω speakers, part number LS102824V1.
- B. Hardwire each speaker directly (without relays) as shown in Figure 26.

NOTE

It is very important to use the correct speakers for this application, wiring 4 Ω speakers in this configuration may cause damage to the radio.

9. Install a relay (19A149299P1) from the kits supplied at a location near the leads from each speaker. For mounting, use the #8 X 3/4” sheet metal screw and nut plate supplied with each kit.
10. At a convenient point cut one of the wires in each of the 2-wire speaker cables, spread the leads, and strip the ends. Crimp a 1/4” tab receptacle to each end.
11. Main Control Unit Speaker: Connect the lead nearest the speaker to Pin 87 of the relay. Connect the lead nearest the connector to Pin 30 of the relay. Connect connector to the accessory cable P2 (Refer to Figure 27).
12. Auxiliary Control Unit Speaker: Connect the lead nearest the speaker to Pin 87A of the relay. Connect the lead nearest the connector to Pin 30 of the relay. Connect the connector to accessory cable P2 (Refer to Figure 27).
13. For Each Relay: Connect a #18 AWG black wire between the relay, Pin 85 and accessory cable P3-1 (labeled “**OUT2**” on schematic diagrams in the service manual). Use a 1/4” tab receptacle on the relay side and a mating Molex connector and pins on the accessory cable side. Connect

the mating Molex connector to the accessory cable P3 when finished (Refer to Figure 27).

14. For Each Relay: Connect one end of a #18 AWG red wire to the relay, Pin 86. Cut the lead to length, and connect the other end to the 1 amp fuse holder supplied. Use crimp on connectors supplied. Connect the other side of the 1 amp fuse holder to the A+ battery source or a vehicle A+ fuse block. Use a #18 AWG red wire and a ring lug supplied, if needed (Refer to Figure 27).
15. Check dual control operation, using the operator’s manual as a test guide. In the PC programming software, make sure the “DUAL CONTROL SPEAKER” is programmed **ACTIVE HIGH**.

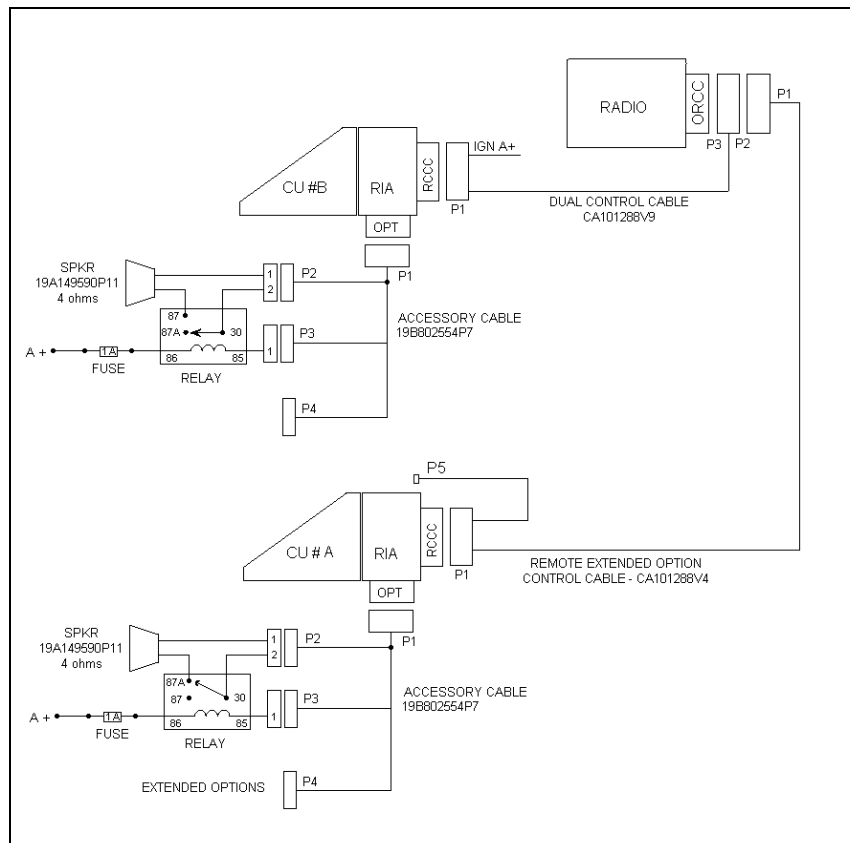

Figure 26 – M7100^{IP} Dual Control Unit Remote Mount/Remote Mount Installation Configuration

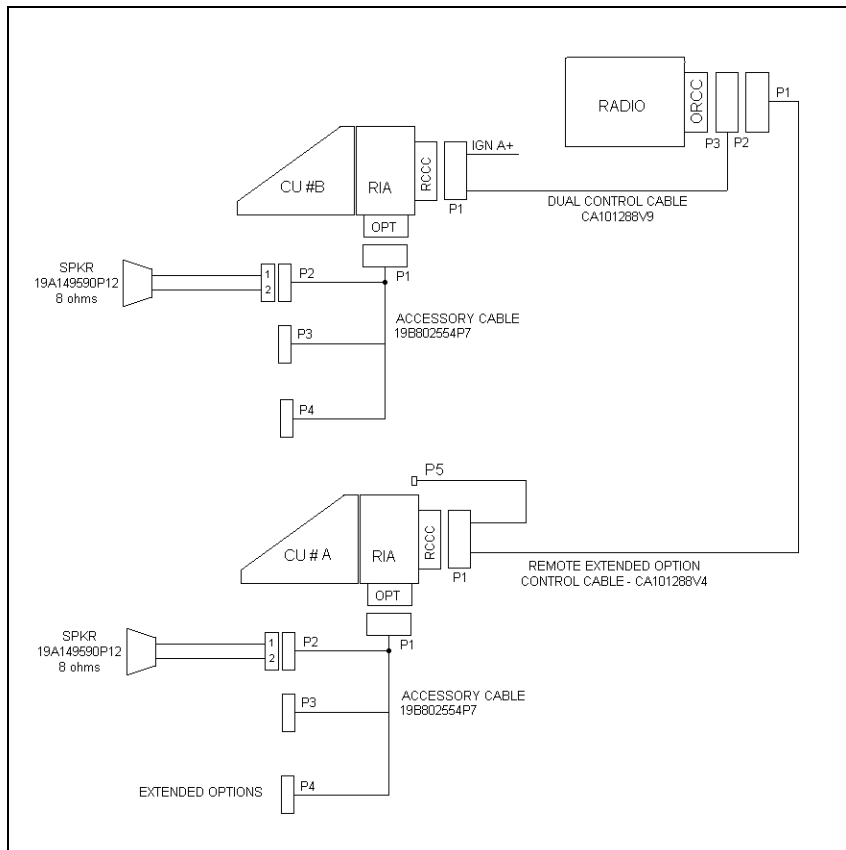

Figure 27 – M7100^{IP} Dual Control Unit Remote/Remote Mount Installation Configuration – Parallel Audio

FIELD PROGRAMMING WITH PROGRAMMER – DUAL CONTROL UNITS

Once installed, the M7100^{IP} can be programmed through connector P5 on cable assemblies, CA101288V2, V4, and V10.

Please note: Keyloading and Mobile Data functions are also available through the P5 connector on the cable assemblies mentioned above. Please follow the applicable instructions in the appropriate manuals for these applications.

Perform the following procedure for each installation configuration:

Field Programming Procedure - Dual Control Units – Front/Remote Mount Configuration

The Radio and Control Units must be programmed in a sequential procedure in order to provide each Control Unit with the proper identification code.

1. Connect the M7100^{IP} Front Mount Radio and the Auxiliary Control Unit per the ProGrammer setup as shown in Figure 28, Step 1 with Control Unit A disconnected. Program the radio with the control configurations shown in Step 1 of “Pre-Installation Programming Procedure with ProGrammer – Front Mount” and adjust as necessary for the specific application.
2. Connect the Front Mount Radio and Auxiliary Control Unit per ProGrammer setup as shown in Figure 28, Step 2 with Control Unit A reconnected. Program the configurations shown in Step 2 of “Pre-Installation Programming Procedure with ProGrammer – Front Mount” and adjust as necessary for the specific application.

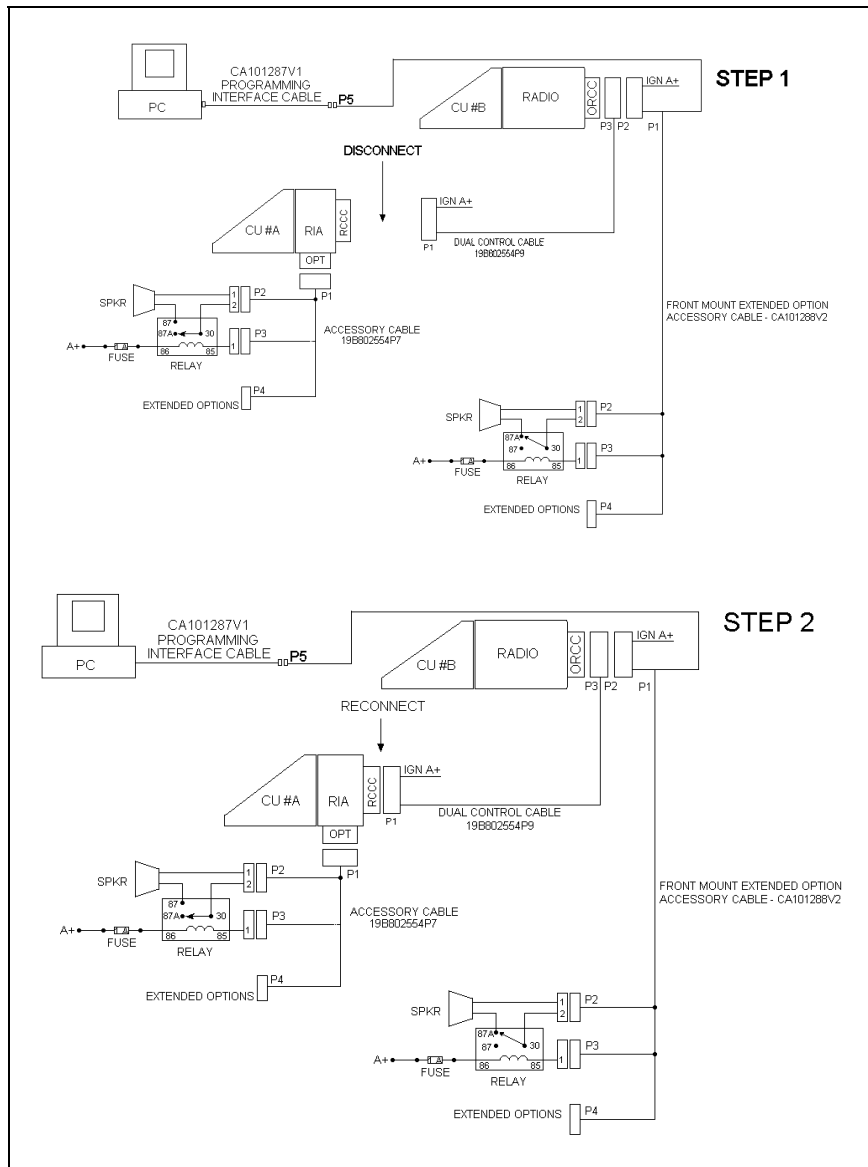

Figure 28 – M7100^{IP} Field Programming – Dual Control Unit Front/Remote Mount Configuration

Field Programming Procedure - Dual Control Units – Remote/Remote Mount Configuration

The Radio and Control Units must be programmed in a sequential procedure in order to provide each Control Unit with the proper identification code.

1. Configure the M7100^{IP} Remote Mount Radio per ProGrammer setup as shown in Figure 29, Step 1 with Control Unit #A disconnected. Program the radio with the control configurations shown in Step 1 of “Pre-Installation Programming Procedure with ProGrammer – Remote Mount” and adjust as necessary for the specific application.
2. Now configure the Remote Mount Radio and Auxiliary Control Unit per ProGrammer setup as shown in Figure 29, Step 2, with Control Unit #A. Program the configurations shown in Step 2 of “Pre-Installation Programming Procedure with ProGrammer – Remote Mount” and adjust as necessary for the specific application.

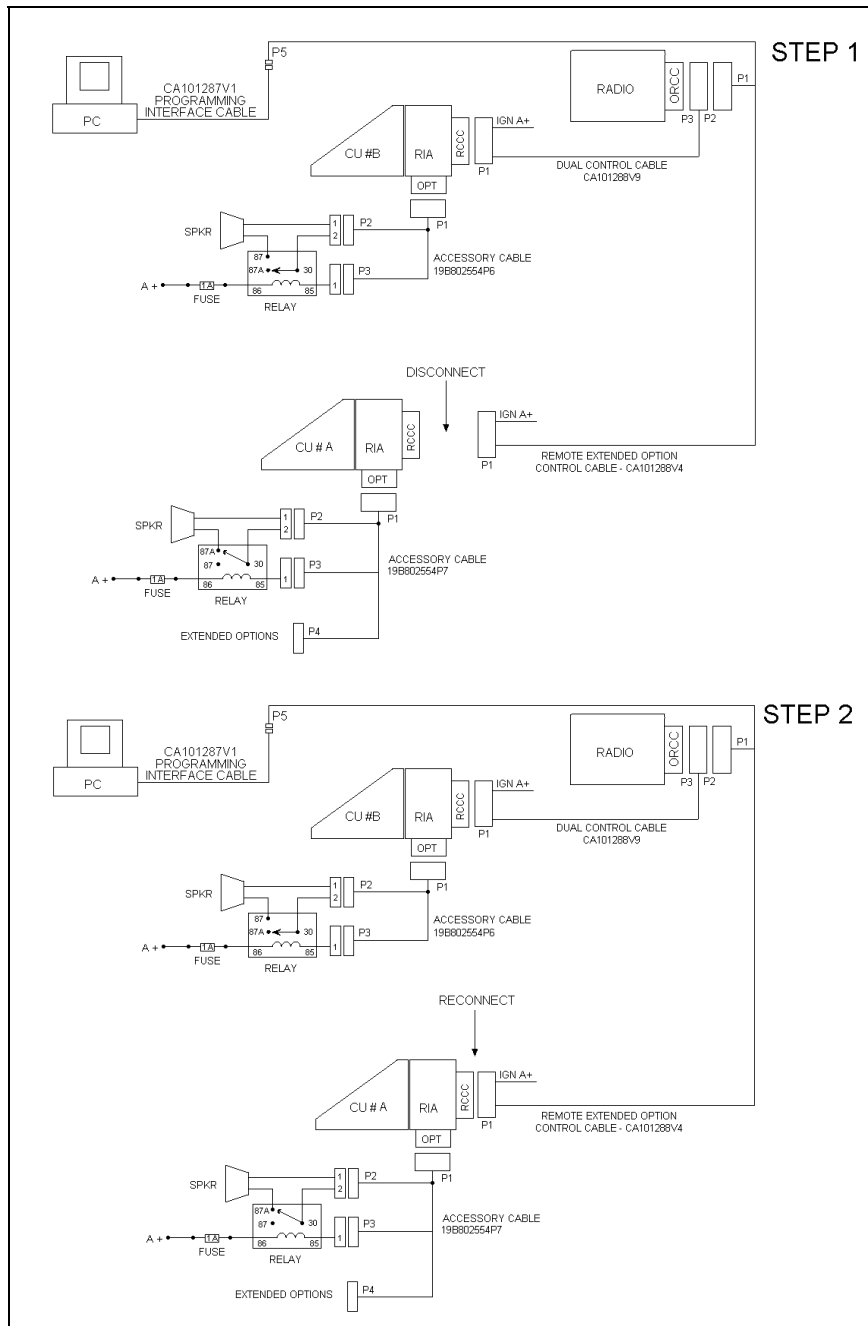

Figure 29 M7100^{IP} Field Programming – Dual Control Unit Remote/Remote Mount Configuration

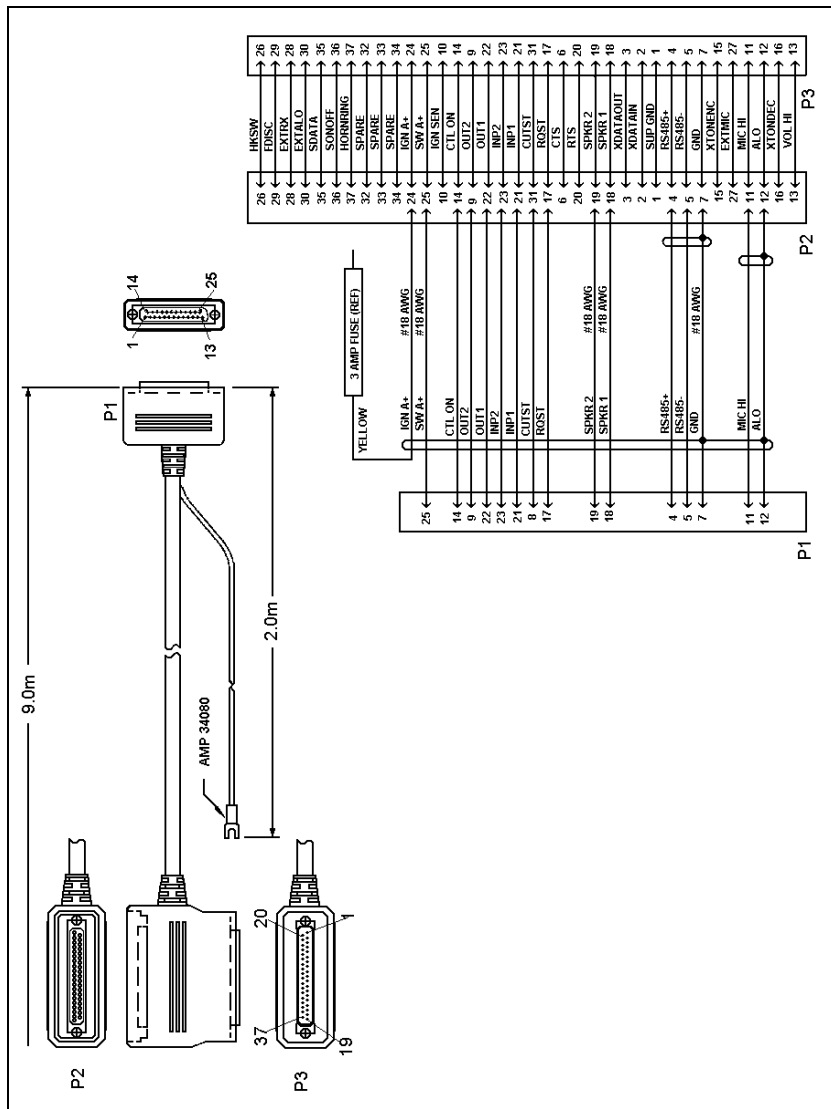

Figure 30 – Remote Mount Dual Control Cable 19B802554P9

DUAL RADIO UNITS

The Dual Radio feature can be configured for two remote mount radio units or for one front mount unit and one remote mount unit. In remote mount configurations the Control Unit is typically located in the vehicle cab, with the Radio Units located side-by-side in vehicle trunk. In front/remote mount configurations the front mount unit is located in the vehicle cab, with the remote mount unit located in a convenient location nearby. The remote/remote mount configuration is the preferred installation, since a separate control unit is required to program the remote unit in a front/remote mount configuration.

The following Dual Radio Unit configurations are not allowed:

- Any configuration using a DIN cassette mount.
- Any installation where Extended Options are required from both Radio Units. Extended options are supported in one Radio Unit only.

PRE-INSTALLATION PROGRAMMING PROCEDURE WITH PROGRAMMER – DUAL RADIO UNITS

All Radio Units in the Dual Radio configuration **MUST BE PROGRAMMED** prior to final installation. It is recommended that the units be first programmed at an Authorized Service Center, and then transferred to the user's installation.

These configurations provide for a Master Radio Unit and a Slave Radio Unit. In the remote/remote mount configuration, the Master Radio Unit is always the radio most directly connected to the Control Unit. In the front/remote mount configuration, the Master Radio Unit is always the front mount radio. Extended Options are allowed only in the Master Radio Unit. Programming each radio is straightforward, except that one radio is programmed as a Master, and one as a Slave.

1. Decide which Radio Unit will be the Master Unit. Configure the radio for programming as shown in the applicable maintenance manual.
2. Program the Master Unit (refer to the programming configuration that follows).
 - a. In the “Multi-Radio” field of ProGrammer, select “Master.”
 - b. Select any M7100^{IP} keypad programming options if the keypad is to be programmed. The M7100^{IP} keypad options can only be programmed with “multi-radio” set to “Master” in a dual radio personality.
3. Program the unit normally. Include Extended Option features, if purchased.
4. Program the Slave Unit (refer to the programming configuration that follows).

- a. Connect the Slave Radio Unit for programming. Be sure to use the programming configuration for remote mount and supply the required control unit if for a front/remote mount dual radio configuration.
 - b. In the “Multi-Radio” field of ProGrammer, select “Slave.”
5. Program the unit normally. Do NOT include Extended Option features. Both radio units are now ready for vehicular installation.

Programming Configuration

Dual Control	Disable
Speaker	Disable
Multiple Radio	Enable
Radio Type	Slave or Master
Power Up Volume	5
Mute Time-Out	30.0
Termination	Enable
Display	Selected for Master radio only
Power Up	Enable for Master radio only
Power Up Radio	Master for Master radio only
Receive Emergency	Enable for Master radio only
Receive Only	Enable for Master radio only
MuRPS	Disable for Master radio only

Program Radio Setup

Mobile Options	Push Button
----------------	-------------

M7100^{IP} Options

Write System Keypad File	Enable (System control unit)
Write Scan Keypad File	Enable (Scan control unit)

INSTALLATION INSTRUCTIONS FOR FRONT/ REMOTE MOUNT DUAL RADIO CONFIGURATION

1. Plan the mounting locations of the two Radio Units. Note that the maximum cable length allowed between the two radios is two meters. Referring to Figure 31, run Dual Radio Cable (CA101288V10) between locations for Master and Slave Radio Units. Be sure to locate the P2/P3 connector assembly at the Master Radio Unit.

2. After installing Master Radio Unit mounting hardware, connect the Dual Radio Cable Connector (P3) to the Master Radio Unit. Tighten the two jackscrews on P3. Next, connect the Accessory Cable (CA101288V2) Connector (P1) to the Dual Radio Cable Connector (P2), and tighten to jackscrews on P2.
3. Connect the Microphone and Accessories. Refer to Accessory Installation Manual for proper connection of Accessories.
4. Connect Power Cable and Antenna, then install Master Radio Unit in mounting bracket.
5. Connect "IGN A+" lead, if option is desired. Be sure internal switch S951 is set properly. Refer to NOTE on Page 27 of this manual for details.
6. After installing Slave Radio Unit in its mounting hardware, connect Dual Radio Cable (P1), and tighten jackscrews. Be sure S951 setting on Slave Radio Unit is same as for Master Radio Unit. Connect Power Cable and Antenna to Slave Radio.
7. Check Dual Radio operation, using Operator's Manual as test guide.

INSTALLATION INSTRUCTIONS FOR REMOTE/REMOTE MOUNT DUAL RADIO CONFIGURATION

1. Plan the mounting locations of the two Radio Units. Note that the maximum cable length allowed between the two radios is two meters. Referring to Figure 32, run Dual Radio Cable (CA101288V10) between locations for Master and Slave Radio Units. Be sure to locate the P2/P3 connector assembly at the Master Radio Unit.
2. After installing Master Radio Unit mounting hardware, connect the Dual Radio Cable Connector (P3) to the Master Radio Unit. Tighten the two jackscrews on P3.
3. Next, route the Remote Mount Extended Option Control Cable (CA101288V4) between Control Head and Master Radio locations. After installing Control Head, connect Remote Control Cable Connector (P2) to Control Head.
4. Connect "IGN A+" lead, if option is desired. Be sure internal Switch S951 on Master Radio is set properly. Refer to Page 27 of this manual for details.
5. Connect Accessory Cable (19B802554P7) Connector (P1) to Control Head.
6. Connect the Microphone and Accessories. Refer to Accessory Installation Manual for proper connection of Accessories.
7. Now, connect Remote Control Cable Connector (P1) to the Dual Radio Cable Connector (P2), and tighten to jackscrews on P2.

8. Connect Power Cable, and Antenna, then install Master Radio Unit in mounting bracket.
9. After installing Slave Radio Unit in its mounting hardware, connect Dual Radio Cable (P1), and tighten jackscrews. Be sure S951 setting on Slave Radio Unit is same as for Master Radio Unit. Connect Power Cable and Antenna to Slave Radio.
10. Check Dual Radio operation, using operator's manual as test guide.

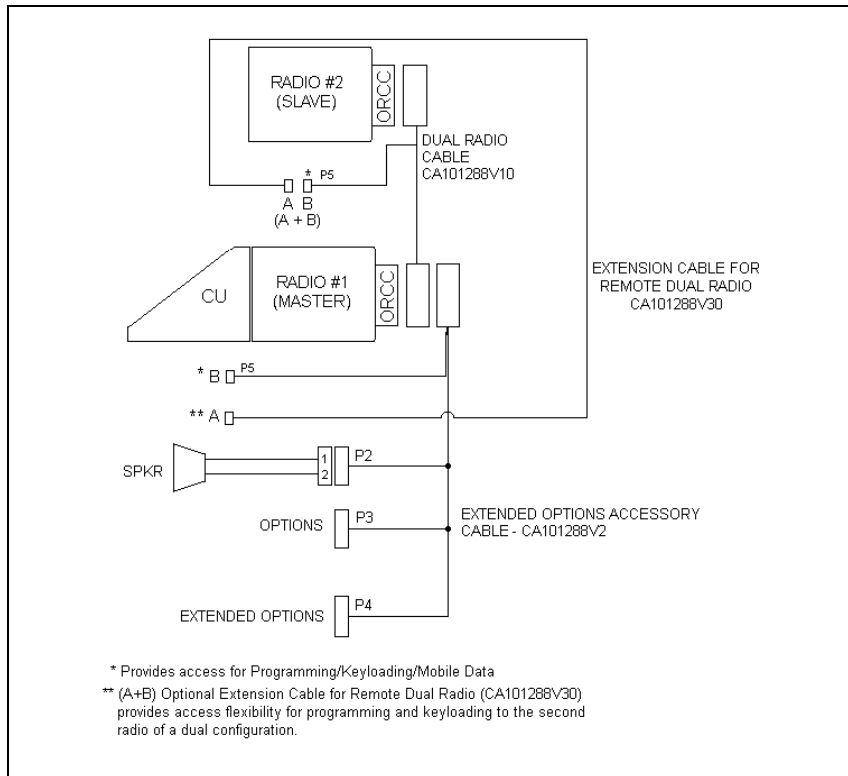

Figure 31 - M7100^{IP} Dual Radio Front Mount/Remote Mount Installation Configuration

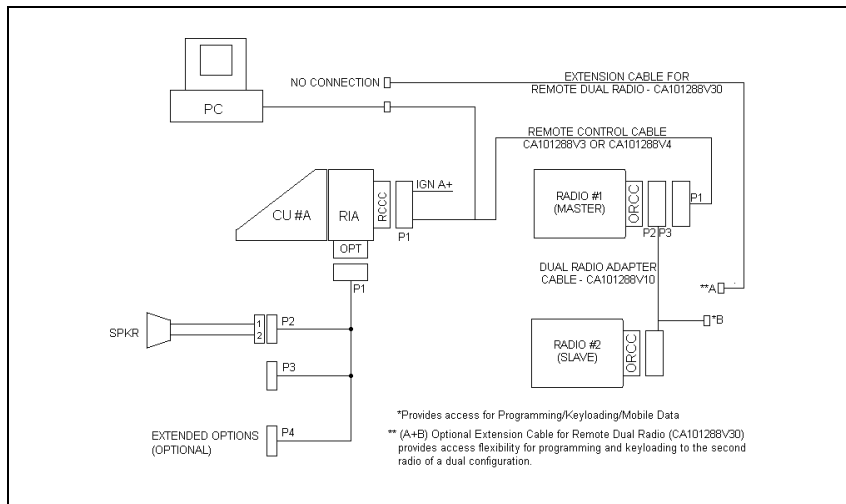

Figure 32 - M7100^{IP} Dual Radio Remote Mount/Remote Mount Installation Configuration

PROGRAMMING WITH PC PROGRAMMER – DUAL RADIO UNITS

Once installed, the M7100^{IP} can be programmed through connector P5 on cable assemblies CA101288V2, V4, and V10. Please Note: Keyloading and Data functions are also available through the P5 connector on these cables. In addition, extended options are supported on ONE radio unit only. Follow the applicable instructions for extended option programming.

Field Programming Procedure for Front/Remote Mount Dual Radio Configuration

The Radio and Control Units must be programmed in a sequential procedure in order to provide each Control Unit with the proper identification code.

1. Configure the M7100^{IP} Master Radio per the ProGrammer setup shown in Figure 33, Step 1, with the Slave Radio disconnected. Program the Master Radio with the control configurations per the Pre-Installation Programming Procedure with ProGrammer – Dual Radio Units and adjust as necessary for the desired application.
2. Now configure the Slave Radio with ProGrammer as shown in Figure 33, Step 2. The Slave Radio should now be disconnected with the Slave Radio connected as shown. Program the Slave Radio with the configuration per the Pre-Installation Programming Procedure with ProGrammer – Dual Radio Units and adjust as needed for the desired application.

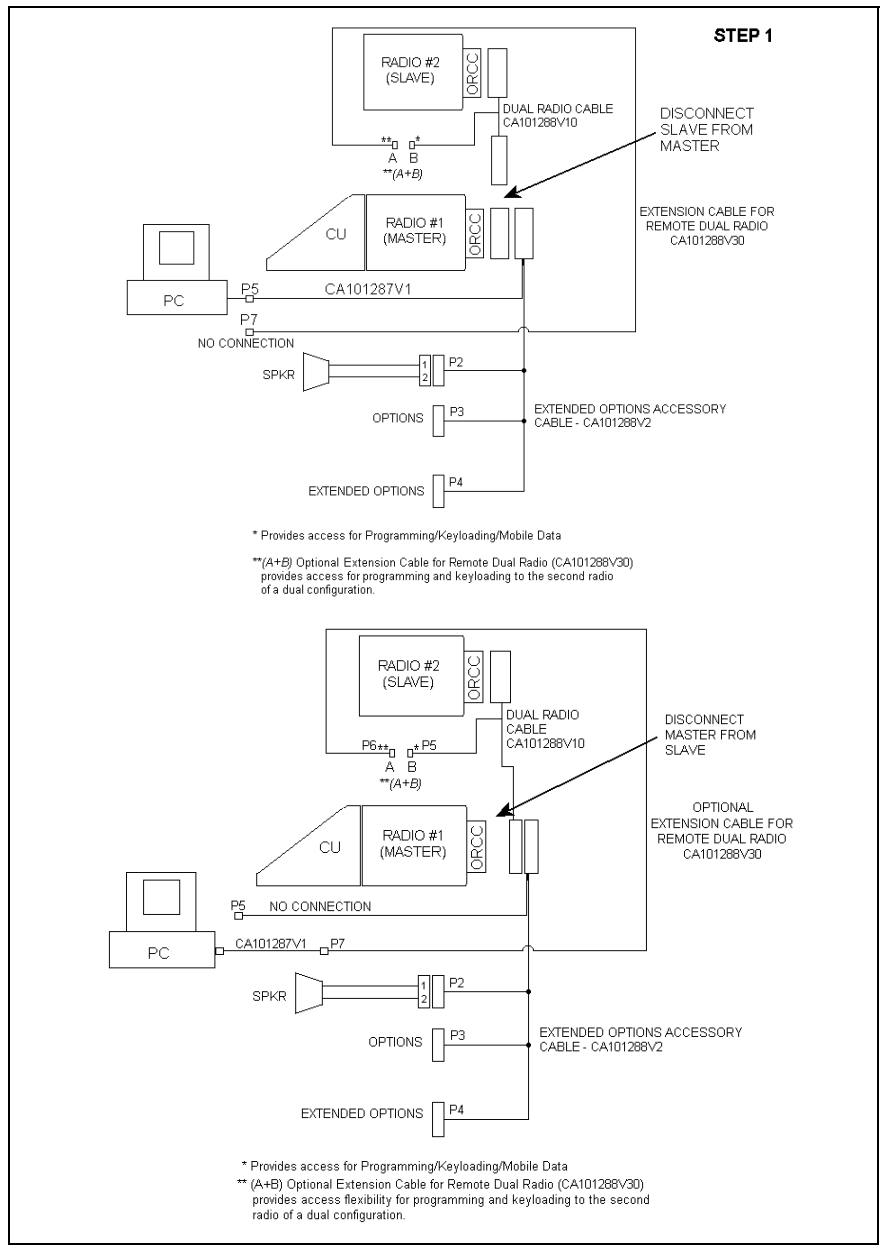

Figure 33 – Dual Radio Configuration – Front/Remote Mount – PC Programming Procedure

Field Programming Procedure for Remote/Remote Mount Dual Radio Configuration

The Radio and Control Units must be programmed in a sequential procedure in order to provide each Control Unit with the proper identification code.

1. Connect the M7100^{IP} Master Radio per the ProGrammer setup as shown in Figure 34, Step 1 with the Slave Radio disconnected. Program the Master Radio with the control configurations per the Pre-Installation Programming Procedure with ProGrammer – Dual Radio Units and adjust as necessary for the desired application.
2. Connect the Slave Radio with ProGrammer as shown in Figure 34, Step 2. The Master Radio should now be disconnected, with the Slave Radio connected as indicated. Program the Slave Radio with the configuration per the Pre-Installation Programming Procedure with ProGrammer – Dual Radio Units and adjust as necessary for the desired application.

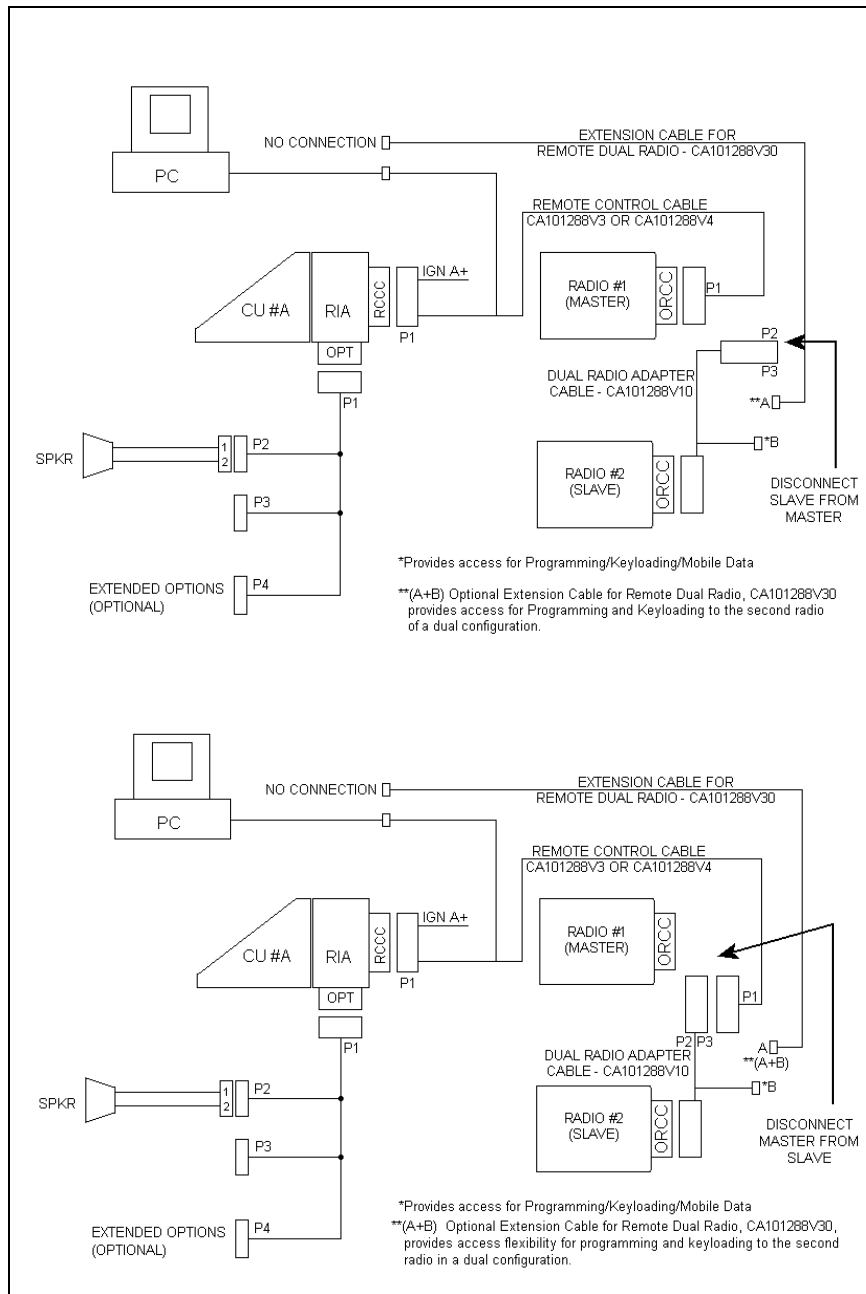

Figure 34 – Dual Radio Configuration – Remote/Remote Mount - PC Programming Procedure

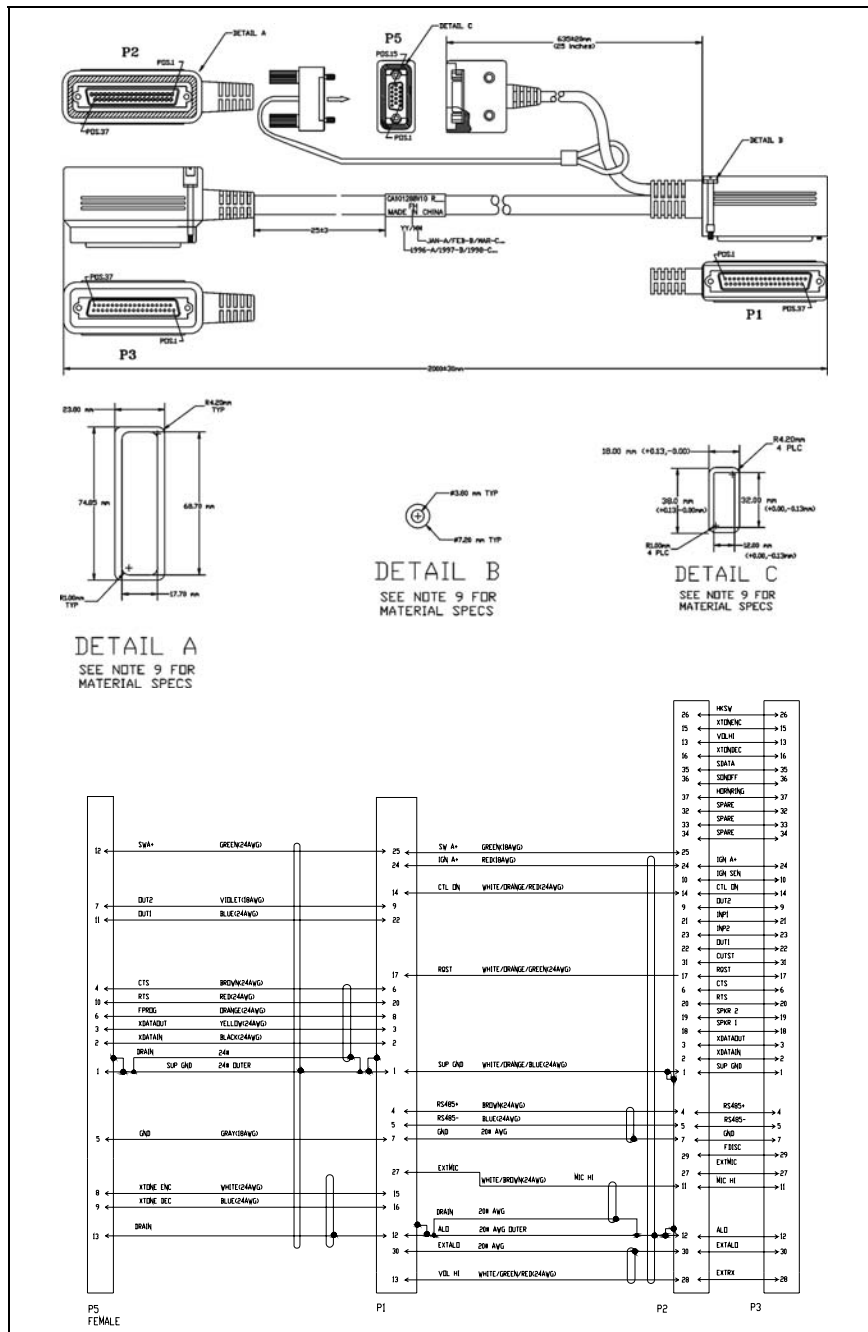

Figure 35 – Dual Radio Control Cable (CA101288V10)

ANTENNA

Installation instructions for the antenna are packaged with the antenna. The antenna must be installed in accordance with good engineering practice for optimum results.

Typical Mobile Antenna Installation

A permanent mount-type antenna must be located in the center of the roof.



See the “**RF ENERGY EXPOSURE INFORMATION**” section at the beginning of this manual for further information regarding **Maximum Permissible Exposure (MPE) limits of RF radiation absorption set by the FCC.**

Route the antenna cable away from locations where it will be exposed to heat, sharp edges or mechanical damage, and where it will be out of the way of the driver, passengers or vehicles mechanics. Wherever possible, use existing holes in the trunk wall and channels above or beneath doors and window columns.

Avoid routing the antenna cable near any electronic modules or along side any vehicle wiring.

Connect the antenna cable to the TNC on the radio, being careful not to twist the cable.

WARRANTY

- A. M/A-COM, Inc. (hereinafter "Seller") warrants to the original purchaser for use (hereinafter "Buyer") that Equipment manufactured by or for the Seller shall be free from defects in material and workmanship, and shall conform to its published specifications. With respect to all non-M/A-COM Equipment, Seller gives no warranty, and only the warranty, if any, given by the manufacturer shall apply. Rechargeable batteries are excluded from this warranty but are warranted under a separate Rechargeable Battery Warranty (ECR-7048).
- B. Seller's obligations set forth in Paragraph C below shall apply only to failures to meet the above warranties occurring within the following periods of time from date of sale to the Buyer and are conditioned on Buyer's giving written notice to Seller within thirty (30) days of such occurrence:
1. for fuses and non-rechargeable batteries, operable on arrival only.
 2. for parts and accessories (except as noted in B.1) sold by Seller's Service Parts Operation, ninety (90) days.
 3. for PANTHER™ Series handportable and mobile radios, two (2) years.
 4. for all other equipment of Seller's manufacture, one (1) year.
- C. If any Equipment fails to meet the foregoing warranties, Seller shall correct the failure at its option (i) by repairing any defective or damaged part or parts thereof, (ii) by making available at Seller's factory any necessary repaired or replacement parts, or (iii) by replacing the failed Equipment with equivalent new or refurbished Equipment. Any repaired or replacement part furnished hereunder shall be warranted for the remainder of the warranty period of the Equipment in which it is installed. Where such failure cannot be corrected by Seller's reasonable efforts, the parties will negotiate an equitable adjustment in price. Labor to perform warranty service will be provided at no charge during the warranty period only for the Equipment covered under Paragraph B.3 and B.4. To be eligible for no-charge labor, service must be performed at a M/A-COM factory, by an Authorized Service Center (ASC) or other Servicer approved for these purposes either at its place of business during normal business hours, for mobile or personal equipment, or at the Buyer's location, for fixed location equipment. Service on fixed location equipment more than thirty (30) miles from the Service Center or other approved Servicer's place of business will include a charge for transportation.
- D. Seller's obligations under Paragraph C shall not apply to any Equipment, or part thereof, which (i) has been modified or otherwise altered other than pursuant to Seller's written instructions or written approval or, (ii) is normally consumed in operation or, (iii) has a normal life inherently shorter than the warranty periods specified in Paragraph B, or (iv) is not properly stored, installed, used, maintained or repaired, or, (v) has been subjected to any other kind of misuse or detrimental exposure, or has been involved in an accident.
- E. The preceding paragraphs set forth the exclusive remedies for claims based upon defects in or nonconformity of the Equipment, whether the claim is in contract, warranty, tort (including negligence), strict liability or otherwise, and however instituted. Upon the expiration of the warranty period, all such liability shall terminate. The foregoing warranties are exclusive and in lieu of all other warranties, whether oral, written, expressed, implied or statutory. **NO IMPLIED OR STATUTORY WARRANTIES OF MERCHANTABILITY OR FITNESS FOR PARTICULAR PURPOSE SHALL APPLY. IN NO EVENT SHALL THE SELLER BE LIABLE FOR ANY INCIDENTAL, CONSEQUENTIAL, SPECIAL, INDIRECT OR EXEMPLARY DAMAGES.**

This warranty applies only within the United States.

M/A-COM, Inc.
1011 Pawtucket Blvd.
Lowell, MA 01853
1-877-OPENSKY

M/A-COM, Inc.
221 Jefferson Ridge Parkway
Lynchburg, VA 24501
1-800-528-7711

ECR-7047C

NOTES



M/A-COM Wireless Systems
221 Jefferson Ridge Parkway
Lynchburg, Virginia 24501
(Outside USA, 434-385-2400) Toll Free 800-528-7711
www.macom-wireless.com

Printed in U.S.A.