

Appendix K: User Manual

Please refer to the following pages for the operator's manual and the product safety manual.



P7300 Series Portable Radio

MANUAL REVISION HISTORY

REV	DATE	REASON FOR REVISION
-	Oct/08	Initial release.

Tyco Electronics Technical Publications would particularly appreciate feedback on any errors found in this document and suggestions on how the document could be improved. Submit your comments and suggestions to:

Tyco Electronics Wireless Systems Fax your comments to: 1-434-455-6851
 Technical Publications or
 221 Jefferson Ridge Parkway e-mail us at: techpubs@tycoelectronics.com
 Lynchburg, VA 24501

ACKNOWLEDGEMENTS

The software contained in this device is copyrighted by M/A-COM, Inc. Unpublished rights are reserved under the copyright laws of the United States.

This device is made under license under one or more of the following U.S. Patents: 4,590,473; 4,636,791; 5,148,482; 5,185,796; 5,271,017; 5,377,229; 4,716,407; 4,972,460; 5,502,767; 5,146,497; 5,164,986; 5,185,795.

CREDITS!

EDACS are registered trademarks of M/A-COM, Inc.
 TORX is a registered trademark of CAMCAR division of TEXTRON, Inc.
 All other product and brand names are trademarks, registered trademarks, or service marks of their respective holders.

NOTICE!

This manual covers M/A-COM products manufactured and sold by M/A-COM, Inc.



This product conforms to the European Union WEEE Directive 2002/96/EC. Do not dispose of this product in a public landfill. Take it to a recycling center at the end of its life.

The voice coding technology embodied in this product is protected by intellectual property rights including patent rights, copyrights, and trade secrets of Digital Voice Systems, Inc. The user of this technology is explicitly prohibited from attempting to decompile, reverse engineer, or disassemble the Object Code, or in any other way convert the Object Code into human-readable form.

Repairs to this equipment should be made only by an authorized service technician or facility designated by the supplier. Any repairs, alterations, or substitution of recommended parts made by the user to this equipment not approved by the manufacturer could void the user's authority to operate the equipment in addition to the manufacturer's warranty.

This manual is published by M/A-COM, Inc., without any warranty. Improvements and changes to this manual necessitated by typographical errors, inaccuracies of current information, or improvements to programs and/or equipment, may be made by M/A-COM, Inc., at any time and without notice. Such changes will be incorporated into new editions of this manual. No part of this manual may be reproduced or transmitted in any form or by any means, electronic or mechanical, including photocopying and recording, for any purpose, without the express written permission of M/A-COM, Inc.

TABLE OF CONTENTS

	<i>Page</i>
1 SAFETY CONVENTIONS.....	10
2 SAFETY TRAINING INFORMATION	11
2.1 RF EXPOSURE GUIDELINES	11
2.2 ELECTROMAGNETIC INTERFERENCE/COMPATIBILITY	12
3 OPERATING TIPS	13
3.1 EFFICIENT RADIO OPERATION	13
3.1.1 Antenna Care and Replacement.....	13
3.1.2 Electronic Devices	13
3.1.3 Aircraft.....	14
3.1.4 Electric Blasting Caps	14
3.1.5 Potentially Explosive Atmospheres	14
4 BATTERIES	15
4.1 CONDITIONING BATTERY PACKS.....	15
4.1.1 Conditioning NiMH Battery Packs.....	15
4.1.2 Conditioning NiCd Battery Packs	15
4.1.3 Additional Information.....	16
4.2 CHARGING BATTERY PACKS	16
4.2.1 Charging Guidelines	16
4.3 BATTERY PACK USAGE.....	16
4.3.1 Usage Guidelines	16
4.4 CHANGING THE BATTERY PACK	17
4.4.1 Removing the Battery Pack	17
4.4.2 Attaching the Battery Pack	18
4.5 BATTERY DISPOSAL.....	18
5 INTRODUCTION	20
5.1 WATER RESISTANCE.....	20
6 OPTIONS AND ACCESSORIES	21
7 USER INTERFACE	23
7.1 CONTROLS	23
7.1.1 Buttons and Knobs.....	23
7.1.2 Keypad.....	25
7.1.3 Display.....	27
7.1.4 Tri-Color LED	29
7.2 UNIVERSAL DEVICE CONNECTOR.....	29
8 EDACS OPERATION.....	31
8.1 CONTROLS	31
8.1.1 Buttons and Knobs.....	31
8.1.2 Keypad.....	32
8.2 DISPLAY	35
8.3 RADIO STATUS ICONS.....	7
8.4 TRI-COLOR LED	37
8.5 STATUS MESSAGES	37
8.6 ERROR MESSAGES	38
8.7 ALERT TONES	39

TABLE OF CONTENTS

		<u>Page</u>
8.8	TURNING ON THE RADIO	39
8.9	SYSTEM SELECTION	40
8.10	GROUP/CHANNEL SELECTION	40
8.11	MODIFY SCAN LIST	41
	8.11.1 P7370 Model.....	41
	8.11.2 P7350 Model.....	41
8.12	MENU	41
	8.12.1 Menu Item Selection Process.....	42
8.13	BACKLIGHT ON/OFF	44
8.14	CONTRAST ADJUST	44
8.15	DECLARING AN EMERGENCY	45
8.16	LOCKING/UNLOCKING KEYPAD	45
8.17	HIGH/LOW POWER ADJUSTMENT	45
	8.17.1 Using the Menu Button.....	45
	8.17.2 Using the Pre-Programmed Option Button.....	45
8.18	DIGITAL VOICE OPERATION	45
	8.18.1 Clear Mode	46
	8.18.2 Digital Mode.....	46
	8.18.3 Private Mode.....	46
	8.18.4 Private Operation	47
8.19	SCANNING TRUNKED GROUPS	48
	8.19.1 Turning Scan On and Off	49
	8.19.2 Adding Groups to a Scan List.....	49
	8.19.3 Deleting Groups from a Scan List	50
	8.19.4 Nuisance Delete	51
8.20	SCANNING TRUNKED SYSTEMS.....	51
	8.20.1 Wide Area System Scanning	51
	8.20.2 Priority System Scan.....	51
	8.20.3 ProScan.....	52
8.21	EMERGENCY OPERATION	52
	8.21.1 Receiving an Emergency Call	52
	8.21.2 Declaring an Emergency Call	52
8.22	INDIVIDUAL CALLS	53
	8.22.1 Receiving and Responding to an Individual Call	53
	8.22.2 Sending an Individual Call	54
	8.22.3 Call Storage Lists.....	54
8.23	TELEPHONE INTERCONNECT CALLS	55
	8.23.1 Receiving a Telephone Interconnect Call.....	55
	8.23.2 Sending a Telephone Interconnect Call.....	55
	8.23.3 Dual-Tone Multi-Frequency: Overdial/Conventional Mode	56
8.24	PROGRAMMABLE ENTRIES	57
	8.24.1 Pre-Storing Individual and Telephone Interconnect Calls from the Keypad.....	57
8.25	STATUS/MESSAGE OPERATION	58
	8.25.1 Status Operation	58
	8.25.2 Message Operation	59
8.26	DYNAMIC REGROUP OPERATION	59
	8.26.1 Emergency Operation	59
8.27	MACRO KEY OPERATION	59

TABLE OF CONTENTS

	<i>Page</i>
8.28 PORTABLE DATA.....	60
8.28.1 Displays	60
8.28.2 DATA OFF Operation.....	60
8.28.3 DATA ON Operation	60
8.28.4 Exiting Data Cells.....	60
8.28.5 Scan Lockout Mode.....	61
8.28.6 Data Lockout Mode.....	61
9 CONVENTIONAL OPERATION	64
9.1 CONTROLS	64
9.1.1 Buttons and Knobs.....	65
9.1.2 Keypad.....	66
9.2 DISPLAY	68
9.2.1 Radio Status Icons	68
9.3 TRI-COLOR LED	69
9.4 STATUS MESSAGES	70
9.4.1 Error Messages	70
9.5 ALERT TONES	70
9.6 TURNING ON THE RADIO	70
9.7 SYSTEM SELECTION.....	71
9.8 GROUP/CHANNEL SELECTION.....	71
9.9 MODIFY SCAN LIST	72
9.9.1 P7370 Model.....	72
9.9.2 P7350 Model.....	72
9.10 NUISANCE DELETE.....	72
9.11 MENU	72
9.12 BACKLIGHT ON/OFF.....	75
9.13 CONTRAST ADJUST	75
9.14 DECLARING AN EMERGENCY.....	75
9.15 LOCKING/UNLOCKING KEYPAD	76
9.16 HIGH/LOW POWER ADJUSTMENT.....	76
9.17 DIGITAL VOICE OPERATION	76
9.17.1 Clear Mode	76
9.17.2 Digital Mode.....	77
9.18 RECEIVING A CALL	77
9.19 SENDING A CALL	78
10 P25 OPERATION.....	80
10.1 CONTROLS	80
10.1.1 Buttons and Knobs.....	81
10.1.2 Keypad.....	82
10.2 DISPLAY	84
10.3 RADIO STATUS ICONS.....	85
10.4 TRI-COLOR LED	86
10.5 STATUS MESSAGES	86
10.5.1 Error Messages	87
10.6 ALERT TONES	88
10.7 TURNING ON THE RADIO	88
10.8 SYSTEM SELECTION.....	88

TABLE OF CONTENTS

	<i>Page</i>
10.8.1 GROUP/CHANNEL SELECTION	89
10.9 MODIFY SCAN LIST	89
10.9.1 P7370 Model.....	89
10.9.2 P7350 Model.....	90
10.10 MENU	90
10.10.1 Menu Item Selection Process.....	90
10.11 BACKLIGHT ON/OFF	93
10.12 CONTRAST ADJUST	93
10.13 DECLARING AN EMERGENCY.....	93
10.14 LOCKING/UNLOCKING KEYPAD	93
10.15 HIGH/LOW POWER ADJUSTMENT	93
10.15.1 Using the Menu Button.....	93
10.15.2 Using the Pre-Programmed Option Button.....	94
10.16 DIGITAL VOICE OPERATION	94
10.16.1 Clear Mode	94
10.16.2 Digital Mode.....	94
10.16.3 Private Mode.....	94
10.16.4 Private Operation	96
10.17 SCANNING TRUNKED GROUPS	97
10.17.1 Turning Scan On and Off	97
10.17.2 Adding Groups to a Scan List.....	97
10.17.3 Deleting Groups from a Scan List	99
10.17.4 Nuisance Delete.....	99
10.18 SCANNING TRUNKED SYSTEMS.....	99
10.18.1 Wide Area System Scanning	99
10.18.2 Priority System Scan.....	100
10.18.3 ProScan.....	100
10.19 EMERGENCY OPERATION.....	100
10.19.1 Receiving an Emergency Call	100
10.19.2 Declaring an Emergency Call.....	101
10.20 INDIVIDUAL CALLS.....	101
10.20.1 Receiving and Responding to an Individual Call	101
10.20.2 Sending an Individual Call	102
10.20.3 Call Storage Lists.....	103
10.21 TELEPHONE INTERCONNECT CALLS	103
10.21.1 Receiving a Telephone Interconnect Call.....	103
10.21.2 Sending a Telephone Interconnect Call.....	104
10.21.3 Dual-Tone Multi-Frequency: Overdial/Conventional Mode	104
10.22 PROGRAMMABLE ENTRIES	106
10.22.1 Pre-Storing Individual and Telephone Interconnect Calls from the Keypad.....	106
10.23 STATUS/MESSAGE OPERATION.....	106
10.23.1 Status Operation	107
10.23.2 Message Operation	107
10.24 MACRO KEY OPERATION.....	108
10.25 PORTABLE DATA.....	108
10.25.1 Displays	108
10.25.2 DATA OFF Operation.....	108
10.25.3 DATA ON Operation	108

TABLE OF CONTENTS

	<i>Page</i>
10.25.4 Exiting Data Calls.....	109
10.25.5 Scan Lockout Mode.....	109
10.25.6 Data Lockout Mode.....	109
10.26 GROUP CALLS IN P25 MODE.....	109
10.26.1 Transmitting a Group Call.....	109
10.26.2 Receiving a Group Call.....	110
10.27 INDIVIDUAL CALLS IN P25 MODE.....	110
10.27.1 Transmitting an Individual Call.....	110
10.27.2 Receiving an Individual Call.....	110
10.28 EMERGENCY GROUP CALLS IN P25 MODE.....	110
10.28.1 Declaring an Emergency Group Call.....	110
10.28.2 Receiving an Emergency Group Call.....	111
11 TECHNICAL ASSISTANCE.....	114
12 BASIC TROUBLESHOOTING.....	115

FIGURES

Figure 4-1: Removing the Battery Pack.....	17
Figure 4-2: Attaching the Battery Pack.....	18
Figure 7-1: P7300 Portable Radio.....	23
Figure 7-2: Top View.....	24
Figure 7-3: Side View.....	24
Figure 7-4: P7350 “Scan” Model Front Panel.....	26
Figure 7-5: P7370 “System” Model Front Panel.....	26
Figure 7-6: Sample Display EDACS Mode.....	27
Figure 7-7: Full Cycle Battery Charge Indicator.....	29
Figure 7-8: Tri-Color LED.....	29
Figure 8-1: P7350 “Scan” Radio Front Panel.....	32
Figure 8-2: P7370 “System” Radio Front Panel.....	5
Figure 8-3: Radio Display in EDACS Mode.....	35
Figure 8-4: Full Cycle Battery Charge Indicator.....	37
Figure 8-5: Tri-Color LED.....	37
Figure 8-6: Menu Display.....	41
Figure 8-7: Backlight Menu Item Selection Parameter.....	42
Figure 8-8: Backlight Menu Display.....	42
Figure 8-9: System Encryption Key Display.....	47
Figure 8-10: Group/Channel Encryption Key Display.....	47
Figure 8-11: Calls Received Lists.....	53
Figure 8-12: WHC Individual Call Display.....	54
Figure 8-13: Calls Received and Personality Lists.....	55
Figure 9-1: Top View.....	64
Figure 9-2: Side View.....	64
Figure 9-3: P7350 “Scan” Radio Front Panel.....	66
Figure 9-4: P7370 “System” Radio Front Panel.....	67
Figure 9-5: Radio Display.....	68
Figure 9-6: Battery Charge Icons (Full Cycle).....	69
Figure 9-7: Tri-Color LED.....	69
Figure 9-8: Menu Display.....	73

TABLE OF CONTENTS

	<u>Page</u>
Figure 9-9: Backlight Menu Item Parameter	73
Figure 9-10: Backlight Menu Display.....	73
Figure 10-1: Top View.....	80
Figure 10-2: Side View	80
Figure 10-3: P7350 “Scan” Radio Front Panel	82
Figure 10-4: P7370 “System” Radio Front Panel	83
Figure 10-5: Radio Display.....	84
Figure 10-6: Full Cycle Battery Charge Indicator	86
Figure 10-7: Tri-Color LED.....	86
Figure 10-8: Menu Display	90
Figure 10-9: Backlight Menu Item Selection Parameter.....	91
Figure 10-10: Backlight Menu Display.....	91
Figure 10-11: System Encryption Key Display	95
Figure 10-12: Group/Channel Encryption Key Display	95
Figure 10-13: Calls Received Lists	102
Figure 10-14: WHC Individual Call Display	102
Figure 10-15: Calls Received and Personality Lists	103

TABLES

Table 2-1: RF Exposure Compliance Testing Distances	12
Table 6-1: Options and Accessories.....	21
Table 7-1: P7300 Front Keypad Functions	26
Table 7-2: Status Icons Descriptions.....	28
Table 8-1: P7350 Keypad Functions.....	32
Table 8-2: P7370 Keypad Functions.....	5
Table 8-3: Status Icon Descriptions	7
Table 8-4: Alert Tones	39
Table 8-5: Menu Item Information	43
Table 8-6: Information Display.....	44
Table 8-7: Transmit/Receive Mode Compatibility for Digital Voice Operation	48
Table 9-1: Status Icon Descriptions	68
Table 9-2: Alert Tones	70
Table 9-3: Menu Item Information	74
Table 9-4: Information Display.....	75
Table 9-5: Transmit/Receive Mode Compatibility for Digital Voice Operation	77
Table 10-1: P7350 Keypad Functions.....	82
Table 10-2: P7370 “System” Keypad Functions	83
Table 10-3: Display Descriptions	85
Table 10-4: Alert Tones	88
Table 10-5: Menu Item Information	91
Table 10-6: Information Display.....	92
Table 10-7: Transmit/Receive Mode Compatibility for Digital Voice Operation	96
Table 12-1: Troubleshooting.....	115

SAFETY SECTION

1 SAFETY CONVENTIONS

The following conventions are used throughout this manual to alert the user to general safety precautions that must be observed during all phases of operation, service, and repair of this product. Failure to comply with these precautions or with specific warning elsewhere in this manual violates safety standards of design, manufacture, and intended use of the product. M/A-COM, Inc. assumes no liability for the customer's failure to comply with these standards.



The **WARNING** symbol calls attention to a procedure, practice, or the like, which, if not correctly performed or adhered to, could result in personal injury. Do not proceed beyond a **WARNING** symbol until the conditions identified are fully understood or met.



The **CAUTION** symbol calls attention to an operating procedure, practice, or the like, which, if not performed correctly or adhered to, could result in damage to the equipment or severely degrade the equipment performance.



The **NOTE** symbol calls attention to supplemental information, which may improve system performance or clarify a process or procedure.



The **ESD** symbol calls attention to procedures, practices, or the like, which could expose equipment to the effects of Electro-Static Discharge. Proper precautions must be taken to prevent ESD when handling circuit modules.



WARNING - The electrical hazard symbol indicates there is an electrical hazard present.

2 SAFETY TRAINING INFORMATION



WARNING

The M/A-COM P7300 portable radio generates RF electromagnetic energy during transmit mode. This radio is designed for and classified as “Occupational Use Only,” meaning it must be used only during the course of employment by individuals aware of the hazards and the ways to minimize such hazards. This radio is NOT intended for use by the “General Population” in an uncontrolled environment.

The P7300 portable radio has been tested and complies with the FCC RF exposure limits for “Occupational Use Only.” In addition, this M/A-COM radio complies with the following Standards and Guidelines with regard to RF energy and electromagnetic energy levels and evaluation of such levels for exposure to humans:

- FCC OET Bulletin 65 Edition 97-01 Supplement C, Evaluating Compliance with FCC Guidelines for Human Exposure to Radio Frequency Electromagnetic Fields.
- American National Standards Institute (C95.1 – 1992), IEEE Standard for Safety Levels with Respect to Human Exposure to Radio Frequency Electromagnetic Fields, 3 kHz to 300 GHz.
- American National Standards Institute (C95.3 – 1992), IEEE Recommended Practice for the Measurement of Potentially Hazardous Electromagnetic Fields – RF and Microwave.

2.1 RF EXPOSURE GUIDELINES



CAUTION

To ensure that exposure to RF electromagnetic energy is within the FCC allowable limits for occupational use, always adhere to the following guidelines:

- DO NOT operate the radio without a proper antenna attached, as this may damage the radio and may also cause the FCC RF exposure limits to be exceeded. A proper antenna is the antenna supplied with this radio by M/A-COM or an antenna specifically authorized by M/A-COM for use with this radio. (Refer to Table 6-1.)
- DO NOT transmit for more than 50% of total radio use time (“50% duty cycle”). Transmitting more than 50% of the time can cause FCC RF exposure compliance requirements to be exceeded. The radio is transmitting when the “TX” indicator appears in the display. The radio will transmit by pressing the “PTT” (Push-To-Talk) button.
- Always transmit using low power when possible. In addition to conserving battery charge, low power can reduce RF exposure.
- ALWAYS use M/A-COM authorized accessories (antennas, batteries, belt clips, speaker/mics, etc). Use of unauthorized accessories may cause the FCC Occupational/Controlled Exposure RF compliance requirements to be exceeded. (Refer to Table 2-1.)

- As noted in Table 2-1, ALWAYS keep the device and its antenna **AT LEAST** 1.1 cm (0.43 inches) from the body and at least 2.5 cm (1.0 inch) from the face when transmitting to ensure FCC RF exposure compliance requirements are not exceeded. However, to provide the best sound quality to the recipients of your transmission, M/A-COM recommends you hold the microphone at least 5 cm (2 inches) from mouth, and slightly off to one side.

Table 2-1: RF Exposure Compliance Testing Distances

RADIO FREQUENCY	TESTED DISTANCES <i>(worst case scenario)</i>	
	Body	Face
450-512 MHz	1.1 cm	2.5 cm

The information in this section provides the information needed to make the user aware of RF exposure, and what to do to assure that this radio operates within the FCC RF exposure limits of this radio.

2.2 ELECTROMAGNETIC INTERFERENCE/COMPATIBILITY

During transmissions, this M/A-COM radio generates RF energy that can possibly cause interference with other devices or systems. To avoid such interference, turn off the radio in areas where signs are posted to do so. DO NOT operate the transmitter in areas that are sensitive to electromagnetic radiation such as hospitals, aircraft, and blasting sites.

3 OPERATING TIPS

Antenna location and condition are important when operating a portable radio. Operating the radio in low lying areas or terrain, under power lines or bridges, inside of a vehicle or in a metal framed building can severely reduce the range of the unit. Mountains can also reduce the range of the unit.

In areas where transmission or reception is poor, some improvement may be obtained by ensuring that the antenna is vertical. Moving a few yards in another direction or moving to a higher elevation may also improve communications. Vehicular operation can be aided with the use of an externally mounted antenna.

Battery condition is another important factor in the trouble free operation of a portable radio. Always properly charge the batteries.

3.1 EFFICIENT RADIO OPERATION

For optimum audio clarity at the receiving radio(s), hold the portable radio approximately two inches from your mouth and speak into the microphone at a normal voice level.

Keep the antenna in a vertical position when receiving or transmitting a message.

Do not hold the antenna when receiving a message and, especially, do not hold when transmitting a message.



Do NOT hold onto the antenna when the radio is powered on!

3.1.1 Antenna Care and Replacement



Do not use the portable radio with a damaged or missing antenna. A minor burn may result if a damaged antenna comes into contact with the skin. Replace a damaged antenna immediately. Operating a portable radio with the antenna missing could cause personal injury, damage the radio, and may violate FCC regulations.



Use only the supplied or approved antenna. Unauthorized antennas, modifications, or attachments could cause damage to the radio unit and may violate FCC regulations. (Refer to Table 6-1.)

3.1.2 Electronic Devices



RF energy from portable radios may affect some electronic equipment. Most modern electronic equipment in cars, hospitals, homes, etc. is shielded from RF energy. However, in areas in which you are instructed to turn off two-way radio equipment, always observe the rules. If in doubt, turn it off!

3.1.3 Aircraft



- Always turn off a portable radio before boarding any aircraft!
- Use it on the ground only with crew permission.
- DO NOT use while in-flight!!

3.1.4 Electric Blasting Caps



To prevent accidental detonation of electric blasting caps, DO NOT use two-way radios within 1000 feet of blasting operations. Always obey the "Turn Off Two-Way Radios" signs posted where electric blasting caps are being used. (OSHA Standard: 1926.900)

3.1.5 Potentially Explosive Atmospheres



Areas with potentially explosive atmospheres are often, but not always, clearly marked. These may be fuelling areas, such as gas stations, fuel or chemical transfer or storage facilities, and areas where the air contains chemicals or particles, such as grain, dust, or metal powders.

Sparks in such areas could cause an explosion or fire resulting in bodily injury or even death.

Turn OFF two-way radios when in any area with a potentially explosive atmosphere. It is rare, but not impossible that a radio or its accessories could generate sparks.

4 BATTERIES

The P7300 series portable radios use rechargeable, recyclable Nickel Cadmium (NiCd), Nickel Metal Hydride (NiMH), or Lithium Ion (Li Ion) batteries. Please follow the directions below to maximize the useful life of each type of battery.



Do not disassemble or modify Lithium Ion battery packs. The Lithium Ion battery packs are equipped with built-in safety and protection features. Should these features be disabled or tampered with in any way, the battery pack can leak acid, overheat, emit smoke, burst, and/or, ignite.



If the battery is ruptured or is leaking electrolyte that results in skin or eye contact with the electrolyte, immediately flush the affected area with water. If the battery electrolyte gets in the eyes, flush with water for 15 minutes and consult a physician immediately.

4.1 CONDITIONING BATTERY PACKS

4.1.1 Conditioning NiMH Battery Packs

Condition a new NiMH battery before putting into use. This also applies to rechargeable NiMH batteries that have been stored for long periods (weeks, months, or longer). Conditioning requires fully charging and fully discharging the battery three (3) times using the tri-chemistry charger. The first time the battery is put into the charger, this unit will condition Nickel-based battery packs by automatically charging and discharging (cycling) the battery. Refer to the appropriate charger manual for details.



Failure to properly condition NiMH battery packs before initial use will result in shortened performance by the battery.

4.1.2 Conditioning NiCd Battery Packs

A new NiCd battery does not require conditioning before use. However, M/A-COM recommends periodically conditioning NiCd batteries to avoid the memory effect which results when a NiCd battery is repeatedly charged and not fully discharged, further resulting in a lower voltage and a lower capacity. Fortunately, both nominal voltage and capacity are restored through battery conditioning.

Conditioning requires fully charging and fully discharging the battery three (3) times using the tri-chemistry charger. The first time the battery is put into the charger, this unit will condition Nickel-based battery packs by automatically charging and discharging (cycling) the battery. Refer to the appropriate charger manual for details.



Always use M/A-COM authorized chargers and conditioners. Use of unauthorized chargers and conditioners may void the warranty.

4.1.3 Additional Information

For more information regarding the proper care of portable radio batteries or establishing a battery maintenance program, refer to ECR-7367 which may be ordered by calling toll free 1-800-368-3277, then select option 7.

4.2 CHARGING BATTERY PACKS

Battery chargers are available from M/A-COM with nominal charge times. Combinations include single and multi-position charge units.

M/A-COM chargers are specifically designed for charging nickel-based and lithium ion battery packs. The chargers are chemistry-specific for the battery packs and automatically adjust the charging profiles accordingly. Refer to the appropriate charger manual for specific operating instructions.

4.2.1 Charging Guidelines

Observe the following guidelines when charging a battery pack:

- Avoid high temperature during charging.
- Discontinue use if the charger is overheating.
- Only charge M/A-COM battery packs using a charger approved for use by M/A-COM.
- Do not leave batteries in the charger indefinitely. For best results leave the battery in the charger for two to six hours after the Green Ready LED comes on. Then place the battery pack into service and fully discharge (as indicated by the radio low battery warning) before re-charging.

If any faults are encountered while charging the battery pack, consult the charger's manual to determine the cause and possible corrective action.

4.3 BATTERY PACK USAGE

Both Nickel-based and Lithium ion batteries vary in capacity and life cycle. For instance, NiCd batteries have a longer life cycle than NiMH batteries whereas NiMH batteries have a larger capacity. However, both Nickel-based and Lithium ion type batteries require basic usage guidelines be followed in order to optimize the battery runtime or shift life.

4.3.1 Usage Guidelines

The following guidelines will help optimize the battery runtime or shift life:

- Ensure Nickel-based battery packs are fully discharged (as indicated by the radio low battery warning) before re-charging. Full discharge is not required for Lithium Ion battery packs.
- Periodically condition Nickel-based battery packs. The frequency should be determined based on usage patterns (refer to ECR-7367). If the battery is fully discharged (to radio Low Battery warning) during routine use, the frequency of conditioning may be reduced. Lithium Ion batteries do not suffer from memory-effect and therefore do not require conditioning.

Do not leave any M/A-COM rechargeable batteries in a charger for more than a few days.

4.4 CHANGING THE BATTERY PACK

4.4.1 Removing the Battery Pack

Make sure the power to the radio is turned OFF.



Although the P7300 has been designed to tolerate changing the battery pack without turning power off, M/A-COM, Inc. recommends turning the radio off before changing battery packs to ensure safety and best operation.

1. Press or pull both latches on either side of the battery pack ① toward the bottom of the radio simultaneously.
2. Pull the battery ② away from the radio.
3. Remove the battery pack from the radio.



Figure 4-1: Removing the Battery Pack

4.4.2 Attaching the Battery Pack

Make sure the power to the radio is turned OFF.

1. Align the tabs at each side on the bottom of the battery pack with the slots at the bottom of the battery cavity ①.
2. Push the top of the battery pack ② down until the latches click to attach the battery to the radio.
3. Tug gently to verify that the latches are secure and the battery pack is properly attached to the radio.



Figure 4-2: Attaching the Battery Pack

4.5 BATTERY DISPOSAL



In no instance should a battery be incinerated. Disposing of a battery by burning will cause an explosion.



RECHARGEABLE BATTERY PACK DISPOSAL – The product you have purchased contains a rechargeable battery. The battery is recyclable. At the end of its useful life, under various state and local laws, it may be illegal to dispose of this battery into the municipal waste stream. Check with your local solid waste officials for details in your area for recycling options or proper disposal. Canadian and U.S. users may call Toll Free 1-800-8-BATTERY® for information and/or procedures for returning rechargeable batteries in your locality.

PRODUCT INFORMATION

5 INTRODUCTION

The P7300 series portable radio is available in two models: the P7350 Scan model with a limited 6-button front-mounted keypad and the P7370 System model with a 15-button DTMF front-mounted keypad. The UHF P7300 portable radio delivers end-to-end encrypted digital voice and IP data communications. It is designed to support multiple operating modes including:

- EDACS® (Enhanced Digital Access Communications System) or ProVoice™ Trunked mode
- P25 Trunked Mode
- P25 Digital Conventional Mode
- Conventional Analog mode

The P7300 portables can include all of these modes or just one. Additional modes of operation can be added with software updates.

The P7300 supports a full range of advanced digital trunking features, including voice group calls, priority scanning, emergency calls, late call entry, and dynamic reconfiguration. It performs autonomous roaming for wide area applications. High quality voice coding and robust audio components assure speech clarity.

In the trunked modes, the user selects a communications “operating” system (i.e., EDACS, ProVoice, or P25) and group. While communicating in a trunked mode, channel selection is transparent to the user and is controlled via digital communication with the system controller (e.g. a CSD in an EDACS system). This provides advanced programmable features and fast access to communication channels.

In Conventional Analog mode, the user selects a channel and communicates directly on that channel. A channel is a transmit/receive radio frequency pair.

The exact operation of the radio will depend on the operating mode, the radio’s programming, and the particular radio system. Most features described in this manual can be enabled through programming. Consult your System Administrator for the particular features programmed into your P7300. Then refer to the corresponding section(s) within this manual for feature and operation information.

5.1 WATER RESISTANCE

The P7300 series portable radios operate reliably even under adverse conditions. These radios meet MIL-STD-810F specifications for wind driven rain, humidity, and salt fog.

6 OPTIONS AND ACCESSORIES

Table 6-1 lists the Options and Accessories tested for use with the P7300 series portable radios.

Refer to the maintenance manual or to M/A-COM's Products and Services Catalog for a complete list of options and accessories, including those items that do not adversely affect the RF energy exposure.



Always use M/A-COM authorized accessories (antennas, batteries, belt clips, speaker/mics, etc). Use of unauthorized accessories may cause the FCC Occupational/Controlled Exposure RF compliance requirements to be exceeded. (Refer to Table 2-1.)



Always use the correct options and accessories (battery, antenna, speaker/mic, etc.) for the radio. Intrinsically safe options must be used with intrinsically safe radios. (Refer to Table 6-1.)

Table 6-1: Options and Accessories

DESCRIPTION	PART NUMBER
ANTENNAS	
Helical Stub 470-512 MHz	KRE 101 1219/14
¼ λ Whip 440-512 MHz	KRE 101 1223/12
BATTERIES (IMMERSION-RATED)	
7.5V Nickel Cadmium (NiCd) Battery, Immersible, non-<IS>	BT-023406-001
7.5V Nickel Cadmium (NiCd) Battery, Immersible, <IS>	BT-023406-002
7.5V Nickel Metal Hydride (NiMH) Battery, Immersible, non-<IS>	BT-023406-003
7.5V Nickel Metal Hydride (NiMH) Battery, Immersible, <IS>	BT-023406-004
7.5V Lithium Ion (Li Ion) Battery, Immersible, non-<IS>	BT-023406-005
7.5V Lithium Ion (Li Ion) Battery, Immersible, <IS>	BT-023406-006
MISCELLANEOUS ACCESSORIES	
Speaker Mic without Antenna (cc) provision, <IS>	MC-023933-001
Speaker Mic with Antenna (cc) provision, <IS>	MC-023933-002
Earphone for Speaker Mic <IS>	LS103239V1
DROP SHIP AUDIO ACCESSORIES	
Earphone Kit, Black	EA-009580-001
Earphone Kit, Beige	EA-009580-002
2-Wire Kit, Palm Mic, Black	EA-009580-003
2-Wire Kit, Palm Mic, Beige	EA-009580-004
3-Wire Kit, Mini-Lapel Mic, Black	EA-009580-005
3-Wire Kit, Mini-Lapel Mic, Beige	EA-009580-006
Explorer Headset with PTT	EA-009580-007
Lightweight Headset Single Speaker with PTT	EA-009580-008
Breeze Headset with PTT	EA-009580-009
Headset, Heavy Duty, N/C Behind-the-Head, with PTT	EA-009580-010
Ranger Headset with PTT	EA-009580-011
Skull Mic with Body PTT and Earcup	EA-009580-012
Headset, Heavy Duty, N/C Over-the-Head, with PTT	EA-009580-013
Throat Mic with Acoustic Tube and Body PTT	EA-009580-014

DESCRIPTION	PART NUMBER
Throat Mic with Acoustic Tube, Body PTT, and Ring PTT	EA-009580-015
Breeze Headset with PTT and Pigtail Jack	EA-009580-016
Hurricane Headset with PTT	EA-009580-017
Hurricane Headset with PTT and Pigtail Jack	EA-009580-018
CARRYING CASE ACCESSORIES	
P7300 Black Nylon Case with Belt Loop Kit, consists of: P7300 Black Nylon Case with Retaining Strap and Leather Belt Loop	Kit: KT-016201-001 , incl: FM-016199-001 CC-014527
P7300 Orange Nylon Case with Belt Loop Kit, consists of: P7300 Orange Nylon Case with Retaining Strap and Leather Belt Loop	Kit: KT-016201-002 , incl: FM-016199-002 CC-014527
P7300 Leather Case with Belt Loop Kit, consists of: P7300 Leather Case with Retaining Strap (w/o Shoulder Strap D-Rings), Swivel Mount and Leather Belt Loop	Kit: KT-016201-003 , incl: FM-016199-003 KRY 101 1608/2 CC-014527
P7300 Leather Case with Shoulder Strap Kit, consists of: P7300 Leather Case with Retaining Strap D-Rings with Retaining Strap, Swivel Mount Shoulder Strap	Kit: KT-016201-004 , incl: FM-016199-004 KRY 101 1608/2 CC-014524-001
Short Leather Retaining Strap (for use with Shoulder Strap application)	CC-014524-002
Swivel Mount and Belt Loop	KRY 101 1608/2 KRY 101 1609/1
Metal Belt Clip (standard)	CC23894
Metal Belt Clip (alternate)	CC-011318
"T" Strap Holder	KRY 101 1656/1

7 USER INTERFACE

This section describes the primary user interface; the buttons, knob controls, indicators, and display.

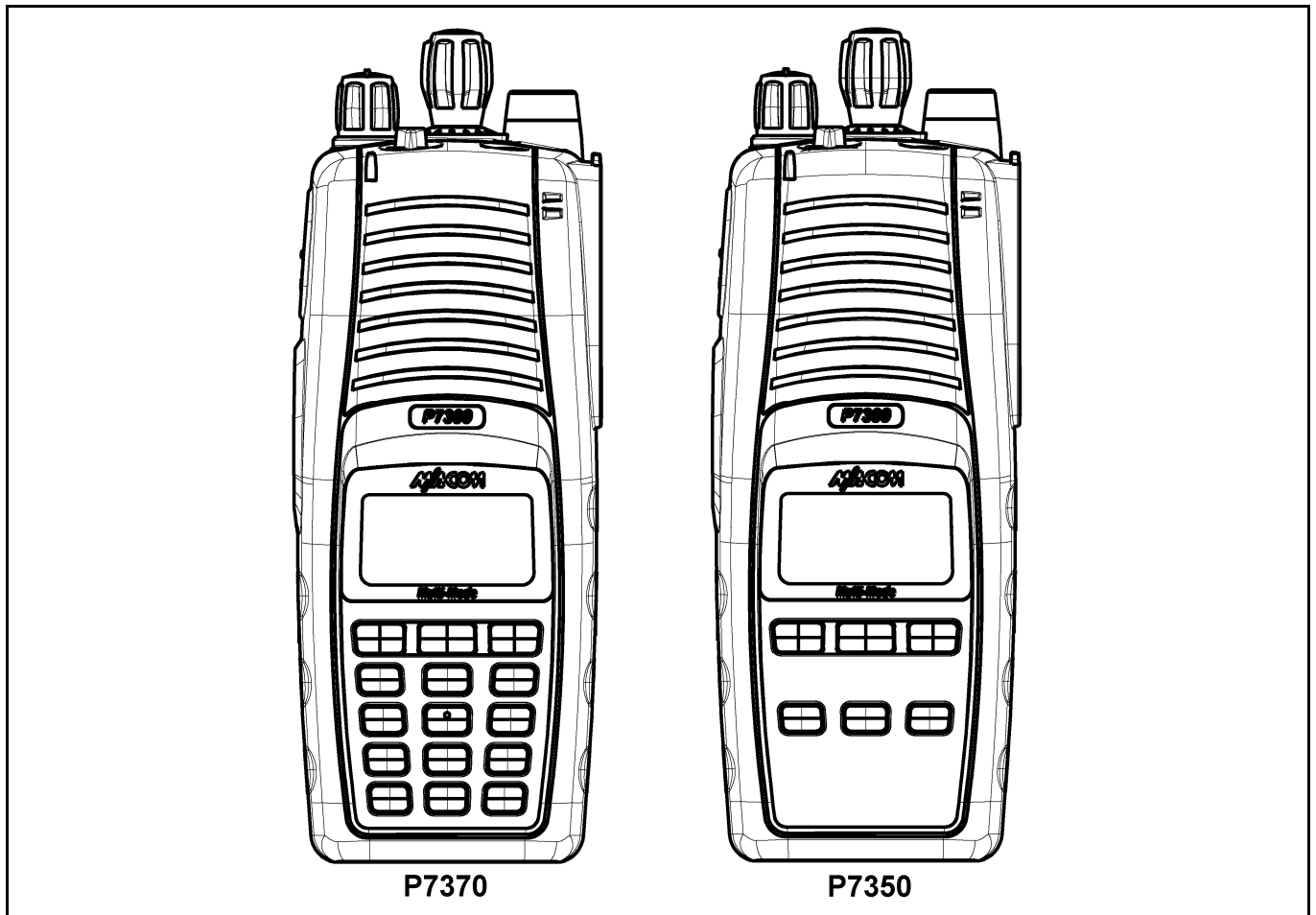

Figure 7-1: P7300 Portable Radio

7.1 CONTROLS

7.1.1 Buttons and Knobs

The P7300 portable radios feature two rotary control knobs, an emergency button, and a dual-position A/B switch located on the top of the radio (Figure 7-2). The Push-To-Talk (PTT) button and two option buttons are located on the side (Figure 7-3).

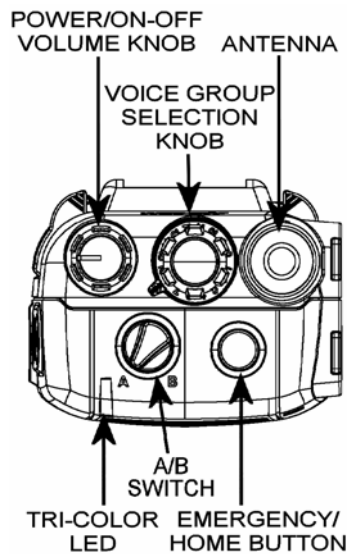

Figure 7-2: Top View

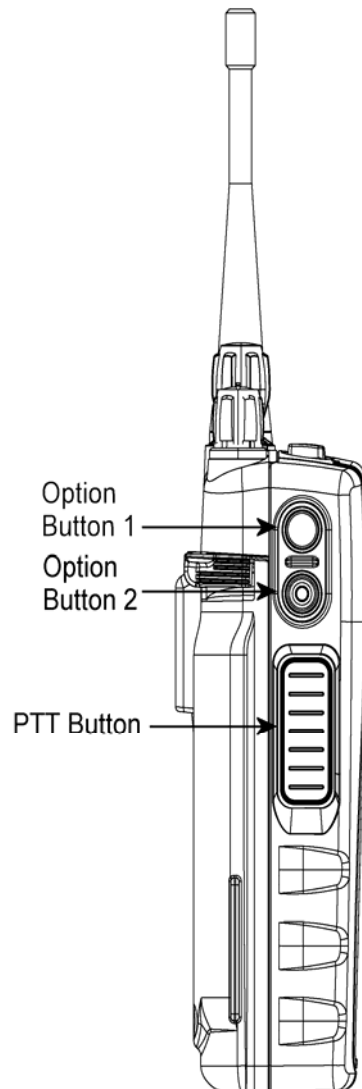



Figure 7-3: Side View

The functions of the button and knob controls vary depending on the mode of operation. The primary functions of the button and knob controls when in the EDACS mode of operation are listed in the following paragraphs. The functions while in other modes are discussed in the specific sections.

POWER ON-OFF/VOLUME KNOB	<p>Applies power to the radio and adjusts audio volume.</p> <p>Rotating the control clockwise applies power to the radio. A single alert tone (if enabled through programming) indicates the radio is operational.</p> <p>Rotating the control clockwise increases the volume level. Minimum volume levels may be programmed into the radio to prevent missed calls due to a low volume setting. While adjusting the volume, the display will momentarily indicate the volume level (i.e. VOL=31). The volume range is from a minimum programmed level of zero (displayed as OFF in the display) up to 40, which is the loudest level.</p>
VOICE GROUP SELECTION CONTROL KNOB	<p>Used to select groups/channels. This is a 16-position rotary knob.</p> <p><i>Note:</i> A mechanical stop, used to limit the number of accessible positions, is shipped with the radio but must be installed. To install the mechanical stop, remove the Voice Group Selection control knob, loosen the set screw on the Voice Group Selection control knob metal base (using a 1.27 mm hex wrench), and remove the Voice Group Selection control knob metal base. Replace the 16 channel ring with the channel stop ring located at the desired channel. Re-install the Voice Group Selection control knob metal base, tighten the set screw, and re-install the Voice Group Selection control knob.</p>
EMERGENCY BUTTON	<p>Used to declare an emergency by pressing and holding for a programmed duration.</p>
PTT BUTTON	<p>The Push-To-Talk button must be pressed before voice transmission begins.</p>
SIDE OPTION BUTTON 1  SIDE OPTION BUTTON 2 	<p>Scrolls UP or DOWN thru available items within a sub-menu (available talk groups, pre-programmed speed dial numbers, canned alert messages, etc.).</p>

7.1.2 Keypad

The front mounted keypad of the P7350 “Scan” model has six buttons and P7370 “System” model has 15 buttons. Refer to Figure 7-4: P7350 “Scan” Model Front Panel and Figure 7-5: P7370 “System” Model Front Panel, respectively.

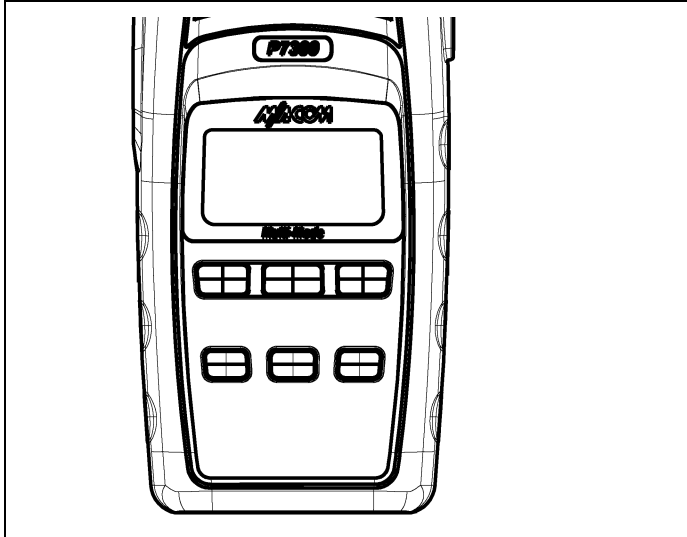

Figure 7-4: P7350 “Scan” Model Front Panel

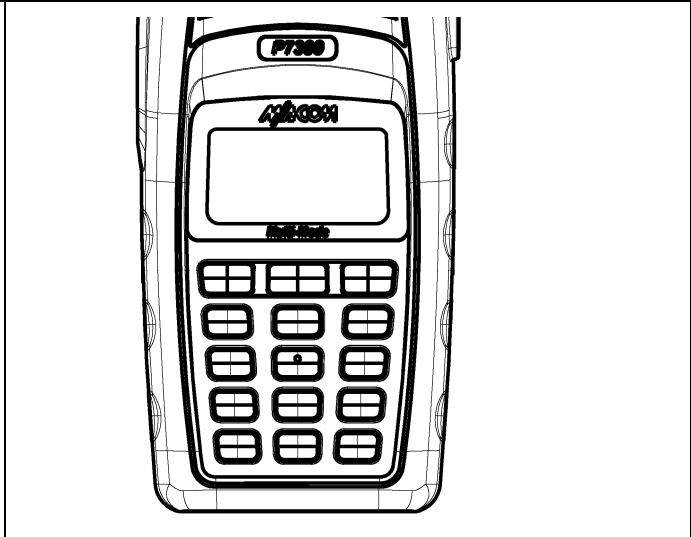



















Figure 7-5: P7370 “System” Model Front Panel

Alpha-numeric character entry is the secondary function of most of the P7300 keypad keys in the EDACS mode of operation. In addition, the ***PIN*** (*) and **#IND** (#) keys are also available. The primary and secondary functions of each key, where applicable, are described in Table 7-1 and the following section.

Table 7-1: P7300 Front Keypad Functions

KEY	FUNCTION
M	<u>Primary Function:</u> Accesses the pre-stored menu. <u>Secondary Function:</u> Activates a selected item within the menu. This is similar to an “Enter” key.
▲ ▼	<u>Primary Function:</u> Allows the user to scroll through available systems, groups, or channels, depending on personality programming. <u>Secondary Function:</u> Changes the selection for an item within a list.
A/D (P7350 only)	In EDACS and Conventional Analog modes, Adds/Deletes selected groups or channels from SCAN list of the currently selected system.
SCN (P7350 only)	In EDACS and Conventional Analog modes, toggles SCAN operation ON and OFF.
OPT (P7350 only)	In EDACS and Conventional Analog modes, activates one of any programmable software options selected during the PC programming, including: high/low TX power and talkaround.
1 SYS	<u>Primary function:</u> Selects a specific system. If the rotary knob is used to select the system and more than 16 systems are programmed in the radio, the 1 SYS key is used to select additional banks (groupings) of systems.
2 GRP	<u>Primary function:</u> Selects a specific group.
3 SCN	<u>Primary function:</u> Turns the Scan operation ON and OFF.
4 PM	<u>Primary function:</u> Enables or disables Private Mode for the system/group/channel displayed.
6 ADD	<u>Primary function:</u> Adds groups or channels from the currently selected system to the Scan list.

KEY	FUNCTION
	<u>Primary function:</u> Status key. Access to the status list (0-9). The Status key permits the transmission of a pre-programmed status message to an EDACS site.
	<u>Primary function:</u> Message key. Access to the message list (0-9). The Message key permits the transmission of a pre-programmed message to an EDACS site.
	<u>Primary function:</u> Deletes selected groups or channels of the currently selected system from the Scan list.
            <i>(P7370 Only)</i>	<u>Secondary function:</u> In EDACS mode the secondary function of these keys is much as a typical DTMF telephone pad 0-9, *, and # keys; and are used to place telephone interconnect and individual (unit-to-unit) calls. (See individual listings for primary functions.)
 <i>(P7370 Only)</i>	<u>Primary function:</u> In EDACS mode, initiates telephone interconnect calls.
 <i>(P7370 Only)</i>	<u>Primary function:</u> In EDACS mode, initiates individual, unit-to-unit calls.

7.1.3 Display

The P7300 display is made up of 3 lines. Lines 1 and 2 contain twelve alpha-numeric character blocks each. The 3rd line also contains twelve blocks, each used to display radio status icons. If programmed, the display backlighting will illuminate upon power up or when radio controls are operated. Specific display characteristics will be discussed in following sub-sections.

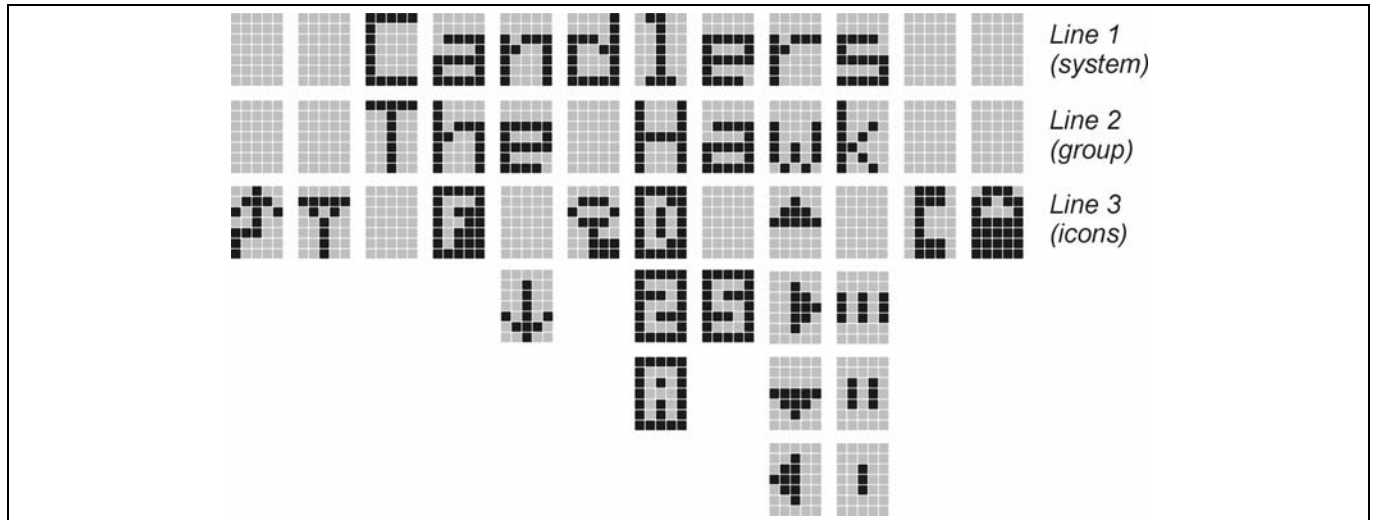

















Figure 7-6: Sample Display EDACS Mode

7.1.3.1 Radio Status Icons

Status Icons represent various operating characteristics of the radio and appear on the third line of the display. Each of the icons will be discussed in further detail in the corresponding modes of operation;

EDACS and Conventional icons will be discussed in the EDACS or Conventional Operation sections, and P25 icons will be discussed in the P25 Operation section.

Table 7-2: Status Icons Descriptions

STATUS ICON DESCRIPTIONS	
EDACS, CONVENTIONAL, AND P25 ICONS	
	Steady – “Busy” transmitting or receiving. Appears in the 2nd position of the display.
	Steady – special call mode (telephone). Appears in the 11 th position of the display.
	Steady – during all radio transmissions. Appears in the 1st position of the display.
	Steady – transmit at low power. Appears in the 5th position of the display. If icon is not visible – transmit at high power
	Steady – battery charge indicator (refer to Figure 9-6). Appears in the 12th position of the display.
	Flashing – Low battery indicator (refer to Figure 9-6).
	Steady – Indicates the current channel is set up as an analog channel. Appears in the 7th position of the display.
	Steady – group or channel in scan list. Appears in the 10th position of the display.
	Steady – priority 2 group or channel. Appears in the 10th position of the display.
	Steady – priority 1 group or channel. Appears in the 10th position of the display.
	Steady (rotates clockwise) – scan mode enabled. Appears in the 9th position of the display. If icon is not visible – scan is disabled
	Steady – Channel Guard enabled. Appears in the 4th position of the display. If icon is not visible – Channel Guard is disabled
	Steady – transmit in encrypt mode. Appears in the 6th position of the display. Flashing – receiving an encrypted call
	Steady – Indicates the current channel is set up as a Project 25 (P25) channel.
	Steady – Indicates the current channel is set up as a ProVoice channel. Appears in the 7th position of the display.

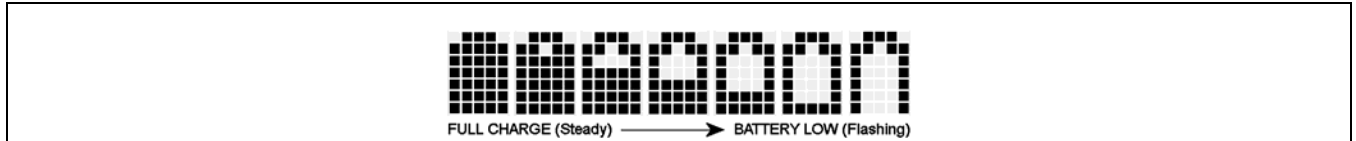

Figure 7-7: Full Cycle Battery Charge Indicator

The battery charge indicators illustrate approximate level only, based on battery voltage. Refer to Figure 7-7.

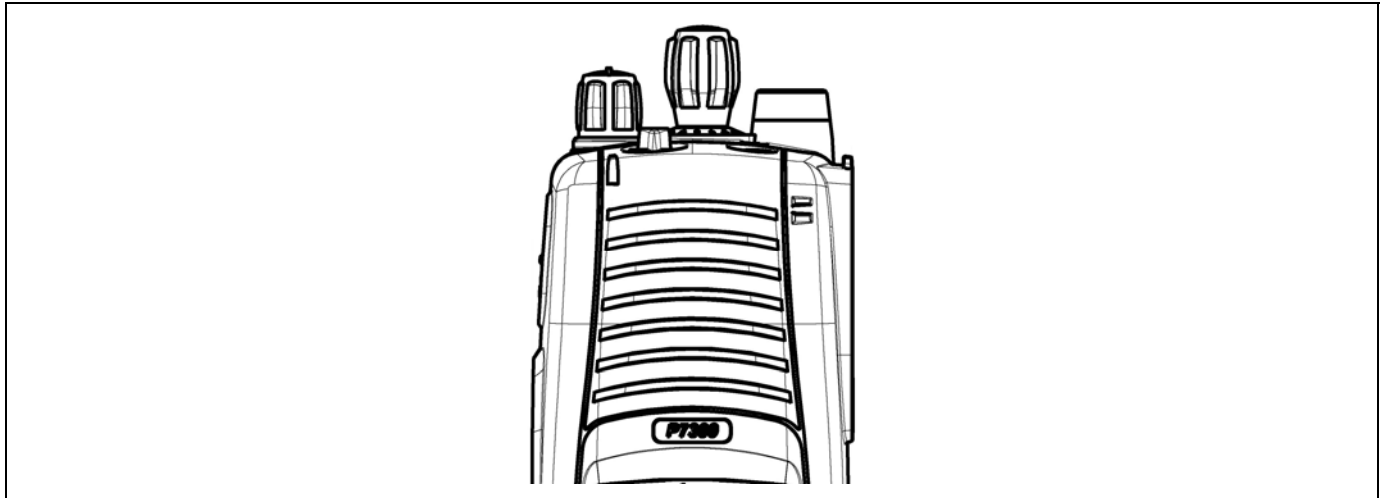

Figure 7-8: Tri-Color LED

7.1.4 Tri-Color LED

The Tri-Color LED changes color to indicate radio status and is visible from both the front and top of the radio (see Figure 7-2). In addition, the mode of operation may also help determine what the color of the LED represents.

In EDACS, Conventional, or P25 modes

Green:	Receiving
Red:	Transmitting Unencrypted
Orange:	Transmitting Encrypted

7.2 UNIVERSAL DEVICE CONNECTOR

The Universal Device Connector (UDC) provides connections for external accessories such as a headset, a speaker-microphone, audio test box, audio test cables, and programming cables. The UDC is located on the right side of the radio, opposite the PTT Button. The UDC facilitates programming and testing the radio. The UDC pins perform different functions depending on the accessory attached to the UDC.

EDACS OPERATION

8 EDACS OPERATION

8.1 CONTROLS

The radio features two rotary control knobs and an emergency button mounted on the top of the radio. Push-To-Talk and option buttons are mounted on the side. The front mounted keypad has six buttons on the P7350 Scan model and 15 buttons on the P7370 System Radio.

8.1.1 Buttons and Knobs

This section describes the primary function of the button and knob controls (see Figure 7-2 and Figure 7-3). Other functions associated with these controls are detailed in later sections.

POWER ON-OFF VOLUME KNOB

Applies power to and adjusts the receiver's volume. Rotating the control clockwise applies power to the radio. A single alert tone (if enabled through programming) indicates the radio is operational.

Rotating the control clockwise increases the volume level. Minimum volume levels may be programmed into the radio to prevent missed calls due to a low volume setting. While adjusting the volume the display will momentarily indicate the volume level (i.e. *VOL=31*). The volume range is from a minimum programmed level of zero (displayed as **OFF** in the display) up to 40, which is the loudest level.

VOICE GROUP SELECTION CONTROL KNOB

Selects systems or group/channels (depending on programming). This is a 16-position rotary knob.

Note: A mechanical stop, which can limit the positions accessed, is shipped with the radio but must be installed. To install the mechanical stop, remove the Voice Group Selection control knob, loosen the set screw on the Voice Group Selection control knob metal base (using a 1.27 mm hex wrench), and remove the Voice Group Selection control knob metal base. Replace the 16 channel ring with the channel stop ring located at the desired channel. Reinstall the Voice Group Selection control knob metal base, tighten the set screw, and reinstall the Voice Group Selection control knob.

EMERGENCY/ HOME BUTTON

Automatically selects the pre-programmed Group/System by pressing and holding for a programmed duration. It can also be used to declare an emergency by pressing and holding for a programmed duration. The button must be pre-programmed for either operation, but not both.

PTT BUTTON

Push-To-Talk must be pressed before voice transmission begins. In trunked mode the radio's ID is transmitted upon depression of the PTT button.

SIDE OPTION BUTTON 1 ○

Exits the current operation (removing all displays associated with it) and returns the radio to the selected talk group. Terminates individual and telephone interconnect calls.

SIDE OPTION BUTTON 2 ◎

Activates one of a number of programmable software options selected during PC programming. Programmable options include hi/low power settings, keypad lock, LCD contrast, LCD and keypad back lighting.

8.1.2 Keypad

The keys on the keypad have special functions and are labeled using a symbol or abbreviated word describing its primary function. Alpha-numeric entry is a secondary function of the keys. Each key is described in the following subsections.

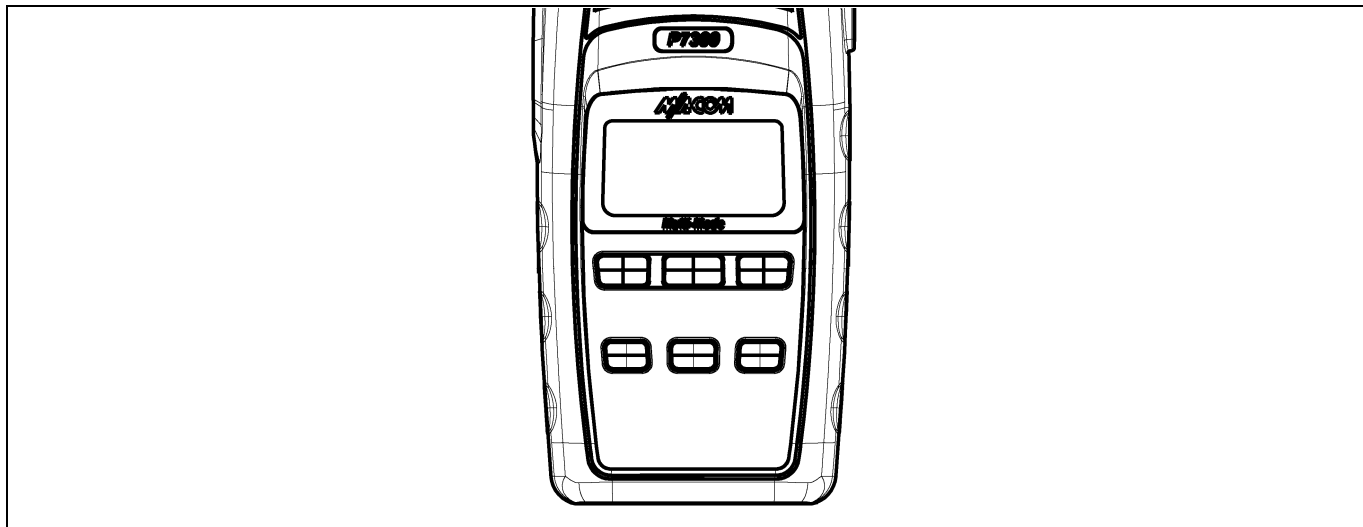

Figure 8-1: P7350 “Scan” Radio Front Panel

Table 8-1: P7350 Keypad Functions

KEY	FUNCTION
M	<u>Primary Function:</u> Accesses the pre-stored menu. <u>Secondary Function:</u> Activates a selected item within the menu. This is similar to an “Enter” key.
▲ ▼	Scrolls thru available menu items.
OPT (P7350 only)	Activates one of any programmable software options selected during the PC programming, including: high/low TX power and talkaround.
SCN (P7350 only)	Toggles SCAN operation ON and OFF.
A/D (P7350 only)	Adds/Deletes selected groups or channels from SCAN list of the currently selected system.

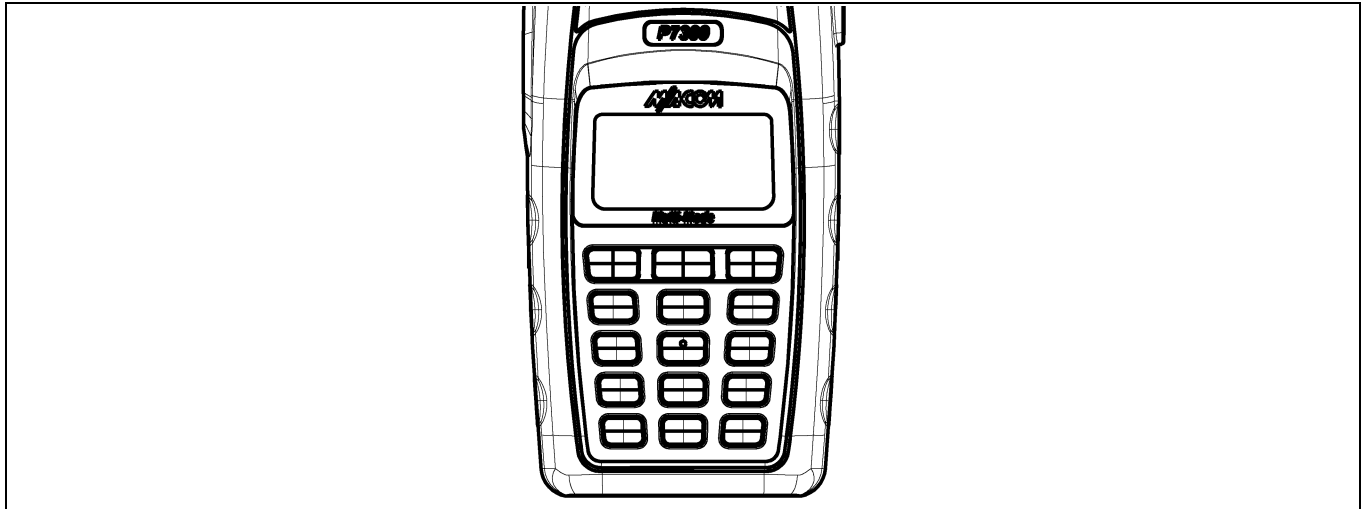

Figure 8-2: P7370 “System” Radio Front Panel

Table 8-2: P7370 Keypad Functions

KEY	FUNCTION
	<u>Primary Function:</u> Accesses the pre-stored menu. <u>Secondary Function:</u> Activates a selected item within the menu. This is similar to an “Enter” key.
	<u>Primary Function:</u> Allows the user to scroll through available systems, groups, or channels, depending on personality programming. <u>Secondary Function:</u> Changes the selection for an item within a list.
	<u>Primary Function:</u> Refer to the separate key definitions within this table. <u>Secondary Function:</u> These keys function much as a typical DTMF telephone pad 0-9, *, and # keys; and are used to place telephone interconnect and individual (unit-to-unit) calls.
	Selects a specific system. If the rotary knob is used to select the system and more than 16 systems are programmed in the radio, the key is used to select additional banks (groupings) of systems.
	Selects a specific group.
	Turns the Scan operation ON and OFF.
	Enables or disables Private Mode for the system/group/channel displayed.
	Adds groups or channels from the currently selected system to the Scan list.
	Status. Access to the status list (0-9). The Status key permits the transmission of a pre-programmed status message to an EDACS site.
	Message. Access to the message list (0-9). The Message key permits the transmission of a pre-programmed message to an EDACS site.
	Deletes selected groups or channels of the currently selected system from the Scan list.

KEY	FUNCTION
* PIN	Initiates telephone interconnect calls.
# IND	Initiates individual unit-to-unit calls.

8.2 DISPLAY

The radio Display is made up of 3 lines (see Figure 8-3). Lines 1 and 2 contain eight alphanumeric character blocks and are used primarily to display system and group names. Line 1 also displays radio status messages. The 3rd line is used primarily to display radio status icons. All three lines are used to display menu options when in the menu mode. If programmed, the display backlighting will illuminate upon power up or when radio controls are operated.

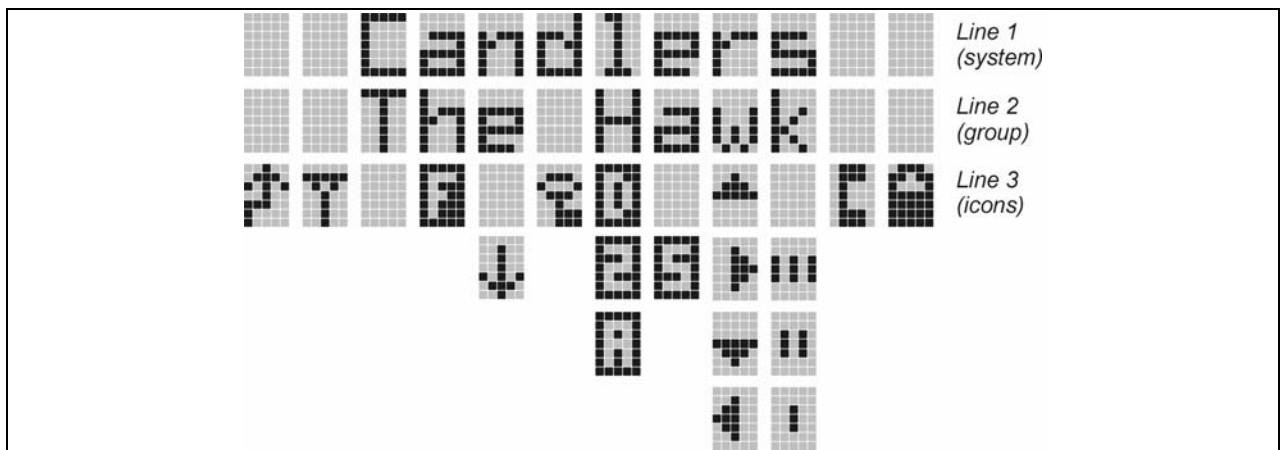











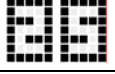



Figure 8-3: Radio Display in EDACS Mode

8.3 RADIO STATUS ICONS

Status Icons indicate the various operating characteristics of the radio. The icons show operating modes and conditions and appear on the third line of the display (see Table 8-3).

Table 8-3: Status Icon Descriptions

	Steady – “Busy” transmitting or receiving. Appears in the 2 nd position of the display. Flashing – call queued
	Steady – special call mode (individual or telephone). Appears in the 11 th position of the display.
	Steady – during all radio transmissions. Appears in the 1 st position of the display
	Steady – transmit at low power. Appears in the 5th position of the display. If icon is not visible – transmit at high power
	Steady – battery charge indicator. Appears in the 12th position of the display. Flashing – Low battery indicator.
	Steady – Indicates the current channel is set up as an analog channel. Appears in the 7th position of the display.
	Steady – trunked system in Failsoft™ mode. Appears in the 4th position of the display.
	Steady – group or channel in scan list. Appears in the 10th position of the display.
	Steady – priority 2 group or channel. Appears in the 10th position of the display.
	Steady – priority 1 group or channel. Appears in the 10th position of the display.
	Steady (rotates clockwise) – scan mode enabled. Appears in the 9th position of the display. If icon is not visible – scan is disabled
	Steady – transmit in encrypt mode. Appears in the 6th position of the display. Flashing – receiving an encrypted call
	Steady – Indicates the current channel is set up as a Project 25 (P25) channel.
	Steady – Indicates the current channel is set up as a ProVoice channel. Appears in the 7th position of the display.

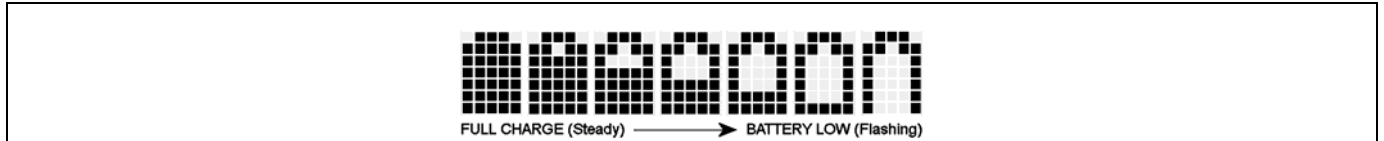

Figure 8-4: Full Cycle Battery Charge Indicator

The battery charge indicators illustrate approximate level only, based on battery voltage. Refer to Figure 8-4.

8.4 TRI-COLOR LED

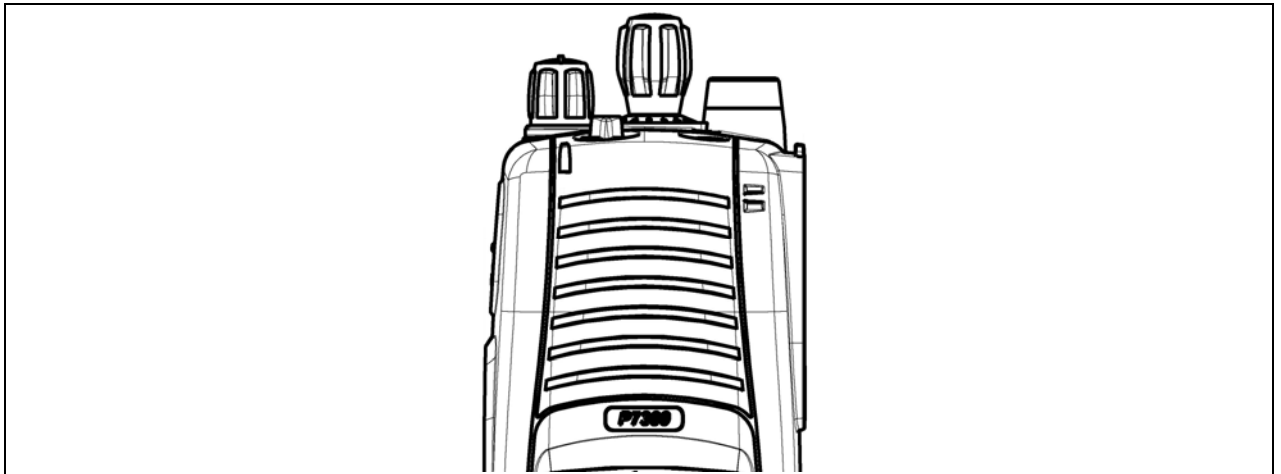

Figure 8-5: Tri-Color LED

The Tri-Color LED changes color to indicate radio status and is visible from both the front and top of the radio (see Figure 8-5). The colors of the LED and the status they represent while operating in EDACS and P25 modes are defined below.

Green:	Receiving
Red:	Unencrypted transmission
Orange:	Encrypted transmission

8.5 STATUS MESSAGES

During radio operation, various radio Status Messages can be displayed. The messages are described below.

<u>MESSAGE</u>	<u>NAME</u>	<u>DESCRIPTION</u>
QUEUED	Call Queued	Indicates the system has placed the call in a request queue.
SYS BUSY	System Busy	Indicates the system is busy, no channels are currently available, the queue is full, or an individual call is being attempted to a radio that is currently transmitting.
DENIED	Call Denied	Indicates the radio or talkgroup is not authorized to operate on the selected system and/or talkgroup.

<u>MESSAGE</u>	<u>NAME</u>	<u>DESCRIPTION</u>
CC SCAN	Control Channel Scan	Indicates the control channel is lost and the radio has entered the Control Channel Scan mode to search for the control channel (usually out of range indication).
WA SCAN	Wide Area Scan	Indicates the radio has entered the Wide Area Scan mode to search for a new system (if enabled through programming).
SYSC ON	System Scan Features On	Indicates the System Scan features are enabled.
SYSC OFF	System Scan Features Off	Indicates the System Scan features are disabled.
LOW BATT	Low Battery	Battery voltage has dropped to the point to where the radio is no longer able to transmit. The radio will still receive calls until the battery is discharged beyond the point of operation at which time the radio automatically shuts down.
RXEMER	Receive Emergency	Indicates an emergency call is being received. This message will be flashing on line two.
TXEMER	Transmit Emergency	Indicates an emergency call has been transmitted on this radio. This message will be flashing on line two.
VOL=31	Volume Level	Indicates the current volume level. The volume level display ranges from OFF (muted) to 40 (loudest).
WHC	Who Has Called	Indicates an individual call has been received, but not responded to. The indicator turns OFF if the individual call mode is entered, the system is changed, or the radio is turned off and then on again.
UNKNOWN	Unknown ID	Indicates an individual call is being received from an unknown ID.

8.6 ERROR MESSAGES

If either of the Error Messages shown below is displayed, the radio is programmed incorrectly or needs servicing.

```
DSP ERR      or  DIG V
ERR=XXXX    ERR
(PowerUp
only)
```

Where `xxxx` is the error code and `DSP ERR` or `DIG V ERR` is the message.

8.7 ALERT TONES

The P7300 radio provides audible Alert Tones or “beeps” to indicate the various operating conditions (see Table 8-4).

Table 8-4: Alert Tones

NAME	STONE	DESCRIPTION
Call Originate	one short mid-pitched	<i>OK to talk after pressing the push-to-talk button</i>
Call Queued	one high-pitched	<i>Call queued for processing</i>
Autokey	one mid-pitched	<i>Queued call received channel assignment</i>
System Busy	three low-pitched	<i>System busy or unable to complete call</i>
Call Denied	one low-pitched	<i>Radio is not authorized on the system or group</i>
Carrier Control Timer	five high-pitched/one long low-pitched	<i>PTT depressed for maximum length of time</i>
Low Battery	one low-pitched/one short mid-pitched	<i>Low battery</i>
TX Low Battery Alert	one low-pitched	<i>After PTT - battery too low to transmit</i>

8.8 TURNING ON THE RADIO

1. Power ON the radio by rotating the POWER ON-OFF/VOLUME knob clockwise. A short alert signal (if enabled through programming) indicates the radio is ready to use.
2. The display shows the last selected system and group or a default system and group (depending on programming).
3. Adjust the POWER ON-OFF/VOLUME knob to the desired volume level.
4. Select the desired system and group. The display indicates the current system and group names.
5. The radio is now ready to transmit and receive calls.



NOTE

In the trunked environment, CC SCAN will be displayed if communication with the system's control channel cannot be established. This may occur if, for example, the radio is out of range of the trunking site. It may be necessary to move to another location or select another trunking system to re-establish the control channel link for trunked mode operations. CC SCAN is displayed on the group line until a control channel is accessed.

8.9 SYSTEM SELECTION

- METHOD 1:** From the control knob: If system selection is programmed to the Voice Group Selection control knob, select a system by turning the knob to the desired system number position (1-16). The display registers the new system name on line one. The **[SYS]** button can be programmed to provide access to a “2nd bank” of 16 system number positions (17-32).
- METHOD 2:** From the keypad: If system selection is programmed as the primary function of **[▼]** and **[▲]** select a system by pressing **[▼]** or **[▲]** to scroll through the system list. The display registers the new system name on line one.
- METHOD 3:** **(P7370 model radios only)** Direct Access: Press **[SYS]** to enter the system select mode. Press the numeric key, which is mapped to the desired system. Press **[M]**. The radio will move to the selected system.



NOTE

If system selection is programmed to the Voice Group Selection control knob, direct access to systems will not be available. Pressing **[▼]** or **[▲]** will scroll through different sets of 16 systems each (banks) if more than 16 systems are programmed into the radio. The systems within each bank are then selectable via the Voice Group Selection control knob as described previously in METHOD 1.

Example:

System: 1 = North	Group: 1 = Group 1
2 = South	2 = Group 2
3 = East	3 = Group 3
4 = West	4 = Group 4

1. Press **[SYS]**. (South is the currently selected system.)
2. Press **[4]**. (Press 4 to select “West” system.)
3. Press **[M]**. (West is the newly selected system.)

8.10 GROUP/CHANNEL SELECTION

Several methods can be used to select a new group or channel.

- METHOD 1:** From the Control knob: If group selection is programmed to the Voice Group Selection control knob, select a group by turning the Voice Group Selection control knob to the desired group number position. The display registers the new group name on line two. If the knob is moved to a position greater than the number of programmed groups, the highest programmed group will remain selected. The **[O]** button can be programmed to provide access to a “2nd bank” of 16 group number positions (17-32).
- METHOD 2:** From keypad: If group selection is programmed as the primary function of **[▼]** and **[▲]** select a group by pressing **[▼]** or **[▲]** to scroll through the group list. The display registers the new group name on line two.
- METHOD 3:** **(P7370 model radios only)** Direct Access: Press **[2ND]** to enter the group select mode. Press the numeric key mapped to the desired group. Press **[M]**. The radio will move to the selected group.

8.11 MODIFY SCAN LIST

8.11.1 P7370 Model

1. Press **[3 SCN OFF]** to toggle scan OFF and verify  is **not** displayed.
2. Select group or channel.
3. Press **[9 DEL]** once to remove group or channel from list.
4. Press **[6 ADD]** once to add as a normal group or channel.
5. Press **[6 ADD]** twice to add as a Priority 2 group.
6. Press **[6 ADD]** three times to add as a Priority 1 group.
7. Press **[3 SCN OFF]** to re-start scanning.

8.11.2 P7350 Model

1. Press **[SCN]** to toggle scan OFF and verify  is **not** displayed.
2. Select group or channel.
3. Press **[A/D]** once to remove group or channel from the list.
4. Press **[A/D]** once to add as a normal group or channel.
5. Press **[A/D]** twice to add as a Priority 2 group.
6. Press **[A/D]** three times to add as a Priority 1 group.
7. Press **[SCN]** to re-start scanning.

8.12 MENU

The Menu function accesses features that are not available directly from the keypad. The order and actual menu items available is configurable through programming. Upon radio power up, the menu item that is at the top of the menu list will always be displayed first. Subsequent access to the menu function will return the last menu item that was shown in the display and cursor position.

1. To enter the menu mode, then press **[M]**.
2. Upon entering the menu selection mode, Menu options will appear in the display (see Figure 8-6).

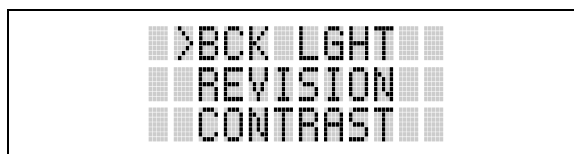

Figure 8-6: Menu Display

3. The radio will continue to receive and transmit normally while in the menu function.
4. To scroll through the menu options use the **[▼]** or **[▲]** keys. When the required menu item has been found align the cursor with the option then press **[M]** to select it. The menu item's parameter setting shown in the display can now be changed by using **[▼]** or **[▲]** to scroll through the list of parameter values.

- Once the desired setting is reached press **M** to store the value and return the menu option selection level.

For menu items that display radio information, pressing **▼** or **▲** will scroll through a list of informational displays. Possible menu items are listed in Table 8-5.

8.12.1 Menu Item Selection Process

An example of the backlight menu item selection process and menu item parameter change is shown in Figure 8-7.

- Press **M**. The menu mode is entered.
- Press **▼** or **▲** until the display shows:

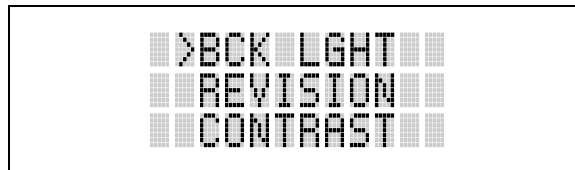

Figure 8-7: Backlight Menu Item Selection Parameter

- Press **M**. The backlight menu item is activated. Line one shows the active menu item and its current parameter setting. Line two shows the currently selected system or group name (see Figure 8-8).

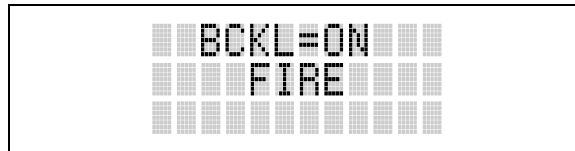

Figure 8-8: Backlight Menu Display

- The menu item's parameter setting shown in the display can now be changed by using **▼** or **▲**.
- Once the desired setting is reached press **M** to store the value and return the menu option selection level.

For menu items that display radio information pressing **▼** or **▲** will scroll through a list of informational displays. An example of information displays is shown in Table 8-5.



The TX POWER menu item, when selected, toggles LOW/HIGH power. It does not use **▼** or **▲** to scroll nor is an additional press of the **M** button required.

Table 8-5: Menu Item Information

FEATURE	DISPLAY	PARAMETER SETTING	COMMENT
Keypad Lock	Menu Item: KEY LOCK Once Selected: LOCKED	Locked Unlocked	Locks the keypad. To unlock; press and release [M] then within 1 second press the option button <i>NOTE:</i> This sequence is also a short cut to locking the keypad.
Backlight Adjust	Menu Item: BCK LIGHT Once Selected: BCKL=	OFF/ON	Selects the light level for backlighting.
Contrast Adjust	Menu Item: CONTRAST Once Selected: CNTRST=	1, 2, 3, 4	Selects the display contrast level.
Transmit Power Select	Menu Item: TX POWER Once Selected: POWER=	HIGH or LOW	Selects radio output power mode.
Radio Revision Information	Menu Item: REVISION	N/A	Selects the information display to view. Informational display only (see Table 8-6). <i>No user selectable settings.</i>
Toggle Scan On/Off	SCAN	ON/OFF	Toggles Scan operation ON/OFF.
Toggle Private Mode	PRIVATE	ON/OFF	Toggles Private Mode ON/OFF.
Display Current Encryption Key	DISP KEY	N/A	Displays current encryption key. Informational display only. <i>No selectable settings.</i>
Display Current Home Group/Channel	HOME	N/A	Selects Home Group/Channel
Select Desired System	SYS SEL	N/A	Selects a new system.
Add Group/Channel to Scan List	SCAN ADD	N/A	Adds to Scan List.
Delete Group/Channel	SCAN DEL	N/A	Deletes Group or Channel from Scan List.
Add/Delete Scan List	SCAN A/D	N/A	Add or Delete from Scan List.
Select Telephone Numbers From Phone List	PHN CALL	N/A	Trunked Only.
Data Operation	NO DATA	ON/OFF	Trunked Only. Toggles Data Operation ON/OFF.
Select Individual Call from IC List	IND CALL	N/A	Trunked Only.
Select Group	GRP SEL	N/A	Trunked Only.
Feature Encryption Display	Menu Item: FEATURES	N/A	Indicates current features programmed into the radio as well as certain information required to add features to the radio. <i>Informational display only. No user selectable settings.</i>
System Scan Enable	Menu Item: SYS SCAN Once Selected: SYSC ON or SYSC OFF	ON/OFF	Toggles System Scan feature ON/OFF.

Table 8-6: Information Display

RADIO ID XXXXXXXX	LID in EDACS/EA In CONV it has no meaning.
RAM SIZ	RAM Size
FLSH SIZ	Flash Size
RF BAND	Frequency Band
PERS VER	Software Version
DSP DATE	Date DSP code was built.
DSP TIME	Time DSP code was built.
DSP FEAT	The DSP Features supported by the DSP code, in Hexadecimal. Bit mapped (see IPC spec for details): <ul style="list-style-type: none"> • 0x0001 – Conventional • 0x0002 – EDACS • 0x0010 – AMPF • 0x0020 – undefined
DSP VER	DSP Software Version
FLSH VER	FLASH Software ex: P73U0102 P=portable, 54=5400 radio, U=unencrypted, 01=major revision (>50 means unreleased code), 02=minor revision
M/A-COM (C) 2007	Copyright
PERSNLTY	Personality Name
BLD DATE	Date host (ARM) code was built.
BLD TIME	Time host (ARM) code was built.





8.13 BACKLIGHT ON/OFF

1. Press **[M]** to access the menu.
2. Press **[v]** or **[^]** to scroll through menu until “BCKLGHT” appears.
3. Press **[M]** to select Backlight menu.
4. Press **[v]** or **[^]** to toggle backlight ON and OFF.
5. Press **[M]** to select new backlight setting.



8.14 CONTRAST ADJUST

1. Press **[M]** to access the menu.
2. Press **[v]** or **[^]** to scroll through menu until “CONTRAST” appears.
3. Press **[M]** to select Contrast menu.
4. Press **[v]** or **[^]** to adjust contrast setting from 1 - 4.
5. Press **[M]** to select new contrast setting.

8.15 DECLARING AN EMERGENCY

1. Press and hold the red Emergency/Home button (the length of time is programmable; check with the system administrator).
2. ***TXEMER*** will flash in the display, plus  and  will be displayed. After 2-3 seconds the transmit icon  will turn off.
3. ***TXEMER*** and  will remain until the emergency is cleared. See Section 8.21 for additional emergency operation.
4. Press the PTT and  will reappear.
5. Release PTT when the transmission is complete.

8.16 LOCKING/UNLOCKING KEYPAD





1. Press  button.
2. Within 1 second, press the  button on the side of the radio.

8.17 HIGH/LOW POWER ADJUSTMENT

Transmit power adjustment is possible if enabled through programming. Within conventional systems, transmit power is adjustable on a per channel basis. Within EDACS trunking systems, transmit power is adjustable on a per system basis.

There are two ways to toggle between high and low power, described in Sections 8.17.1 and 8.17.2.

8.17.1 Using the Menu Button

1. Press .
2. Using the  or  keys, scroll until the cursor (>) appears to the left of “TX POWER” in the display.
3. Press  again to toggle between High and Low power.
4. “POWER = HIGH” or “POWER = LOW” will appear momentarily on the top line of the display.

8.17.2 Using the Pre-Programmed Option Button

Press the Option button. “POWER = HIGH” or “POWER = LOW” will appear momentarily on the top line of the display.

8.18 DIGITAL VOICE OPERATION

Digital voice programmed systems have three (3) different voice modes: clear (analog), digital, and private (encrypted). The voice modes are programmed on a per-group basis within each trunked system and on a per-channel basis within each conventional system.

8.18.1 Clear Mode

The Clear Mode is a voice mode in which the radio transmits and receives only clear (analog) voice signals. These analog signals are non-digitized and non-encrypted. Clear mode transmissions can be monitored easily by unauthorized persons.



Groups or channels programmed for clear operation cannot transmit or receive digital or private messages.

8.18.2 Digital Mode

The Digital Mode allows the radio to transmit and receive digitized voice signals. Digital signals provide improved weak signal performance and cannot be easily monitored with a standard receiver. Groups or channels programmed for digital operation transmit only digital signals. Message trunked group calls and individual phone calls (I-Calls) are answered back in the mode in which they were received assuming the call or hang time is still active. Individual phone, all call, and emergency calls are transmitted clear if the digital mode is disabled or inoperative.



1. If receiving an analog message trunked call, the radio responds in the analog mode during the hang time on the working channel.
2. If receiving an analog I-Call, the radio responds in the analog mode during the hang time.
3. When using the ***WHC*** feature to respond to an I-Call (after the hang time has expired), the call is transmitted in the mode defined by the system mode as programmed for the current system if the ID being called is not in the I-Call list. If the ID is in the I-Call list, then the call is transmitted as defined by the I-Call mode programmed in the list for that ID.

The over dial DTMF tones are not available while in the Digital Mode.

8.18.3 Private Mode

The Private Mode allows the radio to transmit encrypted messages and receive clear or private transmissions. The radio transmits private if the group/channel is programmed for private operation and forced operation is pre-programmed. If auto-select operation is pre-programmed and the radio is in the Private Mode, the radio transmits in the mode of the received call if the hang time is active. If no hang time is active, the radio transmits private.

Cryptographic keys are transferred to the radio using a cryptographic Keyloader. Up to seven (7) different cryptographic keys, numbered 1-7, can be transferred from a Keyloader and stored in the radio. An individual key is automatically selected on a per-group/channel basis according to the radio programming. Groups and channels within the digital system can be programmed for keys 1-7 (private). Up to 8 banks of 7 keys can be stored for private systems. The bank is specified per system.

When operating on a group or channel programmed for Private Mode, all transmissions are private transmissions and the radio receives clear and private signals. The status icon  is displayed when the Private Mode is enabled. If the selected group or channel is programmed for auto-select capability, the mode may be toggled between private and clear with the  key, then following the selection mode rules. Radios programmed for forced private operation do not allow a change of the transmit mode.

8.18.3.1 Displaying the Currently Used Cryptographic Key Number

To Display the Currently Used Cryptographic Key Number for either the system encryption key (for special call such as individual, phone, all, agency or fleet) or the group/channel key (for group or conventional calls), perform the following procedure:

1. Press the **[M]** button.
2. Use the **[▲]** or **[▼]** button to select "DISP KEY."
3. Use the **[▲]** or **[▼]** button to toggle between displaying the system key (Figure 8-9) or the group/channel key (Figure 8-10).

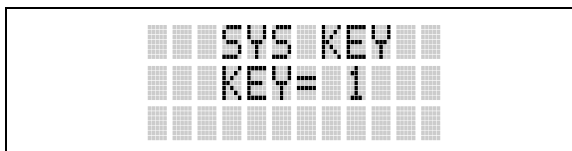

Figure 8-9: System Encryption Key Display

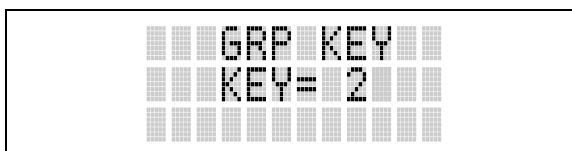

Figure 8-10: Group/Channel Encryption Key Display

8.18.3.2 Key Zero

All cryptographic keys can be zeroed (erased from radio memory) by pressing the **[Ⓞ]** button and while still pressing this button, press and hold the **OPTION** button. Press both buttons for 2 seconds. A series of beeps will begin at the start of the 2 second period and then switch to a solid tone after the keys have been zeroed. The display will indicate **KEY ZERO**.

If the cryptographic key(s) are zeroed, one or more keys must be transferred from the Keyloader into the radio before private communications may continue.

8.18.4 Private Operation

8.18.4.1 Receiving an Encrypted Call

When receiving, the radio automatically switches between clear or private operation. If the transmission being received is an encrypted transmission, it will be decrypted, the **[🔒]** icon will be displayed, the receiver will unsquelch, and the message will be heard in the speaker. For this to occur, the selected group or channel must be programmed for private operation and the correct cryptographic key must be loaded into the radio.

8.18.4.2 Transmitting an Encrypted Call

1. Select the desired group or channel.
2. Place the radio in Private Mode by pressing **[M]** key; then follow the selection mode rules. On a System radio, the **[4^{OFF}]** key can be used to toggle the Private Mode ON/OFF. When Private Mode is enabled, the **[🔒]** icon is displayed.

3. If the last state of the radio was Private Mode, the Private Mode will be enabled on power up. Also, the Private Mode will be enabled if forced operation has been programmed in the radio.

If a group or channel is not programmed for Private Mode operation, **PVT DIS** will be displayed if an attempt is made to enable private transmit mode. It is not possible to operate on this group/channel in Private Mode.

If the radio does not have the correct encryption key loaded, **NO KEY#** will be displayed and the call will not be transmitted.

4. Continue with standard transmission procedures. A Private Mode access tone will be heard when the PTT button is pressed.

8.18.4.3 Scanned Group Calls

Receiving a Scanned Group Call is the same as receiving a selected group call. During the scan hang time, if the radio was programmed for auto-select, it will transmit back in the same mode it received the call. For example, if a clear group is entered in the scan list, it will only receive clear calls. If the same group was available in private and entered in the scan list, it can receive clear and private calls, provided auto-select was programmed in the radio. The user can select transmitting on the scanned or selected group. If a group is entered in the scan list more than once and under different modes, (clear, digital, or private), then only the first occurrence of the group will be used.

Table 8-7: Transmit/Receive Mode Compatibility for Digital Voice Operation

GROUP/CHANNEL PROGRAMMING (TRANSMIT)	CLEAR RECEIVE	DIGITAL RECEIVE	PRIVATE RECEIVE
CLEAR	Yes	No	No
DIGITAL	Yes	Yes	No
PRIVATE	Yes	No	Yes*

*assumes the proper cryptographic key is loaded



NOTE

Conventional digital or encrypted channels require Channel Guard on the channel to operate correctly.





NOTE

The voice coding technology embodied in this product is protected by intellectual property rights including patent rights, copyrights, and trade secrets of Digital Voice Systems, Inc. The user of this technology is explicitly prohibited from attempting to de-compile, reverse engineer, or to disassemble the Object Code, or in any other way convert the Object Code into a human-readable form.

8.19 SCANNING TRUNKED GROUPS







Groups that have been previously added to the scan list on a per system basis may be scanned. Each system's group scan list is retained in memory when the radio is powered OFF or when the battery pack is removed.

8.19.1 Turning Scan On and Off

1. Toggle Scan operation ON by pressing **[SCN]** (P7350 model) or **[3 SEP]** (P7370 model).  icon rotates clockwise to indicate radio is scanning.
2. Toggle Scan operation OFF by again pressing **[SCN]** (P7350 model) or **[3 SEP]** (P7370 model).  will disappear.
 - If the radio scans to a group other than the selected group then receives a call on the selected group, the radio will switch to the selected group. However, if the “scanned-to” group is programmed at a higher priority the radio will remain on the “scanned-to” group.
 - The radio will continue scanning if a new group is selected when scan is ON.
3. Pressing the PTT button when scan is ON will cause the radio to transmit on the displayed group or to the currently selected group (depending on programming).

8.19.2 Adding Groups to a Scan List

P7350 Model Radio

1. Scan must be OFF to add/delete groups to/from the scan list. If the Scan icon  is ON, press the **[SCN]** key to turn Scan OFF.
2. Select the desired group using the Voice Group Selection control knob and/or the **[▼]** or **[▲]** keys. If the selected group is currently on the list, pressing **[ADD]** will display  on line three.
3. If the scan list status icon is blank () , the group can be added to the scan list by pressing the **[ADD]** key.  will be displayed on line three.
4. Press the **[ADD]** key a second time to set the group to Priority 2. A  is displayed on line three.
5. Press **[ADD]** a third time to set the group to Priority 1. A  is displayed on line three. The priority level section sequence only advances the group to the next high priority level and stops at priority level 1. To select a lower priority level, the group must be deleted from the scan list and then added back to the scan list. Each new group added to the scan list starts at the lowest priority. If the Priority 1 and Priority 2 groups are already set and a new group is assigned as Priority 1 or Priority 2, the previously assigned group will change to non-priority scanning. One of the following messages may be momentarily displayed.

SCAN DIS The radio is not programmed to scan.

FIXED P1 A Priority 1 group has been pre-programmed into the radio. A new Priority 1 group cannot be selected.

FIXD LST A fixed scan list has been pre-programmed into the radio. It is not possible to change the list without reprogramming the radio.



NOTE

To quickly view multiple group scan status, press **[ADD]** then slowly but consistently rotate the group knob. Each group status will appear on the display.

P7370 Model Radio

1. With scan operation turned OFF, select the desired group to add to the selected trunked system group scan list.
2. Press **[6 ADD]**. The current priority status of the group will be displayed in column 10 of line three for a time-out period. If the group is not part of the scan list the status will be blank.
3. While the status is displayed, press **[6 ADD]** to add the group to the scan list. **[111]** is displayed on line three.
4. Press **[6 ADD]** a second time to set the group to Priority 2. A **[11]** is displayed on line three.
5. Press **[6 ADD]** a third time to set the group to Priority 1. A **[1]** is displayed on line three. The priority level selection sequence only advances the group to next higher priority level and stops at priority level 1. To select a lower priority level, the group must be deleted from the scan list and then added back to the scan list. Each new group added to the scan list starts at the lowest priority. If the Priority 1 and Priority 2 groups are already set and a new group is assigned as Priority 1 or Priority 2, the previously assigned group will change to non-priority scanning. One of the following messages may be momentarily displayed.

SCAN DIS The radio is not programmed to scan.

FIXED P1 A Priority 1 group has been pre-programmed into the radio. A new Priority 1 group cannot be selected.

FIXD LST A fixed scan list has been pre-programmed into the radio. It is not possible to change the list without reprogramming the radio.



NOTE

To quickly view multiple group scan status, press either **[6 ADD]** or the **[9 DEL]** key. Then slowly but consistently rotate the group knob. Each group status will appear on the display.

8.19.3 Deleting Groups from a Scan List

P7350 Model Radio

1. With scan operation turned OFF, select the desired group to delete from the selected trunked system group scan list.
2. Press **[A/D]**. The current status of the group is displayed for a time-out period.
3. While the current status is displayed, press **[A/D]** until the group from the scan list is **"blank"**. The sequence is **"blank"**, **[111]**, **[11]**, **[1]**, **"blank"**. Any group that is not in a trunked system group scan list will show a **"blank"** for the time-out period when it is the selected channel.

P7370 Model Radio

1. With scan operation turned OFF, select the desired group to delete from the selected trunked system's group scan list.
2. Press **[9 DEL]**. The current status of the group is displayed for a time-out period.
3. While the status is displayed, press **[9 DEL]** to delete the group from the scan list. **[111]**, **[11]**, or **[1]** turns OFF. Any group that is not in a trunked system group scan list will show a **"blank"** for the time out period when it is the selected channel.

8.19.4 Nuisance Delete

A group can also be deleted from the scan list, if it is not the currently selected group, by pressing the **[A/D]** key (P7350 model) or the **[9MHz]** key (P7370 model) during scan operation while the radio is displaying the unwanted group. The group will be deleted from the system's group scan list in the same manner as if done using the steps above. Deletions done in this manner will not remain deleted if the radio is powered OFF and then powered ON.

8.20 SCANNING TRUNKED SYSTEMS

The radio can be programmed using Radio Personality Manager (RPM) with the following System Scan features. Then these features are automatically enabled when the radio is powered ON. A key or menu option is also defined to allow the System Scan features to be toggled during radio operation. The System Scan state will be maintained through system changes but will default to ON when the radio is powered ON.

Enable/Disable via Menu Selection

Press **[M]** and then use the **[▼]** or **[▲]** buttons to scroll through the selections until **SYS SCAN** is displayed. Then press **[M]** to toggle the System Scan state. The **SYSC ON** or **SYSC OFF** display message is displayed for two seconds to show the new state.

Enable/Disable via Pre-Programmed Keypad Key

Press the key pre-programmed to toggle System Scan and the **SYSC ON** or **SYSC OFF** display message is displayed for two seconds to show the new state.

8.20.1 Wide Area System Scanning

The P7300 series radio can be pre-programmed through RPM for Wide Area System Scan operation for roaming across mobile systems. EDACS radio systems manage the radios assigned to the system via a control channel (CC). Upon the loss of the currently selected system's control channel, radios can be programmed to automatically scan the control channels of other systems. If a new control channel is found, the radio will switch to the new system and sound an alert tone.

8.20.2 Priority System Scan

The radio can also be pre-programmed for Priority System Scan. The priority system is the desired or preferred system. While receiving the control channel of the selected system, the radio will periodically leave the selected system and search for the control channel of the priority system. This is done at a pre-programmed rate defined by the value in the Priority Scan Time control, unless the ProScan™ algorithm is enabled, as explained in the following sections. This priority scan timer is reset each time the PTT button is pressed or when the call is received. If the priority system control channel is found, or meets the predefined criteria (ProScan), the radio will automatically switch to the priority system.

8.20.2.1 Enabling the Wide Area System Scan Function

If the radio cannot find the control channel of the selected system and begins to wide area system scan, the radio will only scan for the priority system control channel if the priority system is in the wide area scan list.

8.20.2.2 When ProScan is Enabled

The radio monitors the priority system and will switch to the priority system if the pre-programmed criteria ProScan options are met. If ProScan is enabled, the rate at which the radio will scan for the priority system is defined by the System Sample Time control, set in RPM, (refer to RPM On-Line Help). See Section 8.20.3 for more information on ProScan.

8.20.3 ProScan

The radio may be programmed for ProScan system scan operation for multi-site applications. ProScan is a multi-site system scanning algorithm. ProScan provides the radio with the ability to select a new system for the radio to communicate on, when the selected system drops below a predefined level. This algorithm enables each radio to analyze the signal quality of its current control channel and compare it with the signal quality of the control channel for each site in its adjacent scan list. The signal quality metric used for the ProScan algorithm is based on a combination of both **Received Signal Strength Indicator (RSSI)** and **Control Channel Verification (CCV)** measurements. When the selected system degrades to a pre-programmed level, the radio will begin to look for a better control channel. Once a control channel that exceeds the pre-programmed parameters is found, the radio will change to the new system and emit a tone (if enabled through programming). If the control channel is completely lost, the radio will enter Wide Area System scanning and search the programmed adjacent systems until a suitable control channel is found.

8.21 EMERGENCY OPERATION



The radio's ability to declare an emergency, clear an emergency, remain locked on an emergency system and group, and the emergency audio and display freeze can each be enabled or disabled through programming. When an emergency is declared scanning will stop and restarts only after the emergency has been cleared.



8.21.1 Receiving an Emergency Call

When receiving an Emergency Call on the selected group and system, an alert beep is heard and  is displayed. The message ***RXEMER*** flashes in the display on line two until the emergency condition is cleared.

8.21.2 Declaring an Emergency Call

Perform the following steps to send an emergency call to a selected system and group (or on an optionally pre-programmed group).

1. Press and hold the red EMERGENCY button that is on top of the radio in front of the antenna for approximately one second (this time is programmable and therefore could be longer or shorter; check with the system administrator). The radio will transmit an emergency call request with the radio ID until an emergency channel assignment is received.
2. When the working channel assignment is received, the radio sounds a single beep indicating the radio has auto keyed (see Table 8-4) and is ready for voice transmission. ***TXEMER*** flashes on line two in the display until the emergency is cleared.
3. Press PTT and speak into the microphone in a normal voice.  and  momentarily turn ON.
4. Release PTT when the transmission is complete.

To clear the emergency first press and hold the  button. While continuing to hold the  button, press the EMERGENCY button. (This will work if the radio is programmed to clear emergencies.)

8.22 INDIVIDUAL CALLS

8.22.1 Receiving and Responding to an Individual Call

When the radio receives an individual call (a call directed only to the user's radio), it un-mutes on the assigned working channel and displays **II**. The first line on the display shows the logical ID number of the unit sending the message, or the associated name if the ID number is found in the individual call list. The radio can be programmed to ring when an individual call is received. If enabled, the ring begins five seconds after the caller un-keys and will continue until the PTT button, the **Ⓢ** button or the individual call mode is entered.



The volume of the ring is adjustable through the volume control levels.

If a response is made by pressing the PTT to the call prior to the programmed call-back time-out, the call will automatically be directed to the originating unit. If a response is not made before the call-back time-out, the radio will return to normal receive display, and ***WHC*** will appear on the first line of the LCD.

To respond after the call-back time-out, press the **#NO** key. The radio's display will show the callers ID on the first line and **WHCI=1** on the second line. Pressing the PTT button at this point will initiate an individual call back to the original caller.

The radio stores the IDs of the last 10 callers in the Calls Received List as shown. Individual calls are stored in the top half of the list (1-10) and Group calls are stored in the bottom half of the list (1-10). The most recent call is stored in position 1, the second most recent call is stored in position 2, etc.

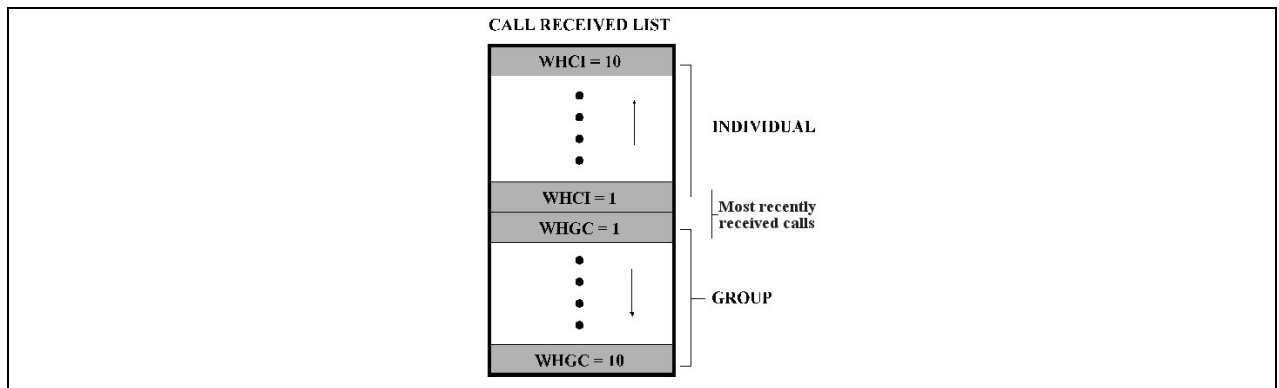

Figure 8-11: Calls Received Lists

To access the Calls Received List, press the **#NO** key twice. Use the **▼** or **▲** buttons to scroll through the list. Pressing the **M** key will display the time elapsed since the call was received. After pressing **#NO** the display will appear similar to Figure 8-12.

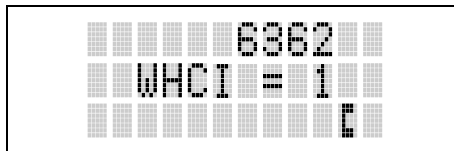

Figure 8-12: WHC Individual Call Display

Pressing the PTT will initiate an individual call to the displayed logical ID. Powering the radio OFF and ON will clear this list.

8.22.2 Sending an Individual Call

8.22.2.1 Pre-Stored Individual Calls

The following procedures describe how to initiate and complete a Pre-Stored Individual Call.

P7370 Model Radio

1. To select a pre-stored individual phone number, enter the individual call mode using the **#ND** key. **I** is displayed. Then scroll through the list of stored numbers using the **▼** or **▲** keys.
2. Press the PTT button; when the radio is clear to transmit, **I** turns ON, **I** turns OFF and the channel access tone sounds. Line one shows the called individual's name if found in the list of stored individuals or **LID** followed by the logical ID number of the unit being called. The message ***INDU*** displays on line two.

P7350 Model Radio

1. To select a pre-stored individual number, enter the menu mode by pressing the **M** key. Scroll through the mode list using the **▼** or **▲** buttons.
2. Press **M**. **I** is displayed. Scroll through the list of stored phone numbers using the **▼** or **▲** buttons until the desired number is displayed. Press **M**.
3. Press the PTT button; when the radio is clear to transmit **I** turns ON, **I** turns OFF and the channel access tone sounds. Line one shows the called individual's name or LID. The message ***INDU*** displays on line two.

8.22.2.2 Direct Dial Individual Calls (P7370 Model Only)

1. The following procedure describes how to initiate and complete a Direct Dial Individual Call.
2. The individual call ID is not stored in the pre-stored list of call IDs but the individual unit ID is known, it can be entered directly from the keypad.
3. Press and hold the PTT button to transmit. **I** will turn ON, **I** will turn OFF, and the channel access tone will sound. Line one shows the called individual's ID followed by the logical ID number of the unit being called. The message ***INDU*** displays on line two. Proceed talking into the microphone.

8.22.3 Call Storage Lists

There are two lists available for call storage in the P7300 series radios, the **calls received** list (1 - 10) and the **personality** list (1 - 99 as defined by the user). When the individual call mode is entered by pressing **#ND**, the **calls received** list is available. The user can toggle to the personality list by selecting any index other than 0 or toggle between the two lists by pressing the **#ND** key. If wrap is enabled, the **calls received** list wraps on itself and not into the other list.

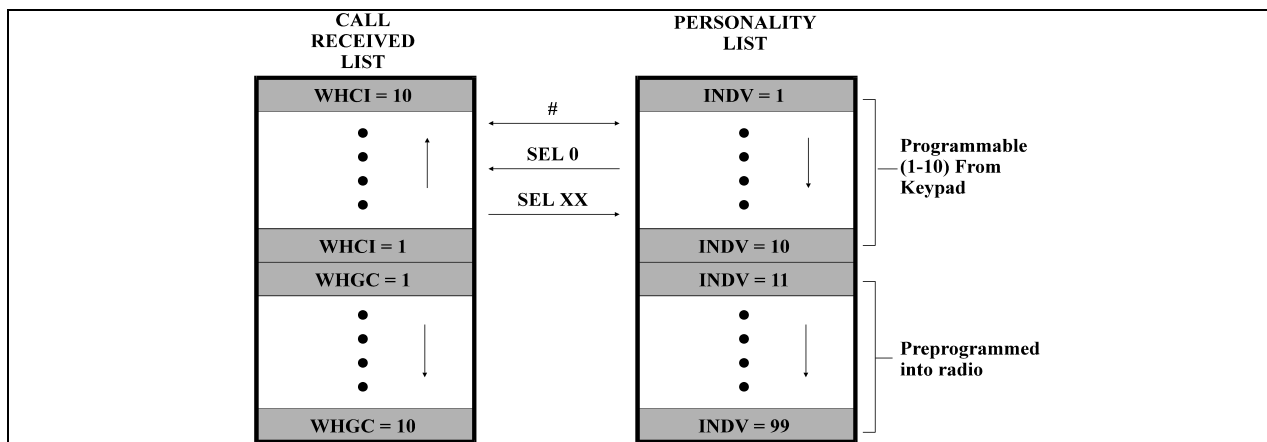

Figure 8-13: Calls Received and Personality Lists

The saved call list shows all ten storage locations. If no calls have been received, the saved call list will be empty and the pre-stored list will be available upon entering the individual call mode.

When in the saved call list, pressing the **[M]** key toggles the time stamp ON and OFF. The time stamp indicates how long ago the call was received. When in the pre-stored list pressing the **[M]** key toggles the *Logical IDentification (LID)* ON and OFF.

8.23 TELEPHONE INTERCONNECT CALLS

8.23.1 Receiving a Telephone Interconnect Call

When the radio receives a telephone interconnect call (a call directed only to the user's radio), it un-mutes on the assigned working channel and displays **[PTT]**. The first line displays ***PHONE***. The second line displays ***INDV***. Proceed with the call. Press the PTT to talk, release the PTT to listen.

8.23.2 Sending a Telephone Interconnect Call

8.23.2.1 Pre-Stored Number

Use the following procedures to initiate and complete a Telephone Interconnect call.

1. **P7370 Model:** To select a previously stored phone number, press the **[*PHN]** key. Use the **[v]** or **[^]** buttons to scroll through the list of stored numbers.

P7350 Model: To select a previously stored phone number, press the **[M]** key. Use the **[v]** or **[^]** buttons to select the menu option **PHN CALL**. Press the **[M]** key again then use the **[v]** or **[^]** buttons to scroll through the list of pre-stored numbers.

2. Press and release the PTT button. When the radio is clear to transmit, **[PTT]** turns ON, **[M]** turns OFF and the channel access tone sounds. Line one shows the accompanying name selected from the list of stored numbers. The message ***PHONE*** appears on line two of the display. The radio then automatically transmits the programmed number stored in the special call queue.
3. A telephone ring will be heard from the speaker. When someone answers the phone, press the PTT button and speak into the microphone. Release the PTT button to listen to the callee. Unsuccessful interconnect signaling returns the radio to the normal receive mode and the number remains displayed until the special call is cleared or the time-out expires or another group or system is selected. Terminate a call by pressing the **[C]** button.



In half-duplex mode, only one person may talk at a time. The radio PTT button needs to be pressed in order to communicate to the individual called and released for the individual called to be heard.

8.23.2.2 Direct Dialing of Phone Calls (P7370 Model Only)

1. If the phone number is not stored in the pre-stored list of phone numbers, but the phone number is known, it can be entered directly from the keypad. Start by pressing the key, then enter the required number from the keypad. Press and release the PTT button.



The last number directly entered can be recalled by first pressing then pressing the PTT button.

2. A telephone ring can be heard from the speaker. When someone answers the phone, press and hold the PTT button and speak into the microphone. Release the PTT button to listen to the individual called. Unsuccessful interconnect signaling returns the radio to the normal receive mode and the number remains displayed until the special call is cleared or the time-out expires or another group or system is selected.
3. To terminate the call, momentarily press the button.

8.23.3 Dual-Tone Multi-Frequency: Overdial/Conventional Mode

Once the radio has established a connection to the public telephone system, it may be necessary to “overdial” more digits to access banking services, answering machines, credit card calls, or other types of systems that require Dual-Tone Multi-Frequency (DTMF) access digits.

Overdial operation can also be used to initiate a telephone interconnect call via DTMF signaling if a dial tone has already been accessed on the system. This method makes a telephone interconnect call while operating in the conventional mode but will also function in trunked mode if a dial tone is directly accessible.

Telephone numbers and other number sequences for overdialing can be stored in the phone list when programming the radio. These numbers are accessed by pressing the key, then following the selection mode rules. Perform the following procedures to access and dial these stored numbers.

P7350 Model Radio





1. Follow the procedure in Section 8.23.2 to establish a connection to the telephone system or consult the system administrator for the procedure to access a dial tone on the trunked or conventional system.
2. Enter selection mode first to enable entry of Overdial numbers by pressing the button.
3. Follow the selection mode rules to call up a stored number from the phone list: Use the or buttons to scroll through the list of stored numbers. is displayed. Press the PTT to send the overdial sequence once. If the number needs to be transmitted again it must be selected or entered again (this prevents unwanted numbers from being sent the next time the PTT button is pressed during the call).



Overdial select/entry mode remains active until the call is dropped, cleared, or is pressed. The overdial select/entry mode can be re-entered if the call is still active by pressing .

P7370 Model Radio

1. Follow the procedure in Section 8.23.2 to establish a connection to the telephone system or consult the system administrator for the procedure to access a dial tone on the trunked or conventional system.



2. Overdial numbers are transmitted using one of the following methods:



- METHOD 1:
1. Enter the overdial selection mode by pressing the  button.
 2. Use the  or  buttons to scroll through the list of stored numbers.  is displayed. Press the PTT to send the overdial sequence once. If the number needs to be transmitted again it must be selected or entered again (this prevents unwanted numbers from being sent the next time the PTT button is pressed during the call).

Overdial select/entry mode remains active until the call is dropped, cleared, or  is pressed. The overdial select/entry mode can be re-entered if the call is still active by pressing .

- METHOD 2: **(P7370 model radios only)**

1. Enter the overdial selection mode by pressing the  button.
2. Press and hold the PTT button while entering the overdial number sequence from the keypad. This method sends DTMF tones during individual, telephone interconnect, trunked group, or conventional channel calls. Press the PTT to send the overdial sequence once. If the number needs to be transmitted again it must be selected or entered again (this prevents unwanted numbers from being sent the next time the PTT button is pressed during the call). *Note: Anytime the PTT button is pressed and held, the keypad is enabled for DTMF entry.*

Overdial select/entry mode remains active until the call is dropped, cleared, or  is pressed. The overdial select/entry mode can be re-entered if the call is still active by pressing .





This overdial select/entry mode remains active until dropped, cleared, or  is pressed. The overdial select/entry mode can be re-entered if the call is still active by pressing the  button.

8.24 PROGRAMMABLE ENTRIES

8.24.1 Pre-Storing Individual and Telephone Interconnect Calls from the Keypad

Individual Call ID numbers, telephone numbers, and other number sequences for overdialing are stored in the special calls lists when programming the radio. The first ten entry locations of these lists can be changed by the radio operator. The keypad is used when adding, changing, and storing numbers in these entry locations.

Use the following procedure to store a number in one of the first ten entries of a special call list:

1. Press the  or  button to enter the individual call list or the phone call list.  is displayed.
2. Scroll through the list using the  or  keys until one of the first ten entries is reached. **NO ENTRY** is displayed if the location is empty.

3. Enter the desired number. If necessary, a pause can be entered by pressing and holding 0-9, **#NO**, or ***PIN** until an underscore appears in the display (telephone interconnect only). The individual call list entries will accept up to 5 digits. The phone call list entries accept a combination of up to 31 digits and pauses.
4. Press and hold the **M** key until the display changes indicating that the number has been stored.

Repeat steps 1-4 to store additional numbers, to change numbers already stored, or to change the storage location of a number.

8.25 STATUS/MESSAGE OPERATION

The **Status** and **Message** operations allow for the transmission of a *pre-programmed status* or a *pre-programmed message* to an EDACS site. Each Status and Message is assigned an ID then cross-referenced with the representative status condition (“Off Duty,” for example) or a message (“Call home”). In addition, Status conditions can also be associated with a programmable Menu entry (required for second method of transmitting a Status condition (see Section 8.25.1).

8.25.1 Status Operation

P7370 Model Radio

One of two methods can be used to transmit a status condition.

- METHOD 1:
1. Press the **M** key, then use the **▼** or **▲** buttons to scroll to the pre-programmed status condition. STATUS and 0 through 9 pre-programmed status selections are available from the menu.
 2. If STATUS is selected, you need to enter the number of the status condition you intend to transmit. If no status has been programmed for the selected number key, the radio will display **NO ENTRY**. A valid selection will display the status for a pre-programmed time.

After the time-out expires or the **M** key has been pressed (the **M** key will override the time-out period), the status is selected and will be transmitted to the site or stored in the radio memory where it can be polled by the site at a future time.

- METHOD 2:
1. Press the **7^{bits}Phone** key.
 2. Press the corresponding pre-programmed 0 through 9 status condition key. If no status has been programmed for the selected number key, the radio will display **NO ENTRY**. A valid selection will permit the status condition to appear in the top line of the display and the status ID to appear in the second line of the display for a pre-programmed time.

After the time-out expires or the **M** key has been pressed (the **M** key will override the time-out period), the status is selected and will be transmitted to the site or stored in the radio memory where it can be polled by the site at a future time.

View the currently selected status after it has been transmitted by pressing the **M** key and then the **M** key and then the **Ⓞ** button prior to the time-out period. If the status was not sent successfully to the site, the text associated with the status condition will flash in the display.

The status selection can be changed by pressing a different status key 0 through 9, or the status operation can be cancelled by pressing Option Button 2 **Ⓞ**. Both operations must be carried out prior to the time-out period.

8.25.2 Message Operation

The following method can be used to transmit a Message using the Message Operation.

1. Press the **[MSG]** key.
2. Press the corresponding pre-programmed 0 through 9 pre-programmed "message" key. If no message has been programmed for the selected number key, the radio will display **NO ENTRY**. A valid selection will permit the message to appear in the top line of the display and the message ID to appear in the second line of the display for a pre-programmed time.

The message selection can be changed by pressing a different message key 0 through 9, or the message operation can be cancelled by pressing Option Button 2 **[2]**. Both operations must be carried out prior to the pre-programmed time-out period.

8.26 DYNAMIC REGROUP OPERATION

Dynamic Regroup Operation permits multiple talk groups (up to eight) to be added to a radio via the system manager. The radio must be pre-programmed to respond to regrouping. Dynamic regrouping will not be activated in a radio until the system manager sends an activation message. Each radio that receives and acknowledges the regrouping instructions is successfully regrouped.

Pressing and holding the **[2]** button for 2.5 seconds toggles the user into and out of the dynamic regroup groupset. A double beep will sound for entry or exit. The display will indicate **REGRP_0x** where "x" is a digit of 1 to 8 indicating the group (when dynamic regroup has been enabled by the user). If the radio is in dynamic regroup and the user selects a group that has not been regrouped, the display will show **NO ENTRY**. The radio will be prevented from transmitting and receiving calls in this condition except for scanned groups.

After the time-out expires or the **[M]** key has been pressed (the **[M]** key will override the time-out period), the status is selected and will be transmitted to the site or stored in the radio memory where it can be polled by the site at a future time.

8.26.1 Emergency Operation

If the pre-programmed groupset on the currently selected system contains an EMER/HOME group and the radio is in dynamic regroup, the radio will declare the emergency on the currently selected dynamic group.

8.27 MACRO KEY OPERATION

Macro key operation permits the user to accomplish a series of keystrokes with a single "macro" keystroke. Each Macro Key is capable of executing up to twenty (20) keystrokes, to any push button input (i.e., keypad keys, OPTION buttons, etc.). Each macro key can be pre-programmed to activate when pressed or when released.

A macro key may also be pre-programmed to change the key stroke sequence the next time the macro key is activated.

For detailed operation and assignment of macro keys, contact your communications supervisor or administrator.

8.28 PORTABLE DATA

The P7300 series portable radios, when operating in the EDACS Trunked configuration, permit both voice and data calls to be transmitted and received. The radio can handle only one type of call at a time; however, either data or voice is selected transparently by the operator through normal usage of the radio. Data communications is not supported in conventional mode.

The radios can be connected to a Mobile Data Terminal (MDT) or to a host computer. Any RS-232 compatible device that supports the Radio Data Interface (RDI) protocol (Version 1.91 or greater) may be connected to the radio. Support for MDTs or host computers is a programmable option per radio. Additionally, radios may also be programmed for data only operation (no voice calls transmitted or received).

8.28.1 Displays

The following will be displayed during the various states of data mode of operation:

- TX DATA** Appears on top line of display when the radio is transmitting a data call.
- RX DATA** Appears on top line of display when the radio is receiving a data call.
- DATA OFF** Appears on top line of display when the radio is in the data disabled state.
- DATA ON** Appears for two seconds on top line of display when the radio is toggled to the data enabled state.

8.28.2 DATA OFF Operation

The radio can be placed in the data disabled state by any of the following methods. When the data state is disabled, **DATA OFF** appears on the top line of the display.

- Declaring an emergency (not to be used unless an actual emergency condition exists). Alert tone will sound.
- Pressing Option Button 1 \bigcirc (if pre-programmed as “no data” key). Alert tone will sound.
- Pressing the pre-programmed “no data” (ND) key. Refer to previous bullet.

8.28.3 DATA ON Operation

The data state is enabled by one of the following (depending on how it was disabled). **DATA ON** will appear on the top line in the display for two seconds then the display will return to normal.

- Pressing the pre-programmed “no data” (ND) key toggles data state ON or OFF.
- Clearing an emergency. *This is valid only if the emergency caused “DATA OFF” operation.*



8.28.4 Exiting Data Cells

Under normal conditions, the radio enters the scan lockout mode and returns to the control channel after completion of a data call (transmit or receive). If, during a data call, one of the following operations occurs, the data call is immediately terminated and the radio performs the desired function:

- If the PTT is activated.
- If an Emergency is declared by pressing the pre-programmed emergency button.
- If a group or system is changed.

8.28.5 Scan Lockout Mode

Following the transmission or reception of a data call, if scan is enabled, scanning will stop temporarily. There are two independent pre-programmed times associated with this mode; one after a received data call and one after a transmitted data call. During this time the scan indicator will flash to indicate that scan is enabled but temporarily suspended. This condition typically returns to normal scan operation when the pre-programmed time expires; however, the following operations and conditions will terminate the scan lockout mode before the timeout has expired.

- Press the  button.
- Press the PTT.
- Change a group or system.
- Enter Telephone Interconnect mode.
- Enter Individual call mode.
- Receive a new emergency assignment.
- Declare or clear an emergency.
- Receive an individual or phone call.
- Receive an Agency, Fleet, or System All Call.
- Press  (P7350 model) or  (P7370 model) to toggle Scan ON or OFF.

8.28.6 Data Lockout Mode

During the voice call scan hang time (pre-programmed) the radio will not receive data calls.

This page intentionally left blank

CONVENTIONAL OPERATION

9 CONVENTIONAL OPERATION

The radio functions in the conventional mode when using conventional communications channels (non-trunked).

9.1 CONTROLS

The radio features two rotary control knobs and an emergency button mounted on the top of the radio. Push-To-Talk and option buttons are mounted on the side. The front mounted keypad has six buttons on the P7350 Scan model and 15 buttons on the P7370 System model.

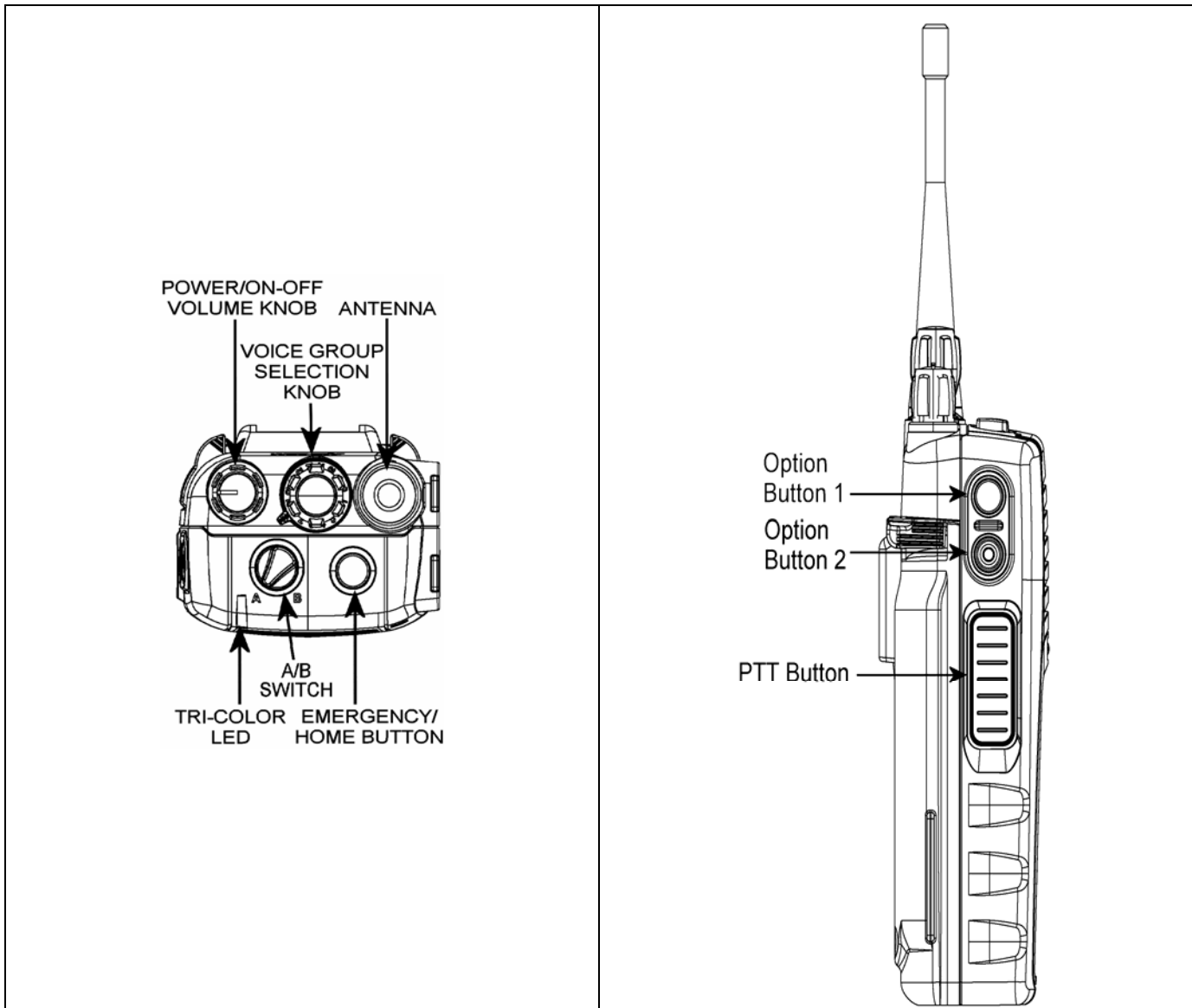

Figure 9-1: Top View

Figure 9-2: Side View

9.1.1 Buttons and Knobs

This section describes the primary function of the button and knob controls. Refer to Figure 9-1 and Figure 9-2.

POWER ON-OFF VOLUME KNOB	Applies power to and adjusts the receiver's volume. Rotating the control clockwise applies power to the radio. A single alert tone (if enabled through programming) indicates the radio is operational.
	Rotating the control clockwise increases the volume level. Minimum volume levels may be programmed into the radio to prevent missed calls due to a low volume setting. While adjusting the volume the display will momentarily indicate the volume level (i.e. VOL=31). The volume range is from a minimum programmed level of zero (displayed as OFF in the display) up to 40, which is the loudest level.
VOICE GROUP SELECTION CONTROL KNOB	Selects pre-programmed channels. This is a 16-position rotary knob. <i>Note:</i> A mechanical stop, which can limit the positions accessed, is shipped with the radio but must be installed. To install the mechanical stop, remove the Voice Group Selection control knob, loosen the set screw on the Voice Group Selection control knob metal base (using a 1.27mm hex wrench), and remove the Voice Group Selection control knob metal base. Replace the 16 channel ring with the channel stop ring located at the desired channel. Re-install the Voice Group Selection control knob metal base, tighten the set screw, and re-install the Voice Group Selection control knob.
EMERGENCY/ HOME BUTTON	Automatically selects the pre-programmed Group/System by pressing and holding for a programmed duration. It can also be used to declare an emergency by pressing and holding for a programmed duration. The button must be pre-programmed for either operation, but not both.
PTT BUTTON	Push-To-Talk must be pressed before voice transmission begins.
SIDE OPTION BUTTON 1 ○	Unsquels the receiver and allows channel monitoring prior to transmission. Momentarily removes the Receiver Channel Guard decoding from the channel.
SIDE OPTION BUTTON 2 ◎	Activates one of a number of programmable software options selected during PC programming. Programmable options include hi/low power settings, keypad lock, LCD contrast, and LCD and keypad back lighting.

9.1.2 Keypad

The keys on the keypad have special functions and are labeled using a symbol or abbreviated word describing its primary function. Numeric entry is a secondary function of the keys. Each key is described in the following subsections.

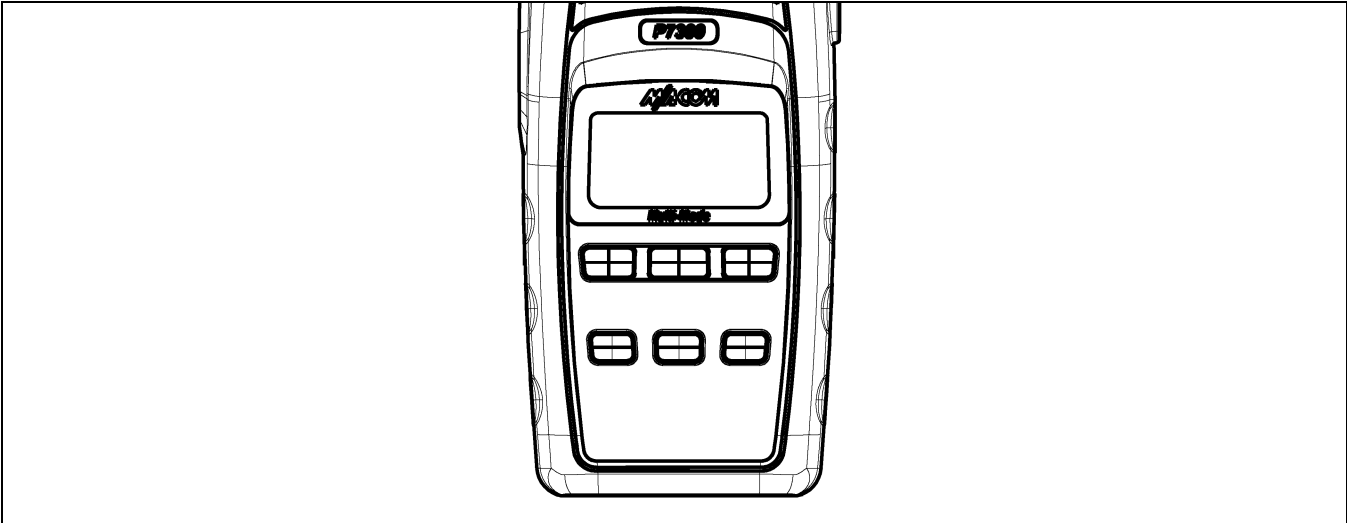

Figure 9-3: P7350 “Scan” Radio Front Panel

KEY	FUNCTION
<div style="display: flex; flex-direction: column; gap: 5px;"> <div style="border: 1px solid black; padding: 2px; width: 20px; text-align: center;">▼</div> <div style="border: 1px solid black; padding: 2px; width: 20px; text-align: center;">▲</div> </div>	<p><u>Primary Function:</u> Allows the user to scroll through available systems, groups, or channels, depending on personality programming.</p> <p><u>Secondary Function:</u> Changes the selection for an item within a list.</p>
<div style="border: 1px solid black; padding: 2px; width: 20px; text-align: center;">M</div>	<p><u>Primary Function:</u> Accesses the pre-stored menu.</p> <p><u>Secondary Function:</u> Activates a selected item within a list. This is similar to an “Enter” key.</p>
<div style="border: 1px solid black; padding: 2px; width: 20px; text-align: center;">A/D</div>	<p>Adds/Deletes selected groups or channels from the Scan list of the currently selected system.</p>
<div style="border: 1px solid black; padding: 2px; width: 20px; text-align: center;">SCN</div>	<p>Turns the Scan operation ON and OFF.</p>
<div style="border: 1px solid black; padding: 2px; width: 20px; text-align: center;">OPT</div>	<p>Activates one of a number of pre-programmed software options.</p>

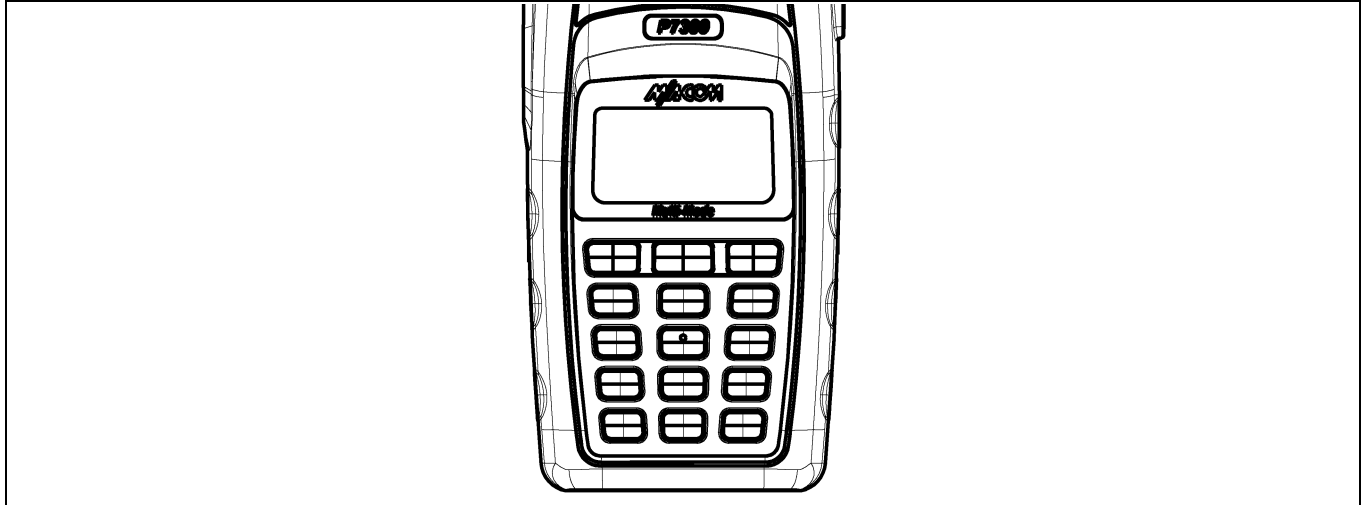

Figure 9-4: P7370 “System” Radio Front Panel

KEY	FUNCTION
▼ ▲	<p><u>Primary Function:</u> Allows the user to scroll through available systems, groups, or channels, depending on personality programming.</p> <p><u>Secondary Function:</u> Changes the selection for an item within a list.</p>
M	<p><u>Primary Function:</u> Accesses the pre-stored menu.</p> <p><u>Secondary Function:</u> Activates a selected item within a list. This is similar to an “Enter” key.</p>
1 SYS 2 GRP 3 SCN 4 PRT 5 JKL 6 ADD 7 SYS 8 MSG 9 DEL 0 * PIN # IND	<p><u>Primary Function:</u> Refer to the separate key definitions within this table.</p> <p><u>Secondary Function:</u> These keys function much as a typical DTMF telephone pad 0-9, *, and # keys; and are used to place telephone interconnect calls and individual unit-to-unit calls.</p>
1 SYS	Selects a specific system. If the rotary knob is programmed to select the system and more than 16 systems are programmed in the radio, the 1 SYS key is used to select additional banks (groupings) of systems.
2 GRP	Selects a specific group.
3 SCN	Turns the Scan operation ON and OFF.
6 ADD	Adds groups or channels from the currently selected system to the Scan list.
9 DEL	Deletes selected groups or channels of the currently selected system from the Scan list.
* PIN	Places telephone interconnect calls.
# IND	Initiates individual calls.

9.2 DISPLAY

The radio display is made up of 3 lines (see Figure 9-5). Lines 1 and 2 contain eight alphanumeric character blocks and are used primarily to display system or group/channel names. Line 1 also displays radio status messages. The 3rd line is used primarily to display radio status icons. All three lines are used to display menu options when in the menu mode. If programmed, the display backlighting will illuminate upon power up or when radio controls are operated.

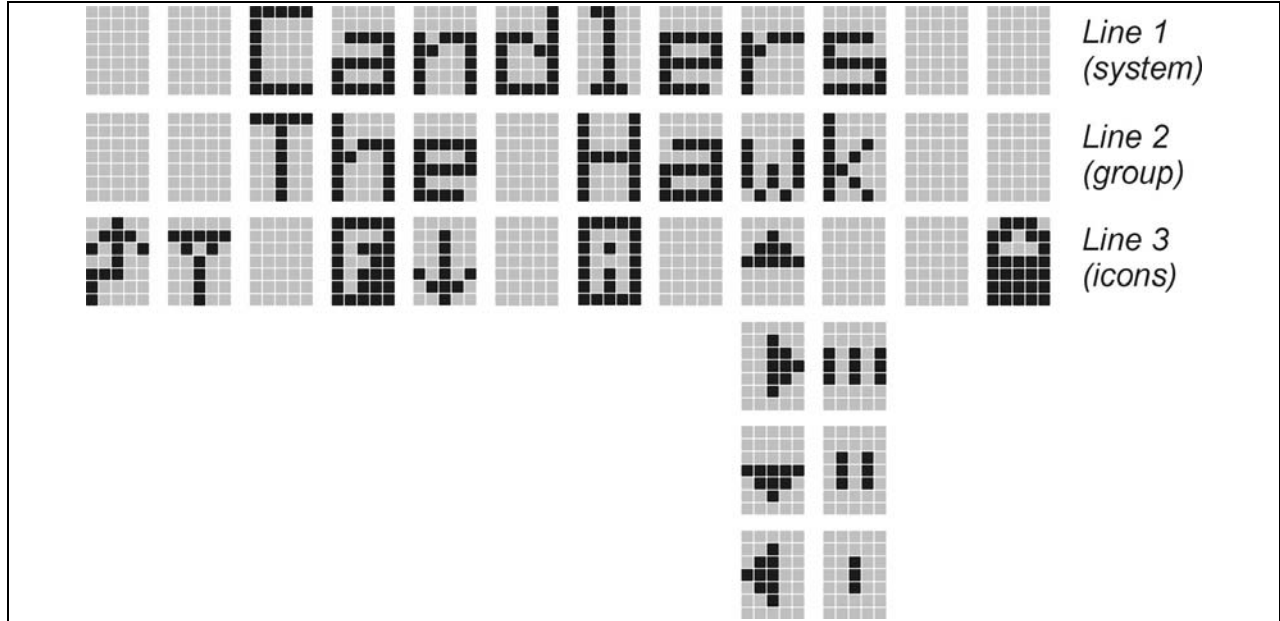





Figure 9-5: Radio Display

9.2.1 Radio Status Icons

Status Icons indicate the various operating characteristics of the radio. The icons show operating modes and conditions and appear on the third line of the display (see Table 9-1).

Table 9-1: Status Icon Descriptions

STATUS ICON DESCRIPTIONS	
	Steady – “Busy” transmitting or receiving. Appears in the 2nd position of the display.
	Steady – during all radio transmissions. Appears in the 1 st position of the display.
	Steady – transmit at low power. Appears in the 5th position of the display. If icon is not visible – transmit at high power
	Steady – battery charge indicator (refer to Figure 9-6). Appears in the 12th position of the display. Flashing – Low battery indicator (refer to Figure 9-6).
	Steady – Indicates the current channel is set up as an analog channel. Appears in the 7th position of the display.
	Steady – group or channel in scan list. Appears in the 10th position of the display.

STATUS ICON DESCRIPTIONS	
	Steady – priority 2 group or channel. Appears in the 10th position of the display.
	Steady – priority 1 group or channel. Appears in the 10th position of the display.
	Steady (rotates clockwise) – scan mode enabled. Appears in the 9th position of the display. If icon is not visible – scan is disabled
	Steady – Channel Guard enabled. Appears in the 4th position of the display. If icon is not visible – Channel Guard is disabled

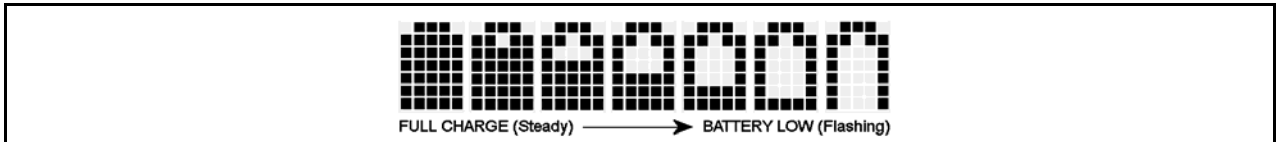

Figure 9-6: Battery Charge Icons (Full Cycle)

The battery icons (see Figure 9-6) indicate approximate level only, based on battery voltage.

9.3 TRI-COLOR LED

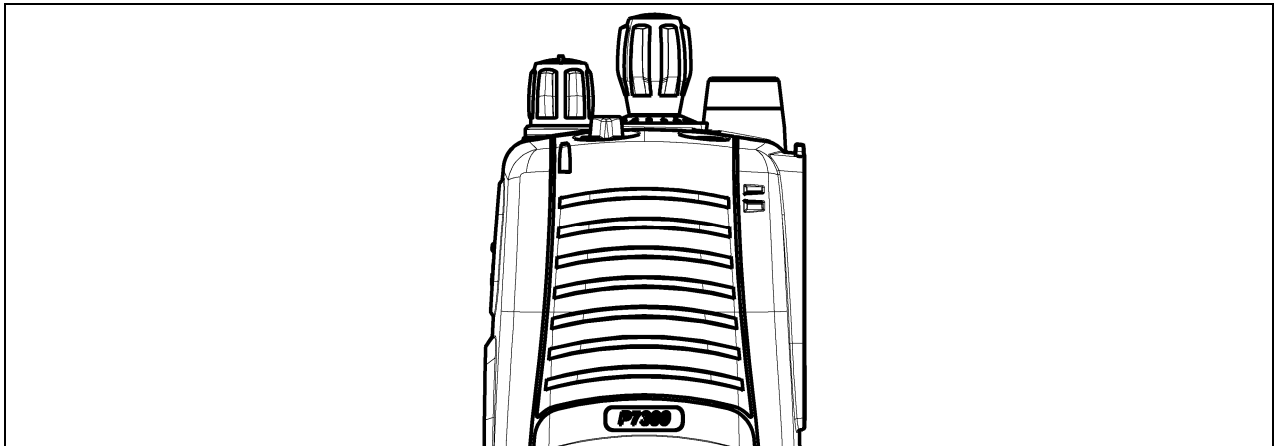

Figure 9-7: Tri-Color LED

The Tri-Color LED changes color to indicate radio status and is visible from both the front and top of the radio (see Figure 9-7). The colors of the LED and the status they represent are:

- Green:** Receiving
- Red:** Transmitting Unencrypted
- Orange:** Transmitting Encrypted

9.4 STATUS MESSAGES

During radio operation, various radio Status Messages can be displayed. The messages are described below.

MESSAGE	NAME	DESCRIPTION
TALKARND	Talkaround	Indicates the radio is operating on conventional channels in talkaround mode (no repeater).
LOW BATT	Low Battery	Battery voltage has dropped to the point to where the radio is no longer able to transmit. The radio will still receive calls until the battery is discharged beyond the point of operation at which time the radio will automatically shutdown.
VOL=31	Volume Level	Indicates the current volume level. The volume level display ranges from OFF (silent) to 40 (loudest).

9.4.1 Error Messages

If either of the Error Messages shown below is displayed, the radio is programmed incorrectly or needs servicing.

```
DSP ERR    or    DIG U
ERR=XXXX   ERR
(PowerUp
only)
```

Where: **xxxxx** is the error code and **DSP ERR** or **DIG U ERR** is the message.

9.5 ALERT TONES

The P7300 radio provides audible Alert Tones or “beeps” to indicate the various operating conditions (see Table 9-2).

Table 9-2: Alert Tones

NAME	STONE	DESCRIPTION
Call Originate	one short mid-pitched	<i>OK to talk after pressing the push-to-talk button</i>
Carrier Control Timer	five high-pitched/one long low-pitched	<i>PTT depressed for maximum length of time</i>
Low Battery	one low-pitched/one short mid-pitched	<i>Low battery</i>
TX Low Battery Alert	one low-pitched	<i>After PTT - battery too low to transmit</i>

9.6 TURNING ON THE RADIO

1. Power ON the radio by rotating the POWER ON-OFF/VOLUME knob clockwise. A short alert signal (if enabled through programming) indicates the radio is ready to use.
2. The display shows the last selected system and group/channel or a default system and group/channel (depending on programming).

3. Adjust the POWER ON-OFF/VOLUME knob to the desired volume level.
4. Select the desired system, group/channel. The display indicates the current system and group/channel names.
5. The radio is now ready to transmit and receive calls.

9.7 SYSTEM SELECTION

- METHOD 1:** From the control knob: If system selection is programmed to the Voice Group Selection control knob, select a system by turning the knob to the desired number position (1-16). The display registers the new system name on line one. The **O** button can be programmed to provide access to a “2nd bank” of 16 system number positions (17-32).
- METHOD 2:** From the keypad: If system selection is programmed as the primary function of **▼** and **▲**, select a system by pressing **▼** or **▲** to scroll through the system list. The display registers the new system name on line one.
- METHOD 3:** (**P7370 model radios only**) Direct Access: Press **1^{sys}** to enter the system select mode. Press the numeric key, which is mapped to the desired system. Press **M**. The radio will move to the selected system.



NOTE

If system selection is programmed to the Voice Group Selection control knob, direct access to systems will not be available. Pressing **▼** or **▲** will scroll through different sets of 16 systems each (banks) if more than 16 systems are programmed into the radio. The systems within each bank are then selectable via the Voice Group Selection control knob as described previously in METHOD 1.

Example:







System: 1 = North	Group: 1 = Group 1
2 = South	2 = Group 2
3 = East	3 = Group 3
4 = West	4 = Group 4

1. Press **1^{sys}**. (South is the currently selected system.)
2. Press **4^{sys}**. (Press 4 to select the “West” system.)
3. Press **M**. (West is the newly selected system.)

9.8 GROUP/CHANNEL SELECTION







Several methods can be used to select a new group/channel.

- METHOD 1:** From the Control knob: If group selection is programmed to the Voice Group Selection control knob, select a group by turning the Voice Group Selection control knob to the desired group number position. The display registers the new group name on line two. If the knob is moved to a position greater than the number of programmed group, the highest programmed group will remain selected. The **O** button can be programmed to provide access to a “2nd bank” of 16 group number positions (17-32)







- METHOD 2: From the keypad: If group selection is programmed as the primary function of  and , select a group by pressing  or  to scroll through the list. The display registers the new group name on line two.
- METHOD 3: **(P7370 model radios only)** Direct Access: Press  to enter the group select mode. Press the numeric key mapped to the desired group. Press . The radio will move to the selected group.

9.9 MODIFY SCAN LIST



9.9.1 P7370 Model

1. Press  to toggle scan OFF and verify  is **not** displayed.
2. Select group or channel.
3. Press  once to remove group or channel from list.
4. Press  once to add as a normal group or channel.
5. Press  twice to add as a Priority 2 group or channel.
6. Press  three times to add as a Priority 1 group or channel.
7. Press  to re-start scanning.

9.9.2 P7350 Model

1. Press  to toggle scan OFF and verify  is **not** displayed.
2. Select group or channel.
3. Press  once to remove group or channel from the list.
4. Press  once to add as a normal group or channel.
5. Press  twice to add as a Priority 2 group or channel.
6. Press  three times to add as a Priority 1 group or channel.
7. Press  to re-start scanning.

9.10 NUISANCE DELETE

A channel can temporarily be deleted from the scan list, if it is not the currently selected channel, by pressing the  key (P7350 model) or the  key (P7370 model) during scan operation while the radio is displaying the unwanted channel. The channel will be deleted from the scan list in the same manner as if done using the steps above. Deletions done in this manner will not remain deleted if the radio is powered OFF and then powered ON.

9.11 MENU

The Menu function accesses features that are not available directly from the keypad. The order and actual menu items available is configurable through programming. At radio power up, the menu item that is at the top of the menu list will always be displayed first. Subsequent access to the menu function will return the last menu item that was shown in the display and cursor position.

1. To enter the menu mode, press the  key.

- Upon entering the menu selection mode, Menu options will appear in the display (see Figure 9-8).

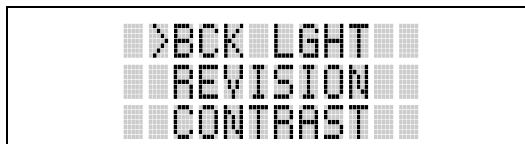

Figure 9-8: Menu Display

- The radio will continue to receive and transmit normally while in the menu function.
- To scroll through the menu options use the or keys. When the required menu item has been found align the cursor with the option then press to select it. The menu item's parameter setting shown in the display can now be changed by using or to scroll through the list of parameter values.
- Once the desired setting is reached press to store the value and return the menu option selection level.
- For menu items that display radio information, pressing or will scroll through a list of informational displays. Possible menu items are listed in Table 9-3.

An example of the backlight menu item selection process and menu item parameter change is shown in Figure 9-9.

- Press to enter the menu mode.
- Press or until the display shows:

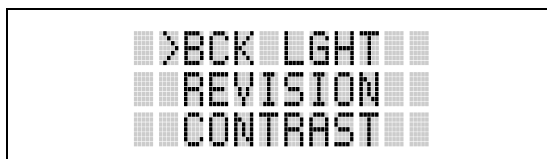

Figure 9-9: Backlight Menu Item Parameter

- Press . The backlight menu item is activated. Line one shows the active menu item and its current parameter setting. Line two shows the currently selected system or group name (see Figure 9-10).

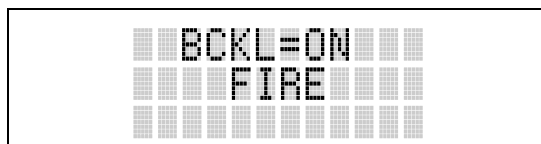

Figure 9-10: Backlight Menu Display

- The menu item's parameter setting shown in the display can now be changed by using or .
- Once the desired setting is reached press to store the value and return the menu option selection level.

For menu items that display radio information, pressing or will scroll through a list of informational displays. An example of information displays is shown in Table 9-4.



NOTE



The TX POWER menu item, when selected, toggles LOW/HIGH power. It does not use  or  to scroll nor is an additional press of the  button required.

Table 9-3: Menu Item Information

FEATURE	DISPLAY	PARAMETER SETTING	COMMENT
Keypad Lock	Menu Item: KEY LOCK Once Selected: LOCKED	Locked Unlocked	Locks the keypad. To unlock; press and release  then within 1 second press the option button (<i>NOTE: this sequence is also a short cut to locking the keypad.</i>)
Backlight Adjust	Menu Item: BCK LIGHT Once Selected: BCKL=	OFF/ON	Selects the light level for backlighting.
Contrast Adjust	Menu Item: CONTRAST Once Selected: CNTRST=	1, 2, 3, 4	Selects the display contrast level.
Transmit Power Select	Menu Item: TX POWER Once Selected: POWER=	HIGH or LOW	Selects radio output power mode.
Radio Revision Information	Menu Item: REVISION	N/A	Selects the information display to view. Informational display only (see Table 9-4). <i>No user selectable settings.</i>
Toggle Scan On/Off	SCAN	ON/OFF	Toggles Scan operation ON/OFF.
Display Current Home Group/Channel	HOME	N/A	Selects Home Group/Channel
Select Desired System	SYS SEL	N/A	Selects a new system.
Add Group/Channel to Scan List	SCAN ADD	N/A	Adds to Scan List.
Delete Group/Channel	SCAN DEL	N/A	Deletes Group or Channel from Scan List.
Add/Delete Scan List	SCAN A/D	N/A	Add or Delete from Scan List.
Talkaround	TALKARND	ON/OFF	Toggles Talkaround feature ON/OFF.
Select Channel	CHN SEL	N/A	Conventional Only.
Feature Encryption Display	Menu Item: FEATURES Once Selected: (See Feature Encryption Display Section)	N/A	Indicates current features programmed into the radio as well as certain information required to add features to the radio. <i>Informational display only. No user selectable settings.</i>

Table 9-4: Information Display

RADIO ID XXXXXXXX	LID in EDACS/EA. In CONV it has no meaning.
RAM SIZ	RAM Size
FLSH SIZ	Flash Size
RF BAND	Frequency Band
PERS VER	Software Version
DSP DATE	Date DSP code was built.
DSP TIME	Time DSP code was built.
DSP FEAT	The DSP Features supported by the DSP code, in Hexadecimal. Bit mapped (see IPC spec for details): <ul style="list-style-type: none"> • 0x0001 – Conventional • 0x0002 – EDACS • 0x0010 – AMPF • 0x0020 – undefined
DSP VER	DSP Software Version
FLSH VER	FLASH Software ex: P73U0102 P=portable, 54=5400 radio, U=unencrypted, 01=major revision (>50 means unreleased code), 02=minor revision
M/A-COM (C) 2007	Copyright
PERSNLTY	Personality Name
BLD DATE	Date host (ARM) code was built.
BLD TIME	Time host (ARM) code was built.

9.12 BACKLIGHT ON/OFF





1. Press **M** to access the menu.
2. Press **▼** or **▲** to scroll through menu until “BCKLGHT” appears.
3. Press **M** to select Backlight menu.
4. Press **▼** or **▲** to toggle backlight ON and OFF.
5. Press **M** to select new backlight setting.

9.13 CONTRAST ADJUST

1. Press **M** to access the menu.
2. Press **▼** or **▲** to scroll through menu until “CONTRAST” appears.
3. Press **M** to select Contrast menu.
4. Press **▼** or **▲** to adjust contrast setting from 1 - 4.
5. Press **M** to select new contrast setting.

9.14 DECLARING AN EMERGENCY

1. Press and hold the red Emergency/Home button (the length of time is programmable; check with the system administrator).

2. *TXEMER* will flash in the display, plus  and  will be displayed. After 2-3 seconds the transmit icon  will turn off.
3. *TXEMER* and  will remain until the emergency is cleared. (Refer to Section 8.21 for more detail concerning emergency operation.)
4. Press the PTT and  will reappear.
5. Release PTT when the transmission is complete.

9.15 LOCKING/UNLOCKING KEYPAD





1. Press  button.
2. Within 1 second, press the Option button on the side of the radio.

9.16 HIGH/LOW POWER ADJUSTMENT

Transmit power adjustment is possible if enabled through programming. Within conventional systems, transmit power is adjustable on a per channel basis. Within EDACS trunking systems, transmit power is adjustable on a per system basis.

There are two ways to toggle between high and low power:

Using the Menu Button:

1. Press .
2. Using the  or  key, scroll until the cursor (>) appears to the left of “TX POWER” in the display.
3. Press  again to toggle between High and Low power.
4. “POWER = HIGH” or “POWER = LOW” will appear momentarily on the top line of the display.

Using the Pre-Programmed Option Button:

Press the Option button. “POWER = HIGH” or “POWER = LOW” will appear momentarily on the top line of the display.

9.17 DIGITAL VOICE OPERATION

Digital voice programmed systems have three (3) different voice modes: clear (analog), digital, and private (encrypted). The voice modes are programmed on a per-group basis within each trunked system and on a per-channel basis within each conventional system.

9.17.1 Clear Mode

The Clear Mode is a voice mode in which the radio transmits and receives only clear (analog) voice signals. These analog signals are non-digitized. Clear mode transmissions can be monitored easily by unauthorized persons.



Groups or channels programmed for clear operation cannot transmit or receive digital messages.

9.17.2 Digital Mode

The Digital Mode allows the radio to transmit and receive digitized voice signals. Digital signals provide improved weak signal performance and cannot be easily monitored with a standard receiver. Groups and channels programmed for digital operation transmit only digital signals. Individual phone calls (I-Calls) are answered back in the mode in which they were received assuming the call or hang time is still active. Individual phone, all call, and emergency calls are transmitted clear if the digital mode is disabled or inoperative.

1. If receiving an analog message trunked call, the radio responds in the analog mode during the hang time on the working channel.
2. If receiving an analog I-Call, the radio responds in the analog mode during the hang time.
3. When using the ***UHC*** feature to respond to an I-Call (after the hang time has expired), the call is transmitted in the mode defined by the system mode as programmed for the current system if the ID being called is not in the I-Call list. If the ID is in the I-Call list, then the call is transmitted as defined by the I-Call mode programmed in the list for that ID.

The over dial DTMF tones are not available while in the Digital Mode.

9.17.2.1 Scanned Group Calls

Receiving a Scanned Group Call is the same as receiving a selected group call. During the scan hang time, if the radio was programmed for auto-select, it will transmit back in the same mode it received the call. For example, if a clear group is entered in the scan list, it will only receive clear calls. If the same group was available in digital and entered in the scan list, it can receive clear and digital calls, provided auto-select was programmed in the radio. The user can choose to transmit on the scanned or selected group. If a group is entered in the scan list more than once under different modes (clear and digital), only the first occurrence of the group will be used.

Table 9-5: Transmit/Receive Mode Compatibility for Digital Voice Operation

GROUP/CHANNEL PROGRAMMING (TRANSMIT)	CLEAR RECEIVE	DIGITAL RECEIVE
CLEAR	Yes	No
DIGITAL	Yes	Yes



NOTE

Conventional digital channels require Channel Guard on the channel to operate correctly.



NOTE

The voice coding technology embodied in this product is protected by intellectual property rights including patent rights, copyrights, and trade secrets of Digital Voice Systems, Inc. The user of this technology is explicitly prohibited from attempting to decompile, reverse engineer, or disassemble the Object Code, or in any other way convert the Object Code into human-readable form.

9.18 RECEIVING A CALL

1. Select the desired conventional system/channel or turn scan ON and make sure desired channel is in scan list.

2. When the radio receives a call, the radio will unmute and the channel name will appear in the display.

9.19 SENDING A CALL

1. Select desired system/channel.
2. Ensure the channel is not busy by pressing the © button momentarily. If audio is heard or if the  icon is on, the channel is busy.
3. When you're sure that the channel is not busy, press the PTT button and speak into the microphone.

P25 OPERATION

10 P25 OPERATION

Once a P25 system has been selected from the available systems on your P7300 series portable radio, the characteristics described in the following sections will govern operation.

10.1 CONTROLS

The radio features two rotary control knobs and an emergency button mounted on the top of the radio. Push-To-Talk and option buttons are mounted on the side. The front mounted keypad has six buttons on the P7350 Scan model and 15 buttons on the P7370 System Radio.

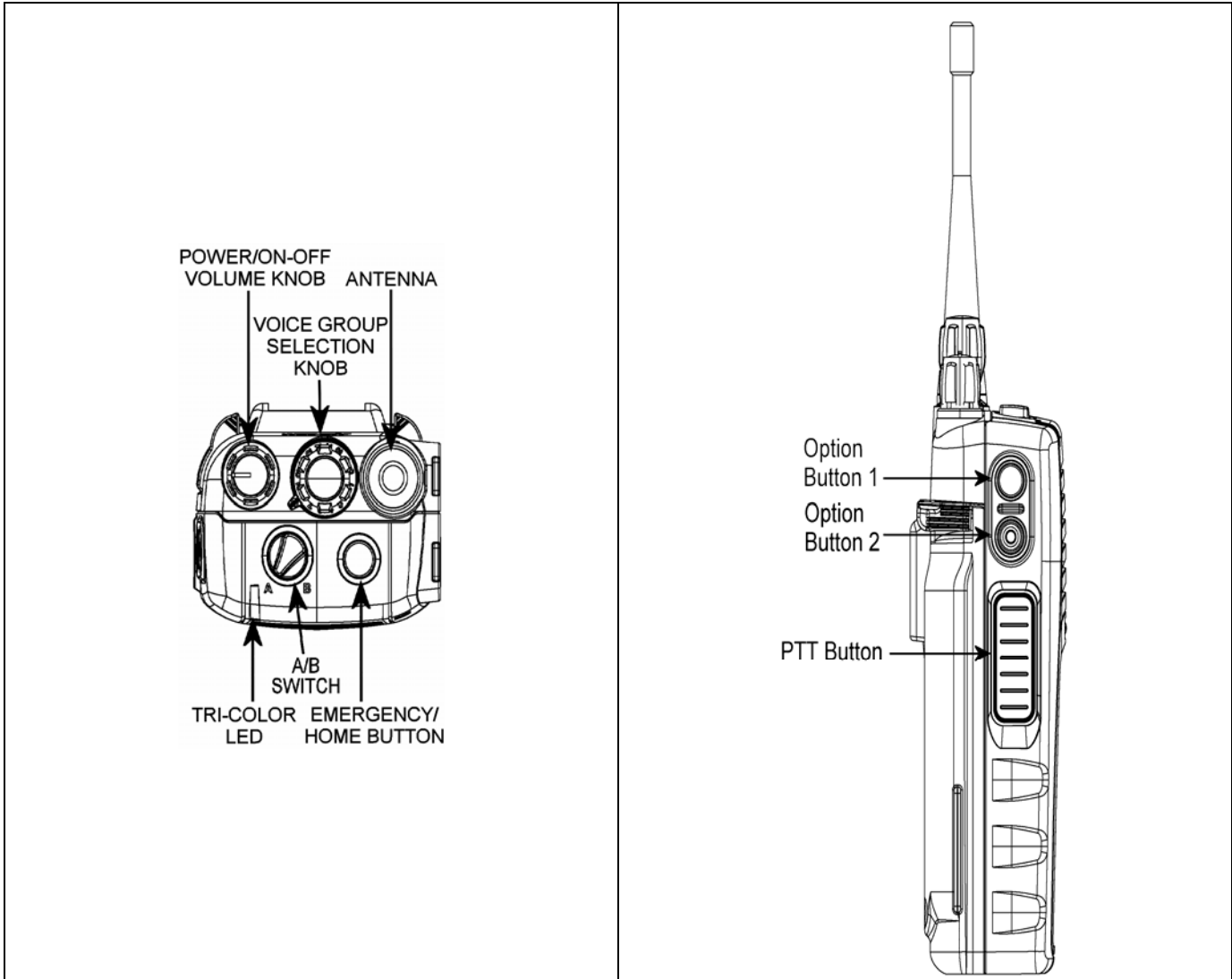

Figure 10-1: Top View

Figure 10-2: Side View

10.1.1 Buttons and Knobs

This section describes the primary function of the button and knob controls. Refer to Figure 10-1 and Figure 10-2.

POWER ON-OFF VOLUME KNOB

Applies power to and adjusts the receiver's volume. Rotating the control clockwise applies power to the radio. A single alert tone (if enabled through programming) indicates the radio is operational.

Rotating the control clockwise increases the volume level. Minimum volume levels may be programmed into the radio to prevent missed calls due to a low volume setting. While adjusting the volume the display will momentarily indicate the volume level (i.e. **VOL=31**). The volume range is from a minimum programmed level of zero (displayed as **OFF** in the display) up to 40, which is the loudest level.

VOICE GROUP SELECTION CONTROL KNOB

Selects systems or groups/channels (depending on programming). This is a 16-position rotary knob.

Note: A mechanical stop, which can limit the positions accessed, is shipped with the radio but must be installed. To install the mechanical stop, remove the Voice Group Selection control knob, loosen the set screw on the Voice Group Selection control knob metal base (using a 1.27 mm hex wrench), and remove the Voice Group Selection control knob metal base. Replace the 16 channel ring with the channel stop ring located at the desired channel. Reinstall the Voice Group Selection control knob metal base, tighten the set screw, and reinstall the Voice Group Selection control knob.

EMERGENCY/ HOME BUTTON

Automatically selects the pre-programmed Group/System by pressing and holding for a programmed duration. It can also be used to declare an emergency by pressing and holding for a programmed duration. The button must be pre-programmed for either operation, but not both.

PTT BUTTON

Push-To-Talk must be pressed before voice transmission begins. In trunked mode the radio's ID is transmitted upon depression of the PTT button.

SIDE OPTION BUTTON 1 ○

Exits the current operation (removing all displays associated with it) and returns the radio to the selected talk group. Terminates individual and telephone interconnect calls.

SIDE OPTION BUTTON 2 ⊙

Activates one of a number of programmable software options selected during PC programming. Programmable options include hi/low power settings, keypad lock, LCD contrast, and LCD and keypad back lighting.

10.1.2 Keypad

The keys on the keypad have special functions and are labeled using a symbol or abbreviated word describing its primary function. Alpha-numeric entry is a secondary function of the keys. Each key is described in the following subsections.

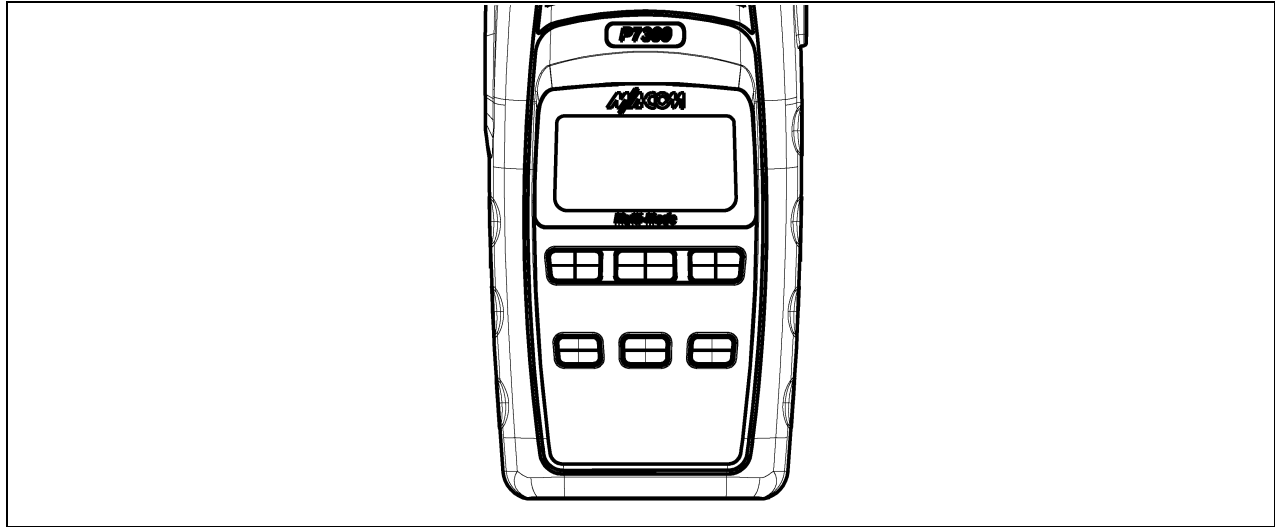

Figure 10-3: P7350 “Scan” Radio Front Panel

Table 10-1: P7350 Keypad Functions

KEY	FUNCTION
	<u>Primary Function</u> : Accesses the pre-stored menu. <u>Secondary Function</u> : Activates a selected item within the menu. This is similar to an “Enter” key.
	Scrolls thru available menu items.
 (P7350 only)	Activates one of any programmable software options selected during the PC programming, including: high/low TX power and talkaround.
 (P7350 only)	Toggles SCAN operation ON and OFF.
 (P7350 only)	Adds/Deletes selected groups or channels from SCAN list of the currently selected system.

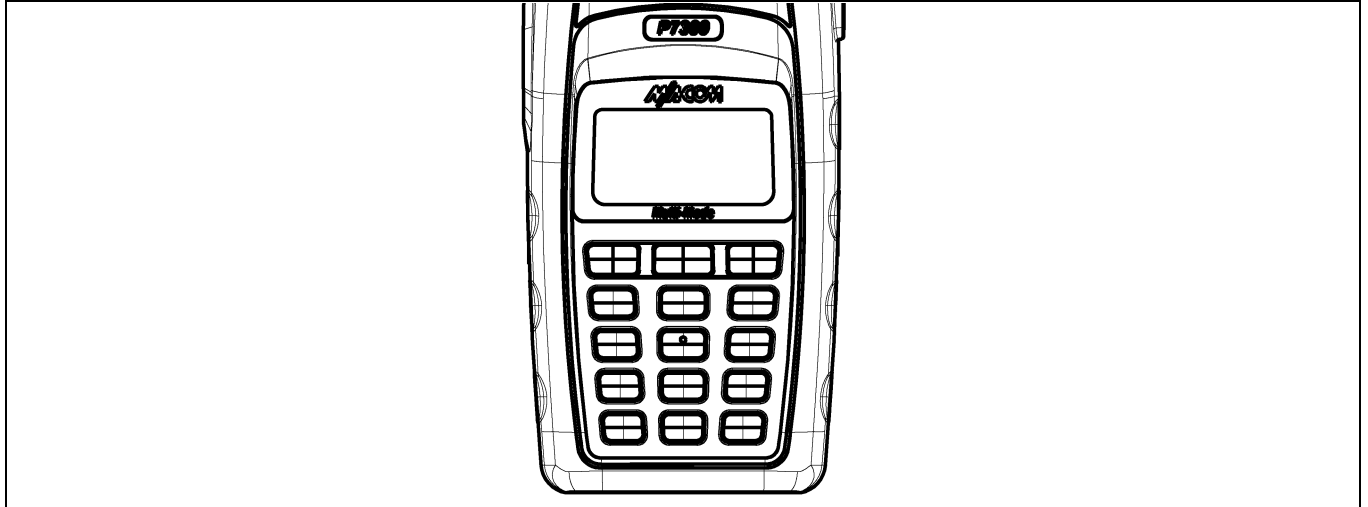

Figure 10-4: P7370 “System” Radio Front Panel

Table 10-2: P7370 “System” Keypad Functions

KEY	FUNCTION
M	<u>Primary Function:</u> Accesses the pre-stored menu. <u>Secondary Function:</u> Activates a selected item within the menu. This is similar to an “Enter” key.
▲ ▼	<u>Primary Function:</u> Allows the user to scroll through available systems, groups, or channels, depending on personality programming. <u>Secondary Function:</u> Changes the selection for an item within a list.
1 SYS 2 GRP ABC 3 SCAN DEF 4 PVT GHI 5 JKL 6 ADD MNO 7 PQR STU 8 MSG VWX 9 DEL YZ 0	<u>Primary Function:</u> Refer to the separate key definitions within this table. <u>Secondary Function:</u> These keys function much as a typical DTMF telephone pad 0-9, *, and # keys; and are used to place telephone interconnect and individual (unit-to-unit) calls.
1 SYS	Selects a specific system. If the rotary knob is used to select the system and more than 16 systems are programmed in the radio, the 1 SYS key is used to select additional banks (groupings) of systems.
2 GRP ABC	Selects a specific group.
3 SCAN DEF	Turns the Scan operation ON and OFF.
4 PVT GHI	Enables or disables Private Mode for the system/group/channel displayed.
6 ADD MNO	Adds groups or channels from the currently selected system to the Scan list.
7 PQR STU	Status. Access to the status list (0-9). The Status key permits the transmission of a pre-programmed status message to an EDACS site.
8 MSG VWX	Message. Access to the message list (0-9). The Message key permits the transmission of a pre-programmed message to an EDACS site.
9 DEL YZ	Deletes selected groups or channels of the currently selected system from the Scan list.
* PHN	Initiates telephone interconnect calls.
# IND	Initiates individual unit-to-unit calls.

10.2 DISPLAY

The radio display is made up of 3 lines (see Figure 10-5). Lines 1 and 2 contain eight alphanumeric character blocks and are used primarily to display system and group names. Line 1 also displays radio status messages. The 3rd line is used primarily to display radio status icons. All three lines are used to display menu options when in the menu mode. If programmed, the display backlighting will illuminate upon power up or when radio controls are operated.

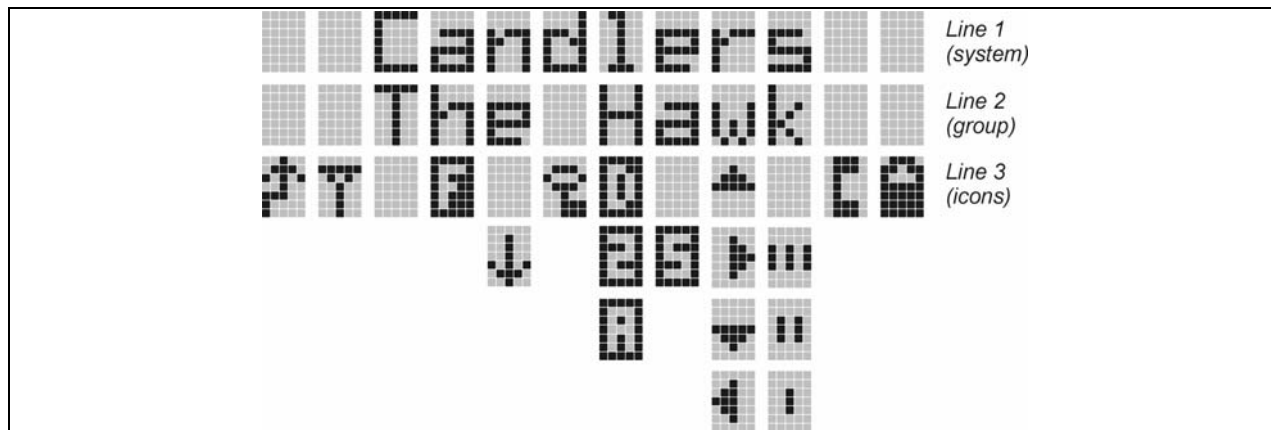















Figure 10-5: Radio Display

10.3 RADIO STATUS ICONS

Status Icons indicate the various operating characteristics of the radio. The icons show operating modes and conditions and appear on the third line of the display (see Table 10-3).

Table 10-3: Display Descriptions

	Steady – “Busy” transmitting or receiving. Appears in the 2 nd position of the display. Flashing – call queued
	Steady – special call mode (individual or telephone). Appears in the 11 th position of the display.
	Steady – during all radio transmissions. Appears in the 1 st position of the display
	Steady – transmit at low power. Appears in the 5th position of the display. If icon is not visible – transmit at high power
	Steady – battery charge indicator. Appears in the 12th position of the display. Flashing – Low battery indicator.
	Steady – Indicates the current channel is set up as an analog channel. Appears in the 7th position of the display.
	Steady – trunked system in Failsoft™ mode. Appears in the 4th position of the display.
	Steady – group or channel in scan list. Appears in the 10th position of the display.
	Steady – priority 2 group or channel. Appears in the 10th position of the display.
	Steady – priority 1 group or channel. Appears in the 10th position of the display.
	Steady (rotates clockwise) – scan mode enabled. Appears in the 9th position of the display. If icon is not visible – scan is disabled
	Steady – transmit in encrypt mode. Appears in the 6th position of the display. Flashing – receiving an encrypted call
	Steady – Indicates the current channel is set up as a Project 25 (P25) channel.
	Steady – Indicates the current channel is set up as a ProVoice channel. Appears in the 7th position of the display.

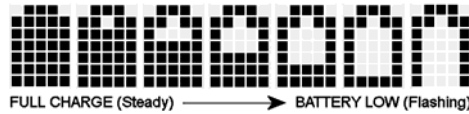

Figure 10-6: Full Cycle Battery Charge Indicator

The battery charge indicators illustrate approximate level only, based on battery voltage. Refer to Figure 10-6.

10.4 TRI-COLOR LED

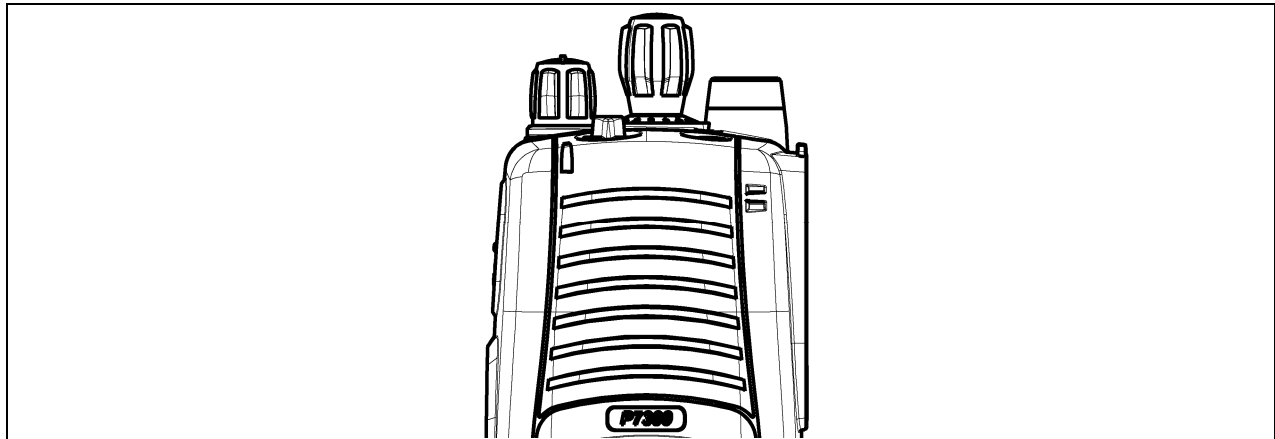

Figure 10-7: Tri-Color LED

The Tri-Color LED changes color to indicate radio status and is visible from both the front and top of the radio (see Figure 10-7). The colors of the LED and the status they represent while operating in EDACS and P25 modes are defined below.

- Green: Receiving
- Red: Unencrypted transmission
- Orange: Encrypted transmission

10.5 STATUS MESSAGES

During radio operation, various radio Status Messages can be displayed. The messages are described below.

<u>MESSAGE</u>	<u>NAME</u>	<u>DESCRIPTION</u>
QUEUED	Call Queued	Indicates the system has placed the call in a request queue.
SYS BUSY	System Busy	Indicates the system is busy, no channels are currently available, the queue is full, or an individual call is being attempted to a radio that is currently transmitting.
DENIED	Call Denied	Indicates the radio or talkgroup is not authorized to operate on the selected system and/or talkgroup.

<u>MESSAGE</u>	<u>NAME</u>	<u>DESCRIPTION</u>
CC SCAN	Control Channel Scan	Indicates the control channel is lost and the radio has entered the Control Channel Scan mode to search for the control channel (usually out of range indication).
WA SCAN	Wide Area Scan	Indicates the radio has entered the Wide Area Scan mode to search for a new system (if enabled through programming).
SYSC ON	System Scan Features On	Indicates the System Scan features are enabled.
SYSC OFF	System Scan Features Off	Indicates the System Scan features are disabled.
LOW BATT	Low Battery	Battery voltage has dropped to the point to where the radio is no longer able to transmit. The radio will still receive calls until the battery is discharged beyond the point of operation at which time the radio automatically shuts down.
RXEMER	Receive Emergency	Indicates an emergency call is being received. This message will be flashing on line two.
TXEMER	Transmit Emergency	Indicates an emergency call has been transmitted on this radio. This message will be flashing on line two.
VOL=31	Volume Level	Indicates the current volume level. The volume level display ranges from OFF (silent) to 40 (loudest).
WHC	Who Has Called	Indicates an individual call has been received, but not responded to. The indicator turns OFF if the individual call mode is entered, the system is changed, or the radio is turned off and then on again.
UNKNOWN	Unknown ID	Indicates an individual call is being received from an unknown ID.

10.5.1 Error Messages

If either of the Error Messages shown below is displayed, the radio is programmed incorrectly or needs servicing.

```
DSP ERR      or  DIG U
ERR=XXXX    ERR
(PowerUp
only)
```

Where: `xxxx` is the error code and `DSP ERR` or `DIG U ERR` is the message.

10.6 ALERT TONES

The P7300 series radios provide audible Alert Tones or “beeps” to indicate the various operating conditions (see Table 10-4).

Table 10-4: Alert Tones

NAME	STONE	DESCRIPTION
Call Originate	one short mid-pitched	<i>OK to talk after pressing the push-to-talk button</i>
Call Queued	one high-pitched	<i>Call queued for processing</i>
Autokey	one mid-pitched	<i>Queued call received channel assignment</i>
System Busy	three low-pitched	<i>System busy or unable to complete call</i>
Call Denied	one low-pitched	<i>Radio is not authorized on the system or group</i>
Carrier Control Timer	five high-pitched/one long low-pitched	<i>PTT depressed for maximum length of time</i>
Low Battery	one low-pitched/one short mid-pitched	<i>Low battery</i>
TX Low Battery Alert	one low-pitched	<i>After PTT - battery too low to transmit</i>

10.7 TURNING ON THE RADIO

1. Power ON the radio by rotating the POWER ON-OFF/VOLUME knob clockwise. A short alert signal (if enabled through programming) indicates the radio is ready to use.
2. The display shows the last selected system and group or a default system and group (depending on programming).
3. Adjust the POWER ON-OFF/VOLUME knob to the desired volume level.
4. Select the desired system and group. The display indicates the current system and group names.
5. The radio is now ready to transmit and receive calls.

10.8 SYSTEM SELECTION

METHOD 1: From the Control knob: If system selection is programmed to the Voice Group Selection control knob, select a system by turning the knob to the desired system number position (1-16). The display registers the new system name on line one. The **[SYS]** button can be programmed to provide access to a “2nd bank” of 16 system number positions (17-32).

METHOD 2: From the keypad: If system selection is programmed as the primary function of **[▼]** and **[▲]** select a system by pressing **[▼]** or **[▲]** to scroll through the system list. The display registers the new system name on line one.

METHOD 3: (**P7370 model radios only**) Direct Access: Press **[SYS]** to enter the system select mode. Press the numeric key, which is mapped to the desired system. Press **[M]**. The radio will move to the selected system.



NOTE

If system selection is programmed to the Voice Group Selection control knob, direct access to systems will not be available. Pressing or will scroll through different sets of 16 systems each (banks) if more than 16 systems are programmed into the radio. The systems within each bank are then selectable via the Voice Group Selection control knob as described previously in METHOD 1.

Example:

System: 1 = North	Group: 1 = Group 1
2 = South	2 = Group 2
3 = East	3 = Group 3
4 = West	4 = Group 4

1. Press . (South is the currently selected system.)
2. Press . (Press 4 to select “West” system.)
3. Press . (West is the newly selected system.)

10.8.1 GROUP/CHANNEL SELECTION

Several methods can be used to select a new group or channel.

METHOD 1: From the Control knob: If group selection is programmed to the Voice Group Selection control knob, select a group by turning the Voice Group Selection control knob to the desired group number position. The display registers the new group name on line two. If the knob is moved to a position greater than the number of programmed groups, the highest programmed group will remain selected. The button can be programmed to provide access to a “2nd bank” of 16 group number positions (17-32).

METHOD 2: From keypad: If group selection is programmed as the primary function of and , select a group by pressing or to scroll through the group list. The display registers the new group name on line two.

METHOD 3: (**P7370 model radios only**) Direct Access: Press to enter the group select mode. Press the numeric key mapped to the desired group. Press . The radio will move to the selected group.

10.9 MODIFY SCAN LIST

10.9.1 P7370 Model

1. Press to toggle scan OFF and verify is **not** displayed.
2. Select group or channel.
3. Press once to remove group from list.
4. Press once to add as a normal group.
5. Press twice to add as a Priority 2 group.
6. Press three times to add as a Priority 1 group.
7. Press to re-start scanning.

10.9.2 P7350 Model

1. Press **[SCN]** to toggle scan OFF and verify  is **not** displayed.
2. Select group or channel.
3. Press **[ADD]** once to remove group from the list.
4. Press **[ADD]** once to add as a normal group.
5. Press **[ADD]** twice to add as a Priority 2 group.
6. Press **[ADD]** three times to add as a Priority 1 group.
7. Press **[SCN]** to re-start scanning.

10.10 MENU

The Menu function accesses features that are not available directly from the keypad. The order and actual menu items available is configurable through programming. Upon radio power up, the menu item that is at the top of the menu list will always be displayed first. Subsequent access to the menu function will return the last menu item that was shown in the display and cursor position.

1. To enter the menu mode, press **[M]**.
2. Upon entering the menu selection mode, Menu options will appear in the display (see Figure 10-8).

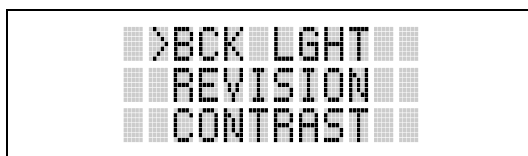

Figure 10-8: Menu Display

3. The radio will continue to receive and transmit normally while in the menu function.
4. To scroll through the menu options use the **[▼]** or **[▲]** keys. When the required menu item has been found align the cursor with the option then press **[M]** to select it. The menu item's parameter setting shown in the display can now be changed by using **[▼]** or **[▲]** to scroll through the list of parameter values.
5. Once the desired setting is reached press **[M]** to store the value and return the menu option selection level.

For menu items that display radio information, pressing **[▼]** or **[▲]** will scroll through a list of informational displays. Possible menu items are listed in Table 10-5.

10.10.1 Menu Item Selection Process

An example of the backlight menu item selection process and menu item parameter change is shown in Figure 10-9.

1. Press **[M]**. The menu mode is entered.
2. Press **[▼]** or **[▲]** until the display shows:

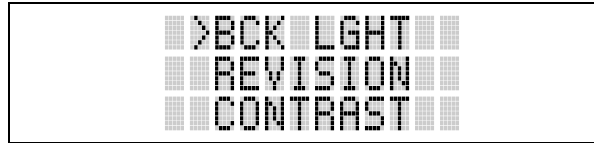

Figure 10-9: Backlight Menu Item Selection Parameter

- Press **[M]**. The backlight menu item is activated. Line one shows the active menu item and its current parameter setting. Line two shows the currently selected system or group name (see Figure 10-10).

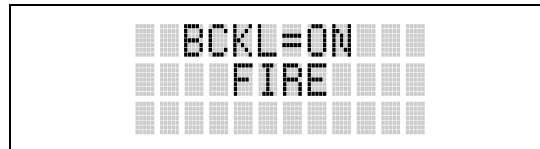

Figure 10-10: Backlight Menu Display

- The menu item's parameter setting shown in the display can now be changed by using **[v]** or **[^]**.
- Once the desired setting is reached press **[M]** to store the value and return the menu option selection level.

For menu items that display radio information pressing **[v]** or **[^]** will scroll through a list of informational displays. An example of information displays is shown in Table 10-6.



NOTE

The TX POWER menu item, when selected, toggles LOW/HIGH power. It does not use **[v]** or **[^]** to scroll nor is an additional press of the **[M]** button required.

Table 10-5: Menu Item Information







FEATURE	DISPLAY	PARAMETER SETTING	COMMENT
Keypad Lock	Menu Item: KEY LOCK Once Selected: LOCKED	Locked Unlocked	Locks the keypad. To unlock; press and release [M] then within 1 second press the option button <i>NOTE</i> : This sequence is also a short cut to locking the keypad.
Backlight Adjust	Menu Item: BCK LIGHT Once Selected: BCKL=	OFF/ON	Selects the light level for backlighting.
Contrast Adjust	Menu Item: CONTRAST Once Selected: CNTRST=	1, 2, 3, 4	Selects the display contrast level.
Transmit Power Select	Menu Item: TX POWER Once Selected: POWER=	HIGH or LOW	Selects radio output power mode.
Radio Revision Information	Menu Item: REVISION	N/A	Selects the information display to view. Informational display only. <i>No user selectable settings.</i>
Toggle Scan On/Off	SCAN	ON/OFF	Toggles Scan operation ON/OFF.
Toggle Private Mode	PRIVATE	ON/OFF	Toggles Private Mode ON/OFF.
Display Current Encryption Key	DISP KEY	N/A	Displays current encryption key. Informational display only. <i>No selectable settings.</i>

FEATURE	DISPLAY	PARAMETER SETTING	COMMENT
Display Current Home Group/Channel	HOME	N/A	Selects Home Group/Channel
Select Desired System	SYS SEL	N/A	Selects a new system.
Add Group/Channel to Scan List	SCAN ADD	N/A	Adds to Scan List.
Delete Group/Channel	SCAN DEL	N/A	Deletes Group or Channel from Scan List.
Add/Delete Scan List	SCAN A/D	N/A	Add or Delete from Scan List.
Select Telephone Numbers From Phone List	PHN CALL	N/A	Trunked Only.
Data Operation	NO DATA	ON/OFF	Trunked Only. Toggles Data Operation ON/OFF.
Select Individual Call from IC List	IND CALL	N/A	Trunked Only.
Select Group	GRP SEL	N/A	Trunked Only.
Feature Encryption Display	Menu Item: FEATURES	N/A	Indicates current features programmed into the radio as well as certain information required to add features to the radio. <i>Informational display only. No user selectable settings.</i>
System Scan Enable	Menu Item: SYS SCAN Once Selected: SYSC ON or SYSC OFF	ON/OFF	Toggles System Scan feature ON/OFF.







Table 10-6: Information Display

RADIO ID XXXXXXXX	LID in EDACS/EA In CONV it has no meaning.
RAM SIZ	RAM Size
FLSH SIZ	Flash Size
RF BAND	Frequency Band
PERS VER	Software Version
DSP DATE	Date DSP code was built.
DSP TIME	Time DSP code was built.
DSP FEAT	The DSP Features supported by the DSP code, in Hexadecimal. Bit mapped (see IPC spec for details): <ul style="list-style-type: none"> • 0x0001 – Conventional • 0x0002 – EDACS • 0x0010 – AMPF • 0x0020 – undefined
DSP VER	DSP Software Version
FLSH VER	FLASH Software ex: P73U0102 P=portable, 54=5400 radio, U=unencrypted, 01=major revision (>50 means unreleased code), 02=minor revision
M/A-COM (C) 2007	Copyright
PERSNLTY	Personality Name
BLD DATE	Date host (ARM) code was built.
BLD TIME	Time host (ARM) code was built.





10.11 BACKLIGHT ON/OFF

1. Press  to access the menu.
2. Press  or  to scroll through menu until “BCKLGHT” appears.
3. Press  to select Backlight menu.
4. Press  or  to toggle backlight ON and OFF.
5. Press  to select new backlight setting.



10.12 CONTRAST ADJUST

1. Press  to access the menu.
2. Press  or  to scroll through menu until “CONTRAST” appears.
3. Press  to select Contrast menu.
4. Press  or  to adjust contrast setting from 1 - 4.
5. Press  to select new contrast setting.

10.13 DECLARING AN EMERGENCY

1. Press and hold the red Emergency/Home button (the length of time is programmable; check with the system administrator).
2. ***TXEMER*** will flash in the display, plus  and  will be displayed. After 2-3 seconds the transmit icon  will turn off.
3. ***TXEMER*** and  will remain until the emergency is cleared. Refer to Section 10.19 for more detail regarding emergency operation.
4. Press the PTT and  will reappear.
5. Release PTT when the transmission is complete.

10.14 LOCKING/UNLOCKING KEYPAD

1. Press  button.
2. Within 1 second, press the  button on the side of the radio.



10.15 HIGH/LOW POWER ADJUSTMENT

Transmit power adjustment is possible if enabled through programming. Within conventional systems, transmit power is adjustable on a per channel basis. Within EDACS trunking systems, transmit power is adjustable on a per system basis.

There are two ways to toggle between high and low power, described in Sections 10.15.1 and 10.15.2.

10.15.1 Using the Menu Button

1. Press .

2. Using the  or  keys, scroll until the cursor (>) appears to the left of “TX POWER” in the display.
3. Press  again to toggle between High and Low power.
4. “POWER = HIGH” or “POWER = LOW” will appear momentarily on the top line of the display.

10.15.2 Using the Pre-Programmed Option Button

Press the Option button. “POWER = HIGH” or “POWER = LOW” will appear momentarily on the top line of the display.

10.16 DIGITAL VOICE OPERATION

Digital voice programmed systems have three (3) different voice modes: clear (analog), digital, and private (encrypted). The voice modes are programmed on a per-group basis within each trunked system and on a per-channel basis within each conventional system.

10.16.1 Clear Mode

The Clear Mode is a voice mode in which the radio transmits and receives only clear (analog) voice signals. These analog signals are non-digitized and non-encrypted. Clear mode transmissions can be monitored easily by unauthorized persons.



NOTE

Groups or channels programmed for clear operation cannot transmit or receive digital or private messages.

10.16.2 Digital Mode

The Digital Mode allows the radio to transmit and receive digitized voice signals. Digital signals provide improved weak signal performance and cannot be easily monitored with a standard receiver. Groups programmed for digital operation transmit only digital signals. Message trunked group calls and individual phone calls (I-Calls) are answered back in the mode in which they were received assuming the call or hang time is still active. Individual phone, all call, and emergency calls are transmitted clear if the digital mode is disabled or inoperative.

1. If receiving an analog message trunked call, the radio responds in the analog mode during the hang time on the working channel.
2. If receiving an analog I-Call, the radio responds in the analog mode during the hang time.
3. When using the ***WHC*** feature to respond to an I-Call (after the hang time has expired), the call is transmitted in the mode defined by the system mode as programmed for the current system if the ID being called is not in the I-Call list. If the ID is in the I-Call list, then the call is transmitted as defined by the I-Call mode programmed in the list for that ID.



The over dial DTMF tones are not available while in the Digital Mode.

10.16.3 Private Mode

The Private Mode allows the radio to transmit encrypted messages and receive clear or private transmissions. The radio transmits private if the group is programmed for private operation and forced operation is pre-programmed. If auto-select operation is pre-programmed and the radio is in the Private





Mode, the radio transmits in the mode of the received call if the hang time is active. If no hang time is active, the radio transmits private.

Cryptographic keys are transferred to the radio using a cryptographic Keyloader. Up to seven (7) different cryptographic keys, numbered 1-7, can be transferred from a Keyloader and stored in the radio. An individual key is automatically selected on a per-group basis according to the radio programming. Groups and channels within the digital system can be programmed for keys 1-7 (private). Up to 8 banks of 7 keys can be stored for private systems. The bank is specified per system.

When operating on a group programmed for Private Mode, all transmissions are private transmissions and the radio receives clear and private signals. The status icon  is displayed when the Private Mode is enabled. If the selected group is programmed for auto-select capability, the mode may be toggled between private and clear with the  key, then following the selection mode rules. Radios programmed for forced private operation do not allow a change of the transmit mode.

10.16.3.1 Displaying the Currently Used Cryptographic Key Number

To Display the Currently Used Cryptographic Key Number for either the system encryption key (for special call such as individual, phone, all, agency or fleet) or the group key (for group calls), perform the following procedure:

1. Press the  button.
2. Use the  or  button to select "DISP KEY."
3. Use the  or  button to toggle between displaying the system key (Figure 10-11) or the group/channel key (Figure 10-12).

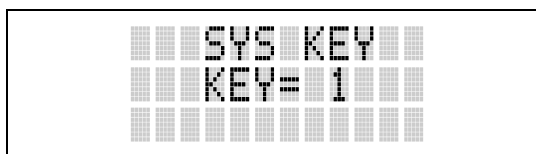

Figure 10-11: System Encryption Key Display

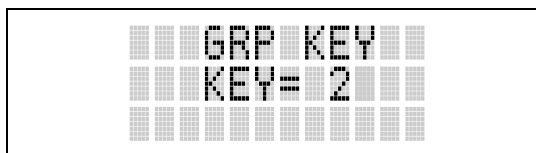



Figure 10-12: Group/Channel Encryption Key Display

10.16.3.2 Key Zero

All cryptographic keys can be zeroed (erased from radio memory) by pressing the  button and while still pressing this button, press and hold the OPTION button. Press both buttons for 2 seconds. A series of beeps will begin at the start of the 2 second period and then switch to a solid tone after the keys have been zeroed. The display will indicate **KEY ZERO**.



If the cryptographic key(s) are zeroed, one or more keys must be transferred from the Keyloader into the radio before private communications may continue.

10.16.4 Private Operation

10.16.4.1 Receiving an Encrypted Call

When receiving, the radio automatically switches between clear or private operation. If the transmission being received is an encrypted transmission, it will be decrypted, the  icon is displayed, the receiver will unquench and the message will be heard in the speaker. For this to occur, the selected group or channel must be programmed for private operation and the correct cryptographic key must be loaded into the radio.

10.16.4.2 Transmitting an Encrypted Call

1. Select the desired group or channel.
2. Place the radio in Private Mode by pressing  key; then follow the selection mode rules. On a System radio, the  key can be used to toggle the Private Mode ON/OFF. When Private Mode is enabled, the  icon is displayed.
3. If the last state of the radio was Private Mode, the Private Mode will be enabled on power up. Also, the Private Mode will be enabled if forced operation has been programmed in the radio.

If a group is not programmed for Private Mode operation, **PUT DIS** will be displayed if an attempt is made to enable private transmit mode. It is not possible to operate on this group in Private Mode.

If the radio does not have the correct encryption key loaded, **NO KEY#** will be displayed and the call will not be transmitted.

4. Continue with standard transmission procedures. A Private Mode access tone will be heard when the PTT button is pressed.

10.16.4.3 Scanned Group Calls

Receiving a Scanned Group Call is the same as receiving a selected group call. During the scan hang time, if the radio was programmed for auto-select, it will transmit back in the same mode it received the call. For example, if a clear group is entered in the scan list, it will only receive clear calls. If the same group was available in private and entered in the scan list, it can receive clear and private calls, provided auto-select was programmed in the radio. The user can select transmitting on the scanned or selected group. If a group is entered in the scan list more than once, and in different modes (clear, digital, or private), only the first occurrence of the group will be used.

Table 10-7: Transmit/Receive Mode Compatibility for Digital Voice Operation

GROUP PROGRAMMING (TRANSMIT)	CLEAR RECEIVE	DIGITAL RECEIVE	PRIVATE RECEIVE
CLEAR	Yes	No	No
DIGITAL	Yes	Yes	No
PRIVATE	Yes	No	Yes*

*assumes the proper cryptographic key is loaded



Conventional digital or encrypted channels require Channel Guard on the channel to operate correctly.



The voice coding technology embodied in this product is protected by intellectual property rights including patent rights, copyrights, and trade secrets of Digital Voice Systems, Inc. The user of this technology is explicitly prohibited from attempting to de-compile, reverse engineer, or to disassemble the Object Code, or in any other way convert the Object Code into a human-readable form.

10.17 SCANNING TRUNKED GROUPS

Groups that have been previously added to the scan list on a per system basis may be scanned. Each system's group scan list is retained in memory when the radio is powered OFF or when the battery pack is removed.

10.17.1 Turning Scan On and Off

1. Toggle Scan operation ON by pressing **[SCN]** (P7350 model) or **[3527]** (P7370 model). The icon rotates clockwise to indicate radio is scanning.
2. Toggle Scan operation OFF by again pressing **[SCN]** (P7350 model) or **[3527]** (P7370 model). The will disappear.
 - If the radio scans to a group other than the selected group then receives a call on the selected group, the radio will switch to the selected group. However, if the “scanned-to” group is programmed at a higher priority the radio will remain on the “scanned-to” group.
 - The radio will continue scanning if a new group is selected when scan is ON.
3. Pressing the PTT button when scan is ON will cause the radio to transmit on the displayed group or to the currently selected group (depending on programming).

10.17.2 Adding Groups to a Scan List

P7350 Model Radio

1. Scan must be OFF to add/delete groups to/from the scan list. If the Scan icon is ON, press the **[SCN]** key to turn Scan OFF.
2. Select the desired group using the Voice Group Selection control knob and/or the **[▼]** or **[▲]** keys. If the selected group is currently on the list, pressing **[ADD]** will display on line three.
3. If the scan list status icon is blank (), the group can be added to the scan list by pressing the **[ADD]** key. will be displayed on line three.
4. Press the **[ADD]** key a second time to set the group to Priority 2. A is displayed on line three.

- Press **[ADD]** a third time to set the group to Priority 1. A **[P1]** is displayed on line three. The priority level section sequence only advances the group to the next high priority level and stops at priority level 1. To select a lower priority level, the group must be deleted from the scan list and then added back to the scan list. Each new group added to the scan list starts at the lowest priority. If the Priority 1 and Priority 2 groups are already set and a new group is assigned as Priority 1 or Priority 2, the previously assigned group will change to non-priority scanning. One of the following messages may be momentarily displayed.

SCAN DIS The radio is not programmed to scan.

FIXED P1 A Priority 1 group has been pre-programmed into the radio. A new Priority 1 group cannot be selected.

FIXD LST A fixed scan list has been pre-programmed into the radio. It is not possible to change the list without reprogramming the radio.



NOTE

To quickly view multiple group scan status, press **[ADD]** then slowly but consistently rotate the group knob. Each group status will appear on the display.

P7370 Model Radio

- With scan operation turned OFF, select the desired group to add to the selected trunked system group scan list.
- Press **[6 ADD]**. The current priority status of the group will be displayed in column 10 of line three for a time-out period. If the group is not part of the scan list the status will be blank.
- While the status is displayed, press **[6 ADD]** to add the group to the scan list. **[P1]** is displayed on line three.
- Press **[6 ADD]** a second time to set the group to Priority 2. A **[P2]** is displayed on line three.
- Press **[6 ADD]** a third time to set the group to Priority 1. A **[P1]** is displayed on line three. The priority level selection sequence only advances the group to next higher priority level and stops at priority level 1. To select a lower priority level, the group must be deleted from the scan list and then added back to the scan list. Each new group added to the scan list starts at the lowest priority. If the Priority 1 and Priority 2 groups are already set and a new group is assigned as Priority 1 or Priority 2, the previously assigned group will change to non-priority scanning. One of the following messages may be momentarily displayed.

SCAN DIS The radio is not programmed to scan.

FIXED P1 A Priority 1 group has been pre-programmed into the radio. A new Priority 1 group cannot be selected.

FIXD LST A fixed scan list has been pre-programmed into the radio. It is not possible to change the list without reprogramming the radio.



NOTE

To quickly view multiple group scan status, press either **[6 ADD]** or the **[9 DEL]** key. Then slowly but consistently rotate the group knob. Each group status will appear on the display.

10.17.3 Deleting Groups from a Scan List

P7350 Model Radio

1. With scan operation turned OFF, select the desired group to delete from the selected trunked system group scan list.
2. Press **[A/D]**. The current status of the group is displayed for a time-out period.
3. While the current status is displayed, press **[A/D]** until the group from the scan list is "**blank**." The sequence is "**blank**", **[F1]**, **[F2]**, **[F3]**, "**blank**." Any group that is not in a trunked system group scan list will show a "**blank**" for the time-out period when it is the selected channel.

P7370 Model Radio

1. With scan operation turned OFF, select the desired group to delete from the selected trunked system's group scan list.
2. Press **[9 DEL]**. The current status of the group is displayed for a time-out period.
3. While the status is displayed, press **[9 DEL]** to delete the group from the scan list. **[F1]**, **[F2]**, or **[F3]** turns OFF. Any group that is not in a trunked system group scan list will show a "**blank**" for the time out period when it is the selected channel.

10.17.4 Nuisance Delete

A group can also be deleted from the scan list, if it is not the currently selected group, by pressing the **[A/D]** key (P7350 model) or the **[9 DEL]** key (P7370 model) during scan operation while the radio is displaying the unwanted group. The group will be deleted from the system's group scan list in the same manner as if done using the steps above. Deletions done in this manner will not remain deleted if the radio is powered OFF and then powered ON.

10.18 SCANNING TRUNKED SYSTEMS

The radio can be programmed with the following System Scan features. These features are automatically enabled when the radio is powered ON. A key or menu option is also defined to allow the System Scan features to be toggled during radio operation. The System Scan state will be maintained through system changes but will default to ON when the radio is powered ON.

Enable/Disable via Menu Selection

Press **[M]** and then use the **[▼]** or **[▲]** buttons to scroll through the selections until **SYS SCAN** is displayed. Then press **[M]** to toggle the System Scan state. The **SYSC ON** or **SYSC OFF** display message is displayed for two seconds to show the new state.

Enable/Disable via Pre-Programmed Keypad Key

Press the key pre-programmed to toggle System Scan and the **SYSC ON** or **SYSC OFF** display message is displayed for two seconds to show the new state.

10.18.1 Wide Area System Scanning

The P7300 series radio can be programmed for Wide Area System Scan operation for roaming across mobile systems. Upon the loss of the currently selected system's control channel, radios can be programmed to automatically scan the control channels of other systems. If a new control channel is found, the radio will switch to the new system and sound an alert tone.

10.18.2 Priority System Scan

The radio can also be programmed for Priority System Scan. The priority system is the desired or preferred system. While receiving the control channel of the selected system, the radio will periodically leave the selected system and search for the control channel of the priority system. This is done at a programmable rate defined by the value in the Priority Scan Time control (unless the ProScan™ algorithm is enabled, as explained in the following sections). This priority scan timer is reset each time the PTT button is pressed or when the call is received. If the priority system control channel is found, (or meets the predefined criteria <ProScan>), the radio will automatically switch to the priority system.

10.18.2.1 Enabling the Wide Area System Scan Function

If the radio cannot find the control channel of the selected system and begins to wide area system scan, the radio will only scan for the priority system control channel if the priority system is in the wide area scan list.

10.18.2.2 When ProScan is Enabled

The radio monitors the priority system and will switch to the priority system if the criteria defined by the controls in the ProScan Options dialog box are met. If ProScan is enabled, the rate at which the radio will scan for the priority system is defined by the System Sample Time control, located in the ProScan Options dialog box. See Section 8.20.3 for more information on ProScan.

10.18.3 ProScan

The radio may be programmed for ProScan system scan operation for multi-site applications depending on the version of radio flash code. ProScan is an improved multi-site system scanning algorithm designed to replace ProSound™ scanning. ProScan provides the radio with the ability to select a new system for the radio to communicate on, when the selected system drops below a predefined level. This is accomplished by enabling each radio to analyze the signal quality of its current control channel and compares it with the signal quality of the control channel for each site in its adjacent scan list. (The signal quality metric used for the ProScan algorithm is based on a combination of both **Received Signal Strength Indicator (RSSI)** and **Control Channel Verification (CCV)** measurements.) When the selected system degrades to a pre-programmed level, the radio will begin to look for a better control channel. Once a control channel that exceeds the pre-programmed parameters is found, the radio will change to the new system and emit a tone (if enabled through programming). If the control channel is completely lost, the radio will enter Wide Area System scanning and search the programmed adjacent systems until a suitable control channel is found.

10.19 EMERGENCY OPERATION



The radio's ability to declare an emergency, clear an emergency, remain locked on an emergency system and group, and the emergency audio and display freeze can each be enabled or disabled through programming. When an emergency is declared scanning will stop and restarts only after the emergency has been cleared.



10.19.1 Receiving an Emergency Call

When receiving an Emergency Call on the selected group and system, an alert beep is heard and  is displayed. The message ***RXEMER*** flashes in the display on line two until the emergency condition is cleared.

10.19.2 Declaring an Emergency Call



Perform the following steps to send an emergency call to a selected system and group (or on an optionally pre-programmed group).

1. Press and hold the red EMERGENCY button that is on top of the radio in front of the antenna for approximately one second (this time is programmable and therefore could be longer or shorter; check with the system administrator). The radio will transmit an emergency call request with the radio ID until an emergency channel assignment is received.
2. When the working channel assignment is received, the radio sounds a single beep indicating the radio has auto keyed (see Table 8-4) and is ready for voice transmission. ***TXEMER*** flashes on line two in the display until the emergency is cleared.
3. Press PTT and speak into the microphone in a normal voice.  and  momentarily turn ON.
4. Release PTT when the transmission is complete.

To clear the emergency first press and hold the  button. While continuing to hold the  button, press the EMERGENCY button. (This will work if the radio is programmed to clear emergencies.)

10.20 INDIVIDUAL CALLS

10.20.1 Receiving and Responding to an Individual Call

When the radio receives an individual call (a call directed only to the user's radio), it un-mutes on the assigned working channel and displays . The first line on the display shows the logical ID number of the unit sending the message, or the associated name if the ID number is found in the individual call list. The radio can be programmed to ring when an individual call is received. If enabled, the ring begins five seconds after the caller un-keys and will continue until the PTT button, the  button or the individual call mode is entered.



NOTE

The volume of the ring is adjustable through the volume control levels.

If a response is made by pressing the PTT to the call prior to the programmed call-back time-out, the call will automatically be directed to the originating unit. If a response is not made before the call-back time-out, the radio will return to normal receive display, and ***WHC*** will appear on the first line of the LCD.

To respond after the call-back time-out, press the  key. The radio's display will show the callers ID on the first line and **WHCI=1** on the second line. Pressing the PTT button at this point will initiate an individual call back to the original caller.

The radio stores the IDs of the last 10 callers in the Calls Received List as shown. Individual calls are stored in the top half of the list (1-10) and Group calls are stored in the bottom half of the list (1-10). The most recent call is stored in position 1, the second most recent call is stored in position 2, etc.

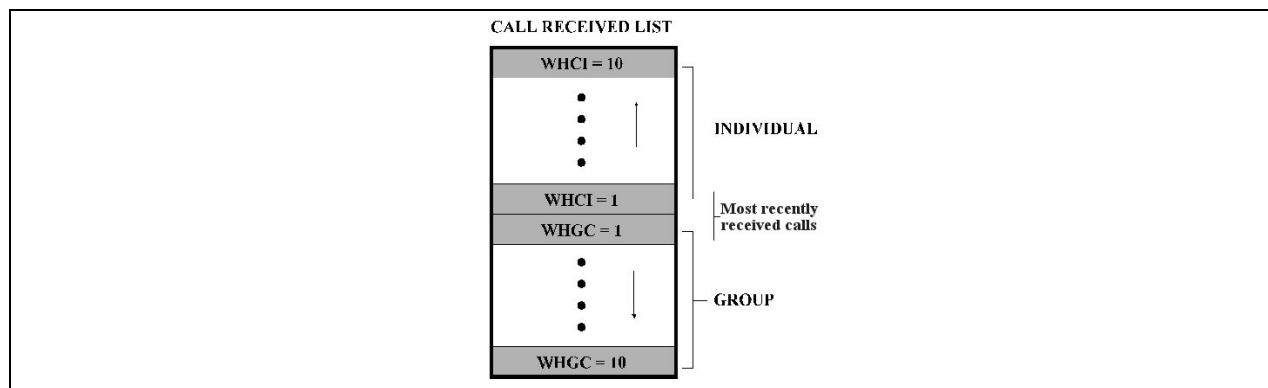

Figure 10-13: Calls Received Lists

To access the Calls Received List, press the $\#$ key twice. Use the \downarrow or \uparrow buttons to scroll through the list. Pressing the M key will display the time elapsed since the call was received. After pressing $\#$ the display will appear similar to Figure 10-14.

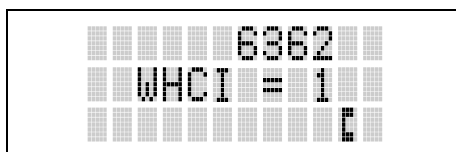

Figure 10-14: WHC Individual Call Display

Pressing the PTT will initiate an individual call to the displayed logical ID. Powering the radio OFF and ON will clear this list.

10.20.2 Sending an Individual Call

10.20.2.1 Pre-Stored Individual Calls



The following procedures describe how to initiate and complete a Pre-Stored Individual Call.

P7370 Model Radio



1. To select a pre-stored individual phone number, enter the individual call mode using the $\#$ key. $\#$ is displayed. Then scroll through the list of stored numbers using the \downarrow or \uparrow keys.
2. Press the PTT button; when the radio is clear to transmit, $\#$ turns ON, $\#$ turns OFF and the channel access tone sounds. Line one shows the called individual's name if found in the list of stored individuals or **LID** followed by the logical ID number of the unit being called. The message ***INDU*** displays on line two.

P7350 Model Radio



1. To select a pre-stored individual number, enter the menu mode by pressing the M key. Scroll through the mode list using the \downarrow or \uparrow buttons.
2. Press M . $\#$ is displayed. Scroll through the list of stored phone numbers using the \downarrow or \uparrow buttons until the desired number is displayed. Press M .

- Press the PTT button; when the radio is clear to transmit  turns ON,  turns OFF and the channel access tone sounds. Line one shows the called individual's name or LID. The message ***INDU*** displays on line two.

10.20.2.2 Direct Dial Individual Calls (P7370 Model Only)

- The following procedure describes how to initiate and complete a Direct Dial Individual Call.
- The individual call ID is not stored in the pre-stored list of call IDs but the individual unit ID is known, it can be entered directly from the keypad.
- Press and hold the PTT button to transmit.  will turn ON,  will turn OFF, and the channel access tone will sound. Line one shows the called individual's ID followed by the logical ID number of the unit being called. The message ***INDU*** displays on line two. Proceed talking into the microphone.

10.20.3 Call Storage Lists

There are two lists available for call storage in the P7300 series radios, the **calls received** list (1 - 10) and the **personality** list (1 - 99 as defined by the user). When the individual call mode is entered by pressing , the **calls received** list is available. The user can toggle to the personality list by selecting any index other than 0 or toggle between the two lists by pressing the  key. If wrap is enabled, the **calls received** list wraps on itself and not into the other list.

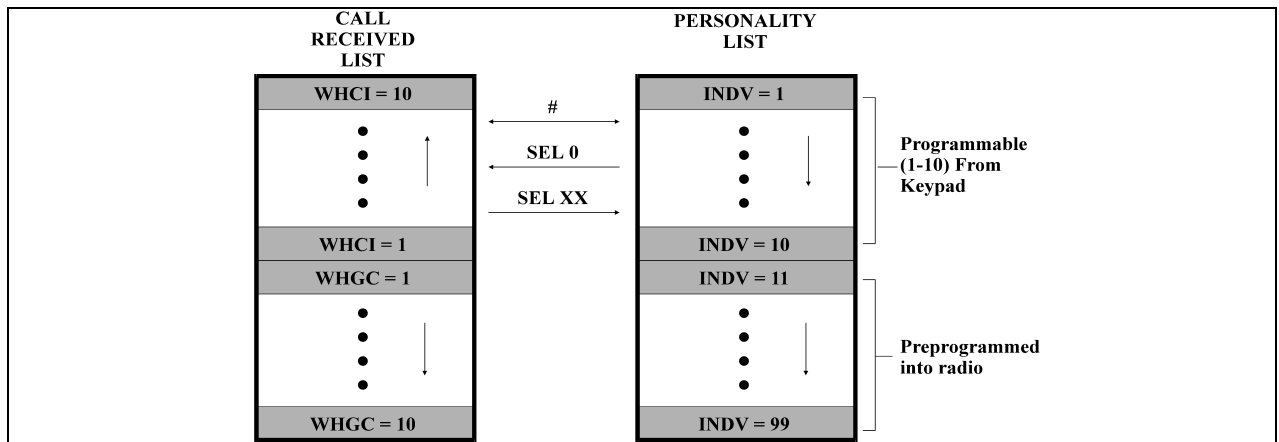





Figure 10-15: Calls Received and Personality Lists

The saved call list shows all ten storage locations. If no calls have been received, the saved call list will be empty and the pre-stored list will be available upon entering the individual call mode.

When in the saved call list, pressing the  key toggles the time stamp ON and OFF. The time stamp indicates how long ago the call was received. When in the pre-stored list pressing the  key toggles the Logical *ID*entification (*LID*) ON and OFF.

10.21 TELEPHONE INTERCONNECT CALLS













10.21.1 Receiving a Telephone Interconnect Call

When the radio receives a telephone interconnect call (a call directed only to the user's radio), it un-mutes on the assigned working channel and displays . The first line displays ***PHONE***. The second line displays ***INDU***. Proceed with the call. Press the PTT to talk, release the PTT to listen.

10.21.2 Sending a Telephone Interconnect Call

10.21.2.1 Pre-Stored Number

Use the following procedures to initiate and complete a Telephone Interconnect call.

1. **P7370 Model:** To select a previously stored phone number, press the  key. Use the  or  buttons to scroll through the list of stored numbers.
P7350 Model: To select a previously stored phone number, press the  key. Use the  or  buttons to select the menu option **PHN CALL**. Press the  key again then use the  or  buttons to scroll through the list of pre-stored numbers.
2. Press and release the PTT button. When the radio is clear to transmit,  turns ON,  turns OFF and the channel access tone sounds. Line one shows the accompanying name selected from the list of stored numbers. The message ***PHONE*** appears on line two of the display. The radio then automatically transmits the programmed number stored in the special call queue.
3. A telephone ring will be heard from the speaker. When someone answers the phone, press the PTT button and speak into the microphone. Release the PTT button to listen to the callee. Unsuccessful interconnect signaling returns the radio to the normal receive mode and the number remains displayed until the special call is cleared or the time-out expires or another group or system is selected. Terminate a call by pressing the  button.



NOTE

In half-duplex mode, only one person may talk at a time. The radio PTT button needs to be pressed in order to communicate to the individual called and released for the individual called to be heard.

10.21.2.2 Direct Dialing of Phone Calls (P7370 Model Only)

1. If the phone number is not stored in the pre-stored list of phone numbers, but the phone number is known, it can be entered directly from the keypad. Start by pressing the  key, then enter the required number from the keypad. Press and release the PTT button.



NOTE

The last number directly entered can be recalled by first pressing  then pressing the PTT button.

2. A telephone ring can be heard from the speaker. When someone answers the phone, press and hold the PTT button and speak into the microphone. Release the PTT button to listen to the individual called. Unsuccessful interconnect signaling returns the radio to the normal receive mode and the number remains displayed until the special call is cleared or the time-out expires or another group or system is selected.
3. To terminate the call, momentarily press the  button.

10.21.3 Dual-Tone Multi-Frequency: Overdial/Conventional Mode

Once the radio has established a connection to the public telephone system, it may be necessary to “overdial” more digits to access banking services, answering machines, credit card calls, or other types of systems that require Dual-Tone Multi-Frequency (DTMF) access digits.

Overdial operation can also be used to initiate a telephone interconnect call via DTMF signaling if a dial tone has already been accessed on the system. This method makes a telephone interconnect call while operating in the conventional mode but will also function in trunked mode if a dial tone is directly accessible.

Telephone numbers and other number sequences for overdialing can be stored in the phone list when programming the radio. These numbers are accessed by pressing the **[M]** key, then following the selection mode rules. Perform the following procedures to access and dial these stored numbers.

P7350 Model Radio

1. Follow the procedure in Section 10.21.3 to establish a connection to the telephone system or consult the system administrator for the procedure to access a dial tone on the trunked or conventional system.
2. Enter selection mode first to enable entry of Overdial numbers by pressing the **[M]** button.
3. Follow the selection mode rules to call up a stored number from the phone list: Use the **[▼]** or **[▲]** buttons to scroll through the list of stored numbers. **[M]** is displayed. Press the PTT to send the overdial sequence once. If the number needs to be transmitted again it must be selected or entered again (this prevents unwanted numbers from being sent the next time the PTT button is pressed during the call).

Overdial select/entry mode remains active until the call is dropped, cleared, or **[M]** is pressed. The overdial select/entry mode can be re-entered if the call is still active by pressing **[M]**.

P7370 Model Radio

1. Follow the procedure in Section 8.23.2 to establish a connection to the telephone system or consult the system administrator for the procedure to access a dial tone on the trunked or conventional system.
2. Overdial numbers are transmitted using one of the following methods:

- METHOD 1:
1. Enter the overdial selection mode by pressing the **[* PTT]** button.
 2. Use the **[▼]** or **[▲]** buttons to scroll through the list of stored numbers. **[M]** is displayed. Press the PTT to send the overdial sequence once. If the number needs to be transmitted again it must be selected or entered again (this prevents unwanted numbers from being sent the next time the PTT button is pressed during the call).

Overdial select/entry mode remains active until the call is dropped, cleared, or **[M]** is pressed. The overdial select/entry mode can be re-entered if the call is still active by pressing **[M]**.

METHOD 2: (P7370 model radios only)

1. Enter the overdial selection mode by pressing the button.
2. Press and hold the PTT button while entering the overdial number sequence from the keypad. This method sends DTMF tones during individual, telephone interconnect, trunked group, or conventional channel calls. Press the PTT to send the overdial sequence once. If the number needs to be transmitted again it must be selected or entered again (this prevents unwanted numbers from being sent the next time the PTT button is pressed during the call). *Note: Anytime the PTT button is pressed and held, the keypad is enabled for DTMF entry.*

Overdial select/entry mode remains active until the call is dropped, cleared, or is pressed. The overdial select/entry mode can be re-entered if the call is still active by pressing .

This overdial select/entry mode remains active until dropped, cleared, or is pressed. The overdial select/entry mode can be re-entered if the call is still active by pressing the button.

10.22 PROGRAMMABLE ENTRIES

10.22.1 Pre-Storing Individual and Telephone Interconnect Calls from the Keypad

Individual Call ID numbers, telephone numbers, and other number sequences for overdialing are stored in the special calls lists when programming the radio. The first ten entry locations of these lists can be changed by the radio operator. The keypad is used when adding, changing, and storing numbers in these entry locations.

Use the following procedure to store a number in one of the first ten entries of a special call list:

1. Press the or button to enter the individual call list or the phone call list. is displayed.
2. Scroll through the list using the or keys until one of the first ten entries is reached. **NO ENTRY** is displayed if the location is empty.
3. Enter the desired number. If necessary, a pause can be entered by pressing and holding 0-9, , or until an underscore appears in the display (telephone interconnect only). The individual call list entries will accept up to 5 digits. The phone call list entries accept a combination of up to 31 digits and pauses.
4. Press and hold the key until the display changes indicating that the number has been stored.

Repeat steps 1-4 to store additional numbers, to change numbers already stored, or to change the storage location of a number.

10.23 STATUS/MESSAGE OPERATION

The **Status** and **Message** operations allow for the transmission of a *pre-programmed status* or a *pre-programmed message* to an EDACS site. Each Status and Message is assigned an ID then cross-referenced with the representative status condition (“Off Duty,” for example) or a message (“Call home”). In addition, Status conditions can also be associated with a programmable Menu entry (required for second method of transmitting a Status condition (see Section 8.25.1).

10.23.1 Status Operation

P7370 Model Radio

One of two methods can be used to transmit a status condition.

- METHOD 1:
1. Press the **[M]** key, then use the **[▼]** or **[▲]** buttons to scroll to the pre-programmed status condition. STATUS and 0 through 9 pre-programmed status selections are available from the menu.
 2. If STATUS is selected, you need to enter the number of the status condition you intend to transmit. If no status has been programmed for the selected number key, the radio will display **NO ENTRY**. A valid selection will display the status for a pre-programmed time.

After the time-out expires or the **[M]** key has been pressed (the **[M]** key will override the time-out period), the status is selected and will be transmitted to the site or stored in the radio memory where it can be polled by the site at a future time.

- METHOD 2:
1. Press the **[7/STATUS]** key.
 2. Press the corresponding pre-programmed 0 through 9 status condition key. If no status has been programmed for the selected number key, the radio will display **NO ENTRY**. A valid selection will permit the status condition to appear in the top line of the display and the status ID to appear in the second line of the display for a pre-programmed time.

After the time-out expires or the **[M]** key has been pressed (the **[M]** key will override the time-out period), the status is selected and will be transmitted to the site or stored in the radio memory where it can be polled by the site at a future time.

View the currently selected status after it has been transmitted by pressing the **[M]** key and then the **[M]** key and then the **[⊙]** button prior to the time-out period. If the status was not sent successfully to the site, the text associated with the status condition will flash in the display.

The status selection can be changed by pressing a different status key 0 through 9, or the status operation can be cancelled by pressing Option Button 2 **[⊙]**. Both operations must be carried out prior to the time-out period.

10.23.2 Message Operation

The following method can be used to transmit a Message using the Message Operation.

1. Press the **[8/MSG]** key.
2. Press the corresponding pre-programmed 0 through 9 pre-programmed “message” key. If no message has been programmed for the selected number key, the radio will display **NO ENTRY**. A valid selection will permit the message to appear in the top line of the display and the message ID to appear in the second line of the display for a pre-programmed time.

The message selection can be changed by pressing a different message key 0 through 9, or the message operation can be cancelled by pressing Option Button 2 **[⊙]**. Both operations must be carried out prior to the pre-programmed time-out period.

10.24 MACRO KEY OPERATION

Macro key operation permits the user to accomplish a series of keystrokes with a single "macro" keystroke. Each Macro Key is capable of executing up to twenty (20) keystrokes, to any push button input (i.e., keypad keys, OPTION buttons, etc.). Each macro key can be pre-programmed to activate when pressed or when released.

A macro key may also be pre-programmed to change the key stroke sequence the next time the macro key is activated.

For detailed operation and assignment of macro keys, contact your communications supervisor or administrator.

10.25 PORTABLE DATA

The P7300 series portable radios, when operating in the EDACS Trunked configuration, permit both voice and data calls to be transmitted and received. The radio can handle only one type of call at a time; however, either data or voice is selected transparently by the operator through normal usage of the radio. Data communications is not supported in conventional mode.

The radios can be connected to a Mobile Data Terminal (MDT) or to a host computer. Any RS-232 compatible device that supports the Radio Data Interface (RDI) protocol (Version 1.91 or greater) may be connected to the radio. Support for MDTs or host computers is a programmable option per radio. Additionally, radios may also be programmed for data only operation (no voice calls transmitted or received).

10.25.1 Displays

The following will be displayed during the various states of data mode of operation:

TX DATA Appears on top line of display when the radio is transmitting a data call.

RX DATA Appears on top line of display when the radio is receiving a data call.

DATA OFF Appears on top line of display when the radio is in the data disabled state.

DATA ON Appears for two seconds on top line of display when the radio is toggled to the data enabled state.

10.25.2 DATA OFF Operation

The radio can be placed in the data disabled state by any of the following methods. When the data state is disabled, **DATA OFF** appears on the top line of the display.

- Declaring an emergency (not to be used unless an actual emergency condition exists). Alert tone will sound.
- Pressing Option Button 1 \bigcirc (if pre-programmed as "no data" key). Alert tone will sound.
- Pressing the pre-programmed "no data" (ND) key. Refer to previous bullet.

10.25.3 DATA ON Operation

The data state is enabled by one of the following (depending on how it was disabled). **DATA ON** will appear on the top line in the display for two seconds then the display will return to normal.

- Pressing the pre-programmed "no data" (ND) key toggles data state ON or OFF.
- Clearing an emergency. *This is valid only if the emergency caused "DATA OFF" operation.*



10.25.4 Exiting Data Calls

Under normal conditions, the radio enters the scan lockout mode and returns to the control channel after completion of a data call (transmit or receive). If, during a data call, one of the following operations occurs, the data call is immediately terminated and the radio performs the desired function:

- If the PTT is activated.
- If an Emergency is declared by pressing the pre-programmed emergency button.
- If a group or system is changed.

10.25.5 Scan Lockout Mode

Following the transmission or reception of a data call, if scan is enabled, scanning will stop temporarily. There are two independent pre-programmed times associated with this mode; one after a received data call and one after a transmitted data call. During this time the scan indicator will flash to indicate that scan is enabled but temporarily suspended. This condition typically returns to normal scan operation when the pre-programmed time expires; however, the following operations and conditions will terminate the scan lockout mode before the timeout has expired.

- Press the  button.
- Press the PTT.
- Change a group or system.
- Enter Telephone Interconnect mode.
- Enter Individual call mode.
- Receive a new emergency assignment.
- Declare or clear an emergency.
- Receive an individual or phone call.
- Receive an Agency, Fleet, or System All Call.
- Press  (P7350 model) or  (P7370 model) to toggle Scan ON or OFF.

10.25.6 Data Lockout Mode

During the voice call scan hang time (pre-programmed) the radio will not receive data calls.

10.26 GROUP CALLS IN P25 MODE

10.26.1 Transmitting a Group Call

1. Select the desired P25 system. (P25 icon will appear in display.)
2. Select the Talk Group/Conventional Channel. (Selected simultaneously using either the Voice Group Selection control knob or the group key.)
3. Press and hold the PTT.
4. When a grant tone is received (if enabled through programming) speak into the microphone.
5. Release PTT and wait for response.

10.26.2 Receiving a Group Call

1. The radio will unmute according to the squelch mode defined in the radio personality (monitor, normal, selective).
2. Select the desired P25 system and Talk Group/Channel or turn scan on and make sure the desired channel is in the scan list.
3. When the radio receives a P25 call, the radio will unmute and the channel name will appear in the display.
4. Press the PTT button to respond.

10.27 INDIVIDUAL CALLS IN P25 MODE

10.27.1 Transmitting an Individual Call

1. Select the desired P25 system. (The P25 icon will appear in the display.)
2. Select the radio unit to call (callee source ID) from the pre-programmed individual call list or enter the ID number on the radio keypad.
3. Press and hold the PTT.
4. When grant tone is received (if enabled through programming) speak into the microphone.
5. Release the PTT.

10.27.2 Receiving an Individual Call

1. The radio will unmute according to the squelch mode defined in the radio personality (monitor, normal, selective).
2. Select the desired P25 system and Talk Group/Channel or turn scan on and make sure the desired channel is in the scan list.
3. When the radio receives a P25 call, the radio will unmute and the ID of the transmitting radio will appear in the display.
4. Press the PTT button to respond.
5. Unanswered calls will appear in the Who Has Called (WHC) list.

10.28 EMERGENCY GROUP CALLS IN P25 MODE



There is no method available for a system-wide Emergency clear. An emergency group call must be cleared on each individual radio.

10.28.1 Declaring an Emergency Group Call

1. Select the desired P25 system and Talk Group/Channel.
2. Press the red emergency button on the top of the radio. The radio will broadcast a short emergency transmission with the emergency bit set. “TXEMER” will appear in the display of the transmitting radio.

3. While the PTT is NOT pressed, the mic will be open and the radio will broadcast an approximately 2 second transmission (e.g., background noise) which will be repeated at 10-30 second intervals.
4. Press the PTT to stop the short transmissions.
5. To send a voice message, press the PTT and speak into the microphone.
6. To clear an emergency from the transmitting radio, perform one of the following steps:
 - Change systems.
 - Change channels (if not prohibited by programming).
 - Cycle power by turning radio off and then back on.
 - Press the Clear and Emergency buttons simultaneously, providing the Clear Emergency option is enabled in the Supervisory Options in the personality.

10.28.2 Receiving an Emergency Group Call

1. Select the desired P25 System and Talk Group/Channel.
2. When the radio detects an incoming Emergency Group Call, the radio will sound an alert tone and “RXEMER” will appear in the display.
3. Voice or emergency transmissions will be heard at the receiving radio.
4. To clear an emergency from the receiving radio, perform one of the following steps:
 - Change systems.
 - Change channels (if not prohibited by programming).
 - Cycle power by turning radio off and then back on.
 - Press the Clear and Emergency buttons simultaneously, providing the Clear Emergency option is enabled in the Supervisory Options in the personality.

This page intentionally left blank

***TECHNICAL ASSISTANCE
AND
WARRANTY INFORMATION***

11 TECHNICAL ASSISTANCE

The Technical Assistance Center's (TAC) resources are available to help with overall system operation, maintenance, upgrades and product support. TAC is the point of contact when answers are needed to technical questions.

Product specialists, with detailed knowledge of product operation, maintenance and repair provide technical support via a toll-free (in North America) telephone number. Support is also available through mail, fax and e-mail.

For more information about technical assistance services, contact your sales representative, or call the Technical Assistance Center at:

North America: 1-800-528-7711

International: 1-434-385-2400

Fax: 1-434-455-6712

E-mail: tac@tycoelectronics.com

12 BASIC TROUBLESHOOTING

Use Table 12-1 as a troubleshooting guide if the radio is not functioning properly. If additional assistance is required, contact a qualified service technician or call M/A-COM at 1-800-528-7711.

Table 12-1: Troubleshooting

SYMPTOM	POSSIBLE CAUSE	POSSIBLE SOLUTION
Radio will not turn on	Low battery charge	Change the battery pack to a fully charged pack.
No Audio	Speaker volume is muted.	Increase the volume level.
Poor Audio	User is in a poor coverage area or not on the network.	Move to a better coverage area.
Radio powers off for no apparent reason.	Radio may be experiencing very low voltage.	Have the battery checked by an authorized technician.
Radio will not transmit.	Radio may be out of coverage area or may be overheated.	Return to coverage area if possible. If overheated, let radio cool before retrying transmission. Report this failure to an authorized technician.

BATTERY WARRANTY

- A. M/A-COM, Inc. (hereinafter "Seller") warrants to the original purchaser for use (hereinafter "Buyer") that nickel-cadmium and nickel-metal hydride batteries supplied by Seller shall be free from defects in material and workmanship, and shall conform to its published specifications for a period of twelve (12) months from the date of purchase.
- B. For purposes of this warranty, batteries shall be deemed defective if (1) the battery capacity is less than 80% rated capacity, or (2) the battery develops leakage.
- C. If any battery fails to meet the foregoing warranty, Seller shall correct the failure by issuing a replacement battery upon receipt of the defective battery at an Authorized Service Center (ASC) or M/A-COM factory (for OpenSky® Equipment only).
- D. Replacement batteries shall be warranted only for the remaining unexpired warranty period of the original battery. This warranty becomes void if:
 - 1. The battery has been subjected to any kind of misuse, detrimental exposure, or has been involved in an accident.
 - 2. The battery is used in equipment or service other than the radio equipment for which it is specified.
- E. The preceding paragraphs set forth the exclusive remedies for claims based upon defects in or non-conformity of any battery, whether the claim is in contract, warranty, tort (including negligence), strict liability or otherwise, and however instituted. Upon the expiration of the warranty period, all such liability shall terminate. The foregoing warranties are exclusive and in lieu of all other warranties, whether oral, written, expressed, implied or statutory. **NO IMPLIED OR STATUTORY WARRANTIES OF MERCHANTABILITY OR FITNESS FOR PARTICULAR PURPOSE SHALL APPLY. IN NO EVENT SHALL THE COMPANY BE LIABLE FOR ANY INCIDENTAL, CONSEQUENTIAL, SPECIAL, INDIRECT OR EXEMPLARY DAMAGES.**

This warranty applies only within the United States.

M/A-COM, Inc.
1011 Pawtucket Blvd.
Lowell, MA 01853
1-877-OPENSKY

M/A-COM, Inc.
221 Jefferson Ridge Parkway
Lynchburg, VA 24501
1-800-528-7711

ECR-7048B

WARRANTY

- A. M/A-COM, Inc. (hereinafter "Seller") warrants to the original purchaser for use (hereinafter "Buyer") that Equipment manufactured by or for the Seller shall be free from defects in material and workmanship, and shall conform to its published specifications. With respect to all non-M/A-COM Equipment, Seller gives no warranty, and only the warranty, if any, given by the manufacturer shall apply. Rechargeable batteries are excluded from this warranty but are warranted under a separate Rechargeable Battery Warranty (ECR-7048).
- B. Seller's obligations set forth in Paragraph C below shall apply only to failures to meet the above warranties occurring within the following periods of time from date of sale to the Buyer and are conditioned on Buyer's giving written notice to Seller within thirty (30) days of such occurrence:
1. for fuses and non-rechargeable batteries, operable on arrival only.
 2. for parts and accessories (except as noted in B.1) sold by Seller's Service Parts Operation, ninety (90) days.
 3. for P7200, P7100^{IP}, P7300, P5300, P5200, P5100, PANTHER™ 405P and 605P, M7300, M7200 (including V-TAC), M7100^{IP} and M5300 radios, two (2) years.
 4. for all other equipment of Seller's manufacture, one (1) year.
- C. If any Equipment fails to meet the foregoing warranties, Seller shall correct the failure at its option (i) by repairing any defective or damaged part or parts thereof, (ii) by making available at Seller's factory any necessary repaired or replacement parts, or (iii) by replacing the failed Equipment with equivalent new or refurbished Equipment. Any repaired or replacement part furnished hereunder shall be warranted for the remainder of the warranty period of the Equipment in which it is installed. Where such failure cannot be corrected by Seller's reasonable efforts, the parties will negotiate an equitable adjustment in price. Labor to perform warranty service will be provided at no charge during the warranty period only for the Equipment covered under Paragraph B.3 and B.4. To be eligible for no-charge labor, service must be performed at a M/A-COM factory, by an Authorized Service Center (ASC) or other Servicer approved for these purposes either at its place of business during normal business hours, for mobile or personal equipment, or at the Buyer's location, for fixed location equipment. Service on fixed location equipment more than thirty (30) miles from the Service Center or other approved Servicer's place of business will include a charge for transportation.
- D. Seller's obligations under Paragraph C shall not apply to any Equipment, or part thereof, which (i) has been modified or otherwise altered other than pursuant to Seller's written instructions or written approval or, (ii) is normally consumed in operation or, (iii) has a normal life inherently shorter than the warranty periods specified in Paragraph B, or (iv) is not properly stored, installed, used, maintained or repaired, or, (v) has been subjected to any other kind of misuse or detrimental exposure, or has been involved in an accident.
- E. The preceding paragraphs set forth the exclusive remedies for claims based upon defects in or nonconformity of the Equipment, whether the claim is in contract, warranty, tort (including negligence), strict liability or otherwise, and however instituted. Upon the expiration of the warranty period, all such liability shall terminate. The foregoing warranties are exclusive and in lieu of all other warranties, whether oral, written, expressed, implied or statutory. NO IMPLIED OR STATUTORY WARRANTIES OF MERCHANTABILITY OR FITNESS FOR PARTICULAR PURPOSE SHALL APPLY. IN NO EVENT SHALL THE SELLER BE LIABLE FOR ANY INCIDENTAL, CONSEQUENTIAL, SPECIAL, INDIRECT OR EXEMPLARY DAMAGES.

This warranty applies only within the United States.

M/A-COM, Inc.
1011 Pawtucket Blvd.
Lowell, MA 01853
1-877-OPENSKY

M/A-COM, Inc.
221 Jefferson Ridge Parkway
Lynchburg, VA 24501
1-800-528-7711

ECR-7047D

P7300 Product Safety Manual

MM-013995-001
Oct/08



This booklet contains important safety information regarding specific absorption rate (SAR) and RF exposure limits included in United States and international standards. Read the information in this booklet before operating your radio.



P7300 Series Portable Radios

 **Tyco Electronics**
Our commitment. Your advantage.

MANUAL REVISION HISTORY

REV	DATE	DESCRIPTION
-	Oct/08	Initial release

Tyco Electronics Technical Publications would particularly appreciate feedback on any errors found in this document and suggestions on how the document could be improved. Submit your comments and suggestions to:

Tyco Electronics Wireless Systems

Technical Publications
221 Jefferson Ridge Parkway
Lynchburg, VA 24501

or: fax your comments to: 1-434-455-6851
e-mail us at: techpubs@tycoelectronics.com

ACKNOWLEDGEMENTS

The software contained in this device is copyrighted by M/A-COM, Inc. Unpublished rights are reserved under the copyright laws of the United States.

This device is made under license under one or more of the following U.S. Patents: 4,590,473; 4,636,791; 5,148,482; 5,185,796; 5,271,017; 5,377,229; 4,716,407; 4,972,460; 5,502,767; 5,146,497; 5,164,986; 5,185,795.

CREDITS

OpenSky is a registered trademark of M/A-COM, Inc.

RBRC and 1-800-8-BATTERY are registered trademarks of Rechargeable Battery Recycling Corporation.

All other product and brand names are trademarks, registered trademarks, or service marks of their respective holders.

NOTICE



This product conforms to the European Union WEEE Directive 2002/96/EC. Do not dispose of this product in a public landfill. This product should be taken to a recycling center at the end of its life.

The voice coding technology embodied in this product is protected by intellectual property rights including patent rights, copyrights, and trade secrets of Digital Voice Systems, Inc. The user of this technology is explicitly prohibited from attempting to decompile, reverse engineer, or disassemble the Object Code, or in any other way convert the Object Code into human-readable form.

Repairs to this equipment should be made only by an authorized service technician or facility designated by the supplier. Any repairs, alterations, or substitution of recommended parts made by the user to this equipment not approved by the manufacturer could void the user's authority to operate the equipment in addition to the manufacturer's warranty.

This manual is published by **M/A-COM, Inc.**, without any warranty. Improvements and changes to this manual necessitated by typographical errors, inaccuracies of current information, or improvements to programs and/or equipment, may be made by **M/A-COM, Inc.**, at any time and without notice. Such changes will be incorporated into new editions of this manual. No part of this manual may be reproduced or transmitted in any form or by any means, electronic or mechanical, including photocopying and recording, for any purpose, without the express written permission of **M/A-COM, Inc.**

TABLE OF CONTENTS

	<i>Page</i>
1	SAFETY SYMBOL CONVENTIONS 4
2	SAFETY TRAINING INFORMATION 5
2.1	RF EXPOSURE GUIDELINES..... 5
2.2	ELECTROMAGNETIC INTERFERENCE/ COMPATIBILITY 6
3	OPERATING TIPS..... 6
3.1	EFFICIENT RADIO OPERATION..... 7
4	OPTIONS AND ACCESSORIES 9
5	BATTERY PACKS 9
5.1	CONDITIONING NIMH BATTERY PACKS 9
5.2	CONDITIONING NICD BATTERY PACKS..... 10
5.3	CONDITIONING LI-ION BATTERY PACKS 10
5.4	ADDITIONAL INFORMATION 10
5.5	BATTERY DISPOSAL 11
6	TECHNICAL ASSISTANCE..... 11
7	BATTERY WARRANTY..... 12
8	WARRANTY..... 13

1 SAFETY SYMBOL CONVENTIONS

The following conventions are used to alert the user to general safety precautions that must be observed during all phases of operation, service, and repair of this product. Failure to comply with these precautions or with specific warnings elsewhere violates safety standards of design, manufacture, and intended use of the product. M/A-COM, Inc. assumes no liability for the customer's failure to comply with these standards.



The **WARNING** symbol calls attention to a procedure, practice, or the like, which, if not correctly performed or adhered to, could result in personal injury. Do not proceed beyond a **WARNING** symbol until the conditions identified are fully understood or met.



The **CAUTION** symbol calls attention to an operating procedure, practice, or the like, which, if not performed correctly or adhered to, could result in a risk of danger, damage to the equipment, or severely degrade the equipment performance.



The **NOTE** symbol calls attention to supplemental information, which may improve system performance or clarify a process or procedure.



The **ESD** symbol calls attention to procedures, practices, or the like, which could expose equipment to the effects of **E**lectro-**S**tatic **D**ischarge. Proper precautions must be taken to prevent ESD when handling circuit modules.

2 SAFETY TRAINING INFORMATION



The M/A-COM P7300 portable radio generates RF electromagnetic energy during transmit mode. This radio is designed for and classified as “Occupational Use Only,” meaning it must be used only during the course of employment by individuals aware of the hazards and the ways to minimize such hazards. This radio is NOT intended for use by the “General Population” in an uncontrolled environment.

The P7300 portable radio has been tested and complies with the FCC RF exposure limits for “Occupational Use Only.” In addition, this M/A-COM radio complies with the following Standards and Guidelines with regard to RF energy and electromagnetic energy levels and evaluation of such levels for exposure to humans:

- FCC OET Bulletin 65 Edition 97-01 Supplement C, Evaluating Compliance with FCC Guidelines for Human Exposure to Radio Frequency Electromagnetic Fields.
- American National Standards Institute (C95.1 – 1992), IEEE Standard for Safety Levels with Respect to Human Exposure to Radio Frequency Electromagnetic Fields, 3 kHz to 300 GHz.
- American National Standards Institute (C95.3 – 1992), IEEE Recommended Practice for the Measurement of Potentially Hazardous Electromagnetic Fields – RF and Microwave.

2.1 RF EXPOSURE GUIDELINES



To ensure that exposure to RF electromagnetic energy is within the FCC allowable limits for occupational use, always adhere to the following guidelines:

- DO NOT operate the radio without a proper antenna attached, as this may damage the radio and may also cause the FCC RF exposure limits to be exceeded. A proper antenna is the antenna supplied with this radio by M/A-COM or an antenna specifically authorized by M/A-COM for use with this radio.
- DO NOT transmit for more than 50% of total radio use time (“50% duty cycle”). Transmitting more than 50% of the time can cause FCC RF exposure compliance requirements to be exceeded. The radio is transmitting when the “TX” indicator appears in the display. The radio will transmit by pressing the “PTT” (Push-To-Talk) button.

- Always transmit using low power when possible. In addition to conserving battery charge, low power can reduce RF exposure.
- ALWAYS use M/A-COM authorized accessories (antennas, batteries, belt clips, speaker/mics, etc). Use of unauthorized accessories may cause the FCC Occupational/Controlled Exposure RF compliance requirements to be exceeded.
- As noted in Table 2-1, ALWAYS keep the device and its antenna **AT LEAST** 1.1 cm (0.43 inches) from the body and at least 2.5 cm (1.00 inch) from the face when transmitting to ensure FCC RF exposure compliance requirements are not exceeded. However, to provide the best sound quality to the recipients of your transmission, M/A-COM recommends you hold the microphone at least 5 cm (2 inches) from your mouth, and slightly off to one side.

Table 2-1: RF Exposure Compliance Tested Distances

RADIO FREQUENCY BAND	TESTED DISTANCES (worst case scenario)	
	Body	Face
UHF T-Band (450 – 512 MHz)	1.1 cm	2.5 cm

The information in this section provides the information needed to make the user aware of a RF exposure, and what to do to assure that this radio operates within the FCC RF exposure limits of this radio.

2.2 ELECTROMAGNETIC INTERFERENCE/COMPATIBILITY

During transmissions, M/A-COM radios generate RF energy that can possibly cause interference with other devices or systems. To avoid such interference, turn off the radios in areas where signs are posted to do so. DO NOT operate the transmitter in areas that are sensitive to electromagnetic radiation such as hospitals, aircraft, and blasting sites.

3 OPERATING TIPS

Antenna location and condition are important when operating a portable radio. Operating the radio in low lying areas or terrain, under power lines or bridges, inside of a vehicle or in a metal framed building can severely reduce the range of the unit. Mountains can also reduce the range of the unit.

In areas where transmission or reception is poor, some improvement may be obtained by ensuring the antenna is vertical. Moving a few yards in another direction or moving to a higher elevation may also improve communications.

Vehicular operation can be aided with the use of an externally mounted antenna.

Battery condition is another important factor in the trouble free operation of a portable radio. Always properly charge the batteries.

3.1 EFFICIENT RADIO OPERATION

For optimum audio clarity at the receiving radio, hold the portable radio approximately three inches from your mouth and speak into the microphone at a normal voice level.

Keep the antenna in a vertical position when receiving or transmitting a message.



Do NOT hold onto the antenna when the radio is powered on.

3.1.1 Antenna Care and Replacement



Always keep the antenna at least 0.43 inches (1.1 cm) away from the body and 1.0 inch (2.5 cm) from the face when transmitting to ensure FCC RF exposure compliance requirements are not exceeded.



Do not use the portable radio with a damaged or missing antenna. A minor burn may result if skin comes into contact with a damaged antenna. Replace a damaged antenna immediately. Operating a portable radio with the antenna missing could cause personal injury, damage the radio, and may violate FCC regulations.



Use only supplied or approved antennas. Use of unauthorized antennas, modifications or attachments could cause damage to the radio unit and may violate FCC regulations.

3.1.2 Electronic Devices



RF energy from portable radios may affect some electronic equipment. Most modern electronic equipment in cars, hospitals, homes, etc. are shielded from RF energy. However, in areas in which you are instructed to turn off two-way radio equipment, always observe the rules. *If in doubt, turn it off!*

3.1.3 Aircraft



Always turn off a portable radio before boarding any aircraft!

- Use it on the ground only with crew permission.
- DO NOT use while in-flight!!

3.1.4 Electric Blasting Caps



To prevent accidental detonation of electric blasting caps, **DO NOT** use two-way radios within 1000 feet of blasting operations. Always obey the "Turn Off Two-Way Radios" signs posted where electric blasting caps are being used. (OSHA Standard: 1926.900)

3.1.5 Potentially Explosive Atmospheres



Areas with potentially explosive atmospheres are often, but not always, clearly marked. These may be fuelling areas, such as gas stations, fuel or chemical transfer or storage facilities, and areas where the air contains chemicals or particles, such as grain, dust, or metal powders.

Sparks in such areas could cause an explosion or fire resulting in bodily injury or even death.

Turn OFF two-way radios when in any area with a potentially explosive atmosphere. It is rare, but not impossible that a radio or its accessories could generate sparks.

4 OPTIONS AND ACCESSORIES

A complete list of Options and Accessories approved for use with the P7300 portable radio can be found online in the Operator's Manual MM-013994-001 at www.macom-wireless.com. Also reference the maintenance manual or M/A-COM's Products and Services Catalog for all available options and accessories, including those items that do not adversely affect the RF energy exposure.



Always use M/A-COM authorized accessories (antennas, batteries, belt clips, speaker/mics, etc). Use of unauthorized accessories may cause the FCC Occupational/Controlled Exposure RF compliance requirements to be exceeded.



Always use the correct options and accessories (battery, antenna, speaker/mic, etc.) for the radio. Immersion rated options must be used with an immersion rated radio. Intrinsically safe options must be used with intrinsically safe radios.

5 BATTERY PACKS

The P7300 series portable radios use rechargeable, recyclable Nickel Cadmium (NiCd), Nickel Metal Hydride (NiMH), or Lithium Ion (Li-Ion) battery packs. Please follow the directions below to maximize the useful life of each type of battery pack.



Do not disassemble or modify Lithium Ion battery packs. The Lithium Ion battery packs are equipped with built-in safety and protection features. Should these features be disabled or tampered with in any way, the battery pack can leak acid, overheat, emit smoke, burst, and/or, ignite.



If the battery pack is ruptured or is leaking electrolyte that results in skin or eye contact with the electrolyte, immediately flush the affected area with water. If the battery electrolyte gets in the eyes, flush with water for 15 minutes and consult a physician immediately.

5.1 CONDITIONING NIMH BATTERY PACKS

Condition a new NiMH battery pack before putting into use. This also applies to rechargeable NiMH battery packs that have been stored for long periods

(weeks, months, or longer). Conditioning requires fully charging and fully discharging the battery pack three (3) times using the tri-chemistry charger. The first time the battery pack is put into the charger, this unit will condition Nickel-based battery packs by automatically charging and discharging (cycling) the battery. Refer to the appropriate charger manual for details.



Failure to properly condition NiMH battery packs before initial use will result in shortened performance by the battery.

5.2 CONDITIONING NICKEL-BATTERY PACKS

A new NiCd battery pack does not require conditioning before use. However, M/A-COM recommends periodically conditioning NiCd battery packs to avoid the memory effect which results when a NiCd battery pack is repeatedly charged and not fully discharged, further resulting in a lower voltage and a lower capacity. Fortunately, both nominal voltage and capacity are restored through battery conditioning.

Conditioning requires fully charging and fully discharging the battery pack three (3) times using the tri-chemistry charger. The first time the battery pack is put into the charger, this unit will condition Nickel-based battery packs by automatically charging and discharging (cycling) the battery. Refer to the appropriate charger manual for details.

5.3 CONDITIONING LI-ION BATTERY PACKS

Lithium Ion battery packs do not suffer from memory effect and therefore do not require conditioning.



Always use M/A-COM authorized chargers and conditioners. Use of unauthorized chargers and conditioners may void the warranty.

5.4 ADDITIONAL INFORMATION

For more information regarding the proper care of portable radio battery packs or establishing a battery maintenance program, refer to ECR-7367 which may be ordered by calling toll free 1-800-368-3277, then select option 7.

5.5 BATTERY DISPOSAL



In no instance should a battery pack be incinerated. Disposing of a battery pack by burning will cause an explosion.



RECHARGEABLE BATTERY PACK DISPOSAL – The product you have purchased contains a rechargeable battery pack. The battery pack is recyclable. At the end of its useful life, under various state and local laws, it may be illegal to dispose of this battery pack into the municipal waste stream. Check with your local solid waste officials for details in your area for recycling options or proper disposal. Canadian and U.S. users may call Toll Free 1-800-8-BATTERY® for information and/or procedures for returning rechargeable batteries in your locality.

6 TECHNICAL ASSISTANCE

The Technical Assistance Center's (TAC) resources are available to help with overall system operation, maintenance, upgrades and product support. TAC is the point of contact when answers are needed to technical questions.

Product specialists, with detailed knowledge of product operation, maintenance, and repair, provide technical support via a toll-free (in North America) telephone number. Support is also available through mail, fax and e-mail.

For more information about technical assistance services, contact your sales representative, or call the Technical Assistance Center directly at:

North America:	1-800-528-7711
International:	1-434-385-2400
Fax:	1-434-455-6712
E-mail:	tac@tycoelectronics.com

7 BATTERY WARRANTY

- A. M/A-COM, Inc. (hereinafter "Seller") warrants to the original purchaser for use (hereinafter "Buyer") that nickel-cadmium and nickel-metal hydride batteries supplied by Seller shall be free from defects in material and workmanship, and shall conform to its published specifications for a period of twelve (12) months from the date of purchase.
- B. For purposes of this warranty, batteries shall be deemed defective if (1) the battery capacity is less than 80% rated capacity, or (2) the battery develops leakage.
- C. If any battery fails to meet the foregoing warranty, Seller shall correct the failure by issuing a replacement battery upon receipt of the defective battery at an Authorized Service Center (ASC) or M/A-COM factory (for OpenSky® Equipment only).
- D. Replacement batteries shall be warranted only for the remaining unexpired warranty period of the original battery. This warranty becomes void if:
 - 1. The battery has been subjected to any kind of misuse, detrimental exposure, or has been involved in an accident.
 - 2. The battery is used in equipment or service other than the radio equipment for which it is specified.
- E. The preceding paragraphs set forth the exclusive remedies for claims based upon defects in or non-conformity of any battery, whether the claim is in contract, warranty, tort (including negligence), strict liability or otherwise, and however instituted. Upon the expiration of the warranty period, all such liability shall terminate. The foregoing warranties are exclusive and in lieu of all other warranties, whether oral, written, expressed, implied or statutory. NO IMPLIED OR STATUTORY WARRANTIES OF MERCHANTABILITY OR FITNESS FOR PARTICULAR PURPOSE SHALL APPLY. IN NO EVENT SHALL THE COMPANY BE LIABLE FOR ANY INCIDENTAL, CONSEQUENTIAL, SPECIAL, INDIRECT OR EXEMPLARY DAMAGES.

This warranty applies only within the United States.

M/A-COM, Inc.
1011 Pawtucket Blvd.
Lowell, MA 01853
1-877-OPENSKY

M/A-COM, Inc.
221 Jefferson Ridge Parkway
Lynchburg, VA 24501
1-800-528-7711

ECR-7048B

8 WARRANTY

- A. M/A-COM, Inc. (hereinafter "Seller") warrants to the original purchaser for use (hereinafter "Buyer") that Equipment manufactured by or for the Seller shall be free from defects in material and workmanship, and shall conform to its published specifications. With respect to all non-M/A-COM Equipment, Seller gives no warranty, and only the warranty, if any, given by the manufacturer shall apply. Rechargeable batteries are excluded from this warranty but are warranted under a separate Rechargeable Battery Warranty (ECR-7048).
- B. Seller's obligations set forth in Paragraph C below shall apply only to failures to meet the above warranties occurring within the following periods of time from date of sale to the Buyer and are conditioned on Buyer's giving written notice to Seller within thirty (30) days of such occurrence:
1. for fuses and non-rechargeable batteries, operable on arrival only.
 2. for parts and accessories (except as noted in B.1) sold by Seller's Service Parts Operation, ninety (90) days.
 3. for P7200, P7100^{IP}, P5400, P5300, P5200, P5100, P3300, PANTHER™ 405P and 605P, M7300, M7200 (including V-TAC), M7100^{IP}, M5300 and M3300 radios, two (2) years, effective 10/01/2007.
 4. for all other equipment of Seller's manufacture, one (1) year.
- C. If any Equipment fails to meet the foregoing warranties, Seller shall correct the failure at its option (i) by repairing any defective or damaged part or parts thereof, (ii) by making available at Seller's factory any necessary repaired or replacement parts, or (iii) by replacing the failed Equipment with equivalent new or refurbished Equipment. Any repaired or replacement part furnished hereunder shall be warranted for the remainder of the warranty period of the Equipment in which it is installed. Where such failure cannot be corrected by Seller's reasonable efforts, the parties will negotiate an equitable adjustment in price. Labor to perform warranty service will be provided at no charge during the warranty period only for the Equipment covered under Paragraph B.3 and B.4. To be eligible for no-charge labor, service must be performed at a M/A-COM factory, by an Authorized Service Center (ASC) or other Servicer approved for these purposes either at its place of business during normal business hours, for mobile or personal equipment, or at the Buyer's location, for fixed location equipment. Service on fixed location equipment more than thirty (30) miles from the Service Center or other approved Servicer's place of business will include a charge for transportation.
- D. Seller's obligations under Paragraph C shall not apply to any Equipment, or part thereof, which (i) has been modified or otherwise altered other than pursuant to Seller's written instructions or written approval or, (ii) is normally consumed in operation or, (iii) has a normal life inherently shorter than the warranty periods specified in Paragraph B, or (iv) is not properly stored, installed, used, maintained or repaired, or, (v) has been subjected to any other kind of misuse or detrimental exposure, or has been involved in an accident.
- E. The preceding paragraphs set forth the exclusive remedies for claims based upon defects in or nonconformity of the Equipment, whether the claim is in contract, warranty, tort (including negligence), strict liability or otherwise, and however instituted. Upon the expiration of the warranty period, all such liability shall terminate. The foregoing warranties are exclusive and in lieu of all other warranties, whether oral, written, expressed, implied or statutory. **NO IMPLIED OR STATUTORY WARRANTIES OF MERCHANTABILITY OR FITNESS FOR PARTICULAR PURPOSE SHALL APPLY. IN NO EVENT SHALL THE SELLER BE LIABLE FOR ANY INCIDENTAL, CONSEQUENTIAL, SPECIAL, INDIRECT OR EXEMPLARY DAMAGES.**

This warranty applies only within the United States.

M/A-COM, Inc.
1011 Pawtucket Blvd.
Lowell, MA 01853
1-877-OPENSKY

M/A-COM, Inc.
221 Jefferson Ridge Parkway
Lynchburg, VA 24501
1-800-528-7711

ECR-7047F

NOTES

NOTES



Tyco Electronics Wireless Systems
221 Jefferson Ridge Parkway
Lynchburg, Virginia 24501
(Outside USA, 1-434-385-2400) Toll Free 1-800-528-7711
www.macom-wireless.com

Printed in U.S.A.