



## **M7300 Mobile Radios** VHF, UHF, and 700/800 MHz Front and Remote-Mount Mobile Radios



Includes  
CH-721 Scan and System  
Control Heads  
and  
HHC-731 Hand-Held  
Controller

### MANUAL REVISION HISTORY

REV.	DATE	REASON FOR CHANGE
G	Apr/11	Revised specifications, antenna part numbers and the respective MPE distance data, and HHC-731 installation kits. Added UHF radios and mobile data connection section.
H	Dec/11	Added FCC Part 80 information and maritime frequencies. Revised specifications and antenna installation procedures.
J	Jan/12	Added 110-watt VHF radio. Revised specifications and warranty.

Harris Corporation, Public Safety and Professional Communications (PSPC) Business, continually evaluates its technical publications for completeness, technical accuracy, and organization. You can assist in this process by submitting your comments and suggestions to the following:

**Harris Corporation**  
PSPC Business  
Technical Publications  
221 Jefferson Ridge Parkway  
Lynchburg, VA 24501

fax your comments to: 1-434-455-6851  
or  
e-mail us at: [PSPC\\_TechPubs@harris.com](mailto:PSPC_TechPubs@harris.com)

### ACKNOWLEDGEMENT

This device is made under license under one or more of the following US patents: 4,590,473; 4,636,791; 5,148,482; 5,185,796; 5,271,017; 5,377,229; 4,716,407; 4,972,460; 5,502,767; 5,146,497; 5,164,986; 5,185,795; 5,226,084; 5,247,579; 5,491,772; 5,517,511; 5,630,011; 5,649,050; 5,701,390; 5,715,365; 5,754,974; 5,826,222; 5,870,405; 6,161,089; and 6,199,037 B1. DVSI claims certain rights, including patent rights under aforementioned U.S. patents, and under other U.S. and foreign patents and patents pending. Any use of this software or technology requires a separate written license from DVSI.

### CREDITS

Harris, assuredcommunications, OpenSky and EDACS are registered trademarks of and ProVoice is a trademark of Harris Corporation.

AMBE is a registered trademark and IMBE, AMBE+, and AMBE+2 are trademarks of Digital Voice Systems, Inc. Bird is a registered trademark of Bird Electronic Corporation. Microsoft and Windows are registered trademarks of Microsoft Corporation. SmartSiren is a registered trademark of Federal Signal Corporation.

All other brand and product names are trademarks, registered trademarks, or service marks of their respective holders.

### NOTICE!

The material contained herein is subject to U.S. export approval. No export or re-export is permitted without written approval from the U.S. Government. Rated: EAR99 in accordance with U.S. Dept. of Commerce regulations 15CFR774, Export Administration Regulations.

Information and descriptions contained herein are the property of Harris Corporation. Such information and descriptions may not be copied or reproduced by any means, or disseminated or distributed without the express prior written permission of Harris Corporation, PSPC Business, 221 Jefferson Ridge Parkway, Lynchburg, VA 24501.

The voice coding technology embodied in this product is protected by intellectual property rights including patent rights, copyrights, and trade secrets of Digital Voice Systems, Inc. The user of this technology is explicitly prohibited from attempting to decompile, reverse engineer, or disassemble the Object Code, or in any other way convert the Object Code into human-readable form.

Repairs to this equipment should be made only by an authorized service technician or facility designated by the supplier. Any repairs, alterations or substitutions of recommended parts made by the user to this equipment not approved by the manufacturer could void the user's authority to operate the equipment in addition to the manufacturer's warranty.



This product conforms to the European Union WEEE Directive 2002/96/EC. Do not dispose of this product in a public landfill. Take it to a recycling center at the end of its life.

This manual is published by **Harris Corporation** without any warranty. Improvements and changes to this manual necessitated by typographical errors, inaccuracies of current information, or improvements to programs and/or equipment, may be made by **Harris Corporation** at any time and without notice. Such changes will be incorporated into new editions of this manual. No part of this manual may be reproduced or transmitted in any form or by any means, electronic or mechanical, including photocopying and recording, for any purpose, without the express written permission of **Harris Corporation**.

**TABLE OF CONTENTS**

<i>Section</i>	<i>Page</i>
<b>1 REGULATORY AND SAFETY INFORMATION .....</b>	<b>7</b>
1.1 SAFETY SYMBOL CONVENTIONS .....	7
1.2 RF ENERGY EXPOSURE AWARENESS AND CONTROL INFORMATION FOR FCC OCCUPATIONAL USE REQUIREMENTS .....	7
1.2.1 Federal Communications Commission Regulations .....	8
1.3 COMPLIANCE WITH RF EXPOSURE STANDARDS .....	8
1.3.1 Mobile Antennas .....	15
1.3.2 Approved Accessories .....	15
1.3.3 Contact Information .....	15
1.4 RADIO FREQUENCY INTERFERENCE .....	15
1.4.1 FCC Part 15 .....	15
1.4.2 Industry Canada .....	15
1.5 OCCUPATIONAL SAFETY GUIDELINES AND SAFETY TRAINING INFORMATION .....	16
1.6 COMMON HAZARDS .....	16
1.7 SAFE DRIVING RECOMMENDATIONS .....	17
1.8 OPERATING RULES AND REGULATIONS .....	17
1.9 OPERATING TIPS .....	18
<b>2 MARITIME FREQUENCIES .....</b>	<b>19</b>
<b>3 SPECIFICATIONS .....</b>	<b>25</b>
3.1 GENERAL .....	25
3.2 TRANSCEIVER .....	26
3.3 REGULATORY .....	27
<b>4 INTRODUCTION .....</b>	<b>28</b>
4.1 GENERAL DESCRIPTION .....	28
4.2 RADIO PROGRAMMING .....	30
4.2.1 EDACS/ProVoice, Conventional and P25 (ECP) Modes .....	31
4.2.2 OpenSky (OTP) Mode .....	31
4.3 RELATED PUBLICATIONS .....	31
4.4 REPLACEMENT PARTS .....	32
4.5 TECHNICAL ASSISTANCE .....	32
<b>5 UNPACKING AND CHECKING THE EQUIPMENT .....</b>	<b>33</b>
5.1 MATERIALS .....	33
5.2 MATERIAL INSPECTION .....	34
<b>6 PLANNING THE INSTALLATION .....</b>	<b>43</b>
6.1 GENERAL INFORMATION .....	43
6.2 TOOLS REQUIRED .....	43
6.3 LOCATING COMPONENTS .....	46
<b>7 ANTENNA INSTALLATION .....</b>	<b>47</b>
7.1 ANTENNA MOUNTING LOCATIONS .....	47
7.1.1 Direct Center or Center-Rear of Rooftop .....	47
7.1.2 Center of Trunk Lid .....	47
7.1.3 Rear Deck Lid for Stand-Alone GPS Receive Antenna .....	47
7.2 ANTENNA INSTALLATION PROCEDURES .....	53
7.2.1 Installing NMO Antenna Mounts AN-125001-001, -002, -003 and -004 .....	53
7.2.2 Installing NMO Magnetic Antenna Mounts AN-125001-007 and AN-125001-008 .....	55
7.2.3 Installing All Other Antenna Mounts .....	56

## TABLE OF CONTENTS

<u>Section</u>	<u>Page</u>
7.2.4 Attaching NMO Antenna Elements .....	56
7.2.5 Installing the Coax Cable and TNC RF Connector.....	56
7.2.6 Install GPS Antenna (Required Only if Radio has GPS Receiver Option).....	58
<b>8 FRONT-MOUNT RADIO INSTALLATION .....</b>	<b>60</b>
8.1 MOUNTING THE FRONT-MOUNT RADIO .....	60
8.1.1 Mounting Bracket Installation .....	62
8.1.2 Inserting the Radio into the Mounting Bracket.....	64
8.2 FRONT-MOUNT RADIO'S DC POWER INSTALLATION .....	64
8.2.1 Overview of On/Off Power Wiring Configurations.....	64
8.2.2 DC Power Cable and Main Fuse Holder Installation.....	65
8.3 TERMINATE CAN PORTS .....	69
<b>9 REMOTE-MOUNT RADIO INSTALLATION.....</b>	<b>70</b>
9.1 MOUNTING THE REMOTE-MOUNT RADIO .....	70
9.1.1 Mounting Bracket Installation .....	73
9.1.2 Inserting the Radio into the Mounting Bracket.....	74
9.2 REMOTE-MOUNT RADIO'S DC POWER INSTALLATION.....	74
9.2.1 Overview of On/Off Power Wiring Configurations.....	74
9.2.2 DC Power Cable and Main Fuse Holder Installation.....	75
9.2.3 Additional Hook-Up Required for a Data-Only Radio Installation .....	80
9.3 CH-721 CONTROL HEAD INSTALLATION.....	80
9.3.1 General Information.....	80
9.3.2 Control Head Mechanical Installation .....	83
9.3.3 Control Head-to-Radio CAN Cable Connections .....	84
9.3.4 Control Head Power Cable Installation .....	86
9.4 HHC-731 HAND-HELD CONTROLLER INSTALLATION .....	89
9.4.1 Mounting the HHC-731 Interface Cable and Bracket.....	90
9.4.2 Connecting CAN Link .....	91
9.4.3 Connecting DC Power .....	92
9.4.4 Mounting the HHC-731 Hanger .....	95
9.4.5 Connecting the HHC-731 to the HHC-731 Interface Cable .....	95
9.4.6 Connecting a Siren/Light Control System .....	95
9.4.7 Connecting a Headset .....	96
<b>10 SPEAKER INSTALLATION .....</b>	<b>96</b>
10.1 FRONT-MOUNT RADIO INSTALLATION.....	96
10.2 REMOTE-MOUNT RADIO INSTALLATION .....	97
10.2.1 With CH-721 Control Head.....	97
10.2.2 With HHC-731 Hand-Held Controller.....	97
<b>11 MICROPHONE ATTACHMENT .....</b>	<b>98</b>
<b>12 OPTIONAL CABLES.....</b>	<b>99</b>
12.1 M5300/M7300 OPTION CABLE CA-012349-001 .....	99
12.2 CH-721 OPTION CABLE CA-011854-001.....	105
12.3 ACCESSORY CABLE 19B802554P24.....	106
12.4 HHC-731 INTERFACE CABLE CA-018399-001.....	107
12.5 SERIAL DATA CABLE CA-013671-020 .....	108
12.6 CH-721 SERIAL PROGRAMMING CABLE CA-104861.....	108
12.7 CH-721 MIC CONNECTOR PROGRAMMING CABLE CA-103541-001.....	109
12.8 SPEAKER-ONLY OPTION CABLE CA-012349-007.....	109

**TABLE OF CONTENTS (Continued)**

<u>Section</u>	<u>Page</u>
<b>13 GPS NMEA-FORMATTED DATA CONNECTION.....</b>	<b>110</b>
<b>14 MOBILE DATA CONNECTION.....</b>	<b>110</b>
<b>15 INITIAL POWER-UP TEST .....</b>	<b>111</b>
<b>16 PERFORMANCE TESTS.....</b>	<b>112</b>
16.1 CHANGING OPERATING MODE FOR TESTS .....	112
16.1.1 Changing from OpenSky to Conventional.....	112
16.1.2 Changing from Conventional to OpenSky.....	113
16.2 REQUIRED TEST EQUIPMENT .....	114
16.3 TRANSMITTING INTO A DUMMY LOAD .....	114
16.4 TRANSMITTING INTO THE MOBILE ANTENNA.....	116
16.5 TEST PERFORMANCE DATA FORM.....	119
<b>17 COMPLETE THE INSTALLATION .....</b>	<b>120</b>
<b>18 WARRANTY REGISTRATION.....</b>	<b>120</b>
<b>19 WARRANTY.....</b>	<b>121</b>

**LIST OF TABLES**

	<u>Page</u>
Table 1-1: Recommended Minimum Safe Lateral Distance from Transmitting Antenna Connected to a 50-Watt VHF M7300 Mobile Radio.....	9
Table 1-2: Recommended Minimum Safe Lateral Distance from Transmitting Antenna Connected to a 110-Watt VHF M7300 Mobile Radio.....	10
Table 1-3: Recommended Minimum Safe Lateral Distance from a Transmitting Antenna Connected to a Low-Split UHF (378 to 430 MHz) 50-Watt M7300 Mobile Radio.....	11
Table 1-4: Recommended Minimum Safe Lateral Distance from a Transmitting Antenna Connected to a High-Split UHF (440 to 512 MHz) 50-Watt M7300 Mobile Radio .....	12
Table 1-5: Recommended Minimum Safe Lateral Distance from a Transmitting Antenna Connected to a 700/800 MHz M7300 Mobile Radio .....	13
Table 2-1: Maritime Frequencies .....	19
Table 4-1: Radio Systems/Standards Supported by the M7300 Mobile Radio .....	28
Table 5-1: M7300 Mobile Radio Catalog and Part Numbers .....	33
Table 5-2: CH-721 Control Head and HHC-731 Controller Catalog and Part Numbers .....	34
Table 5-3: Installation Kit MAMW-NZN6W for Front-Mount M7300 Mobile Radio .....	35
Table 5-4: Installation Kit MAMW-NZN7R for 35/50-Watt Remote-Mount M7300 Mobile Radio with CH-721 Control Head.....	36
Table 5-5: HHC-731 Hand-Held Controller Installation Kit MAMW-NZN9G.....	38
Table 5-6: Additional Options and Accessories for M7300 Mobile Radios .....	40
Table 5-7: Additional Options and Accessories for CH-721 Control Heads.....	42
Table 9-1: HHC-731 Headset Connections .....	96
Table 12-1: M5300/M7300 Option Cable CA-012349-001 Interconnections.....	100
Table 16-1: Required Test Equipment .....	114

## LIST OF FIGURES

	<u>Page</u>
Figure 6-1: M7300 Front-Mount and Remote-Mount 35/50-Watt Mobile Radios — Front and Rear Views.....	44
Figure 6-2: M7300 Remote-Mount 110-Watt Mobile Radios — Front and Rear Views .....	45
Figure 7-1: Recommended VHF Antenna Mounting Locations with Antenna Part Numbers .....	48
Figure 7-2: Recommended Low-Split UHF Antenna Mounting Locations with Antenna Part Numbers .....	49
Figure 7-3: Recommended High-Split UHF Antenna Mounting Locations with Antenna Part Numbers.....	50
Figure 7-4: Recommended 700/800 MHz Antenna Mounting Locations with Antenna Part Numbers .....	52
Figure 7-5: Installing a Standard ¾-Inch NMO Antenna Mount (e.g., AN-125001-001 or AN-125001-002).....	55
Figure 7-6: Installing a Thick-Roof NMO Antenna Mount (e.g., AN-125001-003 or AN-125001-004).....	55
Figure 7-7: Crimping Instructions for TNC RF Connector .....	57
Figure 8-1: Front-Mount M7300 Radio Dimensions .....	61
Figure 8-2: Front-Mount Mounting Bracket Kit KT101533V1.....	62
Figure 8-3: Mounting Bracket FM101319V1 (Marked KTB0310) Dimensions [for Front-Mount M7300 Mobile Radio (Radio Not Shown)] .....	63
Figure 9-1: Remote-Mount 35/50-Watt M7300 Radio Dimensions .....	71
Figure 9-2: Remote-Mount 110-Watt M7300 Radio Dimensions .....	72
Figure 9-3: Remote-Mount Mounting Bracket Kit KT23117 for 35 and 50-Watt Radios .....	73
Figure 9-5: Wiring Diagram for a 35/50-Watt Remote-Mount Radio Installation .....	78
Figure 9-6: CH-721 Scan Model Control Head Front Panel .....	81
Figure 9-7: CH-721 System Model Control Head Front Panel.....	81
Figure 9-8: CH-721 Rear Panel (both control head models) .....	82
Figure 9-9: Standard U-Shaped Control Head Mounting Bracket (Kit Part Number KT-008608) .....	83
Figure 9-10: Optional Control Head Gimbal Mounting Pedestal (Part Number MACDOS0012) .....	83
Figure 9-11: CAN Link Connections for a Single Control Head Installation.....	85
Figure 9-12: Typical CAN Link Connections for a Multi-Control Head Installation.....	85
Figure 9-13: HHC-731 Hand-Held Controller Front View .....	90
Figure 9-14: HHC-731 Interface Cable Mounting Bracket Kit KT-018752-001 .....	90
Figure 9-15: HHC-731 Interface Cable Mounting Bracket-to-Cable Positioning .....	91
Figure 9-16: M7300-to-HHC-731 CAN Link Connections.....	92
Figure 12-1: M5300/M7300 Option Cable CA-012349-001 .....	99
Figure 12-2: CH-721 Option Cable CA-011854-001 .....	105
Figure 12-3: Accessory Cable 19B802554P24.....	106
Figure 12-4: HHC-731 Interface Cable CA-018399-001 .....	107
Figure 12-5: Serial Data Cable CA-013671-020 .....	108
Figure 12-6: CH-721 Serial Programming Cable CA-104861 .....	108
Figure 12-7: CH-721 Serial Programming Cable CA-103541-001 .....	109
Figure 12-8: Speaker-Only Option Cable CA-012349-007.....	109
Figure 16-1: Wattmeter Connections for Antenna System Tests .....	115

# 1 REGULATORY AND SAFETY INFORMATION

## 1.1 SAFETY SYMBOL CONVENTIONS

The following conventions are used in this manual to alert the user to general safety precautions that must be observed during all phases of operation, installation, service, and repair of this product. Failure to comply with these precautions or with specific warnings elsewhere violates safety standards of design, manufacture, and intended use of the product. Harris Corporation assumes no liability for the customer's failure to comply with these standards.



The **WARNING** symbol calls attention to a procedure, practice, or the like, which, if not correctly performed or adhered to, could result in personal injury. Do not proceed beyond a **WARNING** symbol until the conditions identified are fully understood or met.



The **CAUTION** symbol calls attention to an operating procedure, practice, or the like, which, if not performed correctly or adhered to, could result in damage to the equipment or severely degrade equipment performance.



The **NOTE** symbol calls attention to supplemental information, which may improve system performance or clarify a process or procedure.

## 1.2 RF ENERGY EXPOSURE AWARENESS AND CONTROL INFORMATION FOR FCC OCCUPATIONAL USE REQUIREMENTS

Before using the two-way mobile radio, review the following important RF energy awareness and control information and operational instructions. Comply with this information and instructions in order to ensure compliance with RF exposure guidelines.



This radio is intended for use in occupational/controlled conditions, where users have full knowledge of their exposure and can exercise control over their exposure to remain below RF exposure limits. This radio is **NOT** authorized for general population, consumer, or any other use.



Changes or modifications not expressly approved by Harris could void the user's authority to operate the equipment.

This two-way radio uses electromagnetic energy in the radio frequency (RF) spectrum to provide communications between two or more users over a distance. It uses RF energy or radio waves to send and receive calls. RF energy is one form of electromagnetic energy. Other forms include, but are not limited to, electric power, sunlight, and x-rays. RF energy, however, should not be confused with these other forms of electromagnetic energy, which, when used improperly, can cause biological damage. Very high levels of x-rays, for example, can damage tissues and genetic material.

Experts in science, engineering, medicine, health, and industry work with organizations to develop standards for exposure to RF energy. These standards provide recommended levels of RF exposure for both workers and the general public. These recommended RF exposure levels include substantial margins of protection. All two-way radios marketed in North America are designed, manufactured, and tested to

ensure they meet government-established RF exposure levels. In addition, manufacturers also recommend specific operating instructions to users of two-way radios. These instructions are important because they inform users about RF energy exposure and provide simple procedures on how to control it. Refer to the following websites for more information on what RF energy exposure is and how to control exposure to assure compliance with established RF exposure limits:

<http://www.fcc.gov/oet/rfsafety/rf-faqs.html>

<http://www.osha.gov/SLTC/radiofrequencyradiation/index.html>

### 1.2.1 Federal Communications Commission Regulations

Before it was marketed in the United States, the M7300 two-way mobile radio was tested to ensure compliance with FCC RF energy exposure limits for two-way mobile radios. When two-way radios are used as a consequence of employment, the FCC requires users to be fully aware of and able to control their exposure to meet occupational requirements. Exposure awareness can be facilitated by the use of a label directing users to specific user awareness information. The radio has an RF exposure product label. Also, this Installation and Product Safety Manual and the applicable Operator's Manual include information and operating instructions required to control RF exposure and to satisfy compliance requirements.

## 1.3 COMPLIANCE WITH RF EXPOSURE STANDARDS

The M7300 two-way mobile radio is designed and tested to comply with a number of national and international standards and guidelines regarding human exposure to RF electromagnetic energy. This radio complies with the IEEE and ICNIRP exposure limits for occupational/controlled RF exposure environment at duty-cycle times of up to 50% (50% transmit, 50% receive), and it is authorized by the FCC for occupational use. In terms of measuring RF energy for compliance with the FCC exposure guidelines, the radio's antenna radiates measurable RF energy only while it is transmitting (talking), not when it is receiving (listening), or in a standby mode.

The M7300 two-way mobile radio complies with the following RF energy exposure standards and guidelines:

- United States Federal Communications Commission (FCC), Code of Federal Regulations; 47 CFR § 2 sub-part J.
- American National Standards Institute (ANSI)/Institute of Electrical and Electronic Engineers (IEEE) C95.1-2005.
- Institute of Electrical and Electronic Engineers (IEEE) C95.1-2005.
- IC Standard RSS-102, Issue 2, 2005: Spectrum Management and Telecommunications Radio Standards Specification. Radiofrequency Exposure Compliance of Radiocommunication Apparatus (All Frequency Bands).



Table 1-1 through Table 1-5 list the recommended minimum safe lateral distances for a controlled environment and for unaware bystanders in an uncontrolled environment, from transmitting antennas (i.e., monopoles over a ground plane, or dipoles) at rated radio power for mobile radios installed in a vehicle. Transmit only when unaware bystanders are at least the uncontrolled recommended minimum safe lateral distance away from the transmitting antenna.

Based on the highest radiated RF power and the highest antenna gain in antennas to be used with M7300, the distances listed in Table 1-1 through Table 1-5 are considered as safe distances for controlled and uncontrolled environments with the M7300 mobile radio transmitting at a maximum 50% duty cycle:



**Table 1-1: Recommended Minimum Safe Lateral Distance from Transmitting Antenna Connected to a 50-Watt VHF M7300 Mobile Radio**

ANTENNA PART NUMBER	ANTENNA DESCRIPTION	RECOMMENDED MINIMUM LATERAL HUMAN BODY DISTANCE FROM TRANSMITTING ANTENNA	
		CONTROLLED ENVIRONMENT	UNCONTROLLED ENVIRONMENT
AN-125001-001 (mount) with AN-225002-001 (element)	136 to 174 MHz, Standard Rooftop-Mount; 0 dBd Gain	24.8 Inches (63 Centimeters)	55.1 Inches (140 Centimeters)
AN-125001-001 (mount) with AN-225006-001 (element)	132 to 960 MHz,* Standard Rooftop-Mount; 0 dBd Gain		
AN-125001-003 (mount) with AN-225002-001 (element)	136 to 174 MHz, Thick Rooftop-Mount; 0 dBd Gain		
AN-125001-003 (mount) with AN-225006-001 (element)	132 to 960 MHz, Thick Rooftop-Mount; 0 dBd Gain*		
AN-125001-005 (mount) with AN-225002-001 (element)	136 to 174 MHz, GPS Combo Standard Rooftop-Mount; 0 dBd Gain		
AN-125001-007 (mount) with AN-225002-001 (element)	136 to 174 MHz, Magnetic-Mount; 0 dBd Gain		
AN-125001-007 (mount) with AN-225006-001 (element)	132 to 960 MHz,* Magnetic-Mount; 0 dBd Gain		
AN102800V1 (Discontinued)	136 to 941 MHz, ¼-Wavelength*, Standard Rooftop-Mount; 0 dBd Gain		

\* Driven element of AN102800V1 and element AN-225006-001 must be trimmed to proper length in order to minimize antenna system VSWR.

**Table 1-2: Recommended Minimum Safe Lateral Distance from Transmitting Antenna  
Connected to a 110-Watt VHF M7300 Mobile Radio**

ANTENNA PART NUMBER	ANTENNA DESCRIPTION	RECOMMENDED MINIMUM LATERAL HUMAN BODY DISTANCE FROM TRANSMITTING ANTENNA	
		CONTROLLED ENVIRONMENT	UNCONTROLLED ENVIRONMENT
AN-125001-001 (mount) with AN-225002-001 (element)	136 to 174 MHz, Standard Rooftop-Mount; 0 dBd Gain	36.6 Inches (93 Centimeters)	81.9 Inches (208 Centimeters)
AN-125001-001 (mount) with AN-225006-001 (element)	132 to 960 MHz,* Standard Rooftop-Mount; 0 dBd Gain		
AN-125001-003 (mount) with AN-225002-001 (element)	136 to 174 MHz, Thick Rooftop-Mount; 0 dBd Gain		
AN-125001-003 (mount) with AN-225006-001 (element)	132 to 960 MHz, Thick Rooftop-Mount; 0 dBd Gain*		
AN-125001-005 (mount) with AN-225002-001 (element)	136 to 174 MHz, GPS Combo Standard Rooftop- Mount; 0 dBd Gain		
AN-125001-007 (mount) with AN-225002-001 (element)	136 to 174 MHz, Magnetic-Mount; 0 dBd Gain		
AN-125001-007 (mount) with AN-225006-001 (element)	132 to 960 MHz,* Magnetic-Mount; 0 dBd Gain		

\* Element AN-225006-001 must be trimmed to proper length in order to minimize antenna system VSWR.

**Table 1-3: Recommended Minimum Safe Lateral Distance from a Transmitting Antenna Connected to a Low-Split UHF (378 to 430 MHz) 50-Watt M7300 Mobile Radio**

ANTENNA PART NUMBER	ANTENNA DESCRIPTION	RECOMMENDED MINIMUM LATERAL HUMAN BODY DISTANCE FROM TRANSMITTING ANTENNA	
		CONTROLLED ENVIRONMENT	UNCONTROLLED ENVIRONMENT
AN-125001-001 (mount) with AN-225003-001 (element)	378 to 430 MHz Standard Rooftop-Mount; 0 dBd Gain	21.3 Inches (54 Centimeters)	47.2 Inches (120 Centimeters)
AN-125001-001 (mount) with AN-225003-004 (element)	378 to 430 MHz Standard Rooftop-Mount; Low-Profile 0 dBd Gain		
AN-125001-003 (mount) with AN-225003-001 (element)	378 to 430 MHz Thick Rooftop-Mount; 0 dBd Gain		
AN-125001-003 (mount) with AN-225003-004 (element)	378 to 430 MHz Thick Rooftop-Mount; Low-Profile 0 dBd Gain		
AN-125001-005 (mount) with AN-225003-001 (element)	378 to 430 MHz GPS Combo, Standard Rooftop-Mount; 0 dBd Gain		
AN-125001-005 (mount) with AN-225003-004 (element)	378 to 430 MHz GPS Combo, Standard Rooftop-Mount; Low-Profile 0 dBd Gain		
AN-125001-007 (mount) with AN-225003-001 (element)	378 to 430 MHz Magnetic-Mount; 0 dBd Gain		
AN-125001-007 (mount) with AN-225003-004 (element)	378 to 430 MHz Magnetic-Mount; Low-Profile 0 dBd Gain		
AN102800V1 (Discontinued)	136 to 941 MHz, ¼-Wavelength*, Standard Rooftop-Mount; 0 dBd Gain		

\* Driven element of AN102800V1 must be trimmed to proper length in order to minimize antenna system VSWR.

**Table 1-4: Recommended Minimum Safe Lateral Distance from a Transmitting Antenna  
Connected to a High-Split UHF (440 to 512 MHz) 50-Watt M7300 Mobile Radio**

ANTENNA PART NUMBER	ANTENNA DESCRIPTION	RECOMMENDED MINIMUM LATERAL HUMAN BODY DISTANCE FROM TRANSMITTING ANTENNA	
		CONTROLLED ENVIRONMENT	UNCONTROLLED ENVIRONMENT
AN-125001-001 (mount) with AN-225004-001 (element)	450 to 512 MHz Standard Rooftop-Mount; 0 dBd Gain	20 Inches (51 Centimeters)	45 Inches (114 Centimeters)
AN-125001-001 (mount) with AN-225004-004 (element)	450 to 512 MHz Standard Rooftop-Mount; Low-Profile 0 dBd Gain		
AN-125001-003 (mount) with AN-225004-001 (element)	450 to 512 MHz Thick Rooftop-Mount; 0 dBd Gain		
AN-125001-003 (mount) with AN-225004-004 (element)	450 to 512 MHz Thick Rooftop-Mount; Low-Profile 0 dBd Gain		
AN-125001-005 (mount) with AN-225004-001 (element)	450 to 512 MHz GPS Combo, Standard Rooftop- Mount; 0 dBd Gain		
AN-125001-005 (mount) with AN-225004-004 (element)	450 to 512 MHz GPS Combo, Standard Rooftop- Mount; Low-Profile 0 dBd Gain		
AN-125001-007 (mount) with AN-225004-001 (element)	450 to 512 MHz Magnetic-Mount; 0 dBd Gain		
AN-125001-007 (mount) with AN-225004-004 (element)	450 to 512 MHz Magnetic-Mount; Low-Profile 0 dBd Gain		
AN102800V1 (Discontinued)	136 to 941 MHz, ¼-Wavelength*, Standard Rooftop-Mount; 0 dBd Gain		

\* Driven element of AN102800V1 must be trimmed to proper length in order to minimize antenna system VSWR.

**Table 1-5: Recommended Minimum Safe Lateral Distance from a Transmitting Antenna Connected to a 700/800 MHz M7300 Mobile Radio**

ANTENNA PART NUMBER	ANTENNA DESCRIPTION	RECOMMENDED MINIMUM LATERAL HUMAN BODY DISTANCE FROM TRANSMITTING ANTENNA	
		CONTROLLED ENVIRONMENT	UNCONTROLLED ENVIRONMENT
AN-125001-002 (mount) with AN-225001-001 (element)	700/800 MHz Standard Rooftop-Mount; 3 dBd Gain	9.8 Inches (25 Centimeters)	21.7 Inches (55 Centimeters)
AN-125001-002 (mount) with AN-225001-002 (element)	700/800 MHz Standard Rooftop-Mount; Elevated-Feed 3 dBd Gain		
AN-125001-002 (mount) with AN-225001-003 (element)	700/800 MHz Standard Rooftop-Mount; Elevated-Feed, No Ground Plane 3 dBd Gain		
AN-125001-002 (mount) with AN-225001-004 (element)	700/800 MHz Standard Rooftop-Mount; Low-Profile 2 dBd Gain		
AN-125001-002 (mount) with AN-225001-005 (element)	700/800 MHz Standard Rooftop-Mount; 5 dBd Gain	11.8 Inches (30 Centimeters)	23.6 Inches (60 Centimeters)
AN-125001-004 (mount) with AN-225001-001 (element)	700/800 MHz Thick Rooftop-Mount; 3 dBd Gain	9.8 Inches (25 Centimeters)	21.7 Inches (55 Centimeters)
AN-125001-004 (mount) with AN-225001-002 (element)	700/800 MHz Thick Rooftop-Mount; Elevated-Feed 3 dBd Gain		
AN-125001-004 (mount) with AN-225001-003 (element)	700/800 MHz Thick Rooftop-Mount; Elevated-Feed, No Ground Plane 3 dBd Gain		
AN-125001-004 (mount) with AN-225001-004 (element)	700/800 MHz Thick Rooftop-Mount; Low-Profile 2 dBd Gain		
AN-125001-004 (mount) with AN-225001-005 (element)	700/800 MHz Thick Rooftop-Mount; 5 dBd Gain	11.8 Inches (30 Centimeters)	23.6 Inches (60 Centimeters)

(Table Continued on Next Page)

**Table 1-5: Recommended Minimum Safe Lateral Distance from a Transmitting Antenna  
Connected to a 700/800 MHz M7300 Mobile Radio**

ANTENNA PART NUMBER	ANTENNA DESCRIPTION	RECOMMENDED MINIMUM LATERAL HUMAN BODY DISTANCE FROM TRANSMITTING ANTENNA	
		CONTROLLED ENVIRONMENT	UNCONTROLLED ENVIRONMENT
AN-125001-006 (mount) with AN-225001-001 (element)	700/800 MHz GPS Combo Rooftop-Mount; 3 dBd / 5.15 dBi Gain	9.8 Inches (25 Centimeters)	21.7 Inches (55 Centimeters)
AN-125001-006 (mount) with AN-225001-002 (element)	700/800 MHz GPS Combo Rooftop-Mount; Elevated-Feed 3 dBd Gain		
AN-125001-006 (mount) with AN-225001-003 (element)	700/800 MHz GPS Combo Rooftop-Mount; Elevated-Feed, No Ground Plane 3 dBd Gain		
AN-125001-006 (mount) with AN-225001-004 (element)	700/800 MHz GPS Combo Rooftop-Mount; Low-Profile 2 dBd Gain		
AN-125001-006 (mount) with AN-225001-005 (element)	700/800 MHz GPS Combo Rooftop-Mount; 5 dBd / 7.15 dBi Gain	11.8 Inches (30 Centimeters)	23.6 Inches (60 Centimeters)
AN-125001-008 (mount) with AN-225001-001 (element)	700/800 MHz Magnetic-Mount; 3 dBd Gain	9.8 Inches (25 Centimeters)	21.7 Inches (55 Centimeters)
AN-125001-008 (mount) with AN-225001-002 (element)	700/800 MHz Magnetic-Mount; Elevated-Feed 3 dBd Gain		
AN-125001-008 (mount) with AN-225001-003 (element)	700/800 MHz Magnetic-Mount; Elevated-Feed, No Ground Plane 3 dBd Gain		
AN-125001-008 (mount) with AN-225001-004 (element)	700/800 MHz Magnetic-Mount; Low-Profile 2 dBd Gain		
AN-125001-008 (mount) with AN-225001-005 (element)	700/800 MHz Magnetic-Mount; 5 dBd Gain	11.8 Inches (30 Centimeters)	23.6 Inches (60 Centimeters)

(Table Continued on Next Page)

**Table 1-5: Recommended Minimum Safe Lateral Distance from a Transmitting Antenna Connected to a 700/800 MHz M7300 Mobile Radio**

ANTENNA PART NUMBER	ANTENNA DESCRIPTION	RECOMMENDED MINIMUM LATERAL HUMAN BODY DISTANCE FROM TRANSMITTING ANTENNA	
		CONTROLLED ENVIRONMENT	UNCONTROLLED ENVIRONMENT
AN102800V1 (Discontinued)	136 to 941 MHz, ¼-Wavelength**, Standard Rooftop-Mount; 0 dBd Gain	9.8 Inches (25 Centimeters)	21.7 Inches (55 Centimeters)
STI-Co CCAS-SB-700	760 - 820 MHz Concealed Peel-and-Stick Internal-Mount; 0 dBi Gain	7.9 Inches (20 Centimeters)	19.7 Inches (50 Centimeters)

\* Driven element of AN102800V1 must be trimmed to proper length in order to minimize antenna system VSWR.

### **1.3.1 Mobile Antennas**

The antenna(s) for the radio must be installed in accordance with Section 7 in this manual. Refer to Table 5-6 and/or Figure 7-1 through Figure 7-4 for applicable antenna part numbers. Installation guidelines presented in Section 7 are limited to metal-body motor vehicles or vehicles with appropriate ground planes.

Use only approved/supplied antenna(s) or an approved replacement antenna. Unauthorized antennas, modifications, or attachments can cause the FCC RF exposure limits to be exceeded.

### **1.3.2 Approved Accessories**

The radio has been tested and meets FCC RF guidelines when used with accessories supplied or designated for use with it. Use of other accessories may not ensure compliance with the FCC's RF exposure guidelines, and may violate FCC regulations. For a list of approved accessories refer to Section 5 in this manual (begins on page 33) and/or the Products and Services Catalog.

### **1.3.3 Contact Information**

For additional information on RF exposure and other information, contact Harris using one of the contact links listed in Section 4.5 on page 32.

## **1.4 RADIO FREQUENCY INTERFERENCE**

### **1.4.1 FCC Part 15**

This device complies with Part 15 of the FCC Rules. Operation is subject to the following two conditions:

1. This device may not cause harmful interference; and,
2. This device must accept any interference received, including interference that may cause undesired operation.

### **1.4.2 Industry Canada**

This device complies with Industry Canada license-exempt RSS standard(s). Operation is subject to the following two conditions: (1) this device may not cause interference, and (2) this device must accept any interference, including interference that may cause undesired operation of the device.

Le présent appareil est conforme aux CNR d'Industrie Canada applicables aux appareils radio exempts de licence. L'exploitation est autorisée aux deux conditions suivantes : (1) l'appareil ne doit pas produire de brouillage, et (2) l'utilisateur de l'appareil doit accepter tout brouillage radioélectrique subi, même si le brouillage est susceptible d'en compromettre le fonctionnement.

## 1.5 OCCUPATIONAL SAFETY GUIDELINES AND SAFETY TRAINING INFORMATION

To ensure bodily exposure to RF electromagnetic energy is within the FCC allowable limits for occupational use. Always adhere to the following basic guidelines:

- The push-to-talk button should only be depressed when intending to send a voice message.
- The radio should only be used for necessary work-related communications.
- The radio should only be used by authorized and trained personnel. It should never be operated by children.
- Do not attempt any unauthorized modification to the radio. Changes or modifications to the radio may cause harmful interference and/or cause it to exceed FCC RF exposure limits. Only qualified personnel should service the radio.
- Always use only authorized accessories (antennas, control heads, speakers/mics, etc.). Use of unauthorized accessories can cause the FCC RF exposure compliance requirements to be exceeded.

The information listed above provides the user with information needed to make him or her aware of a RF exposure, and what to do to assure that this radio operates within the FCC exposure limits of this radio.

## 1.6 COMMON HAZARDS



**The operator of any mobile radio should be aware of certain hazards common to the operation of vehicular radio transmissions. Possible hazards include but are not limited to:**

- **Explosive Atmospheres** — Just as it is dangerous to fuel a vehicle while its engine is running, be sure to turn the radio **OFF** while fueling the vehicle. If the radio is mounted in the trunk of the vehicle, **DO NOT** carry containers of fuel in the trunk.  
  
Areas with potentially explosive atmosphere are often, but not always, clearly marked. Turn the radio **OFF** when in any area with a potentially explosive atmosphere. It is rare, but not impossible that the radio or its accessories could generate sparks.
- **Interference To Vehicular Electronic Systems** — Electronic fuel injection systems, electronic anti-skid braking systems, electronic cruise control systems, etc., are typical of the types of electronic devices that can malfunction due to the lack of protection from radio frequency (RF) energy present when transmitting. If the vehicle contains such equipment, consult the dealer for the make of vehicle and enlist his aid in determining if such electronic circuits perform normally when the radio is transmitting.
- **Electric Blasting Caps** — To prevent accidental detonation of electric blasting caps, **DO NOT** use two-way radios within 1000 feet (305 meters) of blasting operations. Always obey the “**Turn Off Two-Way Radios**” (or equivalent) signs posted where electric blasting caps are being used. (OSHA Standard: 1926.900).



- **Radio Frequency Energy** — To prevent burns or related physical injury from radio frequency energy, do not operate the transmitter when anyone outside of the vehicle is within the minimum safe distance from the antenna as specified in Table 1-1 (for VHF radios), Table 1-3 (for low-split UHF radios) Table 1-4 (for high-split UHF radios) or Table 1-5 (for 700 and 800 MHz radios). Refer to Section 1.2 for additional information.
- **Vehicles Powered By Liquefied Petroleum (LP) Gas** — Radio installation in vehicles powered by liquefied petroleum gas, where the LP gas container is located in the trunk or other sealed-off space within the interior of the vehicle, must conform to the **National Fire Protection Association standard NFPA 58**. This requires:
  - The space containing the radio equipment must be isolated by a seal from the space containing the LP gas container and its fittings.
  - Outside filling connections must be used for the LP gas container.
  - The LP gas container space shall be vented to the outside of the vehicle.
- **Vehicles Equipped with Airbags** — For driver and passenger safety, avoid mounting the radio's control head (or any other component) above or near airbag deployment areas. In addition to driver-side and passenger-side front-impact airbags, some vehicles may also be equipped with side-impact airbags. For occupant safety, verify the location of all airbags within the vehicle before installing the radio equipment.

## 1.7 SAFE DRIVING RECOMMENDATIONS

The American Automobile Association (AAA) advocates the following key safe driving recommendations:

- Read the literature on the safe operation of the radio.
- Keep both hands on the steering wheel and the microphone in its hanger whenever the vehicle is in motion.
- Place calls only when the vehicle is stopped.
- When talking from a moving vehicle is unavoidable, drive in the slower lane. Keep conversations brief.
- If a conversation requires taking notes or complex thought, stop the vehicle in a safe place and continue the call.
- Whenever using a mobile radio, exercise caution.

## 1.8 OPERATING RULES AND REGULATIONS

Two-way radio systems must be operated in accordance with the rules and regulations of the local, regional, or national government.

In the United States, the M7300 mobile radio must be operated in accordance with the rules and regulations of the Federal Communications Commission (FCC). Operators of two-way radio equipment must be thoroughly familiar with the rules that apply to the particular type of radio operation. Following these rules helps eliminate confusion, assures the most efficient use of the existing radio channels, and results in a smoothly functioning radio network.

When using a two-way radio, remember these rules:

- It is a violation of FCC rules to interrupt any distress or emergency message. The radio operates in much the same way as a telephone "party line." Therefore, always listen to make sure the channel is

clear before transmitting. Emergency calls have priority over all other messages. If someone is sending an emergency message – such as reporting a fire or asking for help in an accident, do not transmit unless assistance can be offered.

- The use of profane or obscene language is prohibited by Federal law.
- It is against the law to send false call letters or false distress or emergency messages. The FCC requires keeping conversations brief and confined to business. Use coded messages whenever possible to save time.
- Using the radio to send personal messages (except in an emergency) is a violation of FCC rules. Send only essential messages.
- It is against Federal law to repeat or otherwise make known anything overheard on the radio. Conversations between others sharing the channel must be regarded as confidential.
- The FCC requires self-identification at certain specific times by means of call letters. Refer to the rules that apply to the particular type of operation for the proper procedure.
- No changes or adjustments shall be made to the equipment except by an authorized or certified electronics technician.



Under U.S. law, operation of an unlicensed radio transmitter within the jurisdiction of the United States may be punishable by a fine of up to \$10,000, imprisonment for up to two (2) years, or both.

## 1.9 OPERATING TIPS

The following conditions tend to reduce the effective range of two-way radios and should be avoided whenever possible:

- Operating the radio in areas of low terrain, or while under power lines or bridges.
- Obstructions such as mountains and buildings.



In areas where transmission or reception is poor, communication improvement may sometimes be obtained by moving a few yards in another direction, or moving to a higher elevation.

## 2 MARITIME FREQUENCIES

Refer to Table 2-1 for a list of maritime frequencies per United States Coast Guard (USCG), National Oceanic and Atmospheric Administration (NOAA), and Canadian Department Fisheries and Oceans.

- United States (US)
- International (Intl)
- Canada (CA)

**Table 2-1: Maritime Frequencies**

CHANNEL			FREQUENCY		CHANNEL USAGE
US	INTL	CA	SHIP (MHz)	SHORE (MHz)	
	1	1	T: 156.05 R: 160.65	T: 160.65 R: 156.05	International: Public Correspondence, Port Operations
1a			T/R: 156.05	T/R: 156.05	US: Port Operations and Commercial, Vessel Traffic Service (VTS). New Orleans/Lower Mississippi area.
	2	2	T: 156.10 R: 160.70	T: 160.70 R: 156.10	International: Public Correspondence, Port Operations
	3	3	T: 156.15 R: 160.75	T: 160.75 R: 156.15	International: Public Correspondence, Port Operations
	4		T: 156.20 R: 160.80	T: 160.80 R: 156.20	International: Public Correspondence, Port Operations
		4a	T/R: 156.20	T/R: 156.20	Canada: Department Fisheries Ocean (DFO)/Canadian Coast Guard only in British Columbia coast area. Commercial fishing in east coast area
	5		T: 156.25 R: 160.85	T: 160.85 R: 156.25	International: Public Correspondence, Port Operations
5a		5a	T/R: 156.25	T/R: 156.25	US: Port Operations or VTS in Houston, New Orleans and Seattle areas.
6	6	6	T/R: 156.30	T/R: 156.30	US: Intership Safety International: Intership Canada: May be used for search and rescue communications between ships and aircraft.
	7		T: 156.35 R: 160.95	T: 160.95 R: 156.35	International: Public Correspondence, Port Operations
7a		7a	T/R: 156.35	T/R: 156.35	US: Commercial
8	8	8	T/R: 156.40	T/R: 156.40	US: Commercial (Intership only) International: Intership Canada: Also assigned for intership in the Lake Winnipeg area.
9	9	9	T/R: 156.45	T/R: 156.45	US: Boater Calling. Commercial and Non-Commercial. International: Intership, Port Operations Canada: Commercial - British Columbia coast area. May be used to communicate with aircraft and helicopters in predominantly maritime support operations.
10	10	10	T/R: 156.50	T/R: 156.50	US: Commercial International: Intership, Port Operations Canada: Commercial - British Columbia coast area. May also be used for communications with aircraft engaged in coordinated search and rescue and antipollution operations.

Table 2-1: Maritime Frequencies

CHANNEL			FREQUENCY		CHANNEL USAGE
US	INTL	CA	SHIP (MHz)	SHORE (MHz)	
11	11	11	T/R: 156.55	T/R: 156.55	US: Commercial. VTS in selected areas. International: Port Operations Canada: VTS - British Columbia coast area. Also used for pilotage purposes.
12	12	12	T/R: 156.60	T/R: 156.60	US: Port Operations. VTS in selected areas. International: Port Operations Canada: VTS - British Columbia coast area. Also used for pilotage purposes.
13	13	13	T/R: 156.65	T/R: 156.65	US: Intership Navigation Safety (Bridge-to-bridge). Ships >20m length maintain a listening watch on this channel in US waters. International: Intership, Port Operations Canada: VTS - British Columbia coast area. Also used for pilotage purposes.
14	14	14	T/R: 156.70	T/R: 156.70	US: Port Operations. VTS in selected areas. International: Port Operations Canada: VTS - British Columbia coast area. Also used for pilotage purposes.
15	15	15	T/R: 156.75 (US: Rx Only)	T/R: 156.75	US: Environmental (Receive only). Used by Class C Emergency Position-Indicating Radio Beacons (EPIRBs). International: Intership, Port Operations Canada: Port operations and Ship Movement - British Columbia coast area. All operations limited to 1-watt maximum power. May also be used for on-board communications.
16	16	16	T/R: 156.80	T/R: 156.80	US: International Distress, Safety and Calling. Ships required to carry radio, US Coast Guard (USCG), and most coast stations maintain a listening watch on this channel. International: International Distress, Safety and Calling Canada: International Distress, Safety and Calling
17	17	17	T/R: 156.85	T/R: 156.85	US: State Control International: Intership, Port Operations Canada: Port operations and Ship Movement - British Columbia coast area. All operations limited to 1 watt maximum power. May also be used for on-board communications.
	18		T: 156.90 R: 161.50	T: 161.50 R: 156.90	International: Public Correspondence, Port Operations
18a		18a	T/R: 156.90	T/R: 156.90	US: Commercial Canada: Towing - British Columbia coast area.
	19		T: 156.95 R: 161.55*	T: 161.55* R: 156.95	International: Public Correspondence, Port Operations
19a		19a	T/R: 156.95	T/R: 156.95	US: Commercial Canada: DFO/Canadian Coast Guard. Pacific Pilots - British Columbia coast area.
20	20	20	T: 157.00 R: 161.60	T: 161.60 R: 157.00	US: Port Operations (Duplex) International: Public Correspondence, Port Operations Canada: Port operations only with 1 watt maximum power.
20a			T/R: 157.00	T/R: 157.00	US: Port Operations
	21		T: 157.05 R: 161.65*	T: 161.65* R: 157.05	International: Public Correspondence, Port Operations

Table 2-1: Maritime Frequencies

CHANNEL			FREQUENCY		CHANNEL USAGE
US	INTL	CA	SHIP (MHz)	SHORE (MHz)	
21a		21a	T/R: 157.05	T/R: 157.05	US: US Coast Guard only Canada: DFO/Canadian Coast Guard only.
		21b	--	T/R: 161.65	
	22		T: 157.10 R: 161.70	T: 161.70 R: 157.10	International: Public Correspondence, Port Operations
22a		22a	T/R: 157.10	T/R: 157.10	US: Coast Guard Liaison and Maritime Safety Information Broadcasts. Broadcasts announced on channel 16. Canada: For communications between Canadian Coast Guard and non-Canadian Coast Guard stations only.
	23	23	T: 157.15 R: 161.75	T: 161.75 R: 157.15	International: Public Correspondence, Port Operations
23a			T/R: 157.15	T/R: 157.15	US: US Coast Guard only
		23b	--	T/R: 161.75	Canada: Continuous Marine Broadcast (CMB) service.
24	24	24	T: 157.20 R: 161.80	T: 161.80 R: 157.20	US: Public Correspondence (Marine Operator) International: Public Correspondence, Port Operations
25	25	25	T: 157.25 R: 161.85	T: 161.85 R: 157.25	US: Public Correspondence (Marine Operator) International: Public Correspondence, Port Operations Canada: Also assigned for operations in the Lake Winnipeg area.
		25b		T/R: 161.85	
26	26	26	T: 157.30 R: 161.90	T: 161.90 R: 157.30	US: Public Correspondence (Marine Operator) International: Public Correspondence, Port Operations
27	27	27	T: 157.35 R: 161.95	T: 161.95 R: 157.35	US: Public Correspondence (Marine Operator) International: Public Correspondence, Port Operations
28	28	28	T: 157.40 R: 162.00	T: 162.00 R: 157.40	US: Public Correspondence (Marine Operator) International: Public Correspondence, Port Operations
		28b	--	T/R: 162.00	Canada: Continuous Marine Broadcast (CMB) service.
	60	60	T: 156.025 R: 160.625	T: 160.625 R: 156.025	International: Public Correspondence, Port Operations
	61		T: 156.075 R: 160.675	T: 160.675 R: 156.075	International: Public Correspondence, Port Operations
		61a	T/R: 156.075	T/R: 156.075	Canada: DFO/Canadian Coast Guard only in British Columbia coast area.
	62		T: 156.125 R: 160.725	T: 160.725 R: 156.125	International: Public Correspondence, Port Operations
		62a	T/R: 156.125	T/R: 156.125	Canada: DFO/Canadian Coast Guard only in British Columbia coast area.
	63		T: 156.175 R: 160.775	T: 160.775 R: 156.175	International: Public Correspondence, Port Operations

Table 2-1: Maritime Frequencies

CHANNEL			FREQUENCY		CHANNEL USAGE
US	INTL	CA	SHIP (MHz)	SHORE (MHz)	
63a		63a	T/R: 156.175	T/R: 156.175	US: Port Operations and Commercial, VTS. New Orleans/Lower Mississippi area. Canada: Tow Boats - British Columbia coast area.
	64	64	T: 156.225 R: 160.825	T: 160.825 R: 156.225	International: Public Correspondence, Port Operations
		64a	T/R: 156.225	T/R: 156.225	Canada: Commercial fishing only.
	65		T: 156.275 R: 160.875	T: 160.875 R: 156.225	International: Public Correspondence, Port Operations
65a		65a	T/R: 156.275	T/R: 156.275	US: Port Operations Canada: Search and rescue and antipollution operations on the Great Lakes. Towing on the Pacific Coast. Port operations only in the St. Lawrence River areas with 1 watt maximum power. Intership in inland Manitoba, Saskatchewan, and Alberta areas.
	66		T: 156.325 R: 160.925	T: 160.925 R: 156.325	International: Public Correspondence, Port Operations
66a		66a	T/R: 156.325	T/R: 156.325	US: Port Operations Canada: Port operations only in the St. Lawrence River/Great Lakes areas with 1 watt maximum power. 1 watt marina channel - British Columbia coast area.
67	67	67	T/R: 156.375	T/R: 156.375	US: Commercial. Used for Bridge-to-bridge communications in lower Miss. River. Intership only. International: Intership, Port Operations Canada: May also be used for communications with aircraft engaged in coordinated search and rescue and antipollution operations. Commercial fishing only in east coast and inland Manitoba, Saskatchewan, and Alberta areas. Pleasure craft - British Columbia coast area.
68	68	68	T/R: 156.425	T/R: 156.425	US: Non-Commercial International: Port Operations Canada: For marinas, yacht clubs and pleasure craft.
69	69	69	T/R: 156.475	T/R: 156.475	US: Non-Commercial International: Intership, Port Operations Canada: Commercial fishing only - east coast area. Pleasure craft - British Columbia coast area.
70	70	70	T/R: 156.525	T/R: 156.525	US: Digital Selective Calling (voice communications not allowed) International: Digital selective calling for distress, safety and calling Canada: Digital selective calling for distress, safety and calling
71	71	71	T/R: 156.575	T/R: 156.575	US: Non-Commercial International: Port Operations Canada: Ship Movement - British Columbia coast area. Marinas and yacht clubs - east coast and on Lake Winnipeg.
72	72	72	T/R: 156.625	T/R: 156.625	US: Non-Commercial (Intership only) International: Intership Canada: May be used to communicate with aircraft and helicopters in predominantly maritime support operations. Pleasure craft - British Columbia coast area

Table 2-1: Maritime Frequencies

CHANNEL			FREQUENCY		CHANNEL USAGE
US	INTL	CA	SHIP (MHz)	SHORE (MHz)	
73	73	73	T/R: 156.675	T/R: 156.675	US: Port Operations International: Intership, Port Operations Canada: May also be used for communications with aircraft engaged in coordinated search and rescue and antipollution operations. Commercial fishing only in east coast and inland Manitoba, Saskatchewan, and Alberta areas.
74	74	74	T/R: 156.725	T/R: 156.725	US: Port Operations International: Port Operations Canada: VTS and Ship Movement British Columbia coast area.
	75	75	T/R: 156.775	T/R: 156.775	International: Port Operations Canada: Simplex port operation, ship movement and navigation related communication only. 1 watt maximum.
	76	76	T/R: 156.825	T/R: 156.825	International: Port Operations Canada: Simplex port operation, ship movement and navigation related communication only. 1 watt maximum.
77	77	77	T/R: 156.875	T/R: 156.875	US: Port Operations (Intership only) International: Intership Canada: Pilotage - British Columbia coast area; 25 watts. Port operations only in the St. Lawrence River/Great Lakes areas with 1 watt maximum power.
	78		T: 156.925 R: 161.525	T: 161.525 R: 156.925	International: Public Correspondence, Port Operations
78a		78a	T/R: 156.925	T/R: 156.925	US: Non-Commercial Canada: Fishing Industry - British Columbia coast area.
	79		T: 156.975 R: 161.575	T: 161.575 R: 156.975	International: Public Correspondence, Port Operations
79a		79a	T/R: 156.975	T/R: 156.975	US: Commercial. Non-Commercial in Great Lakes only Canada: Fishing Industry - British Columbia coast area.
	80		T: 157.025 R: 161.625	T: 161.625 R: 157.025	International: Public Correspondence, Port Operations
80a		80a	T/R: 157.025	T/R: 157.025	US: Commercial. Non-Commercial in Great Lakes only Canada: Fishing Industry - British Columbia coast area.
	81		T: 157.075 R: 161.675	T: 161.675 R: 157.075	International: Public Correspondence, Port Operations
81a		81a	T/R: 157.075	T/R: 157.075	US: US Government only - Environmental protection operations Canada: DFO/Canadian Coast Guard use only.
	82		T: 157.125 R: 161.725	T: 161.725 R: 157.125	International: Public Correspondence, Port Operations
82a		82a	T/R: 157.125	T/R: 157.125	US: US. Government only Canada: DFO/Canadian Coast Guard use only.
	83		T: 157.175 R: 161.775	T: 161.775 R: 157.175	International: Public Correspondence, Port Operations
83a		83a	T/R: 157.175	T/R: 157.175	US: US Coast Guard only Canada: DFO/Canadian Coast Guard and other Government agencies.

Table 2-1: Maritime Frequencies

CHANNEL			FREQUENCY		CHANNEL USAGE
US	INTL	CA	SHIP (MHz)	SHORE (MHz)	
		83b	--	T/R: 161.775	
84	84	84	T: 157.225 R: 161.825	T: 161.825 R: 157.225	US: Public Correspondence (Marine Operator) International: Public Correspondence, Port Operations
85	85	85	T: 157.275 R: 161.875	T: 161.875 R: 157.275	US: Public Correspondence (Marine Operator) International: Public Correspondence, Port Operations
86	86	86	T: 157.325 R: 161.925	T: 161.925 R: 157.325	US: Public Correspondence (Marine Operator) International: Public Correspondence, Port Operations
87			T/R: 157.375	T/R: 157.375	US: Public Correspondence (Marine Operator)
	87	87	T: 157.375 R: 161.975	T: 161.975 R: 157.375	International: Port Operations Canada: Port operation and ship movement - east coast area. Pleasure craft - British Columbia coast area.
AIS1		87b	T/R: 161.975	T/R: 161.975	US: Automatic Identification System Canada: Automatic Ship Identification and Surveillance System.
	88	88	T: 157.425 R: 162.025	T: 162.025 R: 157.425	US: Commercial, Intership only. International: Port Operations Canada: Port operation and ship movement - British Columbia coast area.
88a			T/R: 157.425	T/R: 157.425	US: Commercial, Intership only. Canada: Automatic Ship Identification and Surveillance System.
		88b	T/R: 162.025	T/R: 162.025	
WX1		WX1		R: 162.55	Weather Channel 1 (receive only).
WX2		WX2		R: 162.4	Weather Channel 2 (receive only).
WX3		WX3		R: 162.475	Weather Channel 3 (receive only).
WX4				R: 162.425	Weather Channel 4 (receive only).
WX5				R: 162.45	Weather Channel 5 (receive only).
WX6				R: 162.5	Weather Channel 6 (receive only).
WX7				R: 162.525	Weather Channel 7 (receive only).



## 3 SPECIFICATIONS<sup>1</sup>

### 3.1 GENERAL

<b>Dimensions, Front-Mount Radio:</b> (Height x Width x Depth)	2.4 x 6.9 x 11.3 inches (6.1 x 17.5 x 28.7 centimeters) (Includes knobs but <u>not</u> space required for mounting bracket and cables at rear of radio)
<b>Dimensions, Remote-Mount 35/50W Radio:</b> (Height x Width x Depth)	2.0 x 6.9 x 9.2 inches (5.1 x 17.5 x 23.4 centimeters) (Does <u>not</u> include space required for mounting bracket and cables at rear of radio)
<b>Dimensions, Remote-Mount 110W Radio:</b> (Height x Width x Depth)	2.4 x 6.93 x 11.0 inches (6.1 x 17.6 x 28.0 centimeters) (Does <u>not</u> include space required for mounting bracket and cables at rear of radio)
<b>Dimensions, CH-721 Control Head:</b> (Height x Width x Depth)	2.4 x 6.9 x 3.9 inches (6 x 17.5 x 10 centimeters) (Does <u>not</u> include bracket and mounting screws)
<b>Dimensions, HHC-731 Hand-Held Controller:</b> (Height x Width x Depth)	5.3 x 2.8 x 1.3 inches (13.46 x 7.11 x 3.30 cm) (Does <u>not</u> include swivel hanger and coiled cord)
<b>Weight, Front-Mount Radio:</b>	5.9 pounds (2.68 kilograms), does not include bracket
<b>Weight, Remote-Mount 35/50-Watt Radio:</b>	5.25 pounds (2.38 kilograms), does not include bracket
<b>Weight, CH-721 Control Head:</b>	1.25 pounds (0.57 kilograms), does not include bracket
<b>Weight, HHC-731 Hand-Held Controller:</b>	1.0 pound (0.45 kilograms), does not include bracket and interface cable to radio
<b>Operating Ambient Temperature Range:</b>	-22 to +140° Fahrenheit (-30 to +60° Celsius)
<b>Storage Temperature Range:</b>	-40 to +185° Fahrenheit (-40 to +85° Celsius)
<b>Altitude:</b>	15,000 feet (4572 meters) maximum
<b>DC Supply Voltage Operating Ranges</b>	
For Full Performance:	+13.6 Vdc ±10% (Normal range per TIA-603)
Overall Operating Range:	+10.8 to +16.6 Vdc
Continuous without Damage:	0 to +17 Vdc
<b>DC Supply Current Requirements</b>	
Receive (includes CH-721 control head):	
With Speaker Muted:	1.1 amps maximum
With 0.5-Watt Speaker Output Power:	1.5 amps maximum
With 10-Watt Speaker Output Power:	3.5 amps maximum
With 15-Watt Speaker Output Power:	4.0 amps maximum
Transmit (includes CH-721 control head):	
50-Watt VHF Radio at 10 Watts RF:	8.9 amps maximum, 8.5 amps typical
50-Watt VHF Radio at 20 Watts RF:	9.6 amps maximum, 9 amps typical
50-Watt VHF Radio at 50 Watts RF:	15 amps maximum, 11 amps typical
110-Watt VHF Radio at 110 Watts RF:	25 amps maximum, 23 amps typical
UHF Radio at 50 Watts RF:	15 amps maximum, 13 amps typical
700 & 800 MHz Radio at 15 Watts RF:	8 amps maximum, 6 amps typical
700 & 800 MHz Radio at 35 Watts RF:	15 amps maximum, 12 amps typical
HHC-731 Hand-Held Controller:	0.5 amps maximum

<sup>1</sup> These specifications are primarily intended for the use of the installation technician. See the appropriate Specifications Sheet for the complete specifications.

**Quiescent/Off Currents**

Mobile Radio:	2 milliamps maximum
CH-721 Control Head:	100 microamps maximum
HHC-731 Hand-Held Controller:	500 microamps maximum

**3.2 TRANSCEIVER**

<b>Frequency Range of VHF Radios:</b>	136 to 174 MHz (transmit and receive)
<b>Frequency Range of UHF-L Radio:</b>	378 to 430 MHz (transmit and receive)
<b>Frequency Range of UHF-H Radio:</b>	440 to 512 MHz (transmit and receive)
<b>Frequency Ranges of 700 &amp; 800 MHz Radio</b>	
Receive:	
700 MHz Operation:	764 to 767 MHz, 769 to 775 MHz and 773 to 776 MHz (repeater and talk-around operations) [See footnote <sup>2</sup> ]
800 MHz Operation:	851 to 869 MHz (repeater and talk-around operations)
Transmit:	
700 MHz Talk-Around Operation:	764 to 767 MHz, 769 to 775 MHz and 773 to 776 MHz
700 MHz Repeater Operation:	794 to 797 MHz, 799 to 805 MHz and 803 to 806 MHz [See footnote <sup>3</sup> ]
800 MHz Talk-Around Operation:	851 to 869 MHz
800 MHz Repeater Operation:	806 to 824 MHz
<b>Transmit Power of 50-Watt VHF Radio:</b>	10 to 50 watts (programmable range)
<b>Transmit Power of 110-Watt VHF Radio:</b>	10 to 110 watts (programmable range)
<b>Transmit Power of UHF Radio:</b>	8 to 50 watts (programmable range)
<b>Transmit Power of 700 &amp; 800 MHz Radio</b>	
700 MHz Band:	1.5 to 30 watts (programmable range)
800 MHz Band, OpenSky:	5 to 30 watts (programmable range)
800 MHz Band, EDACS/ProVoice/P25:	5 to 35 watts (programmable range)
800 MHz Band, Analog Conventional:	5 to 35 watts (programmable range)
<b>Channel Spacing:</b>	12.5 kHz or 25 kHz or 30 kHz (mode dependent)
<b>Voice and Data Communications Modes:</b>	Half-Duplex
<b>Frequency Stability:</b>	±1.5 ppm with AFC disabled; ±0.5 ppm with AFC
<b>Receiver Sensitivity:</b>	
Analog Mode:	better than -117.5 dBm (0.3 μV) at 12 dBm SINAD
P25 Mode (TIA-102 Method):	better than -116 dBm (0.35 μV) at 5% static BER
<b>Audio Frequency Response:</b>	300 to 3000 Hz (transmit and receive)
<b>Microphone Input Sensitivity:</b>	82 ±28 mV rms (typical)
<b>Microphone Maximum Input Level:</b>	2500 mV peak-to-peak

<sup>2</sup> 764 to 767 MHz and 773 to 776 MHz per old FCC 700 MHz band plan. 769 to 775 MHz added August 30, 2007 by new FCC 700 MHz band plan.

<sup>3</sup> 764 to 767 MHz, 773 to 776 MHz, 794 to 797 MHz and 803 to 806 MHz per old FCC 700 MHz band plan. 769 to 775 MHz and 799 to 805 MHz added August 30, 2007 by new FCC 700 MHz band plan.

<b>Microphone Input Impedance:</b>	600 ohms
<b>Microphone Audio Frequency Response:</b>	±0.5 dB from 100 Hz to 3000 Hz
<b>Microphone Connector:</b>	17-pin Conxall-style flush-mount thumbscrew-locking connector located on front panel of CH-721 control head
<b>Microphone Types Available:</b>	Standard, DTMF, and Noise-Canceling
<b>Speaker Audio Output Power:</b>	15 watts RMS minimum into 4-ohm external speaker
<b>Speaker Audio Output Distortion:</b>	< 5% at 15 watts RMS into 4-ohm external speaker
<b>Headset Audio Output Power</b>	
At CH-721 Microphone Connector:	1 watt minimum into 4-ohm headset/speaker
At CH-721 DB-25 Rear Panel Connector:	35 milliwatts maximum into 24-ohm headset
At HHC-731 DB-25 Connector:	1 watt minimum into 8-ohm headset/speaker
<b>External Speaker Connection</b>	
Local Control (Front-Mount Radio):	2-pin audio connector on radio's option cable
Remote Control (Trunk-Mount Radio):	2-pin audio connector on rear of control head
Remote Control with HHC-731:	DB-44 connector on rear of radio
<b>Mic A-D and Speaker D-A Audio Conversion</b>	
CODEC Audio Sampling Rate:	8 kHz
CODEC Algorithm (Vocoding Method):	Sigma-Delta ( $\Sigma\Delta$ )
<b>Voice-Coding Method</b>	
OTP Mode:	Advanced Multi-Band Excitation (AMBE <sup>®</sup> )
EDACS, ProVoice, P25 Phase I Modes:	Improved Multi-Band Excitation (IMBE <sup>®</sup> )
<b>Data Rate</b>	
OTP Mode:	19.2 kbps (9600 symbols per second)
EDACS and ProVoice Modes:	9.6 kbps
P25 Mode:	4800 symbols/second

### **3.3 REGULATORY**

#### **FCC Type Acceptance**

VHF 50-Watt Radio:	OWDTR-0055-E
VHF 110-Watt Radio:	OWDTR-0056-E
UHF-L Radio:	OWDTR-0061-E
UHF-H Radio:	OWDTR-0062-E
700 and 800 MHz Radio:	OWDTR-0060-E (formerly OWDTR-0051-E)

**Applicable FCC Rules:** Part 15, Part 80 and Part 90

#### **Industry Canada Certification**

VHF 50-Watt Radio:	3636B-0055
VHF 110-Watt Radio:	3636B-0056
UHF-L Radio:	3636B-0061
UHF-H Radio:	3636B-0062
700 and 800 MHz Radio:	3636B-0051

**Applicable Industry Canada Rules:** RSS-119

## 4 INTRODUCTION

This manual contains installation procedures for the M7300 mobile radio, the CH-721 control heads, and the HHC-731 hand-held controller. Procedures cover the mounting and cabling of the equipment, as well as basic in-vehicle test procedures. In addition, product safety-related information is included.

### 4.1 GENERAL DESCRIPTION

The M7300 mobile radio is a high-performance digital mobile radio. Shown in Figure 6-1 and Figure 6-2 on pages 44 and 45 respectively, the radio series includes:

- VHF Band (136 to 174 MHz) 50-Watt Radio
- VHF Band (136 to 174 MHz) 110-Watt Radio
- Low-Split UHF Band (378 to 430 MHz) Radio
- High-Split UHF Band (440 to 512 MHz) Radio
- Dual-Band 700 and 800 MHz Radio

Supported radio systems/standards are listed in Table 4-1 below.

The M7300 radio is designed to operate in a mobile environment, typically within a motor vehicle. It must be connected to an external transmit/receive antenna such as one mounted to the vehicle's rooftop or trunk lid. Several different types of external-mount antennas are approved and available for use with the radio, as listed in Table 1-1 through Table 1-5, and in Table 5-6.

Front-mount and remote-mount M7300 radio configurations are available. In the front-mount configuration, the control head is an integral part of the mobile radio. In the remote-mount configuration, the control head is located near the radio operator's position and the radio is mounted remotely from the control head, typically in the vehicle's trunk. As described later in this section, an HHC-731 hand-held controller can be connected to a remote-mount radio, in place of the CH-721 control head. The remote-mount radio is shown in Figure 6-1 on page 44.

**Table 4-1: Radio Systems/Standards Supported by the M7300 Mobile Radio**

RADIO SYSTEM/STANDARD	VHF RADIOS (136 to 174 MHz)	UHF-L RADIO (378 to 430 MHz)	UHF-H RADIO (440 to 512 MHz)	DUAL-BAND RADIO (700 and 800 MHz)
APCO Project 25 (P25) Trunked	✓	✓	✓	✓
APCO Project 25 (P25) Conventional	✓	✓	✓	✓
OpenSky <sup>®</sup>	—	—	—	✓
Enhanced Digital Access Communications System (EDACS <sup>®</sup> ) and ProVoice <sup>™</sup>	✓	✓	✓	✓
Conventional FM Repeater-Based and FM Talk-Around	✓	✓	✓	✓

✓ = Supported.

VHF and UHF M7300 radios can provide 50 watts of transmit output power in full-power transmit mode. A 110-watt version of the VHF radio is also available.

The dual-band 700 and 800 MHz M7300 radio can provide 30 watts of transmit output power in full-power transmit mode in the 700 MHz band. When operating in the 800 MHz band, maximum transmitter power output is 30 watts in OpenSky mode and 35 watts in the EDACS/ProVoice and P25 modes.

Control heads used with the M7300 radio include the CH-721 Scan and the CH-721 System model control heads. See Figure 9-5 (page 81) through Figure 9-7 (page 82). Both heads feature a large 3-line graphical vacuum-fluorescent display, front panel controls and buttons/keys for user control of the mobile radio, an internal high-power audio amplifier to drive an externally-connected speaker, and a front panel microphone connector. The CH-721 System control head also has a 12-button numeric keypad that provides Dual-Tone Multi-Frequency (DTMF) functionality and easier operator system/group selection control at the control head's front panel.

In a remote-mount M7300 mobile radio installation, the HHC-731 hand-held controller can be used in place of the CH-721 control head. This easy-to-use hand-held mobile radio controller is primarily designed for use in harsh environments such as maritime (i.e., boating) applications and All-Terrain Vehicle (ATV) applications. The HHC-731 hand-held controller has easy-to-use buttons, a tough liquid-crystal display (LCD), and a built-in microphone. As of the publication of this manual, only one (1) HHC-731 hand-held controller can be connected to a radio, and without any connected CH-721 control heads. The front of the HHC-731 hand-held controller is shown in Figure 9-12 on page 90.

The remote-mount M7300 radio is designed for remote mounting in a motor vehicle's trunk, or some other preferably unoccupied section in a vehicle, such as a fire truck's equipment shelf. Up to four (4) control heads can be connected to a front-mount M7300, and up to five (5) control heads can be connected to a remote-mount M7300. The radio is remotely controlled by a control head(s) connected to it via 3-wire Controller Area Network (CAN) cables. Between the radio and control head(s), the CAN link carries digitized microphone and speaker audio, controlling data such as button presses and radio messages, and user data such as that for a mobile data terminal connected to the serial port of the radio or control head. For proper operation, the CAN link must be terminated appropriately on each end. In multiple control head installations, two or more control heads are interconnected to the mobile radio in a series ("daisy-chain") fashion via CAN link cables.

As shown in Figure 9-7 on page 82, the CH-721 Scan and System model control heads used in remote-mount radio installations have several connectors located on the head's rear panel. These connectors include a DC power connector, two (2) CAN port connectors used for CAN link interconnections, an external speaker connector, a 9-pin serial port connector for connecting optional equipment such as a mobile data terminal, and a 25-pin accessory connector. Both CH-721 models can interface to an optional Federal Signal Electronic siren/light control system for broadcasting via a public address (PA) speaker.

The radio and control head/hand-held controller must be powered by an external +13.6-volt (nominal) DC power source. In mobile applications, the motor vehicle's electrical system is utilized as the source of DC power. In a remote-mount radio installation, the CH-721 control head(s) or the HHC-731 hand-held controller connected to the radio is also powered by the same DC power source, but separately fused. When the control head/hand-held controller is powered-up by the operator, it "wakes up" the radio by transmitting data to the radio via the CAN link.

The radio provides half-duplex voice and data communications. Voice communications are accomplished via a "push-to-talk" (PTT) type microphone and an external speaker connected to the control head. The HHC-731 hand-held controller has an integrated microphone and PTT button/key. When a control head is employed in a mobile radio installation, an audio amplifier in the head drives the speaker. When the hand-held controller is employed, an audio amplifier in the remote-mounted mobile radio drives the speaker.

For data communications, the radio has an industry-standard 9-pin serial interface port for connecting optional data-type equipment, such as a Mobile Data Terminal (MDT), a laptop PC, an external display, or a key-entry device. This port works seamlessly with equipment from popular manufacturers and off-the-shelf applications. OpenSky employs User Datagram Protocol over Internet Protocol (UDP/IP) data packet transfers, providing "plug and play" connectivity for data-type devices.

The radio has an optional built-in Global Positioning System (GPS) tracking receiver. On an OpenSky trunked radio network, the GPS tracking receiver can provide quick and accurate unit location

information to dispatchers via the radio network. The GPS receiver determines the unit's location and the radio transmits it to the network, either when polled by the network or automatically on a predetermined periodic basis. The GPS antenna can be integrated into the mobile transmit/receive antenna (i.e., a "combination" antenna). Alternately, the GPS antenna can be located/mounted completely separate from the mobile transmit/receive antenna.

The M7300 mobile radio, the CH-721 control head and the HHC-731 hand-held controller exceed tough environmental specifications included within military standard MIL-STD-810F, the radio industry standard TIA/EIA-603, and the radio standard established by the U.S. Forest Service.

An M7300 radio operating on an OpenSky radio network uses Time-Division Multiple-Access (TDMA) digital modulation technology on the radio frequency link. TDMA allows multiple radio users to share a single RF channel. In addition, a single RF channel can support simultaneous digital voice and data communications.

OpenSky employs Advanced Multi-Band Excitation (AMBE<sup>®</sup>) speech and data compression technology developed by Digital Voice Systems, Inc. When operating on an OpenSky radio network, AMBE gives an M7300 the ability to provide exceptional voice quality via the limited bandwidth of the radio frequency path, even when the received RF signal is weak (i.e., even in "fringe" areas). AMBE is performed by a Digital Signal Processor (DSP) integrated circuit within the radio programmed to perform an AMBE compression algorithm during mobile transmissions, and an AMBE expansion algorithm during mobile reception.

Speech compression electronic circuitry—be it AMBE or another type such as IMBE<sup>®</sup>—is sometimes referred to as "vocoding" circuitry for voice coding, or simply a "vocoder" circuit.

The M7300 mobile radio supports operation on APCO Project 25 phase I compliant Common Air Interface (P25 CAI) trunked radio networks, and operation in a talk-around mode in accordance with the APCO Project 25 phase I standard. P25 radio systems utilize Improved Multi-Band Excitation (IMBE) speech and data compression technology, also developed by Digital Voice Systems, Inc.

The M7300 mobile radio can also operate using Harris' digital voice technology called ProVoice. Like P25 radio systems, ProVoice also employs IMBE technology.

EDACS and ProVoice trunked radio networks employ analog FM and 2-level Gaussian Frequency-Shift Keying (GFSK) modulation techniques on the RF channels. Data is transmitted on an RF channel at a 9600 bits-per-second rate.

For over-the-air secure radio communications, the M7300 mobile radio may be equipped for 64-bit DES (Data Encryption Standard) encryption or 128/256-bit AES (Advanced Encryption Standard) encryption. With encryption, voice and/or user data signals transmitted and received by the radio on an RF channel are digitally encrypted ("scrambled") to virtually eliminate unauthorized monitoring via the RF channel.



**Harris recommends the buyer use only an authorized representative to install and service this product.** The warranties provided to the buyer under the terms of sale shall be null and void if this product is installed or serviced improperly, and Harris shall have no further obligation to the buyer for any damage caused to the product or to any person or personal property.

## 4.2 RADIO PROGRAMMING

Unless otherwise stated, all radio installation and test procedures presented in this manual assume the radio has been programmed by radio network administration personnel before it is delivered to radio installation personnel.

### **4.2.1 EDACS/ProVoice, Conventional and P25 (ECP) Modes**

Radio Personality Manager (RPM) software application TQS3385 (part number SK-104768-001) is used to program the M7300 mobile radio for operations in EDACS, ProVoice, and P25 trunked radio systems. TQS3385 can also be used to program the radio for analog conventional and P25 conventional operations. For additional information, refer to RPM's built-in online help and/or RPM Software Release Notes, publication number MS-012550-001.

Conventional RPM software application TQS3389 (part number SK-012177-001) is used to program the M7300 mobile radio for analog conventional and P25 conventional operations. Trunking mode programming is disabled in TQS3389. For additional information, refer to RPM's built-in online help and/or Conventional RPM Software Release Notes, publication number MS-012761-001.

Serial programming cable interconnection diagrams are included in the RPM built-in online help. Refer to RPM Release R6A (or later) for additional information.

Both RPM applications also support other radios such as the M7100, M7200, and Unity XG-100M mobile radios, and the P7100, P7200, P7300, and Unity XG-100P portable radios.

### **4.2.2 OpenSky (OTP) Mode**

The Remote Device Configuration (RDC) software application can be used to remotely or locally load customer-specific configuration parameters into the M7300 radio. Parameters such as the radio's initial set of RF channels, user ID number, and IP address, can be easily loaded via a serial link between the RDC computer and M7300 radio. Other parameters, including higher-level parameters which more uniquely configure a radio, can be remotely loaded over-the-air from the RDC.

For complete details on using the RDC application, refer to the RDC's user manual, publication number MM23020. The RDC's Media Kit part number is SK22444-0001, and its Distribution Kit part number is MATQ-S3423 (previously ST23516-0001). RDC Software Release Notes are provided in publication number MS231234-0001. Configuration-related information is included in the M7300 mobile radio maintenance manuals; the respective manual publication numbers are listed in the following section.

## **4.3 RELATED PUBLICATIONS**

The following publications contain additional information about the M7300 mobile radio:

- Quick Guide for OpenSky mode: MM-014368-001
- Quick Guide for EDACS, Conventional and P25 (ECP) modes: MM-014369-001
- Operator's Manual for all modes: MM-014716-001
- Operator's Manual for HHC-731 hand-held controller: MM-018321-001
- Maintenance Manual for 50-Watt VHF radio (includes CH-721 maintenance manual): MM-017065-001
- Maintenance Manual for UHF radios (includes CH-721 maintenance manual): MM-019034-001
- Maintenance Manual for 700 and 800 MHz radio (includes CH-721 maintenance manual): MM-014718-001

A Quick Guide is included with each mobile radio equipment package when it ships from the factory. Quick Guides and the Operator's Manuals are available at [www.pspc.harris.com](http://www.pspc.harris.com) without a login. Obtaining a maintenance manual or an installation manual from that web site requires an Information Center log-in, then browsing to Tech Link's Technical Manual Library.

## 4.4 REPLACEMENT PARTS

Replacement parts can be ordered via our Customer Care center. To order replacement parts, call, fax or e-mail:

### United States:

- Phone Number: 1-800-368-3277
- Fax Number: 1-321-409-4393
- E-mail: [PSPC\\_CustomerFocus@harris.com](mailto:PSPC_CustomerFocus@harris.com)

### International:

- Phone Number: 1-434-455-6403
- Fax Number: 321-409-4394
- E-mail: [PSPC\\_InternationalCustomerFocus@harris.com](mailto:PSPC_InternationalCustomerFocus@harris.com)

## 4.5 TECHNICAL ASSISTANCE

If any of the radio equipment requires repair, or if there are questions or concerns about the installation of this equipment, contact the Harris Technical Assistance Center (TAC) using the following telephone numbers or e-mail address:

- United States and Canada: 1-800-528-7711 (toll free)
- International: 1-434-385-2400
- Fax: 1-434-455-6712
- E-mail: [PSPC\\_tac@harris.com](mailto:PSPC_tac@harris.com)



## 5 UNPACKING AND CHECKING THE EQUIPMENT

### 5.1 MATERIALS

A typical set of materials for an M7300 mobile radio installation includes:

- **M7300 Mobile Radio** — See Table 5-1 below for catalog and part numbers.
- **CH-721 Scan or System Control Head** — See Table 5-2 below for catalog and part numbers.
- **Installation Kit MAMW-NZN6W for Front-Mount M7300** — Contents listed in Table 5-3.  
 or:  
**Installation Kit MAMW-NZN7R for Remote-Mount M7300 and CH-721** — Contents listed in Table 5-4.  
 or:  
**Installation Kit MAMW-ZN9Q for Remote-Mount 110-Watt VHF M7300 and CH-721** — See the NOTE that follows Table 5-4 for details on the contents of this kit.
- **One or Two Antennas** — See Table 5-6. (A second antenna is required for the GPS receiver.)
- **Microphone** — See Table 5-7 for microphone part numbers.

In some cases, the radio may be supplied with an HHC-731 hand-held controller instead of a CH-721 control head and a microphone. In this case, all installation-related components for the radio and the controller are supplied with kit MAMW-NZN9G, as listed in Table 5-5. Since this kit includes radio installation-related components, standard Installation Kits MAMW-NZN6W or MAMW-NZN7R are not required.

**Table 5-1: M7300 Mobile Radio Catalog and Part Numbers**

CATALOG NUMBER	RADIO PART NUMBER	DESCRIPTION
MAMW-SHMXX	RU-144750-041	VHF 50-Watt M7300 Mobile Radio for Front and Remote-Mount Configurations
MAMW-SHHXX	RU-144750-051	VHF 110-Watt M7300 Mobile Radio for Remote-Mount Configurations
MAMW-SNMXX	RU-144750-021	Low-Split UHF (378 to 430 MHz) 50-Watt M7300 Mobile Radio for Front and Remote-Mount Configurations
MAMW-SUMXX	RU-144750-031	High-Split UHF (440 to 512 MHz) 50-Watt M7300 Mobile Radio for Front and Remote-Mount Configurations
MAMW-SDMXX	RU-144750-061	700 & 800 MHz Dual-Band M7300 Mobile Radio for Front and Remote-Mount Configurations

Table 5-2: CH-721 Control Head and HHC-731 Controller Catalog and Part Numbers

CONTROL HEAD CATALOG NUMBER	CONTROL HEAD PART NUMBER	DESCRIPTION
MAMW-NCP9G	CU23218-0001	CH-721 Scan Control Head, Local-Control for Use on a Front-Mount Mobile Radio
MAMW-NCP9E	CU23218-0002	CH-721 Scan Control Head, Remote-Control for Use with a Remote-Mount Mobile Radio
MAMW-NCP9H	CU23218-0003	CH-721 System Control Head, Local-Control for Use on a Front-Mount Mobile Radio
MAMW-NCP9F	CU23218-0004	CH-721 System Control Head, Remote-Control for Use with a Remote-Mount Mobile Radio
MAMW-NCP9P	CU-017821-001	HHC-731 Hand-Held Controller

## 5.2 MATERIAL INSPECTION









After removal from the carton, examine the radio, control head and other components for broken, damaged, loose or missing parts. If any are noted, contact the Customer Care center (see page 32) immediately to discuss and arrange the return of the equipment to Harris for replacement. Any unauthorized attempts to repair or modify this equipment will void the warranty and could create a safety hazard.

Upon removing items from the carton and verifying that all equipment is accounted for, proceed with the installation.



Mounting of the radio, control head, and/or antenna in ways other than those described in this manual may adversely affect performance, violate FCC rules on RF exposure, and even damage the unit, posing a potential safety hazard.





**Table 5-3: Installation Kit MAMW-NZN6W  
for Front-Mount M7300 Mobile Radio**

ITEM	QTY.	PART NUMBER	DESCRIPTION	ILLUSTRATION
1	1 <input type="checkbox"/>	KT101533V1	Kit, Front-Mount Mounting Bracket. Includes M5300/M7100/M7300 Mounting Bracket FM101319V1 (marked KTB0310), M5 stainless-steel hardware to attach radio to bracket, self-tapping hardware to attach bracket to mounting surface, ½-inch rubber grommet, and 7-inch cable ties. See Section 8.1 on page 60.	
2	1 <input type="checkbox"/>	CA-012365-001	Cable, M5300/M7300 DC Power. Includes 10-AWG, 20-Foot DC Power Cable with straight connector, (2) waterproof HFB fuse holders, (1) 20-amp AGC fuse, (1) 15-amp AGC fuse and (1) 3-amp AGC fuse. See CAUTION that follows. See Section 8.2 on page 64.	
3	2 <input type="checkbox"/>	CD-014027-001	Terminator, CAN; 3-Pin, Straight Body. See Section 8.3 on page 69.	
4	1 <input type="checkbox"/>	LS102824V10	Speaker, External Mobile; 20-Watt (with 4.6-foot cable). See Section 10.1 on page 96.	
5	1 <input type="checkbox"/>	CA-012349-001	Cable, M5300/M7300 Option. See Section 12.1 (page 99).	
6	1 <input type="checkbox"/>	FM-104859-001	Cap, Waterproof (For covering M7300's DB-9 serial port connector).	

**Table 5-4: Installation Kit MAMW-NZN7R  
for 35/50-Watt Remote-Mount M7300 Mobile Radio with CH-721 Control Head**

ITEM	QTY.	PART NUMBER	DESCRIPTION	ILLUSTRATION
1	1 <input type="checkbox"/>	KT23117	Kit, Remote-Mount Mobile Radio Mounting Bracket. Includes M5300/M7100/M7300 Mounting Bracket FM103111V1 and M5 stainless-steel hardware to attach radio to bracket. See Section 9.1 on page 70.	
2	1 <input type="checkbox"/>	KT-008608	Kit, CH-721 Mounting Bracket. Includes (1) U-Shaped Mounting Bracket and #8 stainless-steel hardware to attach control head to bracket. See Section 9.3.2 on page 83.	
3	1 <input type="checkbox"/>	CA-012365-001	Cable, M5300/M7300 DC Power. Includes 10-AWG, 20-Foot DC Power Cable with straight connector, (2) waterproof HFB fuse holders, (1) 20-amp AGC fuse, (1) 15-amp AGC fuse and (1) 3-amp AGC fuse. See the CAUTION that follows and Section 9.2 on page 74.	
4	1 <input type="checkbox"/>	CA-012616-001	Cable, CH-721/HHC-731 DC Power. Includes 12-AWG, 10-foot DC Power Cable with straight connector, (2) waterproof HFB fuse holders, (1) 3-amp AGC fuse, and (1) 5-amp AGC fuse. See Section 9.3.4 on page 86.	
5	2 <input type="checkbox"/>	CD-014027-001	Terminator, CAN; 3-Pin, Straight Body. See Section 9.3.3.2 on page 86.	

**Table 5-4: Installation Kit MAMW-NZN7R  
for 35/50-Watt Remote-Mount M7300 Mobile Radio with CH-721 Control Head (Continued)**

ITEM	QTY.	PART NUMBER	DESCRIPTION	ILLUSTRATION
6	1 <input type="checkbox"/>	CA-009562-030	Cable, CAN; 30 feet, Right-Angle-to-Straight Connectors. See Section 9.3.3 on page 84.	
7	1 <input type="checkbox"/>	LS102824V10	Speaker, External Mobile; 20-Watt (with 4.6-foot cable). See Section 10.2 on page 97.	
8	1 <input type="checkbox"/>	MAMROS0034-NN006	Cable, Speaker; 6-Inch, Straight Connector. Section 10.2 on page 97.	
9	2 <input type="checkbox"/>	FM-104859-001	Cap, Waterproof (For DB-9 serial port connectors on radio and control head.)	 [See footnote <sup>4</sup> ]
10	2 <input type="checkbox"/>	FM-104859-002	Cap, Waterproof (For DB-25 connectors on radio and control head.)	 [See footnote <sup>4</sup> ]



For 35 and 50-Watt radios, do **not** use the 20-amp fuse included with DC Power Cable CA-012365-001. With these radios, radio main power should be protected with the 15-amp fuse included with the cable. Refer to Section 15 for additional information.





The 110-Watt VHF M7300 radio requires a 25-amp fuse. This fuse is included with the DC Power Cable 14002-0167-01.





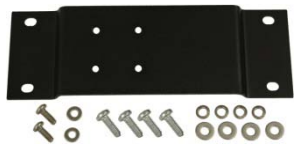

Installation Kit MAMW-ZN9Q for the 110-watt VHF M7300 mobile radio includes the same items as Installation Kit MAMW-NZN7R shown in Table 5-4 above except Mounting Bracket KT23117 (item 1) is replaced by Mounting Bracket KT101533V2 and DC Power Cable CA-012365-001 (item 3) is replaced by DC Power Cable 14002-0167-01. DC Power Cable 14002-0167-01 has 6-AWG red and black wires.

<sup>4</sup> Earlier installation kits contained only one (1) each of FM-104859-001 and FM-104859-002.

**Table 5-5: HHC-731 Hand-Held Controller Installation Kit MAMW-NZN9G**

ITEM	QTY.	PART NUMBER	DESCRIPTION	ILLUSTRATION
1	1 <input type="checkbox"/>	CA-018399-001	Cable, HHC-731 Interface	
2	1 <input type="checkbox"/>	KT-018752-001	Kit, HHC-731 Interface Cable Bracket	
3	1 <input type="checkbox"/>	KT23117	Kit, Remote-Mount Mobile Radio Mounting Bracket. Includes M5300/M7100/M7300 Mounting Bracket FM103111V1 and M5 stainless-steel hardware to attach radio to bracket. See Section 9.1 on page 70.	
4	1 <input type="checkbox"/>	CA-012365-001	Cable, M5300/M7300 DC Power. Includes 10-AWG, 20-Foot DC Power Cable with straight connector, (2) waterproof HFB fuse holders, (1) 20-amp AGC fuse, (1) 15-amp AGC fuse and (1) 3-amp AGC fuse. See the CAUTION on page 37 and Section 9.2 on page 74.	
5	1 <input type="checkbox"/>	CA-012616-001	Cable, CH-721/HHC-731 DC Power. Includes 12-AWG, 10-foot DC Power Cable with straight connector, (2) waterproof HFB fuse holders, (1) 3-amp AGC fuse, and (1) 5-amp AGC fuse. See Section 9.4.3 on page 92.	
6	1 <input type="checkbox"/>	CD-014027-001	Terminator, CAN; 3-Pin, Straight Body. See Section 9.4.2 on page 91.	

**Table 5-5: HHC-731 Hand-Held Controller Installation Kit MAMW-NZN9G (Continued)**

ITEM	QTY.	PART NUMBER	DESCRIPTION	ILLUSTRATION
7	1 <input type="checkbox"/>	CA-009562-030	Cable, CAN; 30 feet, Right-Angle-to-Straight Connectors. See Section 9.4.2 on page 91.	
8	1 <input type="checkbox"/>	LS102824V10	Speaker, External Mobile; 20-Watt (with 4.6-foot cable). See Section 10.2.2 on page 97.	
9	1 <input type="checkbox"/>	CA-012349-007	Cable, Speaker-Only Option, 20-feet. See Section 10.2.2 on page 97.	
10	1 <input type="checkbox"/>	FM-104859-002	Cap, Waterproof (For HHC-731 Interface Cable's DB-25 option connector.)	



For 35 and 50-Watt radios, do **not** use the 20-amp fuse included with DC Power Cable CA-012365-001. With these radios, radio main power should be protected with the 15-amp fuse included with the cable. Refer to Section 15 for additional information.

The 110-Watt VHF M7300 radio requires a 25-amp fuse. This fuse is included with the DC Power Cable 14002-0167-01.

Table 5-6: Additional Options and Accessories for M7300 Mobile Radios

PART NUMBER	DESCRIPTION
AN-125001-001	Antenna Mount: Standard Rooftop, NMO Mounting Base, 15-foot (4.6-meter) RG-58 A/U (or equivalent) Low-Loss RF Cable, Male TNC RF Connector
AN-125001-002	Antenna Mount: Standard Rooftop, NMO Mounting Base, 15-foot (4.6-meter) RF-195 (or equivalent) Low-Loss RF Cable, Male TNC RF Connector
AN-125001-003	Antenna Mount: Thick Rooftop, NMO Mounting Base, 15-foot (4.6-meter) RG-58 A/U (or equivalent) Low-Loss RF Cable, Male TNC RF Connector
AN-125001-004	Antenna Mount: Thick Rooftop, NMO Mounting Base, 15-foot (4.6-meter) RF-195 (or equivalent) Low-Loss RF Cable, Male TNC RF Connector
AN-125001-005	Antenna Mount: GPS Combo, Standard Rooftop, NMO Mounting Base, 17-foot (5.1-meter) RF-195 (or equivalent) Low-Loss RF Cable, Male TNC RF Connector; 17-foot (5.1-meter) RG174/U (or equivalent) GPS RF Cable with Male SMA RF Connector (attached); 2.7 to 3.3 Vdc or 4.8 to 5.2 Vdc Bias
AN-125001-006	Antenna Mount: GPS Combo Rooftop, NMO Mounting Base, 17-foot (5.1-meter) RF-195 (or equivalent) Low-Loss RF Cable, Male TNC RF Connector; 17-foot (5.1-meter) RG174/U (or equivalent) GPS RF Cable with Male SMA RF Connector (attached); 2.7 to 3.3 Vdc or 4.8 to 5.2 Vdc Bias
AN-125001-007	Antenna Mount: Magnetic, NMO Mounting Base, 15-foot (4.6-meter) RG-58 A/U (or equivalent) Low-Loss RF Cable, Male TNC RF Connector
AN-125001-008	Antenna Mount: Magnetic, NMO Mounting Base, 15-foot (4.6-meter) RF-195 (or equivalent) Low-Loss RF Cable, Male TNC RF Connector
AN-225002-001	Antenna Element: 136 to 174 MHz, 0 dBd Gain, NMO, Factory-Tuned
AN-225003-001	Antenna Element: 378 to 430 MHz, 0 dBd Gain, NMO, Factory-Tuned
AN-225003-004	Antenna Element: 378 to 430 MHz, 0 dBd Gain, Low-Profile, NMO, Factory-Tuned
AN-225004-001	Antenna Element: 450 to 512 MHz, 0 dBd Gain, NMO, Factory-Tuned
AN-225004-004	Antenna Element: 450 to 512 MHz, 0 dBd Gain, Low-Profile, NMO, Factory-Tuned
AN-225001-001	Antenna Element: 700/800 MHz, 3 dBd Gain, NMO, Factory-Tuned
AN-225001-002	Antenna Element: 700/800 MHz, 3 dBd Gain, Elevated-Feed, NMO, Factory-Tuned
AN-225001-003	Antenna Element: 700/800 MHz, 3 dBd Gain, Elevated-Feed No Ground Plane, NMO, Factory-Tuned
AN-225001-004	Antenna Element: 700/800 MHz, 2 dBd Gain, Low-Profile, NMO, Factory-Tuned
AN-225001-005	Antenna Element: 700/800 MHz, 5 dBd Gain, NMO, Factory-Tuned
AN-225006-001	Antenna Element: 132 to 960 MHz, 0 dBd Gain, NMO, Field-Tuned*
AN-025187-001 (Cat. No. MAMW-NAN5F)	Antenna, GPS Receive Only, Roof-Mount, 17-foot (5.2-meter) RG174/U (or equivalent) RF Cable with Male SMA RF Connector (attached); 2.7 to 3.3 Vdc or 4.8 to 5.2 Vdc Bias
AN-025187-003 (Cat. No. MAMW-NAN3L)	Antenna, GPS Receive Only, Magnetic-Mount, 17-foot (5.2-meter) RG174/U (or equivalent) RF Cable with Male SMA RF Connector (attached); 2.7 to 3.3 Vdc or 4.8 to 5.2 Vdc Bias
CA-012349-001 (Cat. No. MAMW-NCL8B)	Cable, M5300/M7300 Option. See page 99.
19B802554P24	Cable, Accessory. See page 106.
CA-013671-020	Cable, Serial Data (20 feet). See page 108.



**Table 5-6: Additional Options and Accessories for M7300 Mobile Radios (Continued)**

<b>PART NUMBER</b>	<b>DESCRIPTION</b>
CN-014756	Connector, RF; TNC Male Crimp-Type for RG58U, RG58A/U and RGU400 Coaxial Cable
KT-012350-001 (Cat. No. MAMW-NMK5F)	Kit, GPS Receiver for M5300/M7300
MAMW-NZN7C	Kit, CH-721 Scan Control Head with Installation Hardware. Kit for adding a Scan model control head to a new or existing radio installation.
MAMW-NZN7D	Kit, CH-721 System Control Head with Installation Hardware. Kit for adding a System model control head to a new or existing radio installation.
KT-015037	Kit, Conversion, Front-Mount to Remote-Mount, M5300/M7300. Includes CH-721 Conversion Kit, CH-721 Mounting Bracket Kit, CH-721 DC Power Cable, CAN Cable, CAN Terminator, Speaker Cable, Etc.
KT-014494-002	Kit, Conversion, Remote-Mount to Front-Mount, M5300/M7300 and CH-721
CD-014027-001	Terminator, CAN, 3-Pin, Straight Body

\* Driven element of AN-225006-001 must be trimmed to proper length in order to minimize antenna system VSWR.

Table 5-7: Additional Options and Accessories for CH-721 Control Heads

PART NUMBER	DESCRIPTION
CA-009562-006	Cable, CAN; 6 feet, Right-Angle-to-Straight Connectors
CA-009562-030	Cable, CAN; 30 feet, Right-Angle-to-Straight Connectors
CA-009562-090	Cable, CAN; 90 feet, Right-Angle-to-Straight Connectors
CA-009562-250	Cable, CAN; 250 feet, Right-Angle-to-Straight Connectors
CA-011854-001	Cable, CH-721 Option
CA-104861	Cable, CH-721 Programming
CA-103541-001	Cable, CH-721 Mic Connector Programming
MAMROS0075-N1210	Cable, DC Power; 12-AWG, 10-Foot, Straight Connector
MAMROS0075-N1220	Cable, DC Power; 12-AWG, 20-Foot, Straight Connector
MAMROS0075-R1210	Cable, DC Power; 12-AWG, 10-Foot, Right-Angle Connector
MAMROS0075-R1220	Cable, DC Power; 12-AWG, 20-Foot, Right-Angle Connector
MACDOS0012	Kit, Control Head Gimbal Mounting Pedestal (Includes Gimbal Mounting Pedestal and (4) #8-32 Pan-Head Screws)
MACDOS0013-CN004	Kit, Speaker; 20-Watt, Straight Connector. (Includes 4-Ohm 20-Watt Speaker LS102824V10 with 4.6-Foot Cable and 6-Inch Speaker Cable MAMROS0034-NN006.)
MC-101616-041	Microphone, Standard with Conxall Flush-Mount 90-Degree Connector (Included with catalog number MAMW-NMC7Z)
MC-103334-040	Microphone, DTMF with Conxall Flush-Mount 45-Degree Connector (Included with catalog number MAMW-NMC9C)
MC-103334-041	Microphone, DTMF with Conxall Flush-Mount 90-Degree Connector
MC-103334-051	Microphone, Noise-Canceling with Conxall Flush-Mount 90-Degree Connector (Included with catalog number MAMW-NMC9D)
344A4678P1	Microphone Hanger (Included with catalog numbers MAMW-NMC7Z, MAMW-NMC9C and MAMW-NMC9D)
CD-014027-001	Terminator, CAN; 3-Pin, Straight Body
MACDOS0010	Terminator, CAN; 3-Pin, Right-Angle Body

## 6 PLANNING THE INSTALLATION

### 6.1 GENERAL INFORMATION

Before starting, plan the installation carefully so it will meet the following requirements:

- The installation is safe for the operator and passengers within the vehicle.
- The equipment is installed away from the airbag deployment areas.
- The installation allows for convenient access by the operator, as applicable (i.e., the control head or hand-held controller).
- The equipment is protected from water damage.
- The installation is neat and allows easy service access.
- The mobile radio is mounted in a location assuring the vehicle occupant's safety and out of the way of passengers and auto mechanics.



A professional radio installer should perform the installation!

### 6.2 TOOLS REQUIRED

The following tools are recommended to complete the installation. Where specific vendor names and model or part numbers are given, equivalent substitutes may be used:

- Non-Insulated Crimp Tool: Thomas & Betts WT-111-M
- Insulated Terminal Crimp Tool: Klein 1005
- Fuse Holder Crimp Tool: Thomas & Betts – WT-112M or California Terminal Products No. 1250 or Channelock No. 909
- 3-Blade Coax Cable Stripper for RG-58 Cable similar to Tyco Electronics 1490490-1 (includes blades)
- Ratcheting Hex-Crimp Tool for 50-Ohm TNC and BNC RF Connectors and RG-58 Cable similar to Tyco Electronics 58433-2 (includes Crimper 354940-1 and Die Set 58436-1) or Emerson Network Power 24-9960P
- Non-Metallic Fish Tape, 25-Foot: Klein-Lite 50156
- Various Socket and Driver Sets
- Soft-Jaw Pliers: Tescos 450520 or equivalent
- Phillips-Head Screwdrivers, #1 and #2
- Flat-Blade Screwdrivers, #1 and #2
- 4-Millimeter Hex Key Wrench
- 1/8-Inch Hex Key Wrench (Allen Wrench)
- 5/16-Inch Combination or Open-End Wrench (Only Needed for GPS Receiver Option)
- 3/4-Inch or 3/8-Inch Hole Saw with Depth Protection: 3/4-Inch = Ripley HSK 19 or Antenex HS34; 3/8-Inch = Antenex HS38
- Clutch-Type Cordless Drill with Drill Bits and Driver Bits
- Deburring Tool (for 3/8-inch and smaller holes)
- Flush-Cut and Large Wire Cutters
- Various Fasteners (e.g., machine screws and nuts, Tek screws, etc.)
- Tie Wraps: Nylon, 6-inches or larger



A separate list of test equipment is included in Section 16.2 on page 114.

**FRONT VIEWS**

**Front-Mount 35/50-Watt M7300  
Mobile Radio**  
(With Scan Control Head)



**Remote-Mount 35/50-Watt M7300  
Mobile Radio**



**REAR VIEW**

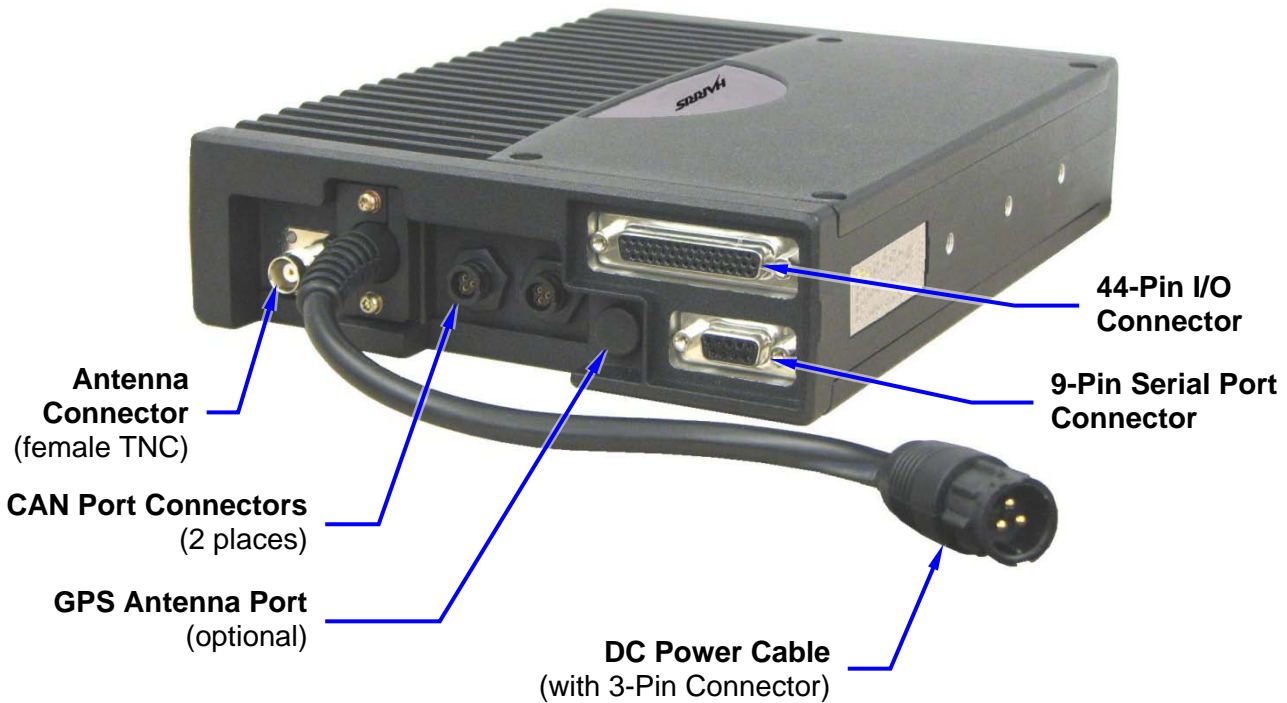

**Figure 6-1: M7300 Front-Mount and Remote-Mount 35/50-Watt Mobile Radios — Front and Rear Views**

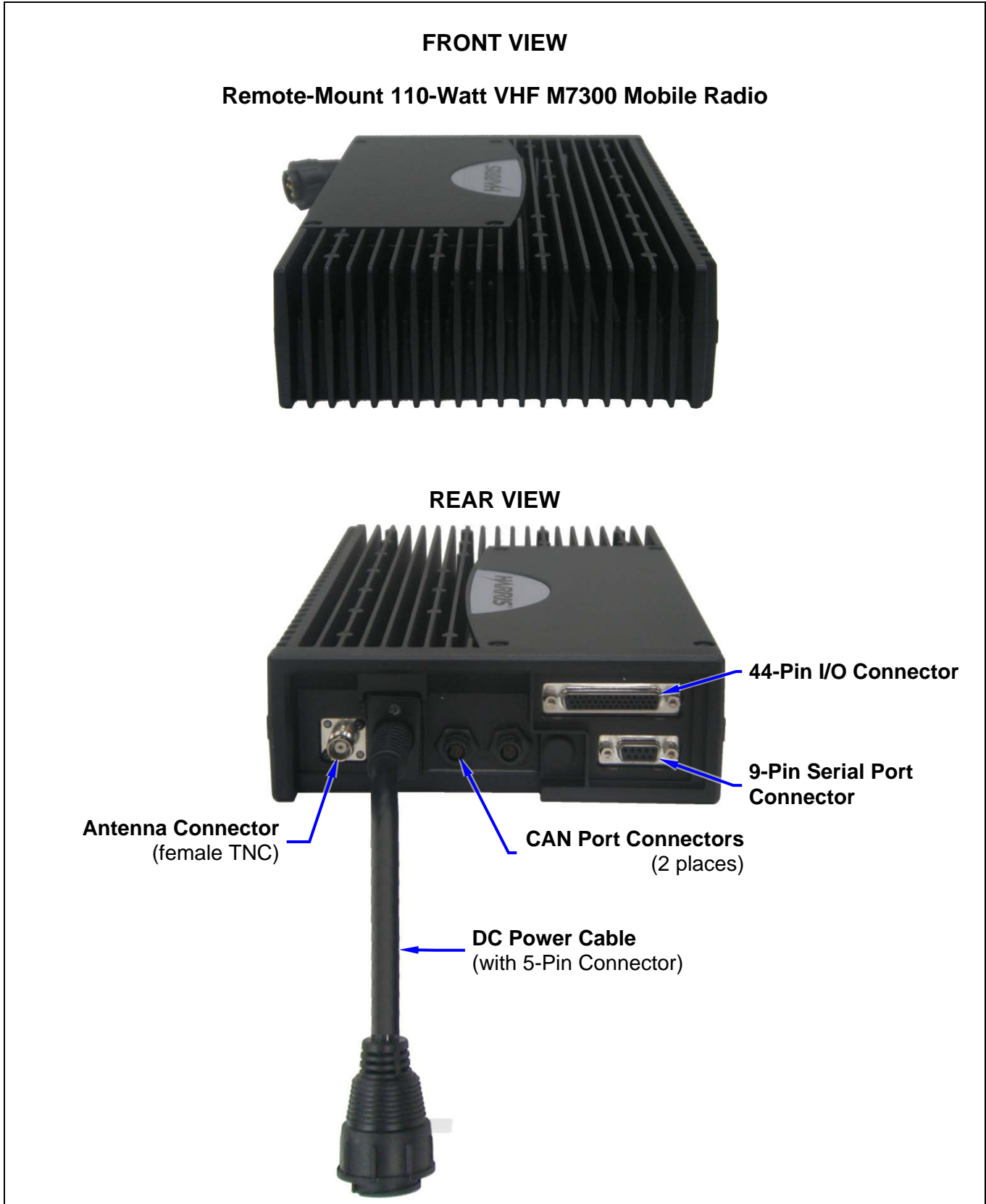

**Figure 6-2: M7300 Remote-Mount 110-Watt Mobile Radios — Front and Rear Views**

## 6.3 LOCATING COMPONENTS

Plan the mounting locations of all components (radio, control head/hand-held controller, antenna, and cables) and determine the routes for all wiring and cables. Particularly consider the connection of the radio for planning purposes.

- Determine the customer's preferences, if any, for location of components. Comply with these preferences as long as they are consistent with safety recommendations and guidelines presented in this manual, and other generally accepted professional radio installation practices.
- For a front-mount installation, the radio is typically located under the vehicle's dash panel. However, it may be mounted above the dash, or at some other location per customer requirements, available space, and/or mounting surface strength. Dimensions for the radio, control head, and hand-held controller are listed in Section 3.1 on page 25. As noted in that section, these dimensions do not include space required at the rear of the radio for cables. Several inches of clearance space is required.
- For a remote-mount radio installation, the radio is typically located in the motor vehicle's trunk, or some other preferably unoccupied section in a vehicle, such as a fire truck's equipment shelf. The control head is typically located under the vehicle's dash panel. Dimensions for the radio, control head, and hand-held controller are listed in Section 3.1 on page 25. As noted in that section, these dimensions do not include space required at the rear of the radio and control head for cables. Several inches of clearance space is required at the back of the control head, and at least six (6) inches is recommended at the back of the radio. In addition, several inches of clearance space is required at each side of the radio for access to the screws that secure the radio to its mounting bracket.
- When selecting a mounting location, verify sufficient clearance behind the radio can be maintained so cables will not be stressed, crushed, twisted, or bent at severe angles. This also applies to the control head in a remote-mount radio installation. Also, the front and sides of the units must have clearance for air circulation, access to mounting screws, mounting hardware, etc.
- Verify the drilling of holes and the insertion of screws will not damage or interfere with any existing vehicle components (for example, a fuel tank, fuel lines, the transmission housing, etc.), or any existing vehicle wiring.
- For antenna location and installation-related information, refer to Section 7.



The radio must be kept out of direct sunlight and away from heat sources. Adequate free-air ventilation must be provided to its rear fins. The radio will automatically reduce its transmit RF output power when its ambient temperature exceeds approximately +140° Fahrenheit (+60° Celsius).



All cables should have a service loop near each connector end. Do not bend the cables at severe angles near the connector end. Above all, after all components are installed, verify no cable is under any tension. Failure to do so may lead to damaged cables, causing intermittent radio operation or complete radio failure.

## 7 ANTENNA INSTALLATION

### 7.1 ANTENNA MOUNTING LOCATIONS



**At this time, review all information presented in the REGULATORY AND SAFETY INFORMATION section of this manual (see page 7). A transmitting antenna must be installed in accordance with the guidelines presented in both the REGULATORY AND SAFETY INFORMATION section, and in this section.**

As a guide for determining the best possible mounting location in order to reduce human exposure to radio frequency (RF) electromagnetic energy during transmit mode, refer to the following:

- For a 50-Watt VHF Radio: See Table 1-1 and Figure 7-1.
- For a 110-Watt VHF Radio: See Table 1-2 and Figure 7-1.
- For a Low-Split UHF Radio (378 to 430 MHz): See Table 1-3 and Figure 7-2.
- For a High-Split UHF Radio (440 to 512 MHz): See Table 1-4 and Figure 7-3.
- For a 700/800 MHz Radio: See Table 1-5 and Figure 7-4.

Antennas must be mounted in one of four (4) possible locations on the vehicle. Figure 7-1 through Figure 7-4 shows the recommended locations and antenna part numbers. Also, see Table 5-6 for additional information. Always follow the antenna manufacturer's instructions when mounting an antenna.

#### **7.1.1 Direct Center or Center-Rear of Rooftop**

The center of the vehicle's roof is the best location for a rooftop-mount antenna (location ❶ in the following figures). For optimal performance, the mounting area under the antenna must be flat with a minimum radius of six (6) inches of metal ground plane. It must be located directly in the center of the roof to minimize human exposure to RF electromagnetic energy. Other obstructions such as a light bar or another antenna may prevent the antenna from being mounted in the direct center of the roof. In this case, the antenna should be mounted a minimum of one foot away from and behind the obstruction but in the middle of the roof with respect to the left and right sides of the vehicle (location ❷ in the following figures).

#### **7.1.2 Center of Trunk Lid**

Certain vehicles do not allow for the antenna to be placed in the center or center-rear of the roof. In this case, the next best location for the antenna is in the direct center of the trunk lid (location ❸ in the following figures). In this case, an elevated-feed-point antenna is recommended. Although this type of antenna does not require a metal ground plane, it must be located directly in the center of the trunk lid to minimize human exposure to RF electromagnetic energy.

#### **7.1.3 Rear Deck Lid for Stand-Alone GPS Receive Antenna**

If the M7300 mobile radio does not use a GPS combination-type antenna and it is equipped with a GPS receiver, a stand-alone GPS receive antenna must be separately located and mounted. The vehicle's rear deck lid (location ❹ in the following figures) is the recommended mounting location for this case. This locates the GPS antenna inside the vehicle.

**TOP VIEW OF A TYPICAL VEHICLE**

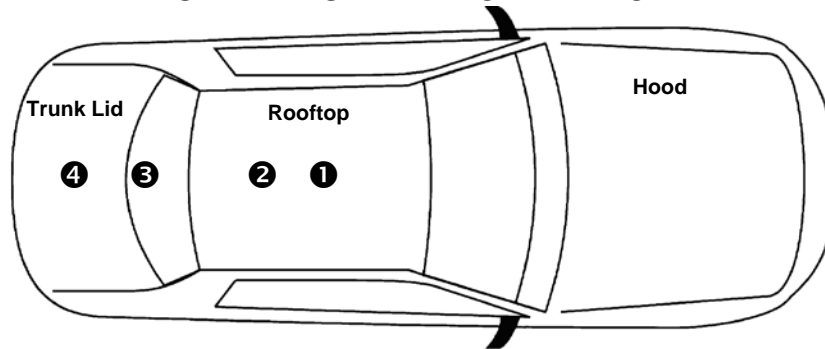

ANTENNA PART NUMBER	ANTENNA DESCRIPTION*	LOCATION(S)			
		4	3	2	1
AN-125001-001 (mount) with AN-225002-001 (element)	136 to 174 MHz, Standard Rooftop-Mount, 0 dBd Gain				✓
AN-125001-001 (mount) with AN-225006-001 (element)	132 to 960 MHz, Standard Rooftop-Mount, 0 dBd Gain				✓
AN-125001-003 (mount) with AN-225002-001 (element)	136 to 174 MHz, Thick Rooftop-Mount, 0 dBd Gain				✓
AN-125001-003 (mount) with AN-225006-001 (element)	132 to 960 MHz, Thick Rooftop-Mount, 0 dBd Gain				✓
AN-125001-005 (mount) with AN-225002-001 (element)	136 to 174 MHz, GPS Combo Standard Rooftop-Mount, 0 dBd Gain				✓
AN-125001-007 (mount) with AN-225002-001 (element)	136 to 174 MHz, Magnetic-Mount, 0 dBd Gain				✓
AN-125001-007 (mount) with AN-225006-001 (element)	132 to 960 MHz, Magnetic-Mount, 0 dBd Gain				✓
AN102800V1 (Discontinued)	136 to 941 MHz Standard Rooftop-Mount, ¼-Wave, 0 dBd Gain				✓
AN-025187-001	GPS Receive Only, Roof-Mount	✓	✓	✓	
AN-025187-003	GPS Receive Only, Magnetic-Mount	✓	✓	✓	

\* See Table 5-6 on page 40 for detailed antenna descriptions.

**Figure 7-1: Recommended VHF Antenna Mounting Locations with Antenna Part Numbers**



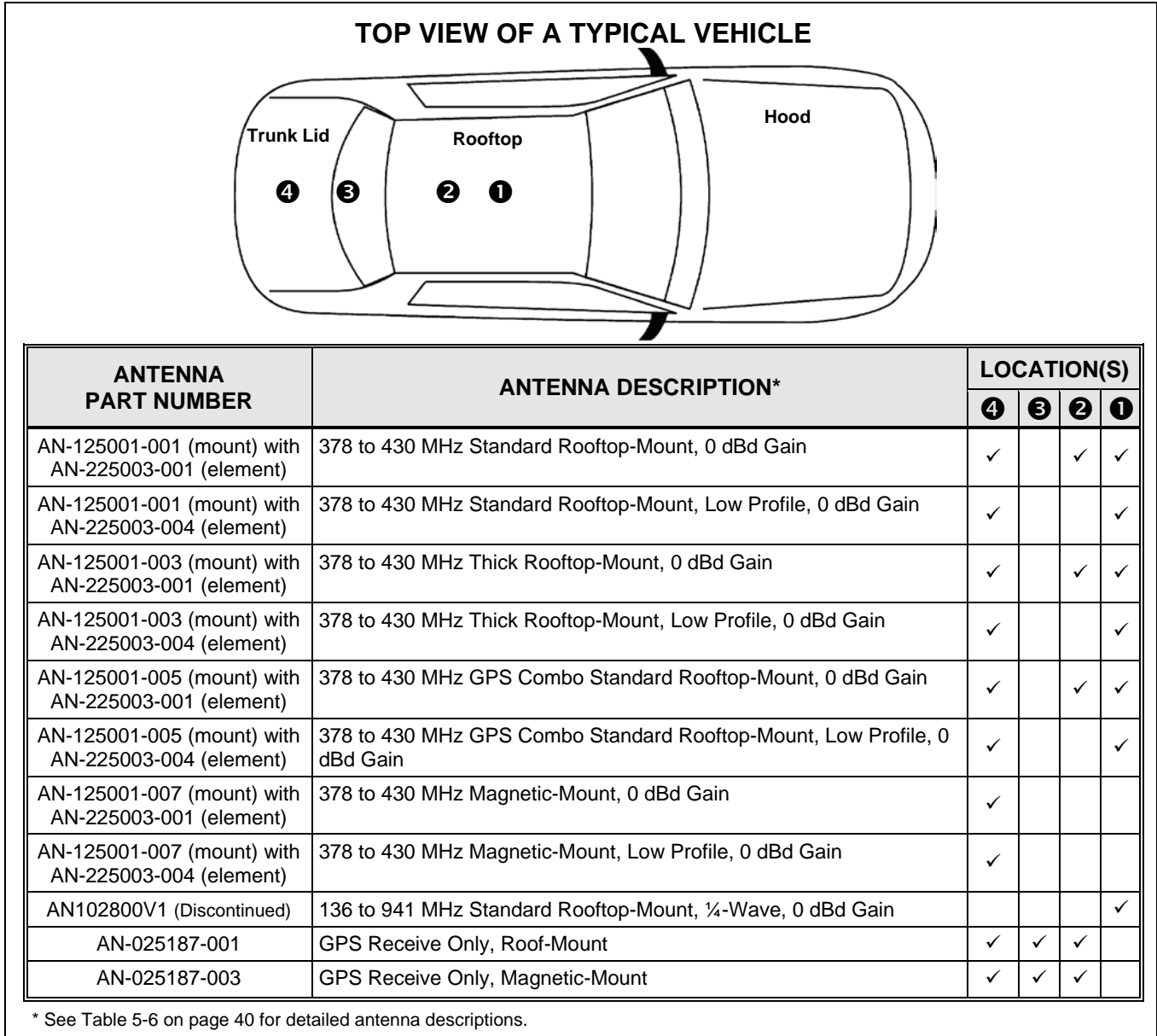

**Figure 7-2: Recommended Low-Split UHF Antenna Mounting Locations with Antenna Part Numbers**

**TOP VIEW OF A TYPICAL VEHICLE**

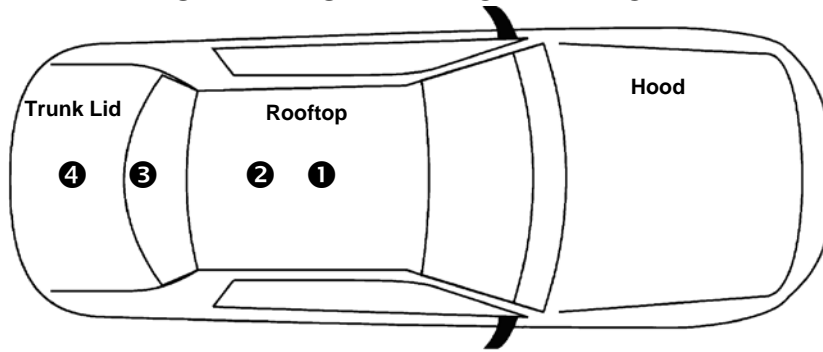

ANTENNA PART NUMBER	ANTENNA DESCRIPTION*	LOCATION(S)			
		4	3	2	1
AN-125001-001 (mount) with AN-225004-001 (element)	450 to 512 MHz Standard Rooftop-Mount, 0 dBd Gain	✓		✓	✓
AN-125001-001 (mount) with AN-225004-004 (element)	450 to 512 MHz Standard Rooftop-Mount, Low Profile, 0 dBd Gain	✓			✓
AN-125001-003 (mount) with AN-225004-001 (element)	450 to 512 MHz Thick Rooftop-Mount, 0 dBd Gain	✓		✓	✓
AN-125001-003 (mount) with AN-225004-004 (element)	450 to 512 MHz Thick Rooftop-Mount, Low Profile, 0 dBd Gain	✓			✓
AN-125001-005 (mount) with AN-225004-001 (element)	450 to 512 MHz GPS Combo Standard Rooftop-Mount, 0 dBd Gain	✓		✓	✓
AN-125001-005 (mount) with AN-225004-004 (element)	450 to 512 MHz GPS Combo Standard Rooftop-Mount, Low Profile, 0 dBd Gain	✓			✓
AN-125001-007 (mount) with AN-225004-001 (element)	450 to 512 MHz Magnetic-Mount, 0 dBd Gain	✓			
AN-125001-007 (mount) with AN-225004-004 (element)	450 to 512 MHz Magnetic-Mount, Low Profile, 0 dBd Gain	✓			
AN102800V1 (Discontinued)	136 to 941 MHz Standard Rooftop-Mount, ¼-Wave, 0 dBd Gain				✓
AN-025187-001	GPS Receive Only, Roof-Mount	✓	✓	✓	
AN-025187-003	GPS Receive Only, Magnetic-Mount	✓	✓	✓	

\* See Table 5-6 on page 40 for detailed antenna descriptions.

**Figure 7-3: Recommended High-Split UHF Antenna Mounting Locations with Antenna Part Numbers**

**TOP VIEW OF A TYPICAL VEHICLE**

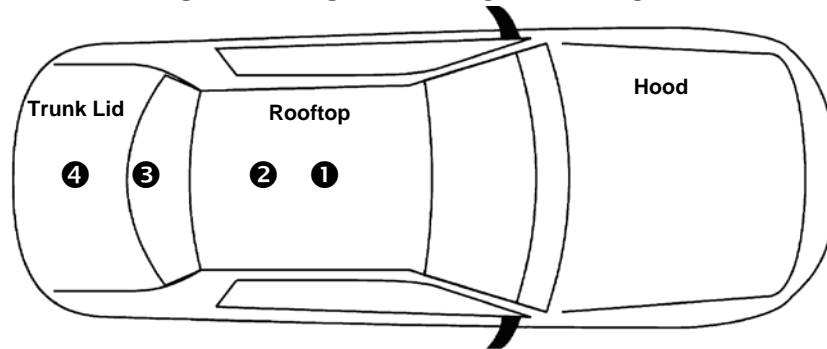

ANTENNA PART NUMBER	ANTENNA DESCRIPTION*	LOCATION(S)			
		4	3	2	1
AN-125001-002 (mount) with AN-225001-001 (element)	700/800 MHz Standard Rooftop-Mount, 3 dBd Gain	✓			✓
AN-125001-002 (mount) with AN-225001-002 (element)	700/800 MHz Elevated-Feed Rooftop-Mount, 3 dBd Gain	✓		✓	✓
AN-125001-002 (mount) with AN-225001-003 (element)	700/800 MHz Elevated-Feed No Ground Plane Rooftop-Mount, 3 dBd Gain	✓		✓	✓
AN-125001-002 (mount) with AN-225001-004 (element)	700/800 MHz Low-Profile Rooftop-Mount, 2 dBd Gain	✓			✓
AN-125001-002 (mount) with AN-225001-005 (element)	700/800 MHz Standard Rooftop-Mount, 5 dBd Gain				✓
AN-125001-004 (mount) with AN-225001-001 (element)	700/800 MHz Thick Rooftop-Mount, 3 dBd Gain	✓			✓
AN-125001-004 (mount) with AN-225001-002 (element)	700/800 MHz Elevated-Feed Thick Rooftop-Mount, 3 dBd Gain	✓		✓	✓
AN-125001-004 (mount) with AN-225001-003 (element)	700/800 MHz Elevated-Feed No Ground Plane Thick Rooftop-Mount, 3 dBd Gain	✓		✓	✓
AN-125001-004 (mount) with AN-225001-004 (element)	700/800 MHz Low-Profile Thick Rooftop-Mount, 2 dBd Gain	✓			✓
AN-125001-004 (mount) with AN-225001-005 (element)	700/800 MHz Thick Rooftop-Mount, 5 dBd Gain				✓
AN-125001-006 (mount) with AN-225001-001 (element)	700/800 MHz GPS Combo Rooftop-Mount, 3 dBd Gain	✓			✓
AN-125001-006 (mount) with AN-225001-002 (element)	700/800 MHz GPS Combo Elevated-Feed Rooftop-Mount, 3 dBd Gain	✓		✓	✓
AN-125001-006 (mount) with AN-225001-003 (element)	700/800 MHz GPS Combo Elevated-Feed No Ground Plane Rooftop-Mount, 3 dBd Gain	✓		✓	✓
AN-125001-006 (mount) with AN-225001-004 (element)	700/800 MHz GPS Combo Low-Profile Rooftop-Mount, 2 dBd Gain	✓			✓
AN-125001-006 (mount) with AN-225001-005 (element)	700/800 MHz GPS Combo Rooftop-Mount, 5 dBd Gain				✓
AN-125001-008 (mount) with AN-225001-001 (element)	700/800 MHz Magnetic-Mount, 3 dBd Gain	✓			✓
AN-125001-008 (mount) with AN-225001-002 (element)	700/800 MHz Magnetic-Mount Elevated-Feed, 3 dBd Gain	✓		✓	✓
AN-125001-008 (mount) with AN-225001-003 (element)	700/800 MHz Magnetic-Mount Elevated-Feed No Ground Plane, 3 dBd Gain	✓		✓	✓

TOP VIEW OF A TYPICAL VEHICLE

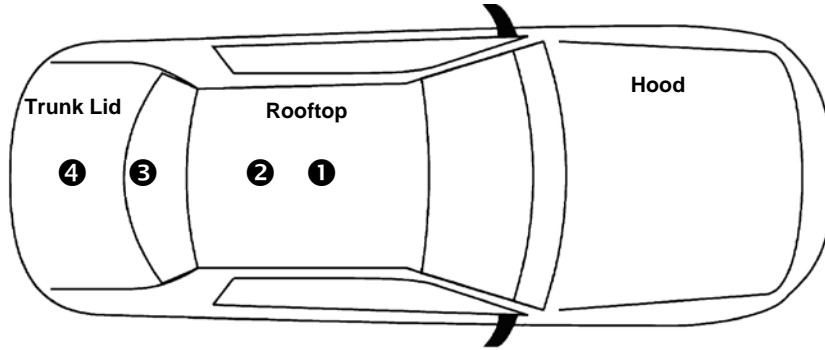

ANTENNA PART NUMBER	ANTENNA DESCRIPTION*	LOCATION(S)			
		4	3	2	1
AN-125001-008 (mount) with AN-225001-004 (element)	700/800 MHz Magnetic-Mount Low-Profile, 2 dBd Gain	✓			✓
AN-125001-008 (mount) with AN-225001-005 (element)	700/800 MHz Magnetic-Mount, 5 dBd Gain				✓
AN102800V1 (Discontinued)	136 to 941 MHz Standard Rooftop-Mount, ¼-Wave, 0 dBd Gain				✓
AN-025187-001	GPS Receive Only, Roof-Mount	✓	✓	✓	
AN-025187-003	GPS Receive Only, Magnetic-Mount	✓	✓	✓	

\* See Table 5-6 on page 40 for detailed antenna descriptions.

**Figure 7-4: Recommended 700/800 MHz Antenna Mounting Locations with Antenna Part Numbers**

## 7.2 ANTENNA INSTALLATION PROCEDURES



An antenna **must** be installed before completing the radio installation.

Table 5-6 (page 40) and Figure 7-1 through Figure 7-4 list the mobile radio antennas available for use with the respective radio. As presented in the previous section, various mounting locations exist. Optimal performance is achieved via a rooftop antenna mounted in the direct center of the motor vehicle's roof.

### 7.2.1 **Installing NMO Antenna Mounts AN-125001-001, -002, -003 and -004**

These NMO style antenna mounts can each be used with several different antenna elements. Only limited access under the mounting location is typically required. The installation procedure is presented in Section 7.2.1.3.

#### 7.2.1.1 **Standard NMO Antenna Mounts AN-125001-001 and AN-125001-002**

These standard 3/4-inch NMO antenna mounts require a 3/4-inch hole in a relatively flat area of the vehicle body, with a vehicle metal thickness of between 0.020 and 0.040 inches. AN-125001-002 has a very-low-loss coax cable (LMR/RF-195 or equivalent).

#### 7.2.1.2 **Thick-Roof NMO Antenna Mounts AN-125001-003 and AN-125001-004**

Both of these thick-roof NMO antenna mounts use either a 3/8-inch or a 3/4-inch mounting hole in a relatively flat area of the vehicle body, with a vehicle metal thickness of between 0.040 and 0.1875 inches (3/16-inch maximum thickness). AN-125001-004 has a very-low-loss coax cable (LMR/RF-195 or equivalent).



For thick-roof NMO antenna mounts AN-125001-003 or AN-125001-004, using a 3/8-inch mounting hole will require better access to the underside of the mounting location than if a 3/4-inch hole is used. This is because, in the case of a 3/8-inch hole, the antenna mount's bushing assembly **must** be inserted from the underside of the mounting surface.

When using a 3/4-inch mounting hole to mount thick-roof NMO antenna mounts AN-125001-003 or AN-125001-004, the thickness of the mounting surface must be at least 1/8-inch (0.125-inch minimum thickness). This requirement is due to the thickness of the alignment ring used to center the bushing assembly within the 3/4-inch mounting hole.

#### 7.2.1.3 **Installation Procedure for Mounts AN-125001-001 through -004**

1. Select the antenna mounting location in accordance with the information presented in Sections 1 and 7.1 of this manual. If necessary, contact the Technical Assistance Center for assistance. See page 32 for TAC contact information.
2. Verify no obstructions exist immediately below the respective mounting location on the underside of the vehicle body, such as vehicle ribbing/body framing, a wiring harness, air bag equipment, etc. Also verify there is a sufficient access path and clearance for the mount's coax cable. If there is an obstruction or insufficient clearance, select another nearby mounting location.
3. Measure and mark the center point of the selected antenna mounting location. Be sure to center the mark from side-to-side of the vehicle.

4. Obtain a hole saw specifically designed for drilling NMO mounting holes of the required diameter. (e.g., Antenex/Laird Technologies model HS34 or equivalent for a  $\frac{3}{4}$ -inch hole; Antenex/Laird Technologies model HS38 or equivalent for a  $\frac{3}{8}$ -inch hole).
5. If the vehicle's headliner panel, carpet, seats, or otherwise, is below the mounting location, move or remove the headliner panel, etc. as necessary to protect it. Alternately, apply a heat-resistant mask material (such as a fiberglass mat or thin sheet metal with masked edges) as required to "catch" the metal shavings and the metal plug (if any) produced by the hole saw. The plug (if any) may be relatively hot if/when it drops out of the saw upon completion of the hole drilling process.  $\frac{3}{8}$ -inch diameter hole saws generally produce only shavings, not plugs.
6. With the hole saw and a drill, drill a hole at the marked hole center point. Position the drill square to (i.e., 90 degrees from) the vehicle mounting surface so paint immediately outside of the perimeter of the hole is evenly removed.



**Excessive use of the hole saw and/or failure to position the drill "square" with (i.e., at a 90-degree angle from) the vehicle mounting surface may result in damage to the metal mounting surface, in the area immediately outside of the perimeter of the hole.**

7. Ensure the saw removed the paint immediately around the hole as the drilling operation completes. If not, do so by reinserting the saw completely into the hole and spinning it as required. This allows proper grounding via the mount's lock nut on the top of the mounting surface. On the bottom of the mounting surface, the "teeth" of the mount's bushing assembly may not provide a good ground due to thick vehicle undercoating, thick primer, oxidation/rust, etc.
8. **For a  $\frac{3}{4}$ -inch hole**, feed the unterminated end of the mount's coax cable into the hole from the top surface of the vehicle until the mount's bushing assembly is in position to drop into the hole. The bushing should be tilted at a slight angle and fed into the hole. The threaded shank of the mount's bushing assembly will not fall through a  $\frac{3}{4}$ -inch hole.  
**For a  $\frac{3}{8}$ -inch hole**, feed the threaded shank of the mount's bushing assembly into the hole from the underside of the mounting surface. Hold it into position until the lock nut is installed.
9. If installing a thick-roof antenna mount ( $\frac{3}{8}$ -inch shank) into a  $\frac{3}{4}$ -inch hole, place the alignment ring onto the threaded shank of the mount. This ring has an approximate  $\frac{3}{4}$ -inch outside diameter.
10. A tube of synthetic lubricant is included with the antenna mount. Apply this lubricant to the mount's rubber O-ring. Do **not** get any lubricant on the center contact of the mount's bushing assembly.
11. As illustrated in Figure 7-5 and Figure 7-6, add the O-ring (C) and lock nut (D) to the top of the mount's bushing assembly (A). With the O-ring in the groove in the underside of the lock nut, thread the lock nut onto the bushing assembly. Be sure the O-ring remains in the groove before tightening the lock nut.
12. Using a  $\frac{15}{16}$ -inch open-end wrench, tighten the lock nut until it fully compresses the O-ring and makes good contact with the vehicle mounting surface. The groove's ridges on the bottom of the lock nut must make full contact with the unpainted metal surface of the vehicle.
13. Install the antenna element per the procedure in Section 7.2.4.

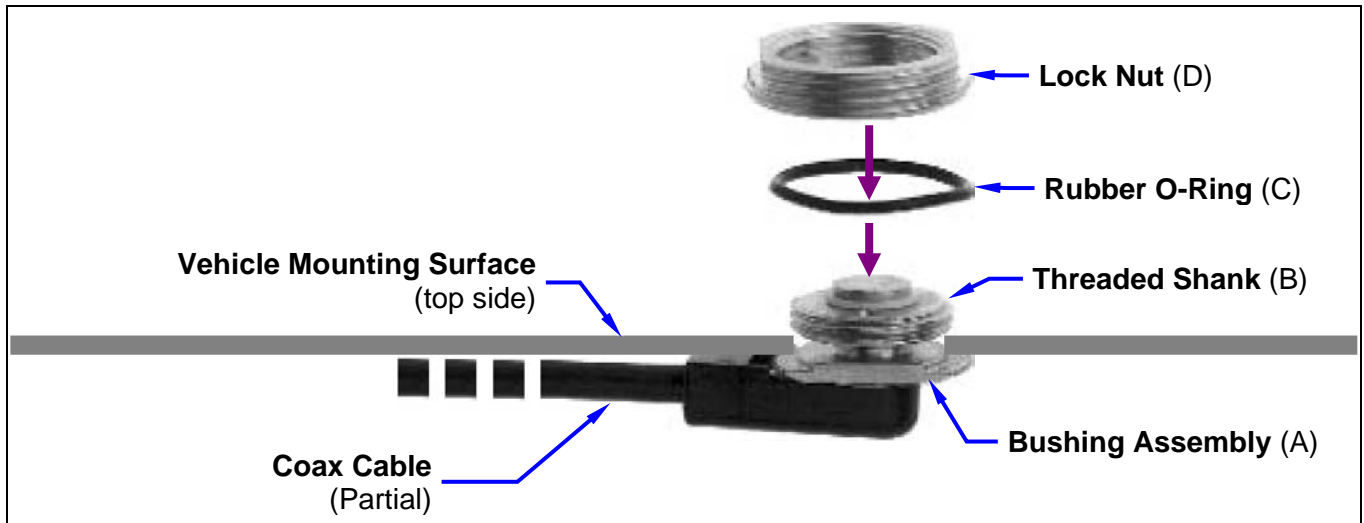

**Figure 7-5: Installing a Standard 3/4-Inch NMO Antenna Mount**  
(e.g., AN-125001-001 or AN-125001-002)

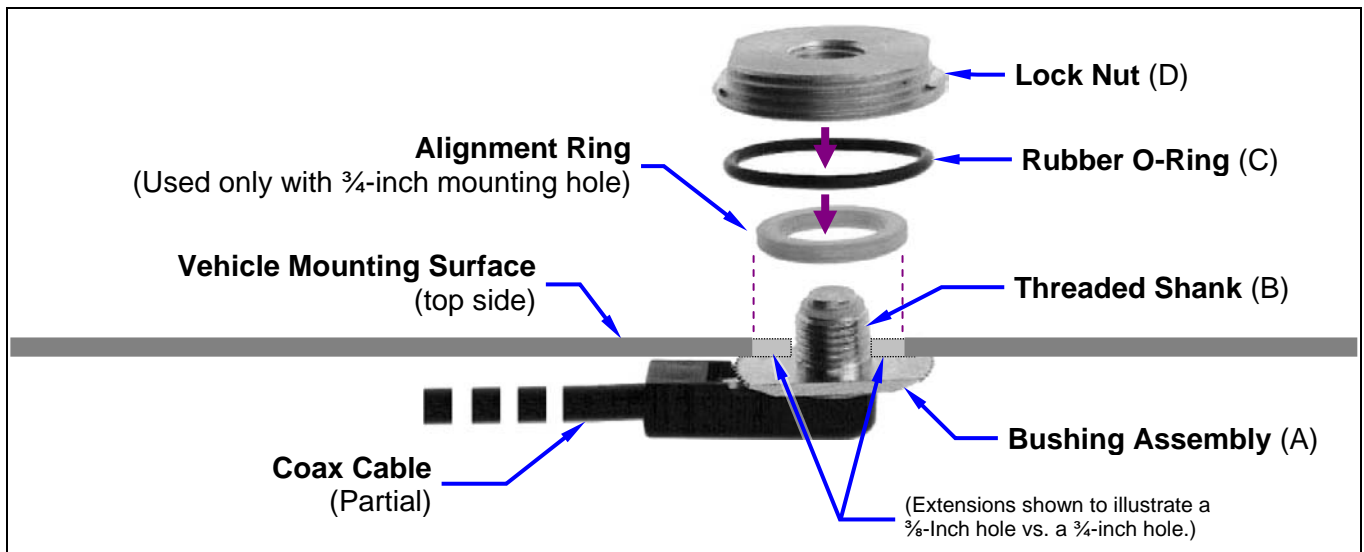

**Figure 7-6: Installing a Thick-Roof NMO Antenna Mount**  
(e.g., AN-125001-003 or AN-125001-004)

**7.2.2 Installing NMO Magnetic Antenna Mounts AN-125001-007 and AN-125001-008**

1. Thoroughly clean the bottom of the magnetic mount and the selected vehicle mounting surface by removing all dust, dirt, etc.
2. Carefully place the magnet mount onto the metal surface of the vehicle at the selected location. The coax cable exiting the mount's base should be orientated towards the point at which it will enter into the interior of the vehicle. Do not try to reposition it by sliding it on a painted metal surface.
3. Route the mount's coax cable to the radio location, passing it by the trunk lid's perimeter gasket, door perimeter gasket, etc., as necessary.
4. Install the antenna element per the procedure in Section 7.2.4.



To remove a magnetic antenna mount, hold it at the bottom of its base and tilt it at an angle to release the magnetic attraction force. **Do not pull on the mount's coax cable. Do not drag the mount across the mounting surface.**

### 7.2.3 Installing All Other Antenna Mounts

For any other type of antenna mount not covered in the previous sections, such as GPS combination antennas, install the mount in accordance with the installation instructions included with the mount.

### 7.2.4 Attaching NMO Antenna Elements

1. Clean the top surface of the NMO mount and the surface of the vehicle immediately around the mount.
2. Place the gasket included with the antenna element (not pictured in Figure 7-5 or Figure 7-6) around the mount and against the surface of the vehicle. If a lubricant or sealant was included with the gasket, apply it to the gasket before placing the gasket.
3. Apply the antenna element to the top of the mount and tighten it in a clock-wise direction (as viewing from the top). Use an appropriate wrench if required. Do **not** over-tighten.
4. Install a placard (not supplied) on the vehicle's dash panel, in accordance with the following **CAUTION**. Place the placard in plain view of the vehicle operator's position.



Before entering any automatic vehicle ("car") wash equipment, remove the antenna element from the antenna mount, and secure the element in a safe location inside the vehicle. This will prevent the wash equipment from damaging the element and/or mount. After exiting the wash equipment, thoroughly dry the top of the mount before re-installing the element.

5. Continue with the connection procedure presented in the next section.

### 7.2.5 Installing the Coax Cable and TNC RF Connector

1. Route the coax cable from the antenna mount to the location where the mobile radio will be installed. Remove headliner panel, interior panels, etc., as necessary. The cable must be kept out of casual contact from persons within the vehicle. Tie and stow the cable as necessary to protect it from possible chafing. Observe and follow this **WARNING**:



The cable of antenna AN102800V1 should **never** be cut to a shorter length. Instead, excess cable must be tied and stowed. This not only prevents the antenna from radiating above its intended or configured power, but it also allows for future re-installation considerations such as a relocation of the mobile radio within the vehicle. Installations requiring longer cables are treated as custom and separately specified.

**All Other Antennas/Antenna Mounts:** The antenna cables of other antennas/antenna mounts can be cut to a length **no shorter than six (6) feet (1.83 meters)**, as measured from the base of the antenna mount.

2. Using an appropriate crimp tool, crimp the supplied TNC RF connector to the end of the antenna cable. For crimping instructions, see Figure 7-7 or the instructions supplied with antenna mount.
3. The antenna cable is connected to the radio's TNC receptacle-type (female) RF connector per a procedure presented later in this manual. The cable and its TNC connector must be protected from damage, dirt, and/or metal shavings which may be generated during the mechanical and electrical



installation of the radio. Temporarily tying the connector and cable-end within a small plastic bag is recommended.

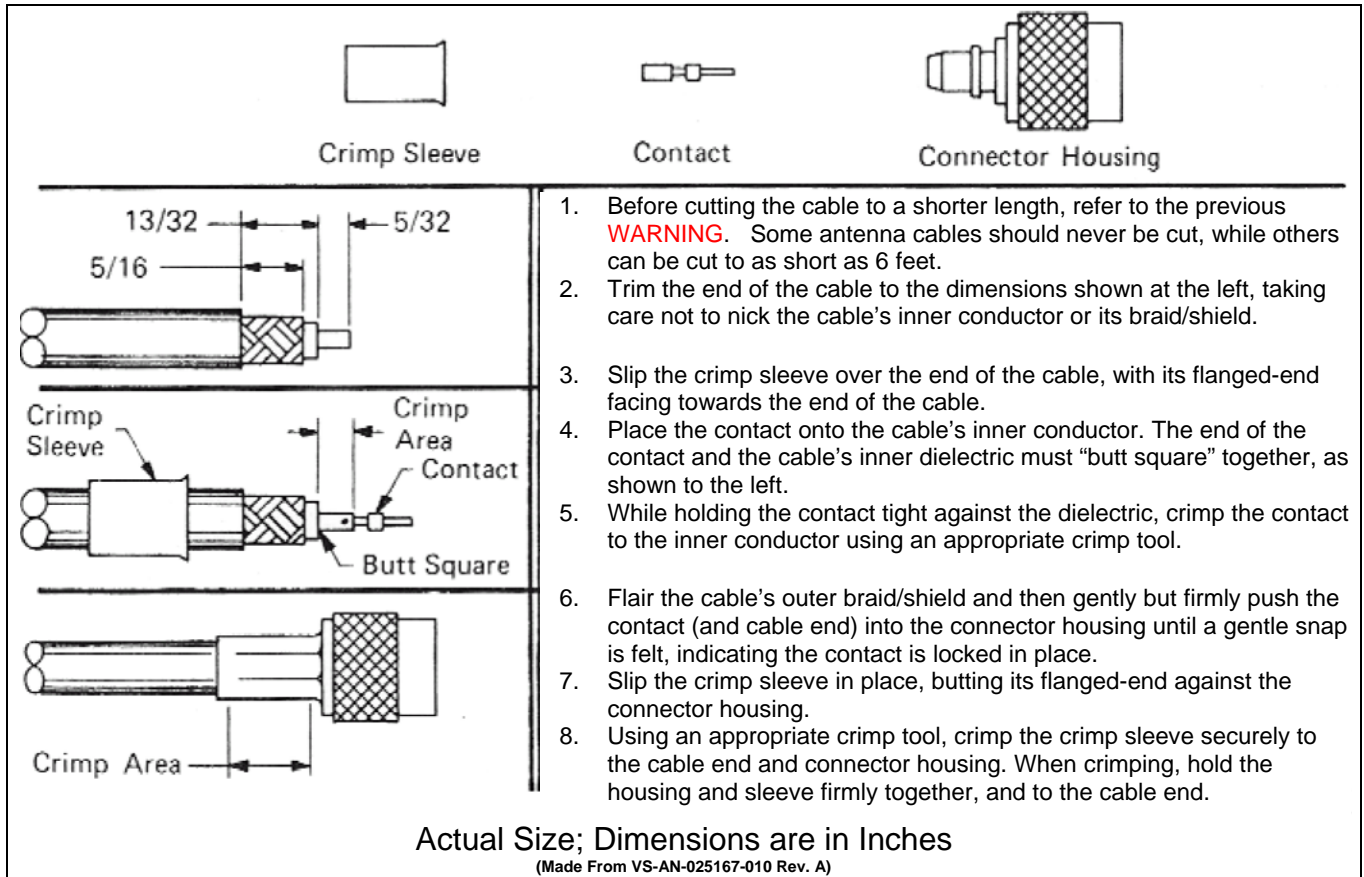

**Figure 7-7: Crimping Instructions for TNC RF Connector**



If the mobile radio installation includes a unity-gain antenna part number AN102800V1 or AN102800V2 or AN-225006-001, the antenna element must be tuned (trimmed) for maximum performance (i.e., minimum reflection) during the test procedures presented in Section 16. Other antennas used with the M5300 are factory-tuned and therefore do not require tuning in the field.

### 7.2.6 Install GPS Antenna (Required Only if Radio has GPS Receiver Option)

If the M7300 radio is equipped with the GPS receiver option, the GPS receiver requires connection to an externally-mounted GPS antenna. The GPS antenna must be kept at least six (6) inches away from any other antenna mounted on the vehicle and it must have at least six inches of surface ground plane beneath it.



NOTE

Connection to a GPS antenna is only required if the (optional) GPS receiver is installed in the radio and if its functions will be utilized/required. For OpenSky radio system applications, the GPS receiver can provide GPS data to either a locally-connected computer/mobile data terminal, or over-the-air to the radio network. For EDACS/ProVoice, P25 and conventional radio system applications, the GPS receiver is typically only used to support a computer/mobile data terminal (MDT) running GPS software connected to the radio via NMEA-formatted serial data link. Refer to Section 13 for additional information.



NOTE

A combination (“combo”) antenna kit includes a GPS antenna built into the base of the mobile antenna. Refer to Table 5-6 (page 40) for available combo antennas.

#### 7.2.6.1 General Installation Procedure

1. After selecting a mounting location, refer to the antenna manufacturer’s mounting and testing instructions for installation guidance. Install the antenna in accordance with these instructions. If necessary, contact the Technical Assistance Center. See page 32 for TAC contact information. **Do not alter the GPS antenna cable length; tie and stow excess cable as necessary.**
2. Route the cable from the antenna base to the location of where the radio will be installed. Remove headliner panel, interior panels, etc., as necessary. The cable must be kept out of casual contact from persons within the vehicle. Tie and stow it as necessary to protect it from possible chafing.
3. The antenna cable is connected to the radio’s SMA receptacle-type (female) RF connector per a procedure presented later in this manual (i.e., procedure on page 111). The cable and its (male) SMA connector must be protected from damage, dirt, and/or metal shavings which may be generated during the mechanical and electrical installation of the radio. Temporarily tying the connector and cable-end in a small plastic bag is recommended.

#### 7.2.6.2 Installation Procedure for Inside-Rear-Deck Mounting in Ford Crown Vic

The following GPS antenna installation procedure is recommended for inside-rear-deck mounting of GPS receive-only antennas, such as AN-025187-001 or AN-025187-003, in a Ford Crown Victoria. Other vehicle makes/models may use similar installation scenarios:

1. Carefully remove the center rear brake light assembly by removing the screws on each side of the assembly. Lift and set it aside.



2. Route the cable from the GPS antenna through the rear deck, next to the cable assembly for the rear brake light.

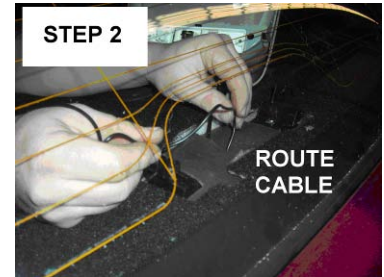

3. Position the antenna near the rear glass.

For an antenna that is not a magnetic-mount, secure it to the deck near the rear glass in accordance with the instructions provided with the GPS antenna.

4. Reassemble the rear deck brake light assembly while using caution to not to crimp/pinch the GPS coaxial cable. A small relief notch may need to be cut in the housing of the light assembly cable passage.
5. The cable and its (male) SMA connector must be protected from damage, dirt, and/or metal shavings which may be generated during the mechanical and electrical installation of the radio. Temporarily tying the connector and cable-end in a small plastic bag is recommended.
6. Route the cable to the area near where the radio will be installed. Tie and stow the antenna cable as necessary to prevent cable chafing or damage from moving items, like the trunk lid's hinges and springs. The antenna cable is connected to the radio's SMA receptacle-type (female) RF connector per a procedure presented later in this manual (i.e., procedure on page 111).

**NOTE**

Do **not** alter the length of cable from the GPS antenna. The SMA connector on the end of the antenna cable is not field-replaceable.

## 8 FRONT-MOUNT RADIO INSTALLATION



This section includes detailed instructions for mechanically installing and wiring a front-mount M7300 mobile radio. For remote-mount M7300 mobile radio installation procedures, refer to Section 9 which begins on page 70.

### 8.1 MOUNTING THE FRONT-MOUNT RADIO

The Mounting Bracket Kit for the front-mount M7300 mobile radio includes a heavy-gauge steel U-shaped mounting bracket. The radio should be attached to a mounting surface using this bracket. The bracket can be mounted above or below the radio. Kit contents are shown in Figure 8-2, and bracket dimensions are shown in Figure 8-3.

Both the radio and the mounting bracket have multiple holes in both sides for adjusting the radio within the bracket. The design allows for both front-to-rear tilting of the radio within the bracket for the best viewing angle, and a front-to-rear position offset. The radio has six (6) threaded mounting holes, three (3) per side, and the mounting bracket has ten (10) corresponding holes, five (5) per side. The radio must be secured to the bracket using at least four of the six M5 socket-head screws included in the Mounting Bracket Kit (2 screws per side).

Typically, the radio is front-to-rear centered within the bracket. However, it can be front-to-rear offset by approximately 2 inches (5.1 centimeters), if required. Also, the radio can be positioned straight in the bracket (i.e., parallel with the bottom surface of the bracket), or it can be tilted up or down at an angle of between approximately 10 to 20 degrees. When positioned straight and centered front-to-rear within the bracket, the radio extends approximately 2.5 inches (6.4 centimeters) from the front and rear edges of the bracket. In the rear, additional clearance must be included for cables. The area directly at the front of the radio must be completely clear of all objects (e.g., gear shift, other radio equipment, etc.) so the operator can easily access and view the radio's control head.

The mounting bracket must be attached to a secure metal surface that meets or exceeds the minimum 1/16-inch-thick steel sheet metal requirement in accordance with the following **WARNING**. For example, it can be attached directly to the bottom of the dash if the gauge of the sheet metal is high and the surface is firm and flat, or it can be attached to the transmission hump, etc., if a mounting wedge (not included) is utilized. The front-mount M7300 radio weighs approximately 6 pounds (2.7 kilograms).



**At a minimum, the mounting surface should be 16-gauge (approximately 1/16-inch thick) steel sheet metal. Mounting to plastic or other material with low tensile and shear strength could lead to an unsafe and/or failed mounting condition, turning the radio and its mounting bracket into a projectile during a high-shock incident such as a motor vehicle accident. If the selected mounting surface does not meet the minimum 16-gauge steel sheet metal requirement, the surface should be reinforced with a metal backing plate (not supplied) or it should be reinforced using some other approved mounting method.**



In addition to improving safety of the installation, firm mounting also prevents unreasonable vibration that could damage the radio, adversely affect transceiver performance and/or cause its cable connections to loosen. An improperly mounted M7300 radio may experience degradation in the quality of voice and data communications.

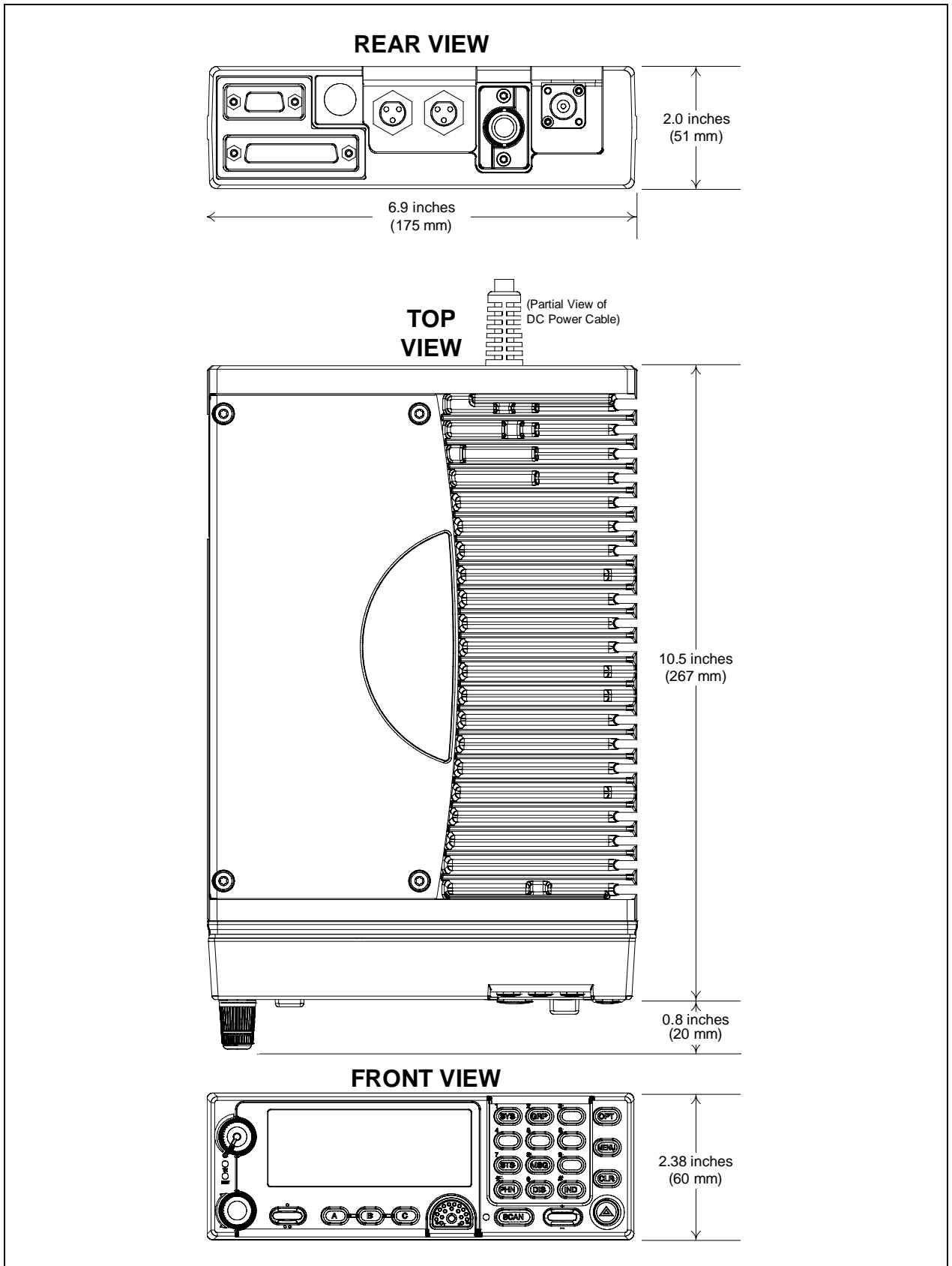
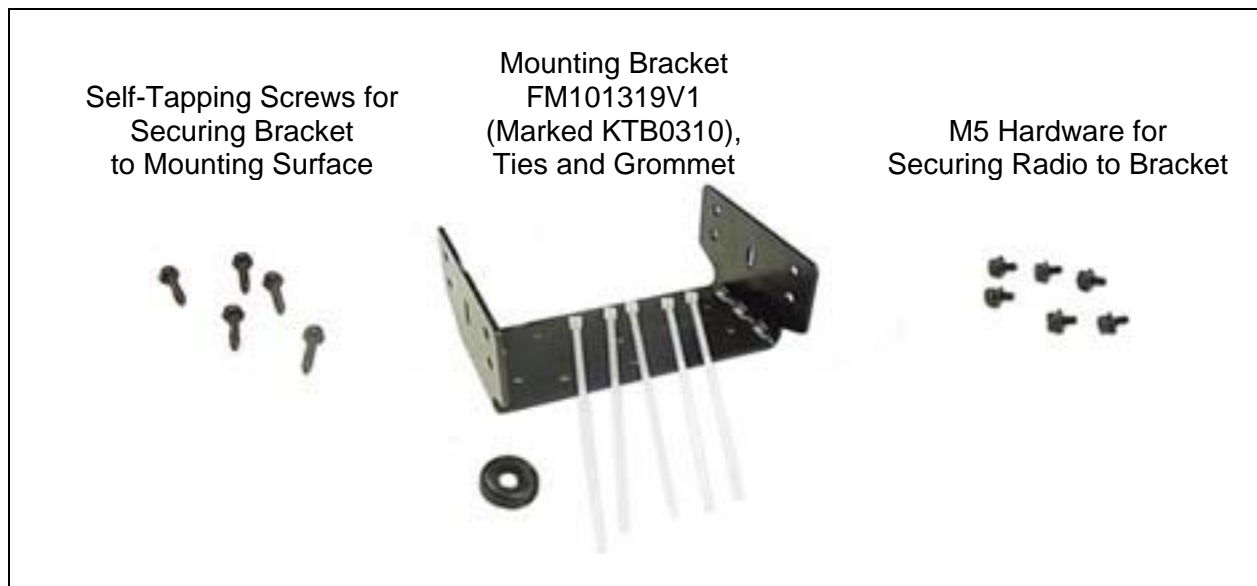

Figure 8-1: Front-Mount M7300 Radio Dimensions

### 8.1.1 Mounting Bracket Installation

The front-mount M7300 radio's mounting bracket is included with the Front-Mount Mounting Bracket Kit KT101533V1. Kit contents are shown in Figure 8-2. This kit is Item 1 listed in Table 5-3 (page 35).



**Figure 8-2: Front-Mount Mounting Bracket Kit KT101533V1**

When selecting a mounting location for the radio, verify sufficient clearance can be maintained around the radio for installation and service access. A minimum clearance of approximately four (4) inches (10 centimeters) is recommended at the rear, left and right sides of the radio. As previously stated, the area directly at the front of the radio must be completely clear of objects so the operator can easily access and view the radio's control head.

As illustrated in Figure 8-3, the bracket is both left-to-right and front-to-rear symmetrical. It has eleven (11) holes for securing it to a mounting surface. At least four (4) of these holes must be used to secure the bracket to the mounting surface. Five 20-millimeter-long self-tapping screws are included in the Mounting Bracket Kit for this purpose. However, some other type of hardware (not supplied) may be used, such as #10-32 stainless-steel self-locking hardware (i.e., machine screws with washers and locking nuts), or self-drilling screws. Self-drilling screws such as "TEK" screws do not require drilling of a pilot hole prior to installation. Do not use common self-threading sheet metal screws because they will loosen over time with vehicle vibrations.

The following mounting procedure is recommended:

1. Determine the best radio-to-bracket position and angle by test-fitting the radio into the mounting bracket at the selected vehicle mounting location. Slide the radio between the sides of the bracket and temporarily secure it to the bracket with several of the M5 socket-head screws from the bracket kit. When positioned straight and centered front-to-rear within the bracket, the radio extends approximately 2.5 inches (6.4 centimeters) from the front and rear edges of the bracket. In the rear, additional clearance must be included for cables. The area directly at the front of the radio must be completely clear of all objects (e.g., gear shift, other radio equipment, etc.) so the operator can easily access and view the radio's control head.
2. At the rear of the radio, verify sufficient clearance is available for cables and service access.

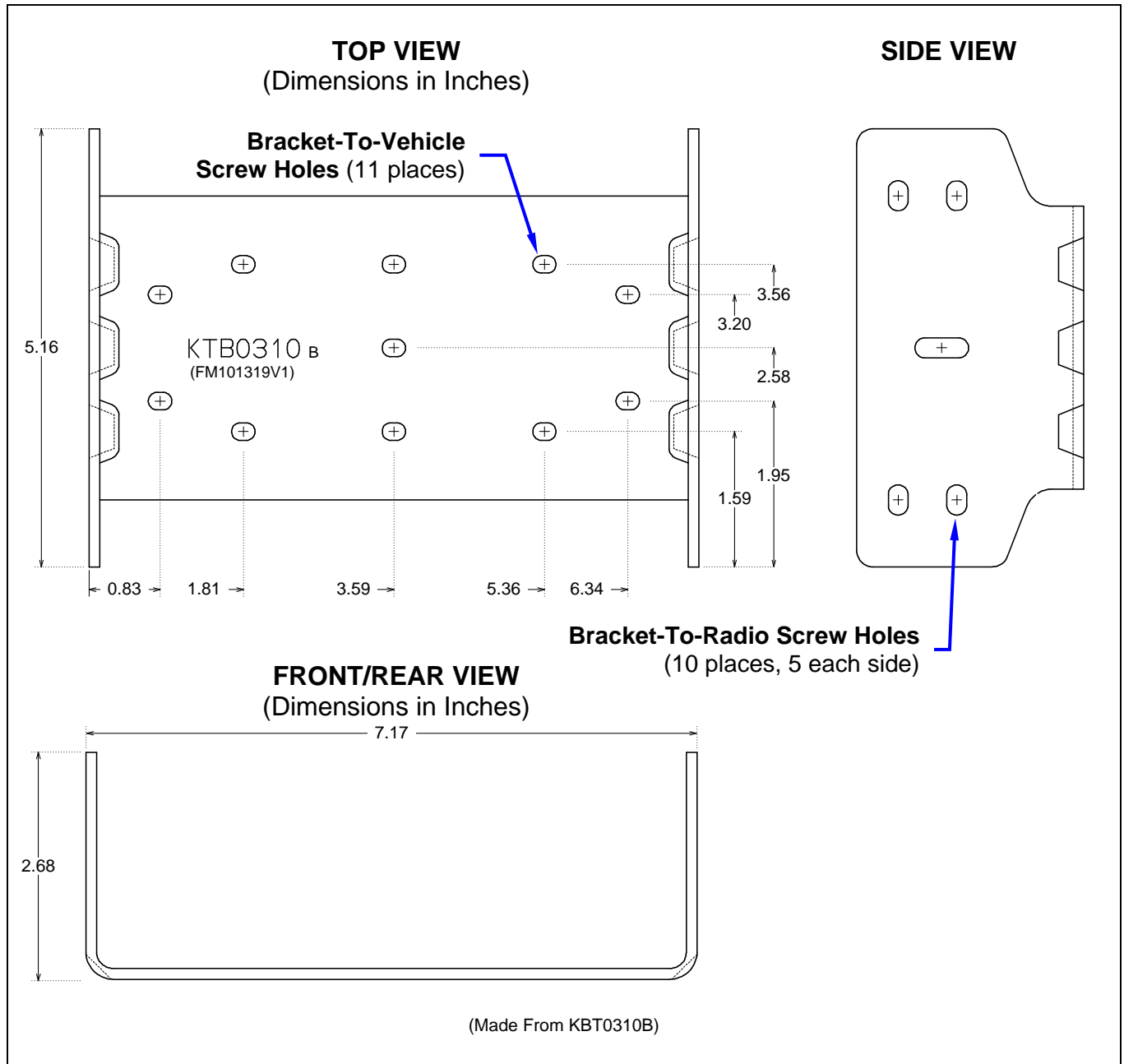

**Figure 8-3: Mounting Bracket FM101319V1 (Marked KTB0310) Dimensions [for Front-Mount M7300 Mobile Radio (Radio Not Shown)]**

3. If the mounting surface is not flat (such as the top of a transmission hump), construct a suitable mounting wedge as necessary, and attach the wedge to the surface using an approved attachment method. Never mount the bracket directly to a non-flat surface.
4. On the mounting surface, mark the selected location for the bracket, and then remove the radio from the bracket.
5. Clean and remove any foreign material from the mounting surface.
6. Using the bracket as a template, and/or the dimensional information shown in Figure 8-3, mark and drill at least four (4) mounting holes into the mounting surface as required per the type of hardware used.



Before drilling holes and/or installing mounting screws, verify these operations will not damage or interfere with any existing vehicle component (the fuel tank, a fuel line, the transmission housing, existing vehicle wiring, etc.). Always check to see how far the mounting screws will extend below the mounting surface prior to installation. Always deburr drilled holes before installing screws.

7. Temporarily remove the bracket and deburr all of the newly drilled holes.
8. If necessary, apply an approved paint or rust-inhibitor at the holes in the mounting surface.
9. Set the bracket back into place.
10. Install and tighten the mounting screws/hardware.
11. Verify the bracket is firmly secured to the mounting surface. A secure mount prevents unreasonable vibration, which could damage the radio and/or cause its cable connections to loosen.
12. If the rear of the radio is easily accessible when the radio is positioned in the selected position within the bracket, it is recommended that the radio be temporarily inserted into the bracket. Otherwise, do not mount the radio into the bracket at this time, because several cable connections must be made at the rear of the radio.

### 8.1.2 Inserting the Radio into the Mounting Bracket

The radio should now be inserted into the mounting bracket according to this procedure:

1. Lay the radio into the mounting bracket with the front of the radio facing in the correct direction (usually towards the rear of the vehicle).
2. Secure the radio to the bracket using at least four (4) of the six (6) M5 x 10 mm stainless-steel socket-head screws included with the Mounting Bracket Kit. These screws have captive lockwashers. Kit contents are shown in Figure 8-2. This kit is Item 1 listed in Table 5-3 (page 35).
3. Tighten all screws using a 4-millimeter hex key wrench until each lockwasher is fully compressed and the radio is firm and flush in between the brackets.
4. Check the mounting area for proper clearance for cable service looping and for air circulation, plus an area to secure and rest the excess cable lengths.



Proper mounting is one factor that ensures optimal radio performance. An improperly mounted radio may experience degradation in the quality of voice and data communications.

## 8.2 FRONT-MOUNT RADIO'S DC POWER INSTALLATION

### 8.2.1 Overview of On/Off Power Wiring Configurations

The following power wiring configurations are supported:

- **Radio turns on and off automatically with vehicle's ignition switch/key** — This configuration allows the on/off state of the vehicle's ignition switch/key to control the on/off power state of the radio. The white wire of the radio's DC Power Cable is connected to a fused switched power source, typically identified as vehicle "Accessory" power. This source must switch on (up to positive (+) battery voltage potential) when the vehicle's ignition switch/key turns on, and it must switch off (to



near zero volts) when the ignition switch/key turns off. The required fuse rating is 3 amperes. When using this configuration, the on/off/volume control must be left in the on position for automatic power-up/down to function properly.



NOTE

In a front-mount M7300 radio installation, to fuse the white wire of the radio's DC Power Cable, a yellow waterproof (HFB type) fuse holder and a 3-amp AGC fuse are included with the cable.

- **Radio turns on and off with a manual switch** — This configuration is used when, for example, the radio has to remain on even when the ignition key must be removed from the vehicle and a separate on/off switch is acceptable. The white wire of the radio's DC Power Cable is connected to one side of a manually-controlled switch, and the other side of this switch is connected to unswitched and fused vehicle power. The required fuse rating is 3 amperes. When using this configuration, the on/off/volume control must be left in the on position for automatic power-up/down to function properly.
- **Radio turns on with its on/off/volume control (“hot wired”)** — This configuration allows radio on/off power control only via its on/off/volume control. It may be desired if, for example, the radio has to remain on even when the ignition key must be removed from the vehicle and a separate on/off switch is not desired and/or not acceptable. The white wire of the radio's DC Power Cable must be connected to unswitched and fused vehicle power. The required fuse rating is 3 amperes.

In all of the above cases, the radio's main DC power input (red wire) must be connected through an in-line fuse to unswitched vehicle DC power. The red wire must be connected to raw battery power (positive battery terminal) via the supplied fuse.



CAUTION

Any DC input power provided to the radio shall be no higher or lower than 13.6 volts DC  $\pm 10\%$ . The DC input power should be free and clear of any AC noise or DC spikes above 18 volts. If the vehicle cannot meet these requirements, then DC conditioning will be required before any DC power is connected to the radio. This includes conditioning for both the radio's main DC power input lead and for its switched ignition sense power input. DC conditioning can be accomplished by a noise filter or DC isolation equipment such as Harris part number FL-018314-001 or FL-018314-002, or similar units with equal specifications. However, these filters cannot be used with the 110-watt VHF mobile radio; in this case, consult with TAC for details if necessary. Also, a fuse must be placed in-line before any noise filter. Contact TAC for additional information.

## 8.2.2 DC Power Cable and Main Fuse Holder Installation

The radio's DC Power Cable has a 3-pin connector, a 20-foot red wire (for the main power connection), a 20-foot white wire (for the switched power source connection), and a 4-foot black wire (for the ground connection). It is supplied with waterproof fuse holders, two AGC-type fuses, and non-insulated ring terminals. The following installation procedures are recommended:

### 8.2.2.1 **Black Wire Connection (Ground Wire)**

1. Connect the radio's DC Power Cable to the radio by mating its 3-pin connector to the radio's 3-pin power cable connector as follows: Visually align the key and firmly push and turn the outer locking ring clockwise until it stops. A click will be sensed to confirm proper mating.

2. Prepare to connect the cable's black wire to vehicle ground by locating an area of vehicle metal within approximately two (2) feet of the radio. This surface **must** have a solid and stable connection to vehicle ground. If not, add grounding strap(s) as necessary.
3. Strip the area of any paint or dirt to expose a bare metal surface, approximately 3/4-inch square.
4. Drill a hole in the approximate center of the bare metal surface, and deburr it. A 3/8-inch non-insulated ring terminal is supplied with the cable to make this ground connection. Therefore, hole diameter should be appropriate for the utilized grounding screw/bolt size and type used to connect the ring terminal to the bare metal surface. This hardware is not supplied.
5. Cut the black wire to the required length plus some additional length for a service loop, then strip insulation back approximately 1/4-inch.
6. Crimp a 3/8-inch non-insulated ring terminal (supplied with the cable) to the end of the black wire.
7. Attach the ring terminal and black wire to the bare metal surface using stainless-steel self-locking hardware (i.e., machine screws with washers and locking nuts) or other appropriate hardware to ensure a reliable terminal-to-metal contact. Tighten securely.
8. Apply an approved paint or rust-inhibitor over the remaining exposed bare metal surface and around the ring terminal.

### 8.2.2.2 Red Wire and Main Fuse Holder Connection (Radio's Main Power Wire)

1. Continue installation of the radio's DC Power Cable by routing its 20-foot 10-AWG red wire to the location of the vehicle's battery (or its main DC bus bar or stud). Remove interior panels, door kick panels, etc., and route the wire through existing channels in the vehicle body as necessary. Protect the wire from possible chafing where necessary. Tie and stow the wire as necessary.



Plan the routing of the 10-AWG red wire carefully, using an existing access hole in the vehicle's firewall if possible. Alternately, drill a new hole approximately 1/2-inch in diameter and install a small rubber grommet (one supplied with the bracket kit) to protect the wire from chafing at the hole's sharp metal edge. **To prevent fumes from entering the passenger compartment, this hole/grommet/wire combination must also be sealed with a silicon-based sealer before completing the installation.**



Do **not** install any wiring or fuse holder over or in the near vicinity of the vehicle's engine. Excessive engine heat can cause permanent damage to these components and can lead to intermittent electrical connection to the battery.



**Before making connections to the battery's positive post, carefully disconnect the battery's negative (ground) cable(s). This will prevent tools or other metallic objects which come in contact with the battery's positive terminal from shorting to vehicle ground, causing sparks or even a fire or an explosion! When disconnecting the negative cable(s), cover/insulate the positive post(s) if it is not already so a tool cannot short between the posts. Some vehicles, such as those with diesel engines have more than one battery; in this case, disconnect the negative cables at all batteries.**

**Radio fuses should not be installed until all wiring is complete. This will prevent the radio from powering up prematurely and/or causing an in-rush of current that could lead to shorting of the battery, sparks, or even fire.**

2. Obtain the orange waterproof (HFB type) fuse holder included with the DC Power Cable.
3. **Observe and follow the previously presented WARNING!**
4. Cut the red wire to the required length for connection to the battery's positive (+) battery terminal (or the main DC bus bar or stud).
5. Prepare to splice the fuse holder into the red wire by cutting it again, at approximately three (3) to six (6) inches from the end.
6. Strip all three (3) wire ends back approximately  $\frac{3}{8}$ -inch, place a fuse holder shell on each wire, and securely crimp a fuse holder terminal to each wire end. Before crimping, verify fuse holder shells are oriented in the correct directions (i.e., with each large end towards the wire end).
7. Label this fuse holder and red wire appropriately (e.g., "M7300 Main Power: 15-AMP FUSE").
8. **Do NOT install a fuse into the fuse holder at this time.**
9. Crimp an appropriate electrical terminal to the short red wire. A corrosion-resistant  $\frac{3}{8}$ -inch ring terminal is included with the cable for this purpose, but another size corrosion-resistant terminal type (not supplied) may be used if required.
10. Connect the ring terminal directly to the battery's positive post (or if present, to a stud on the battery's main/non-switched power distribution terminal block).



A front-mount M7300 mobile radio installation may be equipped with additional CH-721 control heads in a multi-head installation. In this case, refer to Section 9.3 (begins on page 80) for control head installation procedures.

### 8.2.2.3 White Wire Connection

A review of the information presented in Section 8.2.1 (page 64) may be beneficial at this time. As required per the chosen power-up configuration, connect the white wire by following one of the three procedures presented in the respective sub-section that follows.

#### 8.2.2.3.1 Radio Turns On and Off with Vehicle's Ignition Switch/Key

With this wiring configuration, the radio (and its control head) automatically turns on and off with the vehicle's ignition switch/key. The white wire is sometimes referred to as the "white ignition switch wire" or the "ignition sense input wire." In this configuration, the white wire connects to a switched power source, typically identified as "Accessory" power, that switches on and off with the vehicle's ignition switch/key. When using this configuration, the CH-721 control head's on/off/volume control must be left in the on position for automatic power-up/down to function properly.



The white ignition sense wire must be connected to a fused power source that switches from approximately zero volts to approximately +13.6 volts when the vehicle's ignition switch/key is turned from the OFF position to the ACCESSORY and RUN positions. Use of a switched power source that is subject to voltage changes as a result of other actions, such as opening a vehicle door, may result in undesirable radio power cycles.

1. Locate the vehicle's switched ignition or "Accessory" power connection point that will be used for the switched ignition 12-volt DC power source. This point is typically located at or near the vehicle's fuse panel. It may be necessary to consult the vehicle manufacturer's wiring diagram.
2. Route the white wire of the radio's DC Power Cable from the back of the radio to the area near this connection point. Protect the wire from possible chafing as necessary.

3. Obtain the other waterproof (HFB-type) fuse holder included with the radio's DC Power Cable.
4. Cut excess length from the white wire and splice the fuse holder into it, near the location of the connection point.
5. Using an appropriate electrical terminal, connect the white wire to the switched power connection point. An open-barrel spade terminal is included with the cable for this purpose, but another type of terminal (not supplied) may be used as required.
6. Obtain the 3-amp AGC-type fuse included with the cable, and install it into the fuse holder.
7. Tie and stow all wiring as necessary so it remains out of the way of casual contact and wire chafe is avoided.
8. Continue with the speaker installation procedures presented in Section 10.1 on page 96.

#### **8.2.2.3.2 Radio Turns On and Off with a Manual Switch**

With this wiring configuration, the radio (and its control head) is manually turned on and off via an on/off switch mounted separately from the radio, not through the vehicle's ignition switch/key. This configuration is used when, for example, the radio must remain on even when the ignition key must be removed from the vehicle and a separate on/off switch is acceptable and/or required. In this configuration, the white wire connects to a fused switched power source such as that provided by a toggle switch mounted on the vehicle's dash panel. When using this configuration, the CH-721 control head's on/off/volume control must be left in the on position for automatic power-up/down to function properly.

1. Route the white wire of the radio's DC Power Cable from the back of the radio to an area near the location of the panel-mounted on/off switch. Protect the wire from possible chafing as necessary.
2. Cut a short section (6 to 8 inches) off the end of the white wire and strip the ends.
3. Obtain the other waterproof (HFB-type) fuse holder included with the radio's DC Power Cable, and crimp one half of it to one end of the short section of wire.
4. Using an appropriate electrical terminal, connect this short white wire to unswitched 12-volt DC power source at or near the vehicle's fuse box.
5. Cut another section of white wire from the cable. This wire must be long enough to reach from the fuse holder to the location of the panel-mounted on/off switch.
6. Strip one end of this wire and crimp the other half of the waterproof fuse holder to this wire end.
7. Strip the other end of this wire and, using an appropriate electrical terminal, connect it to the common terminal of the switch.
8. Connect the white wire of the power cable to the load (switched) side of the switch.
9. If not already, mount the switch to the vehicle's dash panel, or other customer-selected location.
10. Obtain the 3-amp AGC-type fuse included with the cable, and install it into the fuse holder.
11. Tie and stow these wires as necessary so they remain out of the way of casual contact and wire chafe is avoided.
12. Label this power switch accordingly. For example: "**RADIO ON/OFF.**"
13. Continue with the speaker installation procedures presented in Section 10.1 on page 96.

#### **8.2.2.3.3 Radio Is "Hot Wired"**

In the "hot-wired" configuration, the radio (and its control head) is turned on and off only by the control head's on/off/volume control located on the front panel of the control head. In this configuration, the

white wire must be connected to **unswitched and fused 12-volt** vehicle power. Follow the procedure presented in Section 8.2.2.3.1, except connect the white wire to **unswitched** battery power instead of switched (“Accessory”) power. Be sure to fuse this connection with the provided in-line fuse holder and 3-amp AGC fuse.

### **8.3 TERMINATE CAN PORTS**

Add a CAN Terminator to each CAN port connector on the rear of the radio. Two (2) CAN Terminators are included in the installation kit for this purpose (item 3 in Table 5-3).

## 9 REMOTE-MOUNT RADIO INSTALLATION



This section includes detailed instructions for mechanically installing and wiring a remote-mount M7300 mobile radio. For front-mount M7300 mobile radio installation procedures, refer to Section 8 which begins on page 60.

### 9.1 MOUNTING THE REMOTE-MOUNT RADIO

This section provides details on mounting a remote-mount M7300 mobile radio in the vehicle. The preferred mounting of the radio is on top of a firm, flat surface. CH-721 control head installation procedures are included in Section 9.3 which begins on page 80. HHC-731 hand-held controller installation procedures are included in Section 9.4 which begins on page 89.

The 35 and 50-watt remote-mount radios each weigh approximately 5.25 pounds (2.38 kilograms). Radio dimensions are shown in Figure 9-1.

The 110-watt VHF remote-mount radio weighs approximately 7.0 pounds (3.18 kilograms). Radio dimensions are shown in Figure 9-2.



Prior to beginning the installation, verify the radio has the proper version of software and verify it has been configured properly for customer usage. Consult with the radio system network administration personnel as necessary.



Though generally mounted in a trunk or remote location, the remote-mount mobile radio must be kept away from heat sources. Mounting it in a location which is out of direct sunlight is recommended but not required. Adequate ventilation space must be provided to the side fins. The radio reduces its RF output power when its ambient temperature exceeds approximately +140° Fahrenheit (+60° Celsius).



**At a minimum, the mounting surface should be 16-gauge (approximately 1/16-inch thick) steel sheet metal. Mounting to plastic or other material with low tensile and shear strength could lead to an unsafe and/or failed mounting condition, turning the radio and its mounting bracket into a projectile during a high-shock incident such as a motor vehicle accident. If the selected mounting surface does not meet the minimum 16-gauge steel sheet metal requirement, the surface should be reinforced with a metal backing plate (not supplied) or it should be reinforced using some other approved mounting method.**



Before drilling holes and/or installing mounting screws, verify these operations will not damage or interfere with any existing vehicle component (the fuel tank, a fuel line, the transmission housing, existing vehicle wiring, etc.). Always check to see how far the mounting screws will extend below the mounting surface prior to installation. Always deburr drilled holes before installing screws.

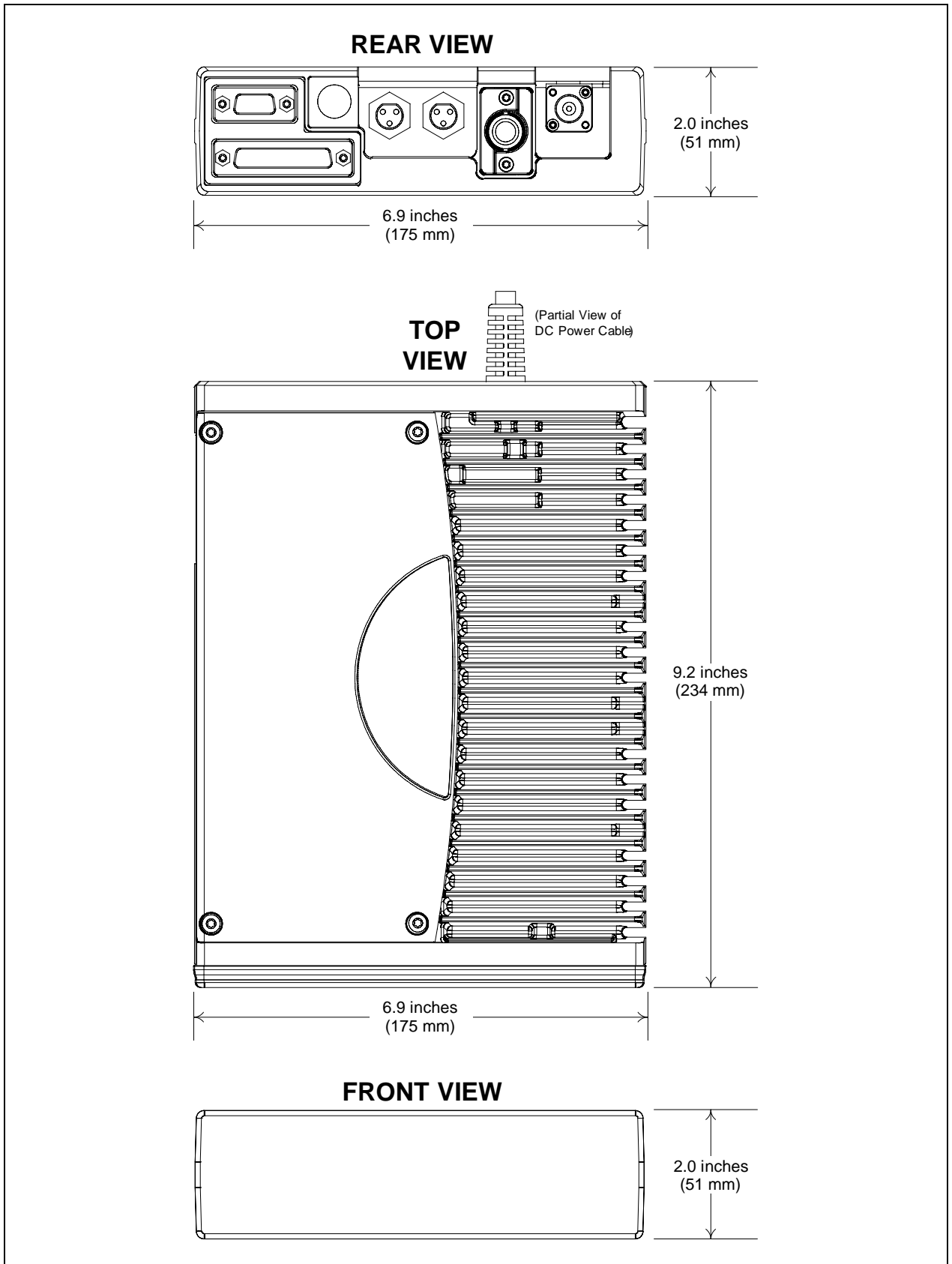

Figure 9-1: Remote-Mount 35/50-Watt M7300 Radio Dimensions

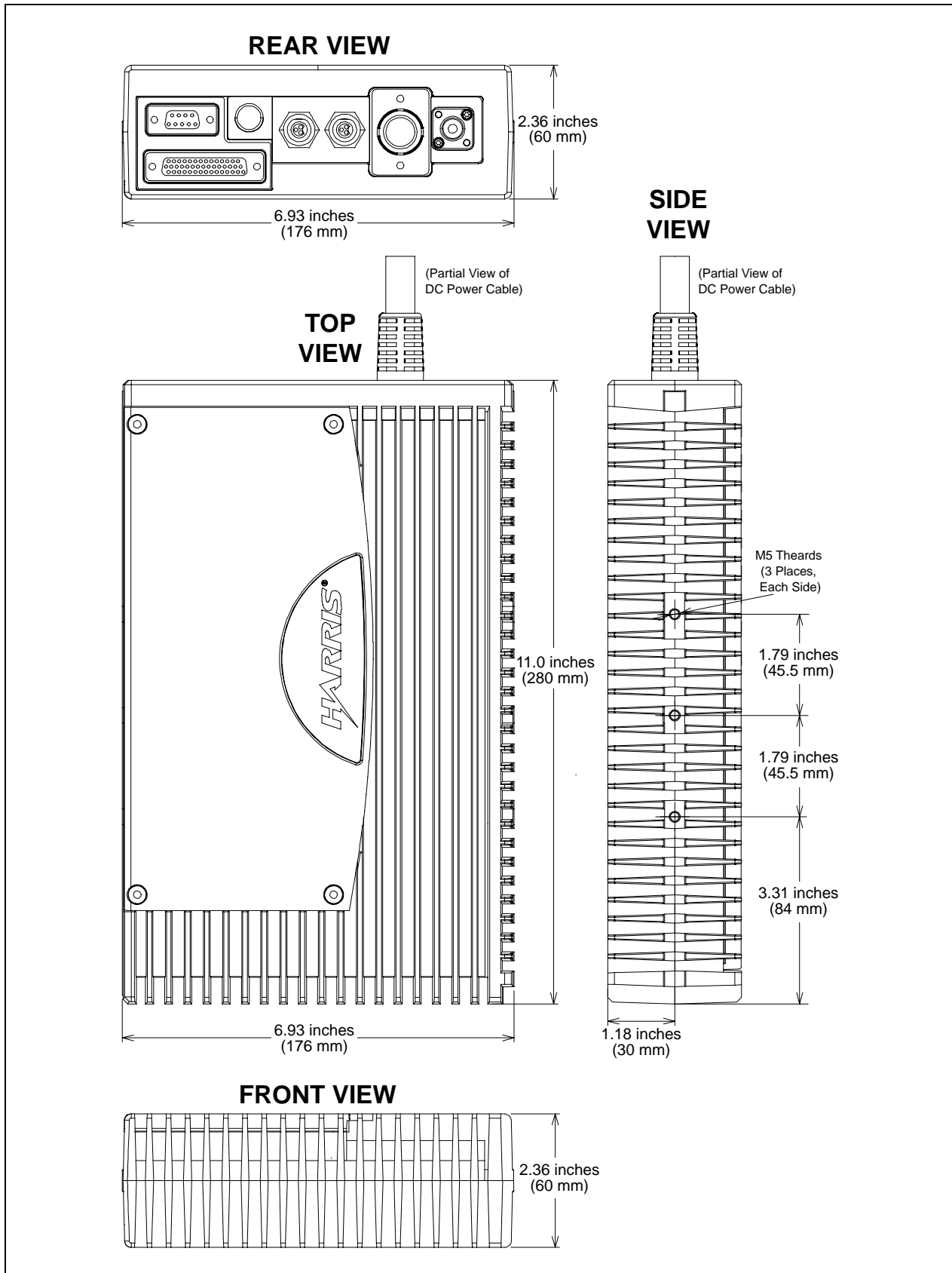

Figure 9-2: Remote-Mount 110-Watt M7300 Radio Dimensions



**9.1.1 Mounting Bracket Installation**

The 35/50-Watt remote-mount radio’s mounting bracket is included with the Remote-Mount Mounting Bracket Kit KT23117. Kit contents are shown in Figure 9-3. This kit is Item 1 listed in Table 5-4 (page 36).

The 110-Watt remote-mount radio’s mounting bracket is FM101319V2. This bracket is included in Mounting Bracket Kit KT101533V2, which is included with Installation Kit MAMW-ZN9Q.



**Figure 9-3: Remote-Mount Mounting Bracket Kit KT23117 for 35 and 50-Watt Radios**

Typically, the radio’s mounting bracket is mounted in the vehicle’s trunk, on the top surface of the trunk tray or on the trunk floor. However, it can be suspended from the trunk’s rear deck if the surface is completely flat and the thickness of deck’s sheet metal is adequate.

When selecting a mounting location for the radio, verify sufficient clearance can be maintained around the radio for installation and service access. A minimum clearance of four (4) inches (approximately 10 centimeters) is recommended at the rear, left and right sides of the radio, and at least 2 inches (approximately 5 centimeters) of clearance is recommended at the front of the radio.

For the 35/50-Watt radio, the bracket is left-to-right symmetrical. The shortest portion of the bracket’s side rails are at the rear.

The bracket used with the 110-Watt radio is both left-to-right and front-to-rear symmetrical.

As installations differ, bracket-to-vehicle mounting screws are not included. Utilization of ¼-inch-diameter, 28-thread-per-inch (¼-28) stainless-steel self-locking hardware (i.e., machine screws with washers and locking nuts) is highly recommended. However, ¼-inch stainless-steel self-drilling screws may be employed to speed installation time. Self-drilling screws such as “TEK” screws do not require drilling of a pilot hole prior to installation. Do **not** use common self-threading sheet metal screws because they will loosen over time with vehicle vibrations.

The bracket has four (4) available mounting holes. All four must be used to secure the bracket to its mounting surface.

The following mounting procedure is recommended:

1. Using the mounting bracket as a template, mark and drill four (4) mounting holes into the mounting surface as required per the type of hardware used. For the 35/50-Watt radio, when it is installed in the bracket, it will extend approximately one (1) inch past the front edge bracket, and at the rear, it will extend approximately ½-inch past the rear edge of the bracket. This distance at the rear does not

include space required for cable connections at the rear of the radio. As previously stated, a clearance of at least four (4) inches (approximately 10 centimeters) at the rear of the radio is recommended.

2. Temporarily remove the bracket and deburr all of the newly drilled holes.
3. If necessary, apply an approved paint or rust-inhibitor at the holes in the mounting surface.
4. Set the bracket back into place and verify front-to-rear orientation.
5. Install and tighten the mounting screws/hardware.
6. Verify the bracket is firmly secured to the mounting surface. A secure mount prevents unreasonable vibration, which could damage the radio and/or cause its cable connections to loosen.

### 9.1.2 Inserting the Radio into the Mounting Bracket

The radio should now be inserted into the bracket according to this procedure:

1. Lay the radio down into the mounting bracket with the front of the radio at the front of the mounting bracket.
2. 35/50-Watt Radio: Attach the radio into the mounting bracket using six (6) of the M5 x 10 mm stainless-steel hex-head screws, flatwashers, and lockwashers included with the Mounting Bracket Kit (item 1 in Table 5-4). Tighten all six screws using a  $\frac{5}{16}$ -inch wrench (or a  $\frac{1}{4}$ -inch-drive ratchet with a  $\frac{5}{16}$ -inch socket) until each lockwasher is fully compressed and the radio is firm and flush between the brackets.  
  
110-Watt Radio: Attach the radio into the mounting bracket using four (4) of the M5 x 10 mm socket-head screws (with bell washers) included in the Mounting Bracket Kit. Tighten all four screws securely using a hex key (Allen) wrench until each lockwasher is fully compressed and the radio is firm and flush between the brackets.
3. Check the mounting area for proper clearance for cable service looping and for air circulation, plus an area to secure and stow the excess cable lengths.



NOTE

Proper mounting is one factor that ensures optimal radio performance. An improperly mounted radio may experience degradation in the quality of voice and data communications.

## 9.2 REMOTE-MOUNT RADIO'S DC POWER INSTALLATION



NOTE

Unless otherwise noted, references in the following subsections to the “control head” also apply to the hand-held controller.

### 9.2.1 Overview of On/Off Power Wiring Configurations

Radio on/off power control is accomplished by the control head, except in the case of a data-only radio installation which has no control head. In a standard installation, when the control head is turned on, it “wakes-up” the radio via data activity on the CAN link. The following power wiring configurations are supported:

- **Radio turns on and off automatically with vehicle's ignition switch/key** — This configuration allows the on/off state of the vehicle's ignition switch/key to control the on/off power state of the radio. The white wire of the control head's DC Power Cable is connected to a fused switched power source, typically identified as vehicle “Accessory” power. This source must switch on (up to positive

(+) battery voltage potential) when the vehicle’s ignition switch/key turns on, and it must switch off (to near zero volts) when the ignition switch/key turns off. The required fuse rating is 3 amperes. When using this configuration, the CH-721 control head’s on/off/volume control must be left in the on position for automatic power-up/down to function properly.



NOTE

In a remote-mount radio installation, to fuse the white wire of the control head’s DC Power Cable, a yellow waterproof (HFB type) fuse holder and a 3-amp AGC fuse are included with the cable.

- **Radio turns on and off with a manual switch** — This configuration is used when, for example, the radio must remain on even when the ignition key must be removed from the vehicle and a separate on/off switch is acceptable. **The** white wire of the control head’s DC Power Cable is connected to one side of a manually-controlled switch, and the other side of this switch is connected to unswitched and fused vehicle power. The required fuse rating is 3 amperes. When using this configuration, the CH-721 control head’s on/off/volume control must be left in the on position for automatic power-up/down to function properly. This does not apply to the HHC-731 hand-held controller.
- **Radio turns on with control head’s on/off/volume control (“hot wired”)** — This configuration allows radio on/off power control only via the control head’s on/off/volume control. It may be desired if, for example, the radio must remain on even when the ignition key must be removed from the vehicle and a separate on/off switch is not desired and/or not acceptable. The white wire of the control head’s DC Power Cable must be connected to unswitched and fused vehicle power. The required fuse rating is 3 amperes.

In all of the above cases, both the radio’s main DC power input (red wire) and the control head’s main DC power input (also a red wire) must each be connected through an in-line fuse to unswitched vehicle DC power. The red wire of the radio’s DC Power Cable must be connected to raw battery power (positive battery terminal) via the supplied fuse. Likewise, the red wire of the control head’s DC Power Cable must also be connected to unswitched vehicle DC power via another supplied fuse. The white ignition wire of the radio’s DC Power Cable is only used for the data-only radio (i.e., no control head), and it is the only means for turning its power on in the data-only radio installation.



CAUTION

Any DC input power provided to the radio shall be no higher or lower than 13.6 volts DC  $\pm 10\%$ . The DC input power should be free and clear of any AC noise or DC spikes above 18 volts. If the vehicle cannot meet these requirements, then DC conditioning will be required before any DC power is connected to the radio. This includes conditioning for both the radio’s main DC power input lead and for its switched ignition sense power input. DC conditioning can be accomplished by a noise filter or DC isolation equipment such as Harris part number FL-018314-001 or FL-018314-002, or similar units with equal specifications. However, these filters cannot be used with the 110-watt VHF mobile radio; in this case, consult with TAC for details if necessary. Also, a fuse must be placed in-line before any noise filter. Contact TAC for additional information.

### 9.2.2 DC Power Cable and Main Fuse Holder Installation

The radio’s DC Power Cable has a connector which mates to the radio’s power cable, a 20-foot red wire (for the main power connection), a 20-foot white wire (only connected in a data-only radio installation), and a 4-foot black wire (for the ground connection). Cable installation instructions are included in the following subsections.

Cable CA-012365-001 used with the 35 and 50-Watt radios has a 3-pin connector. It is supplied with waterproof fuse holders, two AGC-type fuses, and non-insulated ring terminals.

Cable 14002-0167-01 used with the 110-Watt VHF radio has a 5-pin connector. It is supplied with waterproof fuse holders, two fuses, and non-insulated ring terminals.

### 9.2.2.1 Black Wire Connection (Ground Wire)

1. Connect the DC Power Cable to the radio by mating its connector to the radio's "pigtail" style power cable connector as follows: Visually align the key and firmly push and turn the outer locking ring clockwise until it stops. A click will be sensed to confirm proper mating.



Do not confuse the radio's DC Power Cable which has a 6 or 10-AWG red wire with the control head's DC Power Cable which has a 12-AWG red wire. The radio requires much more DC operating current than the control head. Therefore, it requires the larger wire size of 10-AWG. **The part number of the radio's DC Power Cable is CA-012365-001 for 35 and 50-Watt radios (has 10-AWG red wire), or 14002-0167-01 for 110-Watt radios (has 6-AWG red wire).**

2. Prepare to connect the cable's black wire to vehicle ground by locating an area of vehicle metal within approximately two (2) feet of the radio. This surface **must** have a solid and stable connection to vehicle ground. If not, add grounding strap(s) as necessary.
3. Strip the area of any paint or dirt to expose a bare metal surface, approximately  $\frac{3}{4}$ -inch square.
4. Drill a hole in the approximate center of the bare metal surface, and deburr it. A  $\frac{3}{8}$ -inch non-insulated ring terminal is supplied with the cable to make this ground connection. Therefore, hole diameter should be appropriate for the utilized grounding screw/bolt size and type used to connect the ring terminal to the bare metal surface. This hardware is not supplied.
5. Cut the black wire to the required length plus some additional length for a service loop, then strip insulation back approximately  $\frac{1}{4}$ -inch.
6. Crimp a  $\frac{3}{8}$ -inch non-insulated ring terminal (supplied with the cable) to the end of the black wire.
7. Attach the ring terminal and black wire to the bare metal surface using stainless-steel self-locking hardware (i.e., machine screws with washers and locking nuts) or other appropriate hardware to ensure a reliable terminal-to-metal contact. Tighten securely.
8. Apply an approved paint or rust-inhibitor over the remaining exposed bare metal surface and around the ring terminal.

### 9.2.2.2 Red Wire and Main Fuse Holder Connection (Radio's Main Power Wire)

1. Continue installation of the radio's DC Power Cable by routing its 20-foot red wire to the location of the vehicle's battery (or its main DC bus bar or stud). Remove interior panels, door kick panels, etc., and route the wire through existing channels in the vehicle body as necessary. Protect the wire from possible chafing where necessary. Tie and stow the wire as necessary.



Plan the routing of the red wire carefully, using an existing access hole in the vehicle's firewall if possible. Alternately, drill a new hole approximately  $\frac{3}{8}$ -inch in diameter and install a small rubber grommet to protect the wire from chafing on the hole's sharp metal edge. **To prevent fumes from entering the passenger compartment, this hole/grommet/wire combination must also be sealed with a silicon-based sealer before completing the installation.**



Do **not** install any wiring or fuse holder over or in the near vicinity of the vehicle's engine. Excessive engine heat can cause permanent damage to these components and can lead to intermittent electrical connection to the battery.



Before making connections to the battery's positive post, carefully disconnect the battery's negative (ground) cable(s). This will prevent tools or other metallic objects which come in contact with the battery's positive terminal from shorting to vehicle ground, causing sparks or even a fire or an explosion! When disconnecting the negative cable(s), cover/insulate the positive post(s) if it is not already so a tool cannot short between the posts. Some vehicles, such as those with diesel engines have more than one battery; in this case, disconnect the negative cables at all batteries.

Radio and control head fuses should **not** be installed until all wiring is complete. This will prevent the radio from powering up prematurely and/or causing an in-rush of current that could lead to shorting of the battery, sparks, or even fire.

2. Obtain the orange waterproof (HFB type) fuse holder included with the DC Power Cable.
3. **Observe and follow the previously presented WARNING!**
4. Cut the red wire to the required length for connection to the battery's positive (+) battery terminal (or the main DC bus bar or stud).
5. Prepare to splice the waterproof fuse holder into the red wire by cutting it again, at approximately three (3) to six (6) inches from the end.
6. Strip all three (3) wire ends back approximately  $\frac{3}{8}$ -inch each, place a fuse holder shell on each wire, and securely crimp a fuse holder terminal to each wire end. Before crimping, verify fuse holder shells are oriented in the correct directions (i.e., with each large end towards the wire end).
7. Label this fuse holder and red wire appropriately (e.g., "M7300 Main Power: 15-AMP FUSE").
8. **Do NOT install a fuse into the fuse holder at this time.**
9. Crimp an appropriate electrical terminal to the short red wire. A corrosion-resistant  $\frac{3}{8}$ -inch ring terminal is included with the cable for this purpose, but another size corrosion-resistant terminal type (not supplied) may be used if required.
10. Connect the ring terminal directly to the battery's positive post (or if present, to a stud on the battery's main/non-switched power distribution terminal block).



Most M7300 radio installations have one or more control heads connected to the radio. In an installation of this type, the white wire of the radio's DC Power Cable requires no electrical connection. Rather than be cut from the cable, it is recommended that it be routed up to the vehicle's fuse box, coiled, labeled, and stowed for possible future use. The white wire of the control head's DC Power Cable is the radio installation's ignition sense input for on/off power control of both the control head and radio. Radio on/off power control is accomplished by the control head. The control head "wakes-up" the radio via data activity on the CAN link.

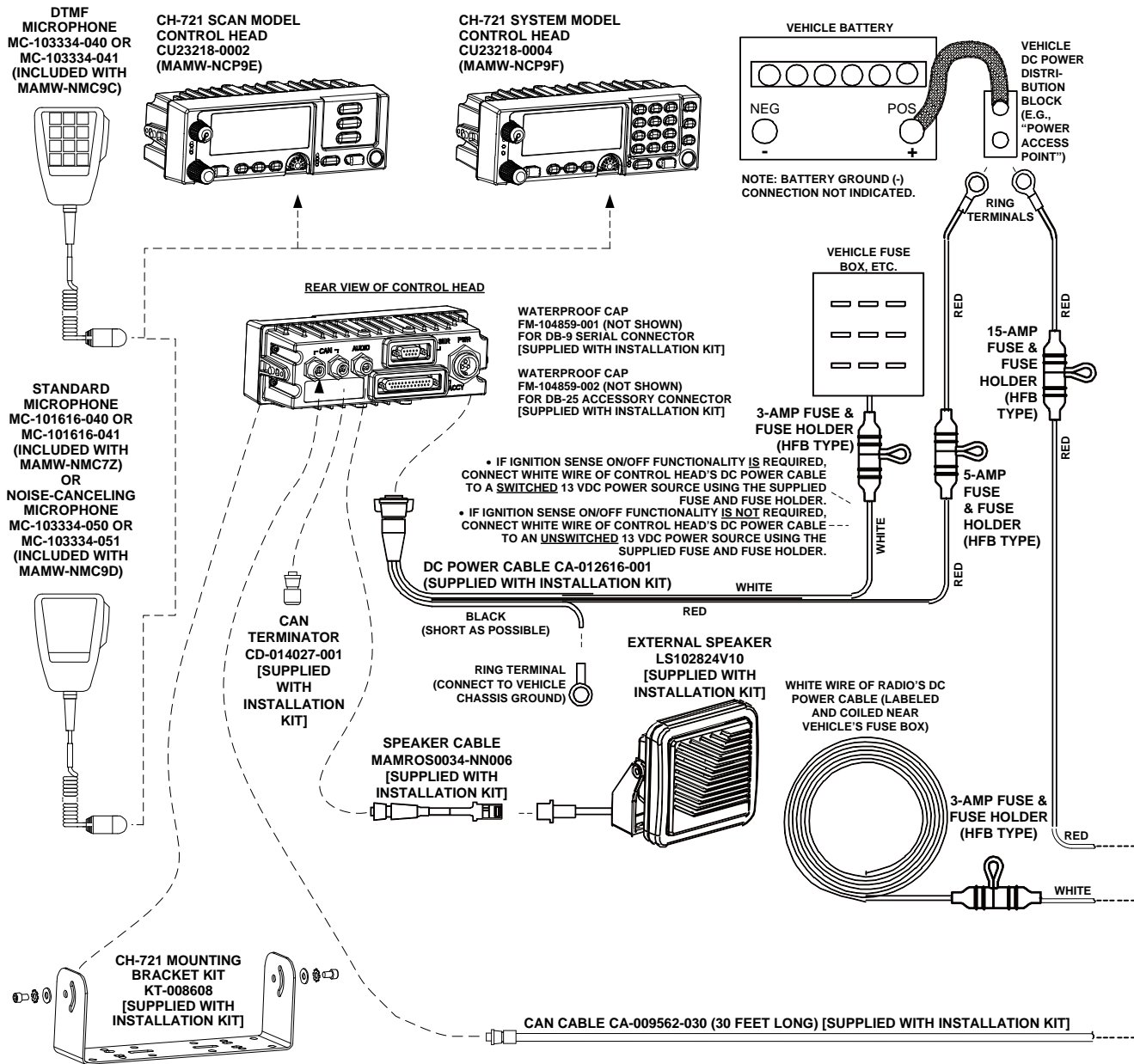

Figure 9-4: Wiring Diagram for a 35/50-Watt Remote-Mount Radio Installation

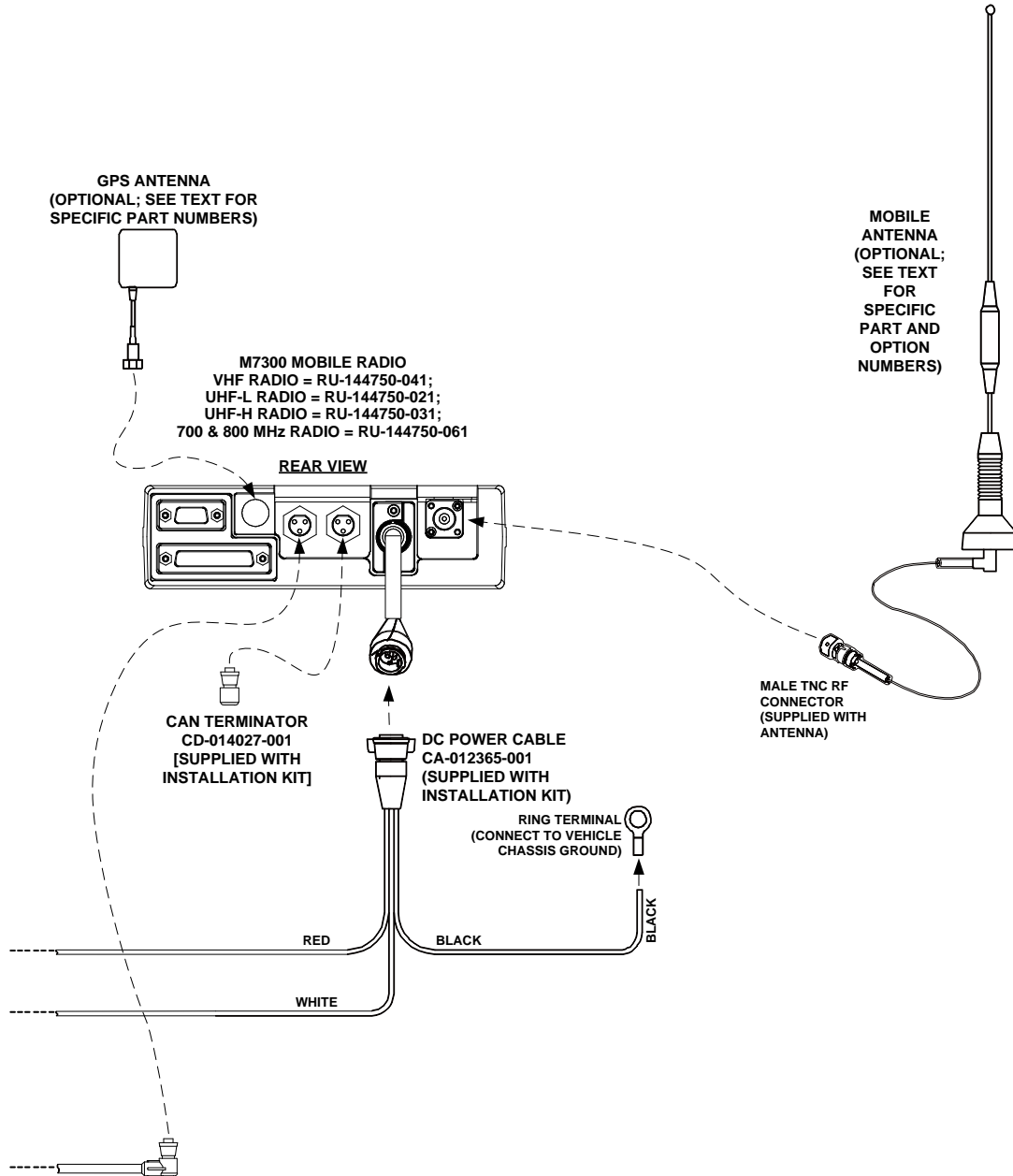

Figure 9-4: Wiring Diagram for a 35/50-Watt Remote-Mount Radio Installation (Cont.)

### 9.2.2.3 White Wire Connection (for Data-Only Radio Installations)

In the case of a data-only radio installation (i.e., no control head connected to the radio), the white wire of the radio's DC Power Cable is used as the radio installation's ignition sense input. Therefore, it requires electrical connection to a fused switched power source. The following procedure is recommended:

1. Route the 20-foot white wire of the radio's DC Power Cable to the location of the vehicle's switched power source connection point, typically identified as "Accessory" power. Remove interior panels, door kick panels, etc., and route the wire through existing channels in the vehicle body as necessary. Protect the wire from possible chafing where necessary. Tie and stow the wire as necessary.
2. Connect this white wire through a fuse to the switched power source in accordance with the instructions presented within the respective subsection of Section 9.3.4.2 (page 87) for the control head's white wire. Follow the procedure in Section 9.3.4.2.1 (page 87) if the vehicle's ignition switch/key must control the data-only radio's on/off power. Follow the procedure in Section 9.3.4.2.2 (page 88) if a manually-controlled switch must control the data-only radio's on/off power.



NOTE

The "hot wired" wiring configuration (as depicted in Section 9.3.4.2.3) cannot be utilized for the data-only radio, since this configuration does not employ the DC Power Cable's white wire.

### 9.2.3 Additional Hook-Up Required for a Data-Only Radio Installation

The CTLOn (control power on) logic input of a data-only radio must be grounded per this procedure:

1. Obtain M5300/M7300 Option Cable CA-012349-001.
2. Connect this cable's male DB-44 connector to the female DB-44 connector on the rear of the radio. Tighten the connector's two (2) jackscrews firmly.
3. Using an appropriate DB-25 connector, hook-up wire, ring terminal and hardware (not supplied), connect pin 14 of this cable's DB-25 connector (P4 pin 14) to vehicle ground. This grounds the radio's CTLOn input at pin 15 of the DB-44 connector. See Section 12.1 for additional information on the Option Cable. Keep the length of the ground wire as short as reasonably possible.
4. Tie and stow the cable and wire as necessary to protect them from possible cable chafing.



CAUTION

When servicing the radio and/or control head, always manually power-down the radio equipment via the control head's on/off/volume control knob, and then remove the main power fuse near the battery.

## 9.3 CH-721 CONTROL HEAD INSTALLATION



NOTE

This section includes installation instructions for the CH-721 control head. If the radio is being installed with and connected to an HHC-731 hand-held controller, skip this section and advance to Section 9.4 which begins on page 89.

### 9.3.1 General Information

The remote-mount M7300 mobile radio must be connected to a control head to provide the operator-to-radio interface. Two different control heads are available — the CH-721 Scan model and the CH-721 System model. See Figure 9-5 and Figure 9-6 respectively. The CH-721 Scan model control head features



three (3) large menu selection buttons. The System model control head has a 12-button keypad to allow advanced operations without the need of a DTMF-capable microphone.

Figure 9-7 on page 82 illustrates the rear panel of the two control head models. Both models have identical rear panels and rear panel connectors.

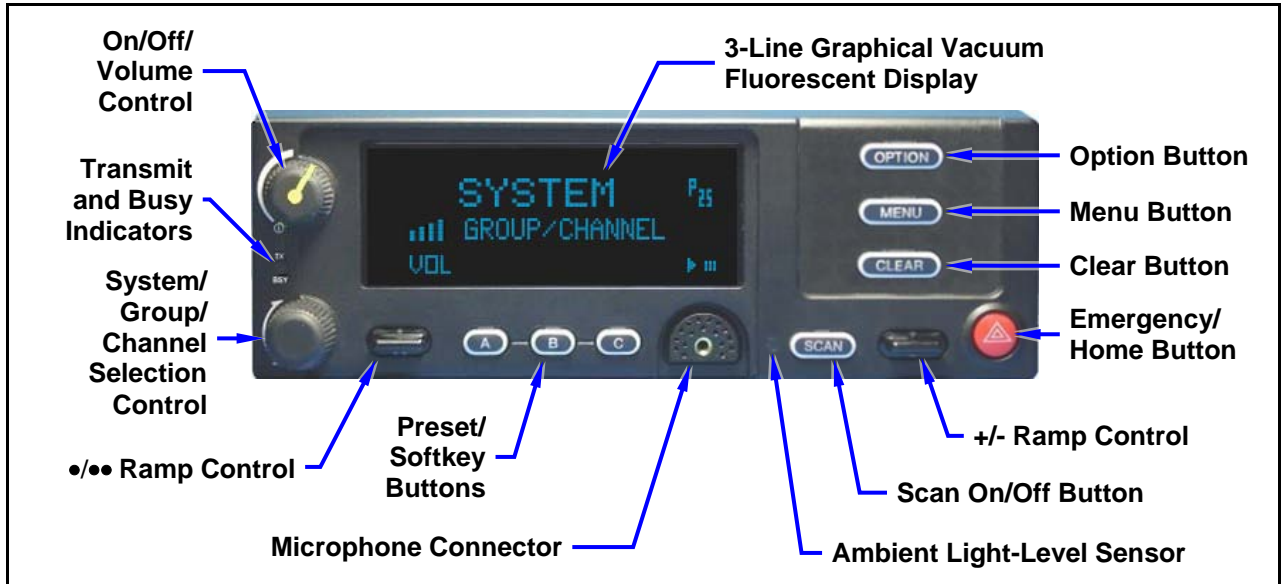

Figure 9-5: CH-721 Scan Model Control Head Front Panel

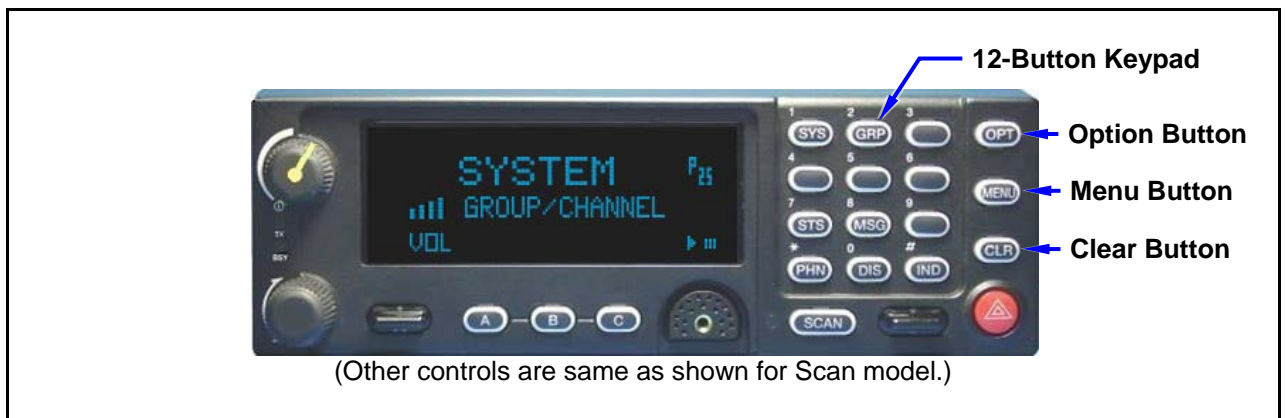
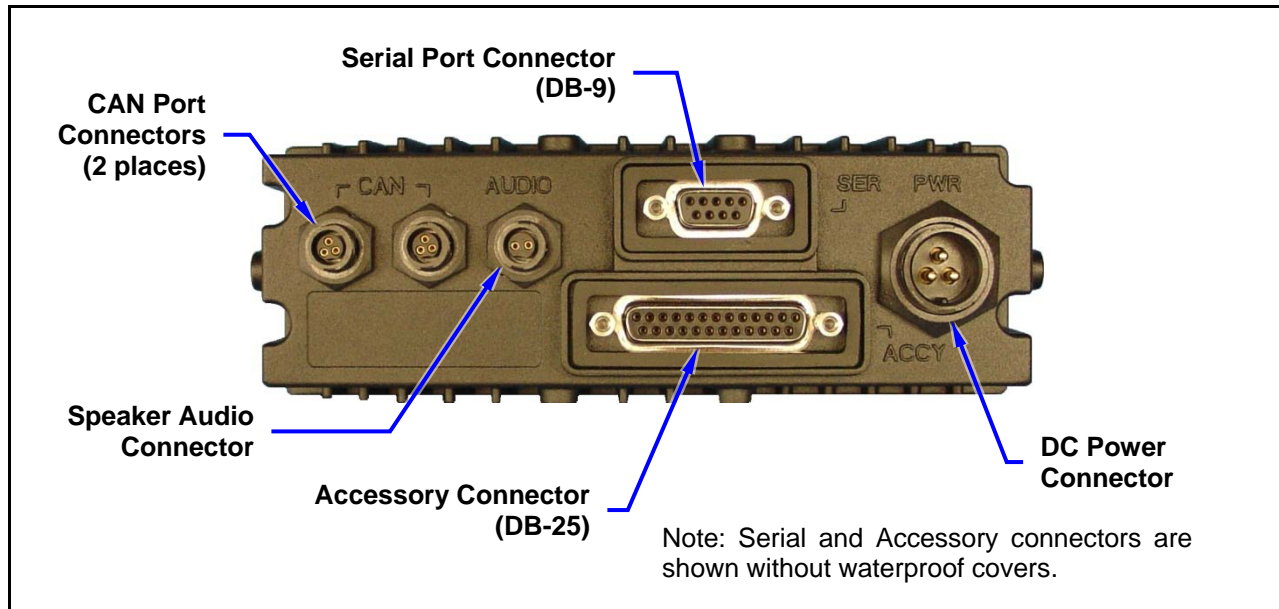

Figure 9-6: CH-721 System Model Control Head Front Panel

The CH-721 control heads feature a large easy-to-read 3-line graphical vacuum fluorescent display, an on/off/volume control knob, menu controls and buttons, trunking mode buttons, an emergency/home button, a scan on/off button, and three (3) preset buttons. Other front panel components include a microphone connector and LED-type indicators. One LED indicator is the busy indicator that lights when the radio is receiving a call and one is the transmitter-enabled indicator that lights when the radio is transmitting.



**Figure 9-7: CH-721 Rear Panel (both control head models)**



**NOTE**

Prior to installing the control head, verify it has the proper software version installed and verify it has been properly configured for customer use.



**NOTE**

Because Installation Kit MAMW-NZN7R contains the most complete set of materials for installing the radio and control head, the following instructions make repeated reference to items within this kit. Item numbers given in parenthesis refer to items in the kit as listed in Table 5-4 on page 36.

In a mobile installation, more than one control head can be connected to one mobile radio for multi-head installations. A multi-head installation may be required in a vehicle such as a fire truck or any large vehicle where more than one operator may require use of the radio. Multi-head installations also provide other benefits such as intercom functionality between different operator positions.

**9.3.2 Control Head Mechanical Installation**

**9.3.2.1 Selecting the Mounting Location**

When selecting a location for the CH-721 control head, first observe the safety and operator-convenience related information presented in Section 6.1 on page 43. Always consider and include clearance for the microphone's connector that must mate to the mic connector on the front panel of the head, and clearance for the connectors/cables that must mate to the connectors on the rear panel of the head. The CH-721 control head can be mounted under or on top of a mounting surface (typically the vehicle's dash) as space permits using either the standard U-shaped mounting bracket or the optional mounting pedestal.

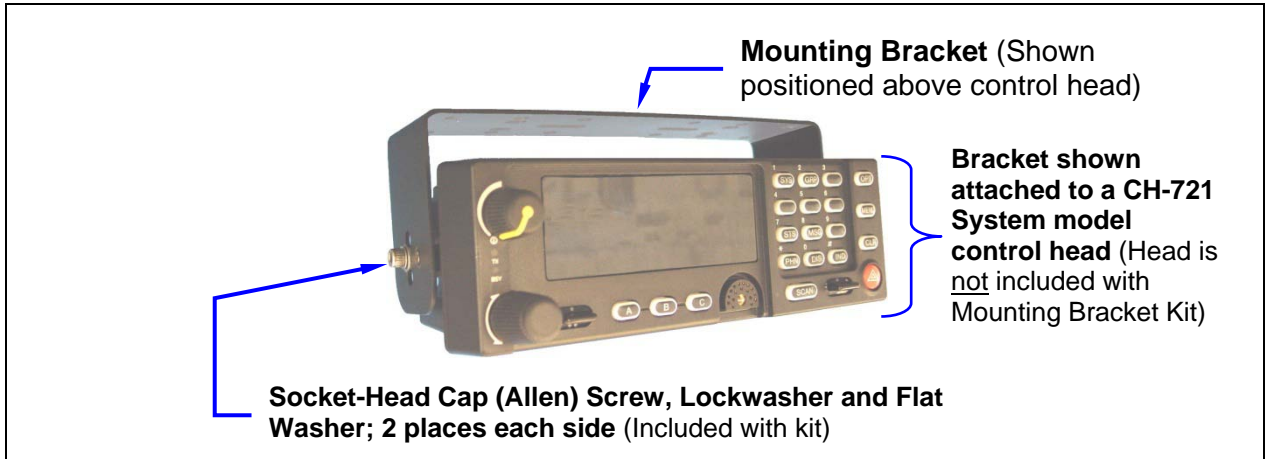

**Figure 9-8: Standard U-Shaped Control Head Mounting Bracket (Kit Part Number KT-008608)**

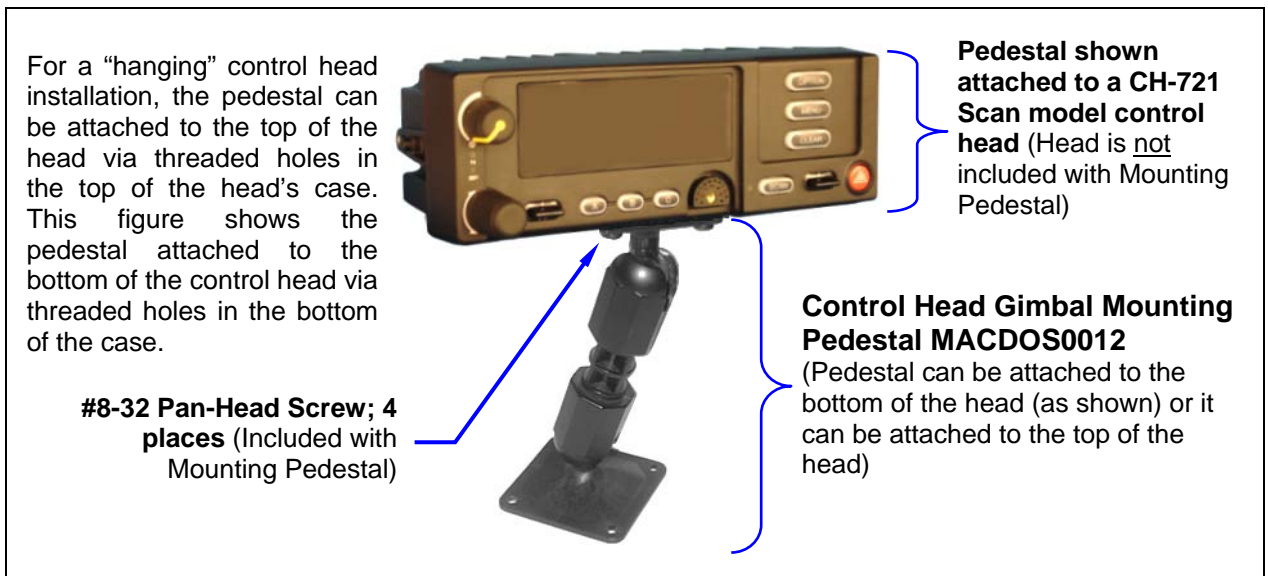

**Figure 9-9: Optional Control Head Gimbal Mounting Pedestal (Part Number MACDOS0012)**

### 9.3.2.2 Using the Standard U-Shaped Mounting Bracket

If the standard U-shaped mounting bracket will be used to mount the control head, the following mounting procedure is recommended. As listed in Table 5-4 on page 36, this bracket is item 2 in the Installation Kit.

1. Using the mounting bracket as a template, mark and drill mounting holes into the mounting surface as required. The round and elliptical holes in the bracket's vehicle mounting surface are symmetrical, so forwards/backwards positioning is not important during this step. However, positioning is important in the next step.



Before drilling holes and/or installing mounting screws, verify these operations will not damage or interfere with any existing vehicle component (the fuel tank, a fuel line, the transmission housing, existing vehicle wiring, etc.). Always check to see how far the mounting screws will extend below the mounting surface prior to installation. Always deburr drilled holes before installing screws.

2. Position the bracket at the mounting surface so the two round holes in its two side "ears" are nearest to the normal location of the operator (typically towards the rear of the vehicle) and the two slotted holes are furthest from the normal location of the operator (typically towards the front of the vehicle).
3. Install and tighten the mounting screws. Screws for mounting the bracket to the mounting vehicle's surface are not included, as all installations differ. Self-threading screws are recommended. Use of self-drilling screws may cause damage to some mounting surfaces, such as a plastic dash panel.
4. Verify the bracket is held firmly to the mounting surface. Firm mounting prevents unreasonable vibration, which could damage the control head and/or cause its cable connections to loosen.
5. Slide the control head into the bracket, placing the two pegs protruding from its left and right sides into the respective round holes in the bracket's two side "ears."
6. In each side "ear" of the mounting bracket, start a #8-32 hex-socket-head cap (Allen) head screw with a lockwasher and a flat washer by inserting the screw through the slotted hole in the bracket and then into the threaded hole in the side of the control head. This hardware is included with Mounting Bracket Kit. The lockwasher should be adjacent to the screw head and the flat washer should be adjacent to the bracket. Turn each screw clockwise as observed from the head of the screw.
7. The control head can be positioned at various angles for best display viewing at the normal position of the operator. As necessary, turn it on the pegs to a good position and tighten both screws using an 1/8-inch hex key (Allen) wrench until the control head is held firmly in place. Do not over-tighten.

### 9.3.2.3 Using the Gimbal Mounting Pedestal (Optional)

An optional Gimbal Mounting Pedestal, part number MACDOS0012, may be purchased separately to replace the standard U-shaped mounting bracket. This pedestal can be attached to the bottom of the control head as shown in Figure 9-9, and then mounted to a mounting surface below the two. It can also be attached to the top of the head and then mounted to a mounting surface above the two.

## 9.3.3 Control Head-to-Radio CAN Cable Connections

### 9.3.3.1 General Information

A remote-mount radio installation requires a CAN cable between every two "CAN devices" and CAN terminators on each end of the CAN link. The M7300 mobile radio is considered a CAN device, and each CH-721 control head in the installation is also considered a CAN device. Figure 9-10 illustrates CAN

cable and CAN terminator connections for a single control head installation. Figure 9-11 illustrates this for a multi-head control head installation where, for example, one control head is located at the main operator location and another is located near the rear of the vehicle. Because CAN devices do not have internal terminators, the CAN link must be terminated at both ends via external CAN terminators, as depicted in the following figures.

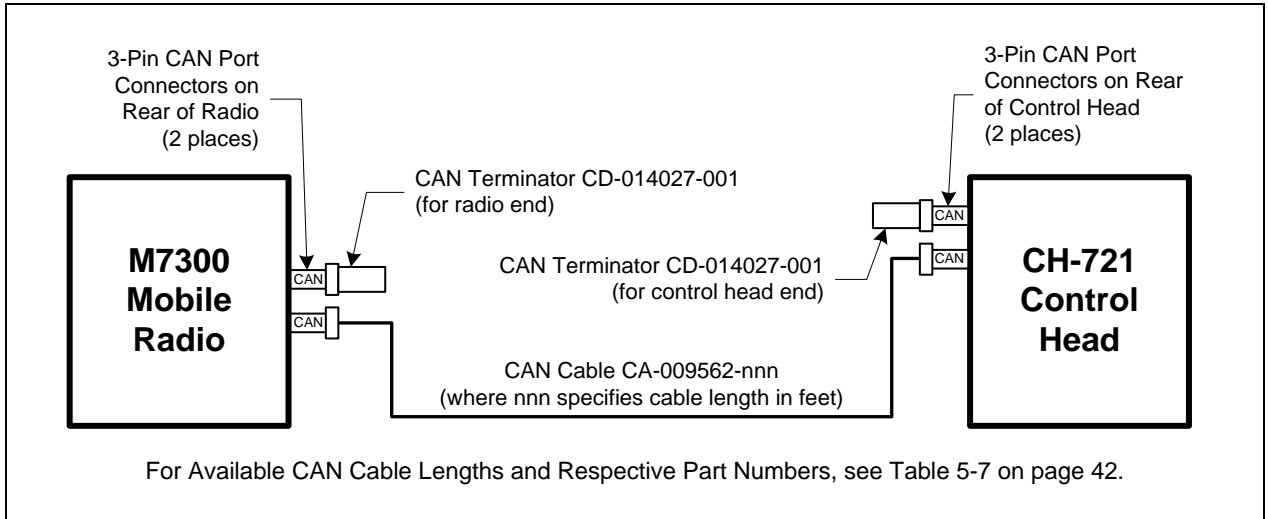

**Figure 9-10: CAN Link Connections for a Single Control Head Installation**

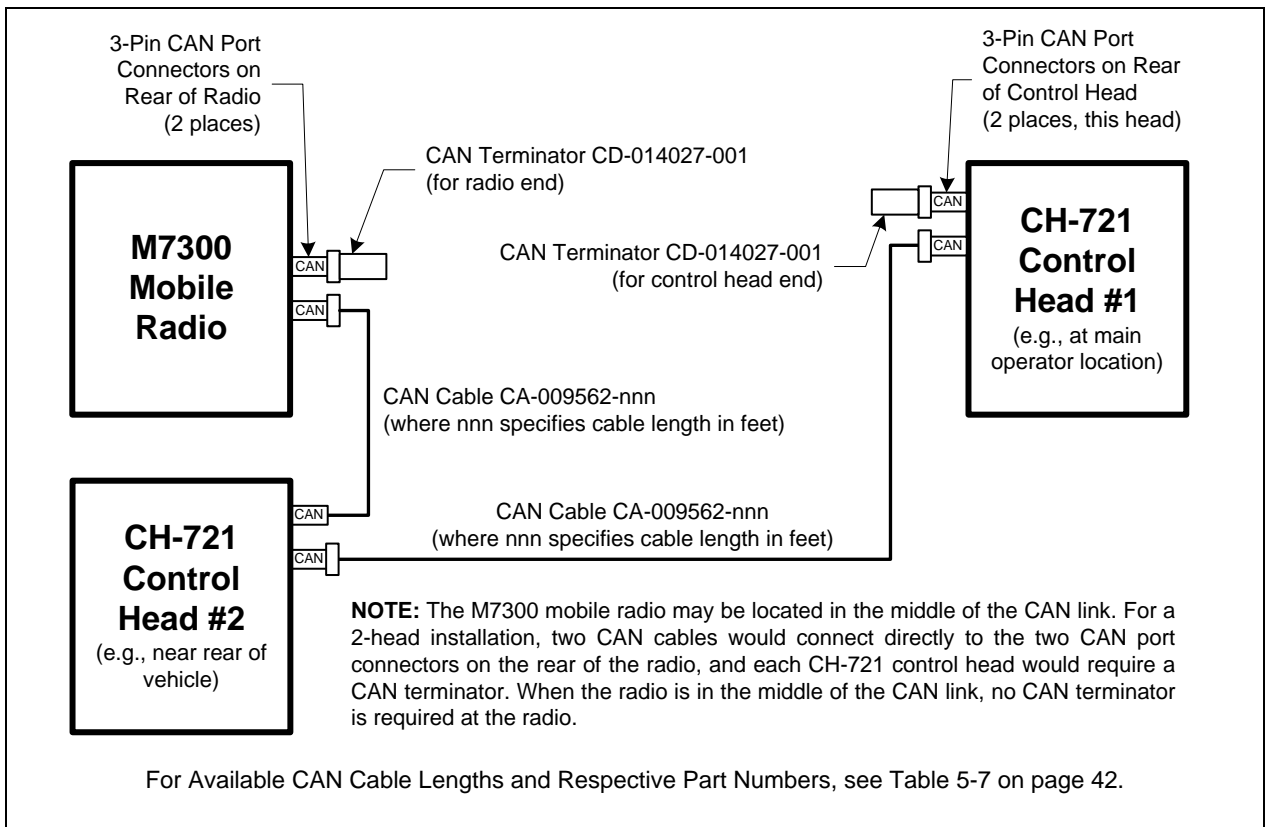

**Figure 9-11: Typical CAN Link Connections for a Multi-Control Head Installation**

Both the radio and the control head have two CAN ports to support “daisy-chaining” of multiple control heads or other CAN devices. Figure 6-1 on page 44 shows the radio’s two CAN port connectors, which

are located near the center of the radio's rear panel. Figure 9-7 on page 82 shows the two CAN port connectors on the control head's rear panel.

### 9.3.3.2 Make CAN Link Terminations and Cable Connection

Follow this procedure for an installation which has only one control head. For a multi-control head installation, refer to Figure 9-11 as necessary.

1. Mate a CAN Terminator (item 5 in Table 5-4 on page 36) with either one of the two smaller 3-pin CAN port connectors on the rear panel of the CH-721. This action makes the CAN termination at the control head end of the CAN link.



NOTE

When mating any CAN connection (terminators and cables) to a rear panel connector, visually align the ¾-moon-shaped keys of the connectors, and then gently push and turn the outer locking ring of the plug (male) connector clockwise until it stops. A mild click will be sensed to confirm proper mating. Without visual alignment as a guide, it is possible with excessive force to mate the CAN connectors improperly. Damage to the connector(s) may result. Therefore, visual alignment is recommended when mating CAN connectors.

2. Obtain a CAN Cable and mate it to the other CAN port connector on the rear panel of the CH-721. Typically, item 6 in Table 5-4 is utilized, a 30-foot CAN cable.
3. Route the CAN cable through the vehicle's interior wire/cable channeling to the radio. Remove interior panels, door kick panels, etc., as necessary. Protect the cable from possible chafing as necessary.



NOTE

If the mobile radio installation must be interfaced to GPS and/or MDT equipment, simultaneous routing of the related interface cables along with the CAN cable will be time-saving. For GPS and MDT equipment cable part numbers and cable installation procedures, refer to Sections 13 and 14 respectively.

4. Mate this other end of the cable to one of the two CAN port connectors on the rear panel of the radio.
5. Mate another CAN Terminator to the other CAN port connector on the rear panel of the radio. This action makes the CAN termination at the radio-end of the CAN link.
6. Loop, tie and stow the excess cable as necessary, leaving a service loop at the back of the radio and at the back of the control head.

### 9.3.4 Control Head Power Cable Installation

Plan the route of the control head's DC Power Cable carefully. Do not route the cable where it will be damaged by heat sources or by casual contact, and protect it from wire chafe per standard installation methods. The following procedures are recommended:

#### 9.3.4.1 Install DC Power Cable and Make Power and Ground Connections

1. Connect the control head's DC Power Cable (item 4 in Table 5-4 on page 36) to the large 3-pin connector at the rear of the head. Visually align the key and gently push and turn the outer locking ring clockwise until it stops. A click will be sensed to confirm proper mating.
2. At the back of the control head, locate a nearby section of vehicle chassis ground and strip this area of any paint or dirt to expose a bare metal surface.

3. Cut the black wire of the control head's DC Power Cable to the required length, plus a service loop of at least six (6) inches, then strip it and crimp a  $\frac{3}{8}$ -inch ring terminal to it. Two ring terminals of this type are included with the cable.
4. Drill a hole as necessary and attach this ring terminal to chassis ground. Use stainless-steel self-locking hardware (i.e., machine screws with washers and locking nuts) or other appropriate hardware to ensure a reliable terminal-to-metal contact. Tighten securely.
5. At the back of the control head, tie and stow the cable as necessary.
6. For the positive 12-volt DC main power source connection, route the cable's red wire to the location of an **unswitched** 12-volt DC power source, typically near the vehicle's battery. Remove interior panels, door kick panels, etc. Protect the wire from possible chafing as necessary. This is the control head's main DC power source.
7. Obtain one of the yellow waterproof (HFB-type) fuse holders included with the control head's DC Power Cable.
8. Cut excess length from the red wire and splice the fuse holder into it, near the location of the unswitched 12-volt DC power source connection point.
9. Using an appropriate electrical terminal, connect the red wire to the unswitched DC power source. A  $\frac{3}{8}$ -inch ring terminal is included with the cable for this purpose, but another terminal type (not supplied) may be used if required.
10. Obtain the 5-amp AGC-type fuse included with the cable, and install it into the fuse holder.

**NOTE**

Do not share the control head's fuse with any other device. Doing so can cause excess current to flow through the fuse, causing it to blow unnecessarily.

**CAUTION**

The fuse for the control head's red wire is rated at 5 amperes. The 3-amp fuse included with the cable must **not** be used for fusing the control head's main DC power. It fuses the head's white wire.

### **9.3.4.2 Connect DC Power Cable's White Wire**

A review of the information presented in Section 9.2.1 (page 74) may be beneficial at this time. As required per the chosen power-up configuration, connect the white wire by following one of the three procedures presented in the respective sub-section that follows.

#### **9.3.4.2.1 Control Head and Radio Turn on with Vehicle's Ignition Switch/Key**

With this wiring configuration, the control head and radio automatically turn on and off with the vehicle's ignition switch/key. The white wire of the control head's DC Power Cable is sometimes referred to as the "white ignition switch wire" or the "ignition sense input wire." In this configuration, the white wire connects to a switched power source, typically identified as "Accessory" power, that switches on and off with the vehicle's ignition switch/key. When using this configuration, the CH-721 control head's on/off/volume control must be left in the **on** position for automatic power-up/down to function properly.



The white ignition sense wire must be connected to a fused power source that switches from approximately zero volts to approximately +13.6 volts when the vehicle's ignition switch/key is turned from the OFF position to the ACCESSORY and RUN positions. Use of a switched power source that is subject to voltage changes as a result of other actions, such as opening a vehicle door, may result in undesirable radio power cycles.

1. Locate the vehicle's switched ignition or "Accessory" power connection point that will be used for the switched ignition 12-volt DC power source. This point is typically located at or near the vehicle's fuse panel. It may be necessary to consult the vehicle manufacturer's wiring diagram.
2. Route the white wire of the control head's DC Power Cable from the back of the head to the area near this connection point. Protect the wire from possible chafing as necessary.
3. Obtain one of the yellow waterproof (HFB-type) fuse holders included with the control head's DC Power Cable.
4. Cut excess length from the white wire and splice the fuse holder into it, near the location of the connection point.
5. Using an appropriate electrical terminal, connect the white wire to the switched power connection point. An open-barrel spade terminal is included with the cable for this purpose, but another type of terminal (not supplied) may be used as required.
6. Obtain the 3-amp AGC-type fuse included with the cable, and install it into the fuse holder.
7. Tie and stow all wiring as necessary so it remains out of the way of casual contact and wire chafe is avoided.

#### 9.3.4.2.2 Control Head and Radio Turn On with a Manual Switch

With this wiring configuration, the control head and radio are manually turned on and off via an on/off switch mounted separately from the control head and radio, not through the vehicle's ignition switch/key. This configuration is used when, for example, the radio must remain on even when the ignition key must be removed from the vehicle and a separate on/off switch is acceptable and/or required. In this configuration, the white wire connects to a fused switched power source such as that provided by a toggle switch mounted on the vehicle's dash panel. When using this configuration, the CH-721 control head's on/off/volume control must be left in the on position for automatic power-up/down to function properly.

1. Route the white wire of the control head's DC Power Cable from the back of the head to an area near the location of the panel-mounted on/off switch. Protect the wire from possible chafing as necessary.
2. Cut a short section (6 to 8 inches) off the end of the white wire and strip the ends.
3. Obtain one of the yellow waterproof (HFB-type) fuse holders included with the control head's DC Power Cable, and crimp one half of it to one end of the short section of wire.
4. Using an appropriate electrical terminal, connect this short white wire to unswitched 12-volt DC power source at or near the vehicle's fuse box.
5. Cut another section of white wire from the cable. This wire must be long enough to reach from this fuse holder to the location of the panel-mounted on/off switch.
6. Strip one end of this wire and crimp the other half of the waterproof fuse holder to this wire end.
7. Strip the other end of this wire and, using an appropriate electrical terminal, connect it to the common terminal of the switch.
8. Connect the white wire of the power cable to the load (switched) side of the switch.



9. If not already, mount the switch to the vehicle's dash panel, or other customer-selected location.
10. Obtain the 3-amp AGC-type fuse included with the cable, and install it into the fuse holder.
11. Tie and stow these wires as necessary so they remain out of the way of casual contact and wire chafe is avoided.
12. Label this power switch accordingly. For example: "**RADIO ON/OFF.**"

#### **9.3.4.2.3 Control Head and Radio Are "Hot Wired"**

In the "hot-wired" configuration, the control head and radio are turned on and off only by the control head's on/off/volume control located on the front panel of the control head. In this configuration, the control head's white wire must be connected to **unswitched and fused 12-volt** vehicle power. Follow the procedure presented in Section 9.3.4.2.1, except connect the white wire to unswitched battery power instead of switched ("Accessory") power. Be sure to fuse this connection with the provided in-line fuse holder and 3-amp AGC fuse.

## **9.4 HHC-731 HAND-HELD CONTROLLER INSTALLATION**

In a remote-mount M7300 mobile radio installation, the HHC-731 hand-held controller can be used in place of the CH-721 control head. This easy-to-use hand-held mobile radio controller is primarily designed for use in harsh environments such as maritime (i.e., boating) applications and All-Terrain Vehicle (ATV) applications. The HHC-731 hand-held controller has easy-to-use buttons, a tough liquid-crystal display (LCD), and a built-in microphone. As of the publication of this manual, only one (1) HHC-731 hand-held controller can be connected to a radio, and without any connected CH-721 control heads. The front of the HHC-731 hand-held controller is shown in Figure 9-12.

Installation procedures for the HHC-731 hand-held controller are included in this section. Procedures include:

- Connecting CAN Link (see page 91);
- Mounting the HHC-731 Interface Cable and Bracket (see page 90);
- Connecting DC Power (see page 92);
- Mounting the HHC-731 Hanger (see page 95);
- Connecting the HHC-731 to the HHC-731 Interface Cable (see page 95);
- Connecting a Siren/Light Control System (see page 95); and,
- Connecting a Headset (see page 96).



Figure 9-12: HHC-731 Hand-Held Controller Front View

#### 9.4.1 Mounting the HHC-731 Interface Cable and Bracket

HHC-731 Interface Cable Mounting Bracket Kit KT-018752-001 is shown in Figure 9-13. This kit includes Bracket FM-018681-001 and mounting hardware, which secure the HHC-731 Interface Cable to a mounting surface. In Table 5-5 and page 38, the bracket kit is item 2, and the cable is item 2.



Figure 9-13: HHC-731 Interface Cable Mounting Bracket Kit KT-018752-001

Follow this procedure to attach the cable to the bracket, and to mount the bracket to a firm surface:

1. Attach the bracket to the large end of the cable using the two #6-32 machine screws and flatwashers included in the bracket kit. As illustrated in Figure 9-14, the two can be attached either perpendicular or parallel to each other. The “wings” of the bracket should be positioned away from the cable. Only two of four center-most holes in the bracket are used.
2. Tighten the two (2) screws securely with a #1 Phillips screwdriver. Do not over-tighten.

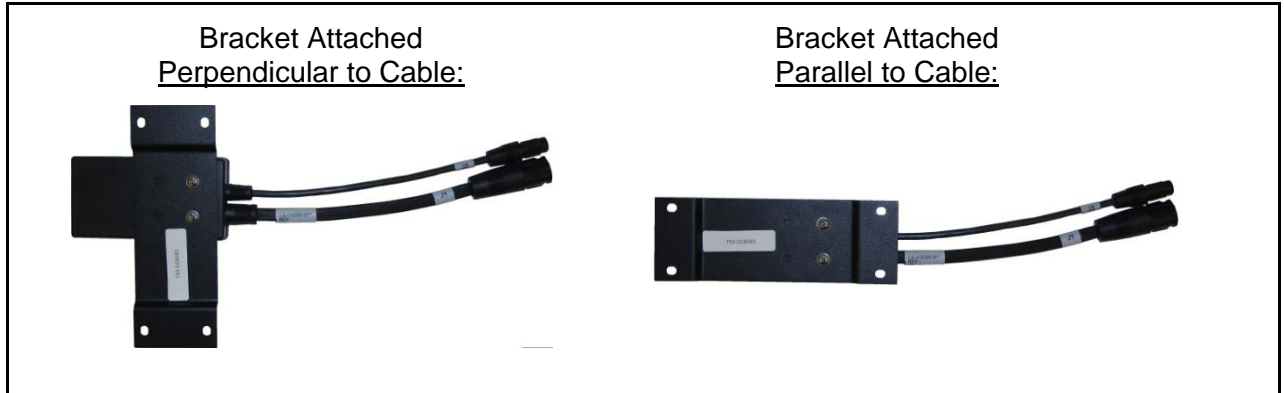

**Figure 9-14: HHC-731 Interface Cable Mounting Bracket-to-Cable Positioning**

3. Select a firm mounting surface near the controller, for the bracket. Review and follow the safety and operator-convenience related information presented in Section 6.1 on page 43. Also, always consider and include clearance for the mating of the two connectors on each side of the square end of the cable, and for clearance for the two “pigtail” style cables extending from the bottom of the square end.
4. Using the four (4) corner holes of the mounting bracket as a template, mark and drill mounting holes into the selected mounting surface as required.



Before drilling holes and/or installing mounting screws, verify these operations will not damage or interfere with any existing vehicle component (the fuel tank, a fuel line, the transmission housing, existing vehicle wiring, etc.). Always check to see how far the mounting screws will extend below the mounting surface prior to installation. Always deburr drilled holes before installing screws.

5. Mount the mounting bracket and cable to the selected mounting surface using the thread-forming screws, lockwashers, and flatwashers included with the HHC-731 installation kit, or other screws as required per the mounting surface. Tighten the four screws securely, but do not over-tighten them.
6. Verify the mounting bracket is firmly mounted. Firm mounting prevents unreasonable vibration, which could damage the cable and/or cause its cable connections to loosen over time.

#### **9.4.2 Connecting CAN Link**

Connect the CAN link between the radio’s CAN port and the CAN port connector of the HHC-731 Interface Cable in accordance with this procedure. Connections are illustrated in Figure 9-15:

1. Mate a CAN terminator to either one of the two small 3-pin CAN port connectors on the rear panel of the radio. The CAN terminator is item 6 in Table 5-5.
2. Obtain a CAN cable and mate it to the other CAN port connector on the rear panel of the radio. Typically, the 30-foot CAN cable is used, item 7 in Table 5-5. Other length CAN cables may be used, as listed in Table 5-7 on page 42.
3. Route the CAN cable through the vehicle’s interior wire/cable channeling to the radio. Remove interior panels, door kick panels, etc., as necessary. Do not route the cable where it will be damaged by heat sources or by casual contact. Protect the cable from possible chafing and other damage as necessary.



NOTE

If the mobile radio installation must be interfaced to GPS and/or MDT equipment, simultaneous routing of the related interface cables along with the CAN cable will be time-saving. For GPS and MDT equipment cable part numbers and cable installation procedures, refer to Sections 13 and 14 respectively.

4. Mate the other end of the cable to the small 3-pin CAN port connector of the HHC-731 Interface Cable.
5. Loop, tie and stow the excess cable as necessary, leaving a service loop at the back of the radio and at the location of the interface cable.

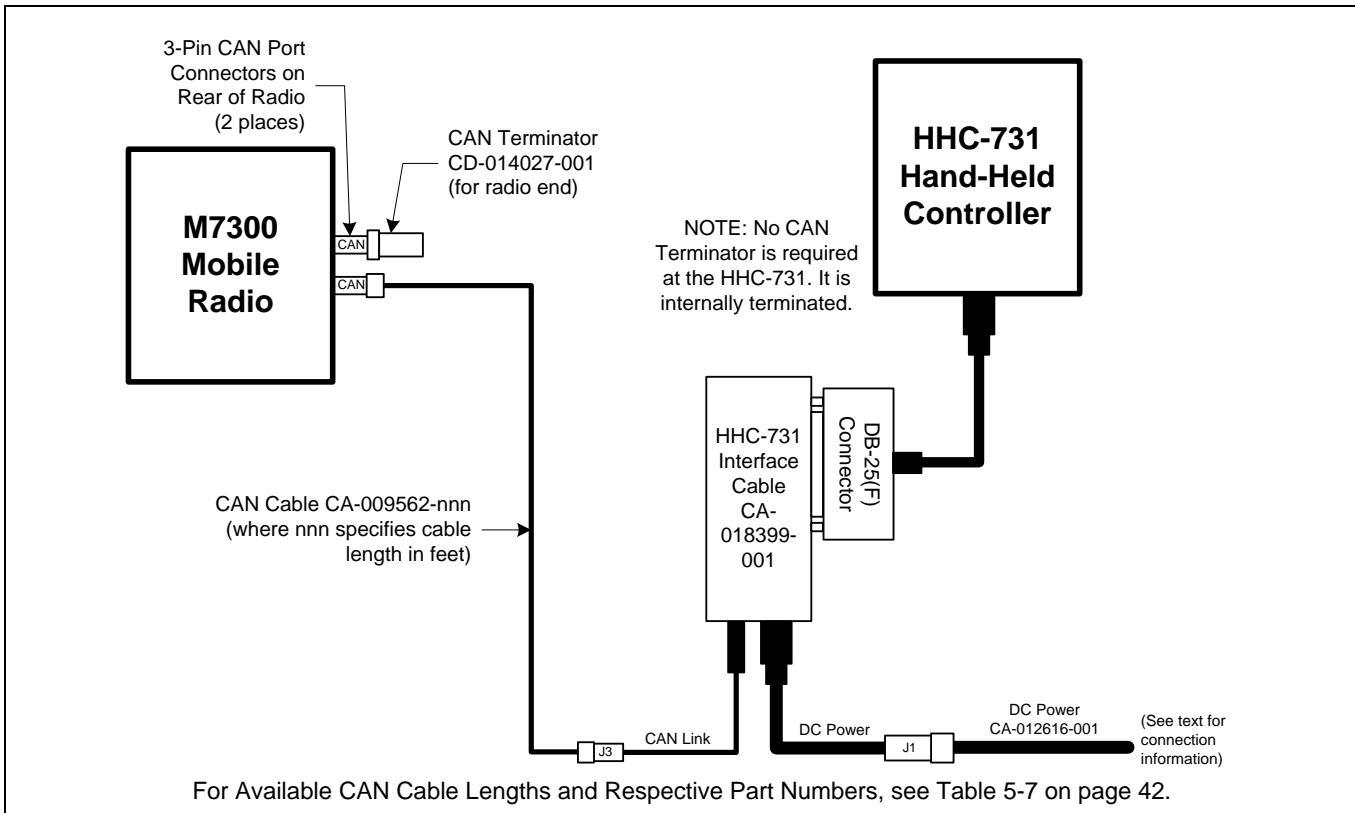

**Figure 9-15: M7300-to-HHC-731 CAN Link Connections**

### 9.4.3 Connecting DC Power

Plan the route of the DC Power Cable for HHC-731 hand-held controller carefully. Do not route it where it will be damaged by heat sources or by casual contact, and protect it from wire chafe per standard installation methods. The following procedures are recommended:

#### 9.4.3.1 **Install DC Power Cable and Make Power and Ground Connections**

1. Connect the DC Power Cable (item 5 in Table 5-5) to the large 3-pin connector of the HHC-731 Interface Cable. Visually align the key and gently push and turn the outer locking ring clockwise until it stops. A click will be sensed to confirm proper mating.
2. Near the HHC-731 Interface Cable's mounting location, locate a nearby section of vehicle chassis ground and strip this area of any paint or dirt to expose a bare metal surface.

3. Cut the black wire of the DC Power Cable to the required length, plus a service loop of at least six (6) inches, then strip it and crimp a 3/8-inch ring terminal to it. Two ring terminals of this type are included with the cable.
4. Drill a new hole as necessary and attach this ring terminal to chassis ground. Use stainless-steel self-locking hardware (i.e., machine screws with washers and locking nuts) or other appropriate hardware to ensure a reliable terminal-to-metal contact. Tighten securely.



**Do not ground the black wire by attaching it via the same hardware that secures the cable's mounting bracket.**



Before drilling holes and/or installing mounting screws, verify these operations will not damage or interfere with any existing vehicle component (the fuel tank, a fuel line, the transmission housing, existing vehicle wiring, etc.). Always check to see how far the mounting screws will extend below the mounting surface prior to installation. Always deburr drilled holes before installing screws.

5. Tie and stow the cable near the HHC-731 Interface Cable's bracket.
6. For the positive 12-volt DC main power source connection, route the cable's red wire to the location of an **unswitched** 12-volt DC power source, typically near the vehicle's battery. Remove interior panels, door kick panels, etc. Protect the wire from possible chafing as necessary. This is the hand-held controller's main DC power source.
7. Obtain one of the waterproof (HFB-type) fuse holders included with the DC Power Cable.
8. Cut excess length from the red wire and splice the fuse holder into it, near the location of the unswitched 12-volt DC power source connection point.
9. Using an appropriate electrical terminal, connect the red wire to the unswitched DC power source. A 3/8-inch ring terminal is included with the cable for this purpose, but another terminal type (not supplied) should be used as required.
10. Obtain the 5-amp AGC-type fuse included with the cable, and install it into the fuse holder.



Do not share the HHC-731 hand-held controller's fuse with any other device. Doing so can cause excess current to flow through the fuse, causing it to blow unnecessarily.



The fuse for the HHC-731 hand-held controller's red wire is rated at 5 amperes. The 3-amp fuse included with the cable must **not** be used for fusing the controller's main DC power. The 3-amp is used to fuse the controller's white wire.

### 9.4.3.2 Connect DC Power Cable's White Wire

Connect the DC Power Cable's white wire by following **one of the following three** procedures, per the customer's required on/off power control method:

#### 9.4.3.2.1 Hand-Held Controller and Radio Turn on with Vehicle's Ignition Switch/Key

With this wiring configuration, the HHC-731 hand-held controller and the radio turn on and off with the vehicle's ignition switch/key (power on also requires pressing of the HHC-731's front panel power on/off button). The white wire of the HHC-731's DC Power Cable is sometimes referred to as the "white ignition switch wire" or the "ignition sense input wire." In this configuration, the white wire of the HHC-731's DC Power Cable connects to a switched power source, typically identified as "Accessory" power, that switches on and off with the vehicle's ignition switch/key.



NOTE

The white ignition sense wire must be connected to a fused power source that switches from approximately zero volts to approximately +13.6 volts when the vehicle's ignition switch/key is turned from the OFF position to the ACCESSORY and RUN positions. Use of a switched power source that is subject to voltage changes as a result of other actions, such as opening a vehicle door, may result in undesirable radio power cycles.

1. Locate the vehicle's switched ignition or "Accessory" power connection point that will be used for the switched ignition 12-volt DC power source. This point is typically located at or near the vehicle's fuse panel. It may be necessary to consult the vehicle manufacturer's wiring diagram.
2. Route the white wire of the HHC-731's DC Power Cable to the area near this connection point. Protect the wire from possible chafing as necessary.
3. Obtain one of the waterproof (HFB-type) fuse holders included with the HHC-731's DC Power Cable.
4. Cut excess length from the white wire and splice the fuse holder into it, near the location of the connection point.
5. Using an appropriate electrical terminal, connect the white wire to the switched power connection point. An open-barrel spade terminal is included with the cable for this purpose, but another type of terminal (not supplied) may be used as required.
6. Obtain the 3-amp AGC-type fuse included with the cable, and install it into the fuse holder.
7. Tie and stow all wiring as necessary so it remains out of the way of casual contact and wire chafe is avoided.

#### 9.4.3.2.2 Hand-Held Controller and Radio Turn On with a Manual Switch

With this wiring configuration, the HHC-731 hand-held controller and radio are turned on and off via an on/off switch mounted separately from the HHC-731 and radio, not through the vehicle's ignition switch/key (power on also requires pressing of the HHC-731's front panel power on/off button). This configuration is used when, for example, the radio must remain on even when the ignition key must be removed from the vehicle and a separate on/off switch is acceptable and/or required. In this configuration, the white wire of the HHC-731's DC Power Cable connects to a fused switched power source such as that provided by a toggle switch mounted on the vehicle's dash panel.

1. Route the white wire of the HHC-731's DC Power Cable to an area near the location of the panel-mounted on/off switch. Protect the wire from possible chafing as necessary.
2. Cut a short section (6 to 8 inches) off the end of the white wire and strip the ends.
3. Obtain one of the waterproof (HFB-type) fuse holders included with the HHC-731's DC Power Cable, and crimp one half of it to one end of the short section of wire.
4. Using an appropriate electrical terminal, connect this short white wire to unswitched 12-volt DC power source at or near the vehicle's fuse box.

5. Cut another section of white wire from the cable. This wire must be long enough to reach from this fuse holder to the location of the panel-mounted on/off switch.
6. Strip one end of this wire and crimp the other half of the waterproof fuse holder to this wire end.
7. Strip the other end of this wire and, using an appropriate electrical terminal, connect it to the common terminal of the switch.
8. Connect the white wire of the power cable to the load (switched) side of the switch.
9. If not already, mount the switch to the vehicle's dash panel, or other customer-selected location.
10. Obtain the 3-amp AGC-type fuse included with the cable, and install it into the fuse holder.
11. Tie and stow these wires as necessary so they remain out of the way of casual contact and wire chafe is avoided.
12. Label this power switch accordingly. For example: "RADIO ON/OFF."

#### **9.4.3.2.3 Hand-Held Controller and Radio Are "Hot Wired"**

In the "hot-wired" configuration, the HHC-731 hand-held controller and radio are turned on and off only by the on/off button on the front of the HHC-731. In this configuration, the HHC-731's white wire must be connected to **unswitched and fused 12-volt** vehicle power. Follow the procedure presented in Section 9.4.3.2.1, except connect the white wire to unswitched battery power instead of switched ("Accessory") power. Be sure to fuse this connection with the provided in-line fuse holder and 3-amp AGC fuse.

#### **9.4.4 Mounting the HHC-731 Hanger**

An HHC-731 hanger is provided with the HHC-731 hand-held controller. Follow this procedure to mount the hanger:

1. Select a mounting surface location that will position the HHC-731 within easy reach of the radio operator's location. Consult with the customer as necessary. Also review the information presented in Section 6. The selected location must have sufficient clearance for the HHC-731 when it is hung in the hanger.
2. Using the hanger as a template, drill mounting holes in the surface of the selected location. Use self-locking hardware (i.e., machine screws with washers and locking nuts), self-drilling screws, or other appropriate hardware as necessary. Tighten securely.
3. Stow the HHC-731 in the hanger and verify it can be easily inserted and removed. A spring detent action keeps the HHC-731 firmly stowed.

#### **9.4.5 Connecting the HHC-731 to the HHC-731 Interface Cable**

1. Mate the HHC-731's female DB-25 connector to the male DB-25 connector of the HHC-731 Interface Cable. Tighten the two jackscrews securely, but do not over-tighten them.
2. If not already, tie and stow the HHC-731 Interface Cable.
3. Hang the HHC-731 in its hanger.

#### **9.4.6 Connecting a Siren/Light Control System**

Follow this procedure to connect a siren/light control system to the HHC-731 hand-held controller:

1. Obtain Accessory Cable 19B802554P24. This cable's diagram is included in Section 12.3.
2. Mate the Accessory Cable's male DB-25 connector (P1) to the female DB-25 connector of the HHC-731 Interface Cable. Tighten the two jackscrews securely, but do not over-tighten them.

3. Mate the male DB-25 connector of the siren/light control system's cable to the female DB-25 connector of Accessory Cable.
4. Continue with the installation instructions included with the siren/light control system. All references to the "control head" or "control unit" should be considered as the HHC-731 hand-held controller.

#### 9.4.7 Connecting a Headset

A headset can be connected to the HHC-731 hand-held controller by making connections at 25-pin option connector P3 (female DB-25) of the HHC-731 Interface Cable. The associated connector pins are listed in Table 9-1. An adapter cable must be field-fabricated to perform these connections. Modifying Accessory Cable 19B802554P24 is not recommended.

**Table 9-1: HHC-731 Headset Connections**

HHC-731 INTERFACE CABLE OPTION CONNECTOR PIN	SIGNAL NAME	DESCRIPTION
24	EXT_MIC_IN	Microphone audio input. Provides an approximate 1.5-volt DC bias.
1 or 7	VEH_A-	Ground/Reference for microphone audio, digital inputs INP1 and INP2.
4 or 22	INP1	Digital inputs 1 and 2. Use one as an external PPT line.
5 or 9	INP2	
13 or 18	HSAUDIO+	Headset speaker differential audio output. In headset applications, this 1-Watt-capable audio output <b>must</b> be externally-attenuated by installing a series resistor in <u>each</u> headset audio line. Typically, two 22-ohm ¼-watt resistors are used to limit the audio power applied to headset speaker elements to safe levels.
8 or 19	HSAUDIO-	

## 10 SPEAKER INSTALLATION

### 10.1 FRONT-MOUNT RADIO INSTALLATION

In a front-mount radio installation, total speaker cable length (of both cables) is approximately 10 feet (308 centimeters). Therefore, to include service loops in these cables, the speaker must be mounted within approximately 9.5 feet (290 centimeters) of the M7300 mobile radio.

1. Select a location for the speaker that will allow for proper listening range with a moderate volume setting.
2. Install the speaker using the hardware and mounting bracket supplied with it. For the speaker's part number, see Table 5-3 (page 35).
3. Route the speaker cable to the rear of the M7300 mobile radio.
4. Connect the M5300/M7300 Option Cable CA-012349-001 (item 5 in Table 5-3) to the DB-44 connector on the rear of the radio. Tighten the cable's two (2) jackscrews securely. See Section 12.1 for additional information on this cable.
5. Mate the Option Cable's 2-pin connector (identified P2) to the 2-pin connector on the end of the speaker cable. A mild click will be sensed to confirm proper mating.
6. Route the cables out of the way of casual contact. Tie and stow as necessary.



## **10.2 REMOTE-MOUNT RADIO INSTALLATION**

### **10.2.1 With CH-721 Control Head**

In a remote-mount mobile radio installation with the CH-721 control head, an audio amplifier in the CH-721 control head drives the external speaker.

For this case, total speaker cable length of both cables between the control head and speaker is approximately five (5) feet. Therefore, to include service loops in these cables, the speaker must be mounted within approximately 4.5 feet of the installation's CH-721 control head.

1. Select a location for the speaker that will allow for proper listening range with a moderate volume setting.
2. Install the speaker using the hardware and mounting bracket supplied with it. For the speaker's part number, see Table 5-4 (page 36).
3. Route the speaker cable to the rear of the CH-721 control head.
4. Mate the 6-inch speaker cable (item 8 in Table 5-4) to the 2-pin connector at the rear of the control head by visually aligning the  $\frac{3}{4}$ -moon-shaped keys of the connectors, and then pushing and turning the outer locking ring of the cable connector clockwise until it stops. A mild click will be sensed to confirm proper mating.
5. Connect the speaker cable's 2-pin plastic connector to the respective mating connector on the 6-inch speaker cable.
6. Route the cables out of the way of casual contact. Tie and stow as necessary.

### **10.2.2 With HHC-731 Hand-Held Controller**

In a remote-mount mobile radio installation with the HHC-731 hand-held controller, an audio amplifier in the mobile radio drives the external speaker. The HHC-731 does not have a high-power speaker audio amplifier. The following speaker installation procedure is recommended for this case:

1. Obtain the speaker, item 8 in Table 5-5.
2. Select a location for the speaker that will allow for proper listening range with a moderate volume setting.
3. Install the speaker using the hardware and mounting bracket supplied with it.
4. If no other optional connections are required at the back of the radio, obtain Speaker Only Option Cable CA-012349-007. This cable is item 9 in Table 5-5. It is approximately 20-feet long.

However, if other optional connections are required at the back of the radio (such as GPS NMEA-formatted serial data connections), obtain M5300/M7300 Option Cable CA-012349-001. This cable is approximately 5.5-feet long. In this case, the length of the cable's 2-wire speaker leads may not be sufficient to reach the 2-pin speaker connector of the option cable, and they will need to be lengthened using approved splicing techniques.

5. Connect the option cable to the DB-44 connector on the rear of the radio. Tighten the two jackscrews securely, but do not over-tighten them.
6. Route the option cable's 2-wire speaker lead to the 2-pin connector of the speaker cable.
7. Mate the option cable's 2-pin connector to the 2-pin connector of the speaker cable.
8. After mating the two 2-pin connectors, secure them together with nylon tie wrap so they will not disconnect with vehicle vibrations or other movements.
9. Route the cables out of the way of casual contact. Tie and stow as necessary.

## 11 MICROPHONE ATTACHMENT

There are several versions of microphones available for use with the radio. Each has a 17-pin connector that mates with the mic connector on the front panel of the control head. The mic's connector includes a captive thumbscrew that secures it to the mic connector on the front panel of the control head. A microphone clip is included with each microphone. The radio can be configured to provide a monitor function when the microphone is cradled in the clip. Connect the mic to the control head and install the clip as follows:

1. Position the mic's connector just in front of the control head's mic connector so its male pins can engage straight into the female (socket) pins of the control head's mic connector. The thumbscrew must be oriented directly **below** the hanging mic cable.
2. Mate the two connectors by pressing them fully together. Do not apply any force to the thumbscrew when mating the connectors.
3. Tighten the thumbscrew securely. Do not over-tighten it.
4. Using the microphone clip as a template, drill mounting holes in the surface of the selected location.
5. Select a mounting surface location that has clearance for the mic when it is clipped to the clip, and then attach the microphone clip to the surface. Use self-locking hardware (i.e., machine screws with washers and locking nuts), self-drilling screws, or other appropriate hardware as necessary. Tighten securely. The microphones have integrated hookswitches. Therefore, the microphone clip does **not** require grounding.
6. Clip the microphone to the clip.

## 12 OPTIONAL CABLES

### 12.1 M5300/M7300 OPTION CABLE CA-012349-001

M5300/M7300 Option Cable CA-012349-001 connects to the 44-pin I/O connector on the rear of the radio. It breaks out into several smaller standardized connectors, allowing straightforward access to external I/O interfaces provided by the radio. The cable also shortens radio removal and re-installation time when required. The cable is shown in Figure 12-1 below. The cable's 44-pin D-subminiature connector that mates with the connector on the rear of the radio is identified P1.



Observe caution before connecting any external device to the radio via its 44-pin I/O connector. If an external device has its own DC power source/cable (i.e., if it is powered separately from the radio), both the radio **and** the external device must be properly grounded **before** connecting the two units and before making a positive (+) power connection to either unit. Otherwise, fuse(s) inside the radio may fail (open) and/or other equipment damage could occur.

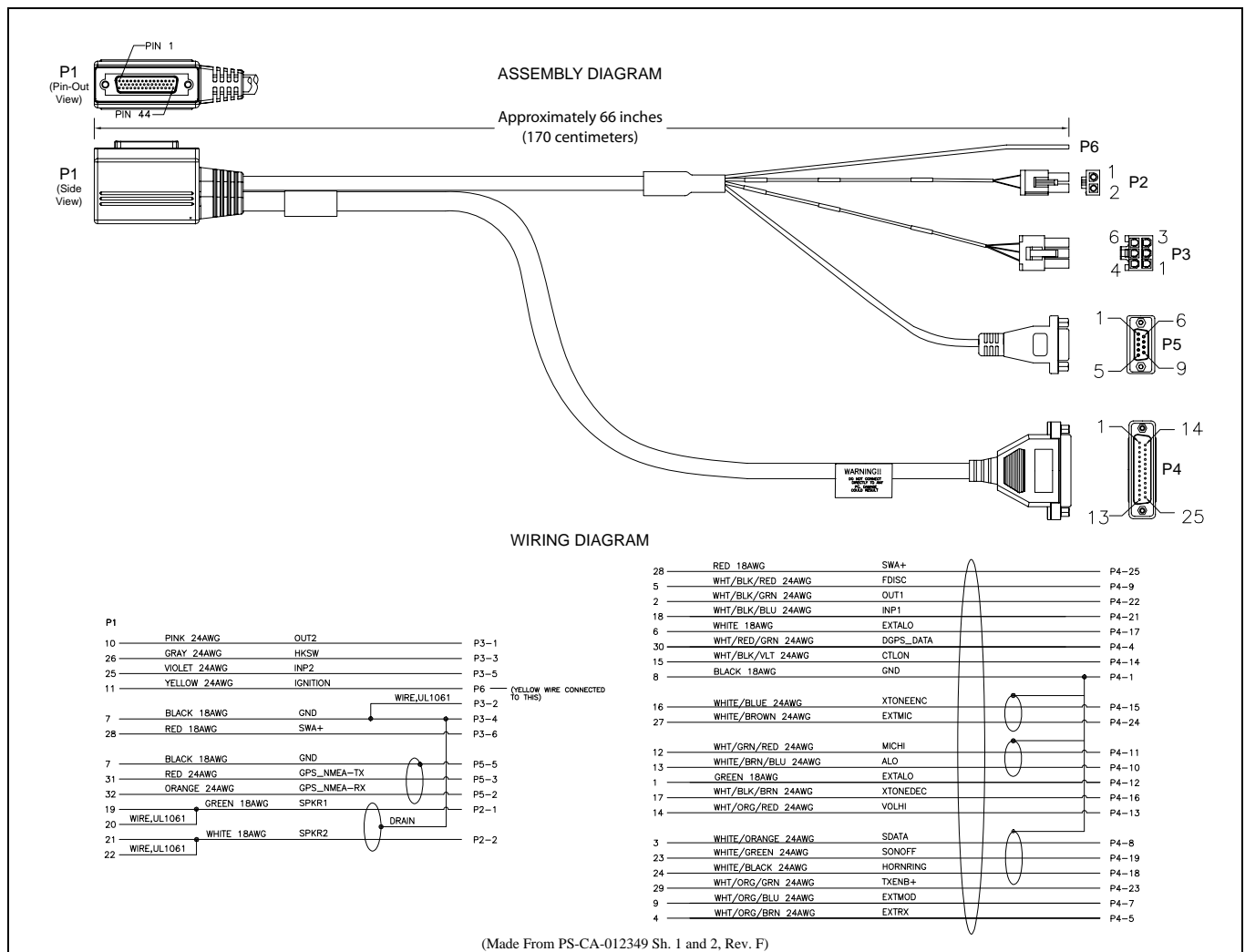

**Figure 12-1: M5300/M7300 Option Cable CA-012349-001**

P2, the cable's 2-pin connector, provides connections for an external speaker in a front-mount M7300 mobile radio installation, or in a remote-mount radio installation with an HHC-731 hand-held controller.

For connection information, see Section 10.1 and Section 10.2.2 respectively. P2 is not used in a remote-mount radio installation with a CH-721 control head, since the audio amplifier in the head drives the external speaker (speaker connection is made at the rear of the control head).

P3, the cable's 6-pin connector, is a connector for basic accessories (e.g., hookswitch, etc.).

P4, the cable's D-subminiature 25-pin connector, provides audio and data connections for optional equipment such as an external siren and light system (e.g., Federal Signal SS2000 SmartSiren<sup>®</sup>).

P5, the cable's D-subminiature 9-pin connector, provides NMEA-formatted GPS serial data connections for the external computer processing the NMEA-formatted GPS data received by the radio's internal GPS receiver. See Section 13 on page 110 for additional information.

**Table 12-1: M5300/M7300 Option Cable CA-012349-001 Interconnections**

44-PIN I/O CABLE CONNECTOR P1 PIN	SIGNAL NAME	TO/FROM	DESCRIPTION
19	SPKR1	P2 pin 1	Speaker Audio Outputs 1 and 2. This differential speaker output is not used in a remote-mount radio installation with a CH-721 control head. However, in a front-mount radio installation, and in a remote-mount radio installation with an HHC-731 hand-held controller, this output drives the radio installation's external speaker.
20			
21	SPKR2	P2 pin 2	
22			
10	OUT2	P3 pin 1	Digital Output 2 (open-collector, 100 mA / 17 V maximum). External pull-up resistor needed if required by the external device's input during the high/off state. Use P3 pin 2 or 4 for ground. For ECP, configure via the "External Output Control Line 2" in Radio Personality Manager's (RPM's) External I/O dialog box. For example, an external logging recorder's record enable/disable input can be controlled by setting "External Output Control Line 2" to "Extern. Tx Indicator." With this example configuration, OUT2 will remain in the high/off (inactive) state during a radio trunked control channel transmission.
7	GND	P3 pins 2 & 4	Chassis Ground. Over-current-protected by a fuse on radio's PK Board.
26	HKSW	P3 pin 3	Digital Input for Hookswitch (default) or for radio PTT. Active = Ground. Inactive = Open. For use as a PTT input with OpenSky (see footnote <sup>5</sup> ), send the following AT command to the radio: AT@PTT_INPUT2. Also see P4 pin 21.

<sup>5</sup> This OpenSky AT command applies only to M5300/M7300 "rear panel software" release R15A (and later), and to M5300/M7300 radio software release R15C (and later).

Table 12-1: M5300/M7300 Option Cable CA-012349-001 Interconnections

44-PIN I/O CABLE CONNECTOR P1 PIN	SIGNAL NAME	TO/FROM	DESCRIPTION
25	INP2	P3 pin 5	<p>Digital Input 2. Active = Ground. Inactive = Open. Use P3 pin 2 or 4 for ground.</p> <p>For ECP, configure via the "Auxiliary Input 2" in Radio Personality Manager's (RPM's) External I/O dialog Box.</p> <p>For OpenSky running OTP software R18C or earlier, send AT@PTT_INPUT2 to the radio to select this input for external PTT control.</p> <p>For OpenSky running OTP software R18D or later, send AT@AUXIO0,1,0,1,4 to the radio to set this input for non-emergency external PTT control. Using a "4" as the last digit of this command pairs this input as PTT control for the external mic input at P4 Pin 27. Send AT@AUXIO1,0 to disable this input. Additional addressable OpenSky functions are available, such as defining this input as an emergency function input. Refer to the OpenSky MES Command Manual MM-016649-001 or contact the Harris Technical Assistance Center.</p>
28	SWA+	P3 pin 6	Switched A+ (DC Power) Output.
8	GND	P4 pin 1	Chassis Ground. Over-current-protected by a fuse on radio's PK Board.
30	DGPS_DATA	P4 pin 4	GPS Receiver Module DGPS Correction Data Serial Data Input (NMEA-Formatted).
4	EXTRX	P4 pin 5	External Rx Audio Input (from external/2 <sup>nd</sup> receiver; summed).
9	EXTMOD	P4 pin 7	External Tx Audio Input (typically not used).
3	SDATA	P4 pin 8	In a front-mount M5300/M7300 radio installation, this pin for the siren/PA interface is the siren serial data output (open-collector/open-drain) from the radio's mounted (local) CH-721. It serially transfers siren and light control data from the CH-721 to a connected third-party siren and light system (e.g., Federal Signal SS2000 SmartSiren). Data rate = 1200 bps. Connects to SS2000's DB-9 pin 3. For a remote-mount radio installation, see footnote <sup>6</sup> .
5	FDISC	P4 pin 9	Buffered Filtered Discriminator Audio Output (typically not used). A fixed-level audio output with DC bias. Approximately 200 mV rms into a 600-ohm load at rated deviation. Does <u>not</u> contain signaling (e.g., CTCSS). Mutes when speaker mutes. Use a 33 μF / 50 V (or greater) AC-coupling capacitor to couple to a 600-ohm load. Use P4 pin 12 for ground.

<sup>6</sup> In a remote-mount M5300/M7300 mobile radio installation, this pin on the radio's DB-44 connector is typically not used. For the CH-721 control head, use the respective pin on the CH-721 Option Cable's female DB-25 pin connector; see Section 12.2 for additional information. For the HHC-731 hand-held controller, use the respective pin on the HHC-731 Interface Cable's female DB-25 connector; see Section 12.4 for additional information.

Table 12-1: M5300/M7300 Option Cable CA-012349-001 Interconnections

44-PIN I/O CABLE CONNECTOR P1 PIN	SIGNAL NAME	TO/FROM	DESCRIPTION
13	ALO	P4 pin 10	In a front-mount M5300/M7300 radio installation, this 600-ohm AC-coupled differential audio output from the mounted (local) CH-721 is typically not used. In a remote-mount M5300/M7300 radio installation, these two pins of the radio's DB-44 connector are not functional.
12	MICHI	P4 pin 11	
1	EXTALO	P4 pin 12	In a front-mount M5300/M7300 radio installation, VOLHI (a single-ended AC-coupled audio signal) and EXTALO (signal ground) provide public address (PA) mic audio from the mounted (local) CH-721 to a siren and light system, such as the Federal Signal SS2000 SmartSiren. Pin 13 connects to SS2000's DB-9 pin 5. Pin 12 connects to SS2000's DB-9 pin 6. For a remote-mount radio installation, these two pins can provide an unmuted volume-level-controlled single-ended audio signal to external devices. P1 pin 1 is over-current protected by a fuse on radio's PK Board.
14	VOLHI	P4 pin 13	
15	CTLON	P4 pin 14	Control-On Digital Input for data-only radio on/off power control. See Section 9.2.3 for additional information.
16	XTONEENC	P4 pin 15	External Tone Encode Audio Input (default) or Auxiliary Mic Audio Input. For use as an aux mic audio input with OpenSky (see footnote <sup>5</sup> ), send the following AT command to the radio: AT@MIC_REAR_INPUT2. Also see P4 pin 24.
17	XTONEDEC	P4 pin 16	External Tone Decode Audio Output.
6	EXTALO	P4 pin 17	Reference/Ground for external audio. Over-current protected by a fuse on radio's PK Board.
24	HORNRING	P4 pin 18	In a front-mount M5300/M7300 radio installation, this pin for the siren/PA interface is the horn/ring logic input to the radio's mounted (local) CH-721. When a connected third-party siren and light system (e.g., Federal Signal SmartSiren SS2000) has its horn/ring function active, this input is used to signal the head/radio as such. Connects to SS2000's DB-9 pin 8. For a remote-mount radio installation, see footnote <sup>6</sup> .
23	SONOFF	P4 pin 19	In a front-mount M5300/M7300 radio installation, this pin for the siren/PA interface is the siren on/off logic output (open-collector) from the radio's mounted (local) CH-721. It is the signal that powers the connected third-party siren and light system (e.g., Federal Signal SmartSiren SS2000) on and off. Connects to SS2000's DB-9 pin 4. For a remote-mount radio installation, see footnote <sup>6</sup> .

**Table 12-1: M5300/M7300 Option Cable CA-012349-001 Interconnections**

44-PIN I/O CABLE CONNECTOR P1 PIN	SIGNAL NAME	TO/FROM	DESCRIPTION
18	INP1	P4 pin 21	<p>Digital Input 1. Active = Ground. Inactive = Open. Use P4 pin 1 for ground (software definable with OTP R18D).</p> <p>For ECP, configure via the "Auxiliary Input 1" in Radio Personality Manager's (RPM's) External I/O dialog Box.</p> <p>For OpenSky running OTP software R18C or earlier, send AT@PTT_INPUT1 to the radio to select only this input for auxiliary PTT control.</p> <p>For OpenSky running OTP software R18D or later, send AT@AUXIO0,1,0,1,4 to the radio to set this input for non-emergency auxiliary PTT control. Using a "4" as the last digit of this command pairs this input as PTT control for the external mic input at P4 Pin 27. Send AT@AUXIO0,0 to disable this input. Additional addressable functions are available such as defining this input as an emergency function. Refer to the OpenSky MES Command Manual MM-016649-001 or contact the Harris Technical Assistance Center.</p>
2	OUT1	P4 pin 22	<p>Digital Output 1 (open-collector, 100 mA / 17 V maximum). External pull-up resistor needed if required by the external device's input during the high/off state. Use P4 pin 1 for ground.</p> <p>For ECP, configure via the "External Output Control Line 1" in Radio Personality Manager's (RPM's) External I/O dialog Box.</p>
29	TXENB+	P4 pin 23	<p>Transmit Enable B+ Output (open-collector, 100 mA / 17 V maximum). Radio transmitting = low/on. Radio not transmitting = high/off. External pull-up resistor needed if required by the external device's input during the high/off state. Use P4 pin 1 for ground. Typically, this output is not used.</p>
27	EXTMIC	P4 pin 24	<p>External/Auxiliary Mic Audio Input. Fixed-level audio input (i.e., input gain is not adjustable). Approximately 120 mV rms gives full-rated deviation. Use P4 pin 17 for ground.</p> <p>For OpenSky running OTP software R15C through R18C, to use as an aux mic audio input, send the following AT command to the radio: AT@MIC_REAR_INPUT1.</p> <p>For OpenSky running OTP software R18D or later, refer to the notes for P4, Pins 25 or 18. Refer to the OpenSky MES Command Manual MM-016649-001 or contact the Harris Technical Assistance Center.</p>
28	SWA+	P4 pin 25	Switched A+ DC Power Output. Typically, this output is not used.
32	GPS_NMEA_RX	P5 pin 2	NMEA-Formatted GPS Receiver Position Data Serial Data Output.
31	GPS_NMEA_TX	P5 pin 3	NMEA-Formatted GPS Receiver Module Initialization Data Serial Data Input.
7	GND	P5 pin 5	Ground for GPS Serial Data Signals. Over-current-protected by a fuse on radio's PK Board.
11	IGNITION	Yellow Wire	Unused/Spare ignition sense input.

Table 12-1: M5300/M7300 Option Cable CA-012349-001 Interconnections

44-PIN I/O CABLE CONNECTOR P1 PIN	SIGNAL NAME	TO/FROM	DESCRIPTION
33 — 44	—	(no connections)	These twelve pins of P1 (i.e., the 44-pin connector on the rear of the radio) are not used/not connected when M5300/M7300 Option Cable CA-012349-001 is connected to P1.



## 12.2 CH-721 OPTION CABLE CA-011854-001

CH-721 Option Cable CA-011854-001 can be used to connect optional equipment to the 25-pin D-subminiature (DB-25) connector on the rear of the CH-721. This cable expands the connections available at the 25-pin connector to three (3) separate connectors. The cable's assembly and wiring diagrams are shown in Figure 12-2 below.

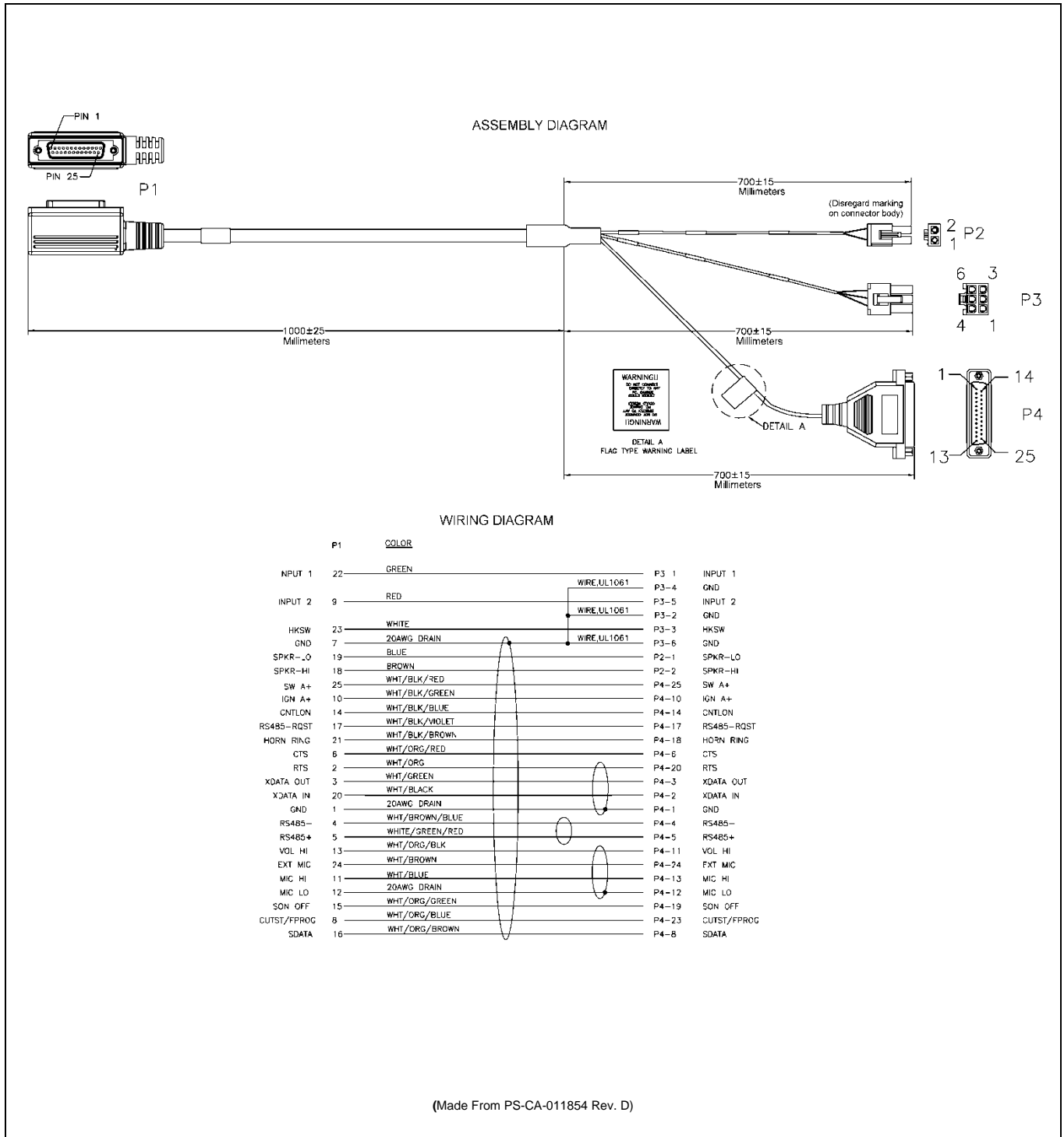

Figure 12-2: CH-721 Option Cable CA-011854-001

### 12.3 ACCESSORY CABLE 19B802554P24

When a remote-mount radio installation employs the HHC-731 hand-held controller, Accessory Cable 19B802554P24 is required to make connections to an external siren and light control system. This cable's male DB-25 connector, identified P1, mates to the female DB-25 connector of the HHC-731 Interface Cable. The cable's assembly diagram is illustrated in Figure 12-3 below.

Connector J1 mates with a cable provided with the siren and light control system. The respective connection procedure is presented in Section 9.4.6 of this manual.

Connector P2 is not used in this application of the cable.

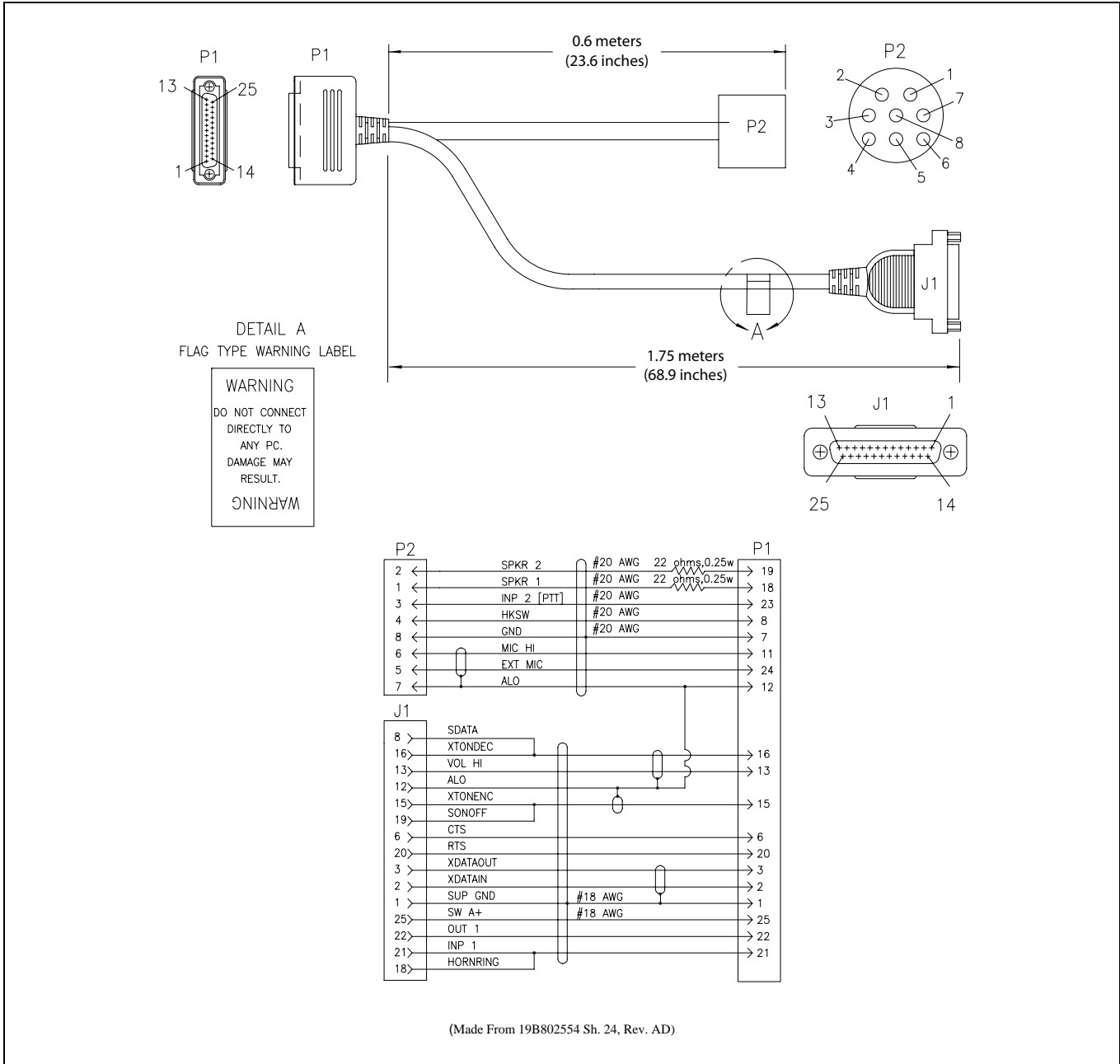

Figure 12-3: Accessory Cable 19B802554P24

## 12.4 HHC-731 INTERFACE CABLE CA-018399-001

HHC-731 Interface Cable CA-018399-001 interconnects a DC power cable and the CAN cable from the radio to the HHC-731 hand-held controller. It also has a 25-pin connector that can be used to connect optional equipment to the HHC-731. The cable's assembly and wiring diagrams are shown in Figure 12-4 below. Connector J1 mates with the DC power cable from the main and switched fused power sources. Connector J3 mates with the CAN cable from the radio. Connector P2 (male DB-25) mates to the coiled cord of the CH-721 hand-held controller. Connector P3 (female DB-25) is the connector for optional connections, such as an external siren and light system (e.g., Federal Signal SS2000 SmartSiren®). Refer to Section 9.4 in this manual for installation instructions.

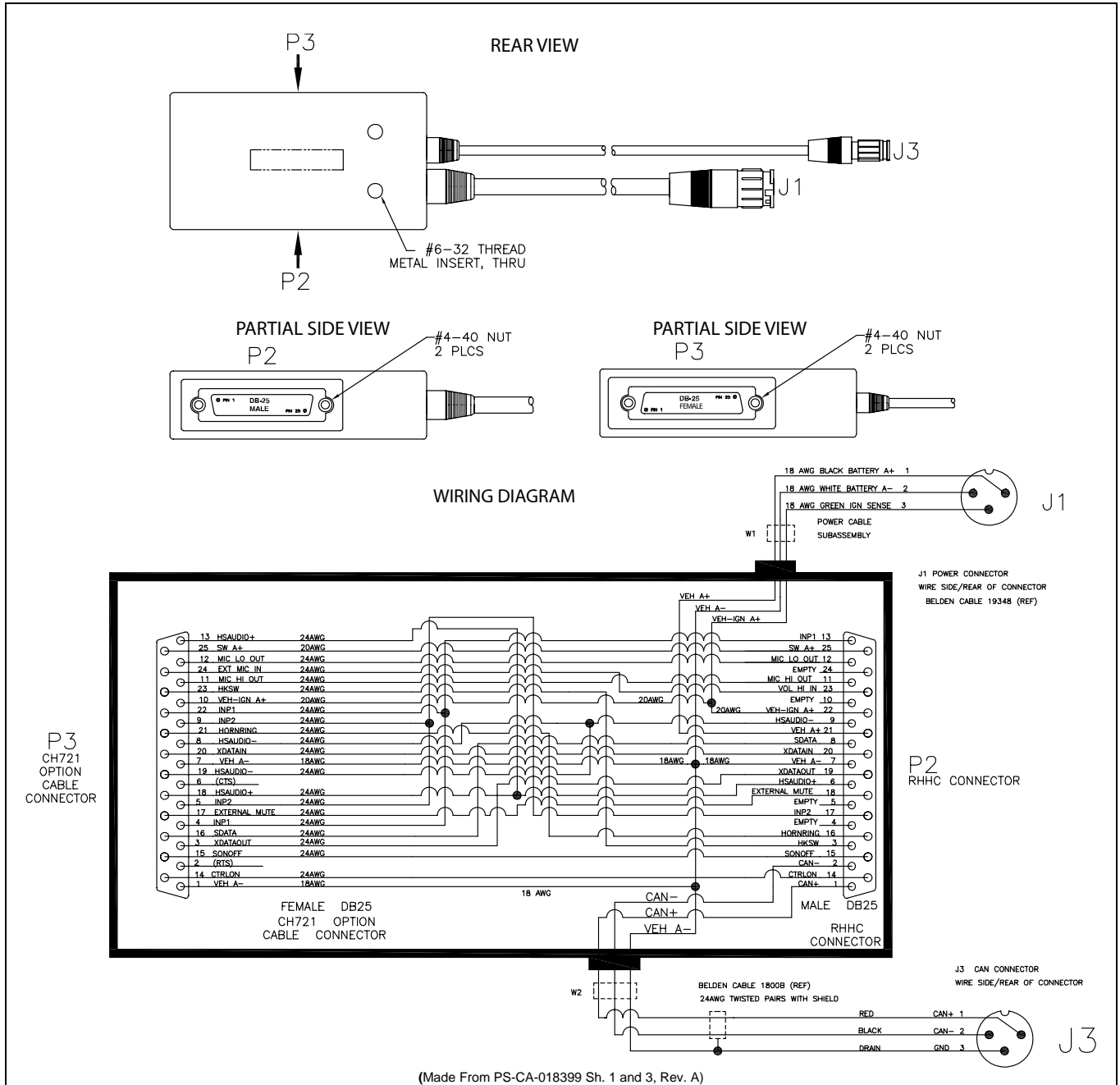

Figure 12-4: HHC-731 Interface Cable CA-018399-001

## 12.5 SERIAL DATA CABLE CA-013671-020

Serial Data Cable CA-013671-020 (20 feet long) can be used make data connections to the radio to support data communications equipment such as an MDT or a GPS NMEA-format device. It can also be used to program and configure the M7300 mobile radio via a Personal Computer (PC). The cable's assembly and wiring diagrams are shown in Figure 12-5 below.

The cable's male DB-9 connector (J1) mates to the female DB-9 serial port connector on the rear of the radio. Alternately, if the cable is being used to carry GPS NMEA-formatted serial data from the radio, this male DB-9 connector mates to connector P5 of M5300/M7300 Option Cable CA-012349-001.

The cable's female DB-9 connector (J2) mates to a PC's male DB-9 serial port connector. If the utilized PC is not equipped with a DB-9 serial port connector, the use of a suitable adapter is required, such as USB-to-RS-232 Adapter Cable CN24741-0001. As of the publication of this manual, CN24741-0001 is available via the Customer Care center; refer to Section 4.4 on page 32 for contact information.

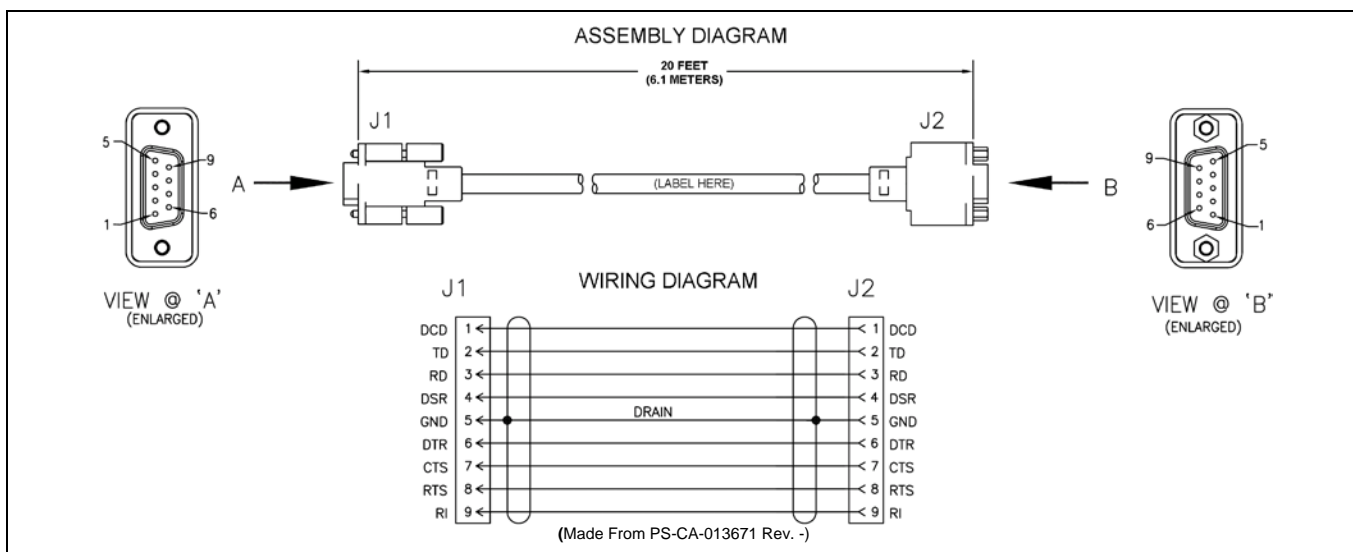

Figure 12-5: Serial Data Cable CA-013671-020

## 12.6 CH-721 SERIAL PROGRAMMING CABLE CA-104861

Serial Programming Cable CA-104861 (5 feet long) can be used to program and configure the CH-721 control head via a Personal Computer. It has a female DB-9 connector on one end for connection to the PC's serial port connector and a male DB-9 connector on the other end for connection to the serial port connector on the rear of the head. Refer to the respective Software Release Notes for programming and configuration information.

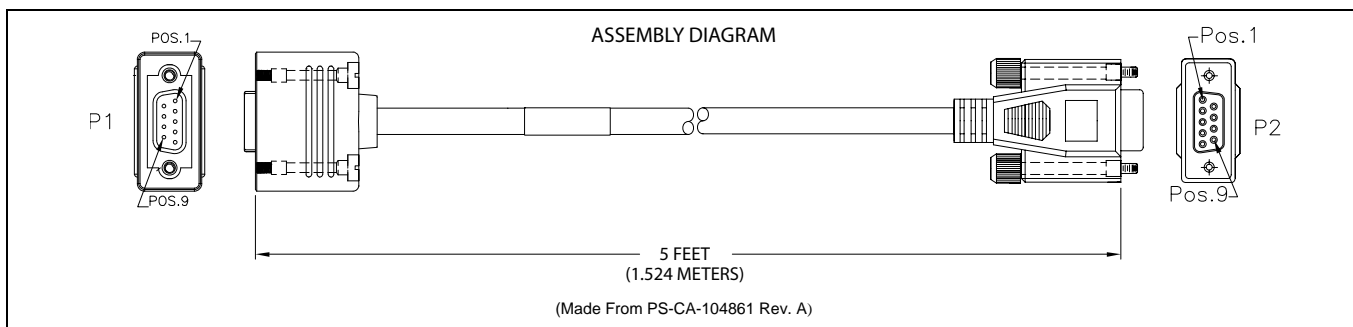

Figure 12-6: CH-721 Serial Programming Cable CA-104861

## 12.7 CH-721 MIC CONNECTOR PROGRAMMING CABLE CA-103541-001

CH-721 Mic Connector Programming Cable CA-103541-001 (4 feet long) can be used to program and configure the CH-721 control head via its front-panel microphone connector. It has a female DB-9 connector on one end for connection to a PC's serial port connector and a 17-pin Conxall-style connector on the other end for connection to the head's mic connector. Refer to the respective Software Release Notes for programming and configuration information.

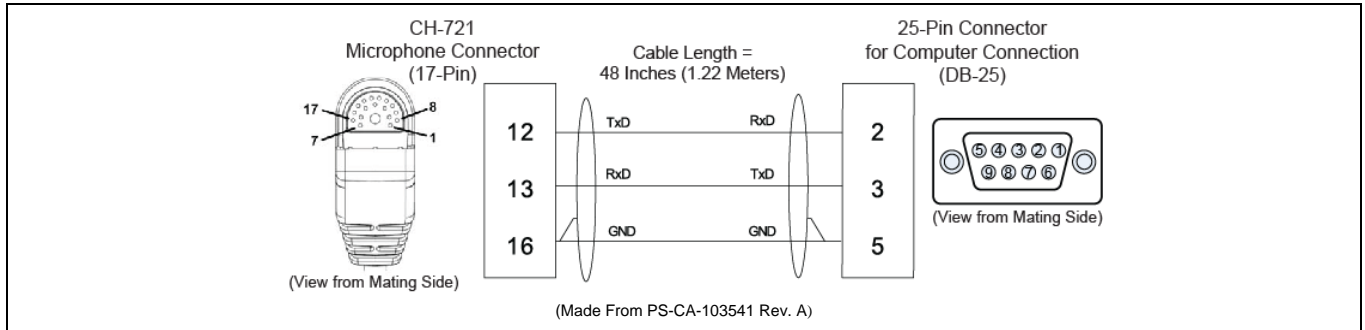

Figure 12-7: CH-721 Serial Programming Cable CA-103541-001

## 12.8 SPEAKER-ONLY OPTION CABLE CA-012349-007

Speaker-Only Option Cable CA-012349-007 is typically only used to make speaker connections to the radio when the HHC-731 hand-held controller is employed. Optional connections **cannot** be made to the 44-pin (DB-44) connector on the rear of the radio when this cable is used. This 20-foot cable connects the radio's high-power speaker audio output to the 2-wire leads of the speaker. Refer to Section 10.2.2 on page 97 for the respective installation instructions. This cable can also be used for the same purpose in front-mount M7300 mobile radio installation, if no optional connections must be made to the radio's 44-pin (DB-44) connector. Connector P1 mates to the 44-pin connector on the rear of the radio. Connector P2 mates to the speaker's 2-pin connector.

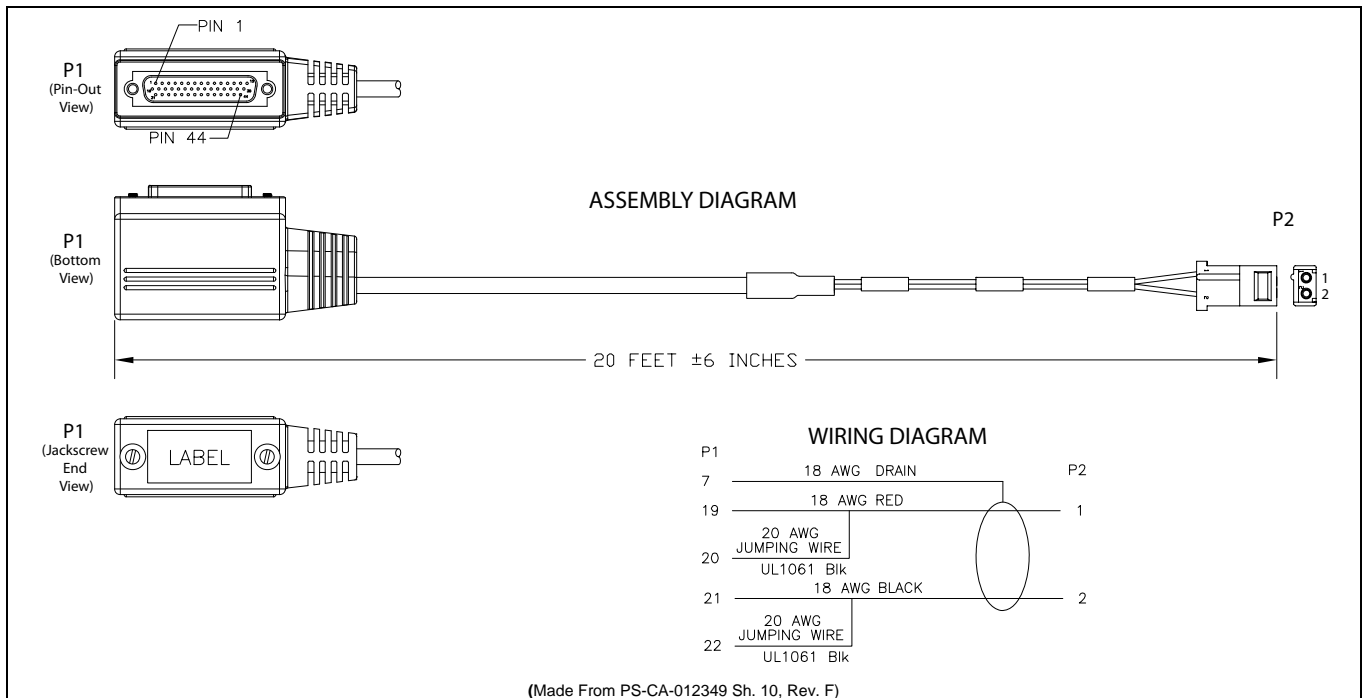

Figure 12-8: Speaker-Only Option Cable CA-012349-007

## 13 GPS NMEA-FORMATTED DATA CONNECTION

To obtain GPS NMEA-formatted serial data from the radio, M5300/M7300 Option Cable CA-012349-001 is required. In addition, the radio must be equipped with the GPS receiver option. Follow this procedure to complete the GPS NMEA-formatted serial data connections:

1. Obtain M5300/M7300 Option Cable CA-012349-001. Each “leg” of this cable is approximately 65 inches long (166 centimeters).
2. Connect the cable’s 44-pin D-subminiature (DB-44) male connector to the DB-44 female connector on the rear panel of the radio. Tighten the two jackscrews with a small flathead screwdriver. Do not over-tighten.
3. Connect the cable’s DB-9 female connector to the computer’s serial port DB-9 male connector—either directly or extended via cable CA-013671-020 (a 20-foot-long cable); see Section 12.5. Tighten the screws firmly, and then route the cabling as required. If the computer is not equipped with a DB-9 serial port connector, the use of a suitable adapter is required, such as USB-to-RS-232 Adapter Cable CN24741-0001.
4. Follow the manufacturer’s instructions on processing the NMEA-formatted GPS data from the radio.



NOTE

If the M5300/M7300 Option Cable is not available, a 3-wire serial cable can be field-fabricated. On the radio end, this cable must interface to the three GPS-related signals of the radio’s 44-pin I/O Cable connector (pins 7, 31, and 32). See Table 12-1 for additional information.

Industry software to process GPS information through this interface is not supported by Harris.

## 14 MOBILE DATA CONNECTION

If the radio installation must support mobile data communications of a computer running Mobile Data Terminal (MDT) or similar software, follow this procedure to connect the computer to the radio:

1. Obtain cable CA-013671-020 (or equivalent). This is a 20-foot-long standard serial data cable.
2. Connect this cable’s male DB-9 connector to the female DB-9 connector on the rear of the radio. Tighten the two (2) jackscrews securely.
3. Route the cable through the vehicle’s interior wire/cable channeling to the computer. Remove interior panels, door kick panels, etc., as necessary. Protect the cable from possible chafing and tie-and-stow it as necessary.
4. Connect the cable’s female DB-9 connector to the computer. If the computer is not equipped with a DB-9 serial port connector, use a suitable adapter, such as USB-to-RS-232 Adapter Cable CN24741-0001.



NOTE

As of the publication of this manual, mobile data should not be obtained from the CH-721 control head.



NOTE

Before data communications can occur on an EDACS or P25 system, the respective data option must be enabled. Contact the Technical Assistance Center (TAC) for additional information. TAC contact information is included on page 32.

## 15 INITIAL POWER-UP TEST

1. At the radio's main waterproof (HFB-type) fuse holder installed near the vehicle battery, insert the fuse that was included with the radio's DC Power Cable.

**NOTE**

The 35 and 50-Watt radios require a 15-amp AGC-type fuse.

The 110-Watt VHF radio requires a 25-amp fuse.

2. Tie and stow all fuse holders at this location to prevent excess vibration/movement.
3. Carefully reconnect the vehicle's battery ground cable.
4. If not already, temporarily connect the mobile antenna cable from the vehicle-mounted mobile antenna to the female TNC RF connector on the rear panel of the radio. This is a temporary connection until test procedures in Section 16 are complete.
5. If the radio is equipped with the GPS receiver option, permanently connect the antenna cable from the GPS antenna (or mobile/GPS combo antenna) to the female SMA connector on the rear panel of the radio. The male SMA connector on most GPS antenna cables has a 5/16-inch hex collar, so the use of a wrench of this same size is normally required for tightening. However, some may have collars with only knurled surfaces, so a standard wrench or torque wrench cannot be used. In either case, do not over tighten the connector and do not twist the cable when tightening.
6. If the installation is wired so the vehicle's ignition key/switch turns the radio on and off, turn the switch to the Accessory or Run position.
7. If the control head is not already powered up, do so by rotating its on/off/volume control clockwise out of the detent position. For the HHC-731, press the on/off power button located just above the display.
8. Verify the control head/hand-held controller has powered-up by observing its display. If the display is not functioning, refer to Section 9.2.1 as necessary.

**NOTE**

Unlike many mobile radio products, the radio powers-up to the **state of last control**.

As long as the software configuration parameters have been loaded, successful installation is almost immediately realized:

- After a short boot-up sequence, the control head/hand-held controller displays login information and/or a talk group.
- If no errors are displayed, the installation is most-likely properly wired.
- If an error is displayed, recheck all cable connections, verify all fuses are properly installed, and verify battery power on the load side of the fuses, etc. If problems persist, contact the Technical Assistance Center (see page 32).
- Consult the Operator's Manual for operational information.

Refer to Section 16 for performance test information.

## 16 PERFORMANCE TESTS

This section includes procedures to verify the performance of the installation's mobile antenna system. There are three (3) procedures in this section:

- Changing Operating Mode for Tests
- Testing by Transmitting into a Dummy Load (a 50-Ohm RF Terminator)
- Testing by Transmitting into the Mobile Antenna



CAUTION

The accuracy of test results depends upon a DC power source in the range of 13.6 volts DC  $\pm 10\%$ . The current capacity of the power source must be greater than 15 amps for a 35 or 50-Watt radio, or greater than 25 amps for a 110-Watt radio. Make sure the vehicle's battery is fully charged by running the engine for a few minutes before the test, and keep the engine running during the test procedures. **Abide by the following WARNING!**



WARNING

**If the vehicle's engine must remain running, the vehicle location should be well ventilated so exhaust fumes from the engine do not cause harm!**



CAUTION

If a vehicle equipped with this radio requires jump-starting, the radio installation's main fuse should be removed from the holder prior to jump-starting. Doing so will prevent damage to the radio system.



NOTE

Prior to installation, the radio's power level should be configured appropriately. The wide range of power levels indicated in the following procedures takes into account such things as: customer's requirements; measurement errors, especially to include uncalibrated equipment; cabling losses; and voltage and temperature variations. By no means should the result from Performance Testing in this section be construed as the exact value of power level output from the radio, as the value is set and more accurately measured in the factory. The values obtained in these test procedures determine a successful installation only.

### 16.1 CHANGING OPERATING MODE FOR TESTS

To complete tests in this section, placing the radio in a conventional mode and using an average-responding wattmeter to measure RF transmit power is recommended. However, if the radio is not programmed for conventional mode operations (i.e., OpenSky Trunking Protocol (OTP) mode is available but EDACS/Conventional/P25 (ECP) modes are not), tests will require a peak-reading RF wattmeter to measure RF transmit power. To select either conventional or OpenSky mode, use one of the following procedures:

#### 16.1.1 Changing from OpenSky to Conventional

This procedure assumes the control head/hand-held controller is configured with default keypad mapping.

1. Apply power to the radio and turn it on via the **On/Off/Volume Control** on the CH-721 control head. See Figure 9-5.



For the CH-731 hand-held controller, use the **On/Off Power Button** located just above its display. See Figure 9-12.

2. For the control head, use the **•/•• Ramp Control** to scroll through the menu until **Mode Menu** appears in the display.

For the hand-held controller, use the **Ramp Up Button** or **Ramp Down Button** located on the top of the controller to scroll through the menu until **Mode Menu** appears in the display.

3. For the control head, select an available conventional channel/system via the **+/- Ramp Control**.  
For the hand-held controller, use the **6 (ADD)** or **9 (DEL)** keys on the keypad to select an available conventional channel/system.
4. For the control head, confirm the selection by pressing the **MENU** button, then toggling the **Ramp Control** once (to select **Y** for Yes), followed by pressing the **MENU** button again. The radio will enter the selected mode as indicated by the display.

For the hand-held controller, confirm the selection by pressing the **Menu Button (M)**, then the **Ramp Up Button** or **Ramp Down Button**, and then the **Menu Button (M)** again.

5. For the control head, select a conventional channel for test transmissions using the **System/Group/Channel Selection Control**.

For the hand-held controller, select a conventional channel for test transmissions using the **▲** (up arrow) button or the **▼** (down arrow) button located just below the display.

### **16.1.2 Changing from Conventional to OpenSky**

This procedure assumes the control head/hand-held controller is configured with default keypad mapping.

1. Apply power to the radio and turn it on via the **On/Off/Volume Control** on the CH-721 control head; see Figure 9-5. For the CH-731 hand-held controller, use the **On/Off Power Button** just above its display; see Figure 9-12.

2. For the control head, use the **•/•• Ramp Control** to scroll through the menu until the required OpenSky system's name is displayed.

For the hand-held controller, use the **Ramp Up Button** or **Ramp Down Button** located on the top of the controller to scroll through the menu until the required OpenSky system's name is displayed.

3. After a few seconds, the radio will automatically transition to OTP mode for operations on the selected OpenSky system.
4. If the radio is not programmed for auto-login, login to the OpenSky system. For login instructions, refer to the respective operator's manual or quick guide as necessary. The quick guide is included with the radio when it ships from the factory.

5. For the control head, select a talk group for test transmissions using either the **•/•• Ramp Control** or the **System/Group/Channel Selection Control** (required control per programming).

For a hand-held controller, select a talk group for test transmissions using the **▲** (up arrow) button or the **▼** (down arrow) button located just below the display.

## 16.2 REQUIRED TEST EQUIPMENT

Table 16-1: Required Test Equipment

TEST EQUIPMENT	MODEL / PART NUMBER & DESCRIPTION
Average-Responding Wattmeter (for conv. measurements)	Bird Electronic Corp. Model 43 (or equivalent) with Type N female connectors at input and output ports.
<b>or</b>	
Peak-Reading Wattmeter (for OpenSky measurements)	Bird Electronic Corp. Model 4314B (or equivalent) with Type N female connectors at input and output ports.
<b>or</b>	
Digital Wattmeter	Bird Electronics Corp Model 5000-EX with Wideband Power Sensor 5012, 350 MHz to 4000 MHz Range (no wattmeter element required).
Wattmeter Element (Typically Not Required if Using a Digital Wattmeter)	<p><u>For 50-Watt VHF Radio:</u> Bird Electronic Corp. Element 50C or 100C (50 or 100-Watt max. respectively), 100 - 250 MHz frequency range (or equivalent).</p> <p><u>For 110-Watt VHF Radio:</u> Bird Electronic Corp. Element 250C (250-Watt max.), 100 - 250 MHz frequency range (or equivalent).</p> <p><u>For UHF or 700 &amp; 800 MHz Radio:</u> Bird Electronic Corp. Element 50E (50-Watt max.), 400 - 1000 MHz frequency range (or equivalent).</p>
RF Coaxial Jumper Cable	Pasternack Enterprises PE3661-36 (or equivalent) 50-Ohm Coaxial Cable with TNC male connector and Type N male connector, approximately three (3) feet in length. The utilized cable <b>must</b> have VSWR below 1.5:1 within the RF passband.
RF Coaxial Jumper Cable (Only Required for 110-Watt VHF Radio)	Pasternack Enterprises PE3714-36 (or equivalent) 50-Ohm RF Coaxial Cable with Type N female connector and Type N male connector, approximately three (3) feet in length. The utilized cable should have VSWR below 1.5:1 within the RF passband.
RF Attenuator, 20 dB, 150-Watt (Only Required for 110-Watt VHF Radio)	Bird Tenuline® Series Part Number 150-SA-MFN-20.
N-to-TNC RF Adapter	Pasternack Enterprises PE9090 (or equivalent) Type N male to TNC female adapter. Required to connect the cable of the vehicle-mounted antenna to the wattmeter.
50-Ohm RF Terminator ("Dummy Load")	Pasternack Enterprises PE6167 (or equivalent) 50-ohm RF terminator rated at 50 watts or greater, with Type N male connector.
Vehicle-Mounted Antenna	Tests are performed with the vehicle-mounted antenna per the installation described in Section 7 of this manual.

## 16.3 TRANSMITTING INTO A DUMMY LOAD

- Using the Type N male to TNC male RF coaxial jumper cable, connect the radio's antenna connector to the wattmeter's input connector. Refer to Figure 16-1 as necessary.
- Connect the 50-ohm dummy load to the wattmeter's output connector, in place of the antenna cable from the vehicle-mounted antenna.



As previously stated, if conventional mode is not available per radio programming (i.e., OTP mode is available but ECP mode is not), a peak-reading RF wattmeter is required to measure RF transmit power. Otherwise, the use of an average-responding wattmeter is recommended. See Table 16-1.

3. If not already, turn the radio on and set it to the required operating mode (based upon available radio programming and test equipment). Refer to Section 16.1 as necessary.
4. Set the radio to a test talk group or conventional channel, if available.



It is recommended that a test talk group/channel be allocated for this testing. This same group should be used during the antenna test procedure which is presented in the subsequent section.

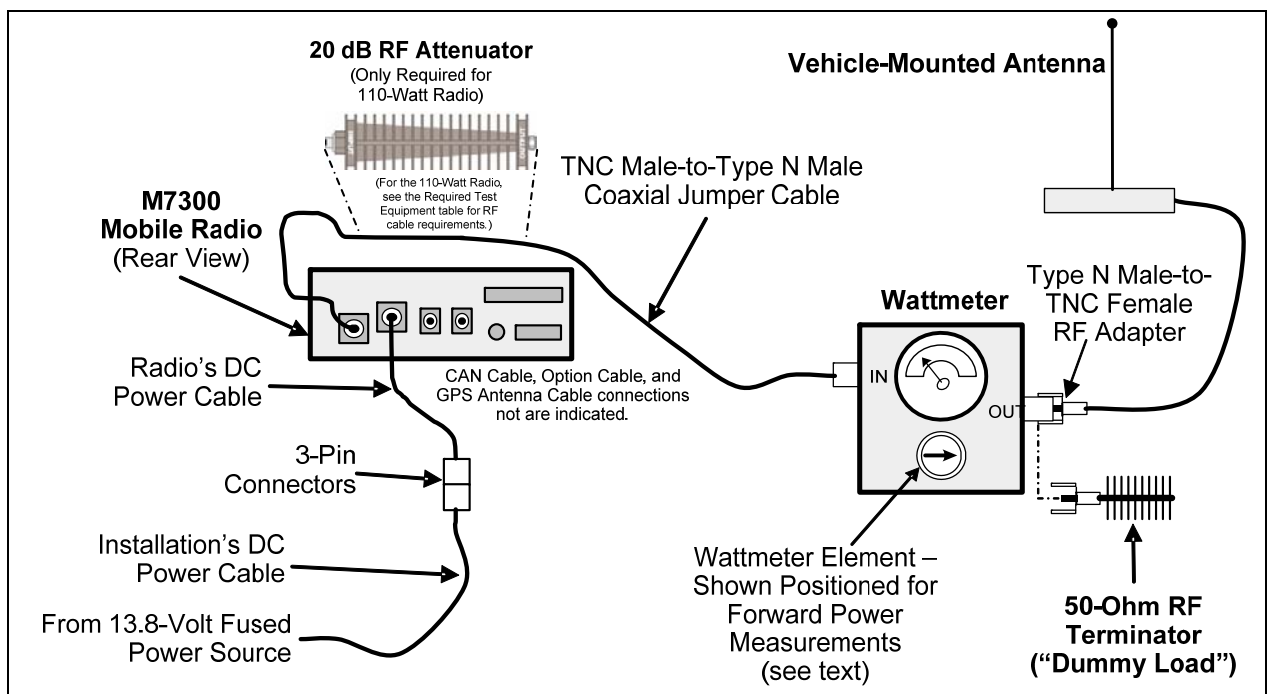

**Figure 16-1: Wattmeter Connections for Antenna System Tests**

5. Position the wattmeter's element to measure forward RF output power. Rotate it if necessary. The arrow on the face of the element must point away from the radio and towards the dummy load for forward power measurements.
6. **For conventional mode transmissions**, set the wattmeter to measure average RF power.  
**For OpenSky mode transmissions**, set the wattmeter to measure peak RF power.
7. Key the radio's transmitter via the microphone's PTT button.
8. For a VHF or a UHF band transmission with a 50-watt radio, compare the wattmeter's reading with the target RF output power range of between **39.8 and 63 watts** (50 watts  $\pm$ 1 dB). This transmit output power range assumes the radio is currently configured at the maximum transmit power level.

For a VHF band transmission with a 110-watt radio, compare the wattmeter's reading with the target RF output power range of between **87.1 and 138.0 watts** (110 watts  $\pm$ 1 dB). This transmit output power range assumes the radio is currently configured at the maximum transmit power level.

For a 700 MHz band transmission, compare the wattmeter's reading with the target RF output power range of between **23.8 and 37.7 watts** (30 watts  $\pm 1$  dB). This transmit output power range assumes the radio is currently configured at the maximum transmit power level.

For an 800 MHz band OpenSky transmission, compare the wattmeter's reading with the target RF output power range of between **23.8 and 37.7 watts** (30 watts  $\pm 1$  dB). This transmit output power range assumes the radio is currently configured at the maximum transmit power level.

For an 800 MHz band EDACS/ProVoice, analog conventional, or P25 transmission, compare the wattmeter's reading with the target RF output power range of between **27.8 and 44.1 watts** (35 watts  $\pm 1$  dB). This transmit output power range assumes the radio is currently configured at the maximum transmit power level.



NOTE

Transmit only for as long as needed to take the measurement, then immediately disable the transmission.

9. **If the wattmeter reading is within the range**, record the measured value in the appropriate space on the data collection form near the end of this manual.

**If the wattmeter reading is outside the range**, verify the radio's power supply voltage (i.e., battery voltage) is within the specified range, recheck all connections, and measure the RF output power again. If this fails to produce a reading within the range, replace it and repeat this procedure. If problems persist, contact the Technical Assistance Center (see page 32).

## 16.4 TRANSMITTING INTO THE MOBILE ANTENNA

1. Connect the antenna cable from the vehicle-mounted antenna to the wattmeter as shown in Figure 16-1.
2. If not already, turn the radio on and set it to the required operating mode (based upon available radio programming and test equipment). Refer to Section 16.1 as necessary.
3. Set the radio to a test talk group or conventional channel, if available.



NOTE

It is recommended that a test talk group/channel be allocated for this testing. Otherwise, interference with other radio users in the system may occur. **Also, during transmissions, always observe the RF exposure-related safety information presented in Section 1.2 (begins on page 7).**

4. Position the wattmeter's element to measure forward RF output power. Rotate it if necessary. The arrow on the face of the element must point away from the radio and towards the antenna for forward power measurements.
5. **For conventional mode transmissions**, set the wattmeter to measure average RF power.  
**For OpenSky mode transmissions**, set the wattmeter to measure peak RF power.
6. Key the radio's transmitter via the microphone's PTT button.
7. For a VHF or a UHF band transmission with a 50-watt radio, compare the wattmeter's reading with the target RF output power range of between **39.8 and 63 watts** (50 watts  $\pm 1$  dB). This transmit output power range assumes the radio is currently configured at the maximum transmit power level.

For a VHF band transmission with a 110-watt radio, compare the wattmeter's reading with the target RF output power range of between **87.1 and 138.0 watts** (110 watts  $\pm 1$  dB). This transmit output power range assumes the radio is currently configured at the maximum transmit power level.

For a 700 MHz band transmission, compare the wattmeter's reading with the target RF output power range of between **23.8 and 37.7 watts** (30 watts  $\pm$ 1 dB). This transmit output power range assumes the radio is currently configured at the maximum transmit power level.

For an 800 MHz band OpenSky transmission, compare the wattmeter's reading with the target RF output power range of between **23.8 and 37.7 watts** (30 watts  $\pm$ 1 dB). This transmit output power range assumes the radio is currently configured at the maximum transmit power level.

For an 800 MHz band EDACS/ProVoice, analog conventional, or P25 transmission, compare the wattmeter's reading with the target RF output power range of between **27.8 and 44.1 watts** (35 watts  $\pm$ 1 dB). This transmit output power range assumes the radio is currently configured at the maximum transmit power level.



Transmit only for as long as needed to take the measurement, then immediately disable the transmission.

8. **If the wattmeter reading is within the range**, record the value in the appropriate space on the data collection form near the end of this manual.

**If the wattmeter reading is outside the range**, verify the radio's power supply voltage (i.e., battery voltage) is within the specified range, recheck all connections, and measure the forward power again. If the installation employs a 1/4-wave unity-gain antenna, observe the following NOTE. If these checks/corrections fail to produce a reading within the range, check all cabling and connections and repeat the testing procedure to this point. In the event the wattmeter reading still falls outside the range, replace the antenna, make sure all connections are seated firmly, and repeat the testing procedure. If problems persist, contact the Technical Assistance Center (see page 32).



If the mobile radio installation employs a 1/4-wave unity-gain antenna (part number AN102800V1 or AN102800V2 or AN-225006-001), the driven element (i.e., whip) of the antenna must be trimmed to the proper length in order to minimize antenna system VSWR. Refer to the instructions included with the antenna for trimming instructions.

9. Position the wattmeter's element to measure reverse (reflected) RF power from the antenna. The arrow on the face of the element must point away from the antenna and to the radio to measure reverse power.
10. Key the radio's transmitter via the microphone's PTT button.
11. Compare the wattmeter reading with the RF power output range of **2 watts or less**.



Transmit only for as long as needed to take the measurement, then immediately disable the transmission.

12. **If the wattmeter reading is within the range**, record the value in the appropriate space on the data collection form near the end of this manual.

**If the wattmeter reading is outside the range**, make sure the antenna is consistent with the specified frequency range of the radio. Recheck all antenna connections, and measure the reverse power again. If the installation employs a ¼-wave unity-gain antenna, observe the **NOTE** that immediately follows step 8. If these checks/corrections fail to produce a reading within the range, replace the antenna and repeat the entire antenna test procedure. Any value exceeding the maximum allowable reflected power value will result in a diminished RF output signal. If problems persist, contact the Technical Assistance Center (see page 32).

13. Disconnect the coaxial cable jumper and wattmeter.
14. Permanently connect the cable from the vehicle-mounted antenna to the radio's antenna cable by mating the two TNC connectors together. Use two pairs of soft-jaw pliers to gently tighten this connection. Do not over tighten and do not twist either cable.
15. Make several test calls on the radio system to verify operation of the mobile radio. Before making the calls, select other talk groups or conventional channels, as required to verify operation.



NOTE

To prevent RF leakage and ensure peak performance, make sure the RF connectors are tight, but do not over-tighten so connector damage will not occur.



WARNING

**Improper installation of the RF cables may lead not only to poor radio performance but also to harmful exposure to RF electromagnetic energy.**

Testing is complete. The radio is now ready for normal communications.

**16.5 TEST PERFORMANCE DATA FORM**

Clip  Here

Enter the information requested on this data collection form. Clip this form and file it as a permanent record of the tested performance of the M7300 mobile radio installation.

*Mobile Radio Serial Number*

*Antenna Make and Model Numbers*

*Date of Test  
(mm/dd/yyyy)*

*Company Performing Installation*

*Technician Performing Test*



Watts
<i>Power into a Dummy Load</i>

Watts
<i>Forward Power with Antenna</i>

Watts
<i>Reflected Power with Antenna</i>

## 17 COMPLETE THE INSTALLATION

Double-check the following items before considering the installation completed:

- Verify all newly installed mechanical hardware is mounted securely and all respective mounting hardware is tight.
- Verify all electrical interconnections are connected properly and the associated connector attachment hardware is tight. Pay special attention to all RF antenna cables!
- Verify all related fuses are correctly installed and properly rated.
- Verify all electrical cables and wiring are tied, stowed, and protected so they are out of the way of casual contact, away from sources of extreme heat, and wire chafing cannot occur. Pay special attention to all RF antenna cables!
- To prevent fumes from entering the vehicle's passenger compartment, seal the hole/grommet/wire combination at the firewall with a silicon-based sealer.
- Verify all vehicle components are properly reinstalled such as kick panels, headliners, and seats.
- If the installation includes a separately-mounted on/off power switch for manually turning the radio (and possibly other systems) on and off, verify it is labelled accordingly. For example: **"Radio ON/OFF."**
- Remove all tools and unused hardware from the vehicle.
- Verify the test performance data has been recorded on the data collection form shown in this manual.

## 18 WARRANTY REGISTRATION

Please register this product within ten (10) days of purchase. Registration validates the warranty coverage, and enables Harris to contact you in case of any safety notifications issued for this product.

Registration can be made on-line at <http://www.pspc.harris.com/Service/WarrantySupport.asp>.



## 19 WARRANTY

- A. Harris Corporation, a Delaware Corporation, through its RF Communications Division (hereinafter "Seller") warrants to the original purchaser for use (hereinafter "Buyer") that Equipment manufactured by or for the Seller shall be free from defects in material and workmanship, and shall conform to its published specifications. With respect to all non-Seller Equipment, Seller gives no warranty, and only the warranty, if any, given by the manufacturer shall apply. Rechargeable batteries are excluded from this warranty but are warranted under a separate Rechargeable Battery Warranty (ECR-7048).
- B. Seller's obligations set forth in Paragraph C below shall apply only to failures to meet the above warranties occurring within the following periods of time from date of sale to the Buyer and are conditioned on Buyer's giving written notice to Seller within thirty (30) days of such occurrence:
1. for fuses and non-rechargeable batteries, operable on arrival only.
  2. for parts and accessories (except as noted in B.1 and B.5), ninety (90) days.
  3. for XG-25P, XG-75, P7300, P7200, P7100<sup>IP</sup>, P5500, P5400, P5300, P5200, P5100, P3300, M7300, M7200 (including V-TAC), M7100<sup>IP</sup>, M5300, M3300 and SG5300 radios, two (2) years, effective 10/01/2007.
  4. for Unity<sup>®</sup> XG-100P and XG-100M, three (3) years.
  5. for Six-Bay battery Chargers (12082-0314-xx and CH-104570-xxx), one (1) year.
  6. for all other equipment of Seller's manufacture, one (1) year.
- C. If any Equipment fails to meet the foregoing warranties, Seller shall correct the failure at its option (i) by repairing any defective or damaged part or parts thereof, (ii) by making available at Seller's factory any necessary repaired or replacement parts, or (iii) by replacing the failed Equipment with equivalent new or refurbished Equipment. Any repaired or replacement part furnished hereunder shall be warranted for the remainder of the warranty period of the Equipment in which it is installed. Where such failure cannot be corrected by Seller's reasonable efforts, the parties will negotiate an equitable adjustment in price. Labor to perform warranty service will be provided at no charge during the warranty period only for the Equipment covered under Paragraph B.3, B.4 and B.5. To be eligible for no-charge labor, service must be performed at Seller's factory, by an Authorized Service Center (ASC) or other Servicer approved for these purposes either at its place of business during normal business hours, for mobile or personal equipment, or at the Buyer's location, for fixed location equipment. Service on fixed location equipment more than thirty (30) miles (48 km) from the Service Center or other approved Servicer's place of business will include a charge for transportation.
- D. Seller's obligations under Paragraph C shall not apply to any Equipment, or part thereof, which (i) has been modified or otherwise altered other than pursuant to Seller's written instructions or written approval or, (ii) is normally consumed in operation or, (iii) has a normal life inherently shorter than the warranty periods specified in Paragraph B, or (iv) is not properly stored, installed, used, maintained or repaired, or, (v) has been subjected to any other kind of misuse or detrimental exposure, or has been involved in an accident.
- E. The preceding paragraphs set forth the exclusive remedies for claims based upon defects in or nonconformity of the Equipment, whether the claim is in contract, warranty, tort (including negligence), strict liability or otherwise, and however instituted. Upon the expiration of the warranty period, all such liability shall terminate. The foregoing warranties are exclusive and in lieu of all other warranties, whether oral, written, expressed, implied or statutory. **NO IMPLIED OR STATUTORY WARRANTIES OF MERCHANTABILITY OR FITNESS FOR PARTICULAR PURPOSE SHALL APPLY. IN NO EVENT SHALL THE SELLER BE LIABLE FOR ANY INCIDENTAL, CONSEQUENTIAL, SPECIAL, INDIRECT OR EXEMPLARY DAMAGES.**

This warranty applies only within the United States.

**Harris Corporation**  
RF Communications Division  
221 Jefferson Ridge Parkway  
Lynchburg, VA 24501  
1-800-368-3277

**Harris Corporation**  
RF Communications Division  
1680 University Avenue  
Rochester, NY 14610  
1-585-244-5830

ECR-7047R

