

Rear Cover of Manual

Front Cover of Manual

momentum™

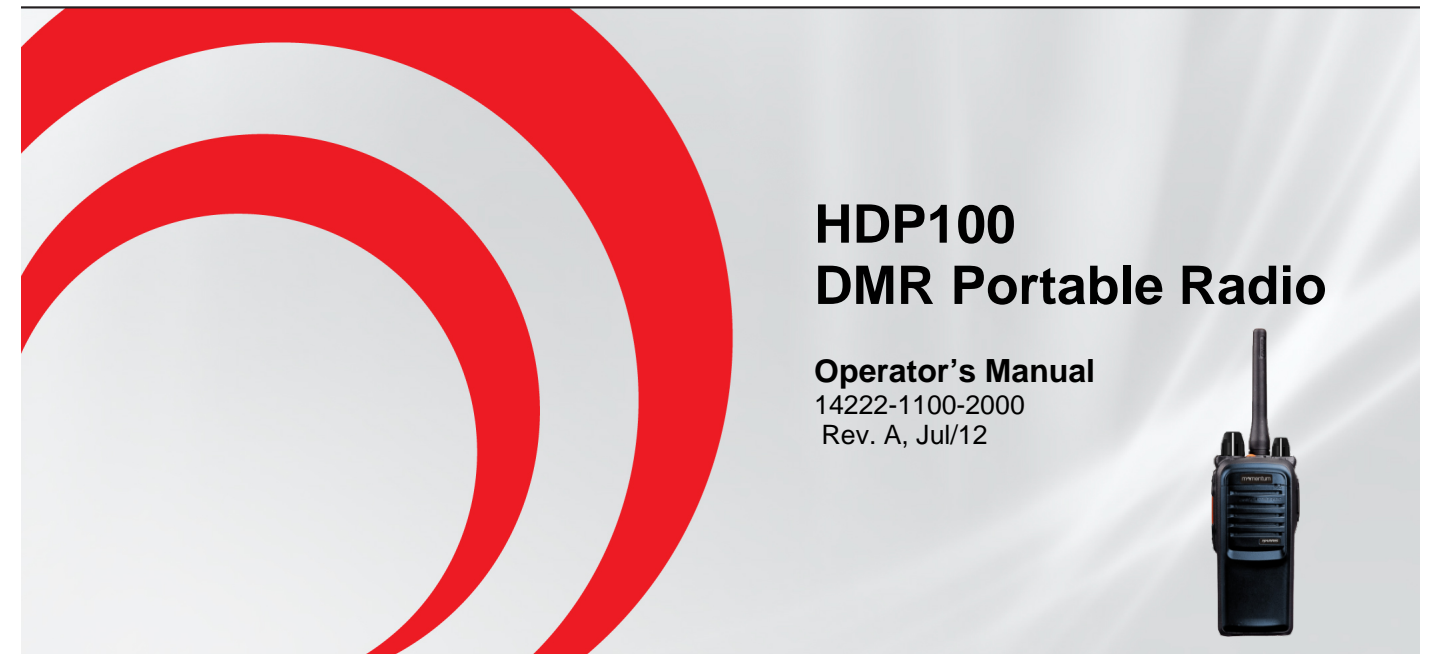

Public Safety and Professional Communications
221 Jefferson Ridge Parkway | Lynchburg, VA USA 24501
www.pspc.harris.com | 1-800-528-7711



MANUAL REVISION HISTORY

REV.	DATE	REASON FOR CHANGE
-	Nov/11	Initial release.
A	Jul/12	Revised attachment procedure for accessory/programming cable and accessory model numbers. Added Equipment and Rechargeable Battery Warranty.

Harris Corporation, Public Safety and Professional Communications (PSPC) Business continually evaluates its technical publications for completeness, technical accuracy, and organization. You can assist in this process by submitting your comments and suggestions to the following:

Harris Corporation fax your comments to: 1-434-455-6851
PSPC Business or email us at:
Technical Publications PSPC_TechPubs@harris.com
221 Jefferson Ridge Parkway
Lynchburg, VA 24501

ACKNOWLEDGEMENT

This device is made under license under one or more of the following US patents: 4,590,473; 4,636,791; 5,148,482; 5,185,796; 5,195,166; 5,271,017; 5,377,229; 4,716,407; 4,972,460; 5,502,767; 5,146,497; 5,164,986; 5,185,795; 5,226,084; 5,247,579; 5,491,772; 5,517,511; 5,581,656; 5,630,011; 5,649,050; 5,701,390; 5,715,365; 5,754,974; 5,826,222; 5,870,405; 6,161,089; 6,199,037 B1 and 6,912,495 B2. DVSI claims certain rights, including patent rights under aforementioned U.S. patents, and under other U.S. and foreign patents and patents pending. Any use of this software or technology requires a separate written license from DVSI.

CREDITS

Harris and assuredcommunications are registered trademarks of and Momentum is a trademark of Harris Corporation.

NOTICE!

The material contained herein is subject to U.S. export approval. No export or re-export is permitted without written approval from the U.S. Government. Rated: EAR99 in accordance with U.S. Dept. of Commerce regulations 15CFR774, Export Administration Regulations.

Publication 14222-1100-2000, Rev. A

iii

NOTICE!

Information and descriptions contained herein are the property of Harris Corporation. Such information and descriptions may not be copied or reproduced by any means, or disseminated or distributed without the express prior written permission of Harris Corporation, PSPC Business, 221 Jefferson Ridge Parkway, Lynchburg, VA 24501.

The voice coding technology embodied in this product is protected by intellectual property rights including patent rights, copyrights, and trade secrets of Digital Voice Systems, Inc. The user of this technology is explicitly prohibited from attempting to decompile, reverse engineer, or disassemble the Object Code, or in any other way convert the Object Code into human-readable form.

Repairs to this equipment should be made only by an authorized service technician or facility designated by the supplier. Any repairs, alterations or substitutions of recommended parts made by the user to this equipment not approved by the manufacturer could void the user's authority to operate the equipment in addition to the manufacturer's warranty.



This product conforms to the European Union WEEE Directive 2002/96/EC. Do not dispose of this product in a public landfill. Take it to a recycling center at the end of its life.

This manual is published by **Harris Corporation** without any warranty. Improvements and changes to this manual necessitated by typographical errors, inaccuracies of current information, or improvements to programs and/or equipment, may be made by **Harris Corporation** at any time and without notice. Such changes will be incorporated into new editions of this manual. No part of this manual may be reproduced or transmitted in any form or by any means, electronic or mechanical, including photocopying and recording, for any purpose, without the express written permission of **Harris Corporation**.

Copyright© 2011 — 2012, Harris Corporation

TABLE OF CONTENTS

<u>Section</u>	<u>Page</u>
SYMBOLS USED IN THIS MANUAL	1
CAUTION AND NOTE SYMBOLS.....	1
SYMBOLS FOR ANALOG AND DIGITAL CHANNEL FEATURES/FUNCTIONS.....	1
REGULATORY INFORMATION	2
PRODUCT SAFETY BOOKLET.....	2
RF EXPOSURE GUIDELINES.....	2
ELECTROMAGNETIC INTERFERENCE.....	3
FCC Part 15 Statement.....	4
Industry Canada Statement.....	4
EU REGULATORY CONFORMANCE.....	4
CHECKING ITEMS IN THE PACKAGE	5
RADIO OVERVIEW	6
RADIO CONTROLS AND OTHER ITEMS.....	6
PROGRAMMABLE SHORTCUT KEYS.....	7
BEFORE USING THE RADIO	9
CHARGING THE BATTERY.....	9
ASSEMBLY AND DISASSEMBLY.....	10
Attaching and Removing the Antenna.....	10
Attaching the Battery.....	10
Removing the Battery.....	10
Attaching the Belt Clip.....	11
Removing the Belt Clip.....	11
Attaching the Audio Accessory/Programming Cable.....	11
Removing an Accessory/Programming Cable.....	12
BASIC OPERATIONS	13
TURNING THE RADIO ON AND OFF.....	13
ADJUSTING THE VOLUME.....	13

TABLE OF CONTENTS





<u>Section</u>	<u>Page</u>
LED INDICATOR	13
SELECTING A ZONE.....	13
SELECTING A CHANNEL	14
SWITCHING THE CHANNEL MODE BETWEEN ANALOG AND DIGITAL	14
PRIVATE CALLS 	14
Transmitting a Private Call	14
Receiving and Responding to a Private Call.....	15
GROUP CALLS 	15
Transmitting a Group Call	15
Receiving and Responding to a Group Call	15
ALL CALLS 	15
Transmitting an All Call	16
Receiving an All Call.....	16
TALK-AROUND (DIRECT MODE)	16
CALLS ON ANALOG CHANNELS 	16
Transmitting a Call on an Analog Channel.....	16
Receiving a Call on an Analog Channel	17
Monitor.....	17
Squelch Off.....	17
Adjust Squelch Level.....	18
BATTERY STRENGTH INDICATOR	18
TRANSMIT POWER LEVEL	18
SCANNING CHANNELS	20
GENERAL INFORMATION	20
OPERATION	20
Turning Scan On and Off.....	20
Pausing Scan 	20
Nuisance Temporary Delete	21

TABLE OF CONTENTS









<u>Section</u>	<u>Page</u>
EMERGENCY COMMUNICATIONS	22
GENERAL INFORMATION	22
Emergency Mode	22
Emergency Type.....	23
Emergency ID Type 	23
Emergency Operations on Analog Channels 	24
Emergency Operations on Digital Channels 	26
LONE WORKER.....	27
Using Lone Worker	28
MAN DOWN (OPTIONAL)	29
Using Man Down	29
HDC1200 SIGNALING.....	30
GENERAL INFORMATION	30
TRANSMISSION (ENCODE)	30
PTT ID Transmission	30
SECURE COMMUNICATIONS	31
GENERAL INFORMATION	31
OPERATION.....	31
Manually Enabling and Disabling Scrambler/Encrypt	31
MISCELLANEOUS FEATURES	32
CHANNEL BUSY LOCKOUT	32
TIME-OUT TIMER (TOT).....	32
PSEUDO TRUNKING 	32
MIC AGC	32
RADIO REGISTRATION SERVICE 	33
GPS REVERT 	33
ONE TOUCH CALL	33



TABLE OF CONTENTS

<u>Section</u>	<u>Page</u>
One Touch Call Operation.....	34
TELEMETRY 	34
Supervise a Device via Another/Remote Radio.....	35
Supervise a Device via Third-Party Software.....	35
ROAM 	35
TROUBLESHOOTING AND TECHNICAL ASSISTANCE	36
TROUBLESHOOTING TABLE	36
TECHNICAL ASSISTANCE	38
CARE AND CLEANING	39
RADIO CARE	39
RADIO CLEANING.....	39
MODEL NUMBERS.....	40
RADIO PACKAGES	40
ANTENNAS	41
BATTERIES AND BATTERY CHARGERS	42
CARRYING ACCESSORIES.....	42
AUDIO ACCESSORIES	43
WARRANTY REGISTRATION AND WARRANTY.....	44
WARRANTY REGISTRATION.....	44
EQUIPMENT AND RECHARGEABLE BATTERY WARRANTY.....	44



SYMBOLS USED IN THIS MANUAL

The following tables lists symbols used in this manual.

CAUTION AND NOTE SYMBOLS

SYMBOL	DESCRIPTION
	The WARNING symbol calls attention to a procedure, practice, or the like, which, if not correctly performed or adhered to, could result in personal injury. Do not proceed beyond a WARNING symbol until the conditions identified are fully understood or met.
	The CAUTION symbol calls attention to an operating procedure, practice, or the like, which, if not performed correctly or adhered to, could result in damage to the equipment or severely degrade equipment performance.
	The NOTE symbol calls attention to supplemental information, which may improve system performance or clarify a process or procedure. It may also be used to flag tips that can help you make better use of the radio.

SYMBOLS FOR ANALOG AND DIGITAL CHANNEL FEATURES/FUNCTIONS

SYMBOL	DESCRIPTION
	The DIGITAL CHANNEL symbol indicates the particular feature or function applies to digital channels only.
	The ANALOG CHANNEL symbol indicates the particular feature or function applies to analog channels only.

If no digital channel or analog channel symbol appears, the function/feature applies to both analog channels and digital channels.

REGULATORY INFORMATION

PRODUCT SAFETY BOOKLET



Before operating the HDP100 portable radio, read the safety and RF exposure guidelines contained in Product Safety Booklet included with the radio.

RF EXPOSURE GUIDELINES



The HDP100 portable radio generates RF electromagnetic energy during transmit mode. This radio is designed for and classified as “Occupational Use Only,” meaning it must be used only during the course of employment by individuals aware of the hazards and the ways to minimize such hazards. This radio is NOT intended for use by the “General Population” in an uncontrolled environment.

The HDP100 radio has been tested and complies with the Federal Communications Commission (FCC) RF exposure limits for “Occupational Use Only.” In addition, this radio complies with the following Standards and Guidelines with regard to RF energy and electromagnetic energy levels and evaluation of such levels for exposure to humans:

- FCC Office of Engineering and Technology (OET) Bulletin 65 Edition 97-01 Supplement C, Evaluating Compliance with FCC Guidelines for Human Exposure to Radio Frequency Electromagnetic Fields.
- American National Standards Institute (C95.1 – 1992), IEEE Standard for Safety Levels with Respect to Human Exposure to Radio Frequency Electromagnetic Fields, 3 kHz to 300 GHz.
- American National Standards Institute (C95.3 – 1992), IEEE Recommended Practice for the Measurement of Potentially Hazardous Electromagnetic Fields – RF and Microwave.

REGULATORY INFORMATION



To ensure exposure to RF electromagnetic energy is within the FCC allowable limits for occupational use, always adhere to the following guidelines:

- DO NOT operate the radio without a proper antenna attached, as this may damage the radio and may also cause the FCC RF exposure limits to be exceeded. A proper antenna is the antenna supplied with this radio by Harris or an antenna specifically authorized by Harris for use with this radio. These antennas are listed on page 41.
- DO NOT transmit for more than 50% of total radio use time (“50% duty cycle”). Transmitting more than 50% of the time can cause FCC RF exposure compliance requirements to be exceeded. The radio is transmitting when the LED indicator on the top of the radio lights red in color. The radio transmits when its “PTT” (Push-To-Talk) key is pressed.
- Always transmit using low power when possible. In addition to conserving battery charge, low power can reduce RF exposure.
- ALWAYS use Harris authorized accessories (antennas, batteries, belt clips, speaker/mics, etc). Use of unauthorized accessories may cause the FCC Occupational/Controlled Exposure RF compliance requirements to be exceeded.
- ALWAYS keep the device and its antenna at least 1 inch (2.5 centimeters) from the body and face when transmitting to ensure FCC RF exposure compliance requirements are not exceeded. To provide the best sound quality to the recipients of your transmission, Harris recommends holding the front of the radio at between 1 and 2 inches (2.5 to 5.0 centimeters) from your mouth when transmitting into the radio’s microphone.

ELECTROMAGNETIC INTERFERENCE

During transmissions, this radio generates RF energy that can possibly cause interference with other devices or systems. To avoid such interference, turn off the radio in areas where signs are posted to do so. DO NOT

REGULATORY INFORMATION

operate the transmitter in areas that are sensitive to electromagnetic radiation such as hospitals, aircraft, and blasting sites.

FCC Part 15 Statement

This device complies with Part 15 of the FCC Rules. Operation is subject to the following two conditions:

1. This device may not cause harmful interference, and
2. This device must accept any interference received, including interference that may cause undesired operation.

Industry Canada Statement

This device complies with Industry Canada license-exempt RSS standard(s). Operation is subject to the following two conditions: (1) this device may not cause interference, and (2) this device must accept any interference, including interference that may cause undesired operation of the device.

Le présent appareil est conforme aux CNR d'Industrie Canada applicables aux appareils radio exempts de licence. L'exploitation est autorisée aux deux conditions suivantes : (1) l'appareil ne doit pas produire de brouillage, et (2) l'utilisateur de l'appareil doit accepter tout brouillage radioélectrique subi, même si le brouillage est susceptible d'en compromettre le fonctionnement.





EU REGULATORY CONFORMANCE

As certified by the qualified laboratory, the product is in compliance with the essential requirements and other relevant provisions of the Directive 1999/5/EC. Please note that the above information is applicable to EU countries only.

CE0678!

CHECKING ITEMS IN THE PACKAGE

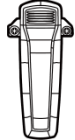
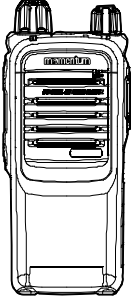
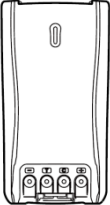
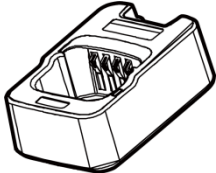
Carefully unpack and check that all items listed below are received. If any item is missing or damaged, please immediately contact your dealer.

 <p>Antenna</p>	 <p>Operator's Manual, Product Safety Booklet, Quick Guide</p>	 <p>Power Adapter</p>	 <p>Belt Clip</p>
 <p>Radio</p>	 <p>Battery</p>	 <p>Battery Charger</p>	 <p>Wrist Strap</p>



NOTE

The antenna may vary with different frequency bands. The frequency band is marked on the label of antenna. If not, refer to the label on the radio unit for frequency band information.

RADIO OVERVIEW



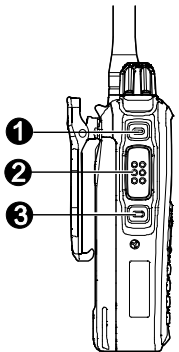
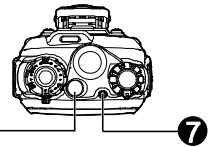
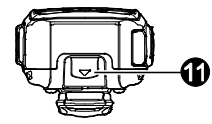
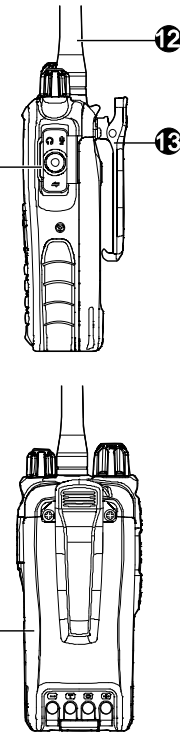

RADIO CONTROLS AND OTHER ITEMS

ITEM	NAME		ITEM	NAME
1	Side Key 1 (SK1)		8	On/Off/Volume Control Knob
2	PTT Key		9	Microphone
3	Side Key 2 (SK2)		10	Accessory Jack
4	Top Key (TK)		11	Battery Latch
5	Channel Selector Knob		7	LED Indicator
6	Speaker		12	Antenna
7	LED Indicator		13	Belt Clip
			14	Battery





RADIO OVERVIEW

PROGRAMMABLE SHORTCUT KEYS

For enhanced convenience, you may request your dealer pre-program keys SK1, SK2, and TK as shortcuts to any of the functions listed in this table:

NO.	SHORTCUT NAME	SHORTCUT KEY FUNCTION
1	Zone Up	Change to another zone. See page 13.
2	Zone Down	
3	Adjust Power Level	Quickly change the radio's transmitting power level. See page 18.
4	Talk-Around	Directly communicate with other radios. See page 16.
5	Monitor 	Toggle receiver muting on and off. See page 17.
6	Monitor Momentary 	Momentarily turn receiver muting off. See page 17.
7	Squelch Off 	Toggle squelch on and off. When off, the radio always unmutes so if no radio carrier is present on the channel, receiver noise is heard. See page 17.
8	Squelch Off Momentary 	Momentarily turn squelch off. Otherwise, same as above. See page 17.
9	Scan	Enable and disable scanning. See page 20.
10	Nuisance Temporary Delete	Temporarily skip unwanted channel activity during scanning. See page 21.
11	Emergency On	Turn on the emergency mode and transmit emergency call/signaling. See page 22.
12	Emergency Off	Turn off the emergency call/signaling, exiting emergency mode. See page 22.

RADIO OVERVIEW

NO.	SHORTCUT NAME	SHORTCUT KEY FUNCTION
13	Lone Worker	Toggle the Lone Worker feature on and off. See page 27.
14	Adjust Squelch Level 	Temporarily adjust the receiver squelch threshold. See page 18.
15	Battery Strength Indicator	Indicate remaining battery strength by the LED indicator. See page 18.
16	Man Down (Optional Feature)	Activate this emergency feature so if the radio is positioned at an angle for a preset period of time, it will begin emergency transmissions. See page 29.
17	Scrambler  Encrypt 	Scrambler: Encrypt voice transmissions for secure communications. Encrypt: Encrypt voice and message transmissions for secure communications. See page 30.
18	One Touch Call (1 though 5) 	Quickly make calls or send messages. See page 33.
19	Telemetry 	To supervise remote devices. See page 34.
20	Roam	To enable and disable the Roam feature. See page 35.



NOTE





Long and short presses of a key can be programmed with different functions by your dealer. The Top Key (TK) is programmed as the emergency key by default. It may be reprogrammed by your dealer.

BEFORE USING THE RADIO

CHARGING THE BATTERY

Follow this procedure to charge the radio's battery:

1. Connect the AC power adapter to an AC power source. See arrow ①.
2. Plug the small plug of the power adapter into the jack at the rear of the charger. See arrow ②.
3. Place the radio with the battery attached, or just the battery alone, into the slot in the top of the charger. See arrow ③.
4. Refer to the following table for charge status, as indicated by the charger's status indicator.

STATUS INDICATOR		CHARGE STATUS
Flashes Red Slowly		Standby (No Load/No Battery)
Glowes Red		Battery Charging
Flashes Red Rapidly		Battery or Charger Failure
Glowes Orange		Battery 90% Charged
Glowes Green		Battery Fully Charged



Read the radio's Product Safety Booklet for related information.

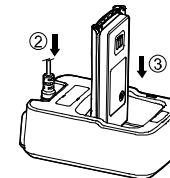
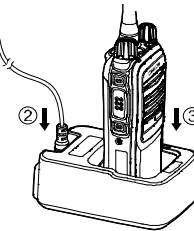
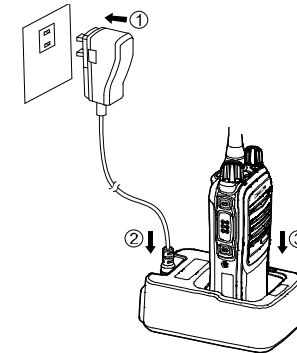

To achieve optimal battery performance, charge the battery five (5) hours before its initial use.

BEFORE USING THE RADIO

ASSEMBLY AND DISASSEMBLY

Attaching and Removing the Antenna

To attach the antenna to the radio, place its base into the antenna jack on the top of the radio and turn the antenna in a clockwise direction.

To remove the antenna from the radio, simply turn the antenna in a counter-clockwise direction until it is free from the radio.

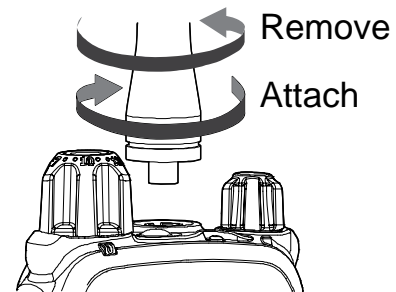

Attaching the Battery

To attach the battery to the radio:

1. Slide the top of the battery completely into the cavity at the rear of the radio. See arrow ①.
2. Gently press on the bottom of the battery until a click is heard. See arrow ②. This locks the battery to the radio.

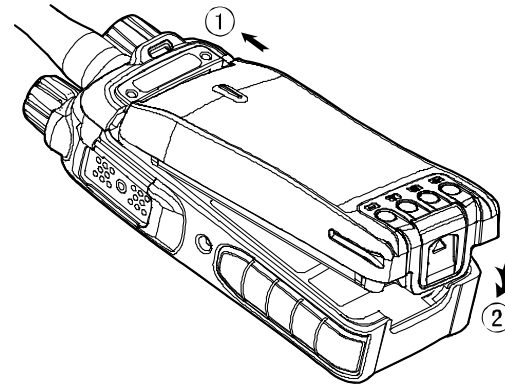

Removing the Battery

To remove the battery from the radio:

1. Turn off the radio by rotating its on/off/volume control to the full counter-clockwise position.
2. Grasp the radio firmly in one hand in a bottoms-up position.
3. Using the other hand, slide the battery latch up to unlatch the battery, and remove the battery from the radio.

BEFORE USING THE RADIO

Attaching the Belt Clip

To attach the belt clip to the radio:

1. Remove the two (2) screws on the rear of the radio.
2. As illustrated, align the screw holes on the belt clip with those on the radio and re-install the two screws into the holes.
3. Using a small screwdriver, tighten the two screws securely. Do not over-tighten them.

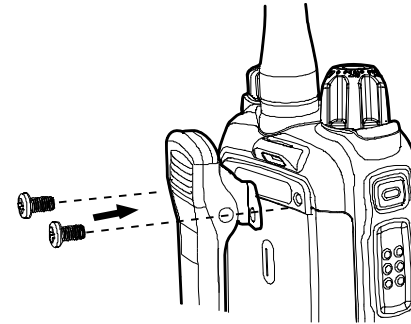

Removing the Belt Clip

To remove the belt clip, use a small screwdriver to loosen and remove the two (2) screws that secure the clip to the radio, and then remove it from the radio.

Attaching the Audio Accessory/Programming Cable

To attach an audio accessory or a programming cable to the radio:

1. Open the accessory jack cover, as illustrated by arrow ①.
2. Align the threaded portion of the cable's screw with the threaded hole in the center of the jack.



Do not scrape the silicon rubber on the accessory jack. Scrapes/Scratches in this area could permanently affect the waterproof performance of the radio. **Correct and incorrect alignment is shown in the illustration on the next page.**

3. Join the screw to the thread hole and tighten the screw by the knob on the cable's plug. See arrow ②.

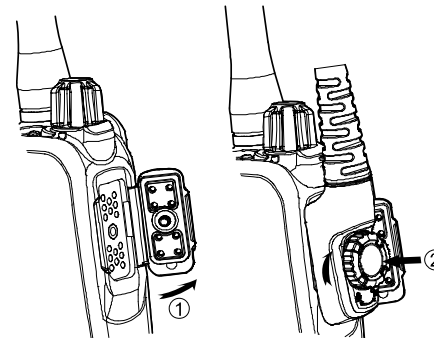

BEFORE USING THE RADIO

**CORRECT
ALIGNMENT**

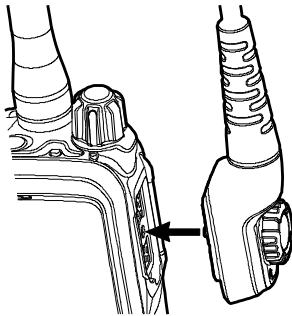

**INCORRECT
ALIGNMENT**

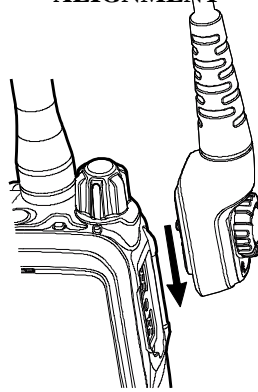

**INCORRECT
ALIGNMENT**

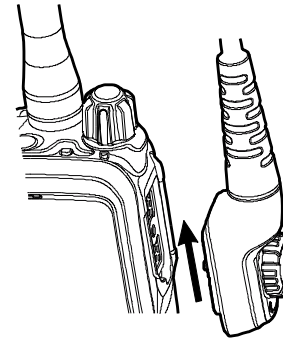

When an external accessory is attached to the radio's accessory jack, waterproof performance of the radio may be affected.

Removing an Accessory/Programming Cable

To remove a cable from the radio's accessory jack, simply loosen its screw and detach the cable from the jack.

BASIC OPERATIONS

TURNING THE RADIO ON AND OFF

To turn on the radio, rotate its **On/Off Volume Control** knob clockwise out of the detent position. A click will be sensed. The radio flashes its LED status indicator green. This knob is item 8 on page 6.







To turn the radio off, rotate this knob fully counter-clockwise until the detent click is sensed.

ADJUSTING THE VOLUME

After turning the radio on, rotate the **On/Off Volume Control** knob clockwise to increase the volume or counter-clockwise to decrease it. Volume adjustment can be made at anytime later in the same manner.

LED INDICATOR

A light-emitting diode (LED) type status indicator is located on the top of the radio, near the On/Off/Volume Control Knob. This indicator can be quickly viewed to determine the basic operational status of the radio. Each status indication is described in the table at the right.

LED INDICATOR	RADIO STATUS
Flashing Green 	Powering on
Glowing Red 	Transmitting
Glowing Green 	Receiving
Flashing Orange Slowly (approximately once every 2 sec.) 	Scanning
Flashing Orange Rapidly (approximately twice every 1 sec.) 	Emergency
Glowing Orange 	OK to transmit voice audio by pressing the PTT key and speaking into the microphone.

SELECTING A ZONE

A zone is a group of pre-programmed radio channels exhibiting similar properties. The radio supports up to three (3) zones and each zone can have up to 16 channels. Zones and channels are pre-programmed into the radio by your dealer. Select a zone by pressing the programmed **Zone Up** or **Zone**

BASIC OPERATIONS

Down shortcut key. When zone 1 is selected, the radio beeps once. When zone 2 is selected, the radio beeps twice. When zone 3 is selected, the radio beeps three times. Keys **SK1**, **SK2**, and **TK** may be pre-programmed by your dealer as Zone Up and Zone Down shortcut keys. The **SK1**, **SK2**, and **TK** keys are illustrated on page 6.

SELECTING A CHANNEL

The radio's **Channel Selector** knob is located on the top of the radio. It is item 5 on page 6. Rotate this knob to select the desired channel within the currently selected zone.

This knob has 16 positions, for a total of 16 channels per zone. Some knob positions may not be programmed with a channel.

SWITCHING THE CHANNEL MODE BETWEEN ANALOG AND DIGITAL

Each channel can be pre-programmed as either an analog channel or a digital channel. If the currently selected zone includes both analog and digital channels, the **Channel Selector** knob can be used to quickly switch between analog and digital channels. Select the desired channel by rotating the knob to the respective position.

PRIVATE CALLS

A private call is a call initiated by a radio user to another radio user.

Transmitting a Private Call

When the channel is clear (i.e., when not receiving a signal), hold down the radio's **PTT** key to transmit a private call to the Private Call contact preset for the currently selected channel. Release the **PTT** key to stop transmitting, and listen for a reply.

BASIC OPERATIONS



Whenever transmitting (i.e., **PTT** key depressed), hold the front of the radio between 1 to 2 inches from your mouth and speak into the microphone at a normal voice level. This will ensure optimal reception at the receiving radio unit(s). Never shout or whisper when transmitting. As illustrated on page 6, the radio's microphone is located near the top of the radio.



Each digital channel may be pre-programmed with a preset contact by your dealer. The preset contact can be a Private Call contact, a Group Call contact, or an All Call contact.

Receiving and Responding to a Private Call

When a private call is received, listen to the call and adjust the volume as necessary. To respond to the call, hold down the **PTT** key within the preset time period, and speak into the microphone at a normal voice level.

GROUP CALLS

A group call is a call initiated by a radio user to a group of radio users.

Transmitting a Group Call

When the channel is clear (i.e., when not receiving a signal), hold down the radio's **PTT** key to transmit a group call to the Group Call contact preset for the currently selected channel. Release the **PTT** key to stop transmitting, and listen for a reply. See *Receiving and Responding to a Group Call* for additional information.

Receiving and Responding to a Group Call

When a group call is received, listen to the call and adjust the volume as necessary. To respond to the call, hold down the **PTT** key within the preset time period, and speak into the microphone at a normal voice level.

ALL CALLS

An all call is a call initiated by a radio user to all radio users on the channel.

BASIC OPERATIONS

Transmitting an All Call

When the channel is clear (i.e., when not receiving a signal), hold down the radio's **PTT** key to transmit an all call to the All Call contact preset for the currently selected channel. Release the **PTT** key to stop transmitting, and listen for a reply.



All calls can only be transmitted if enabled by your dealer via radio pre-programming.

Receiving an All Call

When an all call is received, the call's audio is heard in the radio's speaker.



It is not possible to respond to an all call.

TALK-AROUND (DIRECT MODE)

The talk-around feature provides direct radio-to-radio communications. With talk-around, a radio repeater system is not required for radio communications. This type of operation is sometimes called "direct mode." Talk-around is beneficial when, for example, a radio repeater system malfunction has occurred, or when the radio is out-of-range of a radio repeater system, but other radios are nearby that can communicate on the same pre-programmed radio channels.

To toggle radio operation between normal communications mode (repeater mode) and talk-around, simple press the pre-configured **Talk-Around** shortcut key.

CALLS ON ANALOG CHANNELS

Transmitting a Call on an Analog Channel

1. If not already, select the desired analog channel.

BASIC OPERATIONS

2. Listen for a clear channel. In other words, if another person is using the channel, wait for them to finish transmitting/speaking. If pre-programmed, a monitor or squelch off shortcut key should be used to verify the channel is clear. See the following sections for additional information on these functions.
3. Hold down the radio's **PTT** key and speak into the microphone at a normal voice level.
4. Release the **PTT** key to stop transmitting and listen for a reply.

Receiving a Call on an Analog Channel

1. If not already, select the desired analog channel. Do **not** press the **PTT** key.
2. When an incoming call is received on the channel, rotate the **On/Off Volume Control** knob as necessary to adjust the volume.

If pre-programmed, a monitor or squelch off shortcut key can be used to verify there is no signal on the channel. Also, the Squelch Off shortcut key can be used in weak signal conditions.

Monitor

Monitor is a function for analog channels that allows any pre-programmed receiver decoding to be disabled so calls (or other activity) on the selected channel without the correct code can be monitored.

This does not disable receiver squelch. When the Monitor function is enabled, any calls on the channel will be heard in the radio's speaker.

To enable and disable the Monitor function, press the pre-programmed **Monitor** shortcut key, or the **Monitor Momentary** shortcut key. The **Monitor** shortcut key provides a toggle on/off type function, whereas the **Monitor Momentary** shortcut key temporarily enables the function only while the shortcut key is depressed.

Squelch Off

Squelch Off is an analog channel function that, when enabled, keeps the receiver unsquelched (i.e., not muted) even when there is no signal on the selected channel. When enabled, call audio on the channel (or receiver noise) is routed to the radio's speaker.

BASIC OPERATIONS

To toggle squelch between enabled and disabled, press the pre-configured **Squelch Off** shortcut key.

To momentarily turn squelch off, depress the pre-configured **Squelch Off Momentary** key. When this key is released, squelch turns back on.





Adjust Squelch Level

If programmed, the **Adjust Squelch Level** shortcut key can be used to select one of three receiver squelch levels: Tight, Normal, and Open. The default squelch level is Normal, which is often used in a low radio frequency noise environment. Generally, the Tight level should be used in a high radio frequency noise environment; it requires a stronger received radio signal to unmute the receiver. Using Open will keep the speaker unmuted, regardless of the noise level or the decode settings.

When switching from Tight to Open, a low-pitched tone sounds and received noise or call audio is heard from the speaker. When switching from Open to Normal, a high-pitched tone sounds and the background sounds disappear. When switching from Normal to Tight, a high-pitched tone sounds.

BATTERY STRENGTH INDICATOR

If the **Battery Strength Indicator** shortcut key is pre-programmed, this function can be used to quickly check the remaining battery strength via the LED indicator on the top of the radio. Simply press and hold this pre-programmed shortcut key and view the LED indicator on the top of the radio.

LED INDICATOR	BATTERY STRENGTH
Glowing Green 	High
Glowing Orange 	Medium
Glowing Red 	Low
Glowing Red (and Low Battery Alert Tone Sounds) 	Insufficient

TRANSMIT POWER LEVEL

With this feature, the radio's transmit power level can be quickly changed between a low and a high power level. Use the low power level whenever possible to increase battery operating time and to reduce the possibility of radio communications interference. However, if

BASIC OPERATIONS

communications with other radios is not possible on the currently selected channel at the low power level, select and use the high power level.

Press the programmed **Adjust Power Level** shortcut key to toggle between the low and high power levels. When switching to the high power level, a high-pitched tone sounds. When switching the low power level, a low-pitched tone sounds.

SCANNING CHANNELS

GENERAL INFORMATION

The radio's scan feature allows scanning of radio channels pre-programmed into the radio for call activity. Scan lists can be pre-programmed for each channel. Each scan list may contain 32 digital or analog channels. When the radio is scanning channels:

- The LED indicator on the top of the radio flashes orange slowly.
- The radio scans the channels currently on the scan list for calls (or other activity).
- When a call (or other activity) is received/detected on a channel in the scan list:
 - The call's audio is routed to the radio's speaker.
 - The LED indicator glows green.
 - The radio remains on the channel (i.e., scan operation automatically pauses) until the call (or other activity) ends.

OPERATION

Turning Scan On and Off

Scan can be turned on and off by pressing the **Scan** shortcut key. When scan turns on, a high-pitched tone sounds.

The radio can be pre-programmed with the Auto Scan feature on a per-channel basis. If so, the radio will automatically begin scanning the channel's scan list when the channel is selected. In this case, to turn scan off, press the **Scan** shortcut key once.

Pausing Scan

If a call is received on an analog channel and staying on the channel (i.e., pausing scan) is desired so additional transmissions can be heard on it, press the pre-programmed **Monitor** or **Squelch Off** shortcut key when a call is on the channel. When the Monitor function is on, if present, call audio on the channel is heard in the radio's

SCANNING CHANNELS

speaker. When the Squelch Off function is on or when a call is on the channel, call audio on the channel (or receiver noise) is heard in the radio's speaker. Press the shortcut key again or the **Scan** shortcut key to unpause scan.

Nuisance Temporary Delete

To temporarily remove a channel from a channel's scan list so calls on it will not pause scanning, press the pre-programmed **Nuisance Temporary Delete** shortcut key when a call is on the channel. In this case, the channel will not be scanned again until after the channel or zone is changed, the radio is power-cycled, or scan is turned off and back on.



EMERGENCY COMMUNICATIONS

GENERAL INFORMATION

The radio's emergency feature can be used to summon help from another radio operator(s) and/or via a radio dispatch/control center. The emergency process has the highest call priority throughout the radio communications system. Emergency operations can be performed when the radio is transmitting or receiving. The radio can be pre-programmed with different emergency modes, emergency types, and emergency ID types. These are described in the following subsections. Each channel can be pre-programmed with different emergency system operation. Consult your radio dealer for specific information on how your radio is pre-programmed:

Emergency Mode

The radio supports three (3) emergency modes, as defined in the following table. Two (2) of the three modes apply only to analog channels (see  symbol). To select a different mode, consult with your radio dealer:

EMERGENCY MODE	DESCRIPTION
Alarm 	With this mode, you can send alarm information to another radio operator or to a dispatch/control center, but you cannot transmit voice audio. Initiate by pressing the pre-programmed Emergency shortcut key.
Alarm with Call 	With this mode, you can send alarm information by pressing the pre-programmed Emergency shortcut key. Next, when the LED indicator glows steady, speak into the microphone to transmit your voice. Pressing the radio's PTT key is <u>not</u> necessary when speaking in the mic. This is commonly referred to as a "hot-mic" condition.
Call Only	With this mode, you can send alarm information by pressing the pre-programmed Emergency shortcut key. Next, when the LED indicator glows steady, speak into the microphone to transmit your voice. Pressing the radio's PTT key is <u>not</u> necessary when speaking in the mic (i.e., a hot-mic condition).

EMERGENCY COMMUNICATIONS

Emergency Type

The radio supports four (4) emergency types, as defined in the following table. To select a different type, consult with your radio dealer:

EMERGENCY TYPE	DESCRIPTION
Siren Only	When an emergency occurs, the radio sounds a shrill alarm tone.
Regular	When an emergency occurs, the radio gives an audible indication.
Silent	When an emergency occurs, the radio does not give any indication, audible or visual. This type is typically employed in covert operations.
Silent with Voice	When an emergency occurs, the radio does not give any audible or visual indication, but it will receive voice audio response(s) from other radios or a dispatch/control center transmitting on the emergency channel. This type is typically employed in covert operations.

Emergency ID Type

The radio supports two (2) emergency ID types on analog channels, as defined in the following table. To select a different ID type, consult with your radio dealer:

EMERGENCY TYPE	DESCRIPTION
None	No signaling is used when the radio transmits alarm information.
HDC1200	HDC1200 signaling is used when the radio transmits alarm information.

EMERGENCY COMMUNICATIONS

Emergency Operations on Analog Channels

Alarm Emergency Mode

If the radio is pre-programmed for Alarm emergency mode operations on the selected analog channel, press the pre-programmed **Emergency** shortcut key transmit an alarm. When an alarm is transmitted, the LED indicator on the top of the radio rapidly flashes orange then glows red to indicate the alarm transmission. The radio may also be pre-programmed to sound an audible alarm.

The alarm will be transmitted until the pre-programmed number of alarm cycles completes, or it can be ended early by simply long-pressing the pre-programmed **Emergency** shortcut key.

Alarm with Call Emergency Mode

If the radio is pre-programmed for Alarm with Call emergency mode operations on the selected analog channel, use this feature as follows:

1. Press the pre-programmed **Emergency** shortcut key. The LED indicator on the top of the radio rapidly flashes orange then glows red to indicate the alarm transmission. The radio may also be pre-programmed to sound an audible alarm.
2. The radio is in a hot-mic condition for a pre-programmed period of time. Speak into the microphone to transmit voice audio on the selected analog channel. Pressing the radio's **PTT** key is not necessary during this time. The LED indicator glows red during this time.
3. After the pre-programmed hot-mic time ends, the radio enters a receive period. Listen for a reply during this period of time.
4. If the radio is pre-programmed with more than one voice cycle, it will repeat the transmit (with hot-mic) and receive periods for the number of pre-programmed cycles.
5. After the voice cycle(s) expires, additional voice calls can be made by pressing the radio's **PTT** key. The the LED indicator glows red. Release the **PTT** key to end the voice call (transmission) on the emergency channel. The LED indicator flashes orange rapidly.

EMERGENCY COMMUNICATIONS

The Alarm with Call emergency mode transmission will continue until the pre-programmed number of alarm cycles and voice cycles completes. Alternately, it can be ended early by simply long-pressing the pre-programmed **Emergency** shortcut key.

Call Only Emergency Mode (HDC1200 Signaling Only)

If the radio is pre-programmed for Call Only emergency mode operations on the selected analog channel, use this feature as follows:

1. Press the pre-programmed **Emergency** shortcut key. The radio switches to the dedicated/revert channel for the emergency call. Also, the LED indicator on the top of the radio rapidly flashes orange then glows red to indicate the alarm transmission. The radio may also be pre-programmed to sound an audible alarm.
2. If the feature “Alarm with Call to Follow” is enabled, voice audio can be transmitted by speaking into the microphone.
3. After the voice cycle(s) expires, additional voice calls can be made by pressing the radio’s **PTT** key. The LED indicator glows red. Release the **PTT** key to end the voice call (transmission) on the emergency channel. The radio LED indicator flashes orange rapidly.

To exit the emergency mode early, long-press the pre-programmed **Emergency** shortcut key.

The following parameters are pre-programmed by your radio dealer:

- Number of voice cycles;
- Duration of each transmission;
- Transmission interval;
- If without HDC1200 signaling:
 - Number of alarm cycles; and,
 - Alarm duration.
- If with HDC1200 signaling:
 - Number of polite retries; and
 - Number of impolite retries.



NOTE

EMERGENCY COMMUNICATIONS

Emergency Operations on Digital Channels

Alarm Emergency Mode

If the radio is programmed for Alarm (only) emergency mode operations on the selected digital channel, use this mode as follows:

1. Press the programmed **Emergency** shortcut key. The LED indicator glows red to indicate the alarm transmission.
2. Once the emergency cycles expire, the radio exits the emergency mode automatically.

To exit the emergency mode early, long-press the programmed **Emergency** shortcut key.

Alarm with Call Emergency Mode

If the radio is programmed for Alarm with Call emergency mode operations on the selected digital channel, use this mode as follows:

1. Press the programmed **Emergency** shortcut key. The LED indicator glows red to indicate the alarm transmission.
2. Speak into the microphone to transmit voice audio.
3. After the voice cycle(s) expires, additional voice calls can be made by pressing the microphone's **PTT** key. When doing so, the LED indicator glows red. Release the **PTT** key to end the voice call (transmission) on the emergency channel. The LED indicator flashes orange rapidly. If a call is received, the LED indicator glows green.

To exit the emergency mode early, long-press the programmed **Emergency** shortcut key.



The following parameters are programmed by your radio dealer for the above mode:

- Number of voice cycles;
- Duration of each transmission; and,
- Transmission interval.

EMERGENCY COMMUNICATIONS

Call Only Emergency Mode

If the radio is programmed for Call Only emergency mode operations on the selected digital channel, use this mode as follows:

1. Press the programmed **Emergency** shortcut key. The radio switches to the dedicated/revert channel for the emergency call.
2. If the “Alarm with Call to Follow” feature is enabled, voice audio can be transmitted by speaking into the microphone when the LED indicator glows red.
3. After the voice cycle(s) expires, additional voice calls can be made by pressing the microphone’s **PTT** key. When doing so, the LED indicator glows red. Release the **PTT** key to end the voice call (transmission) on the emergency channel. The LED indicator flashes orange rapidly. When a call is received, the LED indicator glows green.

To exit the emergency mode early, long-press the programmed **Emergency** shortcut key.



The following parameters are programmed by your radio dealer for the above mode:

- Number of voice cycles;
- Duration of each transmission;
- Transmission interval;
- Number of polite retires; and,
- Number of impolite retires.

LONE WORKER

The Lone Worker feature, when enabled, causes the radio to automatically transmit an alarm if the radio user/operator does not react to reminder beeps which the radio periodically generates. Before this feature will function, it must be programmed by your radio dealer and it must be enabled.

User/Operator reaction is accomplished by simply pressing any radio key or by rotating a radio knob before a programmed reminder timer expires. Either reaction will reset the programmed reminder and response timers,

EMERGENCY COMMUNICATIONS

thus starting a new response period of time. The response timer is typically programmed for many minutes or hours (255 minutes maximum), and the reminder timer is typically programmed for several seconds to a minute (255 seconds maximum).

If no reaction is taken when the radio begins beeping and the response timer is allowed to expire, the radio automatically enters the programmed emergency mode. Then, if the selected channel is programmed for Alarm or Alarm with Call emergency mode operations, it immediately begins alarm transmissions on the selected channel, or on a channel pre-assign for emergency communications. However, the radio does not transmit if the selected channel is not programmed for Alarm or Alarm with Call emergency mode operations.

Using Lone Worker

1. Enable (i.e., turn on) the Lone Worker feature if it is not already by pressing the programmed **Lone Worker** shortcut key. A high-pitched tone sounds to indicate the feature is enabled.
2. Select a channel programmed for Alarm or Alarm with Call emergency mode signaling. Consult with radio system administration personnel as necessary.
3. When the radio begins sounding reminder beeps, press any radio key to reset the response timer. If this timer is not reset before it times-out, the radio will begin alarm transmissions per radio programming. When transmitting, the LED indicator on the top of the radio lights red.
4. If the programmed emergency mode is Alarm with Call, the radio beeps once and enters a hot-mic period. The LED indicator lights red. During this time, speak into the radio's microphone to transmit voice audio on the channel. Pressing the PTT key is not necessary.
5. Next, the radio enters a receive period. During this time, listen for a voice reply to the alarm and/or voice transmission. Adjust volume as necessary.

The hot-mic and receive periods may be programmed to repeat one or more times.

EMERGENCY COMMUNICATIONS

6. To exit the emergency mode, thus ending alarm and voice transmissions early, press the Emergency Off shortcut key. If this shortcut key is not programmed, select another channel or cycle radio power to exit the emergency mode.

To disable (i.e., turn off) the Lone Worker feature, press the programmed **Lone Worker** shortcut key. A low-pitched tone sounds to indicate the feature is disabled.



If the Lone Worker feature is not disabled before the radio is powered off, it will remain enabled when the radio is powered on again.

MAN DOWN (OPTIONAL)

If installed in the radio, the Man Down feature can be used to automatically initiate an emergency when the radio is positioned aslant for a programmed period of time.

If the radio has this optional feature, the radio may be programmed to automatically enable the feature upon radio power-up. If a man down-capable radio is not programmed in this manner, the Man Down feature must be manually enabled before the feature will function.

Using Man Down

1. Enable the Man Down feature if it is not already by pressing the pre-programmed **Man Down** shortcut key. A high-pitched tone sounds to indicate the feature is enabled. A low-pitched tone sounds to indicate the feature is disabled. Refer to the previous section as necessary.
2. After the radio is positioned aslant for the preset period of time, it first sounds an alert tone. If it is not soon returned to a near vertical/upright position, it enters the emergency mode and automatically begins transmitting emergency alarm(s), as programmed.
3. To exit the emergency mode, thus ending the alarm transmission(s), return the radio to a (near) vertical/upright position.

HDC1200 SIGNALING

GENERAL INFORMATION

The HDC100 radio supports HDC1200 signaling. This signaling is compatible with MDC1200 signaling. It supports functions such as PTT ID signaling, emergency signaling, and signaling via selective call. These functions are supported in both encode and decode modes.

TRANSMISSION (ENCODE)

PTT ID Transmission

Along with voice audio, the radio can transmit an HDC1200-encoded identification (ID) number on the selected channel with each press of the radio's **PTT** key. This is commonly referred to a "PTT ID." Per radio programming, the ID number can be sent when the **PTT** key is pressed (before voice audio is transmitted), when the **PTT** key is released (after voice audio is transmitted), or both at press and release of the **PTT** key. The radio can be programmed to either sound a tone when it is transmitting the encoded signal or sound beeps after it has transmitted the encoded signal.

SECURE COMMUNICATIONS

GENERAL INFORMATION

The radio's Scrambler feature for analog channels can be used to reduce the likelihood of someone "eavesdropping" via analog radio channels. This feature employs analog voice inversion technology. This feature can be enabled and disabled on a per-channel basis.

The radio's Encrypt feature for digital channels can be used to prevent "eavesdropping" via the digital radio channel. This feature employs 256-bit digital AES encryption technology. This feature ensures the best guarantee of communication privacy. This feature can be enabled and disabled on a per-channel basis.

OPERATION

The Scrambler/Encrypt feature may be programmed to automatically enable when a channel is selected, or it may be manually enabled.

Manually Enabling and Disabling Scrambler/Encrypt

If the **Scrambler** or **Encrypt** shortcut key is programmed to a key, press this key to enable or disable the feature. A high-pitched tone sounds to indicate the feature is enabled. A low-pitched tone sounds to indicate the feature is disabled.

MISCELLANEOUS FEATURES

CHANNEL BUSY LOCKOUT

If enabled via the programming software, this feature can prevent the radio interfering with other transmitting radios on the same channel. If the PTT key is held down while the channel is in use, the radio will keep beeping, alerting of the transmission prohibition. To stop the beeping, release the PTT key. When the channel is free, press and hold down the PTT key to transmit.

TIME-OUT TIMER (TOT)

The purpose of Time-Out-Timer (TOT) is to prevent any user from occupying a channel for an extended period. If the preset time expires, the radio will automatically terminate transmission and keep beeping. To stop the beeping, release the PTT key. You must wait for a certain time period (preset by your dealer) to initiate another transmission. If the pre-alert function is set by your dealer, the radio will alert you to the TOT expiration in advance.



NOTE

This feature does not function when the radio is in an emergency mode.

PSEUDO TRUNKING

This feature can be enabled via the programming software. If the radio operates on a digital channel with this feature enabled and one digital time slot is already occupied, the radio can transmit and receive on the other free digital time slot. This feature allows communications to continue during busy periods.

MIC AGC

If enabled via the programming software, the radio will process the audio signals during transmission, providing improved audio for the receiving radio.

MISCELLANEOUS FEATURES

RADIO REGISTRATION SERVICE

If enabled by your dealer, the radio will automatically register in the system within a certain period after power-on. When registered, the radio can acquire online information about other radios by accessing specific servers within the valid registration period.

GPS REVERT

If enabled by your dealer, a registered radio will transmit GPS positioning information to the radio system when the system requests it.

ONE TOUCH CALL

The radio can be programmed by your radio dealer with the One Touch Call feature. This feature allows any one of the following pre-programmed calls via a programmed shortcut key:

- On an analog channel, send 5-tone signaling call to a contact.
- On an analog channel, send 2-tone signaling call to a contact.
- On a digital channel, send group calls or messages to the Group Call contact.
- On a digital channel, send private calls, messages or make control services to the Private Call contact. Control services include:

Alert Call  — Use the Alert Call command to send an alert call to a Private Call contact. The called party will see the alert and can then call you back.

Radio Check  — The Radio Check command is used to check a remote radio on the Private Call contact list, while not disturbing the contact/radio operator. This command can be used to confirm whether the called radio is powered on and on your selected channel.

MISCELLANEOUS FEATURES

Remote Monitor  — Use this Remote Monitor command to enable the microphone of a remote Private Call contact's radio. This can be used to remotely monitor voices and background sounds near the contact radio's microphone.

Radio Enable  — Use this Radio Enable command to enable the radio of a remote Private Call contact for normal use.

Radio Disable  — Use this Radio Disable command to disable the radio of a remote Private Call contact from normal use.

One Touch Call Operation

Consult with your radio dealer as necessary to determine specific programming and operation details specific to your radio. Basic operations include:

- To send a private call or a group call on a digital channel, select the channel, press the programmed **One Touch Call** shortcut key, and then hold down the **PTT** key and speak into the microphone to transmit voice audio. Release the **PTT** key when you finish speaking.
- To send a call on an analog channel, select the channel and then press the programmed **One Touch Call** shortcut key.
- To send a message on a digital channel, select the channel and then press the programmed **One Touch Call** shortcut key.
- To send control service commands on a digital channel, select the channel and then press the programmed **One Touch Call** shortcut key.

TELEMETRY

The Telemetry feature allows you to remotely supervise a device connected to a radio. With this feature, you can control the device and view its status remotely. The method for supervising the device is programmable by your dealer. These methods are described in the following subsections.

MISCELLANEOUS FEATURES

Supervise a Device via Another/Remote Radio

If a device is connected to a radio, you can use another/remote radio to supervise the device. All the radios involved should be configured with the Telemetry feature. For example, the dealer enables the Telemetry feature for both Radio A and Radio B, and assigns the Telemetry feature to the SK1 key on Radio A. To supervise the device C, connect it with Radio B, and press the SK1 key on Radio A.

Supervise a Device via Third-Party Software

If the Telemetry feature is enabled for the radio by your radio dealer, you can supervise the device connected with the radio via third-party software.

ROAM

This feature allows the radio to communicate between sites in the IP multisite-connected radio system. If enabled, the radio can communicate via any site in the multisite system, thus ensuring seamless radio communication in the system. Press the programmed **Roam** shortcut key to toggle roaming on or off.

TROUBLESHOOTING AND TECHNICAL ASSISTANCE

TROUBLESHOOTING TABLE

SYMPTOM	POSSIBLE PROBLEMS	SOLUTIONS
Radio will not turn on.	Battery is dead.	Charge or replace the battery. See page 9 and 10 for instructions.
	Battery is not properly attached to the radio.	Remove and then re-attach the battery to the radio. See page 10 for instructions.
	Battery is defective/bad.	Replace the battery with a fully-charged battery.
When receiving, voice audio is weak, erratic, or not present at all.	Volume is set too low.	Increase the volume with the On/Off Volume Control knob. See page 13.
	Antenna is not properly connected to the radio.	Turn the radio off, re-connect the antenna cable to the radio, and turn the radio back on.
	Antenna is damaged or not present.	Have your radio dealer repair/replace the antenna.
On an analog channel, you cannot communicate with others.	Speaker may be blocked or damaged.	Clean surface of the speaker. If the problem cannot be solved, contact your dealer or an authorized service center for inspection and repair.
	The frequency or signaling may not be the same as the other radios.	Verify selected channel is correct and/or consult with your radio dealer to verify the programming of the channel's frequency and signaling.
	Out-of-range (too far away) from other radios, or from the channel's respective repeater/base station.	Change your location. Moving a few yards/meters in one direction can sometimes greatly improve communications range.

TROUBLESHOOTING AND TECHNICAL ASSISTANCE

SYMPTOM	POSSIBLE PROBLEMS	SOLUTIONS
On an analog channel, irrelevant communications and/or noises are heard.	Other radios may be using the same radio frequency.	Adjust the squelch and/or consult with your radio dealer as necessary.
	The radio may be programmed without signaling, but signaling is needed.	Consult with your radio dealer as necessary.
On a digital channel, you cannot communicate with others but there is a receive indication.	The ID may be inconsistent with other members. (The digital signal is being received but not fully demodulated.)	Set the ID to the same as the other member's radios. Consult with your radio dealer as necessary.
Noisy communications.	Out-of-range (too far away from) of others, or from the channel's repeater/-base station.	Change your location. Moving a few yards/meters in one direction or moving to a higher elevation can sometimes greatly improve communications range.
	A nearby device, such as an electric motor or light bulb, is causing interference on the radio frequency/channel.	Change your location. Moving a few yards/meters in one direction can sometimes greatly improve communications.
Keypad does not operate.	The keypad has temporarily failed.	Restart the radio by turning it off and back on.
GPS cannot determine location/position.	The GPS antenna is improperly connected to the radio, or the antenna is damaged/missing.	Connect the antenna and/or consult with your radio dealer as necessary.
	No GPS signal is being received.	Change your location and re-check for a signal.

TROUBLESHOOTING AND TECHNICAL ASSISTANCE

TECHNICAL ASSISTANCE

When technical issues arise that cannot be resolved using the troubleshooting table, contact your radio equipment dealer for solution assistance. Also contact your radio equipment dealer for specific information about how the radio is programmed.

CARE AND CLEANING

To ensure optimal radio performance as well as a long radio service life, follow these care and cleaning tips:

RADIO CARE

- Review and follow all precautions described in the radio's *Product Safety Booklet*.
- Do not hold the radio by its antenna or by a cable connected to its accessory connector.
- Do not pierce or scrape the surface of the radio or its accessories.
- Always replace the accessory connector's cover when an accessory cable is not connected to the radio.
- Do not place the radio or any radio accessories in corrosive agents, solutions, gas mixers, or water.

RADIO CLEANING



Turn the radio **off** before cleaning it.

- On a regular basis, clean dust and fine particles from the radio and any accessories with a clean, dry, lint-free cloth or a fine brush.
- After long periods of use, gently clean the radio's keys, control knobs, and jacks/connectors with a non-woven fabric and a neutral-base cleanser or mild soap. Do not use chemical preparations such as stain removers, alcohol, sprays, or oils.
- Always allow the radio and its accessories to dry completely before turning the radio back on.

MODEL NUMBERS

RADIO PACKAGES

MODEL NUMBER	DESCRIPTION
HD-PBV1B	Momentum HDP100 Portable Radio, 136 to 174 MHz, with GPS and Standard Accessories
HD-PBV1B-MD	Momentum HDP100 Portable Radio, 136 to 174 MHz, with GPS, Man Down, and Standard Accessories
HD-PBV1B-TXR	Momentum HDP100 Portable Radio, 136 to 174 MHz, with GPS (radio only)
HD-PBV1B-MD-TXR	Momentum HDP100 Portable Radio, 136 to 174 MHz, with GPS, Man Down (radio only)
HD-PBU1B	Momentum HDP100 Portable Radio, 400 to 470 MHz, with GPS and Standard Accessories
HD-PBU1B-MD	Momentum HDP100 Portable Radio, 400 to 470 MHz, with GPS, Man Down and Standard Accessories
HD-PBU1B-TXR	Momentum HDP100 Portable Radio, 400 to 470 MHz, with GPS (radio only)
HD-PBU1B-MD-TXR	Momentum HDP100 Portable Radio, 400 to 470 MHz, with GPS, Man Down (radio only)
HD-PBU2B	Momentum HDP100 Portable Radio, 450 to 520 MHz, with GPS and Standard Accessories
HD-PBU2B-MD	Momentum HDP100 Portable Radio, 450 to 520 MHz, with GPS, Man Down and Standard Accessories
HD-PBU2B-TXR	Momentum HDP100 Portable Radio, 450 to 520 MHz (radio only)
HD-PBU2B-MD-TXR	Momentum HDP100 Portable Radio, 450 to 520 MHz, with GPS, Man Down (radio only)

MODEL NUMBERS



Standard accessories include one of each item pictured on page 5 (less the radio). Respective part numbers are listed in the tables that follow. Each radio is supplied with one (1) standard antenna, one (1) standard battery, one (1) standard battery charger with power adapter, and various carrying accessories as pictured on page 5.

ANTENNAS

MODEL NUMBER	DESCRIPTION	STANDARD/OPTIONAL
HD-AN6K-01	Antenna, 136 to 147 MHz, Long	Standard
HD-AN6K-02	Antenna, 136 to 174 MHz, Long	Standard
HD-AN6K-03	Antenna, 147 to 160 MHz, Long	Standard
HD-AN6K-04	Antenna, 160 to 174 MHz, Long	Standard
HD-AN6L-03	Antenna, 400 to 470 MHz, Stub	Standard
HD-AN6L-04	Antenna, 450 to 520 MHz, Stub	Standard

MODEL NUMBERS

BATTERIES AND BATTERY CHARGERS

MODEL NUMBER	DESCRIPTION	STANDARD/OPTIONAL
HD-PA2V	Battery, Lithium-Ion 2000 mAH	Standard
HD-PA2Y	Battery, Lithium-Ion 2500 mAH	Optional
HD-CH4D	Charger, Battery: 1-Bay with Power Adapter	Standard
HD-CH4F	Charger, Battery: 6-Bay	Optional
HD-PS2V	Power Supply, 6-Unit, Switching	Optional
HD-PS2T	Adapter, AC Power, 100 to 240 Vac at 50/60 Hz Input, 12 Vdc Output	Optional

CARRYING ACCESSORIES

MODEL NUMBER	DESCRIPTION	STANDARD/OPTIONAL
HD-HC3M	Clip, Belt	Standard
HD-HC3R	Strap, Wrist	Standard
HD-CL3N	Case, Leather with Swivel	Optional

MODEL NUMBERS

AUDIO ACCESSORIES

MODEL NUMBER	DESCRIPTION	STANDARD/OPTIONAL
HD-AE6P	Earpiece with On-Mic PTT	Optional
HD-AE6R	Earpiece with 3-Wire Surveillance Kit	Optional
HD-AE6S	D-Earset with In-Line Mic and PTT	Optional
HD-AE6U	Earbud with On-Mic PTT	Optional
HD-AE6V	Earbud, Receive-Only	Optional
HD-AE6W	Speaker-Mic, Waterproof	Optional
HD-AE6Y	Earpiece, Receive-Only	Optional
HD-AE6Z	Earpiece, 2-Wire, Wireless Earphone/Neck	Optional

WARRANTY REGISTRATION AND WARRANTY

WARRANTY REGISTRATION

Please register this product within ten (10) days of purchase. Registration validates the warranty coverage, and enables Harris to contact you in case of any safety notifications issued for this product.

Registration can be made on-line at <http://www.pspc.harris.com/Service/WarrantySupport.asp>.

EQUIPMENT AND RECHARGEABLE BATTERY WARRANTY

- A. Harris Corporation, a Delaware Corporation, acting through its RF Communications Division (hereinafter "Seller") warrants to the original purchaser for use (hereinafter "Buyer") that Momentum™ Equipment manufactured by or for the Seller shall (i) be free from all defects in material, workmanship and title; and (ii) comply with all of the Momentum™ Equipment Product Specifications. For purposes of this warranty, batteries shall be deemed defective if: (1) the battery capacity is less than 80% rated capacity, or (2) the battery develops leakage.
- B. Seller's obligations set forth in Paragraph C below shall apply only to Momentum™ Equipment failures to meet the above warranties occurring within the following periods of time from the date of sale to the Buyer and are conditioned on Buyer's giving written notice to Seller within thirty (30) days of such occurrence:
 - 1. for portable radios, mobile radios, repeaters and base stations, thirty-six (36) months (except as noted in paragraph B.2 and B.3);
 - 2. rechargeable batteries and accessories, twelve (12) months; and,
 - 3. all other parts, ninety (90) days.
- C. If any Momentum™ Equipment fails to meet the foregoing warranties, Seller shall correct the failure at its option (i) by repairing any defective or damaged part or parts thereof, or (ii) by replacing the failed Momentum™ Equipment with equivalent new or refurbished Equipment. Any repaired or replacement products or parts furnished hereunder shall be warranted for the balance of the original applicable Product Warranty Period or one hundred eighty (180) days for Products (other than batteries, accessories and parts) and ninety (90) days for batteries and accessories, whichever ends later. Where such failure cannot be corrected by Seller's reasonable efforts, the parties will negotiate an equitable adjustment in price. Labor to perform warranty service will be provided at no charge during the warranty period only for the Equipment

WARRANTY REGISTRATION AND WARRANTY

covered under Paragraph B. To be eligible for no-charge labor, service must be performed at Seller's location or other Servicer approved by Seller in writing to make the specific repairs at its place of business during normal business hours. Seller shall pay all freight charges relating to the return and shipment of the defective Products and the repaired or replacement Products to and from the Seller designated location. If it is determined that the Products are not under warranty, Buyer shall pay all freight charges related to the return and shipment of the Products and the repaired or replacement Products to and from the Seller designated location.

- D. Seller's obligations under Paragraph C shall not apply to any Equipment or part thereof, which:
1. has a defect that is not reported during the Product Warranty Period;
 2. is disassembled, modified, altered or repaired other than pursuant to Seller's written instructions or other written approval by Seller;
 3. is not installed, operated or maintained in accordance with written instructions provided by Seller;
 4. has its serial number removed or altered;
 5. is not properly stored or suffers detrimental exposure or is treated with abuse, negligence or other improper treatment; or,
 6. is damaged in an accident or in a natural disaster (earthquake, storm, flood, fire or other natural disaster).
- E. The preceding paragraphs set forth the exclusive remedies for claims based upon defects in or nonconformity of the Momentum™ Equipment, whether the claim is in contract, warranty, tort (including negligence), strict liability or otherwise and however instituted. Upon the expiration of the warranty period, all such liability shall terminate. The foregoing warranties are exclusive and in lieu of all other warranties, whether oral, written, expressed, implied or statutory. **NO IMPLIED OR STATUTORY WARRANTIES OF MERCHANTABILITY OR FITNESS FOR PARTICULAR PURPOSE SHALL APPLY. IN NO EVENT SHALL THE SELLER BE LIABLE FOR ANY INCIDENTAL, CONSEQUENTIAL, SPECIAL, INDIRECT OR EXEMPLARY DAMAGES.**

This warranty applies only within the United States.

Contact your local Harris Dealer to request warranty service.

ECR-7931