

Rear Cover of Manual

Front Cover of Manual

momentum™

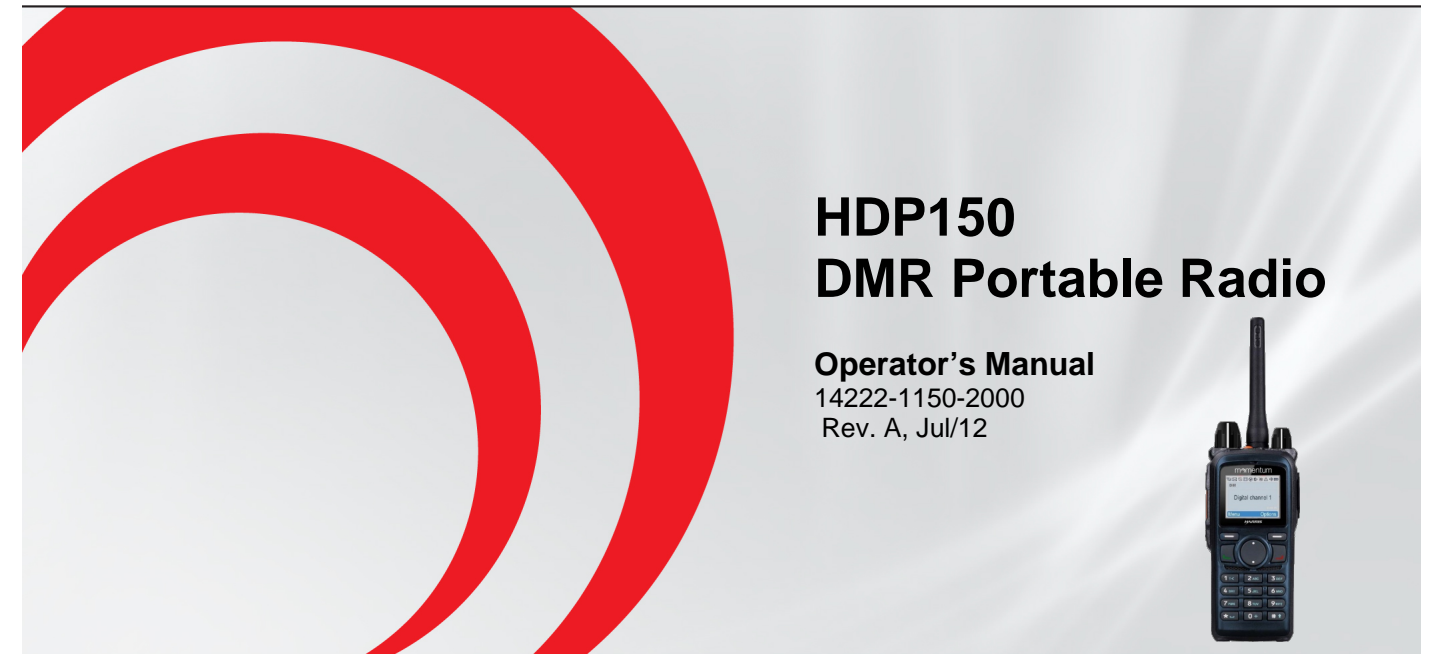

HARRIS
assuredcommunications*

Public Safety and Professional Communications
221 Jefferson Ridge Parkway | Lynchburg, VA USA 24501
www.pspc.harris.com | 1-800-528-7711

HARRIS

DMR
DIGITAL MOBILE RADIO ASSOCIATION

MANUAL REVISION HISTORY

| REV. | DATE | REASON FOR CHANGE |
|------|--------|--|
| – | Nov/11 | Initial release. |
| A | Jul/12 | Revised attachment procedure for accessory/programming cable and accessory model numbers. Added Equipment and Rechargeable Battery Warranty. |

Harris Corporation, Public Safety and Professional Communications (PSPC) Business continually evaluates its technical publications for completeness, technical accuracy, and organization. You can assist in this process by submitting your comments and suggestions to the following:

Harris Corporation fax your comments to: 1-434-455-6851
PSPC Business or email us at:
Technical Publications PSPC-TechPubs@harris.com
221 Jefferson Ridge Parkway
Lynchburg, VA 24501

ACKNOWLEDGEMENT

This device is made under license under one or more of the following US patents: 4,590,473; 4,636,791; 5,148,482; 5,185,796; 5,195,166; 5,271,017; 5,377,229; 4,716,407; 4,972,460; 5,502,767; 5,146,497; 5,164,986; 5,185,795; 5,226,084; 5,247,579; 5,491,772; 5,517,511; 5,581,656; 5,630,011; 5,649,050; 5,701,390; 5,715,365; 5,754,974; 5,826,222; 5,870,405; 6,161,089; 6,199,037 B1 and 6,912,495 B2. DVSI claims certain rights, including patent rights under aforementioned U.S. patents, and under other U.S. and foreign patents and patents pending. Any use of this software or technology requires a separate written license from DVSI.

CREDITS

Harris and assuredcommunications are registered trademarks of and Momentum is a trademark of Harris Corporation.

NOTICE!

The material contained herein is subject to U.S. export approval. No export or re-export is permitted without written approval from the U.S. Government. Rated: EAR99 in accordance with U.S. Dept. of Commerce regulations 15CFR774, Export Administration Regulations.

Publication 14222-1150-2000, Rev. A

iii

NOTICE!

Information and descriptions contained herein are the property of Harris Corporation. Such information and descriptions may not be copied or reproduced by any means, or disseminated or distributed without the express prior written permission of Harris Corporation, PSPC Business, 221 Jefferson Ridge Parkway, Lynchburg, VA 24501.

The voice coding technology embodied in this product is protected by intellectual property rights including patent rights, copyrights, and trade secrets of Digital Voice Systems, Inc. The user of this technology is explicitly prohibited from attempting to decompile, reverse engineer, or disassemble the Object Code, or in any other way convert the Object Code into human-readable form.

Repairs to this equipment should be made only by an authorized service technician or facility designated by the supplier. Any repairs, alterations or substitutions of recommended parts made by the user to this equipment not approved by the manufacturer could void the user's authority to operate the equipment in addition to the manufacturer's warranty.



This product conforms to the European Union WEEE Directive 2002/96/EC. Do not dispose of this product in a public landfill. Take it to a recycling center at the end of its life.

This manual is published by **Harris Corporation** without any warranty. Improvements and changes to this manual necessitated by typographical errors, inaccuracies of current information, or improvements to programs and/or equipment, may be made by **Harris Corporation** at any time and without notice. Such changes will be incorporated into new editions of this manual. No part of this manual may be reproduced or transmitted in any form or by any means, electronic or mechanical, including photocopying and recording, for any purpose, without the express written permission of **Harris Corporation**.

Copyright© 2011 — 2012, Harris Corporation

TABLE OF CONTENTS

| <u>Section</u> | <u>Page</u> |
|--|-------------|
| SYMBOLS USED IN THIS MANUAL | 1 |
| CAUTION AND NOTE SYMBOLS..... | 1 |
| SYMBOLS FOR ANALOG AND DIGITAL CHANNEL FEATURES/FUNCTIONS..... | 1 |
| REGULATORY INFORMATION | 2 |
| PRODUCT SAFETY BOOKLET..... | 2 |
| RF EXPOSURE GUIDELINES..... | 2 |
| ELECTROMAGNETIC INTERFERENCE..... | 3 |
| FCC Part 15 Statement..... | 4 |
| Industry Canada Statement..... | 4 |
| EU REGULATORY CONFORMANCE..... | 4 |
| CHECKING ITEMS IN THE PACKAGE | 5 |
| RADIO OVERVIEW | 6 |
| RADIO CONTROLS, INDICATORS, AND OTHER ITEMS..... | 6 |
| PROGRAMMABLE SHORTCUT KEYS..... | 7 |
| BEFORE USING THE RADIO | 10 |
| CHARGING THE BATTERY..... | 10 |
| ASSEMBLY AND DISASSEMBLY..... | 11 |
| Attaching and Removing the Antenna..... | 11 |
| Attaching the Battery..... | 11 |
| Removing the Battery..... | 11 |
| Attaching the Belt Clip..... | 12 |
| Removing the Belt Clip..... | 12 |
| Attaching the Audio Accessory/Programming Cable..... | 12 |
| Removing an Accessory/Programming Cable..... | 13 |
| RADIO STATUS INDICATORS | 14 |
| OPERATIONAL MODE AND STATUS ICONS THE DISPLAY..... | 14 |
| LED INDICATOR..... | 17 |

TABLE OF CONTENTS





| <u>Section</u> | <u>Page</u> |
|--|-------------|
| BASIC OPERATIONS | 18 |
| TURNING THE RADIO ON AND OFF | 18 |
| ADJUSTING THE VOLUME | 18 |
| SELECTING A ZONE..... | 18 |
| SELECTING A CHANNEL | 19 |
| SWITCHING THE CHANNEL MODE BETWEEN ANALOG AND DIGITAL | 19 |
| LOCKING AND UNLOCKING THE KEYPAD | 19 |
| HOME SCREEN..... | 20 |
| PRIVATE CALLS  | 20 |
| Transmitting a Private Call | 20 |
| Receiving and Responding to a Private Call..... | 22 |
| GROUP CALLS  | 23 |
| Transmitting a Group Call | 23 |
| Receiving and Responding to a Group Call | 24 |
| ALL CALLS  | 25 |
| Transmitting an All Call | 25 |
| Receiving an All Call..... | 25 |
| TALK-AROUND (DIRECT MODE) | 25 |
| CALLS ON ANALOG CHANNELS  | 26 |
| Transmitting a Call on an Analog Channel..... | 26 |
| Receiving a Call on an Analog Channel | 26 |
| Monitor | 26 |
| Squelch Off..... | 27 |
| Telephone Interconnect Calls | 27 |
| BATTERY STRENGTH INDICATOR | 29 |
| MENU NAVIGATION | 30 |
| MAIN MENU | 30 |
| CONTACT MENU  | 30 |

TABLE OF CONTENTS



| <u>Section</u> | <u>Page</u> |
|--|-------------|
| Contact List | 30 |
| New Contact | 31 |
| Manual Dial | 31 |
| MESSAGE MENU  | 32 |
| New Msg | 32 |
| Quick Text | 32 |
| InBox | 32 |
| OutBox | 32 |
| Drafts | 33 |
| CALL LOGS MENU  | 33 |
| PHONE MENU | 34 |
| Phone List | 34 |
| Manual Dial | 34 |
| DTMF Keypad | 34 |
| ROAMING MENU | 34 |
| SCAN MENU | 35 |
| Scan On/Off | 35 |
| Scan List | 35 |
| ZONE MENU | 36 |
| SETTINGS MENU | 36 |
| Radio Set | 36 |
| Device Info | 39 |
| ACCESSORIES MENU | 40 |
| GPS | 40 |
| SCANNING CHANNELS | 42 |
| GENERAL INFORMATION | 42 |
| OPERATION | 42 |
| Turning Scan On and Off | 42 |

TABLE OF CONTENTS





| <u>Section</u> | <u>Page</u> |
|--|-------------|
| Pausing Scan  | 43 |
| Nuisance Temporary Delete | 43 |
| EMERGENCY COMMUNICATIONS..... | 44 |
| GENERAL INFORMATION | 44 |
| Emergency Mode | 44 |
| Emergency Type | 45 |
| Emergency ID Type  | 45 |
| Emergency Operations on Analog Channels  | 46 |
| Emergency Operations on Digital Channels  | 48 |
| LONE WORKER | 50 |
| Enabling and Disabling Lone Worker | 50 |
| Using Lone Worker | 51 |
| MAN DOWN (OPTIONAL) | 52 |
| Manually Enabling and Disabling Man Down | 52 |
| Using Man Down | 52 |
| HDC1200 SIGNALING | 53 |
| GENERAL INFORMATION | 53 |
| TRANSMISSION (ENCODE) | 53 |
| PTT ID Transmission | 53 |
| Private/Group/All Call Transmission (Selective Call via Contact List) | 53 |
| RECEPTION (DECODE) | 54 |
| Indications for Received PTT IDs | 54 |
| Indications for Received Private/Group/All Calls | 54 |
| SECURE COMMUNICATIONS..... | 55 |
| GENERAL INFORMATION | 55 |
| OPERATION | 55 |
| Manually Enabling and Disabling Scrambler/Encrypt | 55 |

TABLE OF CONTENTS





| <u>Section</u> | <u>Page</u> |
|--|-------------|
| MISCELLANEOUS FEATURES | 56 |
| CHANNEL BUSY LOCKOUT | 56 |
| TIME-OUT TIMER (TOT)..... | 56 |
| PSEUDO TRUNKING  | 56 |
| MIC AGC | 56 |
| RADIO REGISTRATION SERVICE  | 57 |
| GPS REVERT  | 57 |
| ONE TOUCH CALL | 57 |
| One Touch Call Operation..... | 57 |
| TELEMETRY  | 58 |
| Supervise a Device via Another/Remote Radio..... | 58 |
| Supervise a Device via Third-Party Software..... | 58 |
| ROAM  | 58 |
| 5-TONE SIGNALING..... | 59 |
| 5-Tone Signaling Encode | 59 |
| 5-Tone Signaling Decode..... | 59 |
| 2-TONE SIGNALING..... | 60 |
| 2-Tone Signaling Encode | 60 |
| 2-Tone Signaling Decode..... | 60 |
| ENTERING LETTERS, NUMBERS, AND OTHER CHARACTERS VIA THE KEYPAD | 60 |
| Upper and Lower Case Letters | 60 |
| Numbers | 61 |
| Punctuation Characters and Special Characters..... | 61 |
| TROUBLESHOOTING AND TECHNICAL ASSISTANCE | 62 |
| TROUBLESHOOTING TABLE | 62 |
| TECHNICAL ASSISTANCE..... | 64 |
| CARE AND CLEANING | 65 |
| RADIO CARE | 65 |



TABLE OF CONTENTS

| <i>Section</i> | <i>Page</i> |
|--|-------------|
| RADIO CLEANING | 65 |
| MODEL NUMBERS..... | 66 |
| RADIO PACKAGES | 66 |
| ANTENNAS | 67 |
| BATTERIES AND BATTERY CHARGERS | 68 |
| CARRYING ACCESSORIES..... | 68 |
| AUDIO ACCESSORIES | 69 |
| WARRANTY REGISTRATION AND WARRANTY..... | 70 |
| WARRANTY REGISTRATION..... | 70 |
| EQUIPMENT AND RECHARGEABLE BATTERY WARRANTY..... | 70 |



SYMBOLS USED IN THIS MANUAL

The following tables list symbols used in this manual. These symbols do not appear in the radio's display.

CAUTION AND NOTE SYMBOLS

| SYMBOL | DESCRIPTION |
|--|--|
|  WARNING | The WARNING symbol calls attention to a procedure, practice, or the like, which, if not correctly performed or adhered to, could result in personal injury. Do not proceed beyond a WARNING symbol until the conditions identified are fully understood or met. |
|  CAUTION | The CAUTION symbol calls attention to an operating procedure, practice, or the like, which, if not performed correctly or adhered to, could result in damage to the equipment or severely degrade equipment performance. |
|  NOTE | The NOTE symbol calls attention to supplemental information, which may improve system performance or clarify a process or procedure. It may also be used to flag tips that can help you make better use of the radio. |

SYMBOLS FOR ANALOG AND DIGITAL CHANNEL FEATURES/FUNCTIONS

| SYMBOL | DESCRIPTION |
|---|--|
|  | The DIGITAL CHANNEL symbol indicates the particular feature or function applies to digital channels only. |
|  | The ANALOG CHANNEL symbol indicates the particular feature or function applies to analog channels only. |

If no digital channel or analog channel symbol appears, the function/feature applies to both analog channels and digital channels.

REGULATORY INFORMATION

PRODUCT SAFETY BOOKLET



Before operating the HDP150 portable radio, read the safety and RF exposure guidelines contained in Product Safety Booklet included with the radio.

RF EXPOSURE GUIDELINES



The HDP150 portable radio generates RF electromagnetic energy during transmit mode. This radio is designed for and classified as “Occupational Use Only,” meaning it must be used only during the course of employment by individuals aware of the hazards and the ways to minimize such hazards. This radio is NOT intended for use by the “General Population” in an uncontrolled environment.

The HDP150 radio has been tested and complies with the Federal Communications Commission (FCC) RF exposure limits for “Occupational Use Only.” In addition, this radio complies with the following Standards and Guidelines with regard to RF energy and electromagnetic energy levels and evaluation of such levels for exposure to humans:

- FCC Office of Engineering and Technology (OET) Bulletin 65 Edition 97-01 Supplement C, Evaluating Compliance with FCC Guidelines for Human Exposure to Radio Frequency Electromagnetic Fields.
- American National Standards Institute (C95.1 – 1992), IEEE Standard for Safety Levels with Respect to Human Exposure to Radio Frequency Electromagnetic Fields, 3 kHz to 300 GHz.
- American National Standards Institute (C95.3 – 1992), IEEE Recommended Practice for the Measurement of Potentially Hazardous Electromagnetic Fields – RF and Microwave.

REGULATORY INFORMATION



To ensure exposure to RF electromagnetic energy is within the FCC allowable limits for occupational use, always adhere to the following guidelines:

- DO NOT operate the radio without a proper antenna attached, as this may damage the radio and may also cause the FCC RF exposure limits to be exceeded. A proper antenna is the antenna supplied with this radio by Harris or an antenna specifically authorized by Harris for use with this radio. These antennas are listed on page 67.
- DO NOT transmit for more than 50% of total radio use time (“50% duty cycle”). Transmitting more than 50% of the time can cause FCC RF exposure compliance requirements to be exceeded. The radio is transmitting when the LED indicator on the top of the radio lights red in color. The radio transmits when its “PTT” (Push-To-Talk) key is pressed.
- Always transmit using low power when possible. In addition to conserving battery charge, low power can reduce RF exposure. Refer to page 36 for additional information.
- ALWAYS use Harris authorized accessories (antennas, batteries, belt clips, speaker/mics, etc). Use of unauthorized accessories may cause the FCC Occupational/Controlled Exposure RF compliance requirements to be exceeded.
- ALWAYS keep the device and its antenna at least 1 inch (2.5 centimeters) from the body and face when transmitting to ensure FCC RF exposure compliance requirements are not exceeded. To provide the best sound quality to the recipients of your transmission, Harris recommends holding the front of the radio between 1 and 2 inches (2.5 to 5.0 centimeters) from your mouth when transmitting into the radio’s microphone.

ELECTROMAGNETIC INTERFERENCE

During transmissions, this radio generates RF energy that can possibly cause interference with other devices or systems. To avoid such interference, turn off the radio in areas where signs are posted to do so. DO NOT

Publication 14222-1150-2000, Rev. A

REGULATORY INFORMATION

operate the transmitter in areas that are sensitive to electromagnetic radiation such as hospitals, aircraft, and blasting sites.

FCC Part 15 Statement

This device complies with Part 15 of the FCC Rules. Operation is subject to the following two conditions:

1. This device may not cause harmful interference, and
2. This device must accept any interference received, including interference that may cause undesired operation.

Industry Canada Statement

This device complies with Industry Canada license-exempt RSS standard(s). Operation is subject to the following two conditions: (1) this device may not cause interference, and (2) this device must accept any interference, including interference that may cause undesired operation of the device.

Le présent appareil est conforme aux CNR d'Industrie Canada applicables aux appareils radio exempts de licence. L'exploitation est autorisée aux deux conditions suivantes : (1) l'appareil ne doit pas produire de brouillage, et (2) l'utilisateur de l'appareil doit accepter tout brouillage radioélectrique subi, même si le brouillage est susceptible d'en compromettre le fonctionnement.







EU REGULATORY CONFORMANCE

As certified by the qualified laboratory, the product is in compliance with the essential requirements and other relevant provisions of the Directive 1999/5/EC. Please note that the above information is applicable to EU countries only.

CE0678!

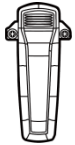
CHECKING ITEMS IN THE PACKAGE

Carefully unpack and check that all items listed below are received. If any item is missing or damaged, please immediately contact your dealer.

| | | | |
|--|---|--|--|
|  <p>Antenna</p> |  <p>Operator's Manual, Product Safety Booklet, Quick Guide</p> |  <p>Power Adapter</p> |  <p>Belt Clip</p> |
|  <p>Radio</p> |  <p>Battery</p> |  <p>Battery Charger</p> |  <p>Wrist Strap</p> |



NOTE

The antenna may vary with different frequency bands. The frequency band is marked on the label of antenna. If not, refer to the label on the radio unit for frequency band information.



RADIO OVERVIEW







RADIO CONTROLS, INDICATORS, AND OTHER ITEMS

| ITEM | NAME | | ITEM | NAME |
|------|------------------------------|--|------|----------------------------|
| 1 | Side Key 1 (SK1) | | 12 | LED Indicator |
| 2 | PTT Key | | 13 | Antenna |
| 3 | Side Key 2 (SK2) | | 14 | On/Off/Volume Control Knob |
| 4 | Top Key (TK) | | 15 | Accessory Jack |
| 5 | Channel Selector Knob | | 16 | Back Key |
| 6 | Microphone | | 17 | Programmable Key (Right) |
| 7 | Liquid Crystal Display (LCD) | | 18 | Up Key |
| 8 | Select/Menu Key | | 19 | Down Key |
| 9 | Programmable Key (Left) | | 20 | Battery Latch |
| 10 | Speaker | | 21 | Belt Clip |
| 11 | Keypad | | 22 | Battery |

RADIO OVERVIEW







PROGRAMMABLE SHORTCUT KEYS

For enhanced convenience, you may request your dealer pre-program keys SK1, SK2, TK,  and  as shortcuts to any of the functions listed in this table:

| NO. | SHORTCUT NAME | SHORTCUT KEY FUNCTION |
|-----|---|---|
| 1 | Zone Up | Change to another zone. See pages 18 or 36. |
| 2 | Zone Down | |
| 3 | Keypad Lock | Lock or unlock the keypad. See page 19. |
| 4 | Contact List  | Quick access the Contact list. See page 30. |
| 5 | Message  | Quick access to Message menu. See page 31. |
| 6 | Call Logs  | Quick access to Call Logs menu. See page 33. |
| 7 | Adjust Power Level | Quickly change the radio's transmitting power level. See page 36. |
| 8 | Talk-Around | Directly communicate with other radios. See page 25. |
| 9 | Monitor  | Toggle receiver muting on and off. See page 26. |
| 10 | Monitor Momentary  | Momentarily turn receiver muting off. See page 26. |
| 11 | Squelch Off  | Toggle squelch on and off. When off, the radio always unmutes so if no radio carrier is present on the channel, receiver noise is heard. See page 27. |
| 12 | Squelch Off Momentary  | Momentarily turn squelch off. Otherwise, same as above. See page 27. |
| 13 | Home Screen | Quickly return to the previous menu or home screen. See page 20. |
| 14 | Scan | Enable and disable scanning. See page 42. |

(Table Continued on Next Page)

RADIO OVERVIEW

| NO. | SHORTCUT NAME | SHORTCUT KEY FUNCTION |
|-----|--|--|
| 15 | Nuisance Temporary Delete | Temporarily skip unwanted channel activity during scanning. See page 43. |
| 16 | Emergency On | Turn on the emergency mode and transmit emergency call/signaling. See page 44. |
| 17 | Emergency Off | Turn off the emergency call/signaling, exiting emergency mode. See page 44. |
| 18 | Lone Worker | Toggle the Lone Worker feature on and off. See page 50. |
| 18 | Adjust Squelch Level  | Temporarily adjust the receiver squelch threshold. See page 36. |
| 19 | Battery Strength Indicator | Display remaining battery strength. See page 29. |
| 20 | Man Down (Optional Feature) | Activate this emergency feature so if the radio is positioned at an angle for a preset period of time, it will begin emergency transmissions. See page 52. |
| 21 | Scrambler  Encrypt  | Scrambler: Encrypt voice transmissions for secure communications. Encrypt: Encrypt voice and message transmissions for secure communications. See page 53. |
| 22 | One Touch Call (1 though 5)  | Quickly make calls or send messages. See pages 57, 59, and 60. |
| 23 | Status  | Quickly access the Status List menu. |
| 24 | Telemetry  | To supervise remote devices. See page 58. |
| 25 | DTMF Keypad | To enter or exit DTMF keypad mode. In this mode, phone numbers can be entered via the radio's keypad. See pages 24, 27, and 34. |

(Table Continued on Next Page)

RADIO OVERVIEW

| NO. | SHORTCUT NAME | SHORTCUT KEY FUNCTION |
|------------|----------------------|--|
| 26 | Phone List | To access the Phone List menu quickly. See pages 27 or 34. |
| 27 | Roam | To enable and disable the Roam feature. See page 58. |







Long and short presses of a key can be programmed with different functions by your dealer.
The Top Key (TK) is programmed as the emergency key by default. It may be reprogrammed by your dealer.

BEFORE USING THE RADIO

CHARGING THE BATTERY

Follow this procedure to charge the radio's battery:

1. Connect the AC power adapter to an AC power source. See arrow ①.
2. Plug the small plug of the power adapter into the jack at the rear of the charger. See arrow ②.
3. Place the radio with the battery attached, or just the battery alone, into the slot in the top of the charger. See arrow ③.
4. Refer to the following table for charge status, as indicated by the charger's status indicator.

| STATUS INDICATOR | | CHARGE STATUS |
|---------------------|---|---------------------------------|
| Flashes Red Slowly |  | Standby (No Load/No Battery) |
| Glowes Red |  | Battery Charging |
| Flashes Red Rapidly |  | Battery or Charger Failure |
| Glowes Orange |  | Battery 90% Charged |
| Glowes Green |  | Battery Fully Charged |



Read the radio's Product Safety Booklet for related information.

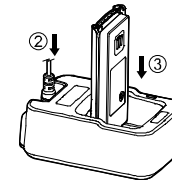
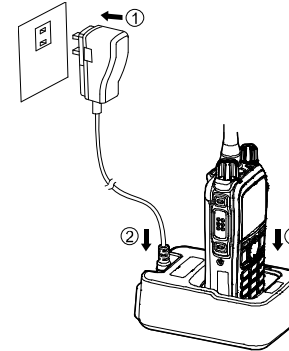

To achieve optimal battery performance, charge the battery five (5) hours before its initial use.

BEFORE USING THE RADIO

ASSEMBLY AND DISASSEMBLY

Attaching and Removing the Antenna

To attach the antenna to the radio, place its base into the antenna jack on the top of the radio and turn the antenna in a clockwise direction.

To remove the antenna from the radio, simply turn the antenna in a counter-clockwise direction until it is free from the radio.

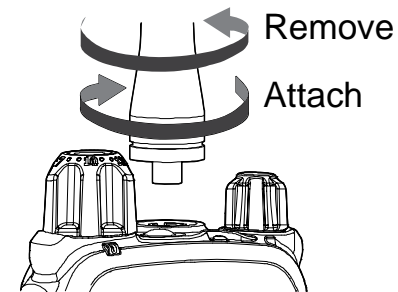

Attaching the Battery

To attach the battery to the radio:

1. Slide the top of the battery completely into the cavity at the rear of the radio. See arrow ①.
2. Gently press on the bottom of the battery until a click is heard. See arrow ②. This locks the battery to the radio.

Removing the Battery

To remove the battery from the radio:

1. Turn off the radio by rotating its on/off/volume control to the full counter-clockwise position.
2. Grasp the radio firmly in one hand in a bottoms-up position.
3. Using the other hand, slide the battery latch up to unlatch the battery, and remove the battery from the radio.

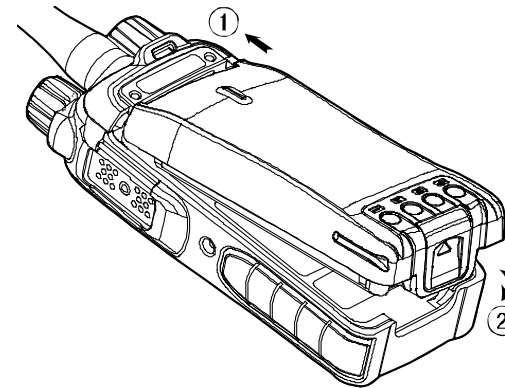

BEFORE USING THE RADIO

Attaching the Belt Clip

To attach the belt clip to the radio:

1. Remove the two (2) screws on the rear of the radio.
2. As illustrated, align the screw holes on the belt clip with those on the radio and re-install the two screws into the holes.
3. Using a small screwdriver, tighten the two screws securely. Do not over-tighten them.

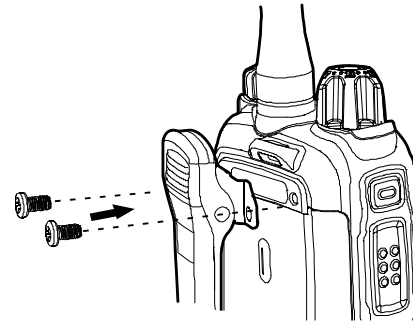

Removing the Belt Clip

To remove the belt clip, use a small screwdriver to loosen and remove the two (2) screws that secure the clip to the radio, and then remove it from the radio.

Attaching the Audio Accessory/Programming Cable

To attach an audio accessory or a programming cable to the radio:

1. Open the accessory jack cover, as illustrated by arrow ①.
2. Align the threaded portion of the cable's screw with the threaded hole in the center of the jack.



Do not scrape the silicon rubber on the accessory jack. Scrapes/Scratches in this area could permanently affect the waterproof performance of the radio. **Correct and incorrect alignment is shown in the illustration on the next page.**

3. Join the screw to the thread hole and tighten the screw by the knob on the cable's plug. See arrow ②.

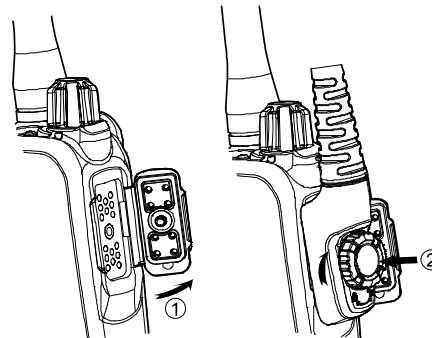

BEFORE USING THE RADIO

**CORRECT
ALIGNMENT**

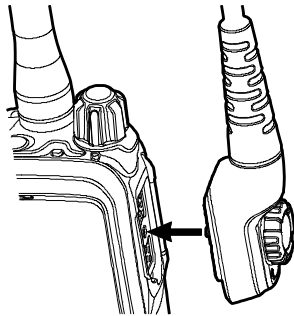

**INCORRECT
ALIGNMENT**

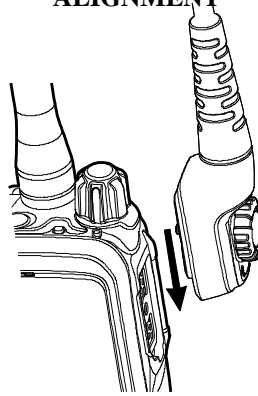

**INCORRECT
ALIGNMENT**

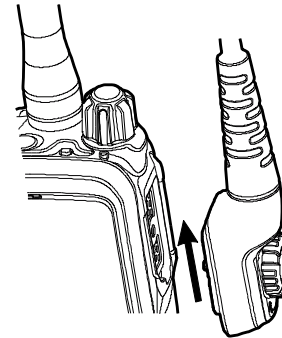

When an external accessory is attached to the radio's accessory jack, waterproof performance of the radio may be affected.





Removing an Accessory/Programming Cable

To remove a cable from the radio's accessory jack, simply loosen its screw and detach the cable from the jack.







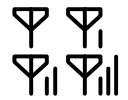

RADIO STATUS INDICATORS

OPERATIONAL MODE AND STATUS ICONS THE DISPLAY







The radio has two (2) operational mode icons and multiple status icons that appear in its display. These icons are illustrated and described in the following table.

| ICON NAME | ICON | DESCRIPTION |
|------------------------|---|--|
| Direct Mode | DM | This operational mode icon indicates the radio is operating in direct mode. In this mode, radios communicate with each other directly. This mode is also referred to as “talk around.” |
| Repeater Mode | RM | This operational mode icon indicates the radio is operating in repeater mode. In this mode, radios communicate with each other via a repeater (i.e., radio base station equipment). |
| Monitor Icon |  | The monitor feature is active. See page 26 for additional information. |
| Speaker Icon |  | The speaker is unmuted. |
| Emergency Icon |  | The Emergency mode (other than secret emergency) is active or an emergency message has been received. |
| Battery Strength Icons |  | These icons indicate the relative strength of the battery. An icon with more bars indicates more remaining battery operating time. No bars and beeps indicates the battery needs charging immediately. |
| Accessory Icon |  | This icon appears in the display when an accessory is connected to the radio’s accessory connector. |

RADIO STATUS INDICATORS

| ICON NAME | ICON | DESCRIPTION |
|---------------------------------|---|---|
| RSSI Icons |  | This RSSI icon indicates no radio signal is being received. RSSI icons appear in the upper left corner of the display. RSSI stands for Received-Signal Strength Indication. |
| |  | More bars on an RSSI icon indicate better signal strength. |
| Transmit (Tx) Power Level Icons |  | Low transmit power for the selected channel. |
| |  | High transmit power for the selected channel. |
| Message Icons |  | New message/unread message. |
| |  | InBox is full. |
| Scan Icons |  | Scanning. |
| |  | Scanning is paused on a non-priority channel. |
| |  | Scanning is paused on the priority 1 channel. |
| |  | Scanning is paused on the priority 2 channel. |







RADIO STATUS INDICATORS

| ICON NAME | ICON | DESCRIPTION |
|----------------------------|---|---|
| GPS Icons |  | The GPS feature is active and valid GPS data is being received. |
| |  | The GPS feature is active but no valid GPS data is being received. |
| Scrambler/ Encrypt Icon |  | The Scrambler/Encrypt feature is enabled/active. |
| Missed Call Icon |  | A call has been missed. |
| DTMF Keypad Icon |  | Dual-Tone Multi-Frequency (DTMF) keypad entry mode is enabled/on, so numbers can be entered via the radio's keypad. |
| Roam Icon |  | The radio is roaming. |

RADIO STATUS INDICATORS

LED INDICATOR

A light-emitting diode (LED) type status indicator is located on the top of the radio, near the On/Off/Volume Control Knob. This indicator can be quickly viewed to determine the basic operational status of the radio. Each status indication is described in the table at the right.

| LED INDICATOR | RADIO STATUS |
|---|--|
| Flashing Green  | Powering on |
| Glowing Red  | Transmitting |
| Glowing Green  | Receiving |
| Flashing Orange Slowly (approximately once every 2 sec.)  | Scanning |
| Flashing Orange Rapidly (approximately twice every 1 sec.)  | Emergency |
| Glowing Orange  | After voice communication ends, it is OK to transmit voice audio by pressing the PTT key and speaking into the microphone. |

BASIC OPERATIONS

TURNING THE RADIO ON AND OFF

To turn on the radio, rotate its **On/Off Volume Control** knob clockwise out of the detent position. A click will be sensed. The radio responds by displaying its power-up screen and its LED status indicator flashes green. This knob is item 13 on page 6.





To turn the radio off, rotate this knob fully counter-clockwise until the detent click is sensed.

ADJUSTING THE VOLUME

After turning the radio on, rotate the **On/Off Volume Control** knob clockwise to increase the volume and rotate it counter-clockwise to decrease the volume. Volume adjustment can be made at anytime later in the same manner. This knob is item 13 on page 6.

SELECTING A ZONE

A zone is a group of pre-programmed radio channels exhibiting similar properties. The radio supports up to 64 zones and each zone can have up to 16 channels. Zones and channels are pre-programmed into the radio by your dealer. Select a zone using either of the following methods:

- **Menu Selection Method** — From the home screen, press the **Menu** key, select **Zone**, then use the **Up/Down** key to select the desired zone from the menu.
- **Pre-Programmed Shortcut Keys Method** — If pre-programmed by your dealer, quickly switch to a desired zone by pressing the programmed **Zone Up** or **Zone Down** shortcut key. Keys SK1, SK2, TK,  or  may be pre-programmed by your dealer as Zone Up and Zone Down shortcut keys. The SK1, SK2, TK,  or  are illustrated on page 6.

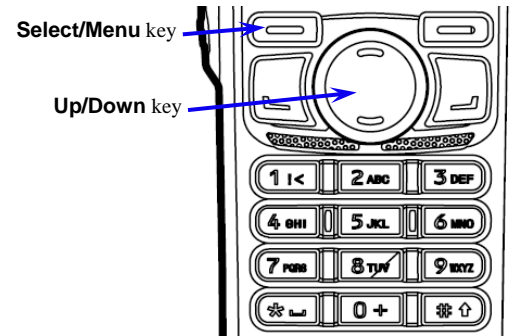

BASIC OPERATIONS

SELECTING A CHANNEL

The radio's **Channel Selector** knob is located on the top of the radio. It is item 5 on page 6. Rotate this knob to select the desired channel within the zone. The name of the selected channel appears in the display.

This knob has 16 positions, for a total of 16 channels per zone. Some knob positions may not be programmed with a channel.

The number of the newly selected channel will be announced from the radio's speaker in a synthesized voice if the radio's Channel Notify feature is enabled. If desired, enable or disable this feature from the Channel Notify menu by selecting: **Menu > Settings > Radio Set > Tone > Channel Notify > Enable or Disable**.

SWITCHING THE CHANNEL MODE BETWEEN ANALOG AND DIGITAL

Each channel can be pre-programmed as either an analog channel or a digital channel. If the currently selected zone includes both analog and digital channels, the **Channel Selector** knob can be used to quickly switch between analog and digital channels. Select the desired channel by rotating the knob to the respective position.

LOCKING AND UNLOCKING THE KEYPAD

The radio's keypad can be locked to prevent unintentional key activations. Lock and unlock the keypad using one of the following methods:

- Press the **Select/Menu** and ***↵** keys simultaneously. Each press toggles between locked and unlocked.
- If programmed, press the key **Keypad Lock** shortcut key. Each press toggles between locked and unlocked. See page 7 for additional information on programmable keys.
- From the Keypad Lock menu select: **Setting > Radio Settings > Keypad Lock > Enable or Disable**. If enabled, the keypad will lock automatically within the preset time period if no operation is made. If disabled, the keypad will not lock automatically. However, it can be manually locked or unlocked via the **Select/Menu** and ***↵** keys, or if pre-programmed, via the **Keypad Lock** shortcut key.

BASIC OPERATIONS



When the Keypad Auto Lock feature is enabled, the keypad will automatically lock if no operation is made within the pre-programmed time period. The Keypad Auto Lock feature can be disabled via the Keypad Lock menu.

HOME SCREEN

The home screen is the default operating screen. It indicates the name of the selected zone, the name of the selected channel, battery strength, and other parameters of the selected channel (via icons) such as if the channel is a repeater vs. a direct mode channel, the current transmit power level, receive signal strength, etc.

To return to the home screen from any menu screen, simply press the **Back** key one or more times. Alternately, if the **Home Screen** shortcut key is pre-programmed, press it to exit the menu screen and immediately return to the home screen. In an editing screen, press the **Home Screen** shortcut key to exit and immediately return to the previously selected menu.

PRIVATE CALLS

A private call is a call initiated by a radio user to another radio user.

Transmitting a Private Call



When transmitting a private call, the  icon appears in the display. A private call can be transmitted using a method described in the following subsections.



When transmitting (i.e., **PTT** key depressed), hold the front of the radio between 1 to 2 inches from your mouth and speak into the microphone at a normal voice level. This will ensure optimal reception at the receiving radio unit(s). Never shout or whisper when transmitting. As illustrated on page 6, the radio's microphone is located just above the display.

BASIC OPERATIONS

Transmitting a Private Call to the Preset Contact

While in the home screen, hold down the radio's **PTT** key to transmit a private call to the Private Call contact preset for the currently selected channel. Release the **PTT** key to stop transmitting, and listen for a reply. See *Receiving and Responding to a Private Call* for additional information.



Each digital channel may be pre-programmed with a preset contact by your dealer. The preset contact can be a Private Call contact, a Group Call contact, or an All Call contact.

Transmitting a Private Call via the Contact List or Call Logs

1. While in the home screen, press the **Menu** key.
2. Select Contact > Contact List. Alternately, go to Call Logs and access the Outgoing/Incoming/Missed list.
3. Press the **Up/Down** key to select the Private Call contact desired for calling. In this list, each Private Call contact name is preceded by a  icon.
4. Hold down the **PTT** key to transmit a private call to the selected contact, and speak into the microphone at a normal voice level.
5. Release the **PTT** key to stop transmitting, and listen for a reply. See *Receiving and Responding to a Private Call* for additional information.

Transmitting a Private Call via Manual Input

1. While in the home screen, press the **Menu** key.
2. Select Contact > Manual Dial.
3. Enter the Private Call contact desired for calling.
4. Hold down the **PTT** key to transmit the private call, and speak into the microphone at a normal voice level.
5. Release the **PTT** key to stop transmitting, and listen for a reply.

BASIC OPERATIONS



If the radio is programmed for Private Call Manual Dial and Group Call Manual Dial, switch between these by pressing the  key. The appropriate ID is displayed.





If the radio is programmed with the Default Numeric Key Selection enabled, you can enter a Private Call number in the home screen using the keypad, and then hold down the **PTT** key to transmit the Private Call. However, if the DTMF keypad is enabled, the number entered in the home screen is a phone number. You can dial the Private Call number through the Manual Dial menu only.

Receiving and Responding to a Private Call



When a private call is received, the  icon appears in the radio's display. To respond to the call, hold down the **PTT** key within the preset time period, and speak into the microphone at a normal voice level.



If you do not respond to a received private call, the  missed call icon appears at the top of the display. In addition, if the radio is programmed with Display Missed Call enabled, the large  icon also displays.

GROUP CALLS

A group call is a call initiated by a radio user to a group of radio users.

Transmitting a Group Call



When transmitting a group call, the  icon appears in the display. A group call can be transmitted using either method described in the following subsections.



When transmitting (i.e., **PTT** key depressed), hold the front of the radio between 1 to 2 inches from your mouth and speak into the microphone at a normal voice level. This will ensure optimal reception at the receiving radio unit(s). Never shout or whisper when transmitting. As illustrated on page 6, the radio's microphone is located just above the display.

Transmitting a Group Call to the Preset Contact

While in the home screen, hold down the radio's **PTT** key to transmit a group call to the Group Call contact preset for the currently selected channel. Release the **PTT** key to stop transmitting, and listen for a reply. See *Receiving and Responding to a Group Call* for additional information.



Each digital channel may be pre-programmed with a preset contact by your dealer. The preset contact can be a Private Call contact, a Group Call contact, or an All Call contact.

Transmitting a Group Call via the Contact List

1. While in the home screen, press the **Menu** key.
2. Select **Contact > Contact List**.
3. Press the **Up/Down** key to select the Group Call contact desired for calling. In this list, each Group Call contact name is preceded by a  icon.

BASIC OPERATIONS

4. Hold down the **PTT** key to transmit a group call to the selected contact, and speak into the microphone at a normal voice level.
5. Release the **PTT** key to stop transmitting, and listen for a reply.

Transmitting a Group Call via Manual Input

1. While in the home screen, press the **Menu** key.
2. Select **Contact > Manual Dial**.
3. Enter the Group Call contact desired for calling via the keypad.
4. Hold down the **PTT** key to transmit the group call, and speak into the microphone at a normal voice level.
5. Release the **PTT** key to stop transmitting, and listen for a reply



NOTE

If the radio is programmed for Private Call Manual Dial and Group Call Manual Dial, switch between these by pressing the **#*** key. The appropriate ID is displayed.



NOTE

If the radio is programmed with the Default Numeric Key Selection enabled, you can enter a Group Call number in the home screen using the keypad, and then hold down the **PTT** key to transmit the Group Call. However, if the DTMF keypad is enabled, the number entered in the home screen is a phone number. You can dial the Group Call number through the Manual Dial menu only.

Receiving and Responding to a Group Call



When a group call is received, the  icon appears in the radio's display. To respond to the call, hold down the **PTT** key within the preset time period, and speak into the microphone at a normal voice level.

ALL CALLS 

An all call is a call initiated by a radio user to all radio users on the channel.

Transmitting an All Call



All calls can be transmitted to the preset contact or to a contact on the Contact list. Methods for transmitting an all call are the same as those described for *Transmitting a Group Call* on page 23. When transmitting an all call, the  icon appears in the display.



All calls can only be transmitted if enabled by your dealer via radio pre-programming.

Receiving an All Call



When an all call is received, the  icon appears in the display.



It is not possible to respond to an all call.

TALK-AROUND (DIRECT MODE)

The talk-around feature provides direct radio-to-radio communications. With talk-around, a radio repeater system is not required for radio communications. This type of operation is sometimes called “direct mode.” Talk-around is beneficial when, for example, a radio repeater system malfunction has occurred, or when the radio is out-of-range of a radio repeater system, but other radios are nearby that can communicate on the same pre-programmed radio channels.

To toggle radio operation between normal communications mode (repeater mode) and talk-around, press the pre-configured **Talk-Around** shortcut key. When in talk-around/direct mode, the **DM** icon appears near the upper left corner of the display. When in repeater mode, the **RM** icon appears.

BASIC OPERATIONS

CALLS ON ANALOG CHANNELS

Transmitting a Call on an Analog Channel

1. If not already, select the desired analog channel.
2. Listen for a clear channel. In other words, if another person is using the channel, wait for them to finish transmitting/speaking. If pre-programmed, a monitor or squelch off shortcut key should be used to verify the channel is clear. See the following sections for additional information on these functions.
3. Hold down the radio's **PTT** key and speak into the microphone at a normal voice level.
4. Release the **PTT** key to stop transmitting and listen for a reply.

Receiving a Call on an Analog Channel

1. If not already, select the desired analog channel. Do **not** press the **PTT** key.
2. When an incoming call is received on the channel, rotate the **On/Off Volume Control** knob as necessary to adjust the volume.
If pre-programmed, a monitor or squelch off shortcut key can be used to verify there is no signal on the channel. Also, the Squelch Off shortcut key can be used in weak signal conditions.

Monitor



Monitor is a function for analog channels that allows any pre-programmed receiver decoding to be disabled so calls (or other activity) on the selected channel without the correct code can be monitored.

This does not disable receiver squelch. When the Monitor function is enabled, the  icon appears in the top of the display, and any calls on the channel will be heard in the radio's speaker.

To enable and disable the Monitor function, press the pre-programmed **Monitor** shortcut key, or the **Monitor Momentary** shortcut key. The **Monitor** shortcut key provides a toggle on/off type function, whereas the **Monitor Momentary** shortcut key temporarily enables the function only when the shortcut key is depressed.

BASIC OPERATIONS

Squelch Off



Squelch Off is an analog channel function that, when enabled, keeps the receiver unsquelched (i.e., not muted) even when there is no signal on the selected channel. When enabled, the  icon appears in the top of the display and call audio on the channel (or receiver noise) is routed to the radio's speaker.

To toggle squelch between enabled and disabled, press the pre-configured **Squelch Off** shortcut key.

To momentarily turn squelch off, depress the pre-configured **Squelch Off Momentary** key. When this key is released, squelch turns back on.

Telephone Interconnect Calls

If an analog channel's repeater site equipment is connected to a Public Switched Telephone Network (PSTN) gateway system, the radio can make a phone call through this channel and phone system.

Transmitting a Phone Call

1. Select an analog channel that has a PSTN connection. Consult with your radio dealer as necessary.
2. Access the phone system using either a Live Dial method or Buffer Dial method as follows:
 - **Live Dial** — Hold down the **PTT** key, then enter the access code via the radio's keypad and release the **PTT** key. The radio beeps and displays the dialing information. When the phone system is accessed successfully, the radio automatically goes to the DTMF keypad mode.
 - **Buffer Dial** — Access the phone system as follows:
 - A. Enter the DTMF keypad mode using one of the following methods:
 - From the home screen, press the **Menu** key then select Phone > Manual Dial to enter the DTMF keypad mode.
 - Press the programmed **DTMF Keypad** shortcut key.
 - From the home screen, press the **Menu** key then select Phone > DTMF Keypad > Enable.



BASIC OPERATIONS



- B. Enter the phone system's access code via the radio's keypad and then press the **PTT** key. The radio beeps and displays the dialing information. When the phone system is accessed successfully, the radio goes to the DTMF keypad mode again.
3. Dial the desired phone number using one of the following methods:
- **Live Dial** — Hold down the **PTT** key and enter the phone number via the radio's keypad. Release the **PTT** key after the complete phone number has been entered.
 - **Buffer Dial** — Enter the phone number via the radio's keypad and then hold down the **PTT** key.
 - Select the **Back** and then the **Menu** keys, and then select **Phone > Phone List** to select a desired contact. Next, press the **PTT** key.
4. After the call is established, hold down the **PTT** key to talk, and release it to listen. To end the call, send the de-access code to exit the phone system; the input method is the same as that for the access code.

If the phone is hung up, the call will end and the phone system will exit.

Receiving a Phone Call











When the radio receives a phone call, the  icon or the  icon displays. To respond to the call, hold down the **PTT** key within the preset time period, and speak into the microphone at a normal voice level.

If you do not respond, the radio will provide appropriate indications. If you do not respond to a received phone call, the  missed call icon appears at the top of the display. In addition, if the radio is programmed with Display Missed Call enabled, the large  icon also displays.

BASIC OPERATIONS

BATTERY STRENGTH INDICATOR

If the **Battery Strength Indicator** shortcut key is pre-programmed, this function can be used to quickly check the remaining battery strength via the LED indicator on the top of the radio. This may be beneficial during certain ambient light conditions, or when the respective icons in the radio's display cannot be easily viewed. Simply press and hold this pre-programmed shortcut key and view the LED indicator on the top of the radio.

| LED INDICATOR | DISPLAY ICON | BATTERY STRENGTH |
|--|---|------------------|
| Glowing Green  |  | High |
| Glowing Orange  |  | Medium |
| Glowing Red  |  | Low |
| Glowing Red (and Low Battery Alert Tone Sounds)  |  | Insufficient |

MENU NAVIGATION

MAIN MENU

The radio's main menu structure is shown in the following diagram. To access the main menu, press the **Menu** key on the home screen. Each menu is described in the subsections that follow.

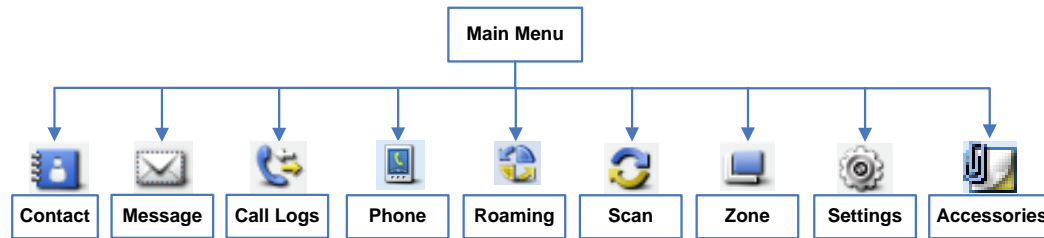

CONTACT MENU

To access the Contact menu, first select a digital channel (if not already), then press the **Menu** key in the home screen and select **Contact**. The Contact menu displays:



Contact List

Up to 512 entries can be saved in the Contact List. To access this list, select **Contact List** in the Contact menu, or if programmed, press **Contact List** shortcut key while on a digital channel. List functions include:

Ctrl Services  — Use this to send a Private Call contact one of the following commands: alert call, radio check, remote monitor, radio enable, or radio disable. See *Manual Dial* on page 31 for details.

Editing a Contact — Use this to edit the number and alias of each private call contact.

Viewing a Contact — Use this to view details about each contact.

MENU NAVIGATION

Deleting a Contact — Use this to delete a private call contact. However, when there is only one entry left in the list, it cannot be deleted. In addition, the private call contact preset on the currently used channel cannot be deleted.

New Contact

To add a private call contact to the Contact list, select **New Contact** in the Contact menu. The number and alias of each contact must be unique, and the available number range is 1 to 16776415.

Manual Dial

To manually input a number for calling, select **Manual Dial** in the Contact menu. Any of the following commands can then be performed:





On a digital channel, if the radio is programmed for Private Call Manual Dial and Group Call Manual Dial, switch between these by pressing the **#*** key. The appropriate ID is displayed.

Alert Call  — Use the Alert Call command to send an alert call to a Private Call contact. The called party will see the alert and can then call you back.

Radio Check  — The Radio Check command is used to check a remote radio on the Private Call contact list, while not disturbing the contact/radio operator. This command can be used to confirm whether the called radio is powered on and on your selected channel.

Remote Monitor  — Use this Remote Monitor command to enable the microphone of a remote Private Call contact's radio. This can be used to remotely monitor voices and background sounds near the contact radio's microphone.

Radio Enable  — Use this Radio Enable command to enable the radio of a remote Private Call contact for normal use.

Radio Disable  — Use this Radio Disable command to disable the radio of a remote Private Call contact from normal use.

MENU NAVIGATION

MESSAGE MENU

To access the Message menu, first select a digital channel (if not already), then press the **Menu** key in the home screen and select **Message**. Alternately, access this menu by pressing the respective pre-programmed shortcut key while on a digital channel. The Message menu displays. This menu supports the text messaging feature of the radio:

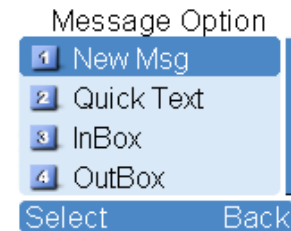

New Msg

Select **New Msg** to create a new text message and send it to an individual (via private call) or to a talk group. Text message length is limited to 256 characters.

Quick Text

Under **Quick Text**, there are up to 25 pre-programmed text messages. You can edit and send any one of these messages.

InBox

Select **InBox** to access the InBox. The InBox can save up to 20 received text messages. For each text message, any of the following operations can be performed: Reply, Forward, View Details, and Delete.



When the InBox is full, the  icon will appear, and the earliest message will be automatically overwritten by the last message that was received.

To delete all messages in the InBox, select **Message > InBox > Delete All**.

OutBox

Select **OutBox** in the Message menu to access the OutBox. The Outbox can save up to 20 sent messages. When the OutBox is full, the earliest message will be automatically overwritten by the last one that was sent.

MENU NAVIGATION

For each message, you can choose to perform any of these operations: Resend, Forward, View Details, and Delete.

To delete all messages in the OutBox, press the **Menu** key in the home screen and select **Message > OutBox > Delete All**.

Drafts

Drafts can save up to 20 draft messages. When full, the earliest message will be automatically overwritten by the last one entered.

For each draft message, you can choose to perform any of these operations: Send, Save, and Delete.

To delete all draft messages, select **Message > Drafts > Delete All**.

CALL LOGS MENU

To access the Call Logs menu, first select a digital channel (if not already), then press the **Menu** key in the home screen and select **Call Logs**. Alternately, access this menu by pressing the respective pre-programmed shortcut key while on a digital channel.

Selections on this menu include Outgoing, Incoming, and Missed, for outgoing, incoming, and missed calls respectively. Up to ten (10) private call entries can be saved in each log. When a log is full, the oldest entry will be automatically overwritten by latest one.

After accessing a log and selecting an entry, any one of the following actions can be performed: Hold down the **PTT** key to initiate a call to the selected entry, add the selected entry to Contact List, or delete the entry.

To delete all entries in a particular log at the same a time, select **Call Logs > Outgoing/Incoming/Missed > Delete All**.

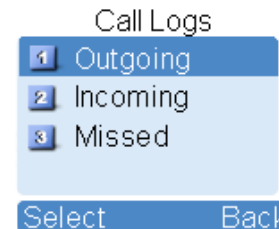

MENU NAVIGATION

PHONE MENU

This menu supports telephone calls, as described in the section beginning on page 27. To access the Phone menu (if programmed), press the **Menu** key in the home screen and select **Phone**.

Phone List

Select **Phone List** to view and use stored phone numbers. Alternately, if programmed by your radio dealer, press the programmed **Phone List** shortcut key to quickly access this list.

Manual Dial

Using the (optional) keypad microphone, select **Manual Dial** to manually enter a phone number for calling. See page 27 for additional information.

DTMF Keypad

Select **DTMF Keypad** to manually enter a phone number for calling via the (optional) keypad microphone. The entered number appears in the home screen. This is the DTMF code that will be transmitted when the radio's PTT key is pressed. See page 27 for additional information.

ROAMING MENU

Use this menu to enable and disable the roam feature. Access this menu (if programmed) by pressing the **Menu** key in the home screen and then selecting **Roaming**.

MENU NAVIGATION

SCAN MENU

To access the Scan menu, press the **Menu** key in the home screen and then select **Scan**:

Scan On/Off

The Scan feature allows you to listen to communication activities on other channels. Select **Scan On/Off** on this menu to toggle scan operation on and off. When scan is off, the radio does not scan channels on the list; it simply remains on the selected channel. When scan is on, the radio scans channels according to the scan list set for the channel on which scanning starts. Refer to page 42 for additional information on channel scanning.

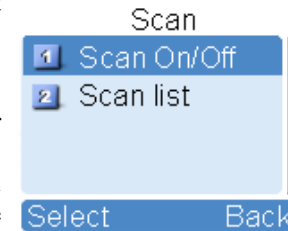

Scan List

Scan lists can be pre-programmed into the radio by your dealer for each channel, and then edited when desired as described below. Each scan list may contain 32 digital or analog channels. Each scan list can be edited via menu selection as follows:

Adding a Channel — Use this function to add a new channel to the active scan lists.

Editing Priority Channel — Use this function to set the selected channel as a non-priority channel or as a priority channel. A priority channel will scanned more frequently than non-priority channels. Each scan list may contain up to two (2) priority channels. **P1** indicates priority channel 1, and **P2** indicates priority channel 2.

Deleting a Channel — Use this function to remove a channel from the active scan list. However, the first channel in the list cannot be deleted.

MENU NAVIGATION

ZONE MENU

The radio supports up to 64 zones. Each zone is pre-programmed into the radio. To access the Zone menu, press the **Menu** key in the home screen, select **Zone**, and then use the **Up/Down** keys to select the desired zone from the menu.



SETTINGS MENU

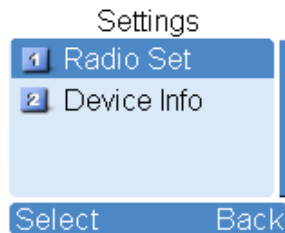

Using the Settings menu, radio settings can be customized by changing various parameters according to actual user/operator needs and preferences. Also, this menu can be used to display basic device information about the radio. To access the Settings menu, press the **Menu** key in the home screen and then select **Settings**:



Radio Set

Selections within Radio Set include:

Power Level — Use this to change between the low and high transmit (TX) power levels. Alternatively, the power level can be changed by, while in the home screen, pressing the pre-programmed **Adjust Power Level** shortcut key. Two (2) power levels are available:

-  High Transmit Power Level — Use this level whenever an increased communications range is necessary.
-  Low Transmit Power — To avoid unnecessary communications interference, use this level whenever possible. Use of this level can also increase battery operating time.

MENU NAVIGATION



The power level should be individually set for each channel.

Squelch  — Select this to set an appropriate receiver squelch level via the Adjust Squelch Level sub-menu. Alternatively, press the assigned shortcut key to access the Adjust Squelch Level sub-menu. There are three (3) levels available: Tight, Normal, and Open. The default squelch level is Normal. It is often used in a low radio frequency noise environment. Generally, the Tight level should be used in a high radio frequency noise environment; it requires a stronger received radio signal to unmute the receiver. Using Open will keep the speaker unmuted, regardless of the noise level or the decode settings.

Scramble  — Use this to enable/disable the scrambler feature. This feature employs analog voice inversion technology.

Encrypt  — Use this to enable/disable the encrypt feature and to set parameters of this feature, as follows:

- On/Off — Enable (turn on) or disable (turn off) encryption.
- Key List — Select one of 30 possible encryption keys.
- New Key — Use this to create a new key ID, which consists of numbers only (range =1 to 255).
- Key Alias — Use this to create a key alias (up to 16 characters) for a key. The key alias cannot be the same as the key ID.
- Key Length — Use this to edit the length of a new key.
- Key Value — Use this to edit a key's value. Values can consist of numbers and the letters A through F (within the predefined key length).
- Save — Use this to save a key and add it to the key list.



If a key must be deleted, consult with your radio dealer for assistance.

MENU NAVIGATION

Language — Use this to set the language of the radio's menus.

Backlight — Use this to set backlight to either on, off, or timer. When set to timer, the backlight turns off a pre-programmed time period after user key presses end. The timer is pre-programmable by your dealer with a time period of between 5 and 60 seconds.

Brightness — Use this to set display brightness. Raise or lower it using the **Up/Down** key.

Keypad Lock — Use to set whether to enable this function. When enabled, the **Up/Down** key can be used to set the time range after which the keypad will be locked. Available range is between 5 and 60 seconds. If enabled, the keypad will lock automatically within the preset time period if no operation is made. If disabled, the keypad will not lock automatically. See page 19 for additional information.

LED — Use this to enable and disable the LED indicator located on the top of the radio. When disabled, the LED indicator always remains off (i.e., it does not light up). See page 17 for additional information.

Tone — Use this to configure radio alert tones. The following settings are available:

Radio Silent: Use this to enable and disable all tones. If Silent On is selected, all tones remain silent.

Keypad: Use this to set whether the radio will sound a tone for keypad operations.

TextMsg: Use this to set whether the radio will sound a tone when it receives a message.

Private Call: Use this to set whether the radio will sound a tone when it receives a private call.

Group Call: Use this to set whether the radio will sound a tone when it receives a group call.

Talk Permit: Configures the transmit (Tx) talk permit tone. The following selections are available: Disable (no tone sounded at Tx), Digital Only (tone sounded at Tx on digital channels only), Analog Only (tone sounded at Tx on analog channels only), and Enable (tone sounded at Tx on both analog and digital channels).

Call End: Use to set whether or not a tone is generated when a call ends.

Voice End: Use to set whether or not a tone is generated after a voice call ends.

MENU NAVIGATION

Low Battery: Use to set whether or not a tone is generated when the radio's battery needs charging.

Channel Notify: Use to set whether or not the number of the newly selected channel will be announced from the radio's speaker in a synthesized voice. See page 19 for additional information.

Signaling Side: Use to set whether or not the radio will sound continuous tone during a signaling transmission. This feature is available for calls for HDC1200/5-tone/2-tone systems.

Vibration — Use this to enable and disable radio vibration. If enabled, the radio will vibrate when it receives a text message or a private call.

Lone Worker — Use this to enable and disable the radio's Lone Worker feature. See page 50 for additional information about this feature.

Man Down (Optional) — Use this to enable and disable the radio's man down feature. See page 52 for information about this feature.

Device Info

Select **Device Info** on the Setting menu to view basic information about the radio, including serial number, model number, frequency range, firmware version, etc.

MENU NAVIGATION

ACCESSORIES MENU

Use the Accessories menu to view, change, and send Global Positioning System (GPS) related information and/or other accessories functions. To access this menu, press the **Menu** key in the home screen and then select **Accessories**.



The Accessories menu only appears if the radio is equipped with an internal GPS receiver or if it is pre-programmed with another accessory function.

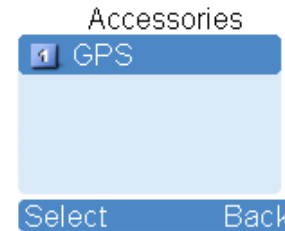

GPS

GPS Switch — Use this to enable or disable the radio's GPS feature.



Enabling the GPS feature will shorten the operating time of the battery.

Position — This selection displays longitude, latitude, time, date, speed (displayed in nautical miles-per-hour), altitude, and GPS satellite (SA) information based upon signals received by the radio's GPS receiver.

GPS Text Message  — On a digital channel, send the radio's GPS position via a text message as follows:

1. Press the **OK** key. The Contact List is selected by default.
2. Press the **OK** key again to access the contact list then press the **Up/Down** key to select the contact which the GPS text message should be transmitted to.

Alternately, select a contact via **Manual Dial** on the Contact menu, and enter the private call or group call number using the keypad on the (optional) keypad microphone. See **Manual Dial** on page 31 for additional information.

3. Press the **OK** key to transmit/send the GPS location information message to the selected contact.



MENU NAVIGATION

Time Zone — This function allows setting of the local time zone, so the received GPS time (hours) is correctly displayed. The zone should be correctly set to before the initial use of this feature. For example, if the time at your location is 5.45 hours earlier than GMT, select “GMT+5.45” as your time zone.

SCANNING CHANNELS

GENERAL INFORMATION

The radio's scan feature allows scanning of radio channels pre-programmed into the radio for call activity. Scan lists can be pre-programmed for each channel and then edited as desired. Each scan list may contain 32 digital or analog channels. When the radio is scanning channels:

- The  icon appears in the top of the display.
- The LED indicator on the top of the radio flashes orange slowly.
- The radio scans the channels currently on the scan list for calls (or other activity).
- When a call (or other activity) is received/detected on a channel in the scan list:
 - The call's audio is routed to the radio's speaker.
 - The radio remains on the channel (i.e., scan operation automatically pauses) until the call (or other activity) ends.
 - The  icon displays while the radio is paused on a non-priority scan channel.
 - The **P₂** icon displays when the radio is paused on the priority 2 scan channel. During this time, scanning pauses until the call ends.
 - The **P₁** icon displays when the radio is paused on the priority 1 scan channel. During this time, scanning pauses until the call on the priority 1 scan channel ends.

OPERATION



Turning Scan On and Off

Scan can be turned on and off via the Scan menu or, if pre-programmed, by pressing the **Scan** shortcut key. Both are toggle-type functions. For details on using the Scan menu, see page 35.

SCANNING CHANNELS

The radio can be pre-programmed with the Auto Scan feature on a per-channel basis. If so, the radio will automatically begin scanning the channel's scan list when the channel is selected. In this case, to turn scan off, use the Scan menu or, if pre-programmed, press the **Scan** shortcut key once.

Pausing Scan

If a call is received on an analog channel and staying on the channel (i.e., pausing scan) is desired so additional transmissions can be heard on it, press the pre-programmed **Monitor** or **Squelch Off** shortcut key when a call is on the channel. When the Monitor function is on, the  icon appears in the top of the display and if present, call audio on the channel is heard in the radio's speaker. When the Squelch Off function is on or when a call is on the channel, the  icon appears in the top of the display and call audio on the channel (or receiver noise) is heard in the radio's speaker. Press the shortcut key again or the **Scan** shortcut key to unpauses scan.

Nuisance Temporary Delete

To temporarily remove a channel from a channel's scan list so calls on it will not pause scanning, press the pre-programmed **Nuisance Temporary Delete** shortcut key when a call is on the channel. In this case, the channel will not be scanned again until after a menu action is completed, the channel or zone is changed, the radio is power-cycled, or scan is turned off and back on. See page 35 for details on editing a scan list.







EMERGENCY COMMUNICATIONS

GENERAL INFORMATION

The radio's emergency feature can be used to summon help from another radio operator(s) and/or via a radio dispatch/control center. The emergency process has the highest call priority throughout the radio communications system. Emergency operations can be performed when the radio is transmitting or receiving. The radio can be pre-programmed with different emergency modes, emergency types, and emergency ID types. These are described in the following subsections. Each channel can be pre-programmed with different emergency system operation. Consult your radio dealer for specific information on how your radio is pre-programmed:

Emergency Mode

The radio supports three (3) emergency modes, as defined in the following table. Two (2) of the three modes apply only to analog channels (see  symbol). To select a different mode, consult with your radio dealer:

| EMERGENCY MODE | DESCRIPTION |
|---|--|
| Alarm  | With this mode, you can send alarm information to another radio operator or to a dispatch/control center, but you cannot transmit voice audio. Initiate by pressing the pre-programmed Emergency shortcut key. |
| Alarm with Call  | With this mode, you can send alarm information by pressing the pre-programmed Emergency shortcut key. Next, when the  icon appears in the display, simply speak into the microphone to transmit your voice. Pressing the radio's PTT key is <u>not</u> necessary when speaking in the mic. This is commonly referred to as a "hot-mic" condition. |
| Call Only | With this mode, you can send alarm information by pressing the pre-programmed Emergency shortcut key. Next, when the  icon () or the  icon () icon appears in the display, simply speak into the microphone to transmit your voice. Pressing the radio's PTT key is <u>not</u> necessary when speaking in the mic (i.e., a hot-mic condition). |

EMERGENCY COMMUNICATIONS

Emergency Type

The radio supports four (4) emergency types, as defined in the following table. To select a different type, consult with your radio dealer:

| EMERGENCY TYPE | DESCRIPTION |
|-----------------------|---|
| Siren Only | When an emergency occurs, the radio sounds a shrill alarm tone and displays the 🚨 icon. |
| Regular | When an emergency occurs, the radio gives an audible and a visual indication. |
| Silent | When an emergency occurs, the radio does not give any indication, audible or visual. This type is typically employed in covert operations. |
| Silent with Voice | When an emergency occurs, the radio does not give any audible or visual indication, but it will receive voice audio response(s) from other radios or a dispatch/control center transmitting on the emergency channel. This type is typically employed in covert operations. |

Emergency ID Type



The radio supports two (2) emergency ID types on analog channels, as defined in the following table. To select a different ID type, consult with your radio dealer:

| EMERGENCY TYPE | DESCRIPTION |
|-----------------------|---|
| None | No signaling is used when the radio transmits alarm information. |
| HDC1200 | HDC1200 signaling is used when the radio transmits alarm information. |

EMERGENCY COMMUNICATIONS

Emergency Operations on Analog Channels

Alarm Emergency Mode



 If the radio is pre-programmed for Alarm emergency mode operations on the selected analog channel, press the pre-programmed **Emergency** shortcut key transmit an alarm. When an alarm is transmitted, a  (red phone handset) icon and “Sending Alarm” is displayed. Also, the LED indicator on the top of the radio rapidly flashes orange then glows red to indicate the alarm transmission. The radio may also be pre-programmed to sound an audible alarm.

The alarm will be transmitted until the pre-programmed number of alarm cycles completes, or it can be ended early by long-pressing the pre-programmed **Emergency** shortcut key.



Alarm with Call Emergency Mode



If the radio is pre-programmed for Alarm with Call emergency mode operations on the selected analog channel, use this feature as follows:

1. Press the pre-programmed **Emergency** shortcut key. The radio displays a  (red phone handset) icon and “Sending Alarm” in its display. Also, the LED indicator on the top of the radio rapidly flashes orange then glows red to indicate the alarm transmission. The radio may also be pre-programmed to sound an audible alarm.
2. When the  icon appears in the display, the radio is in a hot-mic condition for a pre-programmed period of time. Speak in to the microphone to transmit voice audio on the selected analog channel. Pressing the radio’s **PTT** key is not necessary during this time. The LED indicator glows red during this time.
3. After the pre-programmed hot-mic time ends, the radio then enters a receive period, as indicated by the  icon in the display. Listen for a reply during this period of time.
4. If the radio is pre-programmed with more than one voice cycle, it will repeat the transmit (with hot-mic) and receive periods for the number of pre-programmed cycles.

EMERGENCY COMMUNICATIONS







5. After the voice cycle(s) expires, additional voice calls can be made by pressing the radio's **PTT** key. The  icon appears in the display and the LED indicator glows red. Release the **PTT** key to end the voice call (transmission) on the emergency channel. The radio displays the  icon and the LED indicator flashes orange rapidly. If an HDC1200-format signaling call is received, the  icon appears in the display.

The Alarm with Call emergency mode transmission will continue until the pre-programmed number of alarm cycles and voice cycles completes. Alternately, it can be ended early by long-pressing the pre-programmed **Emergency** shortcut key.

Call Only Emergency Mode (HDC1200 Signaling Only)



If the radio is pre-programmed for Call Only emergency mode operations on the selected analog channel, use this feature as follows:

1. Press the pre-programmed **Emergency** shortcut key. The radio displays a  (red phone handset) icon and switches to the dedicated/revert channel for the emergency call. Also, the LED indicator on the top of the radio rapidly flashes orange then glows red to indicate the alarm transmission. The radio may also be pre-programmed to sound an audible alarm.
2. If the feature "Alarm with Call to Follow" is enabled, voice audio can be transmitted by speaking into the microphone when the  icon appears in the display.
The radio displays the  icon when it is ready to receive.
When a call is received, the  icon appears in the display.
3. After the voice cycle(s) expires, additional voice calls can be made by pressing the radio's **PTT** key. The  icon appears in the display and the LED indicator glows red. Release the **PTT** key to end the voice call (transmission) on the emergency channel. The radio displays the  icon and the LED indicator flashes orange rapidly. If a call is received, the  icon appears in the display.

To exit the emergency mode early, long-press the pre-programmed **Emergency** shortcut key.

EMERGENCY COMMUNICATIONS



NOTE

The following parameters are pre-programmed by your radio dealer:

- Number of voice cycles;
- Duration of each transmission;
- Transmission interval;
- If without HDC1200 signaling:
 - Number of alarm cycles; and,
 - Alarm duration.
- If with HDC1200 signaling:
 - Number of polite retries; and
 - Number of impolite retries.

Emergency Operations on Digital Channels

Alarm Emergency Mode



If the radio is programmed for Alarm (only) emergency mode operations on the selected digital channel, use this mode as follows:

1. Press the programmed **Emergency** shortcut key. The radio displays a  (red phone handset) icon and “Sending Alarm” is displayed as the alarm is transmitted. Also, the LED indicator glows red to indicate the alarm transmission.
2. Once the emergency cycles expire, the radio exits the emergency mode automatically.

To exit the emergency mode early, simply long-press the programmed **Emergency** shortcut key.







Alarm with Call Emergency Mode



If the radio is programmed for Alarm with Call emergency mode operations on the selected digital channel, use this mode as follows:

1. Press the programmed **Emergency** shortcut key. The radio displays a  (red phone handset) icon and “Sending Alarm” is displayed as the alarm is transmitted. Also, the LED indicator glows red to indicate the alarm transmission.

EMERGENCY COMMUNICATIONS

- When the  icon appears in the display, speak into the microphone to transmit voice audio. The radio displays the  icon when it is ready to receive. When a call is received, the  icon appears.
- After the voice cycle(s) expires, additional voice calls can be made by pressing the **PTT** key. When doing so, the  icon appears in the display and the LED indicator glows red. Release the **PTT** key to end the voice call (transmission) on the emergency channel. The radio displays the  icon and the LED indicator flashes orange rapidly. If a call is received, the  icon appears in the display.

To exit the emergency mode early, long-press the programmed **Emergency** shortcut key.









The following parameters are programmed by your radio dealer for the above mode:

- Number of voice cycles;
- Duration of each transmission; and,
- Transmission interval.

Call Only Emergency Mode



If the radio is programmed for Call Only emergency mode operations on the selected digital channel, use this mode as follows:

- Press the programmed **Emergency** shortcut key. The radio displays a  (red phone handset) icon and switches to the dedicated/revert channel for the emergency call.
- If the “Alarm with Call to Follow” feature is enabled, voice audio can be transmitted by speaking into the microphone when the  icon appears in the display. The radio displays the  icon when it is ready to receive. When a call is received, the  icon appears.
- After the voice cycle(s) expires, additional voice calls can be made by pressing the **PTT** key. When doing so, the  icon appears in the display and the LED indicator glows red. Release the **PTT** key to end the voice call (transmission) on the emergency channel. The radio displays the  icon and the LED indicator flashes orange rapidly. When a call is received, the  icon appears in the display.

EMERGENCY COMMUNICATIONS

To exit the emergency mode early, simply long-press the programmed **Emergency** shortcut key.



The following parameters are programmed by your radio dealer for the above mode:

- Number of voice cycles;
- Duration of each transmission;
- Transmission interval;
- Number of polite retires; and,
- Number of impolite retires.

LONE WORKER

The Lone Worker feature, when enabled, causes the radio to automatically transmit an alarm if the radio user/operator does not react to reminder beeps which the radio periodically generates. Before this feature will function, it must be programmed by your radio dealer and it must be enabled.

User/Operator reaction is accomplished by simply pressing any radio key or by rotating a radio knob before a programmed reminder timer expires. Either reaction will reset the programmed reminder and response timers, thus starting a new response period of time. The response timer is typically programmed for many minutes or hours (255 minutes maximum), and the reminder timer is typically programmed for several seconds to a minute (255 seconds maximum).

If no reaction is taken when the radio begins beeping and the response timer is allowed to expire, the radio automatically enters the programmed emergency mode and if the selected channel is programmed for Alarm or Alarm with Call emergency mode operations, it immediately begins alarm transmissions on the selected channel, or on a channel pre-assign for emergency communications. However, the radio does not transmit if the selected channel is not programmed for Alarm or Alarm with Call emergency mode operations.

Enabling and Disabling Lone Worker

There are two (2) possible ways to enable and disable the Lone Worker feature:



- From the Radio Set menu select: Menu > Settings > Radio Set > Lone Worker > Enable or Disable.

EMERGENCY COMMUNICATIONS

- If the **Lone Worker** shortcut key is programmed to a key, press this key to enable or disable the Lone Worker feature.

When this feature is enabled (i.e., turned on), the radio briefly displays “Lone Worker On!” When this feature is disabled (i.e., turned off), the radio briefly displays “Lone Worker Off!”

Using Lone Worker

1. Enable (i.e., turn on) the Lone Worker feature if it is not already. Refer to the previous section as necessary. The current enable/disable status can be viewed from the Lone Worker menu.
2. Select a channel programmed for Alarm or Alarm with Call emergency mode signaling. Consult with radio system administration personnel as necessary.
3. When the radio begins sounding reminder beeps, press any radio key to reset the response timer. If this timer is not reset before it times-out, the radio will begin alarm transmissions per radio programming. When transmitting, the LED indicator on the top of the radio lights red and “Sending Alarm” displays.
4. If the programmed emergency mode is Alarm with Call, the radio beeps once and enters a hot-mic period. The  icon displays and the LED indicator lights red. During this time, speak into the radio’s microphone to transmit voice audio on the channel. Pressing the PTT key is not necessary.
5. Next, the radio enters a receive period, displaying the  icon. During this time, listen for a voice reply to the alarm and/or voice transmission. Adjust volume as necessary.

The hot-mic and receive periods may be programmed to repeat one or more times.

6. To exit the emergency mode, thus ending alarm and voice transmissions early, simply press the Emergency Off shortcut key. If this shortcut key is not programmed, select another channel or cycle radio power to exit the emergency mode.

EMERGENCY COMMUNICATIONS

MAN DOWN (OPTIONAL)

If installed in the radio, the Man Down feature can be used to automatically initiate an emergency when the radio is positioned aslant for a programmed period of time.

If the radio has this optional feature, the radio may be programmed to automatically enable the feature upon radio power-up. If a man down capable radio is not programmed in this manner, the Man Down feature must be manually enabled before the feature will function.

Manually Enabling and Disabling Man Down

There are two (2) possible ways to manually enable and disable the Man Down feature:

- From the Man Down menu select: **Menu > Settings > Radio Set > Man Down > Enable or Disable.**
- If the **Man Down** shortcut key is programmed to a key, press this key to enable or disable the Man Down feature. A high-pitched tone sounds to indicate the feature is enabled. A low-pitched tone sounds to indicate the feature is disabled.

Using Man Down

1. Enable the Man Down feature if it is not already. Refer to the previous section as necessary. The current enable/disable status can be viewed from the Man Down menu.
2. After the radio is positioned aslant for the preset period of time, it first sounds an alert tone. If it is not soon returned to a near vertical/upright position, it enters the emergency mode and automatically begins transmitting emergency alarm(s), as programmed.
3. To exit the emergency mode, thus ending the alarm transmission(s), return the radio to a (near) vertical/upright position.

GENERAL INFORMATION

The radio supports HDC1200 signaling. This signaling is compatible with MDC1200 signaling. It supports functions such as PTT ID signaling, emergency signaling, and signaling via selective call. These functions are supported in both encode and decode modes.

TRANSMISSION (ENCODE)



PTT ID Transmission

Along with voice audio, the radio can transmit an HDC1200-encoded identification (ID) number on the selected channel with each press of the radio's **PTT** key. This is commonly referred to a "PTT ID." Per radio programming, the ID number can be sent when the **PTT** key is pressed (before voice audio is transmitted), when the **PTT** key is released (after voice audio is transmitted), or both at press and release of the **PTT** key. The radio can be programmed to either sound a tone when it is transmitting the encoded signal or sound beeps after it has transmitted the encoded signal.

Private/Group/All Call Transmission (Selective Call via Contact List)



An HDC1200-encoded signal can also be transmitted to a contact on the radio's Contact List as follows:

1. Use the Contact menu to access the Contact List and select the desired contact. The contact selection can be a private call, a group call, or an all call. Alternately, if pre-programmed, press the **Contact List** shortcut key to get to this list, and then make the desired selection.
2. After selecting the contact, depress the radio's **PTT** key to transmit the pre-programmed PTT ID number and voice audio to the selected contact, and speak into the microphone at a normal voice level. During the transmission, the LED indicator glows red and the appropriate private call icon is displayed. The  icon is displayed for a private call. The  icon is displayed for a group call. The  icon is displayed for an all call.

HDC1200 SIGNALING

3. Release the **PTT** key to stop transmitting, and listen for a reply. After the transmission, the LED indicator briefly glows orange.

The radio can be programmed to either sound a tone when it is transmitting the encoded signal or sound beeps after it has transmitted the encoded signal.

RECEPTION (DECODE)

The radio can be programmed to display HDC1200 signaling information it receives, as described in the following subsections:

Indications for Received PTT IDs





After decoding a received PTT ID, the radio displays the  icon and either the ID or the alias (name) of the transmitting radio. If the alias of the received ID is not in the radio's Contact List, the ID is displayed. If the alias of the received ID is in the radio's Contact List, the alias is displayed.

Indications for Received Private/Group/All Calls



Upon decoding HDC1200 signaling information received via a private call/group call/all call, the radio sounds the default alert tone and lights the LED indicator green.

Also, if the radio is programmed with the “Display Decode ID” feature, it will display the respective selective call icon and the ID or alias of the transmitting radio. If the alias of the received ID is not in the radio's Contact List, the ID is displayed. If the alias of the received ID is in the radio's Contact List, the alias is displayed. Selective call icons include  for received private calls,  for received group calls, and  for received all calls.

If the radio is not programmed with the “Display Decode ID” feature, it will only display the respective selective call icon.

SECURE COMMUNICATIONS

GENERAL INFORMATION



The radio's Scrambler feature for analog channels can be used to reduce the likelihood of someone "eavesdropping" via analog radio channels. This feature employs analog voice inversion technology. This feature can be enabled and disabled on a per-channel basis.

The radio's Encrypt feature for digital channels can be used to prevent "eavesdropping" via the digital radio channel. This feature employs 256-bit digital AES encryption technology. This feature ensures the best guarantee of communication privacy. This feature can be enabled and disabled on a per-channel basis.

OPERATION

The Scrambler/Encrypt feature may be programmed to automatically enable when a channel is selected, or it may be manually enabled. When this feature is enabled/active, the  icon appears in the display.

Manually Enabling and Disabling Scrambler/Encrypt

There are two (2) possible ways to enable and disable the Scrambler/Encryption feature:

- **Scrambler:** With an analog channel selected, choose: Menu > Settings > Radio Set > Scrambler > Enable or Disable.
Encrypt: With a digital channel selected, choose: Menu > Settings > Radio Set > Encrypt > Enable or Disable.
- If the **Scrambler** or **Encrypt** shortcut key is programmed to a key, press this key to enable or disable the feature. A high-pitched tone sounds to indicate the feature is enabled. A low-pitched tone sounds to indicate the feature is disabled.

MISCELLANEOUS FEATURES

CHANNEL BUSY LOCKOUT

If enabled via the programming software, this feature can prevent the radio from interfering with other transmitting radios on the same channel. If the PTT key is held down while the channel is in use, the radio will keep beeping and display “Channel Busy!” alerting of the transmission prohibition. To stop the beeping, release the PTT key. When the channel is free, press and hold down the PTT key to transmit.

TIME-OUT TIMER (TOT)

The purpose of Time-Out-Timer (TOT) is to prevent any user from occupying a channel for an extended period. If the preset time expires, the radio will automatically terminate transmission and keep beeping. To stop the beeping, release the PTT key. You must wait for a certain time period (preset by your dealer) to initiate another transmission. If the pre-alert function is set by your dealer, the radio will alert you to the TOT expiration in advance.



NOTE

This feature does not function when the radio is in an emergency mode.

PSEUDO TRUNKING

This feature can be enabled via the programming software. If the radio operates on a digital channel with this feature enabled and one digital time slot is already occupied, the radio can transmit and receive on the other free digital time slot, allowing communications to continue during busy periods.

MIC AGC

If enabled via the programming software, the radio will process the audio signals during transmission, providing improved audio for the receiving radio.

MISCELLANEOUS FEATURES

RADIO REGISTRATION SERVICE

If enabled by your dealer, the radio will automatically register in the system within a certain period after power-on. When registered, it can acquire online information of other radios by accessing specific servers within the valid registration period.

GPS REVERT

If enabled by your dealer, a registered radio will transmit GPS positioning information to the radio system when the system requests it.

ONE TOUCH CALL

The radio can be programmed by your radio dealer with the One Touch Call feature. This feature allows any one of the following pre-programmed calls via a programmed shortcut key:

- On an analog channel, send 5-tone signaling call to a contact.
- On an analog channel, send 2-tone signaling call to a contact.
- On a digital channel, send group calls or messages to the Group Call contact.
- On a digital channel, send private calls, messages or make control services to the Private Call contact. Control services include: Alert Call, Radio Check, Remote Monitor, Radio Enable or Radio Disable, as described in the *Manual Dial* section (31 page).

One Touch Call Operation

Consult with your radio dealer as necessary to determine specific programming and operation details specific to your radio. Basic operations include:

- To send a private call or a group call on a digital channel, select the channel, press the programmed **One Touch Call** shortcut key, and then hold down the **PTT** key and speak into the microphone to transmit voice audio. Release the **PTT** key when you finish speaking.

MISCELLANEOUS FEATURES

- To send a call on an analog channel, select the channel and then press the programmed **One Touch Call** shortcut key.
- To send a message on a digital channel, select the channel and then press the programmed **One Touch Call** shortcut key.
- To send control service commands on a digital channel, select the channel and then press the programmed **One Touch Call** shortcut key.

TELEMETRY

The Telemetry feature allows you to remotely supervise a device connected to a radio. With this feature, you can control the device and view its status remotely. The method for supervising the device is programmable by your dealer. These methods are described in the following subsections.

Supervise a Device via Another/Remote Radio

If a device is connected with a radio, you can use another/remote radio to supervise the device. All the radios involved should be configured with the Telemetry feature. For example, the dealer enables the Telemetry feature for both Radio A and Radio B, and assigns the Telemetry feature to the SK1 key on Radio A. To supervise the device C, connect it with Radio B, and press the SK1 key on Radio A.

Supervise a Device via Third-Party Software

If the Telemetry feature is enabled for the radio by your radio dealer, you can supervise the device connected with the radio via third-party software.

ROAM

This feature allows the radio to communicate between sites in the IP multisite-connected radio system. If enabled, the radio can communicate via any site in the multisite system, thus ensuring seamless radio communication in the system.

MISCELLANEOUS FEATURES

Use one of these methods to enable or disable roaming:

- From the home screen, press the **Menu** key then select **Roaming > On** or **Off**.
- Press the programmed **Roam** shortcut key to toggle roaming on or off.

5-TONE SIGNALING

The radio supports 5-tone signal encode and decode operation as follows:

5-Tone Signaling Encode

1. Have your radio dealer configure the correct format and type for the encoding contents.
2. When the format consists of fields for variable information, you need to fill in such fields by manual entry or menu operation.
When the format consists of fixed codes only, you do not have to edit any fields or save any data.
3. To send the 5-tone signaling, press PTT or the programmed **One Touch Call 1** to **One Touch Call 5** shortcut key.

When encoding, the radio sounds a tone, the LED indicator glows red, and the contact information (or “Five Tone Call”) and an appropriate call icon (Private Call: or Group Call:) is displayed. If Auto Reset is enabled (by your dealer), the radio enters the Auto Reset mode after successful encoding, with LED indicator glowing orange until the Auto Reset Time expires.

5-Tone Signaling Decode

The radio can automatically decode the 5-tone signaling when receiving any matched one.

When decoding, the LED indicator glows green. After successful decoding, the display shows the contact information (or “Five Tone Call”), an appropriate call icon (Private Call: or Group Call:), and the decoded status message. If Auto Reset is enabled (by your dealer), the radio enters the Auto Reset mode, with LED indicator glowing orange until the Auto Reset Time expires.

MISCELLANEOUS FEATURES

2-TONE SIGNALING

The radio supports 2-tone signal encode and decode operation as follows:

2-Tone Signaling Encode

1. Have your radio dealer configure the correct format and type for the encoding contents.
2. To send the 2-tone signaling, press the **PTT** key or the programmed **One Touch 1** to **One Touch 5** shortcut key.

When encoding, the radio sounds a tone, the LED indicator glows red, and the  call icon with the contact information above it. If Auto Reset is enabled (by your dealer), the radio enters the Auto Reset mode after successful encoding, with LED indicator glowing orange until the Auto Reset Time expires.



2-Tone Signaling Decode

Your radio can automatically decode the 2-tone signaling. When decoding a matched one, the LED indicator glows green. After successful decoding, the display shows the contact information (or “Five Tone Call”), the  and the call type (selective call, alert call with voice, alert call) below the icon according the decoding type. If Auto Reset is enabled (by your dealer), the radio enters the Auto Reset mode, with LED indicator glowing orange until the Auto Reset Time expires.

ENTERING LETTERS, NUMBERS, AND OTHER CHARACTERS VIA THE KEYPAD

Upper and Lower Case Letters

To enter text via the radio’s keypad:

1. Press the  key to switch between upper case and lower case letters.
2. Press the key that has the desired letter repeatedly until the desired letter appears in the display.
3. To enter a space, press the  key.

MISCELLANEOUS FEATURES

4. Repeat steps 1 through 3 as necessary to complete a word or sentence.

Numbers

To enter text via the radio's keypad:

1. Press the **#*** key to switch to number mode.
2. Enter the desired number by pressing the **0+** through **9 wxyz** alphanumeric keys.
3. Repeat steps 1 and 2 as necessary to complete a word or sentence.

Punctuation Characters and Special Characters

To enter common punctuation characters and special characters, press the **1 <** key one or more times until the desired character appears in the display.

To enter a space, press the *** ↵** key.

TROUBLESHOOTING AND TECHNICAL ASSISTANCE

TROUBLESHOOTING TABLE

| SYMPTOM | POSSIBLE PROBLEMS | SOLUTIONS |
|--|--|---|
| Radio will not turn on. | Battery is dead. | Charge or replace the battery. See page 10 for instructions. |
| | Battery is not properly attached to the radio. | Remove and then re-attach the battery to the radio. See page 11 for instructions. |
| | Battery is defective/bad. | Replace the battery with a fully-charged battery. |
| When receiving, voice audio is weak, erratic, or not present at all. | Volume is set too low. | Increase the volume with the On/Off Volume Control knob. See page 18. |
| | Antenna is not properly connected to the radio. | Turn the radio off, re-connect the antenna cable to the radio, and turn the radio back on. |
| | Antenna is damaged or not present. | Have your radio dealer repair/replace the antenna. |
| On an analog channel, you cannot communicate with others. | Speaker may be blocked or damaged. | Clean surface of the speaker. If the problem cannot be solved, contact your dealer or an authorized service center for inspection and repair. |
| | The frequency or signaling may not be the same as the other radios. | Verify selected channel is correct and/or consult with your radio dealer to verify the programming of the channel's frequency and signaling. |
| | Out-of-range (too far away) from other radios, or from the channel's respective repeater/base station. | Change your location. Moving a few yards/meters in one direction can sometimes greatly improve communications range. |

TROUBLESHOOTING AND TECHNICAL ASSISTANCE

| SYMPTOM | POSSIBLE PROBLEMS | SOLUTIONS |
|---|---|--|
| On an analog channel, irrelevant communications and/or noises are heard. | Other radios may be using the same radio frequency. | Adjust the squelch and/or consult with your radio dealer as necessary. |
| | The radio may be programmed without signaling, but signaling is needed. | Consult with your radio dealer as necessary. |
| On a digital channel, you cannot communicate with others but there is a receive indication. | The ID may be inconsistent with other members. (The digital signal is being received but not fully demodulated.) | Set the ID to the same as the other member's radios. Consult with your radio dealer as necessary. |
| Noisy communications. | Out-of-range (too far away from) of others, or from the channel's repeater/-base station. | Change your location. Moving a few yards/meters in one direction or moving to a higher elevation can sometimes greatly improve communications range. |
| | A nearby device, such as an electric motor or light bulb, is causing interference on the radio frequency/channel. | Change your location. Moving a few yards/meters in one direction can sometimes greatly improve communications. |
| Keypad does not operate. | The keypad has temporarily failed. | Restart the radio by turning it off and back on. |
| Display does not operate. | The display has temporarily failed. | Restart the radio by turning it off and back on. |
| GPS cannot determine location/position | The GPS antenna is improperly connected to the radio, or the antenna is damaged/missing. | Connect the antenna and/or consult with your radio dealer as necessary. |
| | No GPS signal is being received. | Change your location and re-check for a signal. |

TROUBLESHOOTING AND TECHNICAL ASSISTANCE

TECHNICAL ASSISTANCE

When technical issues arise that cannot be resolved using the troubleshooting table, contact your radio equipment dealer for solution assistance. Also contact your radio equipment dealer for specific information about how the radio is programmed.

CARE AND CLEANING

Ensure optimal radio performance as well as a long service life by following these care and cleaning tips:

RADIO CARE

- Review and follow all precautions described in the radio's *Product Safety Booklet*.
- Do not hold the radio by its antenna or by a cable connected to its accessory connector.
- Do not pierce or scrape the surface of the radio or its accessories.
- Always replace the accessory connector's cover when an accessory cable is not connected to the radio.
- Do not place the radio or any radio accessories in corrosive agents, solutions, gas mixers, or water.

RADIO CLEANING



Turn the radio **off** before cleaning it.

- On a regular basis, clean dust and fine particles from the radio and any accessories with a clean, dry, lint-free cloth or a fine brush.
- After long periods of use, gently clean the radio's keys, control knobs, display, and jacks/connectors with a non-woven fabric and a neutral-base cleanser or mild soap. Do not use chemical preparations such as stain removers, alcohol, sprays, or oils.
- Always allow the radio and its accessories to dry completely before turning the radio back on.

MODEL NUMBERS

RADIO PACKAGES

| MODEL NUMBER | DESCRIPTION |
|---------------------|---|
| HD-PFV1B | Momentum HDP150 Portable Radio, 136 to 174 MHz, with GPS and Standard Accessories |
| HD-PFV1B-MD | Momentum HDP150 Portable Radio, 136 to 174 MHz, with GPS and Man Down, and Standard Accessories |
| HD-PFV1B-TXR | Momentum HDP150 Portable Radio, 136 to 174 MHz, with GPS (radio only) |
| HD-PFV1B-MD-TXR | Momentum HDP150 Portable Radio, 136 to 174 MHz, with GPS and Man Down (radio only) |
| HD-PFU1B | Momentum HDP150 Portable Radio, 400 to 470 MHz, with GPS and Standard Accessories |
| HD-PFU1B-MD | Momentum HDP150 Portable Radio, 400 to 470 MHz, with GPS and Man Down, and Standard Accessories |
| HD-PFU1B-TXR | Momentum HDP150 Portable Radio, 400 to 470 MHz, with GPS (radio only) |
| HD-PFU1B-MD-TXR | Momentum HDP150 Portable Radio, 400 to 470 MHz, with GPS and Man Down (radio only) |
| HD-PFU2B | Momentum HDP150 Portable Radio, 450 to 520 MHz, with GPS and Standard Accessories |
| HD-PFU2B-MD | Momentum HDP150 Portable Radio, 450 to 520 MHz, with GPS and Man Down, and Standard Accessories |
| HD-PFU2B-TXR | Momentum HDP150 Portable Radio, 450 to 520 MHz, with GPS (radio only) |
| HD-PFU2B-MD-TXR | Momentum HDP150 Portable Radio, 450 to 520 MHz, with GPS and Man Down (radio only) |

MODEL NUMBERS



Standard accessories include one of each item pictured on page 5 (less the radio). Respective part numbers are listed in the tables that follow. Each radio is supplied with one (1) standard antenna, one (1) standard battery, one (1) standard battery charger with power adapter, and various carrying accessories as pictured on page 5.

ANTENNAS

| MODEL NUMBER | DESCRIPTION | STANDARD/OPTIONAL |
|--------------|-------------------------------|-------------------|
| HD-AN6K-01 | Antenna, 136 to 147 MHz, Long | Standard |
| HD-AN6K-02 | Antenna, 136 to 174 MHz, Long | Standard |
| HD-AN6K-03 | Antenna, 147 to 160 MHz, Long | Standard |
| HD-AN6K-04 | Antenna, 160 to 174 MHz, Long | Standard |
| HD-AN6L-03 | Antenna, 400 to 470 MHz, Stub | Standard |
| HD-AN6L-04 | Antenna, 450 to 520 MHz, Stub | Standard |

MODEL NUMBERS

BATTERIES AND BATTERY CHARGERS

| MODEL NUMBER | DESCRIPTION | STANDARD/OPTIONAL |
|---------------------|--|--------------------------|
| HD-PA2V | Battery, Lithium-Ion 2000 mAH | Standard |
| HD-PA2Y | Battery, Lithium-Ion 2500 mAH | Optional |
| HD-CH4D | Charger, Battery: 1-Bay with Power Adapter | Standard |
| HD-CH4F | Charger, Battery: 6-Bay | Optional |
| HD-PS2V | Power Supply, 6-Unit, Switching | Optional |
| HD-PS2T | Adapter, AC Power, 100 to 240 Vac at 50/60 Hz Input, 12 Vdc Output | Optional |

CARRYING ACCESSORIES

| MODEL NUMBER | DESCRIPTION | STANDARD/OPTIONAL |
|---------------------|---------------------------|--------------------------|
| HD-HC3M | Clip, Belt | Standard |
| HD-HC3R | Strap, Wrist | Standard |
| HD-CL3N | Case, Leather with Swivel | Optional |

MODEL NUMBERS

AUDIO ACCESSORIES

| MODEL NUMBER | DESCRIPTION | STANDARD/OPTIONAL |
|---------------------|--|--------------------------|
| HD-AE6P | Earpiece with On-Mic PTT | Optional |
| HD-AE6R | Earpiece with 3-Wire Surveillance Kit | Optional |
| HD-AE6S | D-Earset with In-Line Mic and PTT | Optional |
| HD-AE6U | Earbud with On-Mic PTT | Optional |
| HD-AE6V | Earbud, Receive-Only | Optional |
| HD-AE6W | Speaker-Mic, Waterproof | Optional |
| HD-AE6Y | Earpiece, Receive-Only | Optional |
| HD-AE6Z | Earpiece, 2-Wire, Wireless Earphone/Neck | Optional |

WARRANTY REGISTRATION AND WARRANTY

WARRANTY REGISTRATION

Please register this product within ten (10) days of purchase. Registration validates the warranty coverage, and enables Harris to contact you in case of any safety notifications issued for this product.

Registration can be made on-line at <http://www.pspc.harris.com/Service/WarrantySupport.asp>.

EQUIPMENT AND RECHARGEABLE BATTERY WARRANTY

- A. Harris Corporation, a Delaware Corporation, acting through its RF Communications Division (hereinafter "Seller") warrants to the original purchaser for use (hereinafter "Buyer") that Momentum™ Equipment manufactured by or for the Seller shall (i) be free from all defects in material, workmanship and title; and (ii) comply with all of the Momentum™ Equipment Product Specifications. For purposes of this warranty, batteries shall be deemed defective if: (1) the battery capacity is less than 80% rated capacity, or (2) the battery develops leakage.
- B. Seller's obligations set forth in Paragraph C below shall apply only to Momentum™ Equipment failures to meet the above warranties occurring within the following periods of time from the date of sale to the Buyer and are conditioned on Buyer's giving written notice to Seller within thirty (30) days of such occurrence:
 1. for portable radios, mobile radios, repeaters and base stations, thirty-six (36) months (except as noted in paragraph B.2 and B.3);
 2. rechargeable batteries and accessories, twelve (12) months; and,
 3. all other parts, ninety (90) days.
- C. If any Momentum™ Equipment fails to meet the foregoing warranties, Seller shall correct the failure at its option (i) by repairing any defective or damaged part or parts thereof, or (ii) by replacing the failed Momentum™ Equipment with equivalent new or refurbished Equipment. Any repaired or replacement products or parts furnished hereunder shall be warranted for the balance of the original applicable Product Warranty Period or one hundred eighty (180) days for Products (other than batteries, accessories and parts) and ninety (90) days for batteries and accessories, whichever ends later. Where such failure cannot be corrected by Seller's reasonable efforts, the parties will negotiate an equitable adjustment in price. Labor to perform warranty service will be provided at no charge during the warranty period only for the Equipment

WARRANTY REGISTRATION AND WARRANTY

covered under Paragraph B. To be eligible for no-charge labor, service must be performed at Seller's location or other Servicer approved by Seller in writing to make the specific repairs at its place of business during normal business hours. Seller shall pay all freight charges relating to the return and shipment of the defective Products and the repaired or replacement Products to and from the Seller designated location. If it is determined that the Products are not under warranty, Buyer shall pay all freight charges related to the return and shipment of the Products and the repaired or replacement Products to and from the Seller designated location.

- D. Seller's obligations under Paragraph C shall not apply to any Equipment or part thereof, which:
1. has a defect that is not reported during the Product Warranty Period;
 2. is disassembled, modified, altered or repaired other than pursuant to Seller's written instructions or other written approval by Seller;
 3. is not installed, operated or maintained in accordance with written instructions provided by Seller;
 4. has its serial number removed or altered;
 5. is not properly stored or suffers detrimental exposure or is treated with abuse, negligence or other improper treatment; or,
 6. is damaged in an accident or in a natural disaster (earthquake, storm, flood, fire or other natural disaster).
- E. The preceding paragraphs set forth the exclusive remedies for claims based upon defects in or nonconformity of the Momentum™ Equipment, whether the claim is in contract, warranty, tort (including negligence), strict liability or otherwise and however instituted. Upon the expiration of the warranty period, all such liability shall terminate. The foregoing warranties are exclusive and in lieu of all other warranties, whether oral, written, expressed, implied or statutory. **NO IMPLIED OR STATUTORY WARRANTIES OF MERCHANTABILITY OR FITNESS FOR PARTICULAR PURPOSE SHALL APPLY. IN NO EVENT SHALL THE SELLER BE LIABLE FOR ANY INCIDENTAL, CONSEQUENTIAL, SPECIAL, INDIRECT OR EXEMPLARY DAMAGES.**

This warranty applies only within the United States.

Contact your local Harris Dealer to request warranty service.

ECR-7931