

*Rear Cover of Manual*

*Front Cover of Manual*

momentum™

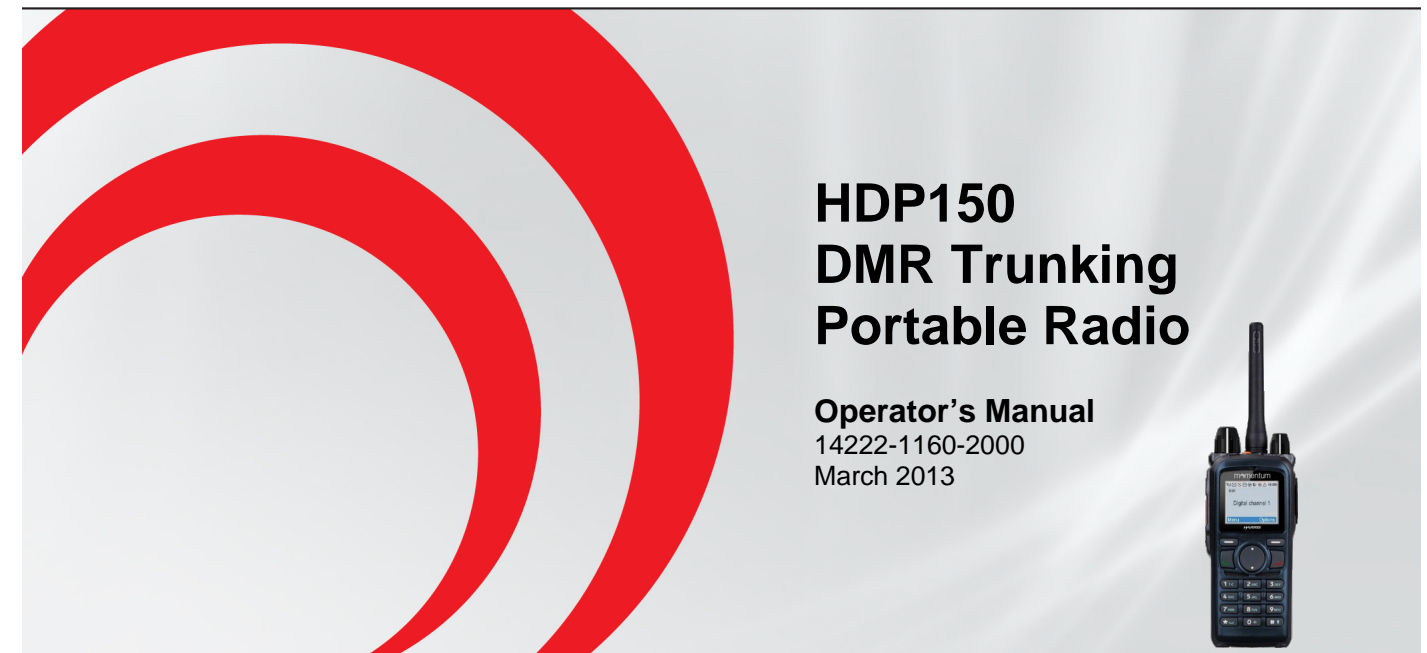

**HARRIS**  
assuredcommunications\*

Public Safety and Professional Communications  
221 Jefferson Ridge Parkway | Lynchburg, VA USA 24501  
www.pspc.harris.com | 1-800-528-7711

**HARRIS**

**DMR**  
DIGITAL MOBILE RADIO ASSOCIATION

**ADDENDUM NUMBER 1 TO OPERATOR'S MANUAL  
14222-1160-2000**

This addendum corrects 800/900 MHz HDP150 radio model numbers. Replace the table at the top of page **64** with the following table:

<b>MODEL NUMBER</b>	<b>DESCRIPTION</b>
HD-PF89B	Momentum HDP150 Portable Radio, 800/900 MHz, 3/2.5 Watts, with Standard Accessories
HD-PF89B-MD	Momentum HDP150 Portable Radio, 800/900 MHz, 3/2.5 Watts, with Man Down and Standard Accessories



Public Safety and Professional Communications  
221 Jefferson Ridge Parkway | Lynchburg, VA USA 24501  
[www.pspc.harris.com](http://www.pspc.harris.com) | 1-800-528-7711

#### MANUAL REVISION HISTORY

REV.	DATE	REASON FOR CHANGE
-	Mar/13	Original release.

Harris Corporation, Public Safety and Professional Communications (PSPC) Business continually evaluates its technical publications for completeness, technical accuracy, and organization. You can assist in this process by submitting your comments and suggestions to the following:

**Harris Corporation** fax your comments to: 1-434-455-6851  
PSPC Business or email us at:  
Technical Publications [PSPC-TechPubs@harris.com](mailto:PSPC-TechPubs@harris.com)  
221 Jefferson Ridge Parkway  
Lynchburg, VA 24501

#### ACKNOWLEDGEMENT

This device is made under license under one or more of the following US patents: 4,590,473; 4,636,791; 5,148,482; 5,185,796; 5,195,166; 5,271,017; 5,377,229; 4,716,407; 4,972,460; 5,502,767; 5,146,497; 5,164,986; 5,185,795; 5,226,084; 5,247,579; 5,491,772; 5,517,511; 5,581,656; 5,630,011; 5,649,050; 5,701,390; 5,715,365; 5,754,974; 5,826,222; 5,870,405; 6,161,089; 6,199,037 B1 and 6,912,495 B2. DVSI claims certain rights, including patent rights under aforementioned U.S. patents, and under other U.S. and foreign patents and patents pending. Any use of this software or technology requires a separate written license from DVSI.

#### CREDITS

Harris and assuredcommunications are registered trademarks of and Momentum is a trademark of Harris Corporation.

#### NOTICE!

The material contained herein is subject to U.S. export approval. No export or re-export is permitted without written approval from the U.S. Government. Rated: EAR99 in accordance with U.S. Dept. of Commerce regulations 15CFR774, Export Administration Regulations.

## NOTICE!

Information and descriptions contained herein are the property of Harris Corporation. Such information and descriptions may not be copied or reproduced by any means, or disseminated or distributed without the express prior written permission of Harris Corporation, PSC Business, 221 Jefferson Ridge Parkway, Lynchburg, VA 24501.

The voice coding technology embodied in this product is protected by intellectual property rights including patent rights, copyrights, and trade secrets of Digital Voice Systems, Inc. The user of this technology is explicitly prohibited from attempting to decompile, reverse engineer, or disassemble the Object Code, or in any other way convert the Object Code into human-readable form.

Repairs to this equipment should be made only by an authorized service technician or facility designated by the supplier. Any repairs, alterations or substitutions of recommended parts made by the user to this equipment not approved by the manufacturer could void the user's authority to operate the equipment in addition to the manufacturer's warranty.



This product conforms to the European Union WEEE Directive 2002/96/EC. Do not dispose of this product in a public landfill. Take it to a recycling center at the end of its life.

This manual is published by **Harris Corporation** without any warranty. Improvements and changes to this manual necessitated by typographical errors, inaccuracies of current information, or improvements to programs and/or equipment, may be made by **Harris Corporation** at any time and without notice. Such changes will be incorporated into new editions of this manual. No part of this manual may be reproduced or transmitted in any form or by any means, electronic or mechanical, including photocopying and recording, for any purpose, without the express written permission of **Harris Corporation**.

Copyright© 2013, Harris Corporation

**TABLE OF CONTENTS**

<u>Section</u>	<u>Page</u>
<b>SYMBOLS USED IN THIS MANUAL</b> .....	<b>1</b>
CAUTION AND NOTE SYMBOLS.....	1
<b>REGULATORY INFORMATION</b> .....	<b>2</b>
PRODUCT SAFETY BOOKLET.....	2
RF EXPOSURE GUIDELINES.....	2
ELECTROMAGNETIC INTERFERENCE.....	4
FCC Part 15 Statement.....	4
Industry Canada Statement.....	4
EU REGULATORY CONFORMANCE.....	4
<b>CHECKING ITEMS IN THE PACKAGE</b> .....	<b>5</b>
<b>RADIO OVERVIEW</b> .....	<b>6</b>
RADIO CONTROLS, INDICATORS, AND OTHER ITEMS.....	6
PROGRAMMABLE SHORTCUT KEYS.....	7
<b>BEFORE USING THE RADIO</b> .....	<b>9</b>
CHARGING THE BATTERY.....	9
ASSEMBLY AND DISASSEMBLY.....	10
Attaching and Removing the Antenna.....	10
Attaching the Battery.....	10
Removing the Battery.....	10
Attaching the Belt Clip.....	11
Removing the Belt Clip.....	11
Attaching the Audio Accessory/Programming Cable.....	11
Removing an Accessory/Programming Cable.....	12
<b>RADIO STATUS INDICATORS</b> .....	<b>13</b>
OPERATIONAL MODE AND STATUS ICONS THE DISPLAY.....	13
LED INDICATOR.....	15
<b>BASIC OPERATIONS</b> .....	<b>16</b>

## TABLE OF CONTENTS

<i>Section</i>	<i>Page</i>
TURNING THE RADIO ON AND OFF AND ADJUSTING VOLUME .....	16
REGISTERING ON A TRUNKED RADIO SYSTEM .....	16
Hunting .....	16
Registration .....	16
HOME SCREEN .....	17
SELECTING A SUBGROUP .....	17
SELECTING A GROUP .....	17
LOCKING AND UNLOCKING THE KEYPAD AND KNOBS .....	18
PRIVATE CALLS .....	19
Transmitting a Private Call .....	19
Receiving and Responding to a Private Call .....	21
Additional Information on Private Calls .....	22
TELEPHONE INTERCONNECT CALLS .....	23
Transmitting a Telephone Interconnect Call .....	23
Receiving and Responding to a Telephone Interconnect Call .....	25
Additional Information on Telephone Interconnect Calls .....	26
GROUP CALLS .....	27
GROUP ATTRIBUTES .....	27
Transmitting a Group Call .....	28
Receiving and Responding to a Group Call .....	30
Additional Information on Group Calls .....	30
BATTERY STRENGTH INDICATOR .....	33
<b>MENU NAVIGATION AND OPERATIONS .....</b>	<b>34</b>
MENU STRUCTURE .....	34
CONTACT MENU .....	35
Contact List .....	35
New Contact .....	35
MESSAGE MENU .....	36

**TABLE OF CONTENTS**

<u>Section</u>	<u>Page</u>
New Msg .....	36
Quick Text.....	36
Status Message .....	36
InBox .....	36
OutBox .....	37
Drafts.....	37
Sending a Message .....	38
CALL LOGS MENU .....	39
HUNT MENU.....	40
TSCC Hunt.....	40
Hunt for Smooth Communications (after Registration).....	42
SUBGROUP MENU.....	43
SETTINGS MENU .....	44
Radio Set .....	44
Device Info.....	46
ACCESSORIES MENU .....	46
GPS .....	46
MODE MENU .....	46
<b>EMERGENCY COMMUNICATIONS .....</b>	<b>48</b>
GENERAL INFORMATION .....	48
SENDING AN EMERGENCY CALL .....	48
By a Programmed Shortcut Key .....	48
By the Man Down Feature.....	48
By Manual Dial .....	48
RECEIVING AN EMERGENCY CALL .....	49
VOICE COMMUNICATIONS ON AN EMERGENCY CALL .....	49
ENDING AN EMERGENCY CALL.....	49
MAN DOWN.....	50

## TABLE OF CONTENTS

<u>Section</u>	<u>Page</u>
Manually Enabling and Disabling Man Down.....	50
Using Man Down.....	50
<b>MISCELLANEOUS FEATURES.....</b>	<b>51</b>
MANUAL DIAL.....	51
Operation.....	51
CPS-P Dialing.....	51
CPS-P3 Dialing.....	51
1343-E Dialing.....	52
CALL QUEUING.....	52
TIME-OUT TIMER (TOT).....	53
MICROPHONE AUTOMATIC GAIN CONTROL (AGC).....	53
VOICE-OPERATED SWITCH (VOX).....	53
Turning VOX On and Off.....	53
Setting VOX Sensitivity Level.....	54
LOUDNESS AND QUALITY OPTIMIZER (LQO).....	54
RENT.....	55
PRIORITY.....	55
COVERT MODE.....	56
ENCRYPTION.....	56
AUTHENTICATION.....	56
ONE TOUCH CALL.....	57
ENTERING LETTERS, NUMBERS, AND OTHER CHARACTERS VIA THE KEYPAD.....	57
Upper and Lower Case Letters.....	57
Numbers.....	57
Punctuation Characters and Special Characters.....	58
Moving Cursor Position.....	58
<b>TROUBLESHOOTING AND TECHNICAL ASSISTANCE.....</b>	<b>59</b>
TROUBLESHOOTING TABLE.....	59



**TABLE OF CONTENTS**

<u>Section</u>	<u>Page</u>
TECHNICAL ASSISTANCE.....	61
<b>CARE AND CLEANING .....</b>	<b>62</b>
RADIO CARE .....	62
RADIO CLEANING.....	62
<b>MODEL NUMBERS .....</b>	<b>63</b>
RADIO PACKAGES .....	63
ANTENNAS .....	64
BATTERIES AND BATTERY CHARGERS .....	65
CARRYING ACCESSORIES .....	65
AUDIO ACCESSORIES .....	66
<b>WARRANTY REGISTRATION AND WARRANTY.....</b>	<b>67</b>
WARRANTY REGISTRATION.....	67
EQUIPMENT AND RECHARGEABLE BATTERY WARRANTY .....	67



*(This Page Intentionally Blank)*





**x**

## SYMBOLS USED IN THIS MANUAL

The following table lists symbols used in this manual. These symbols do not appear in the radio's display.

### CAUTION AND NOTE SYMBOLS

SYMBOL	DESCRIPTION
 WARNING	The <b>WARNING</b> symbol calls attention to a procedure, practice, or the like, which, if not correctly performed or adhered to, could result in personal injury. Do not proceed beyond a WARNING symbol until the conditions identified are fully understood or met.
 CAUTION	The <b>CAUTION</b> symbol calls attention to an operating procedure, practice, or the like, which, if not performed correctly or adhered to, could result in damage to the equipment or severely degrade equipment performance.
 NOTE	The <b>NOTE</b> symbol calls attention to supplemental information, which may improve system performance or clarify a process or procedure. It may also be used to flag tips that can help you make better use of the radio.

## **REGULATORY INFORMATION**

---

### **PRODUCT SAFETY BOOKLET**



**Before operating the HDP150 portable radio, read the safety and RF exposure guidelines contained in *Product Safety Booklet* included with the radio.**

### **RF EXPOSURE GUIDELINES**



**The HDP150 portable radio generates RF electromagnetic energy during transmit mode. This radio is designed for and classified as “Occupational Use Only,” meaning it must be used only during the course of employment by individuals aware of the hazards and the ways to minimize such hazards. This radio is NOT intended for use by the “General Population” in an uncontrolled environment.**

The HDP150 radio has been tested and complies with the Federal Communications Commission (FCC) RF exposure limits for “Occupational Use Only.” In addition, this radio complies with the following Standards and Guidelines with regard to RF energy and electromagnetic energy levels and evaluation of such levels for exposure to humans:

- FCC Office of Engineering and Technology (OET) Bulletin 65 Edition 97-01 Supplement C, Evaluating Compliance with FCC Guidelines for Human Exposure to Radio Frequency Electromagnetic Fields.
- American National Standards Institute (C95.1 – 1992), IEEE Standard for Safety Levels with Respect to Human Exposure to Radio Frequency Electromagnetic Fields, 3 kHz to 300 GHz.
- American National Standards Institute (C95.3 – 1992), IEEE Recommended Practice for the Measurement of Potentially Hazardous Electromagnetic Fields – RF and Microwave.

## REGULATORY INFORMATION



To ensure exposure to RF electromagnetic energy is within the FCC allowable limits for occupational use, always adhere to the following guidelines:

- DO NOT operate the radio without a proper antenna attached, as this may damage the radio and may also cause the FCC RF exposure limits to be exceeded. A proper antenna is the antenna supplied with this radio by Harris or an antenna specifically authorized by Harris for use with this radio.
- DO NOT transmit for more than 50% of total radio use time (“50% duty cycle”). Transmitting more than 50% of the time can cause FCC RF exposure compliance requirements to be exceeded. The radio is transmitting when the LED indicator on the top of the radio lights red in color. The radio transmits when its “PTT” (Push-To-Talk) key is pressed.
- Always transmit using low power when possible. In addition to conserving battery charge, low power can reduce RF exposure. Refer to page 44 for additional information.
- ALWAYS use Harris authorized accessories (antennas, batteries, belt clips, speaker/mics, etc). Use of unauthorized accessories may cause the FCC Occupational/Controlled Exposure RF compliance requirements to be exceeded.
- ALWAYS keep the device and its antenna at least 1 inch (2.5 centimeters) from the body and face when transmitting to ensure FCC RF exposure compliance requirements are not exceeded. To provide the best sound quality to the recipients of your transmission, Harris recommends holding the front of the radio between 1 and 2 inches (2.5 to 5.0 centimeters) from your mouth when transmitting into the radio’s microphone.



For addition information on RF exposure, refer to the *Product Safety Booklet* included with the radio.

## **REGULATORY INFORMATION**

---

### **ELECTROMAGNETIC INTERFERENCE**

During transmissions, this radio generates RF energy that can possibly cause interference with other devices or systems. To avoid such interference, turn off the radio in areas where signs are posted to do so. **DO NOT** operate the transmitter in areas that are sensitive to electromagnetic radiation such as hospitals, aircraft, and blasting sites.

### **FCC Part 15 Statement**

This device complies with Part 15 of the FCC Rules. Operation is subject to the following two conditions:

1. This device may not cause harmful interference, and
2. This device must accept any interference received, including interference that may cause undesired operation.

### **Industry Canada Statement**

This device complies with Industry Canada license-exempt RSS standard(s). Operation is subject to the following two conditions: (1) this device may not cause interference, and (2) this device must accept any interference, including interference that may cause undesired operation of the device.

Le présent appareil est conforme aux CNR d'Industrie Canada applicables aux appareils radio exempts de licence. L'exploitation est autorisée aux deux conditions suivantes : (1) l'appareil ne doit pas produire de brouillage, et (2) l'utilisateur de l'appareil doit accepter tout brouillage radioélectrique subi, même si le brouillage est susceptible d'en compromettre le fonctionnement.







### **EU REGULATORY CONFORMANCE**

This information applies to VHF, UHF1, and UHF2 radios only: As certified by the qualified laboratory, the product is in compliance with the essential requirements and other relevant provisions of the Directive 1999/5/EC. This applies to EU countries only.

**CE0678!**

## CHECKING ITEMS IN THE PACKAGE

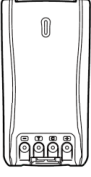
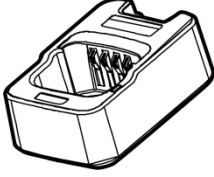
Carefully unpack and check that all items listed below are received. If any item is missing or damaged, please immediately contact your dealer.

 <p>Antenna</p>	 <p>Operator's Manual, Product Safety Booklet, Quick Guide</p>	 <p>Power Adapter</p>	 <p>Belt Clip</p>
 <p>Radio</p>	 <p>Battery</p>	 <p>Battery Charger</p>	 <p>Wrist Strap</p>



NOTE

The antenna may vary with different frequency bands. The frequency band is marked on the label of antenna. If not, refer to the label on the radio unit for frequency band information.

## RADIO OVERVIEW

### RADIO CONTROLS, INDICATORS, AND OTHER ITEMS

ITEM	NAME		ITEM	NAME
1	Side Key 1 (SK1)		12	LED Indicator
2	Push-To-Talk (PTT) Key		13	Antenna
3	Side Key 2 (SK2)		14	On/Off/Volume Control Knob
4	Top Key (TK)		15	Accessory Jack
5	Group Call Selector Knob		16	Back/Subgroup Key
6	Microphone		17	Dial-Back/End/Home Screen Key
7	Liquid Crystal Display (LCD)		18	Up Key
8	OK/Menu Key		19	Down Key
9	Answer/Redial/Call Key		20	Battery Latch
10	Speaker		21	Belt Clip
11	Keypad		22	Battery
	Top View			
	Bottom View			



## RADIO OVERVIEW

### PROGRAMMABLE SHORTCUT KEYS

For enhanced convenience, you may request your dealer pre-program keys **SK1**, **SK2**, and **TK** as shortcuts to any of the functions listed in the table that follows.

Long and short presses of a key can be programmed with different functions by your radio dealer. Therefore, up to six (6) different functions can be assigned to the three (3) programmable keys. A short press is a quick press and release of the key. A “long press” means to press and hold the key for a longer period to activate that function. By default, the programmable time period for a long press is two (2) seconds.



NOTE

By default, a short press of the Top Key (TK) is programmed for the Emergency On function, and a long press of this key is programmed for the Emergency Off function. However, this key may be programmed for other functions by your radio dealer.

NO.	SHORTCUT NAME	SHORTCUT KEY FUNCTION
1	Clear Down	Disconnects a call.
2	Keypad Lock	Lock or unlock the keypad. See page 18.
3	Adjust Power Level	Quickly change the radio's transmitting power level. See page 44.
4	Battery Strength Indicator	Display remaining battery strength. See page 33.
5	Private Contact List	Quick access to the Private Call Contact list. See page 35.
6	Current Subgroup Contact	Quick access to the Subgroup List menu. See pages 17 and 43.
7	Group Call List	Quick access to the Group Call list. See page 28.
8	Call Log	Quick access to the Call Logs menu. See page 39.
9	Operation Mode	Quick access to the Mode menu. See page 46.
10	Hunt Mode	Quick access to the Hunt menu. See page 40.
11	Manual Current Hunt	Sets the radio to hunt in the preset hunt mode. See pages 16 and 40.

## **RADIO OVERVIEW**

<b>NO.</b>	<b>SHORTCUT NAME</b>	<b>SHORTCUT KEY FUNCTION</b>
12	Background Hunt	Enables and disables the Background Hunt feature. See page 42.
13	Home Station Hunt	Enables and disables the Home Station Hunt feature. See page 42.
14	Handover Hunt	Enables and disables the Handover Hunt feature. See page 43.
15	Encrypt	Enables and disables encrypted voice and message transmissions for secure communications. See page 56.
16	LQO	Enable and disable the Loudness and Quality Optimizer (LQO). See page 54.
17	Covert Mode	Enable and disable the Covert feature. See page 56.
18	Emergency On	Turn on the emergency mode and transmit emergency call/signaling. See page 48.
19	Emergency Off	Turn off the emergency call/signaling, exiting emergency mode.
20	Man Down	Activates this emergency feature so if the radio is positioned at an angle for a preset period of time, it will begin emergency transmissions. See page 50.
21	Message	Quick access to Message menu. See page 36.
22	ReDial Call	Use to quickly re-call the last called radio. See page 20, 24, or 29.
23	BackDial Call	Use to quickly call the last calling radio. See page 20, 24, or 29.
24	Operation Mode Switch	Quickly changes the operating mode of the radio. See page 46.
25	One Touch Call (1 though 5)	Quickly make calls or send messages. See page 57.
26	VOX	Enable and disable the Voice-Operated Switch (VOX) feature. See page 53.

## BEFORE USING THE RADIO

### CHARGING THE BATTERY





Follow this procedure to charge the radio's battery:

1. Connect the AC power adapter to an AC power source. See arrow ❶.
2. Connect the small plug of the power adapter into the jack at the rear of the charger. See arrow ❷.
3. Place the radio with the battery attached, or just the battery alone, into the slot in the top of the charger. See arrow ❸.



The radio must be powered **off** when an attached battery is charging. Use only the Harris charger and AC power adapter. **Please read the radio's *Product Safety Booklet* for additional information.**

4. Refer to the following table for charge status, as indicated by the charger's status indicator.

STATUS INDICATOR	CHARGE STATUS
Flashes Red Slowly 	Standby (No Load/No Battery)
Glow Red 	Battery Charging
Flashes Red Rapidly 	Battery or Charger Failure
Glow Orange 	Battery 90% Charged
Glow Green 	Battery Fully Charged

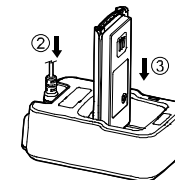
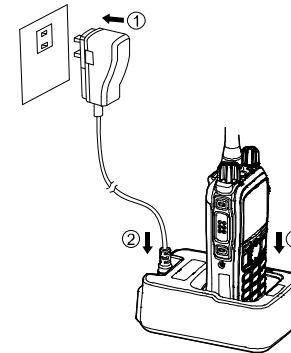

To achieve optimal battery performance, charge the battery five (5) hours before its initial use.

## **BEFORE USING THE RADIO**

### **ASSEMBLY AND DISASSEMBLY**

#### **Attaching and Removing the Antenna**

To attach the antenna to the radio, place its base into the antenna jack on the top of the radio and turn the antenna in a clockwise direction.

To remove the antenna from the radio, turn the antenna in a counter-clockwise direction until it is free from the radio.

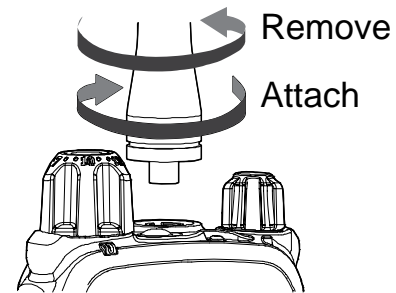

#### **Attaching the Battery**

To attach the battery to the radio:

1. Slide the top of the battery completely into the cavity at the rear of the radio. See arrow ①.
2. Gently press on the bottom of the battery until a click is heard. See arrow ②. This locks the battery to the radio.

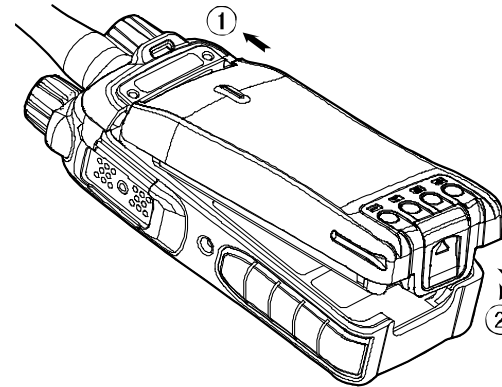

#### **Removing the Battery**

To remove the battery from the radio:

1. Turn off the radio by rotating its on/off/volume control to the full counter-clockwise position.
2. Grasp the radio firmly in one hand in a bottoms-up position.
3. Using the other hand, slide the battery latch up to unlatch the battery, and remove the battery from the radio.

## ***BEFORE USING THE RADIO***

### **Attaching the Belt Clip**

To attach the belt clip to the radio:

1. Remove the two (2) screws on the rear of the radio.
2. As illustrated, align the screw holes on the belt clip with those on the radio and re-install the two screws into the holes.
3. Using a small screwdriver, tighten the two screws securely. Do not over-tighten them.

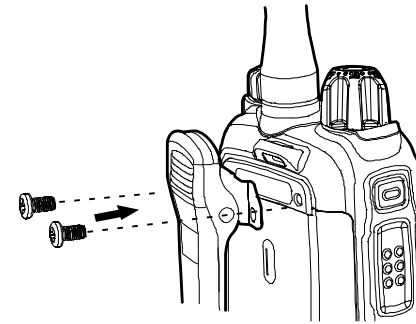

### **Removing the Belt Clip**

To remove the belt clip, use a small screwdriver to loosen and remove the two (2) screws that secure the clip to the radio, and then remove the it from the radio.

### **Attaching the Audio Accessory/Programming Cable**

To attach an audio accessory or a programming cable to the radio:

1. Open the accessory jack cover, as illustrated by arrow ①.
2. Align the threaded portion of the cable's screw with the threaded hole in the center of the jack.



Do not scrape the silicon rubber on the accessory jack. Scrapes and/or scratches in this area could permanently affect the waterproof performance of the radio. **Correct and incorrect alignment is shown in the illustration on the next page.**

3. Join the screw to the thread hole and tighten the screw by the knob on the cable's plug. See arrow ②.

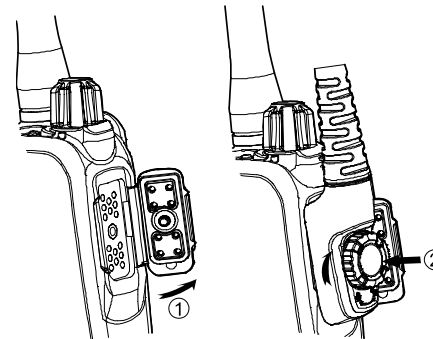

## ***BEFORE USING THE RADIO***

**CORRECT  
ALIGNMENT**

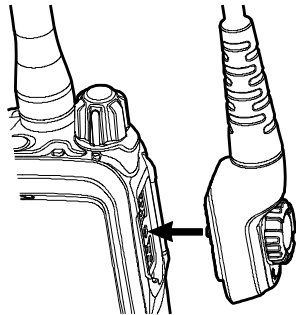

**INCORRECT  
ALIGNMENT**

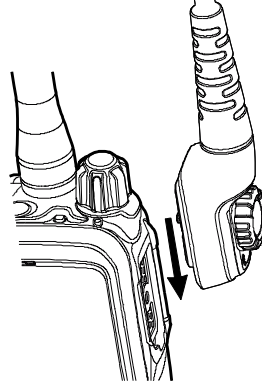

**INCORRECT  
ALIGNMENT**

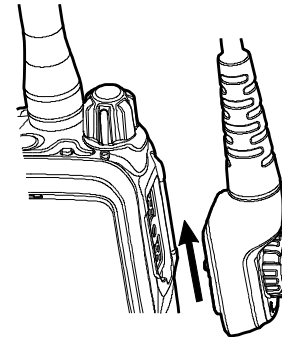

When an external accessory is attached to the radio's accessory jack, waterproof performance of the radio may be affected.







### **Removing an Accessory/Programming Cable**

To remove a cable from the radio's accessory jack, simply loosen its screw and detach the cable from the jack.



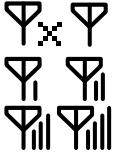





## **RADIO STATUS INDICATORS**

### **OPERATIONAL MODE AND STATUS ICONS THE DISPLAY**

The radio has an operational mode icon and multiple status icons that appear in the display. These icons are illustrated and described in the following table.

<b>ICON NAME</b>	<b>ICON</b>	<b>DESCRIPTION</b>
Trunked Mode	TM	This operational mode icon indicates the radio is operating in trunked mode (TMO). In this mode, radios communicate with each other via the trunking radio system.
Hunt Icon		The radio is hunting. See pages 16 and 40. This does not include background hunt, home station hunt, and multi-site handover.
Roam Icon		The radio is roaming.
Speaker Icon		The speaker is unmuted.
RSSI Icons		Received-Signal Strength Indication (RSSI) icons appear in the upper left corner of the display. They indicate the relative strength of the received radio signal. When  (the RSSI icon with no bars but followed by an "x") appears, no radio signal is being received. More bars on an RSSI icon indicate better signal strength.
Transmit (Tx) Power Level Icons		Low transmit power for the selected group/channel.
		High transmit power for the selected group/channel.

## **RADIO STATUS INDICATORS**









<b>ICON NAME</b>	<b>ICON</b>	<b>DESCRIPTION</b>
Battery Strength Icons		These icons indicate the relative strength of the battery. An icon with more bars indicates more remaining battery operating time. No bars and beeps indicates the battery needs charging immediately.
Accessory Icon		This icon appears in the display when an accessory is connected to the radio's accessory connector.
Message Icons		New message/unread message.
		InBox is full.
VOX Icon		The Voice-Operated Switch (VOX) feature is active.
GPS Icons		The Global Positioning System (GPS) feature is active and valid GPS data is being received.
		The GPS feature is active but no valid GPS data is being received.
LQO Icon		The Loudness and Quality Optimizer (LQO) feature is active.



## RADIO STATUS INDICATORS

### LED INDICATOR

A light-emitting diode (LED) type status indicator is located on the top of the radio, near the On/Off/Volume Control Knob. This indicator can be quickly viewed to determine the basic operational status of the radio. Each status indication is described in the table to the right.

LED INDICATOR	RADIO STATUS
Flashing Green Rapidly (approximately twice every 1 sec.) 	Powering on
Flashing Green Slowly (approximately once every 2 sec.) 	Standby
Glowing Green 	Receiving
Glowing Red 	Transmitting
Flashing Red 	Making a Call (the LED indicator on the called radio flashes)
Flashing Orange Rapidly (approximately twice every 1 sec.) 	Making a FOACSU private call (the LED indicator on the called radio flashes)
Flashing Orange Slowly (approximately once every 2 sec.) 	Hunting
Glowing Orange 	No voice is being transmitted or received on the traffic channel after call establishment. During this period, it is OK to transmit voice audio by pressing the PTT key and speaking into the microphone.

## ***BASIC OPERATIONS***

---

### **TURNING THE RADIO ON AND OFF AND ADJUSTING VOLUME**

To turn on the radio, rotate its **On/Off Volume Control** knob clockwise out of the detent position. This knob is item 13 on page 6. A click will be sensed. The radio responds by displaying its power-up screen and its LED status indicator flashes green. To turn the radio off, rotate this knob fully counter-clockwise until the detent click is sensed.

Rotate this knob clockwise to increase volume and counter-clockwise to decrease volume. Adjustments affect both received call volume and group notification volume.

### **REGISTERING ON A TRUNKED RADIO SYSTEM**

To operate on a trunked radio system, the radio must first hunt to locate a control channel of an in-range trunked radio base station, and then successfully register with the station and the corresponding trunked radio system via the control channel.

#### **Hunting**

After turn on, the radio automatically begins hunting for control channels of available trunked base stations. During this time, it displays “Registering, Please Wait!” and the  icon. Also, the LED indicator on the top of the radio flashes orange slowly.

There are two hunting plans used for radio registration: TSCC Hunt with Fixed Control Channel and TSCC Hunt with Flexible Control Channel. The exact plan used by the radio is pre-programmed by your radio dealer. For additional information, refer to the **HUNT MENU** section that begins on page 40.

#### **Registration**

If a located trunked base station allows the radio to register, the radio does so and it displays “Registered Successfully!” At this time, radio is ready for normal use.

In this case, if registration with a different base station is desired, press the programmed **Manual Current Hunt** shortkey to start another hunt.

## **BASIC OPERATIONS**

### **HOME SCREEN**

The home screen is the default operating screen. It indicates the name of the selected subgroup, the name of the selected group, battery strength, the current transmit power level, receive signal strength, and other parameters.

To return to the home screen from any other screen/menu, press the  key one or more times. If the radio is not in an editing screen, only one press of this key is required to return to the home screen. If the radio is in an editing screen, more than one press is required to return to the home screen.

### **SELECTING A SUBGROUP**

The radio can be programmed with up to 32 subgroups. Each subgroup can have up to 16 groups. After the radio successfully registers on a trunked system, select a subgroup using either of the following methods:

- By Menu Selection — From the home screen, press the **Menu** key, select **Subgroup**, then use the **Up/Down** key to select the desired subgroup. Next, select **Set Default** and press the **OK** key to switch to that subgroup.
- By a Pre-Programmed Shortcut Key — From the home screen, press the **Subgroup** key (item 16 on page 6) to enter the subgroup menu, and then select the desired subgroup.

### **SELECTING A GROUP**

After the radio registers on a trunked system and a subgroup is selected, select a group using one of the following methods:

- By the Selector Knob — The radio's **Group Call Selector** knob is located on the top of the radio. It is item 5 on page 6, and it has 16 positions. Rotate this knob to select the desired group within the currently selected subgroup. The name of the selected group appears in the display. If no group has been pre-programmed at a selected knob position, the radio sounds an alert tone.
- By Menu Selection — From the home screen, press the **Menu** key, select **Subgroup > Members > Group Call** and then use the **Up/Down** key to select the desired group.

## **BASIC OPERATIONS**

---

- By a Group Call List Shortcut Key — If programmed, press the **Group Call List** shortcut key to access the group call list, and then select the desired group by pressing the **Up/Down** key.

### **LOCKING AND UNLOCKING THE KEYPAD AND KNOBS**

The radio's keys and control knobs can be manually or automatically locked to prevent unintentional activations. When a key or knob is locked, it is essentially disabled. Use one of the following methods to switch between a locked and an unlock condition:

- To toggle between locked and unlocked, press the **Menu** key and then press the **\*↵** key.
- If programmed, press the **Keypad Lock** shortcut key. Each press toggles between locked and unlocked. See page 7 for additional information on shortcut keys.
- For timed automatic locking, from the home screen, select **Menu > Settings > Radio Set > Keypad Lock > Enable** or **Disable**. This is the Keypad Auto-Lock feature. When this feature is enabled, the keypad and/or control knobs automatically lock if no key or knob operation is made within the preset time period. When disabled, automatic locking does not occur. This feature's time period can be set to between 5 and 60 seconds by pressing the **Up/Down** key just after selecting **Enabled**. Manual locking and unlocking can always be accomplished via the **Menu** and **\*↵** key, or if pre-programmed, via the **Keypad Lock** shortcut key (as described above).

To configure which keys and/or knobs lock during a locked condition, use the **Select Locked Key** menu. From the home screen, the menu path is **Menu > Settings > Radio Set > Select Locked Key > Enable** or **Disable**. Then use the **Select**, **Up/Down** and **Back** keys to configure each key/knob as **Enabled** (will lock) and **Disabled** (will not lock).

## BASIC OPERATIONS

### PRIVATE CALLS

A private call is a call from one radio user to another radio user. Two types of private calls are available per configuration performed by the trunked radio system's network management personnel. The configured type determines how the call is answered. The two types are:

**Full Off-Air Call Set-Up** — With FOACSU, both the calling radio and called radio ring before the called party answers the call. The call must be manually answered.

**Off-Air Call Set-Up** — With OACSU, the call is automatically placed without any indication from either the calling radio or called radio.



The radio cannot make private or group calls if it has not successfully registered with the trunked radio system. Also, group calls cannot be made if the **Group Call Selector** knob is in an unprogrammed position.

### Transmitting a Private Call



When transmitting a private call, the  icon displays. A private call can be transmitted using any method described in the following subsections.





When transmitting (i.e., **PTT** key depressed), hold the front of the radio between 1 to 2 inches (2.5 to 5.0 centimeters) from your mouth and speak into the microphone at a normal voice level. This will ensure optimal reception at the receiving radio unit(s). Never shout or whisper when transmitting. As illustrated on page 6, the radio's microphone is located just above the display.

### Transmitting a Private Call via the Contact List or Call Logs

1. While in the home screen, press the **Menu** key.
2. Select Contact > Contact List. Alternately, go to Call Logs and access the Outgoing/Incoming/Missed list.

## **BASIC OPERATIONS**





---

3. Press the **Up/Down** key to select the Private Call contact desired for calling. In this list, each Private Call contact name is preceded by a  icon.
4. Hold down the  key or the **PTT** key to transmit a private call to the selected contact, and speak into the microphone at a normal voice level.
5. Release the key to stop transmitting, and listen for a reply. See [Receiving and Responding to a Private Call](#) on page 21 for additional information.





A private call cannot be transmitted if the radio has not registered on the trunked radio system.

### ***Transmitting a Private Call via the ReDial or the BackDial Call Logs***

1. While in the home screen, press the  key to access the ReDial Call Log, or press the  key to access the BackDial Call Log.
2. Press the **Up/Down** key to select the Private Call contact desired for calling. In this list, each Private Call contact name is preceded by a  icon.
3. Hold down the  key or the **PTT** key to transmit a private call to the selected contact, and speak into the microphone at a normal voice level.
4. Release the key to stop transmitting, and listen for a reply. See [Receiving and Responding to a Private Call](#) on page 21 for additional information.

### ***Transmitting a Private Call via Manual Dial***

1. While in the home screen, use the radio's keypad to enter the number of the desired Private Call contact. For the valid numeric range, see the **MANUAL DIAL** section on page 51.
2. Hold down the  key, the **PTT** key, or the  key to transmit a private call to the contact, and speak into the microphone at a normal voice level.

## ***BASIC OPERATIONS***

3. Release the key to stop transmitting, and listen for a reply. See [Receiving and Responding to a Private Call](#) on page 21 for additional information.



A private call cannot be transmitted if the radio has not registered on the trunked radio system.



### ***Transmitting a Private Call via the Missed Call Screen***

1. To call back the last missed private call contact, while in the Missed Call screen, press and hold down the **PTT** key. Alternately, when viewing a number, press and hold down the  key or the **PTT** key to call back the radio with that number.
2. Speak into the microphone at a normal voice level.
3. Release the key to stop transmitting, and listen for a reply. See [Receiving and Responding to a Private Call](#) on page 21 for additional information.

### **Receiving and Responding to a Private Call**

#### ***Full Off-Air Call Set-Up (FOACSU) Configuration***



When a private call is received, the  icon displays and the radio rings. The radio may also be programmed to vibrate. To respond to the call, press and hold down the  key or the **PTT** key within the preset time period, and speak into the microphone at a normal voice level. Afterwards, the radio displays a  icon indicating the received private call has been answered. Release the key to stop transmitting, and listen for a reply.



If you do not respond to a received private call, the  missed call icon displays. In this case, the call can be replied to via the Missed Call screen, as previously described.

## ***BASIC OPERATIONS***

---



### ***Off-Air Call Set-Up (OACSU) Configuration***

The radio displays a  icon indicating the call was established.

### ***Additional Information on Private Calls***

#### ***Voice Communications***



When a radio displays a “PTT Enable” prompt after a private call is established, the radio user can begin transmitting voice by pressing the radio’s **PTT** key and speaking into its microphone. This applies at both the radio that originally initiated the private call and the radio that originally received the private call. As previously described, the  icon displays when the radio is transmitting via a private call and the  icon displays when the radio is receiving via a private call.

#### ***Call Duration***

When a private call is progressing, both the calling radio and the called radio display the call time in a minutes:seconds format. The calling radio displays a count-down timer of the total remaining call time. The total time available is programmed by the radio dealer, and the call will automatically end at both radios when the timer expires. The called radio displays the total time of the call since it was established.

#### ***Ending a Private Call***

Private call voice communication terminates when any one of the following occurs:

- Either the calling radio user or the called radio user manually ends the private call;
- At either radio, the PTT key is not pressed within a programmable preset time period;
- At either radio, the Group Call Selector knob is placed in an unprogrammed position;



## ***BASIC OPERATIONS***

- The private call's duration exceeds that which is preset by the radio system's network administration personnel;
- A pre-emptive call or emergency call occupies the current channel; or,
- The radio signal from the trunked system's base station is lost/missing.

### **TELEPHONE INTERCONNECT CALLS**

The radio can make telephone interconnect calls if the radio system is equipped with Private Branch eXchange (PBX) or Private Automatic Branch eXchange (PABX) equipment. Telephone interconnect calls are handled as a special type of private call.

#### **Transmitting a Telephone Interconnect Call**



When transmitting a telephone interconnect call, the  icon displays and the radio rings until the called party answers the call. A telephone interconnect call can be transmitted using any method described in the following subsections.





When transmitting (i.e., **PTT** key depressed), hold the front of the radio between 1 to 2 inches (2.5 to 5.0 centimeters) from your mouth and speak into the microphone at a normal voice level. This will ensure optimal reception at the receiving radio unit(s). Never shout or whisper when transmitting. As illustrated on page 6, the radio's microphone is located just above the display.

#### ***Transmitting a Telephone Interconnect Call via the Contact List or Call Logs***





1. While in the home screen, press the **Menu** key.
2. Select **Contact > Contact List**. Alternately, go to **Call Logs** and access the **Outgoing/Incoming/Missed** list.
3. Press the **Up/Down** key to select the desired telephone interconnect call contact for calling.

## **BASIC OPERATIONS**

---

4. Press the  key or the **PTT** key. The radio rings until the called party answers the call. When the called party answers the call, their voice audio will be heard in the radio's speaker.
5. To transmit to the called party, press and hold the  key or the **PTT** key and speak into the microphone at a normal voice level.
6. Release the key to stop transmitting, and listen for a reply.

### ***Transmitting a Telephone Interconnect Call via the ReDial or the BackDial Call Logs***

1. While in the home screen, press the  key to access the ReDial Call Log, or press the  key to access the BackDial Call Log.
2. Press the **Up/Down** key to select the desired telephone interconnect call contact for calling.
3. Press the  key or the **PTT** key. The radio rings until the called party answers the call. When the called party answers the call, their voice audio will be heard in the radio's speaker.
4. To transmit to the called party, press and hold the  key or the **PTT** key and speak into the microphone at a normal voice level.
5. Release the key to stop transmitting, and listen for a reply.

### ***Transmitting a Telephone Interconnect Call via Manual Dial***

1. While in the home screen, use the radio's keypad to enter the number of the contact desired for calling. For the valid numeric range, see the **MANUAL DIAL** section on page 51. Number entry format is as follows:



#### **For PSTN Telephone Interconnect Systems:**

- Format for CPS-P/CPS-P3 Dialing Rules: 01 + PSTN number
- Format for 1343-E Dialing Rules: \*01\* + PSTN number

#### **For PABX Telephone Interconnect Systems:**

- Format for CPS-P/CPS-P3 Dialing: 02 + PABX number

## ***BASIC OPERATIONS***



- Format for 1343-E Dialing: \*02\* + PABX number
2. Hold down the  key, the **PTT** key, or the  key to transmit a telephone interconnect call to the contact. The radio rings until the called party answers the call. When the called party answers the call, their voice audio will be heard in the radio's speaker.
  3. To transmit to the called party, press and hold the  key or the **PTT** key and speak into the microphone at a normal voice level.
  4. Release the key to stop transmitting, and listen for a reply.

### ***Transmitting a Telephone Interconnect Call via the Missed Call Screen***

1. To call back the last missed telephone interconnect caller contact, while in the Missed Call screen, press and hold down the **PTT** key. Alternately, when viewing a number, press and hold down the  key or the **PTT** key to call back the caller.
2. Speak into the microphone at a normal voice level.
3. Release the key to stop transmitting, and listen for a reply.

### ***Receiving and Responding to a Telephone Interconnect Call***



When a telephone interconnect call is received, the  icon displays and the radio rings. The radio may also be programmed to vibrate. To answer the call, press and hold down the  key or the **PTT** key within the preset time period, and speak into the microphone at a normal voice level. Afterwards, the radio displays a  icon indicating the received telephone interconnect call has been answered. Release the key to stop transmitting, and listen for a reply.



If you do not answer a telephone interconnect call, the  missed call icon displays. In this case, the call can be replied to via the Missed Call screen, as previously described.

## ***BASIC OPERATIONS***

---

### **Additional Information on Telephone Interconnect Calls**

#### ***Voice Communications***



After a telephone interconnect call is established, the radio user can transmit voice by pressing and holding down the radio's **PTT** key and speaking into its microphone. Since the radio cannot transmit and receive at the same time, the other radio cannot be heard when the radio's **PTT** key is depressed.

#### ***Call Duration***

When a telephone interconnect call is progressing, both the calling radio and the called radio display the call time in a minutes:seconds format. The calling radio displays a count-down timer of the total remaining call time. The total time available is programmed by the radio dealer, and the call will automatically end at both radios when the timer expires. The called radio displays the total time of the call since it was established.

#### ***Ending a Telephone Interconnect Call***

A telephone interconnect call ends when any one of the following occurs:

- Either the calling radio user or the called radio user manually ends the telephone interconnect call;
- At either radio, the operating mode of the radio is changed;
- At either radio, the Group Call Selector knob is placed in an unprogrammed position;
- The telephone interconnect call's duration exceeds that which is preset by the radio system's network administration personnel;
- A pre-emptive call or emergency call occupies the current channel;
- The radio is turned off, or it logs-out of the system; or,
- The radio signal from the trunked system's base station is lost/missing.

## ***BASIC OPERATIONS***

### **GROUP CALLS**

A group call is a call from one radio user to a group of radio users. This includes general group calls and broadcast group calls. With a general group call, both the calling radio user and the called radio users can transmit. However, with a broadcast group call, only the calling radio user can transmit; the called radio users can only receive (listen) to the calling radio user's voice transmission. Broadcast group calls can only be made from a radio if the radio is authorized to do so by the radio dealer.

#### **Group Attributes**

Each group is pre-programmed by your radio dealer with one of the following four main attributes.

- Participant** The radio can receive calls from and transmit calls to a participant group only when the group is selected with the **Group Call Selector** knob. In other words, the group must be selected with the knob in order to communicate via the group.
- Response** Within the currently selected subgroup, the radio can receive group calls from a response group, regardless of the position the **Group Call Selector** knob. However, to transmit to the group, the group must be selected with the knob.
- Background** A background group cannot be viewed via the radio's menu or selected via the **Group Call Selector** knob. However, the radio can receive calls made on a background group and the radio user can call back (transmit) to the group within a pre-defined time period. Since a background group is not selectable, radio users cannot make calls on it until a call is received on it.
- Radio ID** The Radio ID group can receive calls from the Participant and Response groups in all subgroups or the Background groups in its belonging subgroup, when it is selected by the **Group Call Selector** knob. However, it cannot make calls.

## **BASIC OPERATIONS**

---

### **Transmitting a Group Call**



When transmitting a group call, the  icon displays. A group call can be transmitted using any method described in the following subsections.



When transmitting (i.e., **PTT** key depressed), hold the front of the radio between 1 to 2 inches (2.5 to 5.0 centimeters) from your mouth and speak into the microphone at a normal voice level. This will ensure optimal reception at the receiving radio unit(s). Never shout or whisper when transmitting. As illustrated on page 6, the radio's microphone is located just above the display.

#### ***Transmitting a Group Call to the Currently Selected Group***



While in the home screen, hold down the radio's **PTT** key to transmit a group call to the group currently selected with the **Group Call Selector** knob. Release the **PTT** key to stop transmitting, and listen for a reply. See [Receiving and Responding to a Group Call](#) on page 30 for additional information.

#### ***Transmitting a Group Call via Menu Selection***



1. While in the home screen press the **Menu** key and select **Subgroup** or press the **Subgroup** shortcut key (if programmed) to quickly enter the Subgroup list.
2. Select **Members**.
3. Press the **Up/Down** key to select the group desired for calling.
4. If necessary, set the **Call Type** to either **General Group Call** or **Broadcast Group Call**. The **Broadcast Group Call** selection will only be available if the radio is programmed for this feature. Press the **OK** key to confirm.
5. Hold down the  key or the **PTT** key key to transmit the call to the selected contact, and speak into the microphone at a normal voice level.
6. Release the **PTT** key to stop transmitting, and listen for a reply.

## BASIC OPERATIONS

### ***Transmitting a Group Call via the ReDial or the BackDial Call Logs***

1. While in the home screen, press the  key to access the Redial Call Log, or press the  key to access the BackDial Call Log.
2. Press the **Up/Down** key to select the group desired for calling.
3. If necessary, set the **Call Type** to either **General Group Call** or **Broadcast Group Call**. The **Broadcast Group Call** selection will only be available if the radio is programmed for this feature. Press the **OK** key to confirm.
4. Hold down the  key or the **PTT** key to transmit the call to the selected contact, and speak into the microphone at a normal voice level.
5. Release the key to stop transmitting, and listen for a reply. See [Receiving and Responding to a Group Call](#) on page 30 for additional information.

### ***Transmitting a Group Call via Manual Dial***

1. While in the home screen, use the radio's keypad to enter the number of the desired group as follows:
  - For a general group call, enter the number directly.
  - For a broadcast group call, enter \*11\* followed by the desired number.
2. Hold down the  key, the **PTT** key, or the  key to transmit a group call to the contact, and speak into the microphone at a normal voice level.
3. Release the key to stop transmitting, and listen for a reply. See [Receiving and Responding to a Group Call](#) that follows for additional information.





If the radio's **PTT** key is pressed when a group call is being received, the radio does not transmit. The radio beeps to indicate transmission is prohibited.

## ***BASIC OPERATIONS***

---

### **Receiving and Responding to a Group Call**



When a group call is received, the  icon appears in the radio's display and the radio rings. To respond to the call, hold down the **PTT** key within the preset time period, and speak into the microphone at a normal voice level. Afterwards, the radio displays a  icon indicating the received call has been answered. Release the key to stop transmitting, and listen for a reply.

### **Additional Information on Group Calls**

#### ***Late Entry***

Late entry is a group call function that allows a radio that did not initially receive a group call the ability to receive a portion of the call before it ends. It can occur in the following cases:

- The radio user selects a new group that already has a call active on it.
- The radio is turned on after the group call had already started.
- The radio is busy with other call services when the group call started. After such other call services end, the radio then switches to the group call already in progress.
- The radio enters the coverage area after the group call had already started.
- The radio is in an area where the radio signal to/from the base station is very weak, and as a result, the radio did not receive the beginning of the call.

#### ***Voice Communications***

##### **General Group Call**



When a radio displays a “PTT Enable” prompt after a general group call is established, the radio user can begin transmitting voice by pressing the radio's **PTT** key and speaking into its microphone. This applies at both the radio that originally initiated the call and the radios that originally received the call. As previously described, the  icon displays when the radio is



## **BASIC OPERATIONS**



transmitting voice via a group call and the  icon displays when the radio is receiving voice via a group call.

### **Broadcast Group Call**



After a broadcast group call is established, only the calling radio can transmit voice audio on the group. This is accomplished by pressing the radio's **PTT** key and speaking into its microphone. When transmitting, the  icon displays. Radios receiving the broadcast group call cannot transmit on the group.

### **Call Duration**

When a group call is progressing, both the calling radio and the called radios display the call time in a minutes:seconds format. The calling radio displays a count-down timer of the total remaining call time. This timer is programmed by the radio dealer, and the call will automatically end when the timer expires. Each called radio displays the total time of the call since it was established. The timer starts when the radio joins the group call. If the radio user exits the call and then rejoins it later, the timer restarts.

### **Ending a Group Call**

#### **General Group Call**

For a general group call, voice communication ends when any one of the following occurs:

- No radio transmits on the group within a preset time period;
- The group call's duration exceeds that which is preset by the radio system's network administration personnel;
- The calling radio ends the call.
- The radio signal from the trunked system's base station is lost/missing; or,
- A pre-emptive call or emergency call occupies the current channel.

## ***BASIC OPERATIONS***

---



If the radio's **PTT** key is pressed when a group call is being received, the radio does not transmit. The radio beeps to indicate transmission is prohibited.

### **Broadcast Group Call**









For a broadcast group call, voice communication ends when any one of the following occurs:

- The group call's duration exceeds that which is preset by the radio system's network administration personnel;
- The calling radio ends the call.
- The radio signal from the trunked system's base station is lost/missing; or,
- A pre-emptive call or emergency call occupies the current channel.

**BASIC OPERATIONS**

**BATTERY STRENGTH INDICATOR**

If the **Battery Strength Indicator** shortcut key is pre-programmed, this function can be used to quickly check the remaining battery strength via the LED indicator on the top of the radio. This may be beneficial during certain ambient light conditions, or when the respective icons in the radio's display cannot be easily viewed. Simply press and hold this pre-programmed shortcut key and view the LED indicator on the top of the radio.

LED INDICATOR	DISPLAY ICON	BATTERY STRENGTH
Glowing Green 		High
Glowing Orange 		Medium
Glowing Red 		Low
Glowing Red (and Low Battery Alert Tone Sounds) 		Insufficient

## MENU NAVIGATION AND OPERATIONS

### MENU STRUCTURE

The following diagram illustrates the radio's menu structure. This structure can be customized via dealer programming. Therefore, any particular radio's menu structure may vary from this diagram.

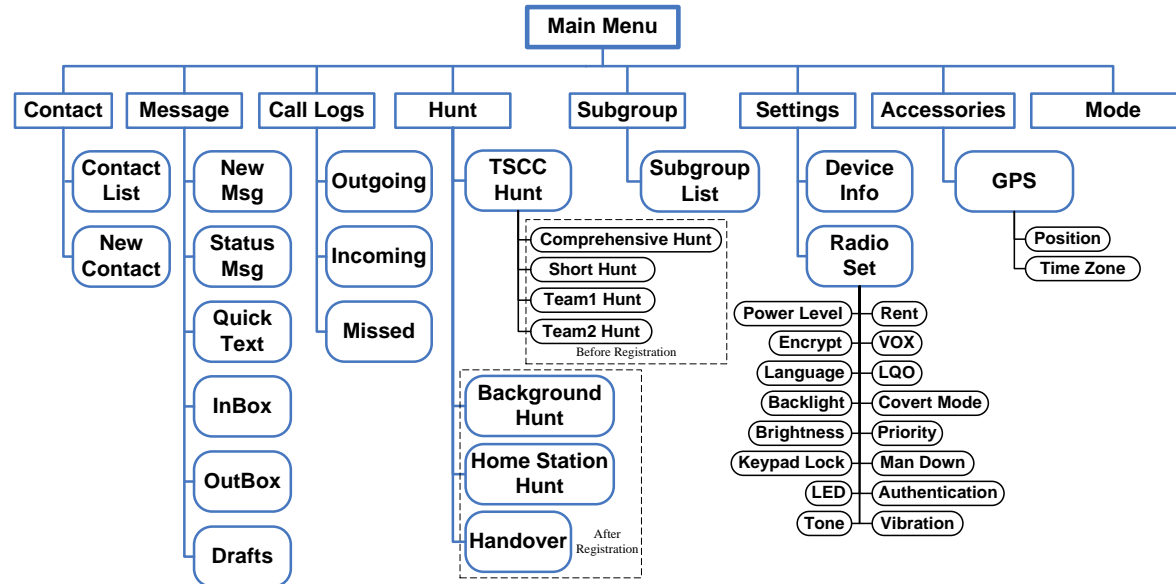

To use the menu, press the **Menu** key in the home screen and then select the desired menu with the **Up/Down** and **Select** keys. Each menu is described in the following sections.

To return to the previous menu/screen, press the **Back** key. Additional presses of this key will return to the earlier screen back to the home screen.

## ***MENU NAVIGATION AND OPERATIONS***

The radio can be pre-programmed with a menu reset function. This function automatically returns operation to the home screen after a pre-programmed period of no operations within a menu or submenu.

### **CONTACT MENU**

The Contact menu allows you to select, view, edit, and delete contacts currently in the Contact List, and to add new contacts to the list.

To access this menu, press the **Menu** key in the home screen and then select **Contact**. As a result, the Contact menu displays. Menu selections are described in the following subsections:

#### **Contact List**

Up to 200 entries can be saved in the Contact List. To access this list, select **Contact List** in the Contact menu, or if programmed, press the **Contact List** shortcut key. List functions include:

**Viewing a Contact** — Use this to view the alias and ID number of each contact.

**Editing a Contact** — Use this to edit the alias and ID number of each contact.

**Deleting a Contact** — Use this to delete a contact from the contact list. However, when there is only one entry left in the list, it cannot be deleted.

#### **New Contact**

To add a contact to the Contact List, select **New Contact** in the Contact menu. The ID number and alias of each contact must be unique. The alias can contain up to 16 characters. When entering the alias, toggle between upper and lower case by pressing the **[\*↑]** key. For valid ID number ranges, refer to the **MANUAL DIAL** section on page 51.

Numbers from the Call Logs list, the ReDial Call Logs list, and the BackDial Call Logs can be saved to the Contact List.

## **MENU NAVIGATION AND OPERATIONS**

---

### **MESSAGE MENU**

The Message menu supports the messaging features of the radio. Message types include text messages, quick text messages, and status messages. To access this menu, press the **Menu** key in the home screen and then select Message.

#### **New Msg**

Select New Msg to create a new text message. After creation, it can be sent to a private call contact, to a group call contact, or it can be saved to Drafts for sending later. Text message length is limited to 23 characters. Refer to the *Sending a Text Message* procedure on page 38 for additional information.

#### **Quick Text**

Under Quick Text, there are up to 10 pre-programmed text messages. You can edit and send any one of these messages. Refer to the *Sending a Quick Text (Pre-Programmed) Message* procedure on page 38.

#### **Status Message**

Each status message contains message text and a message code, which are both pre-programmed by the radio dealer. A status message is sent to the receiving radio via the code, and the corresponding message text displays on the receiving radio upon receipt of the code. Refer to the *Sending a Status Message* on page 39 for additional information.

#### **InBox**

The radio saves received messages in its InBox. Select **InBox** in the Message menu to access the InBox. Icons appear next to each message in the InBox. Their meanings are:



Unread text message



Unread status message



Read text message



Read status message

## ***MENU NAVIGATION AND OPERATIONS***

For each message, any of the following operations can be performed: Reply, Forward (excluding status messages), View Details, and Delete.



The InBox can save up to 50 received messages. When it becomes full, the  icon appears. In this case, the earliest message is automatically overwritten by the last message that was received.

To delete all messages in the InBox, press the **Menu** key in the home screen and select **Message > InBox > Delete All**.

### **OutBox**

The radio saves sent messages in its OutBox. Select **OutBox** in the Message menu to access the OutBox. Icons appear next to each message in the OutBox. Their meanings are:



Successfully sent text message



Successfully sent status message



Not successfully sent text message. In this case, it can be selected for another send attempt.



Not successfully sent status message. In this case, it can be selected for another send attempt.

For each message, the following operations can be performed: Resend, Forward (excluding status messages), View Details, and Delete.

The Outbox can save up to 50 sent messages. When it becomes full, the earliest message is automatically overwritten by the last one that was sent. No icon displays to indicate the OutBox is full.

To delete all messages in the OutBox, press the **Menu** key in the home screen and select **Message > OutBox > Delete All**.

### **Drafts**

Drafts can save up to 20 draft messages. When full, the earliest message is automatically overwritten by the last one entered.

For each draft message, the following operations can be performed: Send, Save, and Delete.

## ***MENU NAVIGATION AND OPERATIONS***

---

To delete all draft messages, press the **Menu** key in the home screen and select **Message > Drafts > Delete All**.

After a message in Drafts is sent, it is automatically removed from Drafts and put in the OutBox.

### **Sending a Message**

#### ***Sending a Text Message***

Follow this basic procedure to send a text message:

1. Press the **Menu** key in the home screen and select **Message > New Msg**. The editing screen appears.
2. In the editing screen, enter the desired text, then press the **OK** key. Refer to the section on page 57 as necessary. Alternately, select an existing message saved in InBox, OutBox or Drafts.
3. Use the **Up/Down** key to select the desired contact to send the message to, or enter the contact's number manually.
4. Press the **OK** key to send the message. When the message is successfully sent, "Send Success!" displays.

#### ***Sending a Quick Text (Pre-Programmed) Message***

Follow this basic procedure to send a text message:

1. Press the **Menu** key in the home screen and select **Message > Quick Text**.
2. Use the **Up/Down** key to select the desired quick text message, then press the **OK** key.
3. Use the **Up/Down** key to select the desired contact to send the message to, or enter the contact's number manually.
4. Press the **OK** key to send the message. When the message is successfully sent, "Send Success!" displays.



## ***MENU NAVIGATION AND OPERATIONS***

### ***Sending a Status Message***

Follow this basic procedure to send a text message:

1. Press the **Menu** key in the home screen and select **Message > Status Msg.**
2. Use the **Up/Down** key to select the desired status message, then press the **OK** key.
3. Use the **Up/Down** key to select the desired contact to send the message to, or enter the contact's number manually.
4. Press the **OK** key to send the message. When the message is successfully sent, "Send Success!" displays.

### ***CALL LOGS MENU***

The radio keeps logs of the private calls and the telephone interconnect calls that it has transmitted and received. Group calls are not logged. Logs include Outgoing, Incoming, and Missed, for outgoing, incoming, and missed calls respectively. The Missed Call Log includes both FOACSU and OACSU private calls that the radio has received, but were not answered. Access a call log via the Call Logs menu.

Up to 10 calls can be saved in each of the 3 logs. When a log is full, the oldest entry will be automatically overwritten by latest one.

Go to the Call Logs menu by pressing the **Menu** key in the home screen and then selecting **Call Logs**. Alternately, access this menu by pressing the respective pre-programmed shortcut key.

After selecting a log and selecting an entry within it, any one of the following actions can be performed:

- Hold down the **PTT** key to initiate a call to the selected entry;
- Add the selected entry to Contact List; or,
- Delete the selected entry.

To delete all entries in a particular log at the same a time, select **Call Logs > Outgoing/Incoming/Missed > Delete All**.

## ***MENU NAVIGATION AND OPERATIONS***

---

### **HUNT MENU**

The radio has two main types of hunt algorithms. Each of these algorithms has hunt subtypes. Use the Hunt menu to select a desired or required hunt mode. To access this menu (if programmed) press the **Menu** key in the home screen and then select **Hunt**. Alternately, if programmed, use the respective shortcut key. Menu selections are described in the subsections that follow.

- **TSCC Hunt for Radio Registration** — See page 40
  - Fixed Control Channel — See page 41
    - Short Hunt
    - Comprehensive Hunt
    - Team Hunt
  - Flexible Control Channel — See page 42
- **Hunt for Smooth Communications (after Registration)** — See page 42
  - Background Hunt — See page 42
  - Home Station Hunt — See page 42
  - Handover Hunt — See page 43

### **TSCC Hunt**

In a trunked radio system, a radio is required to register with a base station prior to normal operation. The TSCC Hunt feature enables the radio to find an appropriate base station's trunked system control channel for registration.

Before registering (typically right after radio turn on), the radio automatically begins hunting for control channels of available trunked base stations. During this time, it displays “Registering, Please Wait!” and the  icon. Also, the LED indicator on the top of the radio flashes orange slowly. The radio employs two different TSCC Hunt subtypes, as described in the following subsections:

## ***MENU NAVIGATION AND OPERATIONS***

### ***TSCC Fixed Control Channel Hunt***

The TSCC Fixed Control Channel Hunt relies on radio systems with fixed sets of control channel radio frequencies. This hunt algorithm has three user-selectable subtypes that are selectable from the TSCC Hunt menu. They are: Short Hunt, Comprehensive Hunt, and Team Hunt.

**Short Hunt** — When using Short Hunt, the radio first hunts for the last 10 control channels upon which the radio has successfully registered on. If that hunt fails to result in a successful registration, the radio then hunts for control channels based on a control channel fixed-list pre-programmed by the radio dealer. This cycle repeats until the radio successfully registers with a base station via the station's control channel. Successful registration causes the radio to add the utilized control channel to its list of last 10 control channels upon which it has successfully registered on, if the channel is not already on the list.

**Comprehensive Hunt** — In this hunt mode, like with a Short Hunt, the radio first hunts for the last 10 control channels upon which the radio has successfully registered on. If that hunt fails to result in a successful registration, the radio then begins hunting all control channels within a radio frequency band pre-programmed by the radio dealer. After 100 channels within this pre-programmed list are hunted without a successful registration, the last 10 channels upon which the radio successfully registered on are hunted again. This process repeats until the radio successfully registers via a base station control channel. Successful registration causes the radio to add the utilized control channel to its list of last 10 control channels upon which it has successfully registered on, if the channel is not already on the list.

**Team Hunt (1 and 2)** — In this hunt mode, like with a Short Hunt, the radio first hunts for the last 10 control channels upon which the radio has successfully registered on. If that hunt fails to result in a successful registration, the radio then begins a team hunt based upon a fixed control channel list pre-programmed by the radio dealer. This process repeats until the radio makes a successful registration. Successful registration causes the radio to add the utilized control channel to its list of last 10 control channels upon which it has successfully registered on, if the channel is not already on the list. Two Team Hunts can be programmed into the radio.

## ***MENU NAVIGATION AND OPERATIONS***

---

### ***TSCC Flexible Control Channel Hunt***

The TSCC Flexible Control Channel Hunt is advantageous to use in an area where base station frequency plans are not well coordinated. Its hunt algorithm is similar to that of the Short Hunt.

### **Hunt for Smooth Communications (after Registration)**

After registration, the radio also supports 3 different hunt algorithms to help maintain radio communications to the highest degree possible, and/or per necessary system requirements. These algorithms are selectable from the Hunt menu. They are described in the following subsections:

#### ***Background Hunt***

When Background Hunt is enabled, the radio periodically measures the signal strength received from the base station with which it is currently registered with. Measurements occur when the radio is idle (i.e., no call is being received or transmitted). If a measured signal strength is below a pre-programmed threshold level, the radio will then automatically begin hunting for a base station with a stronger signal. If one is found, the radio then registers with that (stronger) base station, if the radio is allowed to. Using this feature, the radio can be registered with and use the base station with the strongest signal which it is allowed to operate on, thus ensuring the best-possible radio communications.

To enable or disable Background Hunt, from the main menu, select Hunt > Background Hunt > Enable or Disable. Alternately, if the **Background Hunt** shortcut key is programmed to a radio key, press this key to toggle between enabled and disabled. Also, if the **Hunt Mode** shortcut key is programmed, this key can be used to quickly access the Hunt menu.

#### ***Home Station Hunt***

When Home Station Hunt is enabled, the radio periodically hunts for its assigned home base station and if it is found, the radio registers with it. This feature can help balance-out base station loading in areas covered by multiple base stations, thus maximizing radio communication efficiency by reducing call processing time, and minimizing call queuing and queue times.

## ***MENU NAVIGATION AND OPERATIONS***

---

To enable or disable Home Station Hunt, from the main menu, select Hunt > Home Station Hunt > Enable or Disable. Alternately, if the **Home Station Hunt** shortcut key is programmed to a radio key, press this key to toggle between enabled and disabled. Also, if the **Hunt Mode** shortcut key is programmed, this key can be used to quickly access the Hunt menu.

### ***Handover Hunt***

When Handover Hunt is enabled, the radio can utilize more than one base station to provide the best-possible radio communications. This hunt algorithm is beneficial in weak signal areas (i.e., areas where the radio cannot receive a medium or a strong radio signal from any base station upon which is allowed to operate on.)

To enable or disable Handover Hunt, from the main menu, select Hunt > Handover Hunt > Enable or Disable. Alternately, if the **Handover Hunt** shortcut key is programmed to a radio key, press this key to toggle between enabled and disabled. Also, if the **Hunt Mode** shortcut key is programmed, this key can be used to quickly access the Hunt menu.

### **SUBGROUP MENU**

The radio can be programmed with up to 32 subgroups, and each subgroup can have up to 16 groups. After the radio successfully registers on a trunked system, select a subgroup and then a group. See page 17 for additional information. This menu also allows setting of the default subgroup via the **Set Default** selection.

## ***MENU NAVIGATION AND OPERATIONS***

---

### **SETTINGS MENU**

Using the Settings menu, radio settings can be customized by changing various parameters according to actual user/operator needs and preferences. Also, this menu can be used to display basic device information about the radio. To access the Settings menu, press the **Menu** key in the home screen and then select **Settings**:

#### **Radio Set**

Selections within Radio Set include:

**Power Level** — Use this to change between the low and high transmit (TX) power levels. Alternatively, the power level can be changed from the home screen by pressing the pre-programmed **Adjust Power Level** shortcut key. Two (2) power levels are available:

 High Transmit Power Level — Use this level whenever an increased communications range is necessary.

 Low Transmit Power — To avoid unnecessary communications interference, use this level whenever possible. Use of this level can also increase battery operating time.

**Language** — Use this to set the language of the radio's menus.

**Backlight** — Use this to control backlighting of the display and the backlit keys. There are three (3) possible settings: On, Off, and Timer. When set to **On**, backlighting remains on all the time. When set to **Off**, backlighting stays off all the time. When set to **Timer**, the backlight turns off a pre-programmed time period after user key presses end. The timer is pre-programmable by your dealer with a time period of between 5 and 60 seconds.

**Brightness** — Use this to set display brightness. Raise or lower it using the **Up/Down** key.

**Keypad Lock** — Use to set whether to configure the keypad locking function. See page 18 for details.

**LED** — Use this to enable and disable the LED indicator located on the top of the radio. When disabled, the LED indicator always remains off (i.e., it does not light up). See page 15 for additional information.

## ***MENU NAVIGATION AND OPERATIONS***

---

**Vibration** — Use this to enable and disable radio vibration. If enabled, the radio will vibrate when it receives a message, a private call, or an emergency call.

**Tone** — Use this to configure radio alert tones. The following settings are available:

**Radio Silent:** Use this to enable and disable all tones. If Silent On is selected, all tones remain silent.

**Volume:** Use this to adjust tone volume.

**Talk Permit:** Use this to set whether the radio will sound a tone for transmit talk permit.

**Private Call:** Use this to set whether the radio will sound a tone when it receives a private call.

**TextMsg:** Use this to set whether the radio will sound a tone when it receives a message.

**Keypad:** Use this to set whether the radio will sound a tone at each key press.

**Low Battery:** Use to set whether or not a tone is generated when the radio's battery needs charging.

**Call End:** Use to set whether or not a tone is generated when a call ends.

**Group Call:** Use this to set whether the radio will sound a tone when it receives a group call.

**Income Call:** Use this to set whether the radio will sound a tone when it receives a FOACSU private call.

**PTT Enable:** Use to set whether or not a tone is generated when the PTT is pressed at the beginning of a transmission.

**Hunt:** Use to set whether or not a tone is generated when the radio begins to hunt for a control channel.

**Group Notify:** Use to set whether or not the knob position number is announced when changing the position of the **Group Call Selector** knob.

**Call Queue:** Use to set whether or not a tone is generated when a call is queued. When a call is queued by the radio system, "Queue Call" displays.

## ***MENU NAVIGATION AND OPERATIONS***

---

### **Device Info**

Select **Device Info** on the Setting menu to view basic information about the radio, including serial number, model number, frequency range, firmware version, etc.

### **ACCESSORIES MENU**

#### **GPS**

The GPS Menu supports the radio's internal Global Positioning System receiver. To access this menu, press the **Menu** key in the home screen and then select **Accessories > GPS**. Menu selections include:

**Position** — This selection displays longitude, latitude, time, date, speed (displayed in nautical miles-per-hour), altitude, and GPS satellite (SA) information based upon signals received by the radio's GPS receiver.

**Time Zone** — This function allows setting of the local time zone, so the received GPS time (hours) is correctly displayed. The zone should be correctly set to before the initial use of this feature. For example, if the time at your location is 5.45 hours earlier than GMT, select "GMT+5.45" as your time zone.



As of the publication of this manual, the radio's GPS receiver cannot be turned off when the radio is operating in a trunking mode. Contact your radio dealer for additional information.

### **MODE MENU**

Use the Mode menu to change the main operating mode of the radio.



The radio will reboot upon making a mode change. Voice communications during a reboot is **not** possible. Therefore, use this menu with caution.



## ***MENU NAVIGATION AND OPERATIONS***

---

To access this menu, press the **Menu** key in the home screen and then select **Mode**. Alternately, if the **Operation Mode** shortcut key is programmed, press it to access this menu.

In addition, if programmed, the **Operation Mode Switch** shortcut key may also be pressed to quickly switch to another operating mode.

## ***EMERGENCY COMMUNICATIONS***

---

### **GENERAL INFORMATION**

The radio's emergency feature can be used to summon help from another radio operator(s) and/or via a radio dispatch/control center. The emergency process has the highest call priority throughout the radio communications system and it can pre-empt normal communications. Consult your radio dealer for specific information on how your radio is pre-programmed.

### **SENDING AN EMERGENCY CALL**



When the radio transmits an emergency call, it displays the  icon. Depending upon radio programming performed by the dealer, emergency call can be sent using one or more of the methods described in the following subsections:

#### **By a Programmed Shortcut Key**



If the **Emergency On** shortcut key is programmed to a radio key, press this key to send an emergency call to the programmed contact.

#### **By the Man Down Feature**

If the radio is programmed with the Man Down feature, the sending of an emergency call can be triggered via this feature. Refer to the respective section on page 50 for additional information.

#### **By Manual Dial**

To send an emergency via manual dialing, follow this procedure:



1. While in the home screen, dial \*9\* followed by the desired destination radio's number (e.g., \*9\*80020200). Dial the numbers with the keypad.
2. Press the  key or the  key, or hold down the **PTT** key to make the emergency call.
3. If necessary, continue with voice communications. See the **VOICE COMMUNICATIONS ON AN EMERGENCY CALL** section that follows for additional information.

## EMERGENCY COMMUNICATIONS

### RECEIVING AN EMERGENCY CALL

When the radio receives an emergency call, it is automatically heard in the radio's speaker (or attached speaker/mic). No operator action is required.

### VOICE COMMUNICATIONS ON AN EMERGENCY CALL

After an emergency call is established, a radio user can transmit voice audio on the emergency call by speaking into the microphone when "PTT Enable" is displayed. The  icon displays when the radio is transmitting on the emergency call and the  icon displays when the radio is receiving on the call.

### ENDING AN EMERGENCY CALL

An emergency call can be ended when one of the following occurs:

- The emergency call's duration exceeds that which is preset by the radio system's network administration personnel;
- The radio signal from the trunked system's base station is lost/missing;
- If the emergency call is on a group, a user at a called radio ends the call or exits the emergency mode; or,
- If the emergency call is a private call, a user at either of the two radios ends the call or exits the emergency mode.



NOTE

To exit an emergency at a calling radio (i.e., the radio that initiated the emergency call), press the programmed **Emergency Off** shortcut key.

To exit an emergency at a called radio, press the **Back** key and then within one (1) second, press the **TK** key.

## **EMERGENCY COMMUNICATIONS**

---

### **MAN DOWN**

The Man Down feature can be used to automatically initiate an emergency when the radio is positioned aslant for a programmed period of time, or if it remains motionless for a programmed period of time. The radio can be programmed to automatically enable the Man Down feature upon turn on. If a man-down-capable-radio is not programmed as such, the feature must be manually enabled before it will function.

### **Manually Enabling and Disabling Man Down**

There are two (2) possible ways to manually enable and disable the Man Down feature. One or both methods may be available per programming performed by your radio dealer:

- From the menu select: Menu > Settings > Radio Set > Man Down > Enable or Disable.
- If the **Man Down** shortcut key is programmed to a key, press this key to enable or disable the Man Down feature.

When this feature is enabled (i.e., turned on), the radio briefly displays “Man Down On!” and sounds a high-pitch tone. When this feature is disabled (i.e., turned off), the radio briefly displays “Man Down Off!” and sounds a low-pitched tone.

### **Using Man Down**

1. Enable the Man Down feature if it is not already. Refer to the previous section as necessary. The current enable/disable status can be viewed from the Man Down menu.
2. After the radio is positioned aslant for the preset period of time or after it remains motionless for a preset period of time (depending upon radio programming), it sounds an alert tone.
3. To cancel the emergency call, quickly return the radio to a vertical/upright position, or move it if it was motionless.



If the radio is not soon returned to a near vertical/upright position or moved if it was motionless, the radio then enters the emergency mode and automatically begins transmitting an emergency call, as programmed.

## **MISCELLANEOUS FEATURES**

### **MANUAL DIAL**

This feature allows you to make a call by manually entering a number via the radio's numeric keypad. Supported call types include private calls (includes telephone interconnect calls) and group calls.

#### **Operation**

In the home screen, input the desired contact ID number for calling, and then to transmit, press the  key or the  key, or press and hold the **PTT** key.

#### **CPS-P Dialing**

##### **Number Format**

A contact ID number is composed of 8 digits: NP (3 digits) + FN (2 digits) + UN/GN (3 digits):

- NP (Prefix Number) Range: 328 – 899.
- FN (Fleet Number) Range: 20 - 65 for private call; 20 - 99 for group call.
- UN (Unit Number for a private call) Range: 200 – 899.
- GN (Group Number for a group call) Range: 900 – 999.

##### **Dialing Rules**

- In-Fleet Call — Dial the UN/GN (3 digits) only.
- Inter-Fleet Call — Dial the FN (2 digits) and the UN/GN (3 digits).
- Inter-Prefix Call — Dial the NP (3 digits), the FN (2 digits) and the UN/GN (3 digits).

#### **CPS-P3 Dialing**

##### **Number Format**

A contact ID number is composed of 8 digits: NP (3 digits) + FN (2 digits) + UN/GN (3 digits):

- NP (Prefix Number) Range: 328 – 899.

*Publication 14222-1160-2000*

## **MISCELLANEOUS FEATURES**

- FN (Fleet Number) Range: 20 - 89 for both private call and fleet group call; 90, 97, 98, 99 for hierarchical group call.
- UN (Unit Number for a private call) Range: If FN = 20 - 41, UN Range = 200 – 899. If FN = 42 to 89, UN Range = 200 – 549.
- GN (Group Number for a group call) Range: 900 – 999 for fleet group call; 000 – 999 for hierarchical group call.

### **Dialing Rules**

- In-Fleet Call — Dial the UN/GN (3 digits) only.
- Inter-Fleet Call — Dial the FN (2 digits) and the UN/GN (3 digits).
- Inter-Prefix Call — Dial the NP (3 digits), the FN (2 digits) and the UN/GN (3 digits).

### **1343-E Dialing**

This feature allows customization of dialing rules. The radio can be pre-programmed by your radio dealer to customize the dialing rules according to actual needs. Note that each radio user must follow the same scheme in the same trunking system and each contact ID number is unique. Please consult with your radio dealer for details regarding this dialing rule, if it is implemented.

### **CALL QUEUING**

During busy communications periods, all available radio channels can become active/busy at the same time. In a case such as this, calls without pre-emptive or emergency priority will queue according to their priorities, and wait for the system to assign them to an available radio channel. If a call is queued, the calling radio displays “Queue Call.”

## **MISCELLANEOUS FEATURES**

### **TIME-OUT TIMER (TOT)**

The Time-Out-Timer (TOT) prevents a radio user from transmitting on a group/channel for an extended period. If the preset time expires, the radio automatically terminates the transmission and begins beeping. To stop the beeping, release the **PTT** key. You must wait for a certain time period (preset by your dealer) to start another transmission.

### **MICROPHONE AUTOMATIC GAIN CONTROL (AGC)**

If the mic AGC feature is enabled, the radio will automatically control the level of the audio from the microphone before the audio is applied to the radio's transmitter circuit. This feature can improve radio transmission and thus reception at the receiving radio unit(s). With radio programming, this feature can be enabled on digital channels, analog channels, or both digital and analog channels.

### **VOICE-OPERATED SWITCH (VOX)**

When on, the VOX feature automatically transmit-keys the radio when a sufficient level of audio is detected at the radio's microphone. This allows "hands free PTTing" of the radio. In other words, with this feature on, the radio's **PTT** key does not need to be pressed to make a voice transmission.

#### **Turning VOX On and Off**

The  icon appears in the display when the VOX feature is on. Use one of these methods to turn this feature on and off:

- From the home screen, press the **Menu** key then select **Settings > Radio Set > VOX > On or Off**.
- If the **VOX** shortcut key is programmed to a radio key, press this key to toggle VOX on and off.
- If currently on, press the **PTT** key to quickly turn the VOX feature off.

## **MISCELLANEOUS FEATURES**

---

### **Setting VOX Sensitivity Level**

The VOX sensitivity level can be adjusted for both the internal and an external microphone. Follow this procedure to adjust a level:

1. From the home screen, press the **Menu** key then select **Settings > Radio Set > VOX > Gain Level**.
2. To adjust the sensitivity level for the radio's internal microphone, select **Internal**.  
To adjust the sensitivity level for an external microphone (i.e., a mic or speaker-mic type device connected to the accessory jack), select **External**.
3. Select a new level, **Level 1** through **Level 9**. Upon doing so, "Set Success!" displays. Higher gain levels are less sensitive. Noisy environments may require selection of a higher level.



Always use great care when adjusting the VOX sensitivity levels, and when using the VOX feature. Improper sensitivity adjustment can cause the radio to transmit at improper times. When the radio is transmitting, the LED indicator on the top of the radio glows red.

### **LOUDNESS AND QUALITY OPTIMIZER (LQO)**

When turned on, the LQO feature allows the radio to automatically adjust receive audio volume and quality for various environments. Adjustments are performed when the radio is squelched/muted. This feature can help clarify received voice signals for certain environments.

The © icon appears in the display when the LQO feature is on. Use one of these methods to turn this feature on and off:

- From the home screen, press the **Menu** key then select **Settings > Radio Set > LQO > On or Off**.
- If the **LQO** shortcut key is programmed to a radio key, press this key to toggle LQO on and off.

Upon toggling this feature on or off, "Set Success!" displays.



## MISCELLANEOUS FEATURES

---

### RENT

Radio operating time may be set-up on a rental basis with the radio dealer. If so, when the rental time expires, the radio can no longer be used.

To check the radio's remaining rental time, from the home screen, press the **Menu** key then select **Settings > Radio Set > Rent > Rent Query**.

If the radio is pre-programmed with the Rent Pre-Alert feature enabled, it will periodically sound a tone to remind the radio operator that rental time is nearing expiration.

### PRIORITY

This feature indicates the priority of the normal voice services. When there is no free service channel in the system, the system responds to the higher-priority voice service first. The normal voice services include private calls, general group calls, broadcast group calls, and PSTN and PABX telephone interconnect calls. Emergency calls are not handled as normal voice services.

Use the Priority menu to set the priority of the radio's normal voice services. From the home screen, press the **Menu** key then select **Settings > Radio Set > Priority**.

- Priority follows this principle: Low < Medium < High. When the service channels are all occupied, calls will queue according to their priorities for the system's distribution of channels. When the queue is full, the higher-priority calls can jump the queue and the lower-priority calls will be extruded out accordingly (i.e., the system will prompt that it is busy). In addition, the emergency calls or preemption calls can forcibly disconnect on-going lower-priority calls to release the channels for themselves.
- Preemption: This is the highest priority. When the system is busy, such calls do not need to queue. They can disconnect other on-going calls with lower priority to release the channels for themselves. Preemption is not available in the radio unless the radio dealer has enabled it.

## **MISCELLANEOUS FEATURES**

---

### **COVERT MODE**

If the radio is programmed with the Covert Mode, this mode can be used to help conceal radio operations. When enabled, radio indications such as the LED indicator on the top of the radio and vibrations are turned off.

To enable and disable Covert Mode, press the programmed **Covert Mode** shortcut key. This is a toggle-type function. Alternately, use menu path **Settings > Radio Set > Covert Mode > Enable or Disable**.

### **ENCRYPTION**

The radio's Encrypt feature for digital channels can be used to prevent "eavesdropping" upon a digital radio channel. This feature ensures the best guarantee of radio communication privacy, since communications are performed via digitally-encrypted signals. Each radio must have this feature enabled before it can receive and transmit encrypted calls.

The menu path to enable and disable encryption is: **Menu > Settings > Radio Set > Encrypt > Enable or Disable**.

If a radio key is programmed with the **Encrypt** shortcut function, press it to toggle encryption between the enabled (on) and disabled (off) states.

### **AUTHENTICATION**

The Authentication feature validates radio user accounts on the trunked radio network. When this feature is enabled, both radio and the base station that the radio is attempting to connect to must validate each other before the radio can register with the station. As of the publication of this manual, if authentication is enabled, it is only performed at registration. Registration can only occur after both the radio and the base station pass the authentication process.

The menu path to enable and disable authentication is: **Menu > Settings > Radio Set > Authentication > Enable or Disable**.

## MISCELLANEOUS FEATURES

### ONE TOUCH CALL

The radio can be programmed by your radio dealer with the One Touch Call feature. This feature is used for calling a programmed contact or for quickly sending a programmed message. The contact, call type, and message content are all programmed by the radio dealer.

Up to five (5) different One Touch Calls can be programmed. Any programmable radio key, including the numeric keys of the radio's keypad, can be programmed as a One Touch Call shortcut key. On the keypad, this includes number keys 0 through 9 and the **\*☐** and **#☐** keys. Consult with your radio dealer as necessary to determine specific programming and operation details specific to your radio.

To send a One Touch Call, press the programmed **One Touch Call** shortcut key.

### ENTERING LETTERS, NUMBERS, AND OTHER CHARACTERS VIA THE KEYPAD

#### Upper and Lower Case Letters

To enter text via the radio's keypad:

1. Press the **#☐** key to switch between upper case and lower case letters.
2. Press the key that has the desired letter repeatedly until the desired letter appears in the display.
3. To enter a space, press the **\*☐** key.
4. Repeat steps 1 through 3 as necessary to complete a word or sentence.

#### Numbers

To enter numbers via the radio's keypad:

1. Press the **#☐** key to switch to number mode.
2. Enter each digit of the desired number by pressing the **0+** through **9xyz** alphanumeric keys.
3. Repeat steps 1 and 2 as necessary.

## ***MISCELLANEOUS FEATURES***

---

### **Punctuation Characters and Special Characters**

To enter common punctuation characters and special characters, press the  key one or more times until the desired character appears in the display.

To enter a space, press the  key.

### **Moving Cursor Position**

Use the **Up/Down** key to move the current position of the cursor. Up moves it to the left and Down moves it to the right.

## **TROUBLESHOOTING AND TECHNICAL ASSISTANCE**

### **TROUBLESHOOTING TABLE**

<b>SYMPTOM</b>	<b>POSSIBLE CAUSE</b>	<b>SOLUTIONS</b>
Radio will not turn on.	Battery is dead.	Charge or replace the battery. See page 9 for instructions.
	Battery is not properly attached to the radio.	Remove and then re-attach the battery to the radio. See page 10 for instructions.
	Battery contacts are dirty or damaged.	Clean the contacts and/or replace the battery.
	Battery is defective/bad.	Replace the battery with a fully-charged battery.
The radio cannot successfully register on a trunked system.	The radio is out-of-range of the trunked system's base station(s).	Move to another location and retry. Moving a few yards/meters in one direction can sometimes greatly improve communications range.
	The radio is not authorized to operate on the trunked system.	Move to another location that has a trunked system upon which the radio is authorized to operate and/or select a hunt option via the Hunt menu.
	Damaged, defective, or improperly installed antenna.	Tighten or replace the antenna.
	Weak battery.	Recharge or replace the battery.
The radio registers repeatedly.	The radio signal from the trunked system's base station is weak or has interference.	Move to another location that is within the coverage area of the base station, and retry communications. Alternately, select another hunt option via the Hunt menu.

## **TROUBLESHOOTING AND TECHNICAL ASSISTANCE**

<b>SYMPTOM</b>	<b>POSSIBLE CAUSE</b>	<b>SOLUTIONS</b>
A call cannot be established.	The radio signal from the trunked system's base station is weak or has interference.	Move to another location and retry and/or move to a location that is within the coverage area of the base station. Alternately, select another hunt option via the Hunt menu.
No voice is heard after establishing a call.	The radio's pre-programmed ID is the same as another radio in the trunked system.	Contact the trunked system's administrator to see if the radio's ID is repeated in the network management system.
The called radio disconnects repeatedly during communication.	The radio signal from the trunked system's base station is weak or has interference.	Move to another location that is within the coverage area of the base station, and retry communications. Alternately, select another hunt option via the Hunt menu.
When receiving, voice audio is weak, erratic, unclear, or not present at all.	Volume is set too low.	Increase the volume with the On/Off Volume Control knob. See page 16.
	Antenna is not properly connected to the radio.	Turn the radio off, re-connect the antenna cable to the radio, and turn the radio back on.
	Antenna is damaged or not present.	Have your radio dealer repair/replace the antenna.
	Speaker may be blocked or damaged.	Clean surface of the speaker. If the problem cannot be solved, contact your dealer or an authorized service center for inspection and repair.
	Weak battery.	Recharge or replace the battery.
Noisy communications (cont.)	Out-of-range (too far away from) of the trunked system's base station.	Change your location. Moving a few yards/meters in one direction or moving to a higher elevation can sometimes greatly improve communications range.

## ***TROUBLESHOOTING AND TECHNICAL ASSISTANCE***

<b>SYMPTOM</b>	<b>POSSIBLE CAUSE</b>	<b>SOLUTIONS</b>
(cont.) Noisy communications.	A nearby device, such as an electric motor, light bulb, or computer is causing interference on the radio frequency/channel.	Change your location. Moving a few yards/meters in one direction can sometimes greatly improve communications.
Keypad does not operate.	The keypad has temporarily stopped functioning.	Restart the radio by turning it off and back on.
Display does not operate.	The display has temporarily stopped functioning.	Restart the radio by turning it off and back on.

### **TECHNICAL ASSISTANCE**

When technical issues arise that cannot be resolved using the troubleshooting table, contact your radio equipment dealer for solution assistance. Also contact your radio equipment dealer for specific information about how the radio is programmed.

## CARE AND CLEANING

---

Ensure optimal radio performance as well as a long service life by following these care and cleaning tips:

### RADIO CARE

- Review and follow all precautions described in the radio's *Product Safety Booklet*.
- Do not hold the radio by its antenna or by a cable connected to its accessory connector.
- Do not pierce or scrape the surface of the radio or its accessories.
- Always replace the accessory jack cover onto the jack when an accessory cable is not connected to the radio.
- Do not place the radio or any radio accessories in corrosive agents, solutions, gas mixers, or water.

### RADIO CLEANING



Turn the radio **off** before cleaning it.

- On a regular basis, clean dust and fine particles from the radio and any accessories with a clean, dry, lint-free cloth or a fine brush.
- After long periods of use, gently clean the radio's keys, control knobs, display, and jacks/connectors with a non-woven fabric and a neutral-base cleanser or mild soap. Do not use chemical preparations such as stain removers, alcohol, sprays, or oils.
- Always allow the radio and its accessories to dry completely before turning the radio back on.



## MODEL NUMBERS

### RADIO PACKAGES

MODEL NUMBER	DESCRIPTION
HD-PFV1B	Momentum HDP150 Portable Radio, 136 to 174 MHz, with GPS and Standard Accessories
HD-PFV1B-MD	Momentum HDP150 Portable Radio, 136 to 174 MHz, with GPS with Man Down, and Standard Accessories
HD-PFV1B-TXR	Momentum HDP150 Portable Radio, 136 to 174 MHz, with GPS (radio only)
HD-PFV1B-MD-TXR	Momentum HDP150 Portable Radio, 136 to 174 MHz, with GPS with Man Down (radio only)
HD-PFU1B	Momentum HDP150 Portable Radio, 400 to 470 MHz, with GPS and Standard Accessories
HD-PFU1B-MD	Momentum HDP150 Portable Radio, 400 to 470 MHz, with GPS with Man Down, and Standard Accessories
HD-PFU1B-TXR	Momentum HDP150 Portable Radio, 400 to 470 MHz, with GPS (radio only)
HD-PFU1B-MD-TXR	Momentum HDP150 Portable Radio, 400 to 470 MHz, with GPS with Man Down (radio only)
HD-PFU2B	Momentum HDP150 Portable Radio, 450 to 520 MHz, with GPS and Standard Accessories
HD-PFU2B-MD	Momentum HDP150 Portable Radio, 450 to 520 MHz, with GPS with Man Down, and Standard Accessories
HD-PFU2B-TXR	Momentum HDP150 Portable Radio, 450 to 520 MHz, with GPS (radio only)
HD-PFU2B-MD-TXR	Momentum HDP150 Portable Radio, 450 to 520 MHz, with GPS with Man Down (radio only)

## MODEL NUMBERS

MODEL NUMBER	DESCRIPTION
HD-PFU5B	Momentum HDP150 Portable Radio, 800/900 MHz, 3/2.5 Watts, with Standard Accessories
HD-PFU5B-MD	Momentum HDP150 Portable Radio, 800/900 MHz, 3/2.5 Watts, with Man Down and Standard Accessories



NOTE

Standard accessories include one of each item pictured on page 5 (less the radio). Respective part numbers are listed in the tables that follow. Each radio is supplied with one (1) standard antenna, one (1) standard battery, one (1) standard battery charger with power adapter, and the carrying accessories pictured on page 5. However, that does not apply to model numbers with the “TXR” suffix, as those models are radios only.

## ANTENNAS

MODEL NUMBER	DESCRIPTION	STANDARD/OPTIONAL
HD-AN6K-01	Antenna, 136 to 147 MHz, Long	Standard*
HD-AN6K-02	Antenna, 136 to 174 MHz, Long	Standard*
HD-AN6K-03	Antenna, 147 to 160 MHz, Long	Standard*
HD-AN6K-04	Antenna, 160 to 174 MHz, Long	Standard*
HD-AN6L-03	Antenna, 400 to 470 MHz, Stub	Standard*
HD-AN6L-04	Antenna, 450 to 520 MHz, Stub	Standard*

\* With respective radio.

## **MODEL NUMBERS**

### **BATTERIES AND BATTERY CHARGERS**

<b>MODEL NUMBER</b>	<b>DESCRIPTION</b>	<b>STANDARD/OPTIONAL</b>
HD-PA2V	Battery, Lithium-Ion 2000 mAH	Standard
HD-PA2Y	Battery, Lithium-Ion 2500 mAH	Optional
HD-CH4D	Charger, Battery: 1-Bay with Power Adapter	Standard
HD-CH4F	Charger, Battery: 6-Bay	Optional
HD-PS2V	Power Supply, 6-Unit, Switching	Optional
HD-PS2T	Adapter, AC Power, 100 to 240 Vac at 50/60 Hz Input, 12 Vdc Output	Optional

### **CARRYING ACCESSORIES**

<b>MODEL NUMBER</b>	<b>DESCRIPTION</b>	<b>STANDARD/OPTIONAL</b>
HD-HC3M	Clip, Belt	Standard
HD-HC3R	Strap, Wrist	Standard
HD-CL3N	Case, Leather with Swivel	Optional

## **MODEL NUMBERS**

### **AUDIO ACCESSORIES**

<b>MODEL NUMBER</b>	<b>DESCRIPTION</b>	<b>STANDARD/OPTIONAL</b>
HD-AE6P	Earpiece with On-Mic PTT	Optional
HD-AE6R	Earpiece with 3-Wire Surveillance Kit	Optional
HD-AE6S	D-Earset with In-Line Mic and PTT	Optional
HD-AE6U	Earbud with On-Mic PTT	Optional
HD-AE6V	Earbud, Receive-Only	Optional
HD-AE6W	Speaker-Mic, Waterproof	Optional
HD-AE6Y	Earpiece, Receive-Only	Optional
HD-AE6Z	Earpiece, 2-Wire, Wireless Earphone/Neck	Optional

## **WARRANTY REGISTRATION AND WARRANTY**

### **WARRANTY REGISTRATION**

Please register this product within ten (10) days of purchase. Registration validates the warranty coverage, and enables Harris to contact you in case of any safety notifications issued for this product.

Registration can be made on-line at <http://www.pspc.harris.com/Service/WarrantySupport.asp>.

### **EQUIPMENT AND RECHARGEABLE BATTERY WARRANTY**

- A. Harris Corporation, a Delaware Corporation, acting through its RF Communications Division (hereinafter "Seller") warrants to the original purchaser for use (hereinafter "Buyer") that Momentum™ Equipment manufactured by or for the Seller shall (i) be free from all defects in material, workmanship and title; and (ii) comply with all of the Momentum™ Equipment Product Specifications. For purposes of this warranty, batteries shall be deemed defective if: (1) the battery capacity is less than 80% rated capacity, or (2) the battery develops leakage.
- B. Seller's obligations set forth in Paragraph C below shall apply only to Momentum™ Equipment failures to meet the above warranties occurring within the following periods of time from the date of sale to the Buyer and are conditioned on Buyer's giving written notice to Seller within thirty (30) days of such occurrence:
  - 1. for portable radios, mobile radios, repeaters and base stations, thirty-six (36) months (except as noted in paragraph B.2 and B.3);
  - 2. rechargeable batteries and accessories, twelve (12) months; and,
  - 3. all other parts, ninety (90) days.
- C. If any Momentum™ Equipment fails to meet the foregoing warranties, Seller shall correct the failure at its option (i) by repairing any defective or damaged part or parts thereof, or (ii) by replacing the failed Momentum™ Equipment with equivalent new or refurbished Equipment. Any repaired or replacement products or parts furnished hereunder shall be warranted for the balance of the original applicable Product Warranty Period or one hundred eighty (180) days for Products (other than batteries, accessories and parts) and ninety (90) days for batteries and accessories, whichever ends later. Where such failure cannot be corrected by Seller's reasonable efforts, the parties will negotiate an equitable adjustment in price. Labor to perform warranty service will be provided at no charge during the warranty period only for the Equipment

## **WARRANTY REGISTRATION AND WARRANTY**

covered under Paragraph B. To be eligible for no-charge labor, service must be performed at Seller's location or other Servicer approved by Seller in writing to make the specific repairs at its place of business during normal business hours. Seller shall pay all freight charges relating to the return and shipment of the defective Products and the repaired or replacement Products to and from the Seller designated location. If it is determined that the Products are not under warranty, Buyer shall pay all freight charges related to the return and shipment of the Products and the repaired or replacement Products to and from the Seller designated location.

- D. Seller's obligations under Paragraph C shall not apply to any Equipment or part thereof, which:
1. has a defect that is not reported during the Product Warranty Period;
  2. is disassembled, modified, altered or repaired other than pursuant to Seller's written instructions or other written approval by Seller;
  3. is not installed, operated or maintained in accordance with written instructions provided by Seller;
  4. has its serial number removed or altered;
  5. is not properly stored or suffers detrimental exposure or is treated with abuse, negligence or other improper treatment; or,
  6. is damaged in an accident or in a natural disaster (earthquake, storm, flood, fire or other natural disaster).
- E. The preceding paragraphs set forth the exclusive remedies for claims based upon defects in or nonconformity of the Momentum™ Equipment, whether the claim is in contract, warranty, tort (including negligence), strict liability or otherwise and however instituted. Upon the expiration of the warranty period, all such liability shall terminate. The foregoing warranties are exclusive and in lieu of all other warranties, whether oral, written, expressed, implied or statutory. NO IMPLIED OR STATUTORY WARRANTIES OF MERCHANTABILITY OR FITNESS FOR PARTICULAR PURPOSE SHALL APPLY. IN NO EVENT SHALL THE SELLER BE LIABLE FOR ANY INCIDENTAL, CONSEQUENTIAL, SPECIAL, INDIRECT OR EXEMPLARY DAMAGES.

This warranty applies only within the United States.

*Contact your local Harris Dealer to request warranty service.*

ECR-7931