

# Retekess

## DSP AM/FM POCKET RADIO WITH MICRO SD PLAYBACK



### INSTRUCTION MANUAL

## NOMENCLATURE

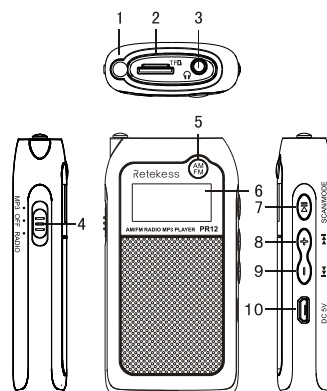

- |   |                     |
|---|---------------------|
| 1. FM antenna                             | 6. LCD display      |
| 2. Micro SD card slot                     | 7. SCAN/MODE        |
| 3. Earphone jack                          | 8. Next/volume +    |
| 4. Function switch:<br>SD/power off/radio | 9. Previous/volume- |
| 5. AM/FM selector                         | 10. DC 5V jack      |

## LCD DISPLAY ILLUSTRATION

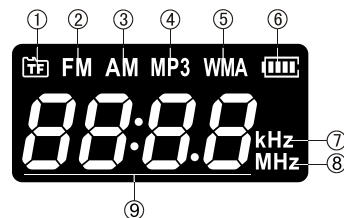

1

1. Micro SD card playback mode
2. FM radio playback mode
3. AM radio playback mode
4. MP3 playback mode
5. WMA playback mode
6. Battery indicator
7. AM frequency unit
8. FM frequency unit
9. Remarks:  
- It will show track # for about two seconds when press previous or next.  
- It will show "000--0:16" playback time under song playback mode.  
- It will show frequency when radio is selected.

## EARPHONE

1. You can use an earphone to listen to music or radio so as to not disturb others.  
Insert the earphone plug into "Earphone jack" (3).

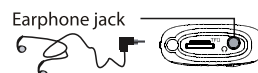

2. Long press Volume+(8) or Volume-(9) to the level you need.

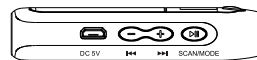

## POWER ON/OFF

Put function "switch" (4) to "Radio" or "MP3" to switch unit on, and turn off unit by putting switch to "off".

2

## POWER SUPPLY

### 1. Built-in lithium battery (500mAh)

When LCD display "□", it means it's low battery, please charge battery. You can use the 5V adaptor to charge battery, and battery indicator on LCD display will flash "■". After about 4 hours, the battery indicator on LCD will display a "■", it means the battery is full. You can charge the battery when the unit is off.

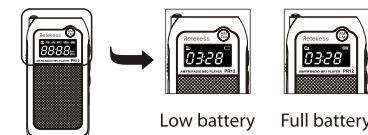

### 2. DC power supply

Use the USB charge cable to connect this unit and your computer, or other 5V USB adaptor. Small plug inserts into the unit's DC jack.



Caution: When unit is connected with computer by USB cable, you can move power switch (4) to SD, and put micro SD card into card slot (2), then you can read the data inside micro SD card by computer. And you can transfer data from computer to micro SD or from micro SD to computer.

3

## MICRO SD CARD PLAYBACK

Put the power switch (4) to "SD" to make power on, and LCD display is lit up at the same time.

Insert micro SD Card

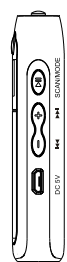
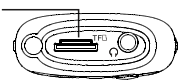

1. Insert a micro SD card with MP3/WMA format music to the micro SD card slot (2) on the unit to playback, you can find the track # shown on LCD display for about 2 seconds, and then display the playback time.
2. Press "Play/pause" button (7) to pause playback and press this button again to resume playback during playback mode.
3. Short press "Previous/next" button (8) to select the track you want, long press these two buttons for volume control.

### Remarks:

Unit setup default micro SD card playback when it's power on, if you want to change play mode, please shift micro SD to radio by "Function switch" (4).

## RADIO FUNCTION

Press "Function switch" button (4) to radio mode, you can see FM frequency shown on LCD display.

1. Press AM/FM selector (5) to the band you need.
2. Long press "SCAN/MODE" button (7) to radio auto scan (ATS) function, you can see AM or FM station will be played about two seconds and

4

automatically saved in memory, then continue to scan for next station until all stations are saved in unit memory, ATS will auto stop and playback the first station in memory.

3. For FM, there are two options. One is from 87-108 MHz, another is from 64-108 MHz, but default frequency is from 87MHz to 108MHz, you can change the FM option by long press "AM/FM" selector (5) for about 6 seconds when unit is under FM mode.
4. For AM, frequency is from 522-1710 kHz, there are two options for AM step frequency, one is 9 kHz, another is 10kHz, you can change the AM step frequency by long press "AM/FM" selector (5) for about 6 seconds when unit is under AM mode.
5. Short press "Previous/Next" key to switch preset radio station; Short press "SCAN/MODE" key to switch to manual adjustment mode, then press "Previous/Next" to adjust radio frequency manually.

### Remarks:

Please pull out FM antenna when listening to FM radio for best reception.

## TECHNICAL SPECIFICATIONS

1. Power: DC 5V 0.6A
2. Battery: Built-in 500mAh/3.7V rechargeable lithium battery
3. External earphone: 3.5mm 32
4. FM frequency: 64-108MHz
5. AM frequency: 522-1710kHz
6. Output power: 3W
7. Unit weight: 72.6g(Without accessory)
8. Unit size: 46(L)x18(W)x88(H) mm

5

## CAUTION



### Avoid Choking Hazard

Small Parts. Not for children under 3 years.



### Protect your hearing

- Use the lowest volume necessary to do your job.
- Turn up the volume only if you are in noisy surroundings.
- Turn down the volume before adding headset or earpiece.
- Limit the amount of time you use headsets or earpieces at high volume.
- When using the radio without a headset or earpiece, do not place the radio's speaker directly against your ear.

### Note:

Exposure to loud noises from any source for extended periods of time may temporarily or permanently affect your hearing. The louder the radio's volume, the less time is required before your hearing could be affected. Hearing damage from loud noise is sometimes undetectable at first and can have a cumulative effect.

6

## **FCC STATEMENT :**

This device complies with Part 15 of the FCC Rules. Operation is subject to the following two conditions:

- (1) This device may not cause harmful interference, and
- (2) This device must accept any interference received, including interference that may cause undesired operation.

**Warning:** Changes or modifications not expressly approved by the party responsible for compliance could void the user's authority to operate the equipment.

NOTE: This equipment has been tested and found to comply with the limits for a Class B digital device, pursuant to Part 15 of the FCC Rules. These limits are designed to provide reasonable protection against harmful interference in a residential installation. This equipment generates uses and can radiate radio frequency energy and, if not installed and used in accordance with the instructions, may cause harmful interference to radio communications. However, there is no guarantee that interference will not occur in a particular installation. If this equipment does cause harmful interference to radio or television reception, which can be determined by turning the equipment off and on, the user is encouraged to try to correct the interference by one or more of the following measures:

- Reorient or relocate the receiving antenna.
- Increase the separation between the equipment and receiver.
- Connect the equipment into an outlet on a circuit different from that to which the receiver is connected.
- Consult the dealer or an experienced radio/TV technician for help.