

# ***Retevis***

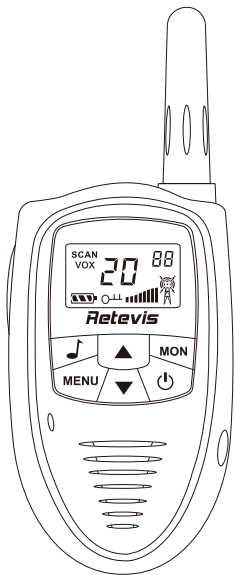

**RT31**

***USER'S MANUAL***

# PIC 01

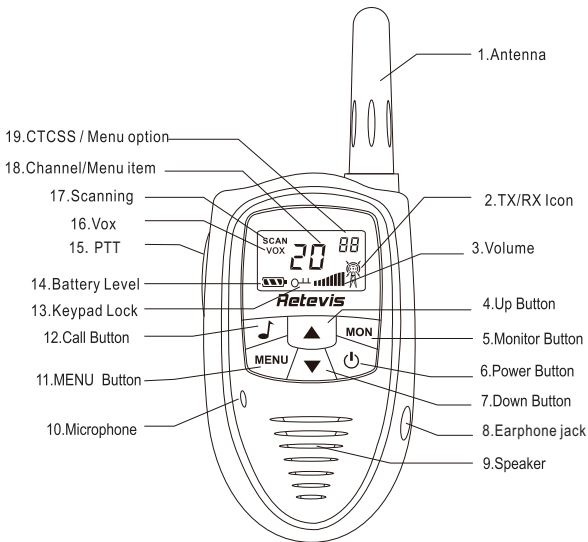

# PIC 02

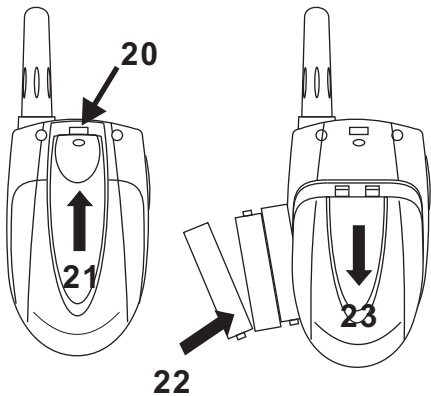

## **EN~Instructions for use**

This set includes 2 walkie-talkie units: these are communication devices which operate on mobile radio frequencies. They come with 8/20/22 channels as well as a back-lit LCD screen, enabling you to communicate over several kilometers free-of-charge.

**NOTE:** Please read these user instructions carefully before using the equipment and retain for future consultation!

### **SPECIFIC RECOMMENDATIONS**



- If you carry any kind of personal medical disease, consult a doctor before use.
- To avoid the risk of burns, do not use the device if the antenna is damaged in any way.
- Do not use the device in a potentially explosive environment (e.g. around petrol pumps, on the lower deck of a boat or around a fuel storage installation or chemical products)

Switch off the device if on an airplane or in a hospital.

- Never use the device in close proximity to a radio to avoid interference.
- Remove the batteries if the device is not in use for an extended period of time. Never mix used and new batteries
- Leave the transmitter and antenna at least 33mm from your face. Direct the antenna upwards and speak normally.

- Clean the device with a damp cloth. Do not use cleaning agents and solvents.
- Do not modify the device in any way. If the device damaged ,please checked by a qualified professional.
- The device cannot be used to contact the emergency services.

### **ITEM DESCRIPTION (Pic01,02)**

1. Antenna
2. RX icon  -Displayed when receiving  
TX icon  -Displayed when transmitting
3. Volume level indicator
4. Up adjustor button (▲)
5. Continued reception (MON)
6. On / off button (Ⓜ)
7. Down adjustor button (▼)
8. Earphone socket
9. Loud speaker
10. Microphone
11. Enter the menu settings (Menu)
12. Call button (📞)

13. Keypad lock indicator
14. Battery level indicator
15. Push to talk (PTT) button
16. VOX indication
17. Scanning indication:  
    Displayed during scan mode
18. Channel/Menu item indication
19. CTCSS/Menu option-value
20. Belt attachment clip
21. Belt attachment
22. Batteries (not supplied)
23. Battery compartment

### **To install the batteries**

To insert batteries into the devices, first remove the belt attachment: lift the attachment clip (20) and press the belt attachment(21) upwards. Open the battery compartment (23) and insert 3 AAA batteries (22) (not supplied), ensuring that the poles are correctly aligned. Then close the lid.

## **USING THE WALKIE TALKIE**

### **1. Turn the device on/off:**

To turn on the devices on or off , press the on/off button(6) for 3 seconds, there will be a BEEP sound to confirm.

### **2.Adjusting the volume:**

To increase the volume, press the Up adjustor button ▲(4) and press the ▼(7) button to decrease volume.

**Note:** The volume level (3) is displayed on the screen.

### **3.Battery Charge Level/Low Battery Indication**

The battery charge level is indicated by the number of squares present inside the battery icon on the LCD screen.

 Battery Full

 Battery 2/3 charged

 Battery 1/3 charged

 Battery empty

When the battery charge level is low, the battery icon will flash and a beep will be heard to indicate that the batteries need to be replaced or recharged.

#### **4. Receiving/Transmitting communications:**

The devices are in 'Reception' mode when lit up, i.e. they are ready to receive a call or sound transmitting on the activated frequency.

When you press the Call tone button (12), the device switches to 'Transmission' mode. You are then transmitting a sound signal to the other device.

To send a voice message, press the PTT button (15) and speak into the microphone (10). Continue to press the button until you have finished transmitting your message.

Please keep press the Talk button until you finish the transmitting .

Hold the Mic with a minimum distance of 25mm from your face.

#### **Note:**

- The other device must be set to the same channel and same CTCSS code.
- When you finish the communication, please lose the hand, the other device will email the beep to indicate that the this device is ready to transmit.

#### **5. Changing Channels**

- Press the MENU button (11) once, the current channel number flashes on the display.
- Press the ▲ button (4) or ▼ button (7) to change the channel .
- Press the PTT button to (15) confirm and return to stand-by mode.

**Note:** If no button is pressed within 15 seconds during setting, the unit will return to standby .



## **6.CTCSS (Continuous Tone Coded Squelch System)**

Licence free radio's operating on the 400~470 MHZ frequency band, like the Twintalker, have 8/20/22 available radio channels. If there are many radio's users in your neighborhood, there is a chance that some of these users are operating on the same radio channel. To prevent that you receive signals from other users, sub-channels have been integrated.

Two radios only be able to communicate with each other not only on the same channel but also set to the same sub-channels.

There is the sub-channels:continuous tone squelch system(CTCSS)

When using CTCSS, a low frequency tone(67-250Hz)will be transmitted along with the voice signal. There are 99 available tons to choose.

**Note:** To disable CTCSS, select code "0F" for CTCSS in the menu. When pressing PTT button to confirm.

## **7.CTCSS**

- Press the MENU-button (11) twice: The current CTCSS code flashes on the display
- Press the ▲-button (4) or the ▼-button (7) to change to another code.
- Press the PTT-button (15) to confirm and return to stand-by mode.

**Note:** To disable CTCSS, select code "0F" for CTCSS in the menu. When pressing PTT button to confirm.

## **8. Monitor**

You can use the monitor feature to check for weaker signals in the current channel.

- Press the MON-button to activate channel monitoring.
- Press the MON-button to stop channel monitoring.

**Note:** During channel monitoring the receiver circuit in the Radios will not listen to CTCSS codes.

## **9. VOX Selection**

The radios is capable of voice activated (VOX) transmission. In VOX mode, the radio will transmit a signal when it pick up your voice or other sound around you. VOX operation is not recommended if you plan to use your radio in a noisy or windy environment.

**Note:** VOX mode will be overridden when you press the PTT-button (15).

- Press the MENU(11) three times, the current VOX setting flashes on the display and the VOX icon is displayed.
- Press ▲-button (4) to set the VOX sensitivity level between 1 and 3 (level 3 is the most sensitive level).
- Press ▼-button (7) until OF appears on the display, to turn VOX off.
- Press the PTT -button (15) to confirm and return to stand-by mode.

## **10. Scanning for an active radio channel**

- Press and hold the **♪**-button (12): The 'Scan' function indicator (17) will appear on the screen and the channel (18) will scan continuously from 1 to 8/20/22.

- Press the **▼**-button (7) to start the channel scan from 8/20/22 to 1.

Once an active channel is found, the scanning will stop and you can listen to the transmission.

When the transmission on the found channel stops, the scanning will resume automatically.

**NOTE:** If you press the TALK button (15) while listening to a found channel, the Radios will go back in stand-by mode on the found channel.

## **11. Call Tones**

A call tone alerts others that you want to start talking.

### **11.1 Setting the Call Tone**

The walkie talkies have 10 call tones.

- Press the MENU-button (11) four times, "CA" is displayed and the current call tone is flashing.
- Press the **▲**-button (4) or the **▼**-button (7) to change to another Call Tone.
- Press the TALK-button (15) to confirm and return to stand-by Mode.

### **11.2 Sending a call tone**

Press the **♪**-button (12) briefly. The call tone will be transmitted on the set channel.

## **12.Key-Tone On/Off**

When a button is pressed, the unit will beep briefly. To set the key-tone.

- Press the MENU-button (11) five times, "to" will be displayed.
- Press ▲ to enable (ON) or ▼ disable the Key Tones (OF).
- Press the PTT-button (15) confirm your selection and return to the standby mode.

## **13.Roger Beep On/Off**

After the TALK-button is released, the unit send out a roger beep to confirm that you have stopped talking. To set the Roger Beep.

- Press the MENU-button (11) six times, "ro" will be displayed.
- Press ▲ to enable (ON) ▼ disable the Key Tone (OF)
- Press the PTT-button (15) to confirm your selection and return to the standby mode.

## **14.Button Lock**

Press and hold the MENU-button (11) for two seconds to activate the Button lock mode. The button lock icon is displayed on the LCD Screen.

Press and hold MENU button(11) until there are the Lock icon displayed on the LCD Screen.The same step to unlock the button.

**Note:** The PTT-button (15), the CALL-button (12), MON-button (5) and the on/off button (6) will still be functional when the Button Lock is activated,But the other button deactivated.

### **15. Display back light**

To activate the backlight of the LCD display, press any button.  
The LCD backlight will light up for 5 seconds.

### **16. Earpiece connection**

The Twintalker can be used with the included earpiece.

The connector is located on the top of the device.

Insert the earpiece plug into the connector (2.5mm jack).

The small button on the earpiece has the same function as the TALK-button (15) on the unit.

When you use the microphone from the earpiece to talk into.

Note: Do not connect other earpieces. This may damage your device.

### **17. Battery saving function:**

When the device has not been used for 6 seconds, the economy mode is automatically activated. This does not affect the reception of transmissions and the standard mode is automatically reactivated as soon as a signal is detected.

<b>EU Channel Frequency</b>				
Channel	1	2	3	4
Frequency	446.00625	446.01875	446.03125	446.04375
Channel	5	6	7	8
Frequency	446.05625	446.06875	446.08125	446.09375

<b>USA Channel Frequency</b>				
Channel	1	2	3	4
Frequency	462.5625	462.5875	462.6125	462.6375
Channel	5	6	7	8
Frequency	462.6625	462.6875	462.7125	467.5625
Channel	9	10	11	12
Frequency	467.5875	467.6125	467.6375	467.6625
Channel	13	14	15	16
Frequency	467.6875	467.7125	462.5500	462.5750
Channel	17	18	19	20
Frequency	462.6000	462.6250	462.6500	462.6750
Channel	21	22		
Frequency	462.7000	462.7250		

# FCC NOTICE AND DECLARATION

This device complies with Part 15 of the FCC Rules. Operation is subject to the following two conditions:

1. This device may not cause harmful interference, and
2. This device must accept any interference received, including interference that may cause undesired operation

Any modification to a walkie-talkie to receive transmissions from Service frequency bands voids the certification of the scanning receiver, regardless of the date of manufacture of the original unit. In addition, the provisions of FCC §15.23 shall not be interpreted as permitting modification of a scanning receiver to receiver Cellular Radiotelephone Service the Cellular Radiotelephone transmissions.

Caution:

- . To maintain compliance with the FCC's RF exposure guideline, hold the transmitter and antenna at least 1 inch (2.5 centimeters) from the face and speak at a normal volume/pitch, with the antenna pointed up and away from the face.
- . This device complied with FCC RF radiation exposure limits set forth an uncontrolled environment.
- . Use only the antenna supplied. Unauthorized antennas, modifications, or attachments could damage the transmitter and may violate FCC regulations.

This product is authorized to operate at a duty factor not to exceed 50%. To transmit (talk), push the PTT, to receive calls, release PTT key. Transmitting 50% of the time or less is important because the radio generates RF energy only when it transmits. When worn on the body, always use the manufacturer's belt clip and accessories approved with this product. Use non-approved accessories may result in exposure levels which exceed the FCC's RF exposure limits.

The device operates on GMRS (General Mobile Radio Service) frequencies, which require an FCC (Federal Communications Commission) license. You must be licensed prior to transmitting on all channels, which comprise of GMRS channels. Serious penalties could result for unlicensed use of GMRS channels, in violation of FCC rules, as stipulated in the Communications Act's Sections 501 and 502 (amended).

You will be issued a call sign by the FCC, which should be used for station identification when operating the radio on GMRS channels. You should also cooperate by engaging in permissible transmissions only, avoiding channel interference with other GMRS users, and being prudent with the length of their transmission time. To obtain a license or ask questions about the license application, contact the FCC at 1-888-CALL-FCC or go to the FCC's website: <http://www.fcc.gov> and request form 605.