



15370 Barranca Parkway  
Irvine, CA 92618-2215  
USA



## **DTC4500 User Guide**

P/N: L001444

DTC4500 Card Printer/Encoder User Guide (Rev 1.0), © 2010 property of HID Global Corporation. All rights reserved.

Exclusive permission is granted to authorized resellers of HID Global products to reproduce and distribute this copyrighted document to authorized HID Global customers, who have signed a no disclosure agreement regarding the restricted, proprietary use of said document.

The revision number for this document will be updated to reflect changes, corrections, updates and enhancements to this document.

<b>Revision Control Number</b>	<b>Date</b>	<b>Document Title</b>
Revision 1.0	March 2010	DTC4500 Card Printer/Encoder User Guide

### **Trademarks and Disclaimers**

HID, HID Global, and Fargo are the trademarks or registered trademarks of HID Global Corporation in the U.S. and other countries.

The information contained in this document is provided AS IS without any warranty.

HID Global hereby disclaims all warranties and conditions with regard to the information contained herein, including all implied warranties of merchantability, fitness for a particular purpose, title and non-infringement.

In no event shall HID Global be liable, whether in contract, tort or otherwise for any indirect, special or consequential damages arising from the use of the information contained in this document.

Any questions regarding changes, corrections, updates or enhancements to this document should be forwarded to:

Hid Global  
Support Services  
6533 Flying Cloud Drive  
Eden Prairie, MN 55344 (USA)  
(866)607-7339 Ext #6  
FAX: (952) 946-8492  
[www.hidglobal.com](http://www.hidglobal.com)

# Table of Contents

<b>DTC4500 User Guide</b>	<b>1</b>
<b>Section 1: Specifications</b>	<b>5</b>
Regulatory Compliances	5
Agency Listings	6
United States	6
Canada	6
Safety Messages (review carefully)	7
Environmental Protection (China-RoHS)	8
Traditional Chinese RF Emissions and Safety Statements	8
Simplified Chinese	9
Technical Specifications	10
Functional Specifications	13
Printer Components: Print Ribbons	13
Ribbon Types/Count Table	14
Printer Components: Blank Cards	15
<b>Section 2: Setup and Installation Procedures</b>	<b>16</b>
Choosing a Good Location	16
About Moisture Condensation	16
Unpacking and Inspection	16
Installing the Print Ribbon Cartridge (DTC4500)	17
Installing the Ribbon	17
Installing Blank Cards into the Card Hopper (DTC4500)	19
Using the Single and Dual Hopper	19
Setting the Card Size for CR79 and CR80	23
Connecting the Printer power	27
<b>Section 3: Print Driver Installation</b>	<b>28</b>
Driver Installation Instructions	28
<b>Section 4: Printer Preferences Tab Functions</b>	<b>29</b>
contextid=30 Using the Card tab	29
Using the Toolbox Options	30
contextid=150 Using the Configuration Tab	31
contextid=151 Selecting the Calibrate Laminator tab	32
Using the Event Monitoring Group Box	34
Reviewing the Ribbon Low message	34
contextid=152 Selecting the Calibrate Ribbon tab	35
contextid=154 Selecting the Clean Printer tab	37
contextid=155 Selecting the Advanced Settings tab	38
contextid=40 Using the Device Options tab	46
contextid=50 Using the Image Color tab	49
contextid=51 Using the Image Calibrate tab	52
contextid=70 Using the Magnetic Encoding Tab	53
Using the Magnetic Encoding Tab – ISO Standards	54
Using the Magnetic Encoding Tab – Custom Encoding or Raw Binary Encoding Mode	56
Reviewing the ISO Track Locations	57
Reviewing the Sample String	58
Sending the Track Information	59
Reviewing the ASCII Code and Character Table	60
contextid=80 Using the Lamination tab	62
contextid=90 Using the Overlay / Print Area tab	62

contextid=100Using the K Panel Resin tab	66
contextid=120Using the Printer Info tab	69
<b>Section 5: Selecting the Fluorescent Panel Ribbon Type</b>	<b>70</b>
Creating a Custom Fluorescent Image (using the YMCFKO Ribbon)	70
Configuring Fluorescent Data (F-Panel for YMCFKO Ribbon) using the Application	72
<b>Section 6: System Overview- Troubleshooting</b>	<b>76</b>
Reviewing the DTC4500 Sequence of Operations	76
Reviewing the DTC4500 Sequence of Operations	77
<b>Section 7: Troubleshooting</b>	<b>78</b>
Printer Error Button and Display Message Table	78
Using the Error Message Table	80
Troubleshooting with the Error Message Table	82
Printer Specific Tools (DTC4500)	92
Additional Printer Specific Tools (DTC4500)	93
<b>Section 8: Cleaning</b>	<b>94</b>
Safety Messages (review carefully)	94
DTC4500 Card Printer/Encoder Cleaning Kit	95
Printhead Cleaning	96
Cleaning the Platen and the Card Feed Rollers	97
Cleaning the Printer's Interior	99
Cleaning the Printer's Exterior	99
<b>Section 9: Firmware Upgrades</b>	<b>100</b>
Upgrade the Printer Firmware	100
<b>Section 10: HID Global Technical Support</b>	<b>103</b>
Reading the Serial Numbers on a Fargo Printer	104
<b>Appendix A</b>	<b>105</b>
Using the Defined Area Option	105
Configuring Fluorescent Data (F-Panel for YMCFKO Ribbon) using the Workbench	106

## Section 1: Specifications

The purpose of this section is to provide you with specific information on the Regulatory Compliances, Agency Listings, Technical Specifications and Functional Specifications for the DTC4500 Card Printer User Guide.

### Regulatory Compliances

Term	Description
CSA (cUL)	The Printer manufacturer has been authorized by UL to represent the Card Printer as CSA Certified under CSA Standard C22.2 No. 60950-1-03.  <b>File Number:</b> E145118
FCC	The Card Printer complies with the requirements in Part 15 of the FCC rules for a Class A digital device.
EMC	The Card Printer has been tested and complies with EN55022 / CISPR 22 Class A: and EN55024 standards.  <b>(Note:</b> Based on the above testing, the Printer manufacturer certifies that the Card Printer complies with current EMC directive 2004/108/EC of the European Community and has placed the CE mark on the Card Printer.)  <b>License Number:</b> J99032510
UL	The Card Printer is listed under UL IEC 60950-1 (2001) INFORMATION TECHNOLOGY EQUIPMENT  <b>(Note:</b> This product is intended to be supplied by a Listed Power Unit marked Class 2 and rated for 24 V dc, 3.7 to 5A.)  <b>File Number:</b> E145118
Environmental	Power supply Efficiency level IV, RoHS, China RoHS

## Agency Listings

Term	Description
Emissions Standards	CE, FCCPart 15 Class A, CRC c1374, CISPR22 Class A, EN55022, EN55024, EN61000-3-2, EN61000-3-3,
Safety Standards	UL IEC 60950-1 (2001), CSA C22.2 No. 60950-1-03.

### United States

This device complies with Part 15 of the FCC rules. Operation is subject to the following two conditions:

- (1) This device may not cause harmful interference.
- (2) This device must accept any interference received, including interference that may cause undesired operation.

**Note:** This equipment has been tested and found to comply with the limits for a Class A digital device, pursuant to part 15 of the FCC Rules. These limits are designed to provide reasonable protection against harmful interference when the equipment is operated in a commercial environment. This equipment generates, uses, and can radiate radio frequency energy and, if not installed and used in accordance with the instruction manual, may cause harmful interference to radio communications. Operation of this equipment in a residential area is likely to cause harmful interference; in which case, you will be required to correct the interference at his own expense.

Reference the Safety Messages in this document.

### Canada



This Class A digital apparatus complies with Canadian ICES-003.

C'et appareil numerique de la classe A est conforme a la norme NMB-003 du Canada.



**Caution:** Changes or modifications not expressly approved by the party responsible for compliance could void the user's authority to operate the equipment.

## Safety Messages (review carefully)

Symbol	Critical Instructions for Safety purposes
<p><b>Danger:</b></p> 	<p><b>Failure to follow these installation guidelines can result in death or serious injury.</b></p> <p>Information that raises potential safety issues is indicated by a warning symbol (as shown to the left).</p> <ul style="list-style-type: none"> <li>• <b>To prevent personal injury</b>, refer to the following safety messages before performing an operation preceded by this symbol.</li> <li>• <b>To prevent personal injury</b>, always remove the power cord prior to performing repair procedures, unless otherwise specified.</li> <li>• <b>To prevent personal injury</b>, make sure only qualified personnel perform these procedures.</li> </ul>
<p><b>Caution:</b></p> 	<p><b>This device is electrostatically sensitive. It may be damaged if exposed to static electricity discharges.</b></p> <p>Information that raises potential electrostatic safety issues is indicated by a warning symbol (as shown to the left).</p> <ul style="list-style-type: none"> <li>• <b>To prevent equipment or media damage</b>, refer to the following safety messages before performing an operation preceded by this symbol.</li> <li>• <b>To prevent equipment or media damage</b>, observe all established Electrostatic Discharge (ESD) procedures while handling cables in or near the Circuit Board and Printhead Assemblies.</li> <li>• <b>To prevent equipment or media damage</b>, always wear an appropriate personal grounding device (e.g., a high quality wrist strap grounded to avoid potential damage).</li> <li>• <b>To prevent equipment or media damage</b>, always remove the Ribbon and Cards from the Printer before making any repairs, unless otherwise specified.</li> <li>• <b>To prevent equipment or media damage</b>, take jewelry off of fingers and hands, as well as thoroughly clean hands to remove oil and debris before working on the Printer.</li> </ul>

# Environmental Protection (China-RoHS)

Environmental Protection Use Period is based on the product being used in an office environment.

## Traditional Chinese RF Emissions and Safety Statements

### 传统中文 射频放射及安全指令

#### 安全信息 (小心检查)

<b>标记</b>	<b>重要的安全事项说明安全</b>
<b>危险:</b>	<b>未按照说明安装可能造成人员伤亡。</b>
	<p>在可能产生潜在安全问题的地方有警示标记。(如左图所示)。</p> <p><b>为了防范人员伤亡, 做带此警示标记的操作前, 参考安全信息提示。</b></p> <p><b>为了防范人员伤亡, 在没有特别说明的情况下, 修理前关掉电源开关。</b></p>
<b>小心:</b>	<b>此设备对静电很敏感。如果受到静电放电, 设备会被损害。</b>
	<p>在可能产生潜在静电安全问题的地方有警示标记。(如左图所示)。</p> <p><b>为了防范损害设备, 做带此警示标记的操作前, 参考安全信息提示。</b></p> <p><b>为了防范损害设备, 在排放电路板和打印头联合装置里面或附近的电线时, 请注意观察所有的静电放电设备。</b></p> <p><b>为了防范损害设备, 贴身佩戴合适的接地装置 (比如: 手腕上带一个高质量的接地皮带以免受到可能的伤害)。</b></p> <p><b>为了防范损害设备, 如果没有特殊说明, 在做任何修理前, 请取下打印机上的色带和卡。</b></p> <p><b>为了防范损害设备, 在使用打印机之前, 请摘下戒指和手上饰品, 仔细清洗手上的油脂。</b></p>

經型式認證合格之低功率射頻電機, 非經許可, 公司、商號或使用者均不得擅自變更頻率、加大功率或變更原設計之特性及功能。低功率射頻電機之使用不得影響飛航安全及干擾合法通信; 經發現有干擾現象時, 應立即停用, 並改善至無干擾時方得繼續使用。前項合法通信, 指依電信法規定作業之無線電通信。低功率射頻電機須忍受合法通信或工業、科學及醫療用電波輻射性電機設備之干擾。



## Simplified Chinese

### 如何使用本手册

实际上, DTC4500 证卡打印机用户指南

是一本整个证卡打印机的故障排除和服务手册。本手册旨在帮助安装人员和技术人员快速有效地查找相关过程、组件和术语。安装人员或技术人员可根据自己的喜好, 高效地使用本手册的电子文档或纸面文档。

### 安全消息(请仔细阅读)

符号	安全事项的重要说明
危险: 	<p>如果不遵循这些安装指南进行操作, 可能会导致重伤, 甚至死亡。</p> <p>可能引发安全问题的信息由警告符号(如左图所示)来表示。</p> <p>为了确保人身安全, 在执行前面带有此符号的操作之前, 请先阅读下面的安全消息。</p> <p>为了确保人身安全, 除非另有规定, 否则在执行维修过程前, 始终应断开电源。</p> <p>为了确保人身安全, 只能由有资格的人员执行这些过程。</p>

安全消息(请仔细阅读)

符号	安全事项的重要说明
小心: 	<p>此设备为静电敏感设备。如果暴露在静电电流下, 可能会损坏设备。</p> <p>可能引发静电安全问题的信息由警告符号(如左图所示)来表示。</p> <p>为了防止设备或介质受损, 在执行前面带有此符号的操作之前, 请先阅读下面的安全消息。</p> <p>为了防止设备或介质受损, 请在处理电路板和打印头部件中或附近的电缆时, 遵守所有规定的静电放电 (ESD) 过程。</p> <p>为了防止设备或介质受损, 请始终佩带适当的个人接地设备(例如, 已接地避免出现潜在损坏的高质量腕带)。</p> <p>为了防止设备或介质受损, 除非另有规定, 否则在执行任何维修过程前, 始终应将色带和证卡与打印机分离。</p> <p>为了防止设备或介质受损, 在操作打印机前, 请取下手指和手上的珠宝首饰物, 并将手上的油渍和污渍彻底清洗干净。</p>

## Technical Specifications

Term	Function
Print resolution	<ul style="list-style-type: none"> <li>• 300 x 300 dpi(11.8 dots/mm)</li> <li>• Up to 16.7 million colors, Monochrome</li> </ul>
Printer Memory	16MB RAM
Print Area	CR-80 (3.375"L x 2.125"W / 85.6mmL x 54mmW)
Print Method	Dye Sublimation/Resin Thermal Transfer
Printer Driver & System Requirements	<ul style="list-style-type: none"> <li>• Windows XP, Server 2003 and 2008, Vista 32-bit and 64-bit compliance, Linux distributions-Red Hat, open</li> <li>• SUSE, SUSE Enterprise, Ubuntu, Fedora Core</li> <li>• Mac OS X version 10.0 to 10.5</li> <li>• x86 based PC or compatible, Windows 2000, Windows XP, Windows 2003, 500MHz computer with 256MB of RAM or higher, 500MB free hard disk space or higher</li> </ul>
Fargo E-card Software Development Kit	Support with developed Fargo E-card Software Development Kit (SDK).

## Technical Specifications

Term	Function
Connectivity	<ul style="list-style-type: none"> <li>• Standard USB 2.0 (USB Standard with this option), including single USB cable support for Omnikey 5121 and 5125 encoders</li> <li>• Ethernet 10/100 option, including single Ethernet cable support for Omnikey 5121 encoder (separate USB cable required for encoding with the Omnikey 5125 encoder)</li> <li>• Full bi-directional status messaging to the PC during the encoding process</li> </ul>
Print Speed	<p>Indicates the Ribbon type and the number of Ribbon panels printed where Y=Yellow, M=Magenta, C=Cyan, K=Resin Black, O=Overlay, F=Fluorescing Resin</p> <ul style="list-style-type: none"> <li>• YMCKO= 24 seconds per card</li> <li>• YMCKOK= 30 seconds per card</li> <li>• Resin= 6 seconds per card</li> <li>• Print speed indicates an approximate batch print speed and is measured from the time a card feeds into the Printer to the time it ejects from the Printer.</li> <li>• Print speeds do not include encoding time or the time needed for the PC to process the image.</li> <li>• Process time is dependent on the size of the file, the CPU, amount of RAM and the amount of available resources at the time of the print.</li> </ul>

## Technical Specifications

Term	Function
Card Size and Types Supported	<ul style="list-style-type: none"> <li>• CR-80 (3.362"L x 2.114"W / 85.4mmL x 53.7mmW)</li> <li>• CR-79 (3.303"L x 2.051"W / 83.7mmL x 51.9mmW)</li> <li>• 10 mil to 40 mil card thickness</li> <li>• Re-writable card technologies (requires special rewritable cards)</li> <li>• PVC, Polyester cards with a polished PVC finish</li> </ul>
Printer Dimensions	<p><b>DTC4500 :</b></p> <ul style="list-style-type: none"> <li>• 14.4"(366 mm)L x 9.2"(234 mm)W x 9.8"(249 mm)H w/o output bin</li> <li>• 18.1"(460 mm)L x 9.2"(234 mm)W x 9.8"(249 mm)H w/ output bin</li> </ul> <p><b>DTC4500 with Flipper (includes input Hopper):</b></p> <ul style="list-style-type: none"> <li>• 18.7"(475 mm)L x 9.2"(234 mm)W x 9.8"(249 mm)H</li> </ul> <p><b>DTC4500 without Flipper (includes input and output Hoppers):</b></p> <ul style="list-style-type: none"> <li>• 18.7"(475 mm)L x 9.2"(234 mm)W x 18.9"(480 mm)H</li> </ul>
Environmental Operation	<ul style="list-style-type: none"> <li>• 20-80% Humidity</li> <li>• 65° to 80° F / 18° to 27° C Temperature</li> </ul>
Electrical	<ul style="list-style-type: none"> <li>• External power adapter: 100-240 VAC, 1.5 A max, output 24Vdc 3.75A</li> <li>• 50 Hz/60 Hz Supply Frequency</li> <li>• Efficiency level IV</li> </ul>
Encoding Options Supported	<ul style="list-style-type: none"> <li>• Omnikey 5121 (iClass, Mifare, Desfire)</li> <li>• Omnikey 5125 (HID Prox, Indala)</li> <li>• Contact Smart Card (requires Omnikey 5121 or 5125 )</li> <li>• ISO Mag Encoding standard 7811, Parts 1-7. High or Low Coercivity. (Raw Magnetic Encoding option)</li> <li>• JIS II Mag Encoding</li> </ul>

## Functional Specifications

This Card Printer utilizes two different, yet closely related printing technologies to achieve its remarkable direct-to-card print quality for dye-sublimation and resin thermal transfer.

### Printer Components: Print Ribbons

The Card Printer utilizes both dye-sublimation and/or resin thermal transfer methods to print images directly onto blank cards. Since the dye-sublimation and the resin thermal transfer print methods each provide their own unique benefits, Print Ribbons are available in resin-only, dye-sublimation-only and combination dye-sublimation/resin versions.

To make it easier to remember which Print Ribbons are which, a letter code has been developed to indicate the type of Ribbon panels found on each Ribbon. This letter code is as follows:



= Dye-Sublimation Yellow Panel



= Dye-Sublimation Magenta Panel

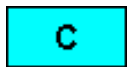

= Dye-Sublimation Cyan Panel



= Resin Black Panel (Premium unless otherwise stated )

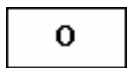

= Clear Protective Overlay Panel



= Ultra Violet Fluorescing Panel

## Ribbon Types/Count Table

Ribbon type and count used in each Printer.

<b>Ribbon</b>	<b>DTC4500</b>
<b>YMCKO – Full Color/Resin Black/Overlay</b>	<b>500</b>
<b>YMCKO Half Panel – Full Color (1/2)/Resin Black/Overlay</b>	<b>850</b>
<b>YMCFKO - Full Color/UV Fluorescing/Resin Black/Overlay</b>	<b>500</b>
<b>YMCKK - Full Color/2 Resin Black</b>	<b>500</b>
<b>YMCKOK - Full Color/2 Resin Black/Overlay</b>	<b>500</b>
<b>YMCFKOK - Full Color/UV Fluorescing/2 Resin Black/Overlay</b>	<b>400</b>
<b>K – Standard Resin</b>	<b>3000</b>
<b>K – Premium Resin</b>	<b>3000</b>
<b>Colored Resin</b>	<b>2000</b>
<b>Metallic Resin</b>	<b>2000</b>
<b>KO - Premium Black Resin/Overlay</b>	<b>1250</b>
<b>BO - Dye-Sub Black/Overlay</b>	<b>1250</b>
<b>None – Rewritable</b>	<b>Supported</b>

## Printer Components: Blank Cards

Type	Description
Card Size	The Card Printer accepts standard CR-80 and CR-79 sized cards.
Card Surface	<p>Suitable cards must have a polished PVC surface free of fingerprints, dust or any other types of embedded contaminants. In addition, cards must have a completely smooth, level surface in order for the Printer to achieve consistent color coverage.</p> <ul style="list-style-type: none"> <li>• Certain types of Proximity cards have an uneven surface that will inhibit consistent color transfer.</li> <li>• Certain types of smart card chips are raised slightly above the cards surface which also results in poor color transfer.</li> </ul>
UltraCard™ Brand Cards	<p>The UltraCard product line, available exclusively as part of HID's Global's Fargo brand secure card issuance solutions, has a long standing reputation among dealers and end-Users for consistent quality in construction.</p> <ul style="list-style-type: none"> <li>• In addition to blank stock, the UltraCard line is available in a variety of configurations for magnetic stripe, custom holograms and other additional anti-counterfeiting feature</li> <li>• UltraCard™ Premium is the preferred card for Direct-to-Card (DTC®) applications that require a higher quality card. The UltraCard Premium's composite material construction provides for maximum durability, flexibility and card life, with optimal resolution print quality for lamination and fluorescent panel Ribbon printing applications.</li> <li>• UltraCard™ PVC cards are medium-durability cards for a glossy, photo quality finish. These cards are manufactured to ensure clean, scratch-free cards for high-quality prints and extended Printhead life.</li> </ul>

## Section 2: Setup and Installation Procedures

This section describes the setup and installation for the DTC4500 Card Printer.

### Choosing a Good Location

Follow these guidelines:

- Place the unit in a location with adequate air circulation to prevent internal heat build up.
- Use the Printer's dimensions as a guideline for the minimum clearances to the unit. (**Note:** Allow for adequate clearance in front of the unit to accommodate the unit with its Covers open.)
- Do not install unit near heat sources such as radiators or air ducts or in a place subject to direct sunlight, excessive dust, mechanical vibration or shock.

### About Moisture Condensation

If the unit is brought directly from a cold to a warm location or is placed in a very damp room, moisture may condense inside the unit. Should this occur, print quality may not be optimum.

Leave the unit turned **Off** in a warm, dry room for several hours before using. This will allow the moisture to evaporate.



**Caution:** For safety purposes, Ethernet is not intended for a direct connection outside of the building.

### Unpacking and Inspection

While unpacking your Printer, inspect the carton to ensure that no damage has occurred during shipping. Make sure that all supplied accessories are included with your unit.

Check that the following items are included:

- Power Supply
- US / EU Power Cable
- USB cable (2.0)
- Software Installation CD/User Guide
- User Guide
- Warranty Statement, Registration Card and Compliancy Document





## Installing the Print Ribbon Cartridge (DTC4500)

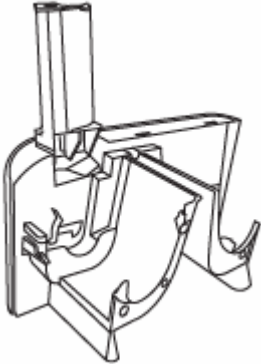

Fargo Card Printers require highly specialized supplies to function properly.

- The Fargo DTC4500 Card Printer uses a one-piece, refill system.
- To maximize Printer life, reliability, printed card quality and durability, you must use only Fargo-certified supplies.
- For this reason, your Fargo warranty is void, where not prohibited by law, if you use non-Fargo-certified supplies.
- Printer cleaning is recommended with each Ribbon change to ensure quality printed cards.
- Resin-only Print Ribbons consist of a continuous roll of a single resin color. No protective overlay panel (O) is provided since resin images do not require the protection of such an overlay.

### Installing the Ribbon

Step	Procedure
1	<p>Lift up the Cleaning Roller Cover.</p> 
2	<p>Load the Print Ribbon into the Print Ribbon Cartridge.</p> 

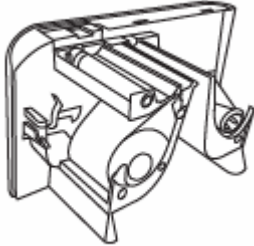
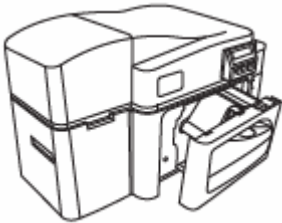
## Installing the Ribbon

Step	Procedure
3	<p>a. Close the Cleaning Roller Cover.</p> <p>b. Insert the new Cleaning roller.</p>  A detailed line drawing of the cleaning roller assembly. It shows a rectangular frame with a central roller and various adjustment screws and levers. A small circular component, the cleaning roller, is shown being inserted into the assembly.
4	<p>Load the Ribbon Cartridge into the Printer.</p>  A line drawing of the printer from a three-quarter perspective. The front cover is open, revealing the internal components where the ribbon cartridge is located.
5	<p>Close the Front Cover.</p>  A line drawing of the printer from a three-quarter perspective, identical to the previous diagram but with the front cover closed.

# Installing Blank Cards into the Card Hopper (DTC4500)

## Using the Single and Dual Hopper



**Caution:** Do not run the cards with a contaminated, dull or uneven surface through the Printer.

Step	Procedure
1	<p><b>Pre-instruction.</b></p> <ul style="list-style-type: none"> <li>• Printing onto such cards will ultimately lead to poor print quality and will greatly reduce the life of the Printhead. Card Types include PVC or PVC finish.</li> <li>• Cards eject into the Output Hopper or Reject Hopper.</li> <li>• Each Hopper holds 100 cards.</li> <li>• The DTC4500 is available with two (2) Hopper configurations: Single and Dual Hopper</li> <li>• Certain types of smart card chips are raised slightly above the cards surface which may result in poor color transfer. Design the card with white space surrounding the chip. (<b>Note:</b> The Fargo DTC4500 Printer is capable of printing single load cards and multiple feed cards (batch mode).)</li> <li>• To print using single feed, simply remove all cards from the Card Hopper, leave the Card Hopper door closed and place a card in the single Feed Card Slot (which can be used repeatedly).</li> <li>• Again, the cards should be loaded with the print side down and (if applicable) the magnetic strip up and towards the front of the Printer.</li> </ul>

### Using the Single and Dual Hopper

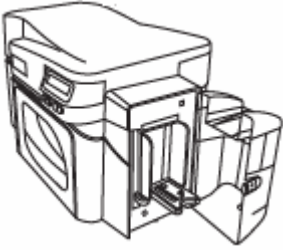
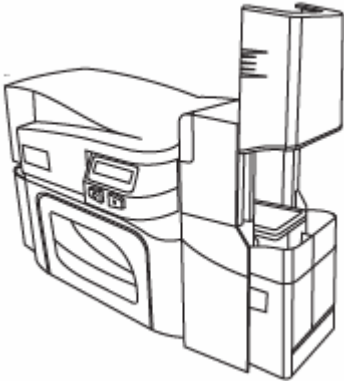
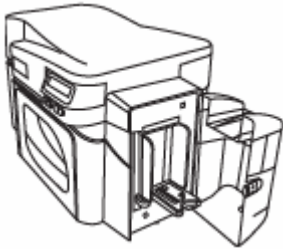
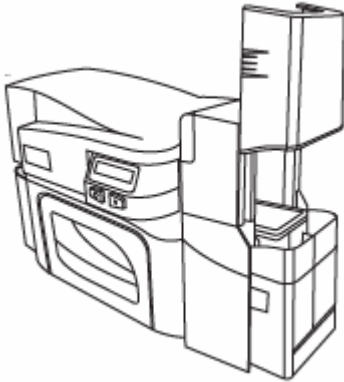
Step	Procedure
2	<p data-bbox="266 342 656 373">Open the Card Hopper Cover.</p> <div data-bbox="289 552 570 800"></div> <p data-bbox="282 821 467 852">Single Hopper</p> <div data-bbox="716 415 1057 793"></div> <p data-bbox="824 821 993 852">Dual Hopper</p>
3	<p data-bbox="266 886 1263 917">Press the Card Hopper Load Lever down until the Card Tray locks into place.</p> <div data-bbox="280 1102 561 1350"></div> <div data-bbox="735 961 1076 1339"></div>

### Using the Single and Dual Hopper

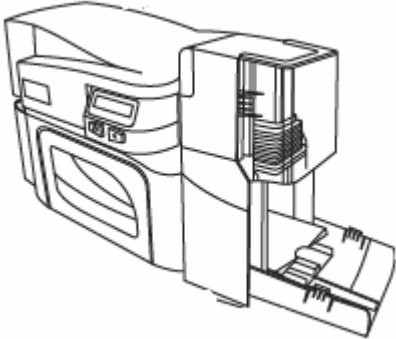
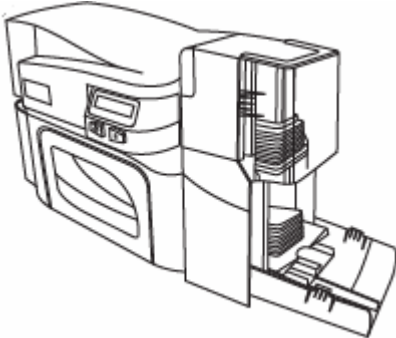
Step	Procedure
4	<p data-bbox="264 342 1276 443">Load up to 100 cards into the Hopper with the print side down. (<b>Note:</b> If using cards with a magnetic stripe, the magnetic stripe should be loaded with the stripe up and to the front of the Printer.)</p> <p data-bbox="264 459 1255 493"><b>Display: Card loaded into the upper Hopper of DTC4500 Single Hopper</b></p>  <p data-bbox="264 926 1190 959"><b>Display: Cards loaded into lower Hopper of DTC4500 Dual Hopper</b></p> 

## Using the Single and Dual Hopper

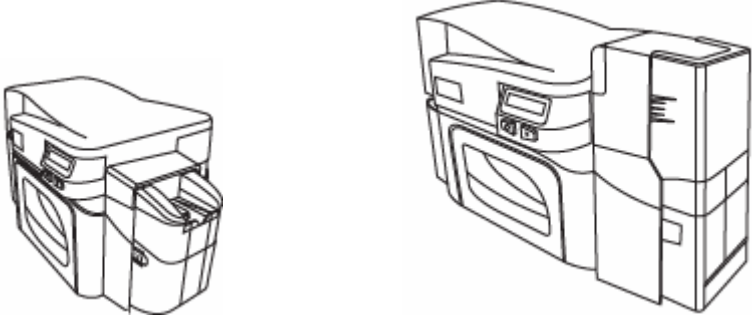
Step	Procedure
5	<p data-bbox="266 365 1211 401">Close the Card Hopper Cover to release the lever to the printing position.</p> 

## Setting the Card Size for CR79 and CR80

Follow this procedure in the Printer and in the Printer Driver to setup the card size.

Step	Procedure
1	<p data-bbox="267 430 836 462">Open the front door and locate the slide bar.</p> 

### Setting the Card Size for CR79 and CR80

Step	Procedure
2	<p data-bbox="266 342 971 373">If using the CR79 card, push the slide bar to the LEFT.</p>  <p data-bbox="639 940 1070 1094">Push LEFT for CR79 card size</p>



### Setting the Card Size for CR79 and CR80

Step	Procedure
3	<p>If using the CR80 card, push the slide bar to the RIGHT.</p>  <p>Push RIGHT for CR80 card size</p>

### Setting the Card Size for CR79 and CR80

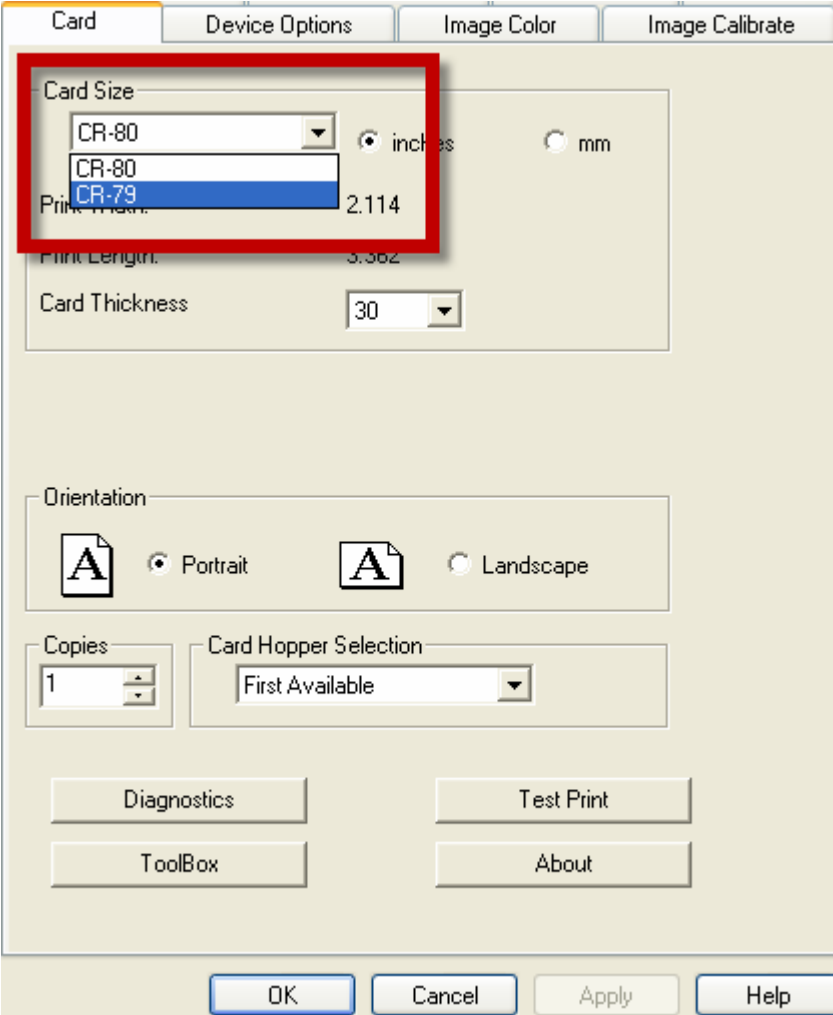
Step	Procedure
4	<p data-bbox="266 342 1110 373">From the Driver Printing Preferences, select the correct card size.</p> 

## Connecting the Printer power

Follow this procedure. (**Note:** Do not connect the Printer's USB cable until prompted during the Printer Driver installation.)

Step	Procedure
1	Plug the AC adapter power cable into the back of the Printer. 
2	Plug the wall power cable into the AC power adapter. This display shows Printer from behind with AC power cable.
3	Plug the wall power cable into a standard 110VAC power outlet.
4	Press the left ON/Off Button to power up the printer.

## Section 3: Print Driver Installation

This section describes the Printer Driver installation requirements and standard procedures. Requirements are listed below. The DTC4500 Print Driver supports the following:

- Vista, 32 bit Windows OS,
- Windows XP
- Server 2003
- Vista, 64 bit Windows OS
- Linux OS (Ubuntu7.10, Red Hat Enterprise Desktop 5, Fecora Core 7 & 8, openSUSE 10.3 , open NOVELL SUSE 10.). Contact HID/Fargo Technical Support for the driver.

### Driver Installation Instructions

Start the installation process by inserting the Driver CD into the computer. Then, follow the Installaware Wizard screen prompts.

- Select 32 bit Windows or 64 bit Windows to start the installation.
- Select the Fargo Workbench Utility Program to install this program.
- Specific versions of Windows require Administrator rights.
- From the Printer & Faxes folder, open the Printing Preferences to setup the Driver after it has been installed.
- Printing Preferences need to be setup after the Driver has been installed. Each TAB is shown in the next section.
- Use the drop down arrows to select the correct options for each printing preference.

## Section 4: Printer Preferences Tab Functions

This section provides an overview of the Printer Driver preferences tab.

### Using the Card tab

Click on the Card tab to bring up the window (shown below). Refer to the **Help** file for the **Fargo Workbench Utility Program and User Guide**.

**DTC4500 Card Printer Printing Preferences**

**Card** | Magnetic Encoding | Lamination | Overlay / Print Area | K Panel | Device Options | Image Color

**Card Size**

CR-80 | inches | mm

Print Width: 2.114

Print Length: 3.362

Card Thickness: 30

**Orientation**

Portrait | Landscape

Copies: 1

Card Hopper Selection: First Available

Diagnostics | Test Print

ToolBox | About

Select either **CR-80 (ISO ID-1)** or **CR-79** sized cards for Card Size.

Click **inches** or **mm** to choose the desired unit of measurement.

Select Print **Print Width** or **Print Length** for the desired Card Dimensions.

Select **Card Thickness (mil)** as required for that dimension.

Select **Portrait** for vertical orientation and **Landscape** for horizontal orientation.

Select the number of copies.

Select the correct Card Hopper.

Click on **Diagnostics** to bring up the Workbench Printer Utility.

Click on the **Test Print** button to send a self-test print to the Printer.

Click on the **About** button to bring up the Copyright, Version, and Date Code information for Printer Driver Software.

Click on the **Toolbox** button to bring up the Configuration, Calibrate Ribbon, Clean Printer, and Advanced Settings.

**Note:** See below for more information on the Diagnostics and Toolbox.

## Using the Toolbox Options

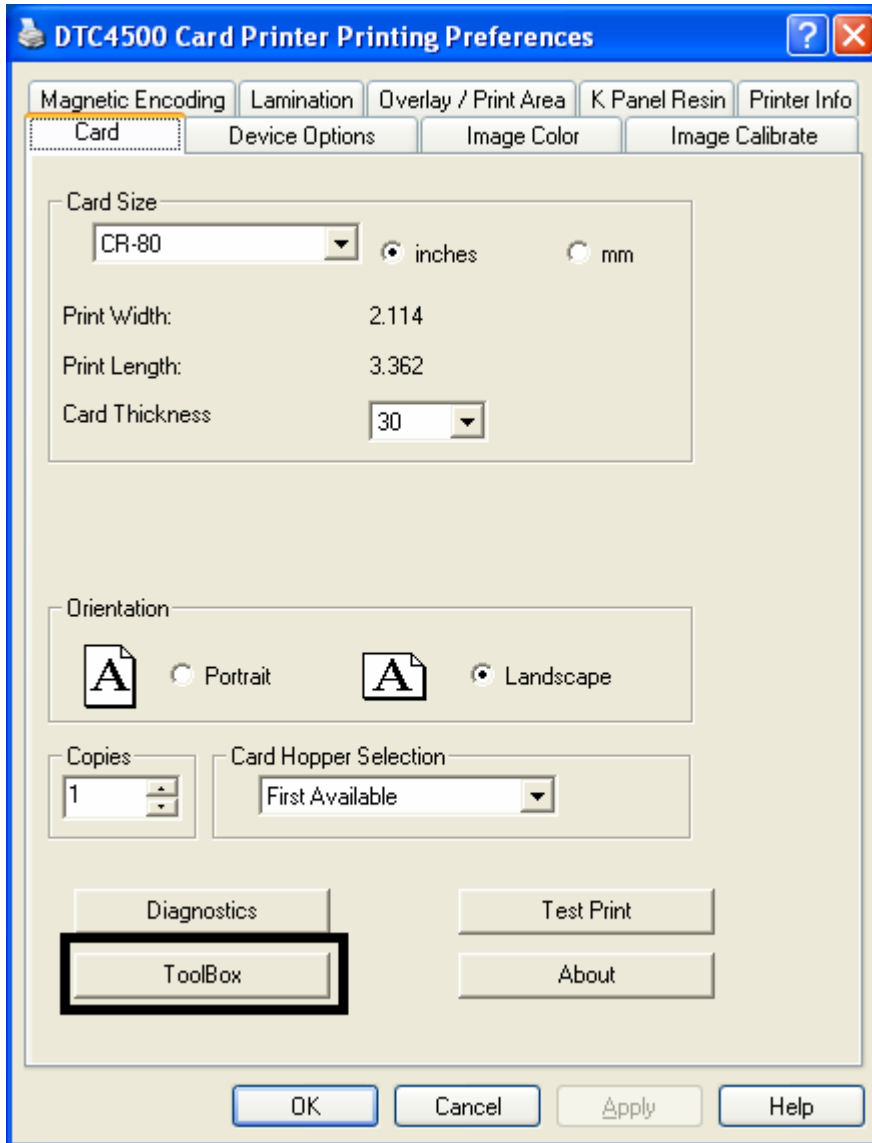

## Using the Configuration Tab

This option is used to show the currently installed Optional Printer features, Event Monitoring, to set the Printer Driver language and Printer LCD Display language.

- To switch between languages, select the desired language and reboot the driver.

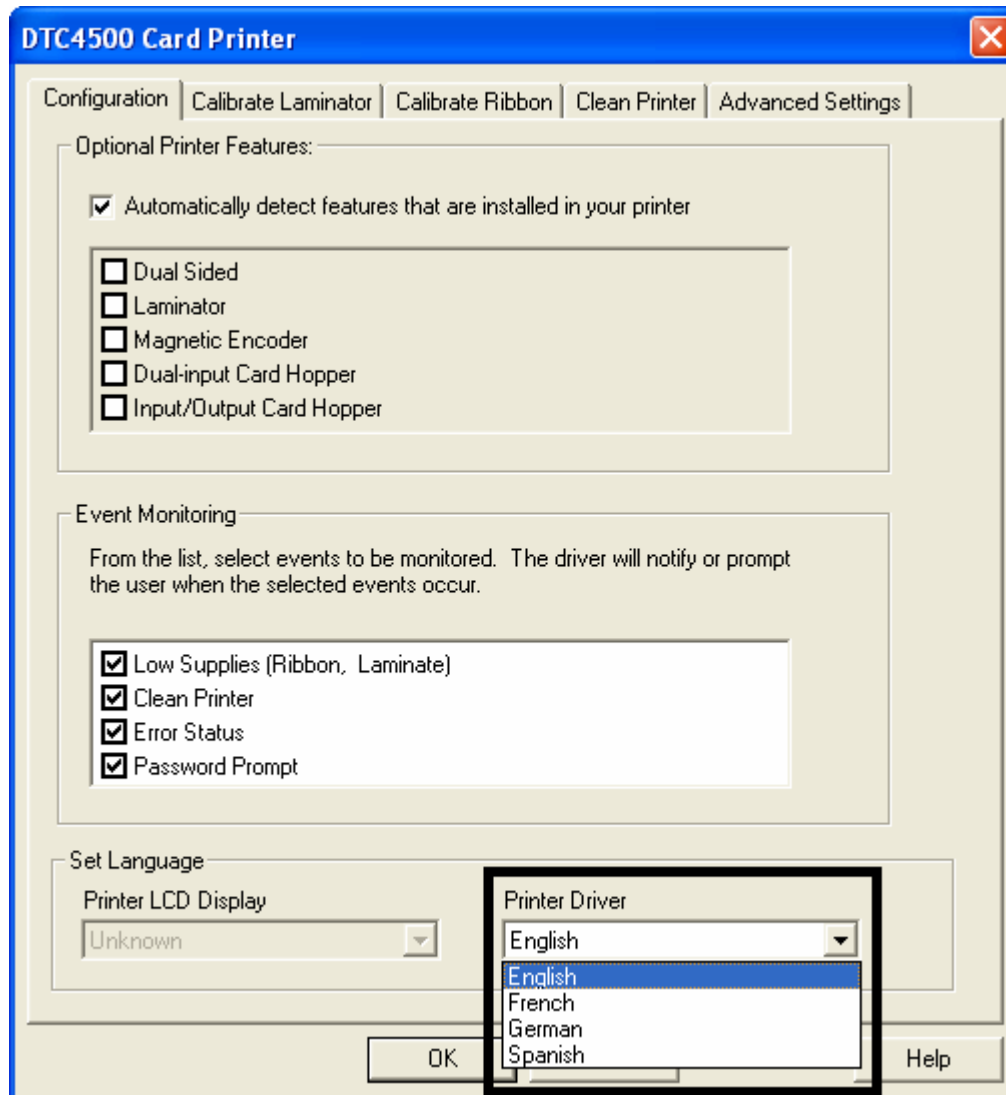

## contextid=151 Selecting the Calibrate Laminator tab

The Calibrate Laminator tab is active when the Laminator is automatically detected or when the Laminator is manually checked (as a Printer Feature on the Configuration tab). If the Laminator is not detected and not manually checked, the tab is active; however, all functions are grayed out.

- **Calibrate button:** Sends calibrate Laminator command to Printer. Follow the instruction on the page for setting up the Printer.
- **Help button:** Launches help specific to this tab.

Step	Procedure
1	Select the Calibrate Laminator tab. <ol style="list-style-type: none"> <li>Ensure that the Cartridges are out of the Laminator.</li> <li>Ensure the Laminator Cover is closed.</li> <li>Click on the Calibrate button. (<b>Note:</b> The Printer's LCD will display CALIBRATE PASSED. Error Message Calibration Failed may be solved by manually increasing the sensor calibration number to 13 or higher under the Advanced Settings tab. Do not use the AUTO calibrate function.)</li> <li>Click on the <b>OK</b> button on the LCD display to complete the procedure.</li> </ol>



## Selecting the Calibrate Laminator tab

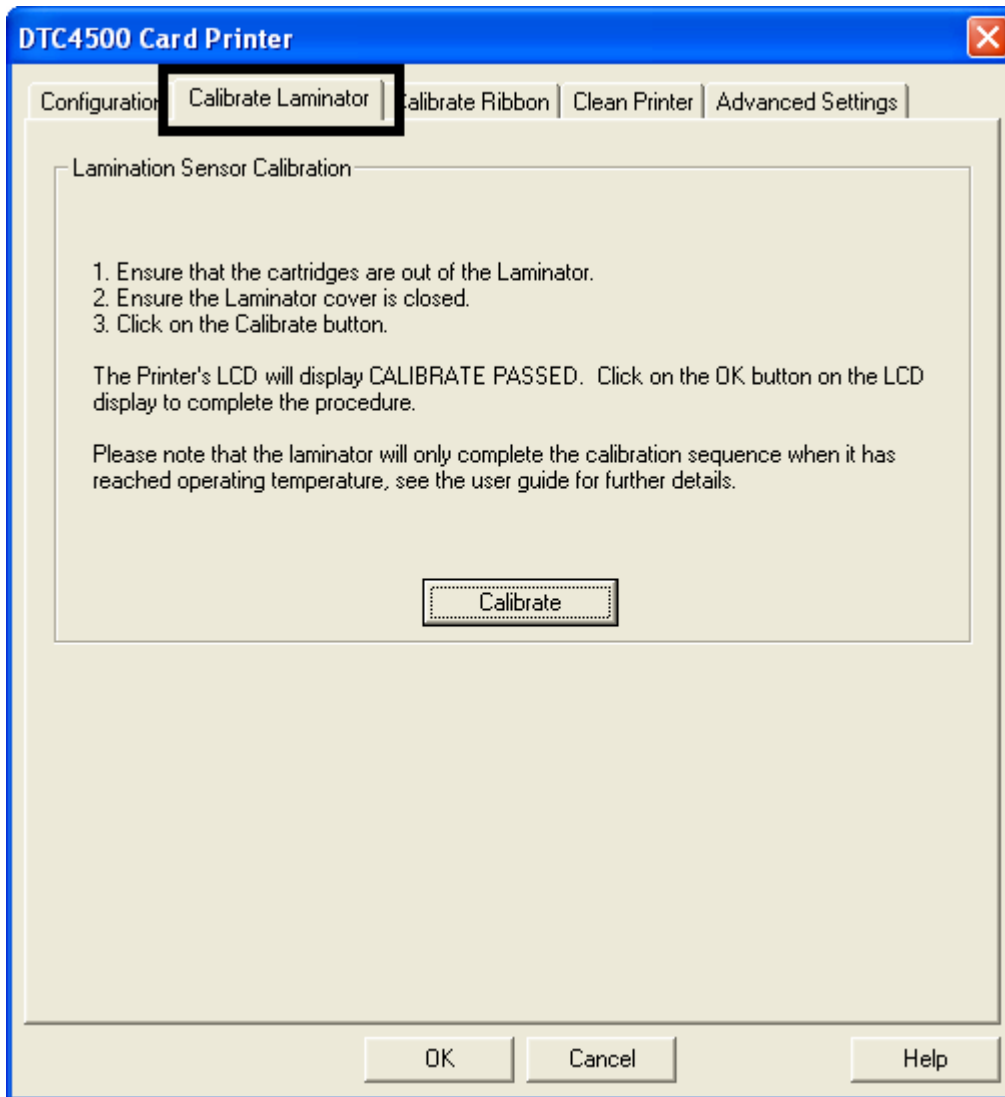

## Using the Event Monitoring Group Box

This Event Monitoring group box displays the Low Supplies (Ribbon, Laminate and Film).

- **The default setting is checked.** If checked, the Ribbon Low message box is displayed with every print job when Printer reports low Ribbon to the Driver.
- **Do not show this message again:** The check box allows the User to suppress message per Driver instance. Default = unchecked.

## Reviewing the Ribbon Low message

Display – Ribbon Low dialog

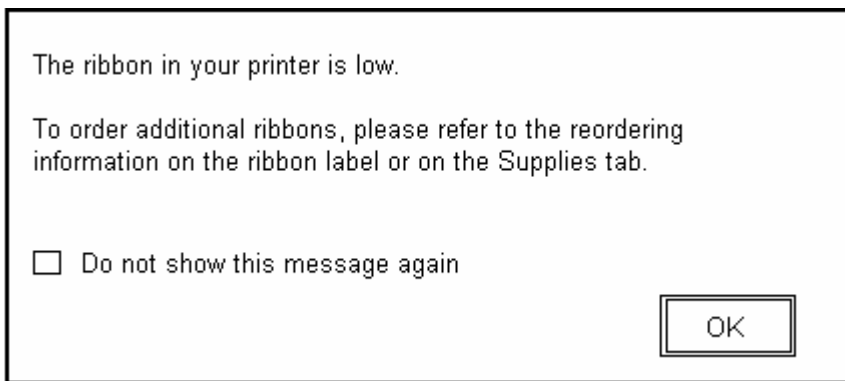

## |contextid=152 Selecting the Calibrate Ribbon tab

The two buttons for the Calibrate Ribbon tab are described below.

- **Calibrate button:** Sends the Calibrate Ribbon Command to Printer. Follow the instructions below to set up the Printer.
- **Help button:** Launches help specific to this tab.

Step	Procedure
1	Select the Calibrate Ribbon tab. <ol style="list-style-type: none"><li>Ensure that the Ribbon Cartridge is removed.</li><li>Ensure the Printer's Cover is closed.</li><li>Click on the <b>Calibrate</b> button. (<b>Note:</b> The Printer's LCD will display CALIBRATE PASSED.)</li><li>Click on the <b>OK</b> button on the LCD display to complete the procedure.</li></ol>

## Selecting the Calibrate Ribbon tab

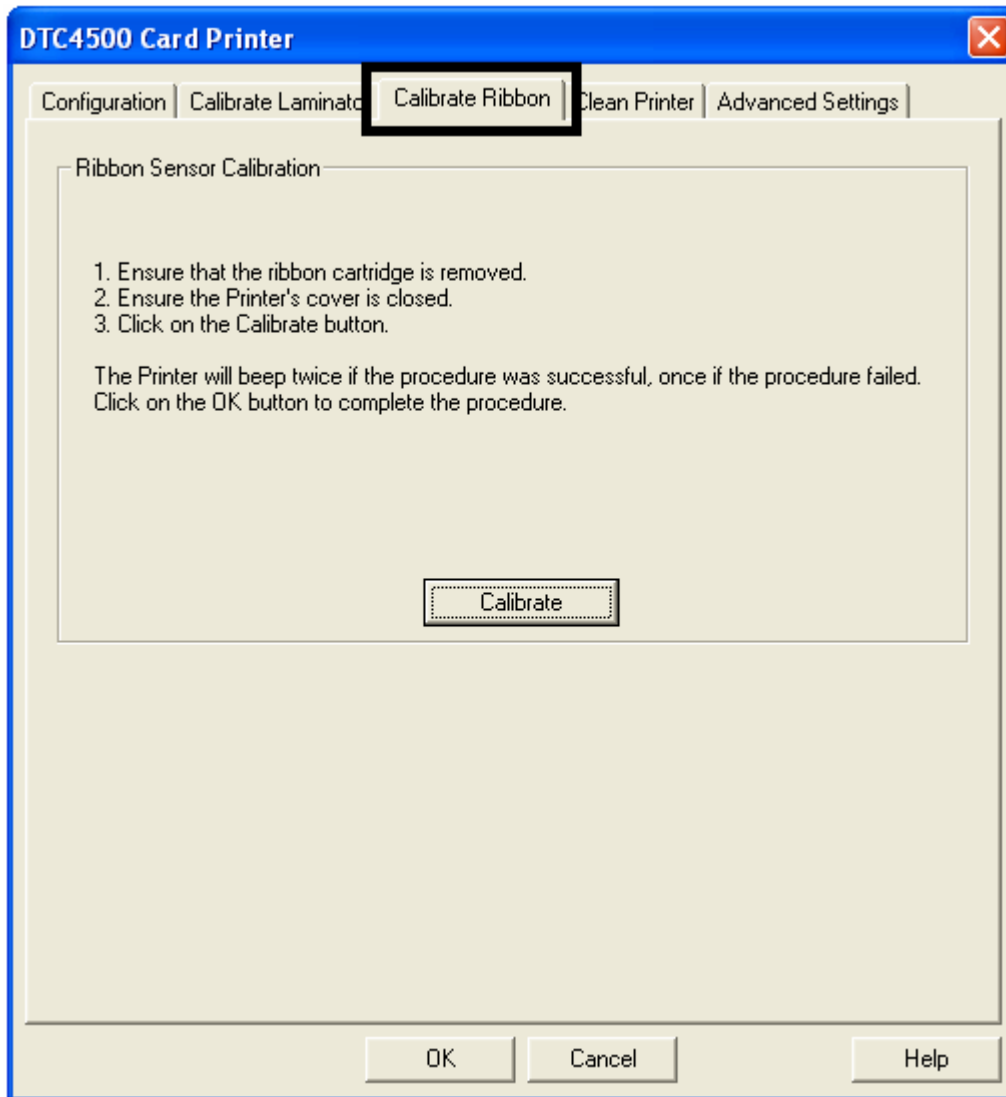

## contextid=154 Selecting the Clean Printer tab

The button for the Clean Printer tab is described below.

- **Clean Button:** Launches cleaning routine. Follow the instruction on the page for setting up the Printer.
- **Help button:** Launches help that is specific to this tab.
- Also see [Cleaning the Printer](#) for full instructions.

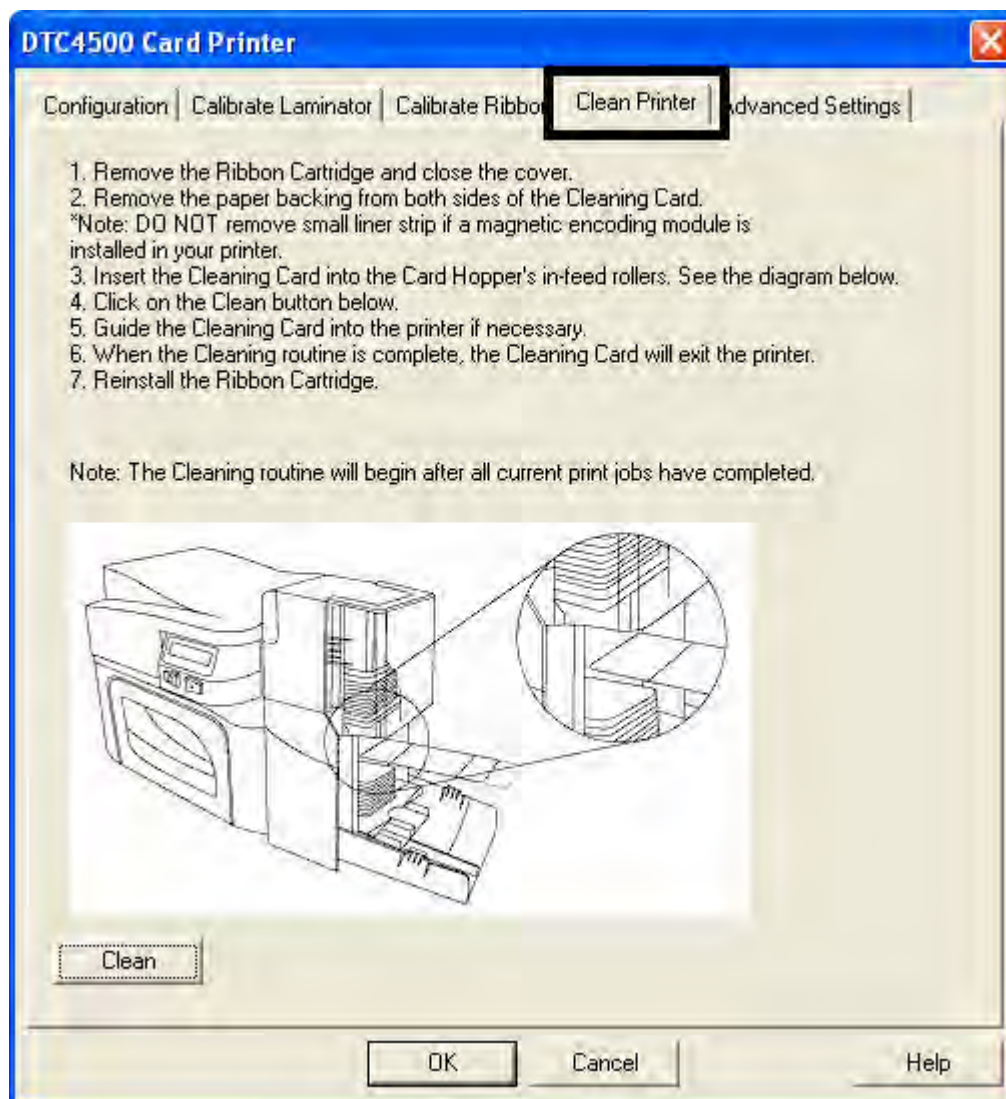

## |contextid=155 Selecting the Advanced Settings tab

Use the **Advanced Settings** tab for adjusting the internal Printer settings, which are customized for every Printer at the factory and saved directly within the Printer's memory. (**Note:** You can select the Restore Defaults to restore the internal default settings.)

### Selecting the Advanced Settings tab

These change values for Firmware settings. See below.

- **Setting Column:** Displays label for setting
- **Default Column:** Displays default value for setting
- **Current Column:** Displays current value for setting
- Change the value by clicking on the value to activate spin control or type.
- **Apply Button:** Applies changed values.
- **Restore Defaults Button:** Restores default values.

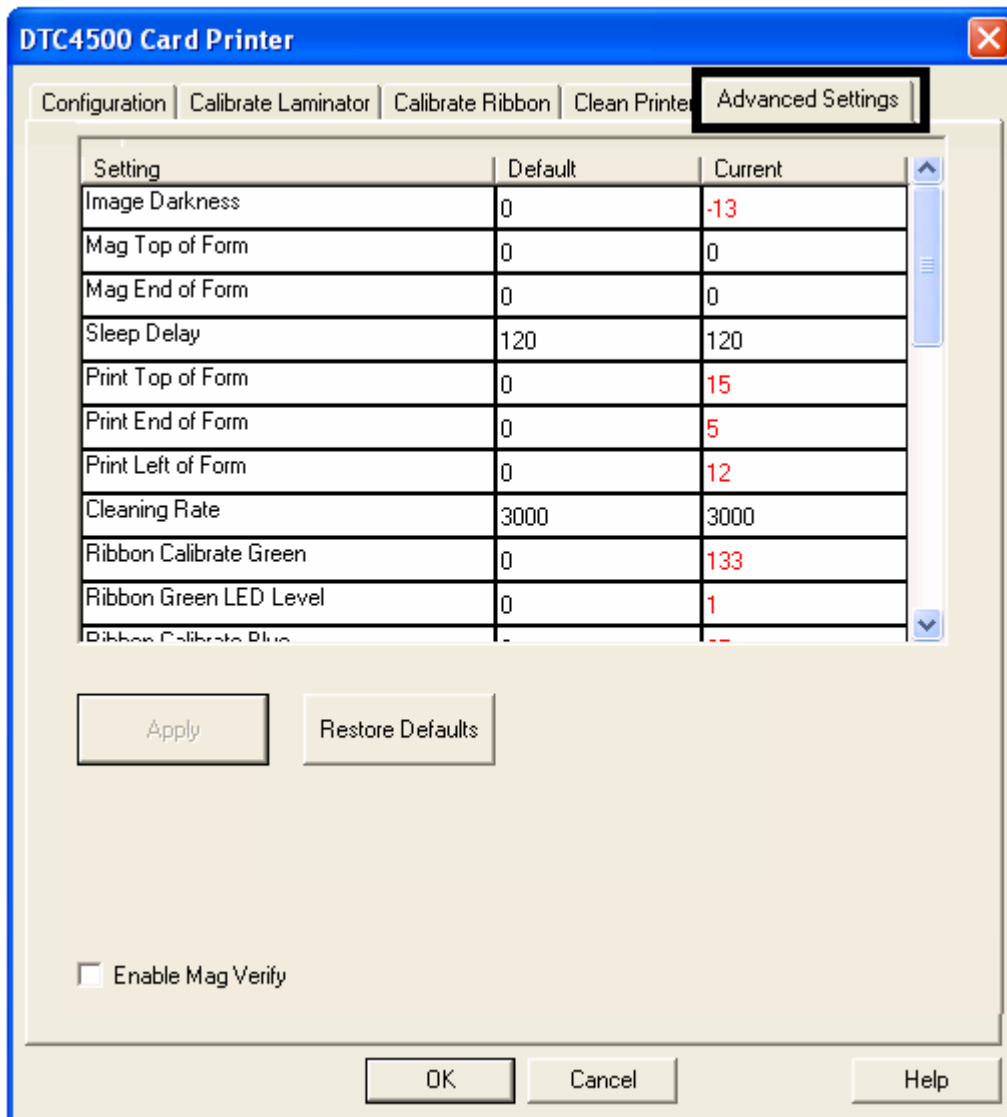

### Selecting the Advanced Settings tab



Example:

Setting	Default	Current
Image Darkness	0	-14

## Selecting the Advanced Settings tab

Setting	Option
<b>Image Darkness</b>	<p>Use this option to set the overall darkness of the printed image by increasing or decreasing the amount of heat (used by the Printhead when printing).</p>  <p><b>Caution:</b> If the value is set too high, the Ribbon may jam or even break.</p>
<b>Mag Top of Form</b>	<p>Use this option to shift the starting point where the Printer begins to encode the magnetic track data on the card's Magnetic Stripe.</p>  <p><b>Caution:</b> If the negative value is set too high, the Printer may start encoding before the Magnetic Stripe reaches the encoding head.</p> <ul style="list-style-type: none"> <li>• Maximum adjustment range is +/- 80.</li> <li>• Each increment equals .01”.</li> </ul>
<b>Sleep Delay</b>	<p>The Sleep Time setting adjusts the number of minutes of inactivity before the Printer enters a low power sleep state.</p>



## Selecting the Advanced Settings tab

Setting	Option
<b>Print Top of Form</b>	<p>Use this option to adjust the length-wise or horizontal position of the printed image on the card (so it appears to be centered).</p>  <p><b>Caution:</b> If the negative value is set too high, the Print Ribbon may break.</p>
<b>Print End of Form</b>	<p>Use this option to reduce or increase the overall printable area; this is done in order to optimize edge to edge printing toward the trailing edge of the card.</p> <ul style="list-style-type: none"> <li>• Maximum adjustment range is +/- 200.</li> <li>• Each increment equals .01”.</li> </ul>
<b>Print Left of Form</b>	<p>Use this option to adjust the vertical position of the printed image on the card; so it appears centered.</p> <ul style="list-style-type: none"> <li>• Maximum Adjustment Range is +/- 127.</li> <li>• Each increment equals .01”.</li> </ul>
<b>Cleaning Rate</b>	<p>Use this option to adjust the number of cards printed before the Printer displays a message indicating cleaning is needed.</p> <ul style="list-style-type: none"> <li>• The default value is 3000 cards.</li> </ul>

## Selecting the Advanced Settings tab

Setting	Option
<b>Ribbon Calibrate Green</b>	This is a calibration driven value and should not be adjusted. <b>(Note:</b> This is factory set and should not be changed unless directed by a technician.)
<b>Ribbon Green LED Level</b>	This is a calibration driven value and should not be adjusted. <b>(Note:</b> This is factory set and should not be changed unless directed by a technician.)
<b>Ribbon Calibrate Green</b>	This is a calibration driven value and should not be adjusted. <b>(Note:</b> This is factory set and should not be changed unless directed by a technician.)
<b>Ribbon Blue LED Level</b>	This is a calibration driven value and should not be adjusted. <b>(Note:</b> This is factory set and should not be changed unless directed by a technician.)
<b>Ribbon Print Tension</b>	Use the Ribbon Tension option to increase or decreases the amount of tension (drag) on the Ribbon during printing.
<b>Flipper Home Offset</b>	This is a calibration driven value and should not be adjusted. If the Flipper unit is replaced and has not been calibrated this value may need to be adjusted. <b>(Note:</b> This is factory set and should not be changed unless directed by a technician.)

## Selecting the Advanced Settings tab

Setting	Option
<b>Flipper Lam Height Offset</b>	<p>This is a calibration driven value and should not be adjusted. If the Flipper unit is replaced and has not been calibrated this value may need to be adjusted.</p> <p><b>(Note:</b> This is factory set and should not be changed unless directed by a technician.)</p>
<b>Mag HI-Co Voltage Offset</b>	<p>This option changes the voltage going the magnetic head.</p> <p><b>(Note:</b> This is factory set and should not be changed unless directed by a technician.)</p>
<b>Mag Lo-Co Voltage Offset</b>	<p>This option changes the voltage going the magnetic head.</p> <p><b>(Note:</b> This is factory set and should not be changed unless directed by a technician.)</p>
<b>OLED Contrast</b> (display contrast)	<p>Use this option to increase or decrease the contrast of the printer OLED (if applicable).</p>
<b>Resin Heat Adjust</b>	<p>Use this adjustment for Black resin text and barcodes appear faded or too light/dark.</p> <p>Adjust the Resin Heat, Front (K) or the Resin Head, Back (K) as needed.</p> <ul style="list-style-type: none"> <li>• Move the slider to the left to cause less heat to be used in the printing process, causing resin images to be lighter or less saturated.</li> </ul> <p><b>OR</b></p> <ul style="list-style-type: none"> <li>• Move the slider to the right to (a) cause more heat to be used or (b) cause the resin image to be darker or more saturated.</li> </ul> <p><b>(Note:</b> This control can be helpful for fine-tuning the transfer of resin text and bar codes.)</p>

## Selecting the Advanced Settings tab

Setting	Option
<b>Head Resistance</b>	<p>This is factory set. If the main board or the Printhead is replaced then adjust this number.</p> <p>Locate the Printhead Setting Number on the bottom of the Printhead.</p> <p>The number reads R=XXXX.</p>
<b>Head Home Offset</b>	<p>This is a calibration driven value and should not be adjusted. If the Printhead assembly is replaced then this value may need to be adjusted.</p> <p><b>(Note:</b> This is factory set and should not be changed unless directed by a technician.)</p>
<b>Head Contact Offset</b>	<p>This is a calibration driven value and should not be adjusted. If the Printhead assembly is replaced then this value may need to be adjusted.</p> <p><b>(Note:</b> This is factory set and should not be changed unless directed by a technician.)</p>
<b>Erase Heat Offset</b>	<p>Adjust the Erase temperature for the rewriteable cards as needed.</p> <ul style="list-style-type: none"> <li>• Increase the <b>Current Setting</b> to cause more heat to be used in the erasing process.</li> </ul> <p><b>OR</b></p> <ul style="list-style-type: none"> <li>• Decrease the <b>Current Setting</b> to cause less heat to be used in the erasing process.</li> </ul> <p><b>(Note: Erase Temp Offset</b> provides user ability to control the Printhead heat level when the Erase Operation is performed. Appropriate heat levels should be applied for the proper erase process. This setting should be adjusted for proper erasure.)</p>

**Selecting the Advanced Settings tab**

<b>Setting</b>	<b>Option</b>
<b>Write Heat Offset</b>	<p>Adjust the Write temperature for the rewriteable cards as needed.</p> <ul style="list-style-type: none"><li>• Increase the <b>Current Setting</b> to cause more heat to be used in the printing process of a rewritable card.</li></ul> <p><b>OR</b></p> <ul style="list-style-type: none"><li>• Decrease the <b>Current Setting</b> to cause less heat to be used in the printing process of a rewritable card.</li></ul> <p><b>(Note: Write Heat Offset</b> provides user ability to control the Printhead heat level when the Write Operation is performed. Appropriate heat levels should be applied for the proper writing process.)</p>

## Using the Device Options tab

Click on the Device Option tab to bring up the window (shown below).

• Click Detect Supplies at Print Time to verify that the Ribbon type selected matches the Ribbon installed in the Printer.

The Printer Driver will change the Ribbon type to the correct setting. The dialog indicates either the current setting has changed or the current Ribbon type is correct.

• Select this option to rotate the image on the card's front by 180 degrees (when printed).

• Select this option to rotate the image on the card's back by 180 degrees (when printed).

• Use this option to disable the printer's capabilities.

**DTC4500 Card Printer Printing Preferences**

Magnetic Encoding | Duplexing | Overlay / Print Area | K Panel Resin | Printer Info

Card | **Device Options** | Image Color | Image Calibrate

Supplies

Detect Supplies at Print Time

Ribbon Type:

YMCKO - Full Color/Resin Black/Overlay

Dual Sided

Print Both Sides

Split 1 Set of Ribbon Panels

Print Back Image on Front of Card

Print Back Side Only

Options

Rotate Front 180 Degrees

Rotate Back 180 Degrees

Disable Printing

Invert F-panel Image

Write Only

OK Cancel Apply Help

## Using the Device Options tab

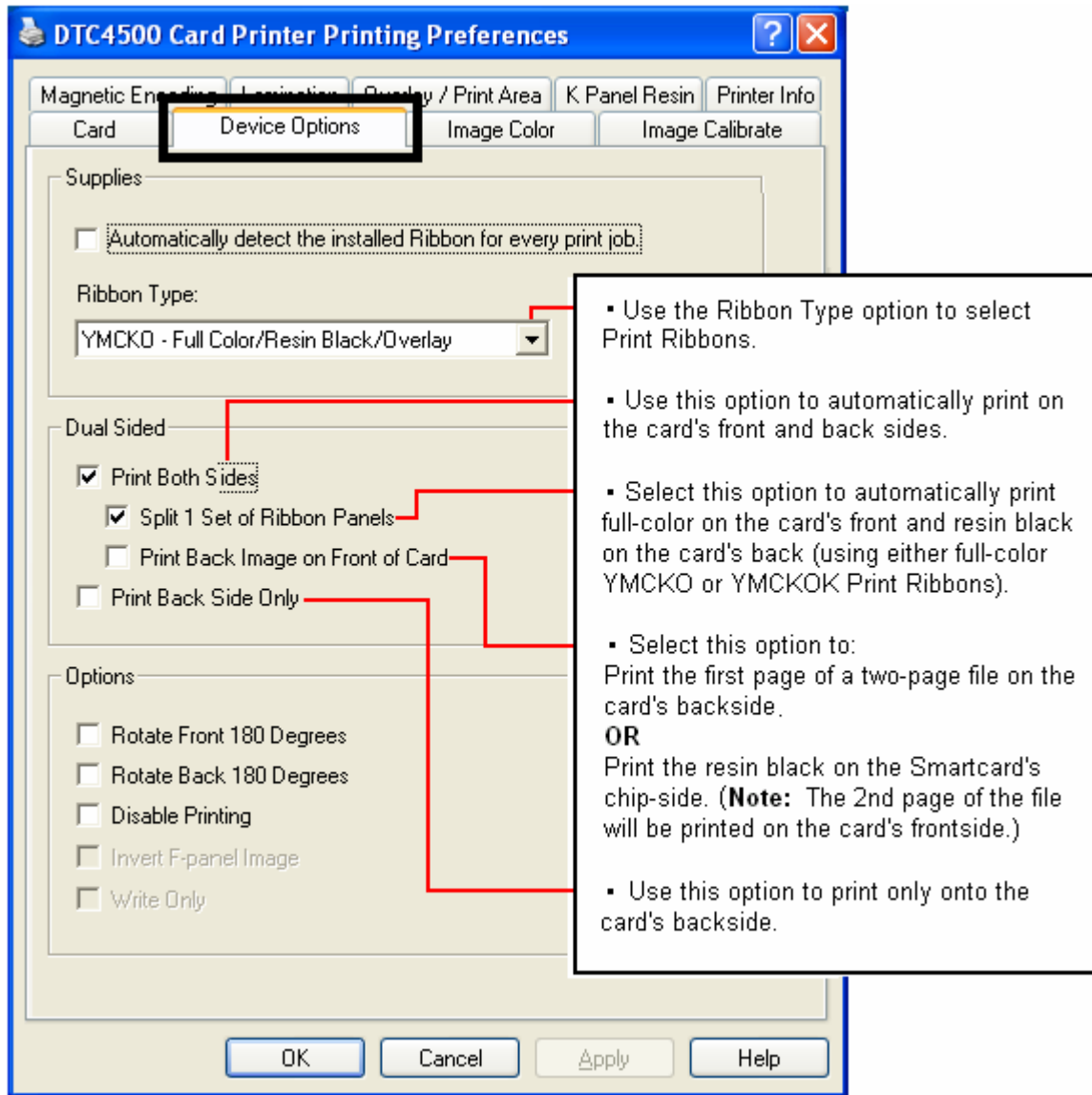

## Using the Device Options tab

You can use this option for the re-writeable cards. Select the **Write Only** option.

- The default setup is for the Printer to first erase the previously-printed card; then write the new information on the card.

- If you are printing to a new card, select **Write Only** to speed up the process. The full card is erased and printed. There is no option to select specific areas to erase.

- To print/erase a certain section, use the Overlay/Print Area tab in the Driver. Select the specific area in the same manner as the print job with the Color Ribbon.

- To erase many cards, use the **Fargo Workbench Re-Writable Card Eraser** option. This option does not print. It will only erase.

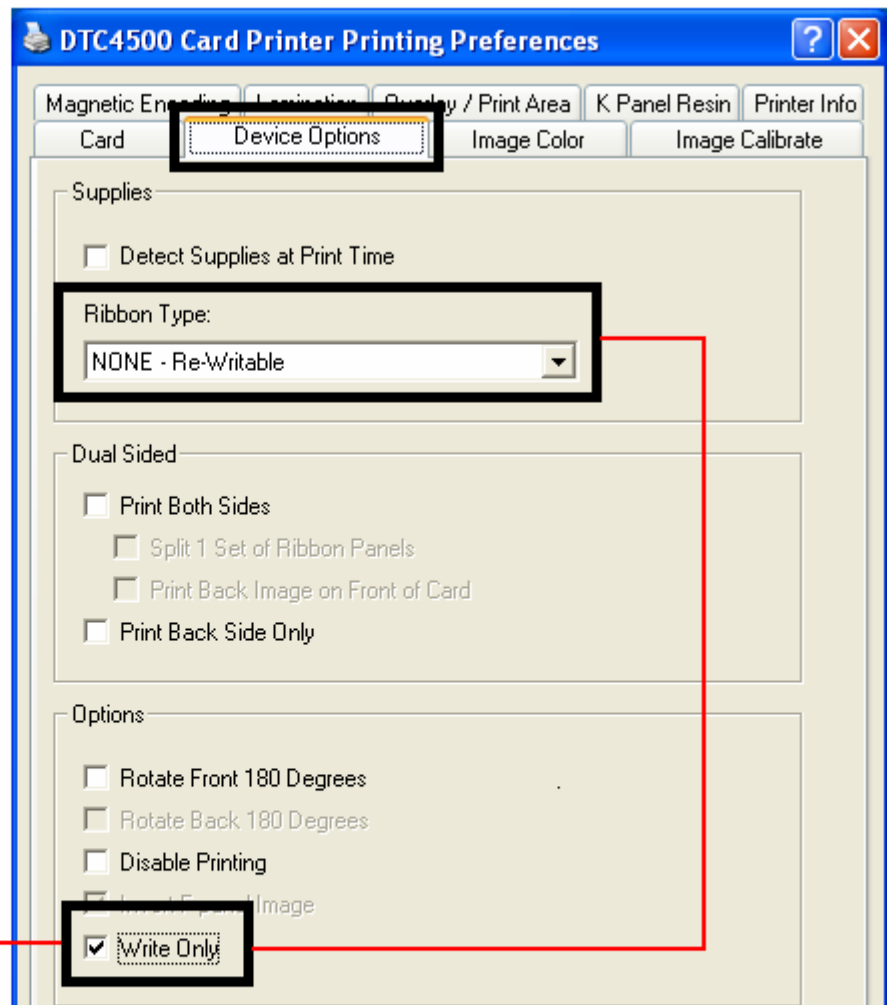

**Caution:** No Ribbon is used with these cards. Do not load a Ribbon into the Printer when using this process. Printing on the Re-Writable card with a Ribbon will ruin the card.

Refer to the procedure **Using the Workbench (to erase the card)** for more details. The Fargo Workbench Re-Writable Card Eraser has an option to erase many cards.



## Using the Image Color tab

Click on the Image Color option tab to bring up the window (shown below).

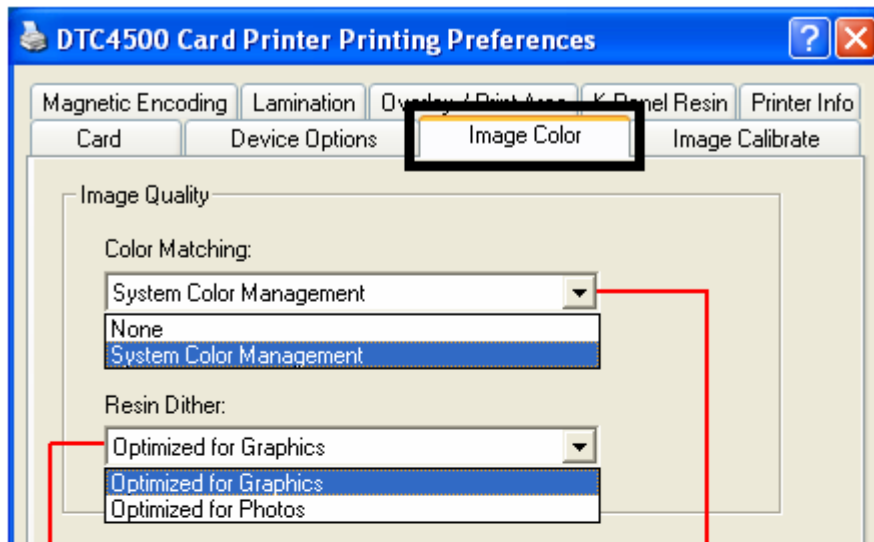

Select the appropriate dither method according to the type of image to be printed. This option affects objects printed with a resin-only Print. Select Optimized for Graphics when printing drawings and graphics (e.g., clipart, logos, etc.) with resin.  
**OR**  
Select Optimized for Photos when printing photo quality images with resin.

Use the Color Matching dropdown menu to choose the color matching options which best fits the print job requirements. Select None for print speed versus print color or for use of third party color matching software.  
**OR**  
Select System Color Management for Windows to make color corrections. This provides a closer match to the RGB color specifications.

## Using the Image Color tab

**Image Quality**

Color Matching:  
System Color Management

Resin Dither:  
Optimized for Graphics

**Heat**

Dye-Sub Intensity: (YMC) 0 %

Resin Heat, Front: (K) 0 %

Resin Heat, Back: (K) 0 %

Overlay Heat (O): 0 %

**Advanced Settings**

Control the overall darkness and lightness of the printed image by adjusting the Dye-Sub Intensity slider.

- Move the slide to the left to cause less heat to be used in the printing process and to generate a lighter print.

**OR**

- Move the slide to the right to cause more heat to be used, thus generating a darker print. This slide only affects images printed with dye-sublimation Ribbon panels (YMC).

Use this option to control the amount of heat the Printer uses when printing with the resin black panel(s) of a full-color Ribbon or when printing with a resin-only Ribbon by adjusting the Resin Heat slide.

- Move the slide to the left to (a) cause less heat to be used in the printing process and (b) cause resin images to be lighter or less saturated.

**OR**

- Move the slide to the right to (a) cause more heat to be used or (b) cause the resin image to be darker or more saturated.

Use this option to control the amount of heat the Printer uses when printing with the Overlay Ribbon Panel.

- Move the slide to the left to cause less heat to be used while printing.

**OR**

- Move the slide to the right to cause more heat to be used.

## Using the Image Color tab

You can use this option to control the image quality. The Sharpness, Contrast and Gamma settings are controlled here.

The color balance for yellow, magenta and cyan are adjusted with these settings.

Move the slide to the left to cause less of the particular option to be used in the printing process.  
**OR**  
Move the slide to the right to cause more of the particular option to be used.

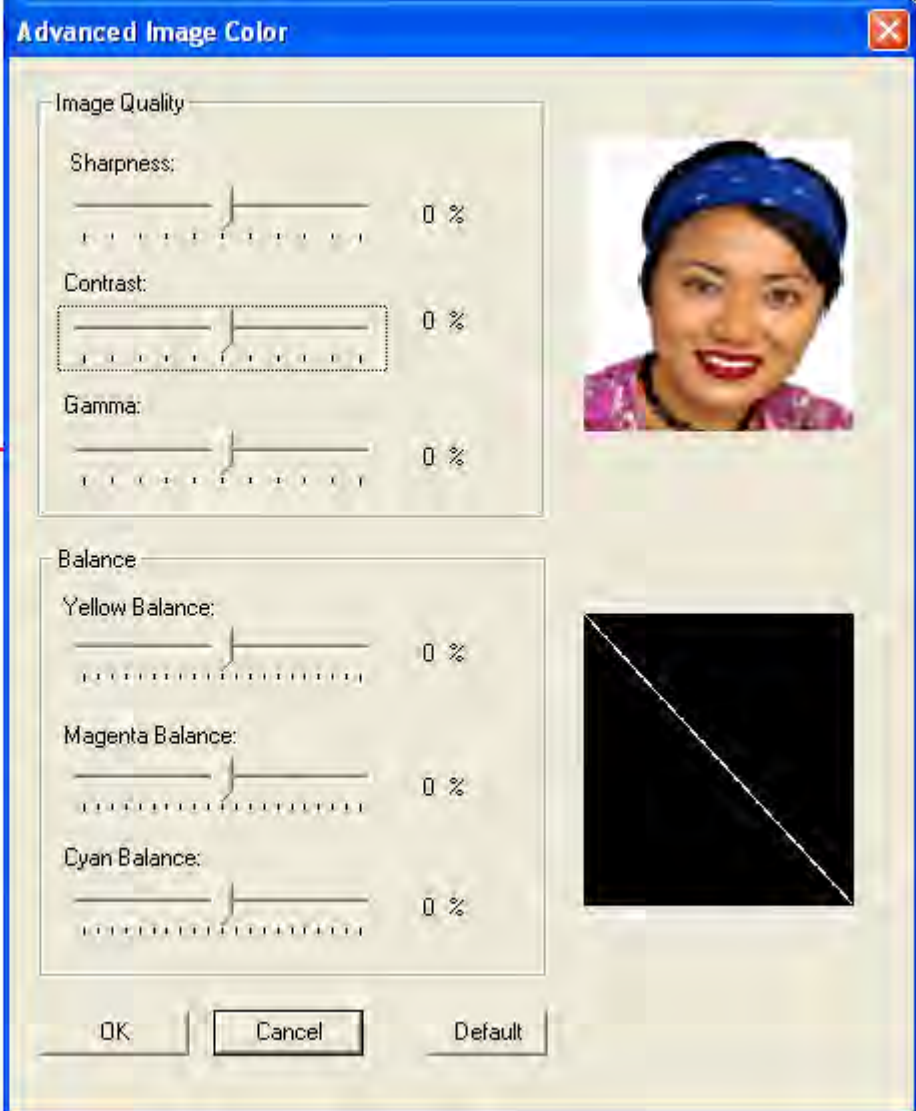

Advanced Image Color

Image Quality

Sharpness: 0 %

Contrast: 0 %

Gamma: 0 %

Balance

Yellow Balance: 0 %

Magenta Balance: 0 %

Cyan Balance: 0 %

OK Cancel Default

## Using the Image Calibrate tab

Use the Image Calibrate tab to control the position of the printable area in relation to the card.

Use the Image Position controls to adjust the position of the overall print area to be precisely centered on a card.

Use the Calibrate tab to (a) control the position of the printable area in relation to the card, (b) calibrate Sensors and (c) adjust the internal Printer settings that are customized for every Printer and saved directly within the Printer's memory.

Use the Vertical adjustment to move the image toward:

- The rear of the Printer if a positive number is entered.
- The front of the Printer if a negative number is entered.

Use the Horizontal adjustment to move the image toward:

- The card output side of the Printer if a positive number is entered.
- The card input side of the Printer if a negative number is entered.

The maximum value for the Vertical and Horizontal adjustments is  $\pm 100$  pixels (10 pixels = about .03"/.8mm).

The Vertical and Horizontal adjustment arrows point to within the Image Position window, which represents the direction that the printed image moves.

## Using the Magnetic Encoding Tab

Select the **Magnetic Encoding** tab to display options for controlling the Magnetic Stripe encoding process. You should use these options only if the Printer has an optional Magnetic Stripe Encoding Module installed.

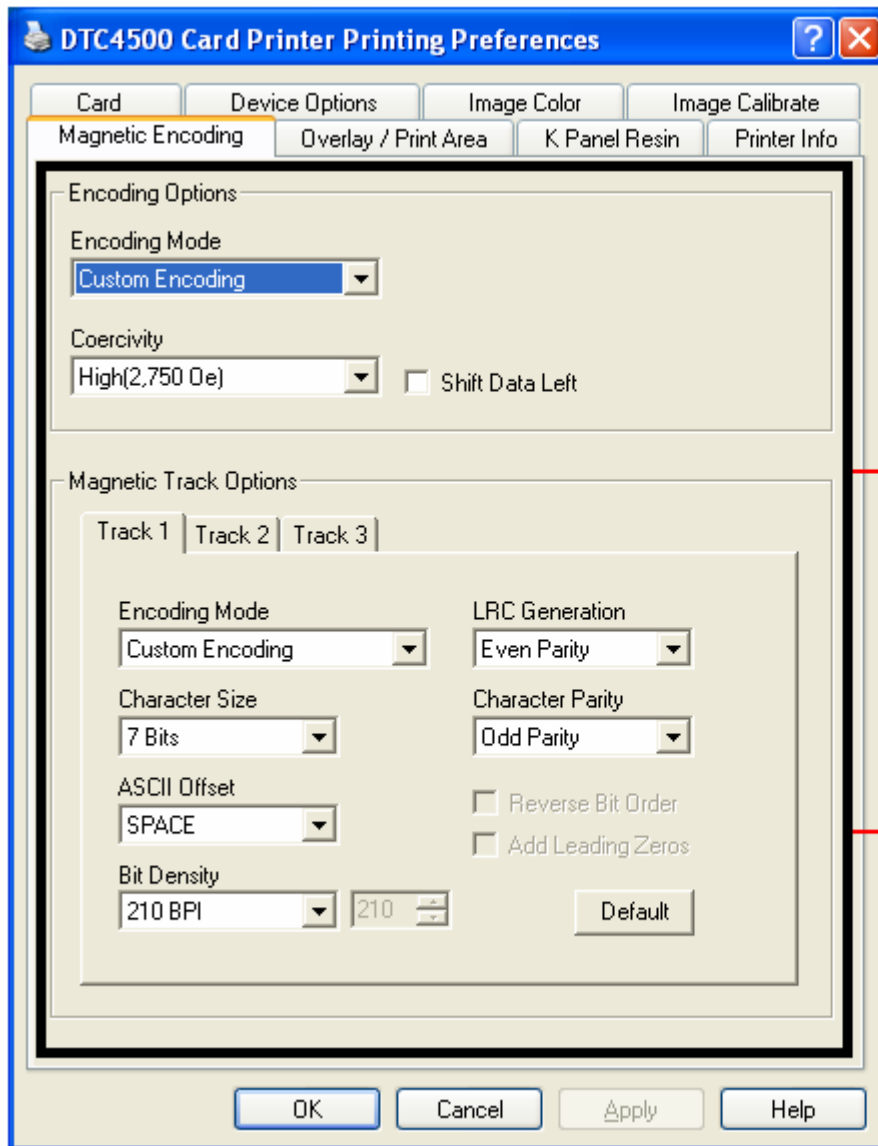

Please see the related tables and procedures below for more details on how to use the Magnetic Encoding tab window.



Use the Default button to reset defaults for the current Track tab only.

## Using the Magnetic Encoding Tab – ISO Standards

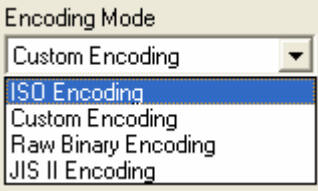
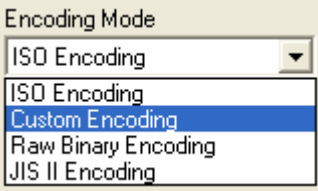
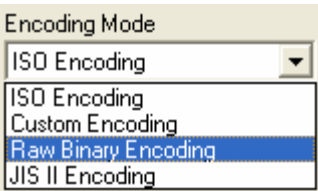
You can change the encoding mode and coercivity setting or modify the ISO standards for Tracks 1, 2 and 3. This can be done by correctly modifying these Magnetic Encoding options.

Window TAB	Procedure	Procedure (continued)
 <p>Encoding Mode Custom Encoding ISO Encoding Custom Encoding Raw Binary Encoding JIS II Encoding</p>	<p>If you select <b>ISO Encoding</b>, you send down a formatted set of characters.</p>	<p>This selection activates the track tabs. However, all functions on the Track tabs are inactive or gray and display ISO defaults, which are the defaults listed for each track below. The <b>Shift Data Left</b> check box remains unchecked and inactive.</p>
 <p>Encoding Mode ISO Encoding ISO Encoding Custom Encoding Raw Binary Encoding JIS II Encoding</p>	<p>If you select <b>Custom Encoding</b>, all options are active.</p>	<p>The <b>Default</b> is ISO Encoding. (<b>Note:</b> The defaults are the same as the ISO Encoding defaults.)  All functions on the Magnetic Track Options tabs are active.</p>
 <p>Encoding Mode ISO Encoding ISO Encoding Custom Encoding Raw Binary Encoding JIS II Encoding</p>	<p>If you select <b>Raw Binary Encoding</b>, you send down a raw binary string rather than a formatted set of characters.</p>	<p>The <b>Coercivity</b> dropdown function is active and the <b>Shift Data Left</b> checkbox is not active.  All functions on the Magnetic Track Options tabs are inactive except for <b>Bit Density</b>.</p>

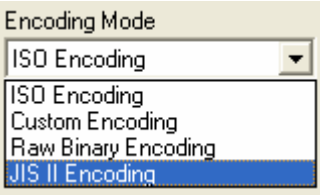
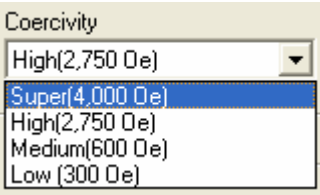
## Using the Magnetic Encoding Tab – ISO Standards

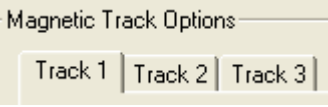
Window TAB	Procedure	Procedure (continued)
	<p>If you select <b>JIS II Encoding</b>, specific standards are used.</p>	<p>This selection disables all the Magnetic Track Options tabs. It also disables the Coercivity dropdown function and <b>Shift Data Left</b> checkbox option.</p> <p>The default Coercivity is 600 Oe.</p>
	<p>Select the <b>Coercivity</b> option (Oersted) to use the Magnetic Stripe type that matches the card type.</p>	<ul style="list-style-type: none"> <li>• High Coercivity to Super Coercivity = 2750-4000 Oersted</li> <li>• Fargo's High Coercivity UltraCard IIIs are 2750 Oe</li> <li>• Medium Coercivity=600 Oersted</li> <li>• Low Coercivity = 300 Oersted</li> </ul>
	<p>Select this option to shift the recorded magnetic data to the left-hand side of the card's Magnetic Stripe.</p>	<p>This is useful in situations that require cards to be readable with insert type readers.</p>
	<p>Select the <b>Magnetic Track Selection</b> option to specify which track is to be configured through the Magnetic Track Options.</p>	<p>This applies if the application being used <u>requires</u> customization of the standard ISO encoding process.</p>

## Using the Magnetic Encoding Tab – Custom Encoding or Raw Binary Encoding Mode

You can change the Magnetic Track options for Tracks 1, 2 and 3 when using the Custom Encoding or Raw Binary Encoding Mode. These options are not available for ISO or JIS II encoding.

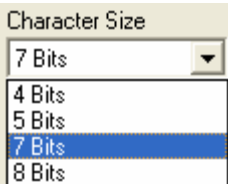
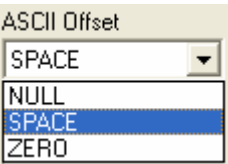
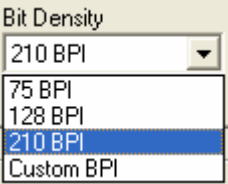
Window TAB	Procedure	Procedure (continued)
	<p>Select <b>4 Bits</b> to change the bits per character to 4 BPC. (<b>Note:</b> This is the default for Track 3).</p> <p>Select <b>5 Bits</b> to change the bits per character to 5 BPC. (<b>Note:</b> This is the default for Tracks 2 and 3).</p>	<p>Select <b>7 Bits</b> to change the bits per character to 7 BPC. (<b>Note:</b> This is the default for Track 1).</p> <p>Select <b>8 Bits</b> to change the bits per character to 8 BPC.</p>
	<p>Select <b>NULL</b> to change the ASCII Offset to NULL.</p> <p>Select <b>SPACE</b> to change the ASCII Offset to SPACE. (<b>Note:</b> This is the default for Track 1.)</p>	<p>Select <b>ZERO</b> to change the ASCII Offset to ZERO. (<b>Note:</b> This is the default for Tracks 2 and 3.)</p>
	<p>Select <b>75 BPI</b> to change the bits per inch to 75 BPI. (<b>Note:</b> This is the default for Track 2.)</p> <p>Select <b>128 BPI</b> to change the bits per inch to 128 BPI.</p>	<p>Select <b>210 BPI</b> to change the bits per inch to 210 BPI. (<b>Note:</b> This is the default for Tracks 1 and 3.)</p> <p>Select <b>Custom BPI</b>, which enables the custom BPI text box. (<b>Note:</b> The lower limit is 75 and upper limit is 210.)</p>

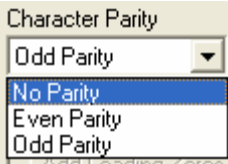

## Using the Magnetic Encoding Tab – Custom Encoding or Raw Binary Encoding Mode

Window TAB	Procedure	Procedure (continued)
	<p>Select <b>No LRC</b> to change the LRC Generation to none.</p> <p>Select <b>Even Parity</b> to change the LRC Generation to Even Parity. (<b>Note:</b> This is the default for all tracks.)</p>	<p>Select <b>Odd Parity</b> to change the LRC Generation to Odd Parity.</p>
	<p>Select <b>No Parity</b> to change the Character Parity to none.</p> <p>Select <b>Even Parity</b> to change the Character Parity to Even Parity.</p>	<p>Select <b>Odd Parity</b> to change the Character Parity to Odd Parity. (<b>Note:</b> This is the default for all tracks.)</p>
<input type="checkbox"/> Reverse Bit Order <input type="checkbox"/> Add Leading Zeros	<p><b>Reverse Bit Order</b> is used to reverse the character bits and is used for the encryption of data in specific programs</p>	<p><b>Add Leading Zeros</b> is used to add a set number of leading zeros to the magnetic string in order to move the starting point of the encoded data in specific programs for encryption of data.</p>

## Reviewing the ISO Track Locations

The magnetic Encoding Module encodes onto tracks in accordance with an ISO 7811-2 Magnetic Stripe. For track locations, review the display below.

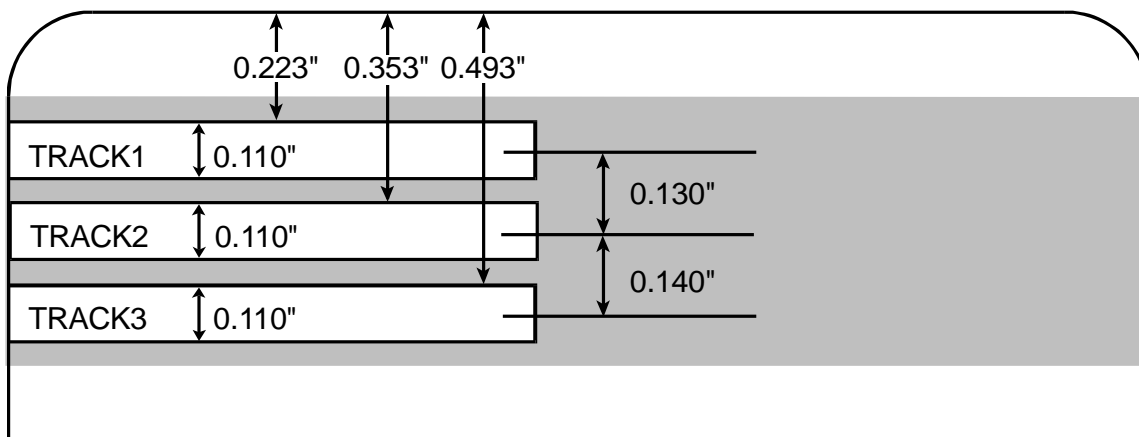

## Reviewing the Sample String

- Track 1: ~1%JULIEANDERSON^1234567890?
- Track 2: ~2;1234567890987654321?
- Track 3: ~3;1234567890987654321?

Track	Start Sentinel	End Sentinel	Field Separator	Valid Characters	Maximum Number of Characters
Track 1	%	?	^	ASCII 32-95 (See the table below.)	78
Track 2	;	?	=	ASCII 48-63 (See the table below.)	39
Track 3	;	?	=	ASCII 48-63 (See the table below.)	106

## Sending the Track Information

Magnetic track data is sent in the form of text strings from the application software to the Printer Driver.

- In order for the Printer Driver to differentiate between Magnetic Track data and the rest of the printable objects, specific characters must be added to the magnetic data to be encoded.
- These specify the data that is to be encoded, the tracks to encode and mark the start and stop of the data string. In some cases, these specific characters are automatically added to the string of track data by ID software applications.
- In most cases, the user must carefully add these characters to the string of Magnetic Track data. If these characters are not added to the track data, the text intended for the Magnetic Track will appear as printed text on the card. To avoid this, track information must be entered as described below.

Step	Procedure
1	<p>When entering track data, the ~ (tilde) character is entered first, followed by the track number (1, 2 or 3) on which the data should encode. This is followed by the data to be encoded.</p> <ul style="list-style-type: none"> <li>• The first character of this data string must be the track's specific Start Sentinel (SS) and the last character must be the specific End Sentinel (ES).</li> <li>• The characters or data in between the SS and ES can include all of the valid characters specific to each track.</li> <li>• The number of these characters, however, is limited by each track's maximum character capacity.</li> <li>• When segmenting track data, the appropriate Field Separator (FS) must be used. The table below shows the SS, ES, FS and the valid characters defined for each track.</li> </ul>

## Reviewing the ASCII Code and Character Table

ASCII Code	Character	ASCII Code	Character	ASCII Code	Character
32	space	56	8	80	P
33	!	57	9	81	Q
34		58	:	82	R
35	#	59	;	83	S
36	\$	60	<	84	T
37	%	61	=	85	U
38	and	62	>	86	V
39	'	63	?	87	W
40	(	64	@	88	X
41	)	65	A	89	Y
42	*	66	B	90	Z
43	+	67	C	91	[
44	'	68	D	92	\
45	-	69	E	93	]

## Reviewing the ASCII Code and Character Table

ASCII Code	Character	ASCII Code	Character	ASCII Code	Character
46	.	70	F	94	^
47	/	71	G	95	_
48	0	72	H		
49	1	73	I		
50	2	74	J		
51	3	75	K		
52	4	76	L		
53	5	77	M		
54	6	78	N		
55	7	79	O		

## Using the Lamination tab

Use the Image Calibrate tab to control the position of the printable area in relation to the card.

**Adjust the Transfer Dwell Time to control the Lamination Dwell Time or through-put speed of a card in seconds per inch and with the Lamination Temperature.**

- Default = 2.0 seconds per inch
- Upper Limit = 5.5 seconds per inch
- Lower Limit = 0.8 seconds per inch

**Use the Lamination Position control to adjust the horizontal position of the PolyGuard Overlaminare.**

- To adjust the Lamination position, click on the Horizontal adjustment arrows.
- To move the overlaminare more toward the card output side of the Printer, enter a positive number
- To move the overlaminare more toward the card input side of the Printer, enter a negative number.

The adjustment arrows point in the direction the patch will move on the card. The maximum value for the Horizontal adjustment is  $\pm 100$  Pixels (10 Pixels = about .03/.8mm). The default is 0.

## Using the Overlay / Print Area tab

This option is helpful if, for example, you would like to omit the printing or block out the overlay for a signature or printing around a card's smart chip or Magnetic Stripe. Refer to [Using the Defined Area Option](#) for a specific procedure that relates to this tab.

Use this tab to control and customize where the Overlay (O) Panel and/or the print area appear on a card. By default, this option is set to print and overlay the entire card.

Select **For Print and Overlay** for the defined area to apply to both the printing and overlay process.  
**OR**  
Select **For Overlay Only** for the defined area to apply only to the overlay process. In this mode, printing will still be allowed over the entire card and only the overlay will be affected.  
**OR**  
Select **For Print Only (No Overlay)** for the defined area to apply only to the print process. In this mode, the overlay is completely disabled so it will not be applied.

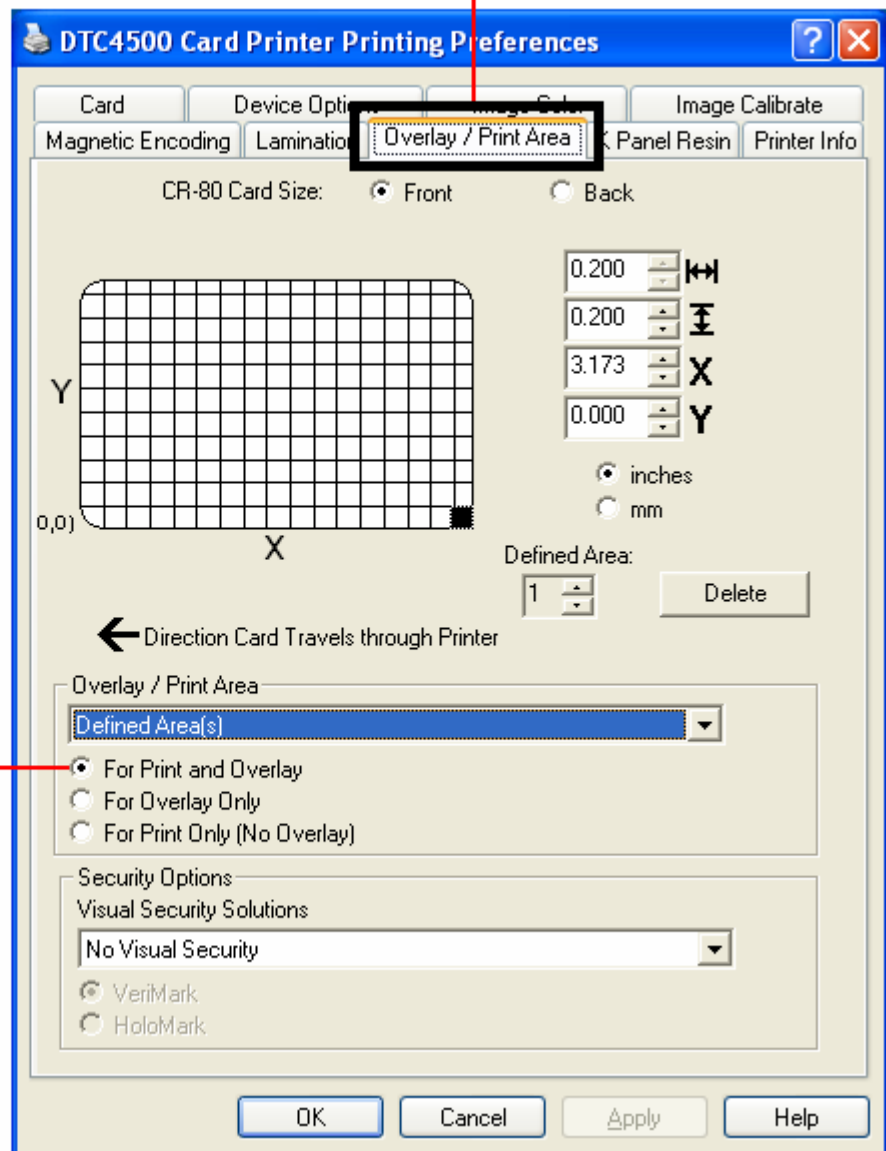

## Using the Overlay / Print Area tab

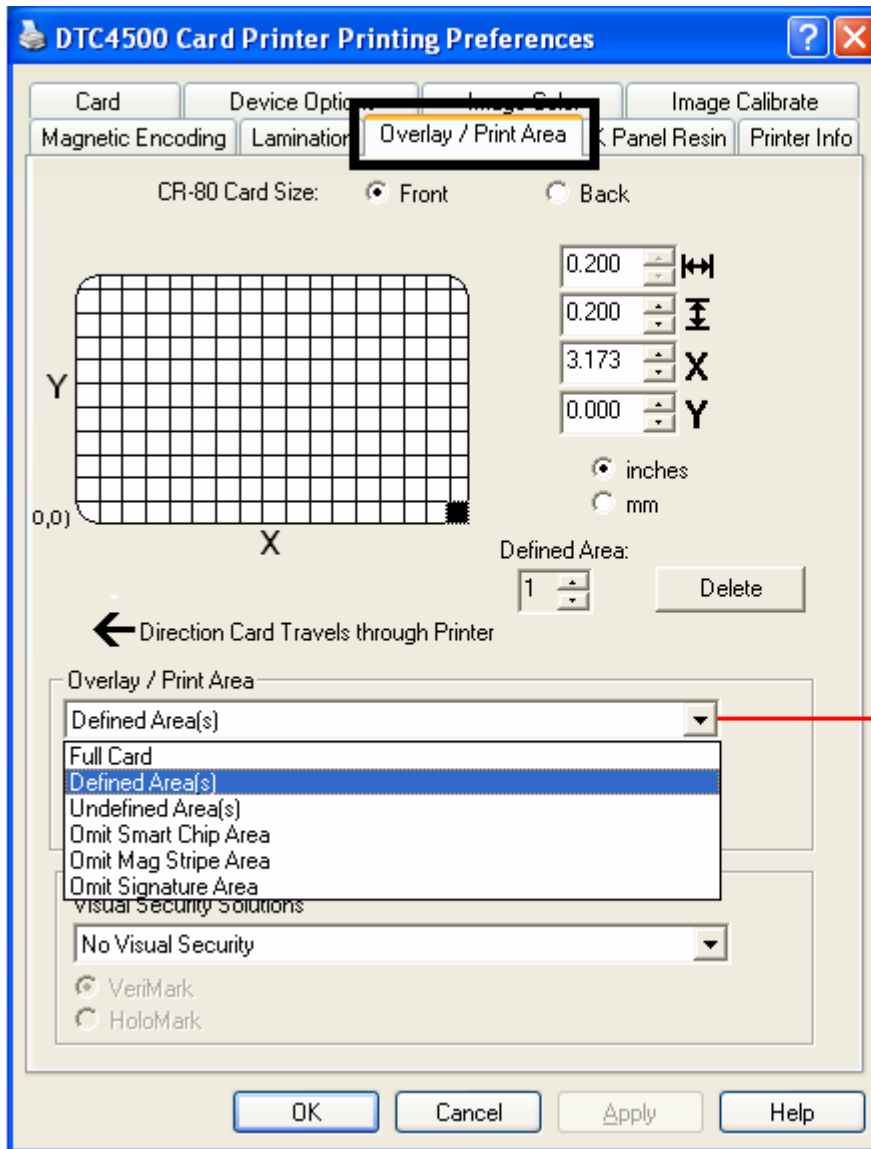

Select **Full Card** for the Printer to overlay and/or print the entire card.

**OR**  
Select **Defined Area(s)** for the Printer to overlay and/or print only in the selected and defined area or areas.

**OR**  
Select **Undefined Area(s)** for the Printer to overlay and/or print only in the space outside the selected and defined area.

**OR**  
Select **Omit Smart Chip Area** for the Printer to overlay and/or print only in the space outside the standard location of a smart chip.

**OR**  
Select **Omit Magnetic Stripe Area** for the Printer to overlay and/or print only in the space outside the standard location of an ISO Magnetic Stripe.

**OR**  
Select **Omit Signature Area** for the Printer to overlay and/or print only in the space outside the standard location of a signature panel.



## Using the Overlay / Print Area tab

The Visual Security Solutions dropdown menu list is used to enable and select which type of visual security will be used.

The Visual Security dropdown list is selectable only on the Front side. Visual Security is not an option for the back side.

These actions occur when one of the Visual Security locations is selected.

- The Overlay / Print Area will be disabled.
- The Security Options become selectable.

Select **Landscape** under **Orientation** on the Card tab to use the Visual Security Solutions (A to D).

Select **Portrait** under **Orientation** on the Card tab to use the Visual Security Solutions (E to H).

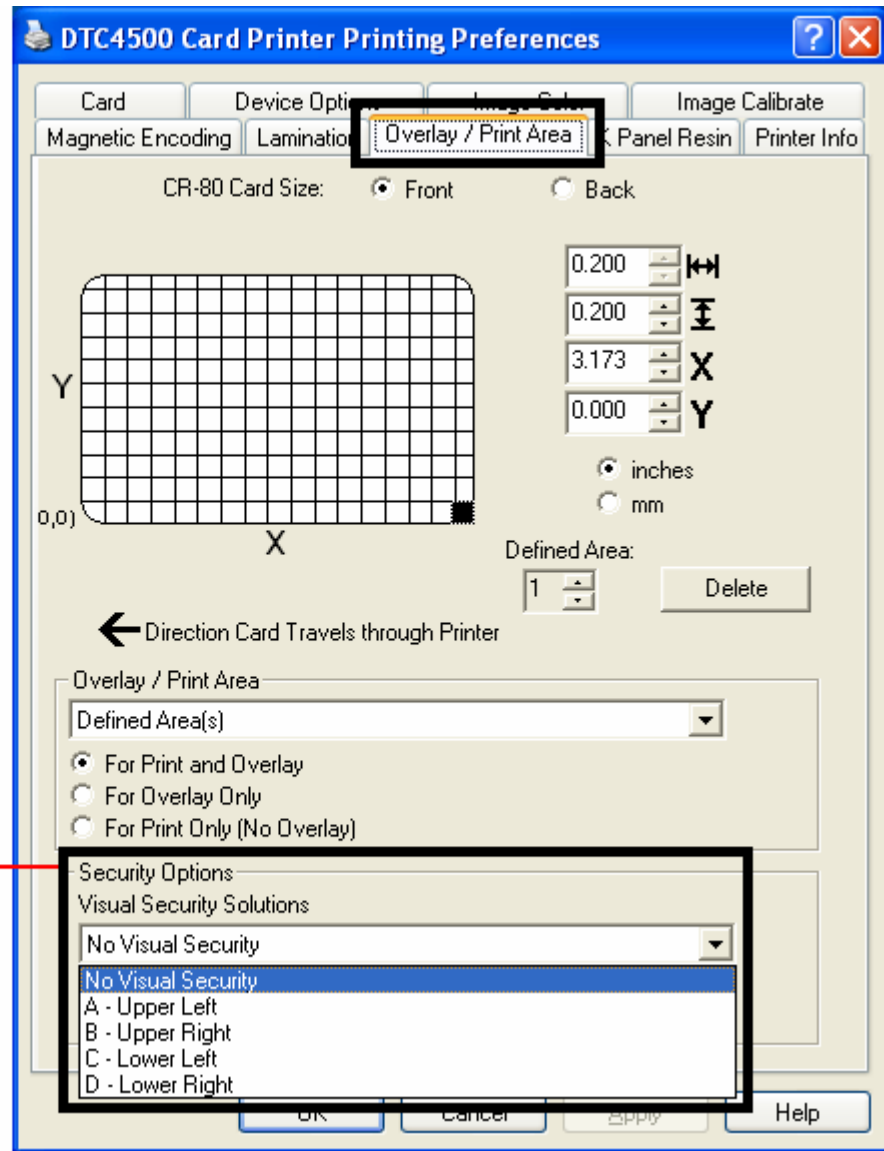

## Using the K Panel Resin tab

Use this tab to control where the resin black (K) Panel of a full-color Ribbon is printed. Refer to [Using the Defined Area Option](#) for a specific procedure that relates to this tab.

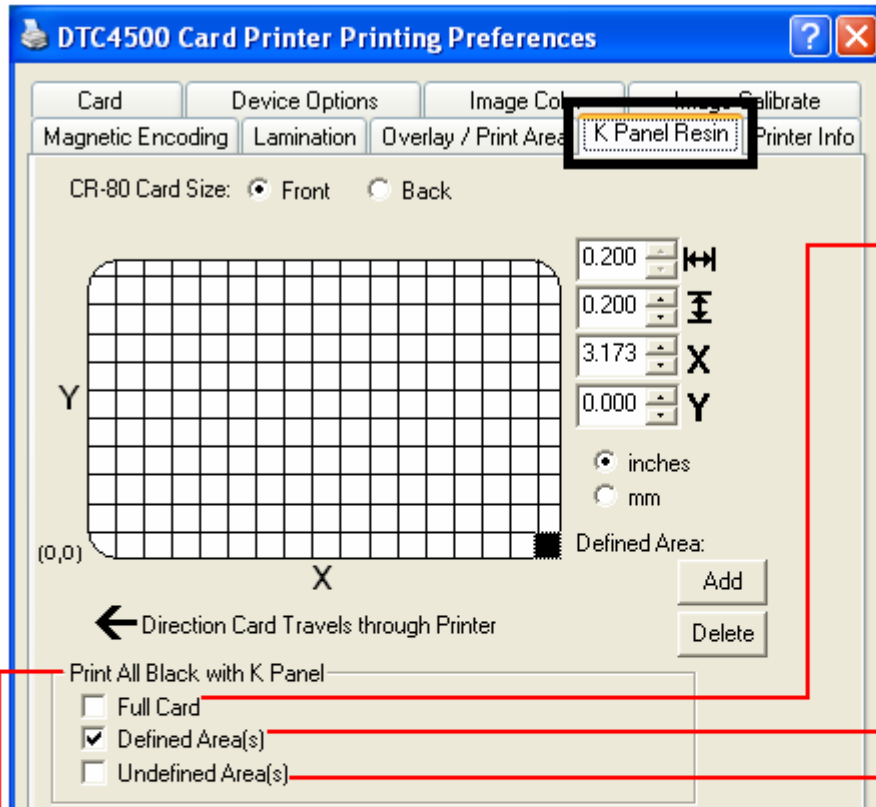

Select **Full Card** for the Printer Driver to print the resin black (K) panel for all black found within all areas of the image.

Select **Defined Area(s)** for the Printer Driver to print the resin black (K) panel for all black found only in a desired and defined area or areas.

Select **Undefined Area(s)** for the Printer Driver to print the resin black (K) panel for all black found only in the space outside the defined areas. In the card grid, black indicates the area in which the resin black (K) panel will be printed.

<p>Select one of the three options listed under Print All Black with K Panel if the black text or bar codes are not TrueType fonts and/or are not printing with the resin black panel.</p>	<p>When these options are not selected, the Printer Driver will automatically print all TrueType black text and bar codes only with the Resin Black (K) Panel of the Print Ribbon.</p>
--	--

## Using the K Panel Resin tab

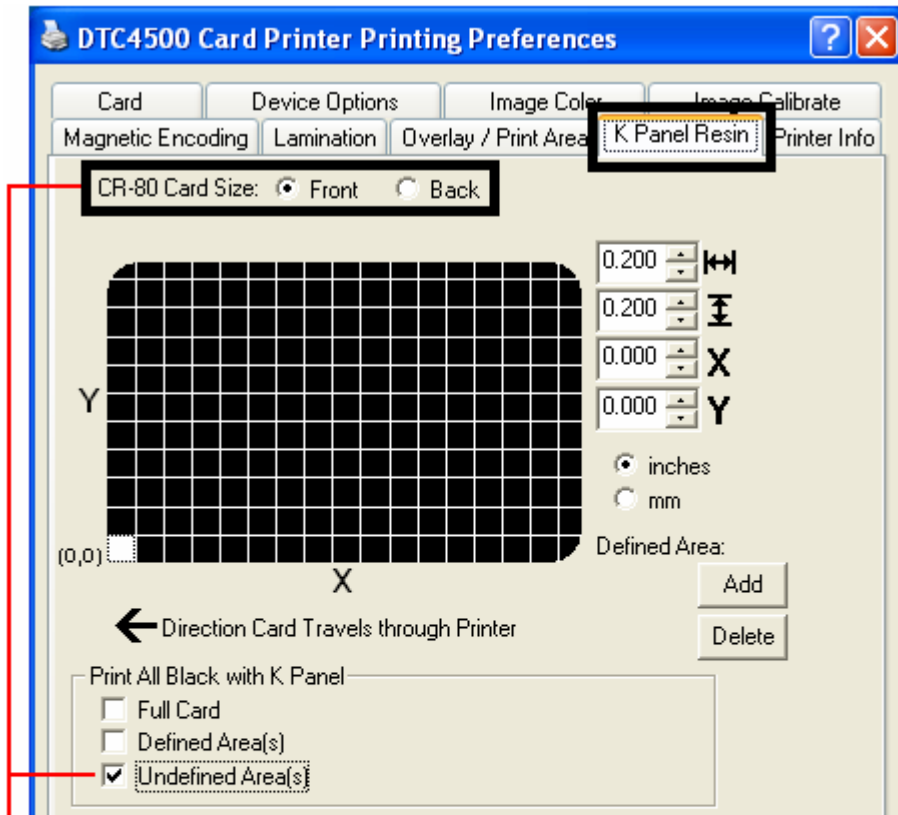

Select **Undefined Area(s)** for the Printer Driver to print the resin black (K) panel for all black found only in the space outside the defined areas.

In the card grid, black indicates the area in which the resin black (K) panel will be printed.

## Using the K Panel Resin tab

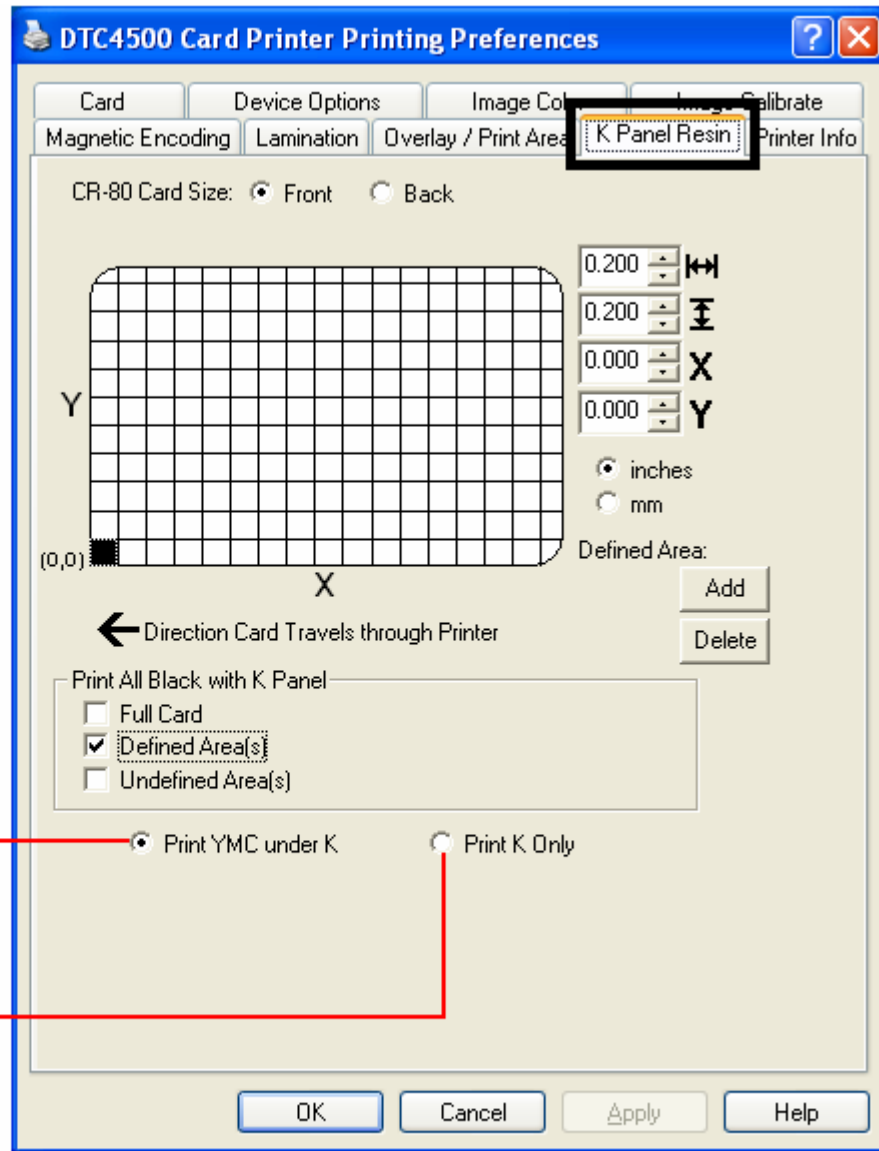

Select the **Print YMC under K** option to print all black in the designated areas with the Yellow (Y), Magenta (M) and Cyan (C) Ribbon panels directly beneath the resin black (K) panel and provide a gradual transition between the resin black text or bar codes.

Select **Print K Only** if printing resin black onto a white background to maximize the sharpness of printed text and bar codes and print all black in the designated areas with the resin black (K) panel.

## Using the Printer Info tab

Use the options on this tab to view information about the Ribbon, Laminate, Card Count, Printer Serial #, Firmware version, and Reorder Media #'s installed in the Printer.

The screenshot shows the 'DTC4500 Card Printer Printing Preferences' dialog box with the 'Printer Info' tab selected. The dialog is divided into several sections:

- Ribbon:** Type: YMCKK - Full Color/2 Resin Black, Reorder #: 84052. Includes a gauge indicator from Empty to Full.
- Lamination - Cartridge 1:** Type: 1.0 PolyGuard Lamination, Reorder #: 82601. Includes a gauge indicator from Empty to Full.
- Lamination - Cartridge 2:** Type: 1.0 PolyGuard Lamination, Reorder #: 82601. Includes a gauge indicator from Empty to Full.
- Printer:** Card Count: 691, Serial #: A7440840, Version: 4.0.5.3.

Callout boxes on the right provide additional information:

- Here are guidelines for automatic positioning on the Printer Info tab.
- Ribbon Level: Type, Reorder Number, and Gauge Indicator.
- Lamination - Cartridge 1 Level: Type, Reorder Number and Gauge Indicator. Visible only when this cartridge is detected.
- Lamination - Cartridge 2 Level: Type, Reorder Number, and Gauge Indicator. Visible only when this cartridge is detected.
- Printer - Card Count, Serial Number, and Version Number are provided here.

## Section 5: Selecting the Fluorescent Panel Ribbon Type

The YMCFKO/YMCFKOK Ribbon is an economical way to add a fully customizable, incremental level of security to your photo identification cards.

- **Process:** This process allows you to configure the data that is printed with the fluorescent panel of an YMCFKO/YMCFKOK Ribbon. (**Note:** Any software program may be used to print the special florescent panel of the Ribbon to a card once the Driver and Workbench are set up correctly.)
- **Ribbons:** These Ribbons contain a yellow (**Y**), magenta (**M**), cyan (**C**), and resin black (**K**) panels to create a full color over-the-edge printing identification card. In addition, the Ribbon contains a dye-based fluorescing panel (**F**) which will allow you to print a standard or one-to-one personalized grayscale fluorescing image that is completely invisible until exposed to ultraviolet light.

### Creating a Custom Fluorescent Image (using the YMCFKO Ribbon)

There are three (3) methods used to accomplish the creation of a custom fluorescent image when using the YMCFKO Ribbon.

- **First Method:** The first method uses the Fargo Workbench Printer Utility to create a static image that will be applied automatically to each card sent to the Printer. Refer to the **Help file** for the **Fargo Workbench Utility Program and User Guide** or to **Appendix A for Configuring Fluorescent Data (F-Panel for YMCFKO Ribbon)** using the Workbench.
- **Second Method:** The second method (described below) allows the creation of the fluorescent panel image directly from the badge application software. (**Note:** You can now print a unique fluorescent image, such as the card holder's picture on each card.)
- **Third Method:** The third method is described in the **Asure ID 2009 Software User Guide**. See the procedure relating to the Fluorescent Panel Ribbon. For more information about Asure ID 2009, please visit our website at <http://www.hidglobal.com/cardIssuance/idSoftware.php>

### Creating a Custom Fluorescent Image (using the YMCFKO Ribbon)

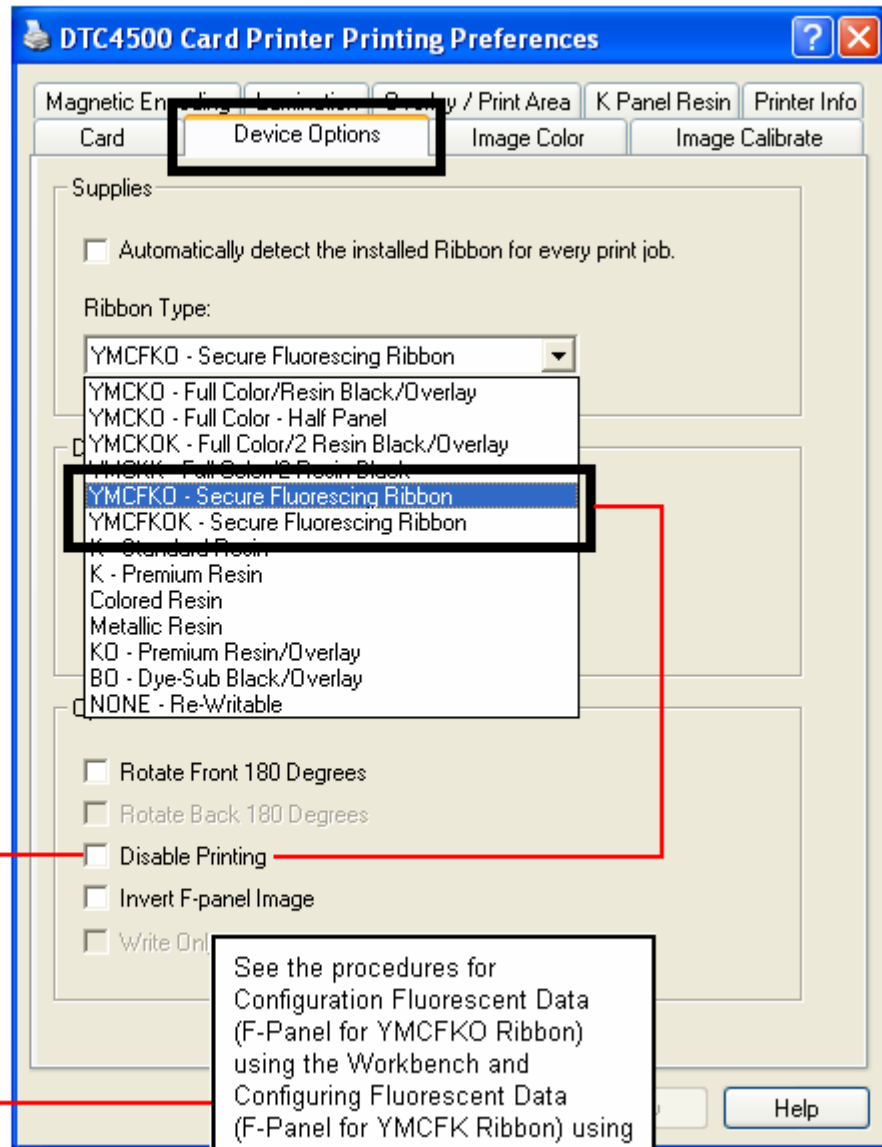

Check Invert F-Panel Image to create a negative of the fluorescent image. See below.

- Refers to the ability to cause light or white areas of the image to fluoresce and for dark colors to remain dark on the printed card when exposed to a UV light.
- This was requested because the fluorescent dye color is bright when black light is applied to it.

By default, the dark areas of the image will fluoresce on the card, and the lighter or white areas will have no dye applied.

See the procedures for Configuration Fluorescent Data (F-Panel for YMCFKO Ribbon) using the Workbench and Configuring Fluorescent Data (F-Panel for YMCFK Ribbon) using the Application for more details.

## Configuring Fluorescent Data (F-Panel for YMCFKO Ribbon) using the Application

This process creates a fluorescent image on your card using a simple text string command in your badge application.

Step	Procedure
1	<b>Creating Fluorescent Text:</b> Create a new text box in your badge application.
2	<p>Type the <b>TEXT</b> that you want to appear as fluorescent and put a <b>~T</b> before the start of the text with no space after the <b>~T</b>. The text will start on the card where the <b>~T</b> begins. (see Display A below)</p> <div data-bbox="272 741 659 1371" style="border: 1px solid black; padding: 10px;"> <p>~Ic:\globe.bmp</p> <p>Valid until MAY 2006</p> <p>Christian Sander Technical Advisor</p> <p>A-567-234-21223-C98-R5</p> <p>~TSC06893B</p> <p>S C 0 6 8 9 3 B</p> </div>



## Configuring Fluorescent Data (F-Panel for YMCFKO Ribbon) using the Application

Step	Procedure
3	<p><b>Creating a Fluorescent Image:</b> In a separate drawing program, create the image that you wish to fluoresce. (See Display C below.)</p> 
4	<p>Create the <b>IMAGE</b> in the actual size that you want it to appear on the card, and save it as a Grayscale or 1 - bit bmp file on the root c:\ directory.</p> <ul style="list-style-type: none"> <li>Do not put spaces in the file name.</li> </ul>
5	<p>Create a new text box in your badge application, and type ~I followed by the address of your image (see Display A below). The top left of your image will start at the top left of your text box.</p>

## Configuring Fluorescent Data (F-Panel for YMCFKO Ribbon) using the Application

Step	Procedure
6	Set up the Printer Driver preferences. Refer to Step 8-10 below.
7	<p>Printer will print the fluorescent BMP IMAGE at the ~I position on the card. Printer will print the fluorescent TEXT at the ~T position on the card. (See Display B below)</p> <p><b>BMP Image located at c:\globe.bmp</b></p> 
8	Set the Ribbon for YMCFKO in the Printing Preferences. ( <b>Note:</b> The <b>Detect Supplies at Print Time</b> button may also be used.)
9	<p>Check <b>Dual Pass</b> if you would like to print the F-Panel on a separate panel of HDP film from the YMC image.</p> <p>You should use:</p> <p>The default <b>Dual Pass</b> option if the fluorescent image is used in places where other dye is used.</p> <p><b>OR</b></p> <p>Any time the Invert F-Panel Image option is selected.</p>

## Configuring Fluorescent Data (F-Panel for YMCFKO Ribbon) using the Application

Step	Procedure
10	<p>Check <b>Invert F-Panel Image</b> to create a negative of the fluorescent image. See below.</p> <ul style="list-style-type: none"><li>• This refers to the ability to cause light or white areas of the image to fluoresce and dark colors to remain dark on the printed card when exposed to a UV light.</li><li>• This was requested because the fluorescent dye color is bright when black light is applied to it.</li></ul> <p>By default, the dark areas of the image will fluoresce on the card and the lighter or white areas will have no dye applied. (<b>Note:</b> This may improve the look of the person's image if used for the Logo.)</p> <div data-bbox="277 793 1027 1104"><p>Options</p><ul style="list-style-type: none"><li><input type="checkbox"/> Rotate Front 180 Degrees</li><li><input type="checkbox"/> Rotate Back 180 Degrees</li><li><input type="checkbox"/> Disable Printing</li><li><input checked="" type="checkbox"/> Invert F-panel Image</li><li><input type="checkbox"/> Write Only</li></ul></div>

## Section 6: System Overview- Troubleshooting

### Reviewing the DTC4500 Sequence of Operations

Knowing the sequence of the Printer operation will help troubleshoot the printer.

Step	Process
1	The File information is received from PC.
2	Printer checks the installed Ribbon type stored in memory against the Ribbon type command that was sent from the Printer. If Ribbon type does not match, the <b>Pause</b> button on the right will begin flashing.
3	The Print Stepper Motor engage.
4	The Card Feed Sensor detects leading edge of card, the Headlift Stepper then engages to disengage the input lever.
5	The card feeds through for the alignment pass.
6	The Card Feed Stepper Motor engages to queue card for magnetic encoding (if applicable).
7	The Encoding data is written to the card (if applicable).
8	The Magnetic Encoder verifies while the Stepper reverses the card (if applicable).
9	The Print Ribbon Drive engages (if not already at the yellow Panel).
10	The Print Ribbon Sensor looks for the Yellow Panel. ( <b>Note:</b> The Print Ribbon Encoder detects number of revolutions, required to use an entire color Panel.)
11	The Print Stepper Motor engages.
12	The Card Feed Sensor detects the leading edge of card.

## Reviewing the DTC4500 Sequence of Operations

Step	Process
13	The Print Stepper Motor queues card to the middle of the platen Roller. All Stop.
14	The Print Headlift Motor engages to the print position.
15	The Print Cover Sensor checks for closed state.
16	The Print Stepper Motor engages.
17	The Ribbon Drive Motor engages.
18	The Image data is burned by the Printhead until the image data is depleted. All Stop.
19	The Thermistor engages the Printhead Cooling Fan to maintain proper operating temperature.
20	The Headlift Motor engages to the queue position.
21	The Print Stepper Motor engages.
22	The Print Ribbon Drive engages.
23	After Ribbon advances a few Encoder clicks, assume the Ribbon is free of card. All stop.
24	Repeat Steps 9 through 22 for the appropriate number of color/overlay Panels.
25	Either the Card is ejected from the singled-sided Printer or the Card Feed Stepper engages to queue the card for the Flipper Table for the dual-sided Printer.
26	All Stop.

## Section 7: Troubleshooting

### Printer Error Button and Display Message Table

Both the DTC4500 use the Button messages rather than the Display Message system.

Step	Procedure
1	<p>All Printers have two (2) buttons, one for <b>ON/Off (LEFT)</b> and one for <b>Pause (II) (RIGHT)</b>.</p> 
2	<p>The <b>ON/Off</b> button is blue when the Printer is <b>ON</b>. When the Printer enters the Sleep Mode, the LED is dimmed but still <b>ON</b>.</p>
3	<p>The <b>Pause (II)</b> button will be illuminated blue when the Printer is capable of accepting a printjob and does not have an error.</p> <ul style="list-style-type: none"> <li>• This LED will continue to stay on while the Printer prints as long as there is no error.</li> <li>• This LED will also be dimmed when the Printer goes into sleep mode.</li> </ul>
4	<p>When an error occurs, the <b>Pause</b> button will no longer be illuminated blue, but will blink red.</p>

## Printer Error Button and Display Message Table

Both the DTC4500 use the Button messages rather than the Display Message system.

Step	Procedure
5	Press the <b>ON/Off</b> button when Printer is in an error state to cause the action to be cancelled. ( <b>Note:</b> If no other error occurs, then the <b>Pause</b> button will illuminate its blue LED.)
6	Press the <b>Pause</b> button when Printer is in an error state to cause the Printer to retry. ( <b>Note:</b> It will illuminate its blue LED and retry the failed action.)
7	When downloading an upgrade file, both blue LED's will blink. If the unit is a DTC1000: <ul style="list-style-type: none"> <li>• You have been advised that the upgrade is in process.</li> </ul>
8	If a language (other than English) is currently selected: <ul style="list-style-type: none"> <li>• You can press and hold the <b>Pause</b> button during the power-up sequence to change the language back to English.</li> </ul>
9	When no LCD Display is available, press or hold the buttons to access certain Internal Test jobs. See below. <ul style="list-style-type: none"> <li>• To print a card with the Printer Settings, press the <b>Pause</b> button and hold for 4+ seconds when the Printer is ready and idle.</li> <li>• To print the alignment or the Self Test, press the <b>ON/OFF</b> button then immediately press the <b>Pause</b> button.</li> </ul>

## Using the Error Message Table

This section provides the troubleshooting table for the error message. The DTC4500 has a display that will show the Printer error messages.

- When an error occurs in the Printer, the PC will show the error message on screen with solutions.
- The display will blink in the location needing attention. Those locations include the Printer, Input Hopper, Magnetic Encoder, Flipper, Card Path, Ribbon, and Data/Communication error device.

Each table uses a 3- column presentation to present a specific or Printer error message, its cause and its solution.

- This allows the troubleshooter to identify the error and its cause, and then perform the procedure (provided in the solution column).
- This standard mode of identifying the problem and its solution should provide an efficient method of troubleshooting this Printer.
- If you encounter problems beyond the capabilities of these the error message table, you should contact Technical Support. Refer to: [Section 10: HID Global Technical Support](#)



### Using the Error Message Table

Error Message	Cause	Solution
<p><b># 81</b> Unable to Feed</p>	<p>The Printer is unable to feed a card from the Card Hopper.</p>	<p>Check the following, then press the <b>Pause</b> button to continue.</p> <ul style="list-style-type: none"> <li>• Verify the card thickness setting is set to the thickness of your cards.</li> <li>• Verify the Cleaning roller is properly installed on the Ribbon Cartridge.</li> <li>• Check for card slippage. If necessary, run the Printer cleaning routine.</li> <li>• Verify that your cards are within the perimeters accepted card size range.</li> <li>• Verify the cards are not sticking together.</li> </ul>

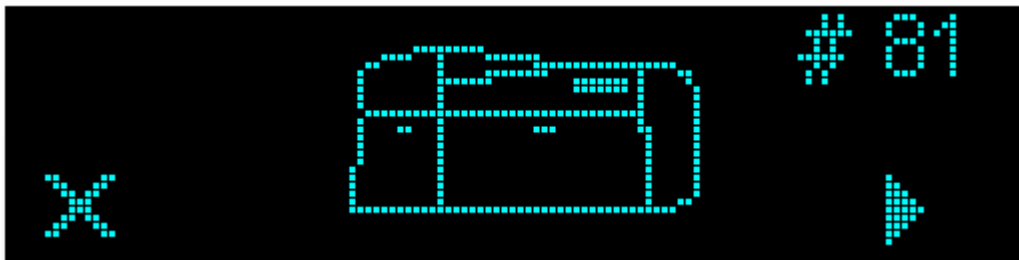

## Troubleshooting with the Error Message Table

Error Message	Cause	Solution
<b># 2</b> <b>Head Move Error</b> <b># 3</b> <b>Headlift Error</b> <a href="#"> contextid=201</a>	This is a problem with the Printhead Lift.	Reset the Printer and try again. <ul style="list-style-type: none"> <li>• If this problem persists, call for technical assistance.</li> </ul>
<b># 8</b> <b>Head Sensor Error</b> <a href="#"> contextid=200</a>	The Printhead Temperature Sensor is not functioning or is not connected properly. <b>OR</b> The Printhead is not cooling properly.	Reset the Printer and try again. <ul style="list-style-type: none"> <li>• If the problem persists, call for technical assistance.</li> </ul>
<b># 9</b> <b>Reboot Required</b>	Unspecified system error detected by the Printer Firmware.	Reset the Printer and try again. <ul style="list-style-type: none"> <li>• If this problem persists, call for technical assistance.</li> </ul>
<b># 25</b> <b>Ribbon not Installed</b> <a href="#"> contextid=232</a>	A Ribbon is not installed in the Printer.	Install a Ribbon and retry.

## Troubleshooting with the Error Message Table

Error Message	Cause	Solution
<b># 30</b> <b>Mag Verify Error</b> <a href="#"> contextid=251</a> <a href="#"> contextid=252</a>	Magnetic encoding verification failure.	<ul style="list-style-type: none"> <li>• Try encoding with a different card.</li> <li>• Verify cards have the Magnetic Stripe.</li> <li>• Replace the Magnetic Encoding Module.</li> </ul>
<b># 31</b> <b>No Mag Module</b> <a href="#"> contextid=250</a>	You are trying to send encoding data, but the Printer is not configured with this Encoder type.	<ul style="list-style-type: none"> <li>• Ensure that no encoding data is being sent with the print job and reprint the card.</li> <li>• Install a Magnetic Encoding Module.</li> </ul>
<b># 38</b> <b># 39</b> <b># 40</b> <b>EEPROM Corrupt</b> <b>EEPROM Read Error</b>	EEPROM restored with factory default values.	<p>If changes were made in the Advanced Setting Tab in the Printer Driver, click the <b>Default</b> button to reset these numbers.</p> <ul style="list-style-type: none"> <li>• Reset the Printer and try again. If this problem persists, call for technical assistance.</li> </ul>

## Troubleshooting with the Error Message Table

Error Message	Cause	Solution
<b># 44</b> <b>Flipper Jam/ Home Error</b>   contextid=220	A card has become jammed in the Printer's Flipper Table.  The Flipper failed to position properly while aligning a card or flipping a card.	Clear any cards in the Flipper Table using the buttons to move the card out. Resume printing. <ul style="list-style-type: none"> <li>Reset the Printer and retry. If problem persists call for technical assistance.</li> </ul>
<b># 45</b> <b>No Flip Module</b>   contextid=221	Request to print on 2 <sup>nd</sup> side of card, but no Flipper is installed.	If a Flipper Module is present, ensure that the <b>Print Both Sides</b> option in the Printer Driver is set correctly. <ul style="list-style-type: none"> <li>Install a Flipper module.</li> </ul>
<b># 48</b> <b>Check Lam Power</b>   contextid=281	Lam is connected but not powered.	Power off the Printer, power the Laminator, and then power on the Printer. A damaged Flipper board, E-Card board, or EEPROM could potentially result in this same error.
<b># 52</b> <b>Lam Generic Error</b>   contextid=280	Laminator firmware error	Cycle power and try again. <ul style="list-style-type: none"> <li>If this problem persists call for technical assistance.</li> </ul>

## Troubleshooting with the Error Message Table

Error Message	Cause	Solution
# 53 <b>Lam Card Jam</b>	A jam occurred somewhere between the Printer and the laminator	Open covers and clear the obstruction/jam
# 63 Lam Tag Error <a href="#"> contextid=286</a>	There is no material loaded in the laminator	Load material into the Laminator
# 64 # 65 # 66 <b>Reboot Required</b>	Unspecified system error detected by the Printer Firmware.	Reset the Printer and try again. <ul style="list-style-type: none"> <li>• If this problem persists, call for technical assistance.</li> </ul>
# 68 <b>Card in Printer</b>	A card is jammed in the Print Station or card flipping area of the Printer.	Clear the jam and press the the <b>Pause</b> button.
# 70 <b>Multiple Feed</b> <a href="#"> contextid=211</a>	Multiple cards were fed into the Printer.	Verify the card thickness is set to the thickness of your cards, then press the <b>Pause</b> button. <ul style="list-style-type: none"> <li>• Check for card slippage. If necessary, run the Printer cleaning routine</li> <li>• Verify the Cleaning roller is properly installed on the Ribbon Cartridge.</li> <li>• Verify the cards are not sticking together.</li> </ul>

## Troubleshooting with the Error Message Table

Error Message	Cause	Solution
<p><b># 81</b>  <b>Unable to Feed</b>   contextid=214   contextid=210</p>	<p>The Printer is unable to feed a card from the Card Hopper.</p>	<p>Check the following, then press the <b>Pause</b> button to continue.</p> <ul style="list-style-type: none"> <li>• Verify the card thickness setting is set to the thickness of your cards.</li> <li>• Verify the Cleaning roller is properly installed on the Ribbon Cartridge.</li> <li>• Check for card slippage. If necessary, run the Printer cleaning routine.</li> <li>• Verify that your cards are within the perimeters accepted card size range.</li> </ul> <p>Verify the cards are not sticking together.</p>
<p><b># 82</b>  <b>Mag Jam</b>   contextid=216</p>	<p>A card is jammed Magnetic station</p>	<ul style="list-style-type: none"> <li>• Clear any cards in the Magnetic station using the buttons to move the card out.</li> <li>• Press the <b>Pause</b> button to continue.</li> </ul>

## Troubleshooting with the Error Message Table

Error Message	Cause	Solution
<b># 91</b> <b>Ribbon Out</b> <a href="#"> contextid=233</a>	The Print Ribbon has run out.	<ul style="list-style-type: none"> <li>• Install a new Ribbon.</li> <li>• Press the <b>Pause</b> button to continue or the <b>ON/OFF</b> button to cancel.</li> </ul>
<b># 93</b> <b>Wrong Ribbon</b> <a href="#"> contextid=231</a>	The Print Ribbon installed in the Printer does not match the Ribbon type selected in the Printer Driver.	<ul style="list-style-type: none"> <li>• Change either the installed Print Ribbon or the Ribbon type selected in the Printer Driver.</li> <li>• Press the <b>Pause</b> button to continue or the <b>ON/OFF</b> button to cancel .</li> </ul>
<b># 97</b> <b>Ribbon Search Error</b> <a href="#"> contextid=239</a>	<p>The Ribbon is not able to find the next panel correctly.</p> <p>Check for jams/breaks.</p>	<p>Recalibrate the Ribbon Sensor.</p> <ul style="list-style-type: none"> <li>• If broken, repair by taping the Ribbon back on to the take- up core.</li> <li>• Replace the Ribbon.</li> <li>• Press the <b>Pause</b> button to continue or the <b>ON/OFF</b> button to cancel.</li> </ul>

## Troubleshooting with the Error Message Table

Error Message	Cause	Solution
<b># 99</b> <b>Ribbon Error</b> <a href="#"> contextid=234</a>	The Print Ribbon has either broken or jammed.	<ul style="list-style-type: none"> <li>• If jammed, clear the jam.</li> <li>• If broken, repair by taping the Ribbon back on to the take-up core.</li> <li>• Press the <b>Pause</b> button to continue or the <b>ON/OFF</b> button to cancel.</li> </ul>
<b># 100</b> <b>Ribbon RFID Error</b> <a href="#"> contextid=230</a>	There is no Ribbon or the Ribbon tag information is corrupted or incorrect.	Verify the Printer Driver settings for correct Ribbon. <ul style="list-style-type: none"> <li>• Try a new Ribbon and continue.</li> <li>• Press the <b>ON/OFF</b> button to cancel.</li> </ul>
<b># 102</b> <b># 103</b> <b># 104</b> <b>Headlift Error</b>	This is a problem with the Printhead Lift.	Reset the Printer and try again. <ul style="list-style-type: none"> <li>• If this problem persists, call for technical assistance.</li> </ul>
<b># 106</b> <b>Job Data Error</b>	The print data sent to the Printer is corrupt or has been interrupted.	Check the interface cable. Select the <b>ON/OFF</b> button to cancel this print job and then resend the job.



## Troubleshooting with the Error Message Table

Error Message	Cause	Solution
# 107 Printing Error	An error was detected during printing.	Reset the Printer and try again. <ul style="list-style-type: none"> <li>• If this problem persists, call for technical assistance.</li> </ul>
# 109 Ribbon Release Error	The Printer cannot locate the next Ribbon panel in order to release the Ribbon from the card.	Ensure that the Ribbon is not stuck to the card. <ul style="list-style-type: none"> <li>• Replace the Ribbon.</li> <li>• Recalibrate the Ribbon sensor.</li> <li>• If the Ribbon is broken, repair by taping the Ribbon back onto the take- up core and manually advance to the next panel.</li> </ul>
# 110 Card Jam/Align error	A card is jammed in the Print Station or card flipping area of the Printer.	Clear the jam. Press the <b>Pause</b> button to continue.
# 111 Head Loading	An unrecoverable error has occurred during printing.	Reset the Printer and try again. If this problem persists, call for technical assistance.
# 112 Card Jam/Align error	A card is jammed in the Print Station or card flipping area of the Printer.	Clear the jam. Press the <b>Pause</b> button to continue.

## Troubleshooting with the Error Message Table

Error Message	Cause	Solution
<p><b># 113</b> <b>Ribbon Release Error</b></p> <p> contextid=300</p>	<p>The Printer cannot locate the next Ribbon panel in order to release the Ribbon from the card.</p>	<p>Ensure that the Ribbon is not stuck to the card.</p> <ul style="list-style-type: none"> <li>• Replace the Ribbon.</li> <li>• Recalibrate the Ribbon sensor.</li> <li>• If the Ribbon is broken, repair by taping the Ribbon back onto the take- up core and manually advance to the next panel.</li> <li>• Press the <b>Pause</b> button to continue.</li> </ul>
<p><b># 128</b> <b>Calibrate Ribbon</b></p> <p> contextid=235</p>	<p>The Print Ribbon Sensor is out of calibration.</p>	<p>Calibrate the Ribbon Sensor.</p>
<p><b># 131</b> <b>Flipper Jam/ Home Error</b></p>	<p>A card has become jammed in the Printer's Flipper Table.</p> <p>The Flipper failed to position properly while aligning a card or flipping a card.</p>	<p>Clear any cards in the Flipper Table, using the buttons to move the card out.</p> <ul style="list-style-type: none"> <li>• Resume printing.</li> <li>• Reset the Printer and retry. If problem persists call for technical assistance.</li> </ul>







## Troubleshooting with the Error Message Table

Error Message	Cause	Solution
<b># 136</b> <b>Secure Guard Print Disabled</b> <a href="#"> contextid=203</a>	Printing is disabled by SecureGuard until a password is received.	Reset the Printer and retry. <ul style="list-style-type: none"> <li>• If the problem persists, call for technical assistance.</li> </ul>
<b># 139</b> <b>Please Remove Ribbon</b>	Ribbon needs to be removed.	Reset the Printer and retry. <ul style="list-style-type: none"> <li>• If problem persists, call for technical assistance.</li> </ul>
<b># 144</b> <b>EEPROM Corrupt</b> <b>EEPROM Read Error</b>	EEPROM restored with factory default values.	<ul style="list-style-type: none"> <li>• If changes were made in the Advanced Setting Tab in the Printer Driver, click the <b>Default</b> button to reset these numbers.</li> <li>• Reset the Printer and try again. If this problem persists, call for technical assistance.</li> </ul>
<b># 170</b> <b>Ribbon Calibration failed</b>	Ribbon calibration failed.	Check for material blocking sensor and try again.

## Printer Specific Tools (DTC4500)



Here is a description of these tools.

- Press the  button to scroll through the details of the Printer and perform the action.
- Press the  button to select the option.
- Once  is selected, use the left down arrow  to scroll through the Info, Test Prints, and Languages and Exit.
- Use the corner arrow  to run that option.
- The curved arrow  will return to the first screen.



## Additional Printer Specific Tools (DTC4500)

Label	Description
<b>INFO</b>	<ul style="list-style-type: none"> <li>• Printer Type</li> <li>• Firmware Version</li> <li>• I.P Address</li> <li>• Flipper</li> <li>• Lamination</li> <li>• Magnetics</li> <li>• E-Card</li> <li>• Password</li> <li>• Card count</li> </ul>
<b>TEST PRINTS</b>	<p><b>Color Photo:</b> Select this to print a color card to test communication and integrity.</p> <p><b>Alignment:</b> Select this to print a card used to align the print image on the card.</p> <p><b>Settings:</b> Select this to print a card with the Advanced settings.</p> <p><b>Resin:</b> Select this to print a RESIN test card.</p> <p><b>Rewritable:</b> Select this to ERASE the Rewritable card.</p>
<b>Language</b>	<p><b>Language:</b> Select this choice to change the Printer Displayed Language.</p>
<b>Exit</b>	<p><b>Exit:</b> Select this choice to exit the Printer Tool options.</p>

## Section 8: Cleaning

The Card Printer is built to require a minimum amount of maintenance. Nevertheless, there are a few procedures you can perform on a regular basis or as needed to ensure the best possible performance

### Safety Messages (review carefully)

Symbol	Critical Instructions for Safety purposes
<p>Danger:</p> 	<p><b>Failure to follow these installation guidelines can result in death or serious injury.</b></p> <p>Information that raises potential safety issues is indicated by a warning symbol (as shown to the left).</p> <ul style="list-style-type: none"> <li>• <b>To prevent personal injury</b>, refer to the following safety messages before performing an operation preceded by this symbol.</li> <li>• <b>To prevent personal injury</b>, always remove the power cord prior to performing repair procedures, unless otherwise specified.</li> <li>• <b>To prevent personal injury</b>, make sure only qualified personnel perform these procedures.</li> </ul>
<p>Caution:</p> 	<p><b>This device is electrostatically sensitive. It may be damaged if exposed to static electricity discharges.</b></p> <p>Information that raises potential electrostatic safety issues is indicated by a warning symbol (as shown to the left).</p> <ul style="list-style-type: none"> <li>• <b>To prevent equipment or media damage</b>, refer to the following safety messages before performing an operation preceded by this symbol.</li> <li>• <b>To prevent equipment or media damage</b>, observe all established Electrostatic Discharge (ESD) procedures while handling cables in or near the Circuit Board and Printhead Assemblies.</li> <li>• <b>To prevent equipment or media damage</b>, always wear an appropriate personal grounding device (e.g., a high quality wrist strap grounded to avoid potential damage).</li> <li>• <b>To prevent equipment or media damage</b>, always remove the Ribbon and Cards from the Printer before making any repairs, unless otherwise specified.</li> <li>• <b>To prevent equipment or media damage</b>, take jewelry off of fingers and hands, as well as thoroughly clean hands to remove oil and debris before working on the Printer.</li> </ul>



## DTC4500 Card Printer/Encoder Cleaning Kit



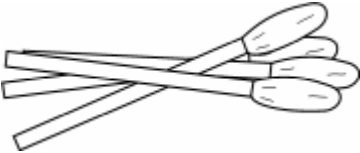
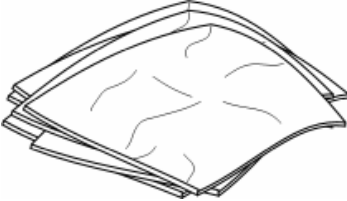

**Caution:** As with any electronic device, internal components of the Printer, such as the Printhead, may be damaged if exposed to static electrical discharges. To avoid potential damage, always wear an appropriate personal grounding device, such as a wrist strap (with integral resistor) connected to an ESD ground.

### Supplies (included with the Cleaning Kit)

This Cleaning Kit provides you with the specialized cleaning supplies and the required cleaning procedures for you to maintain your Fargo DTC4500 Card Printer/Encoder. The following cleaning procedures will require less than ten minutes.

Description	Supplies (pictured)
<p><b>Four (4) Printhead Cleaning Swabs</b> are pre-moistened with 99.99% isopropyl alcohol for cleaning your Printer's Printhead.</p>	
<p><b>Ten (10) Gauze Pads</b> are pre-moistened with 99.99% isopropyl alcohol for cleaning your Printer's interior and exterior.</p>	
<p><b>Ten (10) Cleaning Cards</b> are provided with adhesive backing for cleaning your Printer's Platen and Card Feed Rollers.</p>	



## Printhead Cleaning

Step	Procedure
1	 <b>Caution:</b> Turn <b>Off</b> the Printer and unplug the power cord from the Printer.
2	Remove the Ribbon Cartridge.
3	Open the <b>Printhead Cleaning Swabs</b> . Break it to moisten the tip.
4	Swab the tip back and forth across the top of the Printhead. Allow to dry thoroughly before sending a print job. 

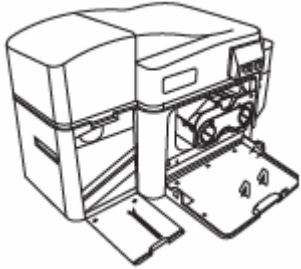

## Cleaning the Platen and the Card Feed Rollers

Perform this procedure approximately every **1000 prints** to maintain a consistent print quality. (**Note:** The Card Feed Rollers move the card throughout the print process. Rollers should be kept clean to prevent card jams and card contamination. This cleaning process will ultimately lead to better print quality and extended Printhead life.)

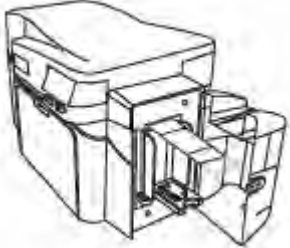
Step	Procedure	Picture
1	<p>a. Open the Printer's Front Cover and remove the Print Ribbon.</p> <p>b. Remove all the cards from the Printer's Input Hopper.</p>	
2	<p>Use the <b>Cleaning Card</b> from the Printer's and remove the adhesive backing from both sides of the card.</p> <p>If your Printer has a Magnetic Encoder installed, be sure to leave the small Liner Strip on top of the <b>Cleaning Card</b> in place.</p> <p>This small strip is needed to protect the Magnetic Head from the adhesives on the <b>Cleaning Card</b>.</p>	
3	<p>Insert the <b>Cleaning Card</b> into the Single Feed Card Slot until the card stops.</p> <p>If your Printer is equipped with a Magnetic Encoder, you must insert the <b>Cleaning Card</b> with the printed side up and with the small Liner Strip towards the front of the Printer.</p>	

## Cleaning the Platen and the Card Feed Rollers

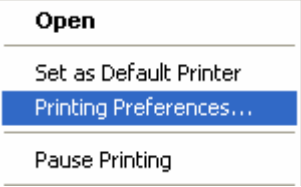
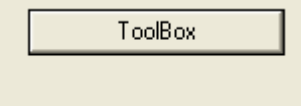
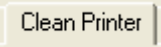
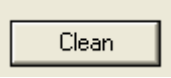
Step	Procedure	Picture
4	From your computer, open the Printer Driver and select Printing Preferences.	 <p>The image shows a context menu titled "Open" with the following options: "Set as Default Printer", "Printing Preferences..." (highlighted in blue), and "Pause Printing".</p>
5	Open the <b>Toolbox</b> button.	 <p>The image shows a rectangular button labeled "ToolBox".</p>
6	Click on the <b>Clean Printer</b> button.	 <p>The image shows a rectangular button labeled "Clean Printer".</p>
7	<p>Click on the <b>Clean</b> button.</p> <ul style="list-style-type: none"> <li>• The Printer will pull in the <b>Cleaning Card</b>. The Printer will then perform an automated cleaning procedure.</li> <li>• This procedure is designed to thoroughly clean the Platen and the Card Feed Rollers inside the Printer.</li> </ul>	 <p>The image shows a rectangular button labeled "Clean".</p>

## **Cleaning the Printer's Interior**

Periodically, use a **Cleaning Pad** from the Printer's **Cleaning Kit** to remove dust and other contaminants from inside the Printer. (**Note:** Dust and other particles may accumulate inside the Printer with continued usage. This can cause spots or specks to appear on the printed cards.)

## **Cleaning the Printer's Exterior**

Clean it only with a **Cleaning Pad** from the Printer's **Cleaning Kit**. (**Note:** The Printer has a durable casing that should retain its luster and appearance for many years.)

## Section 9: Firmware Upgrades

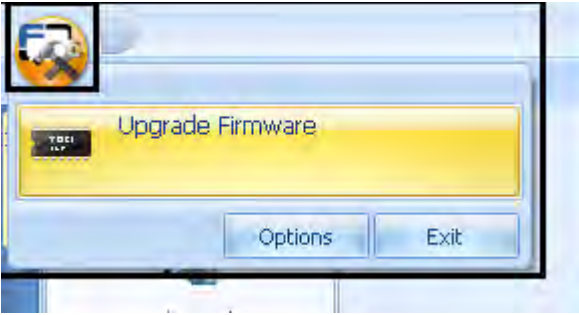

### Upgrade the Printer Firmware

Step	Procedure
1	<b>Requirements</b> <ul style="list-style-type: none"><li>• Internet Access</li><li>• Printer is powered up and connected to PC</li></ul>
2	Open the Fargo Workbench Printer Utility and use the <b>Diagnostics</b> button from the Card Option Printing Preference page. ( <b>Note:</b> The Workbench is also available from the Fargo Folder in the Windows Program folder.) 
3	From the Application Icon, select <b>Upgrade Firmware</b> . 

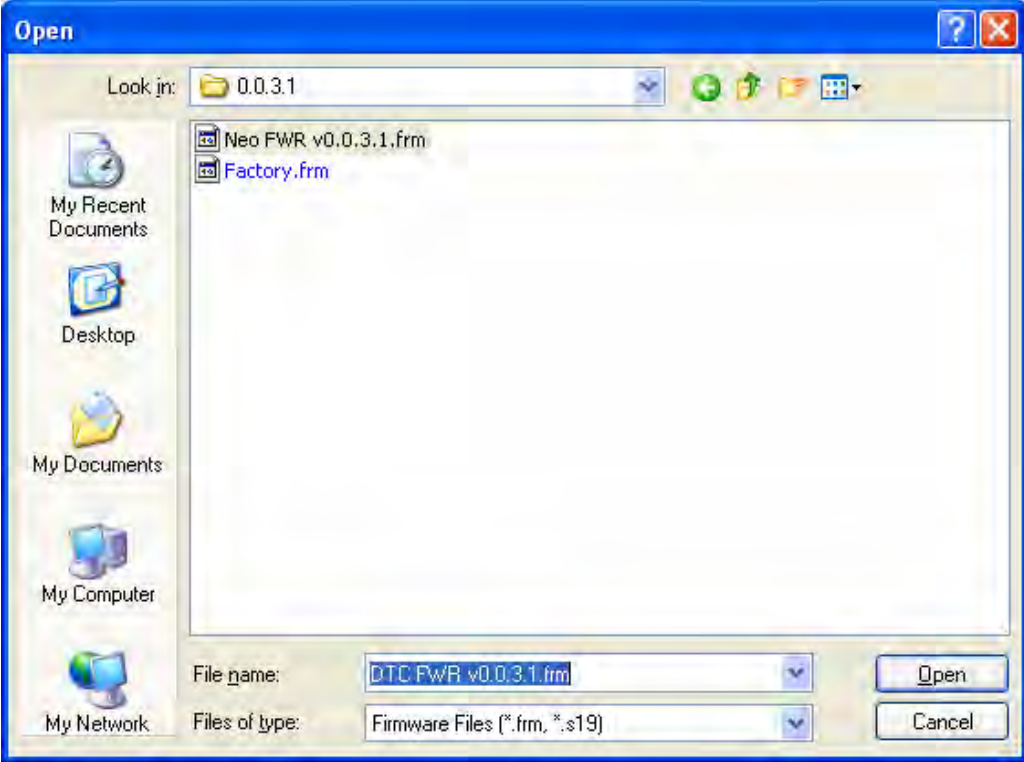
### Upgrade the Printer Firmware

Step	Procedure
4	<p>Find the Firmware via Check for Firmware Updates at <a href="http://www.hidglobal.com">www.hidglobal.com</a></p> <ul style="list-style-type: none"><li>• Save the file to a folder.</li><li>• Use the <b>Browse</b> button to find the .frm file.</li><li>• Select the file. Click <b>Open</b>.</li></ul> 

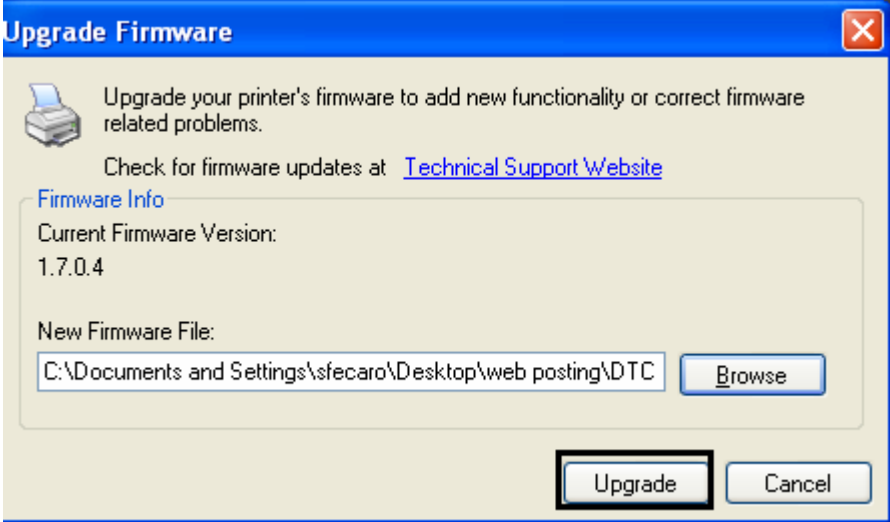
## Upgrade the Printer Firmware

Step	Procedure
5	<p>Click on <b>Upgrade</b> to start the upgrade process.</p> 
6	<p>This message will appear while Firmware is updating.</p> 
7	<p>The Printer will reboot after this process is completed.</p>

## Section 10: HID Global Technical Support

The purpose of this section to provide you with an efficient, step-by-step procedure to be used when contacting HID GLOBAL Technical Support as needed for this Card Printer.

Step	Procedure
1	Contact the HIDGlobal Technical Support Group by phone at (866)607-7339 Ext #6 or by fax at (952) 946-8492 for additional technical assistance.  <b>OR</b> Contact HID Technical Support via the Web: <a href="http://www.hidglobal.com">www.hidglobal.com</a>
2	Position a phone near the Printer and Computer so the technician can help to troubleshoot the Printer(s).
3	Please have a self-test and a sample card ready when calling HID Technical Support.

## Reading the Serial Numbers on a Fargo Printer

You can determine when your card Printer was manufactured by reading directly from the serial number (affixed to your card Printer).

Example	Explanation
Reviewing Example No. 1: Serial Number A9050028 ( 2009)	<ul style="list-style-type: none"> <li>• <b>A9050028:</b> The first two digits in the serial number indicate the year the Printer was built (e.g., the digits A9 indicate the year 2009).</li> <li>• <b>A9050028:</b> The third and fourth digits in the serial number indicate the week the Printer was built (e.g., the digits 05 indicate week 5th of that year).</li> <li>• <b>A9050028:</b> The last four digits indicate the sequence number for the numeric order in which the Printers were built.</li> </ul>
Reviewing Example No. 2: Serial Number B0050028 (2010)	<ul style="list-style-type: none"> <li>• <b>B0050028:</b> The first two digits in the serial number indicate the year the Printer was built (e.g., the digits B0 indicate the year 2010).</li> <li>• <b>B0050028:</b> The third and fourth digits in the serial number indicate the week the Printer was built (e.g., the digits 05 indicate week 5th of that year).</li> <li>• <b>B0050028:</b> The last four digits indicate the sequence number for the numeric order in which the Printers were built.</li> </ul>



## Appendix A

### Using the Defined Area Option

This procedure can be used with the K Panel or the Overlay /Print Area procedure to define specific areas. The K-Panel procedure is described below: The same process is used for the Overlay/Print Area option.

- Select **Defined Area(s)** for the Printer Driver to print the resin black (K) panel for all black found only in a desired and defined area or areas.
- Click **Defined Area(s)**, which will activate the card grid in the upper half of the window. It is through this card grid that up to five areas can be defined.
- Determine the area of the card necessary to define. In the sample, this area is indicated by the dashed outline.
- Determine the size of this area by actually printing a card and looking at it in the same orientation as when it exits the Printer.
- Measure the total size for the area and enter those dimensions into the dimension boxes.
- Once the area is sized properly, measure from the lower left corner of the card up and over to the lower left corner for the defined area. Enter these values into the X and Y boxes.



**Identification Card**

Karen Atkins  
Access Level-2  
ID# 1234478  
\* 172355\*

1.8"      1.2"



- Print the card design and note how the image is oriented on the card as it ejects from the Printer.
- Measure the defined area location based on the printed card.

- Define another area by clicking the Defined Area up arrow.
- Use the Defined Area arrows to navigate back and forth from area to area.
- Delete an area by using the Defined Area arrows to select the area.

## Configuring Fluorescent Data (F-Panel for YMCFKO Ribbon) using the Workbench

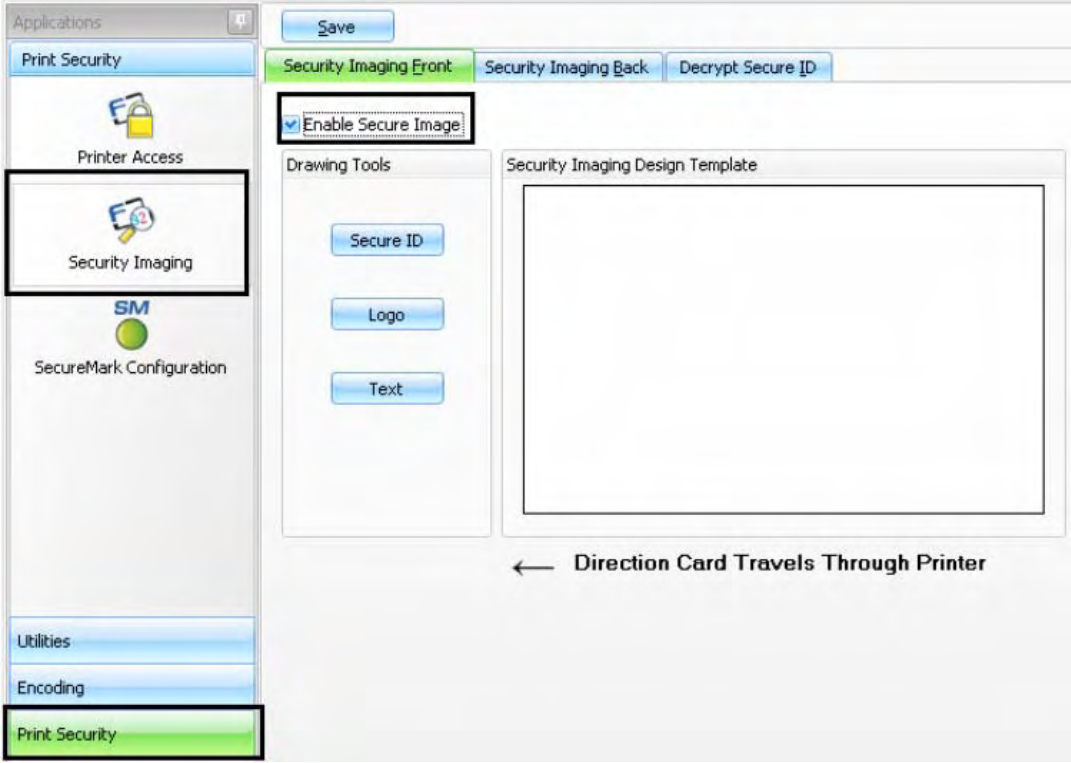
Step	Procedure
1	From the Driver Printing Preferences, click on <b>Diagnostics</b> to bring up the Fargo Workbench Printer Utility.
2	<p>a. Click the <b>Print Security</b> applet group and select the <b>Security Imaging</b> applet.</p> <p>b. Check the <b>Enable Secure Imaging</b> checkbox. (<b>Note:</b> The option for both front and back are set up the same way.)</p> 

**Configuring Fluorescent Data (F-Panel for YMCFKO Ribbon) using the Workbench**

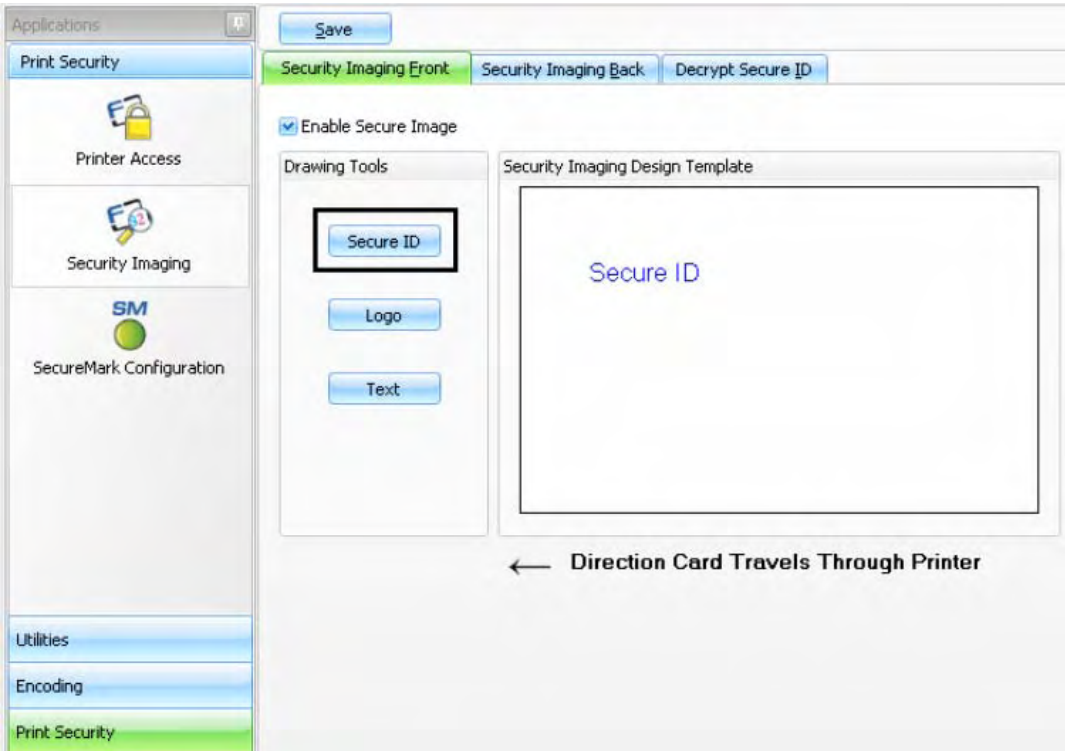
Step	Procedure
3	<p>a. Click on the <b>Secure ID</b> box on the left.</p> <p>b. Click and drag a box onto the Template.</p> <p>c. Move and size as needed.</p> 

### Configuring Fluorescent Data (F-Panel for YMCFKO Ribbon) using the Workbench

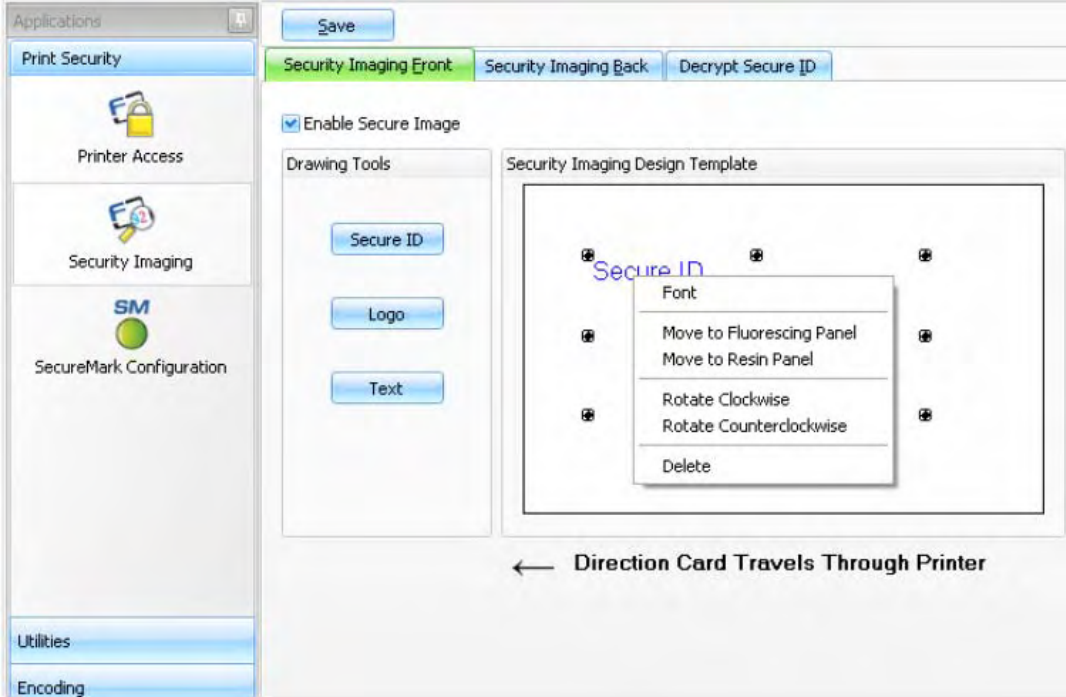
Step	Procedure
4	<p>On the Template, right click on the Secure ID box for the options.</p>  <p>The screenshot shows the 'Security Imaging Design Template' window. On the left, there is a sidebar with 'Applications' including 'Print Security', 'Printer Access', 'Security Imaging', and 'SecureMark Configuration'. Below that are 'Utilities' and 'Encoding'. The main window has a 'Save' button and tabs for 'Security Imaging Front', 'Security Imaging Back', and 'Decrypt Secure ID'. A 'Drawing Tools' panel contains 'Secure ID', 'Logo', and 'Text' buttons. The 'Security Imaging Design Template' area shows a card layout with a 'Secure ID' label. A context menu is open over the 'Secure ID' label, listing options: 'Font', 'Move to Fluorescing Panel', 'Move to Resin Panel', 'Rotate Clockwise', 'Rotate Counterclockwise', and 'Delete'. Below the design template, an arrow points left with the text 'Direction Card Travels Through Printer'.</p>

### Configuring Fluorescent Data (F-Panel for YMCFKO Ribbon) using the Workbench

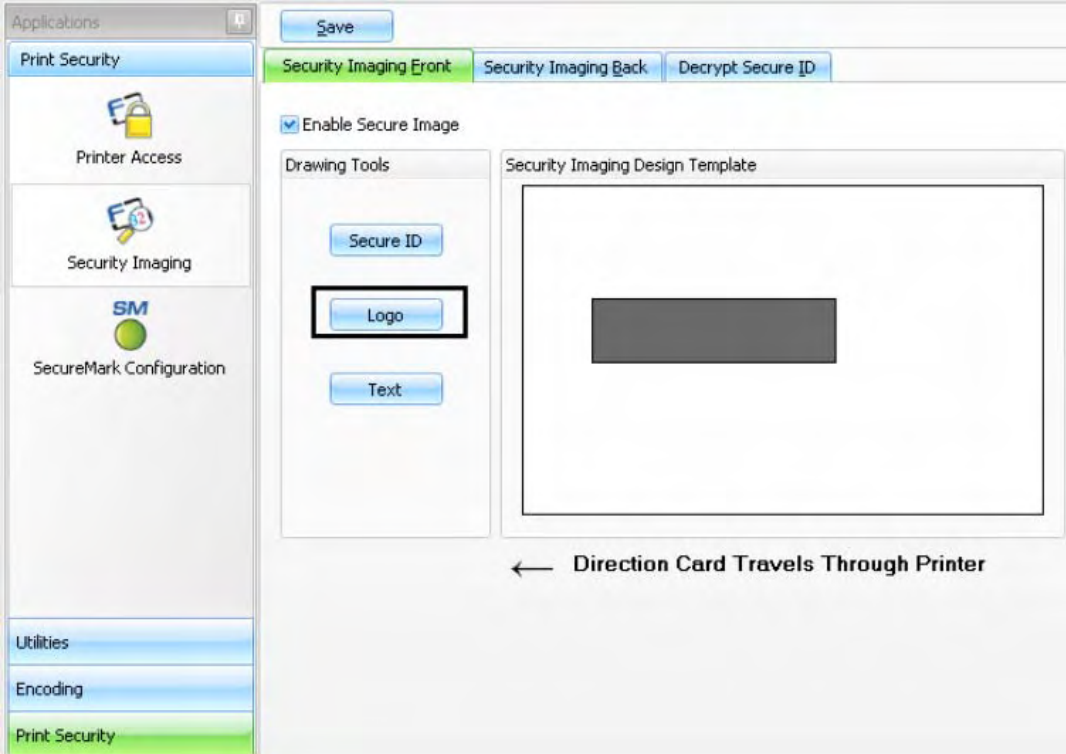
Step	Procedure
5	<p>a. Click on the <b>Logo</b> box on the left.</p> <p>b. Click and drag a box onto the Template.</p> <p>c. Move and size (as needed) by grabbing the corner of the box.</p> 

### Configuring Fluorescent Data (F-Panel for YMCFKO Ribbon) using the Workbench

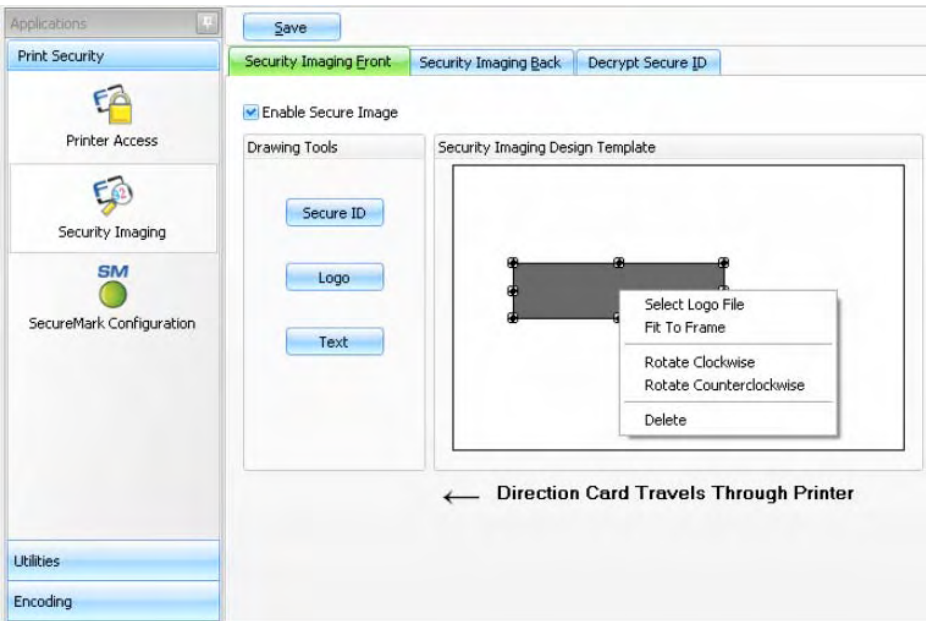
Step	Procedure
6	On the Template right click on the <b>Logo</b> box for the options shown below.
7	<p><b>Select the Logo File.</b></p> <p>Find the source of the Logo to place on the card. (<b>Note: Fit to Frame</b> will size the image to fit the box. Once this is set up, this logo will print from the software program. This is set up in the background.)</p> 

### Configuring Fluorescent Data (F-Panel for YMCFKO Ribbon) using the Workbench

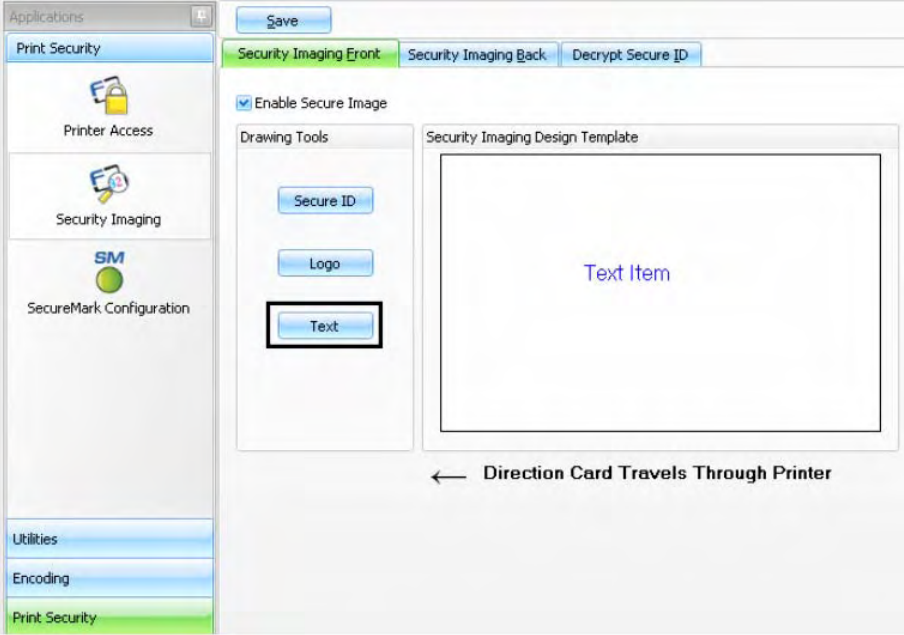
Step	Procedure
8	<p>a. Click on the <b>Text</b> box on the left.</p> <p>b. Click and drag a box onto the Template.</p> <p>c. Move and size as needed.</p> 

### Configuring Fluorescent Data (F-Panel for YMCFKO Ribbon) using the Workbench

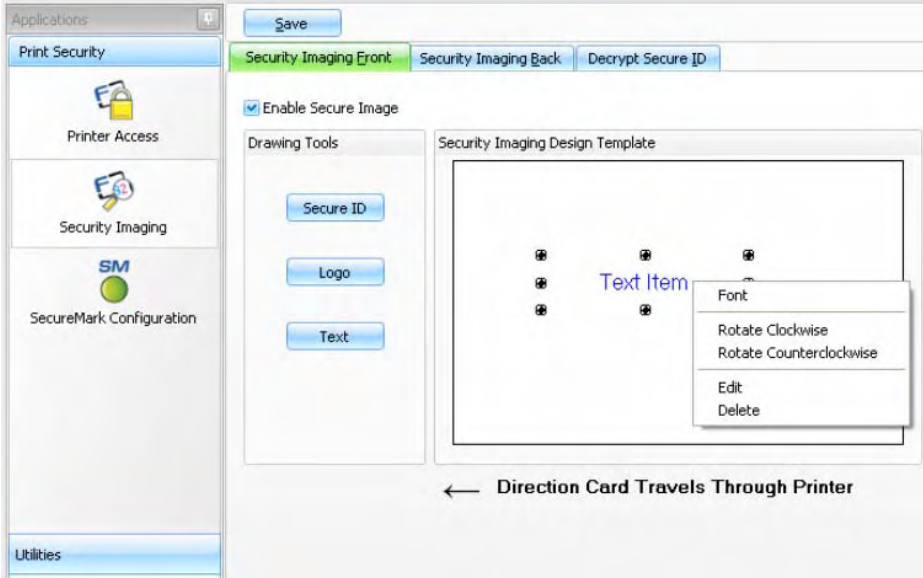
Step	Procedure
9	<p>On the Template, right click on the <b>Text</b> box for the options.</p> 

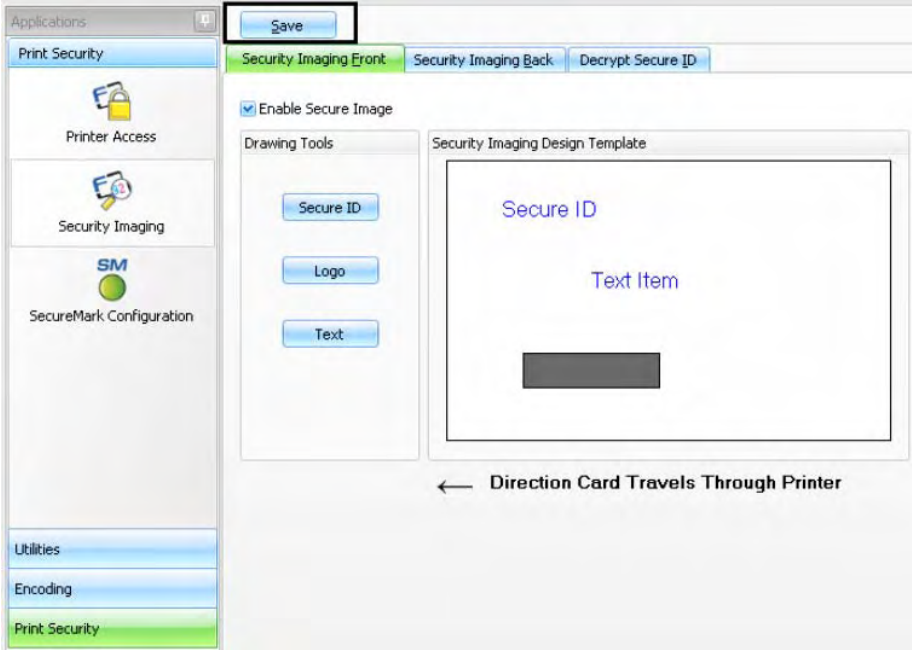

### Configuring Fluorescent Data (F-Panel for YMCFKO Ribbon) using the Workbench

Step	Procedure
10	Follow the same instruction as above for the back side of the card.
11	<p>a. Save this template using the <b>Save</b> button</p> <p>b. Close the Workbench. (<b>Note:</b> Any Software program file printed with the YMCFKO Ribbon installed into the Printer will print this design with the F-Panel of the Ribbon. It will print the same file each time unless you recreate a new template.)</p> 

**Configuring Fluorescent Data (F-Panel for YMCFKO Ribbon) using the Workbench**

Step	Procedure
12	Set the Ribbon for YMCFKO in the Printing Preferences. ( <b>Note:</b> The <b>Detect Supplies at Print Time</b> button may also be used. The F-Panel Ribbon must be installed for this process to work.)
13	<p>Check <b>Dual Pass</b> if you would like to print the F-Panel on a separate panel of HDP film from the YMC image.</p> <p>You should use the default <b>Dual Pass</b> option:</p> <p>If the fluorescent image is used in places where other dye is used.</p> <p><b>OR</b></p> <p>Any time the Invert F-Panel Image option is selected.</p>
14	<p>Check <b>Invert F-Panel Image</b> to create a negative of the fluorescent image.</p> <ul style="list-style-type: none"> <li>• This refers to the ability to cause light or white areas of the image to fluoresce and dark colors to remain dark on the printed card when exposed to a UV light.</li> <li>• This was requested because the fluorescent dye color is bright when black light is applied to it.</li> <li>• By default, the dark areas of the image will fluoresce on the card and the lighter or white areas will have no dye applied. (<b>Note:</b> This may improve the look of the person’s image if used for the Logo.)</li> </ul> <div data-bbox="293 1178 1073 1520" style="border: 2px solid black; padding: 10px; margin-top: 20px;"> <p>Options</p> <p><input type="checkbox"/> Rotate Front 180 Degrees</p> <p><input type="checkbox"/> Rotate Back 180 Degrees</p> <p><input type="checkbox"/> Disable Printing</p> <p><input checked="" type="checkbox"/> <b>Invert F-panel Image</b></p> <p><input type="checkbox"/> Write Only</p> </div>