

**Circle Communication Products, Inc**

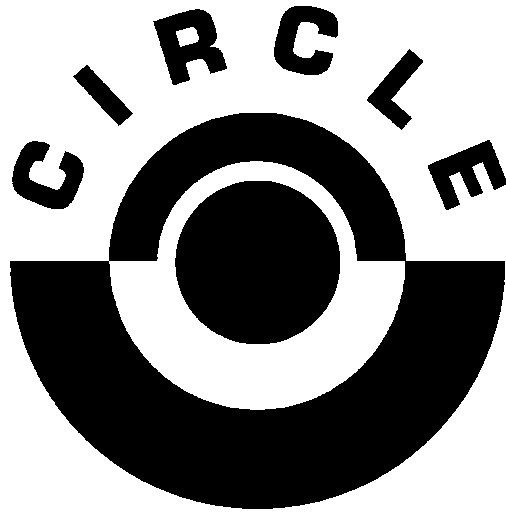

**5.8GHz Multi-line and Multi-handset  
Cordless Telephone System**

Configuration Guide

Version 2.20

# **COPYRIGHT**

**COPYRIGHT 2003, Circle Communication Products, Inc. ALL RIGHTS RESERVED.**

This manual is the copyright of Circle Communication Products, Inc. You may not reproduce, transmit, transcribe, store in a retrieval system, or translate into any language, in any form or by any means, electronic, mechanical, magnetic, optical, chemical, manual, or otherwise, any part of this publication without the express written permission of Circle Communication Products, Inc.

## **Disclaimer**

Circle Communication Products, Inc. makes no representations or warranties regarding the content of this manual. We reserve the right to revise the manual or make changes in the specifications of the product described within it at any time without notice and without obligation to notify any person of such revision or change.

## Table of Contents

COPYRIGHT .....	2
DISCLAIMER .....	2
<b>INTRODUCTION .....</b>	<b>6</b>
PACKAGE CONTENT.....	6
<b>INSTALLATION .....</b>	<b>7</b>
OVERVIEW OF MAIN CONTROL BASE .....	7
EQUIPMENT LOCATION.....	7
INSTALLATION OF THE MAIN CONTROL BASE.....	8
CHARGING THE BATTERY .....	9
CONNECTION OF TELEPHONE LINE .....	9
CONNECTION OF EXTERNAL MOH (MUSIC ON HOLD).....	9
CONNECTION OF PAGING SYSTEM (OPTION).....	9
CONNECTION OF SINGLE LINE PHONE FOR POWER FAILURE TRANSFER (OPTION).....	10
SOFTWARE INSTALLATION .....	10
<b>CALL FEATURES DESCRIPTIONS.....</b>	<b>11</b>
AUTO ATTENDANCE (AA) .....	11
AUTOMATIC CALL BACK ON BUSY .....	11
AUTOMATIC CALL DISTRIBUTION.....	11
AUTOMATIC RECALL .....	12
CALL FORWARD, ALL CALLS.....	12
CALL FORWARD, BUSY .....	12
CALL FORWARD, BUSY OR NO ANSWER .....	12
CALL FORWARD, NO ANSWER.....	12
CALL FORWARD, TO EXTERNAL LINE .....	13
CALL FORWARD, TO VOICE MAIL .....	13
CALL HOLD, NORMAL.....	13
CALL HOLD, EXCLUSIVE .....	13
CALL LOG .....	14
CALL PAGING .....	14
CALL PICKUP, LINE .....	14
CALL PICKUP, EXTENSION.....	14
CALL TRANSFER, LINE CALL.....	14
CALL TRANSFER, INTERCOM CALL.....	15
CONFERENCE .....	15
DIAL TYPE SELECTION .....	15
DIGITAL VOLUME CONTROL.....	15
DIRECT IN LINES (DIL).....	15
DISPLAY.....	16
DO NOT DISTURB (DND) .....	16
DP TO MF CONVERSION .....	16
END-TO-END SIGNALING.....	16
FLASH FUNCTION.....	16
HANDS FREE OPERATION.....	16
HEADSET OPERATION.....	17
IDLE LINE AUTOMATIC SELECTION .....	17
INTERCOM TO LINE FORWARDING .....	17
LAST NUMBER REDIAL .....	17
LINE ASSIGNMENT .....	17
LINE OR EXTENSION CAMP ON .....	17
LINE-TO-LINE FORWARDING .....	18
MUSIC ON HOLD .....	18
MEMO RECORDING.....	18
NEW CALL INDICATION .....	18

NIGHT SERVICE .....	18
ON-HOOK DIALING .....	19
PAUSE INSERTION .....	19
POWER FAILURE TRANSFER.....	19
REAL TIME CLOCK PROGRAMMING .....	19
TOLL RESTRICTION CODE .....	20
TOLL CALL SECURITY CODE.....	20
<b>CALL FEATURES CONFIGURATION .....</b>	<b>21</b>
1) CALL FEATURES CONFIGURATION BY COMPUTER (SEE PC PROGRAMMING GUIDE) .....	21
2) CALL FEATURES CONFIGURATION BY HANDSET.....	21
<i>Start Call Features Configuration</i> .....	21
<i>Menu Hierarchy</i> .....	22
<i>System Configuration Menu</i> .....	24
1 <i>Basic Setup</i> .....	24
1.1 <i>TIME</i> .....	25
1.2 <i>Outgoing Call</i> .....	26
1.3 <i>Incoming Call</i> .....	26
1.4 <i>Tone/Pulse Dialing</i> .....	27
1.5 <i>Password</i> .....	27
2 <i>Advanced Call Features</i> .....	28
2.1 <i>Day/Night mode</i> .....	28
2.2. <i>Line Mode</i> .....	29
2.3 <i>Line to Line</i> .....	31
2.4 <i>ACD Options</i> .....	31
2.5 <i>Toll Restriction</i> .....	32
3 <i>Voice Mail / AA</i> .....	33
3.1 <i>VOICE MAIL</i> .....	33
3.2 <i>Auto Attendant</i> .....	35
4 <i>Handset Manage</i> .....	36
4.1 <i>Edit User Name</i> .....	36
4.2 <i>Delete User</i> .....	37
5 <i>Technical Setting</i> .....	37
5.1 <i>Restore Technical Default</i> .....	37
5.2 <i>Call Setting</i> .....	37
5.3 <i>Technical Setting (Password protected, authorized personnel only)</i> .....	38
<b>VOICE MAIL CONFIGURATION .....</b>	<b>42</b>
INTRODUCTION .....	42
FEATURES.....	42
<i>Voice Mail</i> .....	42
<i>Auto Attendant</i> .....	42
<i>Multi-level Interactive Voice Response</i> .....	42
VOICE MAIL.....	43
<i>Related Setting by Computer (See PC programming Guide)</i> .....	43
<i>Mailbox</i> .....	43
<i>Global Parameters</i> .....	43
<i>Other Voice Mail Features</i> .....	43
<i>Verification of Voice Mail Setup</i> .....	45
<i>Voice Mail Operation Flow</i> .....	46
<i>Administration by Phone</i> .....	48
AUTO ATTENDANT .....	50
<i>Day / Night / Afternoon</i> .....	50
<i>Day Mode Afternoon Greeting</i> .....	50
<i>Time of Silence after Announcement</i> .....	50
<i>Auto Switch Day / Night Mode, Day Mode Start Time, Night Mode Start Time</i> .....	50
<i>Other Auto Attendant Features</i> .....	51
MULTI-LEVEL INTERACTIVE VOICE RESPONSE .....	53
<i>Configuration of IVR Call Flow</i> .....	54

<i>IVR Call Flow and Configuration Example</i> .....	56
<i>Termination of Call Flow</i> .....	58
<i>Example of Multi-level IVR Application</i> .....	58
<b>IMPORTANT SAFETY INSTRUCTION</b> .....	<b>62</b>
<b>SPECIFICATION</b> .....	<b>64</b>
HARDWARE SPECIFICATION.....	64
OPERATING CONDITIONS: .....	64
<b>LIMITED WARRANTY</b> .....	<b>65</b>
<b>IMPORTANT CONSUMER INFORMATION</b> .....	<b>69</b>

# Introduction

The Circle 5.8G Cordless Telephone System provides professional quality digital voice mail and PBX call handling capability with the convenience of a cordless phone.

The configuration of the Cordless Telephone System can be accomplished by one of the following options:

1. From the keypad and LCD display on extension "0".
2. From a standard PC via the RS232 port

Configuration from the PC provides a simple Graphic User Interface while configuration from the Extension affords convenience.

There are four sections in this document.

**Installation:** Procedures and Precaution

**Call Features:** All the various call features

**Configuration programming:** Configuration Procedures in detail

**Voice mail configuration:** Voice Mail Features and Configuration

## Package Content

Main Control Base (WMC) (1)

AC Adaptor (1)

Rechargeable battery pack (1)

Desktop Stand (1)

Telephone Cord (3)

System Programming Disk (1)

RS232 Serial Cable

# Installation

## Overview of Main Control Base

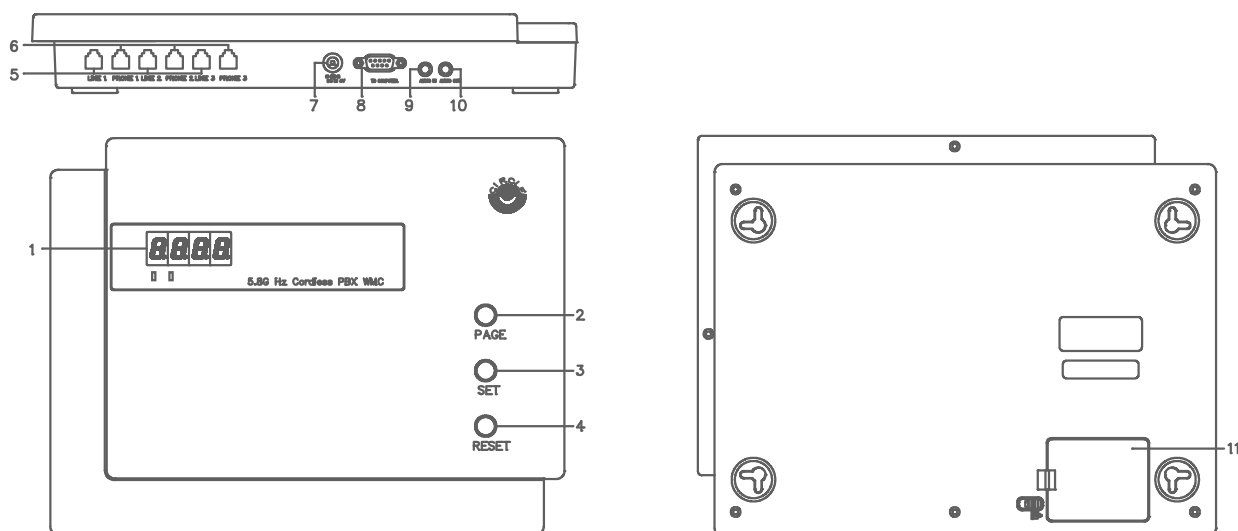

Fig.1: Overview

Item	Key Description	Functionality
1	LED Display	Show time
2	PAGE	Recall the system's extensions
3	SET	Press for the extension registration
4	RESET	System reset
5	Line 1-3	Telephone Line Ports
6	Phone 1-3	Single Line Telephone Port for Power Failure Transfer
7	DC 9V / 1.4A INPUT	Connects AC switching power supply
8	TO COMPUTER	RS232 PORT to computer
9	AUDIO IN	Connects to a sound source
10	AUDIO OUT	Connects to a PA system for voice announcement
11	BATTERY COVER (7.2V BATTERY)	Allows replacement of Batteries

## Equipment Location

When selecting a location for the equipment, consider the following:

1. The location should not be subject to excessive dirt, dust, or extremes of heat and humidity.
2. Avoid a location subject to shock or vibration.

3. Avoid a location where equipment might be subjected to water.
4. Avoid location with direct sunlight or near high frequency noise-generating equipment, such as next to a radio or television set.
5. Always install the equipment near a power outlet with easy access to a power switch.
6. The equipment should not be placed on top of a metal surface as this can affect the RF signal transmission.

## Installation of The Main Control Base

1. Insert the backup rechargeable battery.

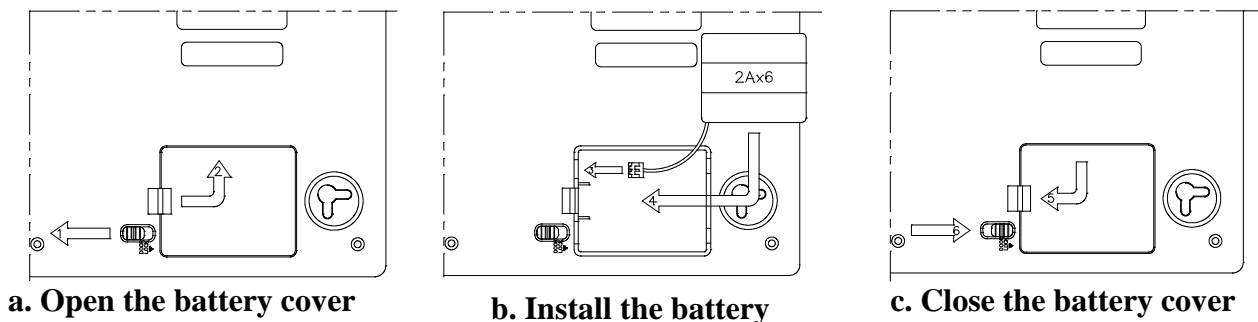

Fig. 2 Backup rechargeable battery

2. The Base should be placed at the center of the desired service area as much as possible so as to have maximum RF transmission performance.
3. The Base should be placed on a raised surface, desk or shelf so that the equipment is likely to neither fall down nor topple over. The Stand provided should be used to hold the Base in an upright position.



Fig. 3 Base Stand

4. It can also be wall mounted by hooks located at the 4 corners. (256.0x154.0mm)

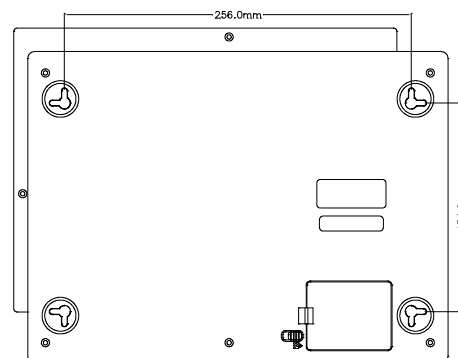

Fig. 4: Back View



5. Plug in the power supply (use **9V/1.4A adaptor**) and the clock should come on to indicate that it is working.

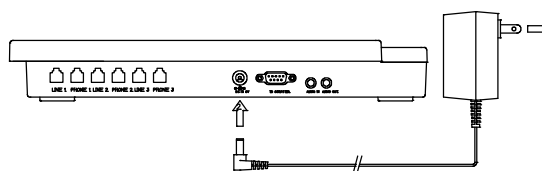

Fig. 5: Power Supply Connection

6. Follow the System Configuration Section for system programming, if necessary.

## Charging the Battery

The Base (WMC) should always be kept in the AC power mode. The battery is for emergency backup only and should always be connected as shown above. The battery will be fully charged within 24 hours of connection. A fully charged battery can maintain the system for about 10 minutes after power is lost. See the section under Connection of Single Line Phone for Power Failure Transfer.

## Connection of Telephone Line

1. Telephone lines are connected to the Line ports of the Base.
2. Telephone lines can be connected to any of the Line1, Line2 or Line3 ports.
3. If less than 3 Telephone lines are being connected, those unconnected Lines should be programmed so as not to be used in System Configuration.

## Connection of External MOH (Music on Hold)

The specifications of external MOH Audio input are:

Input Impedance	=	47kohm
Input Level	=	Nominal 50mV
Maximum Input	=	1 Vrms
Phone Jack	=	3.5mm mono or stereo jack

A sound source such as a Radio or CD Player can be connected to the Audio-In connector of the Base to provide music on hold as an option to the built-in internal MOH generator.

## Connection of Paging System (option)

The specifications of paging Audio Output are:

Output level	=	Approx. 500mV at 47 k ohm load impedance
Phone Jack	=	3.5mm mono or stereo jack

You can connect the paging port in the Main Control Base to a PA system using an audio cable to make a voice announcement using the system's extensions.

# Connection of Single Line Phone for Power Failure Transfer (option)

A maximum of 3 sets of Corded phones can be connected to the Main Control Base phone1, 2 and 3 ports. The three line ports can be automatically transferred to the corresponding corded phones connected to the three phone ports during a power failure. Any of these phones can be used as a normal single line phone for emergency calls.

## Software Installation

Software Installation Requirements:

1. System Programming Software CDROM is included in the packing.
2. System Programming Software requires an IBM – Pentium 100M Personal Computer with Window 98 (or above) operating system. Minimum Ram requirement is 128M Byte.

Software Installation Procedures

1. Boot up the PC in Window environment.
2. Put the System Programming CDROM into the CDROM drive.(e.g. D drive).
3. The CDROM will auto start, or use the Window File Explore, go to D: and run setup.exe, or use Desktop 'Start', then 'Run', type D: \setup.exe.  
Wait until the installation is finished.

# Call Features Descriptions

## Auto Attendance (AA)

Description	This feature is useful to back up the operator in receiving incoming calls. When the operator is unavailable, incoming calls will be forwarded to the voice mail system. The outside caller can press an extension number to call a desired extension or leave a message after a beep tone.
Conditions	Extension 0 is the default location of the system operator. This feature should be activated at extension '0' for the system by pressing the AA button. When the called extension is not set call forward to voice mail, the outside caller will leave message in extension "0".
Setting	Call features configuration 3.2 & User Guide's Feature Operation.

## Automatic Call Back on Busy

Description	When making an intercom call or seizing an external line, user can camp on the destination if it is busy. The busy line or extension will call back to the calling party automatically when it is idle.
Conditions	Camping on an external line and internal extension are allowed at the same time.
Setting	Call features configuration 5.2.4

## Automatic Call Distribution

Description	An incoming call can be distributed to ring the desired extensions in turn automatically. The feature is very useful in Help Desk or Call Center operation.
Conditions	For example, if extension 0, 2 and 5 are programmed to ring, then the 1 <sup>st</sup> incoming call will ring port 0 only, the 2 <sup>nd</sup> incoming call will ring port 2 only and so on. If port 2 is busy, then the next extension port, which is 5, will be rung. The distribution algorithm can be Longest idle first or Circular Hunt.

Setting Call features configuration 2.2.1.3 & 2.2.4

## Automatic Recall

Description After the recall time-out, the extension putting a call on hold or transferring a call to a no answer extension will be recalled. The recall time is programmable from 10 sec. to 90 sec. in steps of 10 sec.

Conditions Off hook prior to the start of recall cancels this operation.

Setting Call features configuration 5.2.2

## Call Forward, All Calls

Description All incoming calls will be forwarded to the desired extension immediately. All calls will be redirected to the forwarded number.

Conditions The extension will not receive any incoming call.

Setting User Guide's Feature Operation. (Menu → Call Setting)

## Call Forward, Busy

Description When the extension is off hook, incoming calls will be forwarded to the desired extension immediately.

Conditions Incoming calls will only be forwarded to the desired extension under busy condition.

Setting User Guide's Feature Operation. (Menu → Call Setting)

## Call Forward, Busy or No Answer

Description When the extension is off hook or not answering for a period, incoming calls will be forwarded to the desired extension.

Conditions When the extension is off hook, incoming calls will be forwarded to the desired extension immediately.  
When the extension is not answering for a preset time limit, incoming calls will be forwarded to the desired extension.

Setting User Guide's Feature Operation. (Menu → Call Setting)

## Call Forward, No Answer

Description When the extension is not answering for a period, incoming calls

	will be forwarded to the desired extension.
Conditions	When the extension is not answering for a preset time limit, incoming calls will be forwarded to the desired extension.
Setting	User Guide's Feature Operation. (Menu→Call Setting)

## Call Forward, to External Line

Description	An external number can be set as the forwarded number (destination) in all call forward modes for an internal call.
Conditions	Call forward operation complies with the conditions of the call forward modes. This feature is subjected to a time limit for the conversation.
Setting	User Guide's Feature Operation. (Menu →Call Setting)

## Call Forward, to Voice Mail

Description	Voice mail service can be set as a forwarded number (destination) in all call forward modes.
Conditions	Call forward operation complies with the conditions of the call forward modes.
Setting	User Guide's Feature Operation. (Menu →Call Setting)

## Call Hold, Normal

Description	By pressing the HOLD button, the call in progress can be put in the common hold condition. The call can be picked up again at any extension or transferred to another extension by making an intercom call.
Conditions	If a call on hold is not retrieved in a specified period, the system will automatically recall the extension user.

## Call Hold, Exclusive

Description	By pressing the CONF button, the call in progress can be put into the exclusive hold condition. The call can only be picked up again at the same extension. When time out occurs, the exclusive hold condition will change to common hold condition and can be picked up at any extension.
Conditions	If a call on hold is not retrieved in a specified period, the system

will automatically recall the extension user.

## Call Log

Description	Call Log detail is available if call logging is desired..
Conditions	This includes all incoming & outgoing. Connect the serial cable provided to the RS232-C serial port of the computer. The Call Log can be activated with the Windows based software provided.
Setting	PC programming, the system call log

## Call Paging

Description	Paging allows you to make a voice announcement through a PA system via the paging port of the main control base.
Setting	It is optional. To Connection of the Paging Port to a PA system use an audio cable with a 3.5mm plug.

## Call Pickup, Line

Description	By pressing the PICK button, any extension can answer an incoming line even if the call is not ringing that extension.
-------------	--

## Call Pickup, Extension

Description	By pressing the PICK button, any extension can pick up a call ringing at another extension.
-------------	---

## Call Transfer, Line Call

Description	An external incoming call from an external line can be transferred from the first answering extension to another extension.
Conditions	When an extension is on a line call, first call the destination extension number and then go on-hook and it will activate ring-inward transfer automatically.
Operation	See User Guide's Feature Operation for details.

## Call Transfer, Intercom Call

Description	An intercom call can be transferred from the first answering extension to another extension.
Conditions	The same operation as call transfer, line call.

## Conference

Description	The system supports a three party conference call. Each conference call can include up to 2 lines. During a two party conversation, the extension user can add a third party to their conversation, hence establishing a conference.
Conditions	The combinations of conference call are: 2 internal extensions and 1 line 1 internal extension and 2 lines. The system can only facilitate one conference call at a time
Operation	See User Guide's Feature Operation for details.

## Dial Type Selection

Description	The system allows users to select the desired dialing mode: pulse or tone.
Setting	call features configuration 1.4

## Digital Volume Control

Description	The ringing and receiving volumes can be controlled individually with discrete levels.
Setting	User Guide's Feature Operation.(Menu →Phone Setting→Ringer)

## Direct In Lines (DIL)

Description	The system directs incoming calls from line to one or more answering extensions.
Conditions	When the Auto-attendance feature is activated, incoming calls from line can also be directed to the voice mail system for auto-attendant service.

## Display

**Description** On the extension, the following information can be shown: extension number and name, dialed telephone number, number or name of the extension owner, line number, call duration, time and date.

## Do Not Disturb (DND)

**Description** An extension user except extension '0' can set the Do Not Disturb feature to reject incoming calls.

**Conditions** By activating the Do Not Disturb feature, any incoming exchange line or internal calls will be directed to a pre-assigned extension 0.  
DND cancels any Call Forward feature currently set.

## DP to MF conversion

**Description** By pressing the [\*] button in conversation mode, an extension can change the dialing signal from dial pulse to MF in subsequent dialing. The dialing signal will return to dial pulse after the call is finished.

## End-to-End Signaling

**Description** After making an outgoing call, the calling extension can continue sending tone (MF) signal to the called party in order to access various facilities provided by the called party such as tele-banking service.

## Flash Function

**Description** Flashing time of system can be programmed from 50 ms. to 950 ms. in step of 50 ms.

**Conditions** It is available at Desktop extension (WDE).

**Setting** call features configuration 5.3.1

## Hands free Operation

**Description** With the hands free feature phone, the user can make and receive



calls with hands free operation. Besides, the user can turn the microphone on and off (mute) during hands free operation.

## Headset Operation

Description	With the headset connected to the extension, the user can make and receive calls with the headset.
Condition	It is optional. A headset jack is available on the side of the extension.

## Idle Line Automatic Selection

Description	An idle line will be accessed in ascending order automatically: by picking up the handset or by pressing the Speaker key on the desktop phone (WDE) or press Talk or the Speaker Key on the handheld phone (WHE).
-------------	---

## Intercom to Line Forwarding

Description	When an extension receives an intercom call, the call can be transferred to an external destination such as a mobile phone.
Conditions	The destination number should be pre-stored. It works for Extension 1 to 9.
Setting	User Guide's Feature Operation. (Menu → Call Setting)

## Last Number Redial

Description	The last outgoing calls telephone number is stored in the system and it can be recalled by pressing the redial key.
-------------	---

## Line Assignment

Description	A line port in the system can be enabled or disabled.
Setting	call features configuration 2.2

## Line or Extension Camp On

Description	An extension can camp on a busy line or busy extension. Connection will be established once the called party and the calling party are idle.
-------------	--

Operation See User Guide's Feature Operation for details.

## Line-to-Line Forwarding

Description An incoming call on a pre-defined line can be automatically transferred to an external destination.

Conditions The incoming and outgoing line having this feature is programmable and the destination number should be pre-stored. It can only be set at extension 0.

Setting call features configuration 2.4

## Music on Hold

Description Either internal or external music-on-hold will be provided for any calls on hold.

Conditions No additional system hardware is required for connecting external music-on-hold. The customer has only to provide the desired music source such as a music player or radio.

Setting **Connection of External MOH** for external music on hold.

## Memo Recording

Description This function allows the user to record memos during conversation and save them for playback later.

Conditions The phone must be in the conversation mode. The memo recording is counted as a conference call.

Operation See User Guide's Feature Operation for details.

## New Call indication

Description When there is any new unanswered call, the New Call indicator light will come on.

Conditions The indicator light is available on the Desktop Phone (WDE) only. The light is off when the user browses the call history.

## Night Service

Description The System can be changed between day and night modes as required. The incoming signal can be programmed accordingly in

the Day and Night mode.

- Conditions Day and night modes can be changed automatically according to the Night mode start and end time.  
Or it can be changed manually at extension 0 as desired.
- Setting call features configuration 2.1

## On-Hook Dialing

- Description Extension can make an outgoing call in speaker mode. If the handset is lifted when the called party answers, the system will change the talk path to handset from the speaker.

## Pause Insertion

- Description A pause can be inserted into the pre-dialing mode when needed.
- Conditions The pause time is programmable from 0.5 sec.to 4.5 sec. in steps of 0.5 sec.
- Setting call features configuration 5.3.2

## Power Failure Transfer

- Description During power failure condition, telephone lines 1, 2 and 3 will be automatically connected to the corresponding single line phones (option).
- Condition A maximum of 3 sets of Corded phones can be connected to the Main Control Base . Any of these can be used as a normal single line phone for emergency calls.

## Real Time Clock Programming

- Description The System provides a real time clock (RTC) on the display, which is programmed as part of the system programming.
- Conditions RTC is programmed by the extension '0' and can be set automatically and adjusted from the incoming valid Caller ID signal.
- Setting call features configuration 1.1

## Toll Restriction Code

Description	Restricted codes can be set in the system to bar restricted extensions from dialing.
Conditions	The individual extension can be configured to be restricted from dialing certain numbers, e.g. Toll Call access codes. Three sets of code can be set restricted. The restricted extensions will require the input of a password as set for making calls in the Toll Restricted Codes on the list everytime the extension user wants to make such a call.
Setting	call features configuration 2.5.1 & 2.5.2

## Toll Call Security Code

Description	An extension can be permitted to Toll access as set by entering a 4-digit security code before dialing.
Setting	call features configuration 2.5.3

# Call Features Configuration

## 1) Call Features Configuration by Computer (see PC Programming guide)

## 2) Call Features Configuration by Handset

### Start Call Features Configuration

System configuration can be programmed at the Extension 0.

1. Press the **MENU** Button and press up/down arrow to select “system config”.
2. Press the soft key “SELECT” to confirm. The system will download the data to the extension.

1 <sup>st</sup> Row	< M A I N M E N U >
2 <sup>nd</sup> Row	r e g i s t e r
3 <sup>rd</sup> Row	s y s t e m c o n f i g
4 <sup>th</sup> Row	B A C K S E L E C T

Prompt for password if Password Enabled, Press OK to confirm.

Password setting : see system configuration 1.5.

1 <sup>st</sup> Row	P a s s w o r d R e q u i r e
2 <sup>nd</sup> Row	
3 <sup>rd</sup> Row	p a s s w o r d : * * <input type="text"/>
4 <sup>th</sup> Row	B A C K D E L O K

3. Set up the required application via the user friendly Main Menu & its Sub Menu.

### Main Menu

1 <sup>st</sup> Row	< S y s t e m C o n f i g >
2 <sup>nd</sup> /3 <sup>rd</sup> Row	b a s i c s e t u p
	a d v a n c e d s e t u p
	v o i c e m a i l / a a
	h a n d s e t m a n a g e
	t e c h n i c a l
4 <sup>th</sup> Row	B A C K S E L E C T

Press up/down arrow to select and press ‘Select’ to confirm

4. When you finish all required setting, press the soft key ‘BACK’ until the screen appears as shown below :

<b>1<sup>st</sup> Row</b>	
<b>2<sup>nd</sup> Row</b>	<b>S u r e t o E x i t ?</b>
<b>3<sup>rd</sup> Row</b>	
<b>4<sup>th</sup> Row</b>	<b>N o Y e s</b>

<b>1<sup>st</sup> Row</b>	<b>S a v e t h e n e w</b>
<b>2<sup>nd</sup> Row</b>	<b>s e t t i n g s ?</b>
<b>3<sup>rd</sup> Row</b>	
<b>4<sup>th</sup> Row</b>	<b>N o Y e s</b>

5. You have to select ‘Yes’ to confirm ‘Exit Setting’ and ‘Save new settings’. Then the new setting will upload to the Main Control Base. The screen will return to normal when it completes.

## Menu Hierarchy

### 1. Basic Setup

#### 1.1 Time

- 1.1.1- Set Time/Date
- 1.1.2- Set Time Format
- 1.1.3- Set Date Format
- 1.1.4- Set Daylight Saving
- 1.1.5- Set CID update

#### 1.2 Outgoing Call

#### 1.3 Incoming Call

#### 1.4 Tone/Pulse Dialing

#### 1.5 Password

- Set Password Enable/Disable
- Set System Password

### 2. Advanced Call Features

#### 2.1 Day/Night Mode Selection

- 2.1.1 Day/Night mode Enable
- 2.1.2 Night Mode start/end Selection

#### 2.2 Line Mode

2.2.1 Line Selection

2.2.2 Line Mode Selection

2.2.2.1 Normal (Extension Selection for receiving and making call)

2.2.2.2 Line out only (Extension for making call)

2.2.2.3 Auto Call Distribute (ACD) (Extension Selection for receiving and making call)

2.2.2.4 Line Disabled

2.3 Line to Line Forward (Forward Number Selection)

2.4 ACD Mode Selection

2.5 Toll restriction

2.5.1 Restricted Extension

2.5.2 Restricted Numbers

2.5.3 Toll Enabled Password

3. Voice Mail

3.1 Voice Mail Setting

3.1.1 Password Change

3.1.2 Max Recording Time

3.1.3 Max Message No

3.1.4 Greeting Time

3.1.5 Sound Level

3.1.6 Silence Detect

3.1.7 Route to AA

3.1.8 Min Duration

3.2 Auto Attendance Setting

3.2.1 Afternoon Mode

3.2.2 AA Timeout

3.2.3 Supervisor Password

4. Handset Management

4.1 Edit User Name

4.2 Delete Extension

5. Technical Setting

5.1 Technical Default

5.2 Call Setting

5.2.1 Call Hold Recall Time

5.2.2 Automatic Call Transfer

5.3 Technical Setting (Password protected, authorized personnel only)

- 5.3.1 Flash Time Duration
- 5.3.2 Pause Time Duration
- 5.3.3 No Answer Count
- 5.3.4 Line to Line Forward Time Limit
- 5.3.5 Stop Ring Hold Time
- 5.3.6 Tone DTMF Level Low Group
- 5.3.7 Tone DTMF Level High Group
- 5.3.8 Pulse Dial Speed
- 5.3.9 Pulse Make Ratio
- 5.3.10 PCM Incoming Gain
- 5.3.11 PCM Outgoing Gain

5.4 Restore Factory Default

## System Configuration Menu

### Main Menu

1 <sup>st</sup> Row	< S y s t e m C o n f i g >
2 <sup>nd</sup> /3 <sup>rd</sup> Row	b a s i c s e t u p
	a d v a n c e d s e t u p
	v o i c e m a i l / a a h a n d s e t m a n a g e t e c h n i c a l
4 <sup>th</sup> Row	B A C K S E L E C T

Press up/down arrow to select and press ‘Select’ to confirm

### 1 Basic Setup

1 <sup>st</sup> Row	< B a s i c S e t u p >
2 <sup>nd</sup> /3 <sup>rd</sup> Row	t i m e s e t t i n g
	o u t c a l l i n c a l l t o n e / p u l s e p a s s w o r d
	4 <sup>th</sup> Row

Press up/down arrow to select and press ‘Select’ to confirm



## 1.1 TIME

1 <sup>st</sup> Row	< T i m e S e t t i n g >
2 <sup>nd</sup> /3 <sup>rd</sup> Row	s e t t i m e / d a t e
	s e t t i m e f o r m a t
	s e t d a t e f o r m a t
	d a y l i g h t s a v i n g c i d u p d a t e
4 <sup>th</sup> Row	B A C K S E L E C T

### 1.1.1 Set Time/Date

1 <sup>st</sup> Row	S e t t i m e / d a t e
2 <sup>nd</sup> /3 <sup>rd</sup> Row	T i m e : 1 1 : 3 0 a m
	D a t e : 0 4 - 1 5 - 2 0 0 3
	W e e k : T u e
4 <sup>th</sup> Row	B A C K N E X T O K

Press “NEXT” to change the current field. Press up/down to change value. Press “OK” to confirm all settings

### 1.1.2 Set Time Format

1 <sup>st</sup> Row	< S e t T i m e F o r m a t
2 <sup>nd</sup> Row	1 ) 1 2 h o u r <
3 <sup>rd</sup> Row	2 ) 2 4 h o u r
4 <sup>th</sup> Row	B A C K S E L E C T

“<”show the current status. Press up/down to select and press “SELECT” to confirm.

### 1.1.3 Set Date Format

1 <sup>st</sup> Row	< S e t D a t e F o r m a t
2 <sup>nd</sup> /3 <sup>rd</sup> Row	1 ) m m - d d - y y y y <
	2 ) m m m - d d - y y y y
	3 ) d d - m m - y y y y
	4 ) d d - m m m - y y y y
4 <sup>th</sup> Row	B A C K S E L E C T

“<”show the current status. Press up/down to select and press “SELECT” to confirm.

### 1.1.4 Set Daylight Saving

1 <sup>st</sup> Row	< D a y l i g h t S a v i n g
2 <sup>nd</sup> Row	1 ) o f f <
3 <sup>rd</sup> Row	2 ) o n
4 <sup>th</sup> Row	B A C K S E L E C T

“<”show the current status. Press up/down to select and press “SELECT” to confirm.

This sets the clock one hour ahead for daylight savings in some countries.

### 1.1.5 CID Update

1 <sup>st</sup> Row	< C I D U p d a t e >
2 <sup>nd</sup> Row	1 ) o n <
3 <sup>rd</sup> Row	2 ) o f f
4 <sup>th</sup> Row	B A C K S E L E C T

“<”show the current status. Press up/down to select and press “SELECT” to confirm.

Incoming calls with caller ID service can automatically update the time and date of system clock.

## 1.2 Outgoing Call

1 <sup>st</sup> Row	E x t c a n m a k e
2 <sup>nd</sup> Row	c a l l o n a l l l i n e
3 <sup>rd</sup> Row	E x t : 0 1 2 3 4 5 6 7 8 9
4 <sup>th</sup> Row	B A C K O K

Press 0 to 9 to toggle the extension. Press “OK” to confirm all settings

Default: all extensions can make outgoing call.

## 1.3 Incoming Call

1 <sup>st</sup> Row	E x t w i l l r i n g
2 <sup>nd</sup> Row	o n a l l l i n e
3 <sup>rd</sup> Row	E x t : 0 1 - 3 4 5 6 7 - -
4 <sup>th</sup> Row	B A C K O K

Press 1 to 9 to toggle the extension. The setting will be applied to both day and night mode.

Press “OK” to confirm all settings

Default: all extensions will ring for all incoming calls. **Ext 0 should be always ringing.**

For both 1.2 & 1.3 , when “OK” is pressed, the following screen shall be appeared to remind

the user that the Advanced Setting will be affected.

1 <sup>st</sup> Row	W a r n i n g : A d v a n c e d
2 <sup>nd</sup> Row	S e t t i n g w i l l b e
3 <sup>rd</sup> Row	a f f e c t e d
4 <sup>th</sup> Row	B A C K O K

If ‘BACK’ is pressed, then the change shall be cancelled.

## 1.4 Tone/Pulse Dialing

1 <sup>st</sup> Row	< T o n e / P u l s e >
2 <sup>nd</sup> Row	1 ) t o n e <
3 <sup>rd</sup> Row	2 ) p u l s e
4 <sup>th</sup> Row	B A C K S E L E C T

“<” show the current status. Press up/down to select and press ‘SELECT’ to confirm.

It is a dialing mode. Normally the operator offers the tone.

## 1.5 Password

1 <sup>st</sup> Row	< P a s s w o r d >
2 <sup>nd</sup> Row	e n a b l e / d i s a b l e
3 <sup>rd</sup> Row	c h a n g e p a s s w o r d
4 <sup>th</sup> Row	B A C K S E L E C T

Press up/down arrow to select and press ‘Select’ to confirm

### 1.5.1 Enable/Disable Password

1 <sup>st</sup> Row	< E n a b l e / D i s a b l e >
2 <sup>nd</sup> Row	1 ) o f f <
3 <sup>rd</sup> Row	2 ) o n
4 <sup>th</sup> Row	B A C K S E L E C T

“<” show the current status. Press up/down to select and press ‘SELECT’ to confirm. Default:

Password disable (off).

When ‘on’ is selected, the system password is enabled. It is effective when entering the system configuration by the phone.

### 1.5.2 Change Password

1 <sup>st</sup> Row	P a s s w o r d C h a n g e
2 <sup>nd</sup> Row	
3 <sup>rd</sup> Row	P a s s w o r d : 1 2 3 4
4 <sup>th</sup> Row	B A C K D E L O K

Input 4 digit password when you select Password enabled.

Default: blank

## 2 Advanced Call Features

1 <sup>st</sup> Row	A d v a n c e d S e t u p
2 <sup>nd</sup> /3 <sup>rd</sup> Row	d a y / n i g h t m o d e
	l i n e m o d e
	l i n e - t o - l i n e
	a c d o p t i o n s
	t o l l r e s t r i c t
4 <sup>th</sup> Row	B A C K S E L E C T

Press up/down arrow to select and press ‘Select’ to confirm

### 2.1 Day/Night mode

1 <sup>st</sup> Row	< D a y / N i g h t M o d e >
2 <sup>nd</sup> Row	e n a b l e n m
3 <sup>rd</sup> Row	n m a u t o m a t i o n
4 <sup>th</sup> Row	B A C K S E L E C T

Press up/down arrow to select and press ‘Select’ to confirm

#### 2.1.1 Enable night mode

1 <sup>st</sup> Row	< E n a b l e N M >
2 <sup>nd</sup> Row	1 ) o f f <
3 <sup>rd</sup> Row	2 ) o n
4 <sup>th</sup> Row	B A C K S E L E C T

If ‘on’ is selected, you can set Day / Night mode manually according to your selection in the ‘Menu → Call Setting → Day/Night Mode’ via the extension 0, or if night mode automation (on) is also selected, the system follows the automatic mode.

### 2.1.2 Night mode Automation

1 <sup>st</sup> Row	< N M A u t o m a t i o n >
2 <sup>nd</sup> Row	1 ) o f f <
3 <sup>rd</sup> Row	2 ) o n
4 <sup>th</sup> Row	B A C K S E L E C T

If nm automation (on) is selected, then night mode time shall be appeared for setting.

#### Set Night mode time

1 <sup>st</sup> Row	N i g h t M o d e
2 <sup>nd</sup> Row	S t a r t : 0 5 : 3 0 p m
3 <sup>rd</sup> Row	E n d : 0 8 : 0 0 a m
4 <sup>th</sup> Row	B A C K N E X T O K

Press up/down to change value, press next to change field. Press ‘OK’ to confirm all settings in the fields.

## 2.2. Line Mode

### 2.2.1 Line Selection

1 <sup>st</sup> Row	L i n e S e l e c t i o n
2 <sup>nd</sup> Row	P r e s s 1 , 2 o r 3
3 <sup>rd</sup> Row	L i n e : L 1 L 2 L 3
4 <sup>th</sup> Row	B A C K O K

Press 1, 2 or 3 to toggle the Line selected.

Then with the following selection

### 2.2.2 Line Mode Selection

1 <sup>st</sup> Row	< M o d e S e l e c t i o n >
2 <sup>nd</sup> /3 <sup>rd</sup> Row	n o r m a l m o d e
	l i n e o u t o n l y
	c a l l d i s t r i b u t e
	l i n e d i s a b l e d
4 <sup>th</sup> Row	B A C K S E L E C T

Press up/down arrow to select and press ‘Select’ to confirm

### 2.2.2.1 Normal mode

1 <sup>st</sup> Row	E x t w i l l r i n g
2 <sup>nd</sup> Row	o n l i n e 1
3 <sup>rd</sup> Row	D a y : 0 1 2 3 4 5 6 7 8 9
4 <sup>th</sup> Row	B A C K O K

The LCD will show the line no. you selected for extension receiving call. Press 1 to 9 to toggle extension selection. **Ext 0 should be always ringing.**

If night mode is enabled that set at ‘2.1.1’, the extension for both day/night modes are allowed to select. Press up/down to select the ‘Day’ or ‘Night’.

Press “OK” to confirm all settings.

Then the LCD will show the next line no. you selected. Repeat same procedure for settings until you complete all lines you selected.

Press “OK” to confirm all settings and the following screen will appear.

1 <sup>st</sup> Row	E x t c a n m a k e
2 <sup>nd</sup> Row	c a l l o n l i n e 1
3 <sup>rd</sup> Row	E x t : 0 1 2 3 4 5 6 7 8 9
4 <sup>th</sup> Row	B A C K O K

Press 1 to 9 to toggle extension selection. Press “OK” to confirm. Repeat same procedure for settings until you complete all lines you selected.

### 2.2.2.2 Line out Only

1 <sup>st</sup> Row	E x t c a n m a k e
2 <sup>nd</sup> Row	c a l l o n l i n e 1
3 <sup>rd</sup> Row	E x t : 0 1 2 3 4 5 6 7 8 9
4 <sup>th</sup> Row	B A C K O K

Press 1 to 9 to toggle extension selection. Press “OK” to confirm. Repeat same procedure for settings until you complete all lines you selected.

### 2.2.2.3 Call Distribute

1 <sup>st</sup> Row	E x t w i l l r i n g
2 <sup>nd</sup> Row	o n A C D l i n e
3 <sup>rd</sup> Row	D a y : 0 1 2 3 4 5 6 7 8 9
4 <sup>th</sup> Row	B A C K O K

If night mode is enabled, then extension selection for both day/night modes is allowed,

otherwise, only ‘Day’ is shown for selection.

Press up/down to select the line Day / Night. Press 1 to 9 to toggle extension selection. **Ext 0 should be always ringing.**

Press ‘OK’ to confirm all settings and the following screen will appear.

1 <sup>st</sup> Row	E x t c a n m a k e
2 <sup>nd</sup> Row	c a l l o n A C D l i n e
3 <sup>rd</sup> Row	E x t : 0 1 2 3 4 5 6 7 8 9
4th Row	B A C K O K

Press 1 to 9 to toggle extension selection. Press ‘OK’ to confirm.

#### 2.2.2.4 Disable Line

1 <sup>st</sup> Row	L i n e D i s a b l e d
2 <sup>nd</sup> Row	o n
3 <sup>rd</sup> Row	L i n e : L 2 L 3
4th Row	B A C K O K

Display the selection and let user to press ‘OK’ to confirm.

### 2.3 Line to Line

1 <sup>st</sup> Row	E n t e r F W D n u m b e r
2 <sup>nd</sup> Row	
3 <sup>rd</sup> Row	
4th Row	B A C K D E L O K

Prompt for number and max allowed 32 digits. Press ‘DEL’ for backspace. Press ‘OK’ to confirm.

### 2.4 ACD Options

1 <sup>st</sup> Row	< A C D B y >
2 <sup>nd</sup> Row	1 ) l o n g e s t i d l e <
3 <sup>rd</sup> Row	2 ) c i r c u l a r
4th Row	B A C K S E L E C T

“<” show the current status. Press up/down to select and press ‘SELECT’ to confirm. Default: longest idle

## 2.5 Toll Restriction

<b>1<sup>st</sup> Row</b>	<b>&lt; T o l l R e s t r i c t &gt;</b>
<b>2<sup>nd</sup>/3<sup>rd</sup> Row</b>	<b>r e s t r i c t e d e x t</b>
	<b>r e s t r i c t n u m b e r</b> <b>e n a b l e p a s s w o r d</b>
<b>4th Row</b>	<b>B A C K S E L E C T</b>

Press up/down to select.

### 2.5.1 Restricted Extension

<b>1<sup>st</sup> Row</b>	<b>T o l l R e s t r i c t e d</b>
<b>2<sup>nd</sup> Row</b>	<b>e x t e n s i o n</b>
<b>3<sup>rd</sup> Row</b>	<b>E x t : 0 1 2 3 4 5 6 7 8 9</b>
<b>4th Row</b>	<b>B A C K S E L E C T</b>

Press 0 to 9 to toggle the extension. .Press OK to confirm Default: all extensions are restricted.

The restricted extensions will require the input of a password as set in 2.5.3 for making calls in the Toll Restricted Codes on the list everytime the extension user wants to make such a call. (Menu →Call Setting→ Make Toll call)

### 2.5.2 Restricted Number

<b>1<sup>st</sup> Row</b>	<b>R e s t r i c t e d C o d e</b>
<b>2<sup>nd</sup>/3<sup>rd</sup> Row</b>	<b>S e t 1 : <input type="text"/></b>
	<b>S e t 2 : <input type="text"/></b>
	<b>S e t 3 : <input type="text"/></b>
<b>4th Row</b>	<b>B A C K D E L O K</b>

Three sets of code (e.g. Toll Call Access code) can be set restricted. Press up/down to select which set to be entered. Input a number of digit not greater than 4. Press “DEL” for backspace.

### 2.5.3 Enable password

<b>1<sup>st</sup> Row</b>	<b>T o l l E n a b l e</b>
<b>2<sup>nd</sup> Row</b>	<b>P a s s w o r d</b>
<b>3<sup>rd</sup> Row</b>	<b>P a s s w o r d : <input type="text"/></b>
<b>4th Row</b>	<b>B A C K D E L O K</b>

Input a number of digit equal to 4 for password. Press “DEL” for backspace. Blank means that it does not allow password override.



### 3 Voice Mail / AA

1 <sup>st</sup> Row	< V O I C E M A I L / A A >
2 <sup>nd</sup> Row	v o i c e m a i l
3 <sup>rd</sup> Row	a u t o a t t e n d a n t
4 <sup>th</sup> Row	B A C K S E L E C T

Press up/down arrow to select and press ‘Select’ to confirm

### 3.1 VOICE MAIL

1 <sup>st</sup> Row	< V O I C E M A I L >
2 <sup>nd</sup> /3 <sup>rd</sup> Row	p a s s w o r d c h a n g e
	m a x r e c o r d t i m e
	m a x m e s s a g e N o
	g r e e t i n g t i m e
	s o u n d l e v e l
	s i l e n c e d e t e c t
	r o u t e t o a a
m i n d u r a t i o n	
4 <sup>th</sup> Row	B A C K S E L E C T

Press up/down arrow to select and press ‘Select’ to confirm

#### 3.1.1 Password Change

1 <sup>st</sup> Row	P a s s w o r d
2 <sup>nd</sup> Row	E x t e n s i o n : 0
3 <sup>rd</sup> Row	p a s s w o r d :
4 <sup>th</sup> Row	B A C K D E L O K

Press up/down arrow to select extension (0-9). Input / edit a number of 4 digit password. 0000 is reserved for the system. Press ‘OK’ to confirm. There is no default password in Ex-factory setting.

#### 3.1.2 Max Recording

1 <sup>st</sup> Row	M a x R e c o r d i n g
2 <sup>nd</sup> Row	T i m e
3 <sup>rd</sup> Row	V a l u e : 6 0 s e c <
4 <sup>th</sup> Row	B A C K O K

Press up/down arrow to select setting. Press OK to confirm.

Range: 10-240 sec

Default: 60

Step size: 10

### 3.1.3 Max Message Number, per Voice Box

<b>1<sup>st</sup> Row</b>	<b>M a x M e s s a g e N O</b>
<b>2<sup>nd</sup> Row</b>	<b>P e r V o i c e B o x</b>
<b>3<sup>rd</sup> Row</b>	<b>V a l u e : 2 4 0 &lt;</b>
<b>4<sup>th</sup> Row</b>	<b>B A C K O K</b>

Press up/down arrow to select setting. Press OK to confirm.

Range: 20-240

Default: 240

Step size: 20

### 3.1.4 Max Recording Time for Greeting

<b>1<sup>st</sup> Row</b>	<b>M a x R e c o r d T i m e</b>
<b>2<sup>nd</sup> Row</b>	<b>F o r G r e e t i n g</b>
<b>3<sup>rd</sup> Row</b>	<b>V a l u e : 6 0 s e c &lt;</b>
<b>4<sup>th</sup> Row</b>	<b>B A C K O K</b>

Press up/down arrow to select and press OK to confirm.

Range: 10-120 sec

Default: 60

Step size: 10

### 3.1.5 Announcement Sound Level

<b>1<sup>st</sup> Row</b>	<b>A n n o u n c e m e n T</b>
<b>2<sup>nd</sup> Row</b>	<b>S o u n d L e v e l</b>
<b>3<sup>rd</sup> Row</b>	<b>V a l u e : 1 3 &lt;</b>
<b>4<sup>th</sup> Row</b>	<b>B A C K O K</b>

Press up/down arrow to select setting. Press OK to confirm.

Range: 0-31 sec

Default: 13

Step size: 1

### 3.1.6 Silence detect

<b>1<sup>st</sup> Row</b>	<b>S i l e n c e d e t e c t</b>
<b>2<sup>nd</sup> Row</b>	<b>1 ) o f f &lt;</b>
<b>3<sup>rd</sup> Row</b>	<b>2 ) o n</b>
<b>4<sup>th</sup> Row</b>	<b>B A C K O K</b>

Press up/down arrow to select setting. Press OK to confirm.

When 'on' is selected, recording will be stopped when 6 seconds of silence is detected.

### 3.1.7 Route to AA

1 <sup>st</sup> Row	< R o u t e t o A A >
2 <sup>nd</sup> Row	1 ) o f f <
3 <sup>rd</sup> Row	2 ) o n
4 <sup>th</sup> Row	B A C K O K

Press up/down arrow to select setting. Press ‘OK’ to confirm.

When ‘on’ is selected, after a caller has listened to the personal greeting message and in addition to leaving a message, he/she can press the [0] key to go back to auto attendant for selecting other extensions.

### 3.1.8 Min Message Duration

1 <sup>st</sup> Row	M i n M e s s a g e
2 <sup>nd</sup> Row	D u r a t i o n
3 <sup>rd</sup> Row	V a l u e : 3 s e c <
4 <sup>th</sup> Row	B A C K O K

Press up/down arrow to select setting. Press OK to confirm.

Range: 1-8 sec

Default: 3

Step size: 1

## 3.2 Auto Attendant

1 <sup>st</sup> Row	< A u t o A t t e n d a n t >
2 <sup>nd</sup> /3 <sup>rd</sup> Row	a f t e r n o o n m o d e
	a a t i m e o u t s u p e r p a s s w o r d
4 <sup>th</sup> Row	B A C K S E L E C T

Press up/down arrow to select setting. Press ‘Select’ to confirm

### 3.2.1 Afternoon mode

1 <sup>st</sup> Row	< A f t e r n o o n M o d e >
2 <sup>nd</sup> Row	1 ) o f f <
3 <sup>rd</sup> Row	2 ) o n
4 <sup>th</sup> Row	B A C K O K

Press up/down arrow to select setting. Press ‘OK’ to confirm.

If you have enabled this function, the afternoon greeting will be activated automatically at 12:00. (Note : an afternoon greeting should be recorded for this feature.)

### 3.2.2 Announcement Silent Timeout

1 <sup>st</sup> Row	A n n o u n c e m e n t
2 <sup>nd</sup> Row	S i l e n t T i m e o u t
3 <sup>rd</sup> Row	V a l u e : 5 s e c <
4 <sup>th</sup> Row	B A C K O K

Press up/down arrow to select setting. Press “OK” to confirm.

Range: 1-10 sec                      Default: 5                      Step size: 1

If the caller does not enter an extension within a specified time after announcement, then the mail box 0 will be opened for the caller to leave a message.

### 3.2.3 Supervisor Password

1 <sup>st</sup> Row	S u p e r v i s o r
2 <sup>nd</sup> Row	p a s s w o r d :
3 <sup>rd</sup> Row	p a s s w o r d :
4 <sup>th</sup> Row	B A C K D E L O K

Input / edit 3 digit password. Press “OK” to confirm..

The System Administrator can use this password enter the administrator menu of the system from a remote phone call and do some global modifications on voice mail parameters. (see details in the Configuration Guide – Administration by Phone)

## 4 Handset Manage

1 <sup>st</sup> Row	< H a n d s e t M a n a g e >
2 <sup>nd</sup> Row	1 E d i t U s e r N a m e
3 <sup>rd</sup> Row	2 D e l e t e U s e r
4 <sup>th</sup> Row	B A C K S E L E C T

Press up/down arrow to select setting. Press “Select” to confirm.

### 4.1 Edit User Name

1 <sup>st</sup> Row	E d i t U s e r N a m e
2 <sup>nd</sup> Row	E x t e n s i o n : 0
3 <sup>rd</sup> Row	B O
4 <sup>th</sup> Row	B A C K D E L O K

Press up/down arrow to select the extension. Input name by using dial keypad. Press “DEL” to delete the last word. Press “OK” to confirm when all selected extensions are completed.

The name is a maximum of 12 alpha numeric characters.

## 4.2 Delete User

1 <sup>st</sup> Row	D e l e t e U s e r
2 <sup>nd</sup> Row	E x t e n s i o n : 1
3 <sup>rd</sup> Row	A B C
4 <sup>th</sup> Row	B A C K D E L

Press up/down arrow to select the extension. Press ‘DEL’ to delete the user.

The handset will become unregistered.

## 5 Technical Setting

1 <sup>st</sup> Row	< T e c h n i c a l >
2 <sup>nd</sup> /3 <sup>rd</sup> Row	t e c h d e f a u l t
	c a l l s e t t i n g
	t e c h s e t t i n g
	f a c t o r y d e f a u l t
4 <sup>th</sup> Row	B A C K S E L E C T

### 5.1 Restore Technical Default

1 <sup>st</sup> Row	R e s t o r e D e f a u l t
2 <sup>nd</sup> Row	T e c h n i c a l
3 <sup>rd</sup> Row	S e t t i n g ?
4 <sup>th</sup> Row	B A C K O K

Press ‘OK’ to confirm. Then the following screen will acknowledge the setting restored.

1 <sup>st</sup> Row	T e c h n i c a l
2 <sup>nd</sup> Row	S e t t i n g R e s t o r e d
3 <sup>rd</sup> Row	
4 <sup>th</sup> Row	O K

Press ‘OK’ to return to previous sub -menu.

### 5.2 Call Setting

1 <sup>st</sup> Row	C a l l S e t t i n g
2 <sup>nd</sup> Row	h o l d r e c a l l
3 <sup>rd</sup> Row	a u t o c a l l t x f r
4 <sup>th</sup> Row	B A C K S E L E C T

Press up/down to select different menu

### 5.2.1 Hold Recall Timer

After the call time out, the extension putting a call on hold or transferring a call to a no answer extension will be recall.

<b>1<sup>st</sup> Row</b>	<b>H o l d R e c a l l</b>
<b>2<sup>nd</sup> Row</b>	<b>H i t u p / d o w n k e y</b>
<b>3<sup>rd</sup> Row</b>	<b>V a l u e : 2 0 S e c &lt;</b>
<b>4<sup>th</sup> Row</b>	<b>B A C K O K</b>

Press up/down arrow to change value.

Range: 10-90 sec

Default: 20

Step size: 10

### 5.2.2 Call Auto Transfer

<b>1<sup>st</sup> Row</b>	<b>&lt; A u t o C a l l T x f r</b>
<b>2<sup>nd</sup> Row</b>	<b>1 ) o f f</b>
<b>3<sup>rd</sup> Row</b>	<b>2 ) o n &lt;</b>
<b>4<sup>th</sup> Row</b>	<b>B A C K S E L E C T</b>

Press up/down arrow to change value.

Default: on

When an extension is on a line call, first hold and call the destination extension number and then go on-hook, it will activate ring-inward transfer automatically. It is not required to press transfer key.

## 5.3 Technical Setting (Password protected, authorized personnel only)

<b>1<sup>st</sup> Row</b>	<b>&lt; T e c h S e t t i n g &gt;</b>
<b>2<sup>nd</sup>/3<sup>rd</sup> Row</b>	<b>f l a s h d u r a t i o n</b>
	<b>p a u s e d u r a t i o n</b>
	<b>n o a n s w e r c o u n t</b>
	<b>t r u n k f w d l i m i t</b>
	<b>r i n g s t o p t i m e</b>
	<b>d t m f l e v e l l o w</b>
	<b>d t m f l e v e l h i g h</b>
	<b>p u l s e s p e e d</b>
	<b>p u l s e m a k e</b>
	<b>o u t g o i n g g a i n</b>
<b>i n c o m i n g g a i n</b>	
<b>4<sup>th</sup> Row</b>	<b>B A C K S E L E C T</b>

Press up/down to select different menu.

### 5.3.1 Flash time duration

1 <sup>st</sup> Row	F I a s h      D u r a t i o n
2 <sup>nd</sup> Row	H i t      u p / d o w n      k e y
3 <sup>rd</sup> Row	V a l u e : 6 0 0 m S e c      <
4 <sup>th</sup> Row	B A C K      O K

Press up/down arrow to change value.

Activates the special features provided by your telephone company.

Range: 50-950 sec

Default: 500

Step size: 50

### 5.3.2 Pause Duration

1 <sup>st</sup> Row	P a u s e      D u r a t i o n
2 <sup>nd</sup> Row	H i t      u p / d o w n      k e y
3 <sup>rd</sup> Row	V a l u e : 3 . 0 S e c      <
4 <sup>th</sup> Row	B A C K      O K

Press up/down arrow to change value.

Insert the pause time in the phone number when required.

Range: 0.5-4.5 sec

Default: 3.0

Step size: 0.5

### 5.3.3 No Answer Count

1 <sup>st</sup> Row	N o      A n s w e r      C o u n t
2 <sup>nd</sup> Row	H i t      u p / d o w n      k e y
3 <sup>rd</sup> Row	V a l u e : 3      R i n g      <
4 <sup>th</sup> Row	B A C K      O K

Press up/down arrow to change value.

Range: 1-9

Default: 3

Step size: 1

### 5.3.4 Line to Line forward time limit

1 <sup>st</sup> Row	L I N E      T O      L I N E
2 <sup>nd</sup> Row	F W D      T i m e      L i m i t
3 <sup>rd</sup> Row	V a l u e : 2 5 0 S e c      <
4 <sup>th</sup> Row	B A C K      O K

Press up/down arrow to change value.

Range: 0-375 sec

Default: 250

Step size: 25

### 5.3.5 Ring Stop time

1 <sup>st</sup> Row	R i n g S t o p t i m e
2 <sup>nd</sup> Row	H i t u p / d o w n k e y
3 <sup>rd</sup> Row	V a l u e : 3 . 0 S e c <
4 <sup>th</sup> Row	B A C K O K

Press up/down arrow to change value.

Range: 1-10 sec

Default: 3

Step size: 0.5

### 5.3.6 DTMF level Low Group

1 <sup>st</sup> Row	D T M F L e v e l L o w
2 <sup>nd</sup> Row	H i t u p / d o w n k e y
3 <sup>rd</sup> Row	V a l u e : 2 3 <
4 <sup>th</sup> Row	B A C K O K

Press up/down arrow to change value.

Range: 0-31

Default: 23

Step size: 1

### 5.3.7 DTMF Level High Group

1 <sup>st</sup> Row	D T M F L e v e l H i g h
2 <sup>nd</sup> Row	H i t u p / d o w n k e y
3 <sup>rd</sup> Row	V a l u e : 3 1 <
4 <sup>th</sup> Row	B A C K O K

Press up/down arrow to change value.

Range: 0-31 sec

Default: 31

Step size: 1

### 5.3.8 Pulse Dial Speed

1 <sup>st</sup> Row	P u l s e S p e e d
2 <sup>nd</sup> Row	H i t u p / d o w n k e y
3 <sup>rd</sup> Row	V a l u e : 1 0 P P S <
4 <sup>th</sup> Row	B A C K O K

Press up/down arrow to change value.

Range: 10 or 20 pps

Default: 10

### 5.3.9 Pulse make ratio

1 <sup>st</sup> Row	P u l s e M a k e
2 <sup>nd</sup> Row	H i t u p / d o w n k e y
3 <sup>rd</sup> Row	V a l u e : 3 9 % <



<b>4<sup>th</sup> Row</b>	<b>B A C K</b>	<b>O K</b>
---------------------------	----------------	------------

Press up/down arrow to change value.

Range: 33 or 39 %                      Default: 39

### 5.3.10 PCM Incoming gain - from PSTN to PCM

<b>1<sup>st</sup> Row</b>	<b>I n c o m i n g            G a i n</b>
<b>2<sup>nd</sup> Row</b>	<b>H i t            u p / d o w n            k e y</b>
<b>3<sup>rd</sup> Row</b>	<b>V a l u e :            8</b>
<b>4<sup>th</sup> Row</b>	<b>B A C K                                      O K</b>

Press up/down arrow to change value.

Range: 0-15                                  Default: 8                                  Step size: 1

### 5.3.11 PCM Outgoing gain - From PCM to PSTN

<b>1<sup>st</sup> Row</b>	<b>O u t g o i n g            G a i n</b>
<b>2<sup>nd</sup> Row</b>	<b>H i t            u p / d o w n            k e y</b>
<b>3<sup>rd</sup> Row</b>	<b>V a l u e :            8</b>
<b>4<sup>th</sup> Row</b>	<b>B A C K                                      O K</b>

Press up/down arrow to change value.

Range: 0-15 sec                              Default: 8                                  Step size: 1

## 5.4 Restore Factory Default

<b>1<sup>st</sup> Row</b>	<b>R e s t o r e            S e t t i n g s</b>
<b>2<sup>nd</sup> Row</b>	<b>T o            F a c t o r y</b>
<b>3<sup>rd</sup> Row</b>	<b>D e f a u l t ?</b>
<b>4<sup>th</sup> Row</b>	<b>B A C K                                      O K</b>

When “OK” is pressed, the following screen shall be appeared to remind all user configuration will be erased and restore factory default.

However, the user name & phone book remain the same.

<b>1<sup>st</sup> Row</b>	<b>W a r n i n g :</b>
<b>2<sup>nd</sup> Row</b>	<b>A l l            u s e r            c o n f i g</b>
<b>3<sup>rd</sup> Row</b>	<b>w i l l            b e            e r a s e d !</b>
<b>4<sup>th</sup> Row</b>	<b>B A C K                                      O K</b>

If “BACK” is pressed, then the change shall be cancelled.

# Voice Mail Configuration

## Introduction

The Interactive Voice Response (IVR) function is a built in feature in the Cordless Telephone System. It integrates voice mail, auto attendant, and day / night modes solutions. The target of IVR is to meet all the voice processing requirements in today's SOHO communications.

The system uses digital recording and non-volatile memory making it advanced, innovative and reliable equipment.

## Features

### Voice Mail

- Personal Greeting
- Time Stamp
- Message Waiting Notification
- Remote access to mailbox
- Menu browse and selection of voice mail
- Incoming Call Direct Transfer to Mailbox

### Auto Attendant

- Operator Backup
- Day / Night Mode
- Automatic switch Day / Night Mode

### Multi-level Interactive Voice Response

- Multi-level announcements
- Voice message, call Transfer, single digit menu functions
- Maximum allowable time for incoming call

# Voice Mail

## Related Setting by Computer (See PC programming Guide)

### Mailbox

The System provides 10 mailboxes. You can attach any user's extension to a mailbox. The mailbox number should be the same as the user's extension number.

### Global Parameters

This defines global parameters for mailboxes. All users should follow these settings.

#### Silence Detection

When selected, recording will be stopped when 6 seconds of silence is detected.

Setting: See call feature configuration: 3.1.7

#### Route to Auto Attendant if "0" pressed

After a caller has listened to the personal greeting message, in addition to leaving a message, he/she can press [0] key to go back to Auto Attendant for calling other extensions or operator.

Setting: See call feature configuration: 3.1.8

#### Minimum Message Duration

To prevent message recorded with only a busy tone (e. g. the caller hangs up the line immediately after greeting) or silence, any message less than 3 seconds (default) will not be stored. Nor will the message waiting acknowledgment be activated in this case. The programming option for this parameter is from 0 (no minimum message feature) to 10 seconds.

Setting: See call feature configuration: 3.1.6

### Other Voice Mail Features

#### Message with Time Stamp

A record of a message's creation date and time can be heard prior to message playback. For example, the message will be announced as 'Message one, Sunday, Ten, Twenty Two PM', and then the voice message will be played.

## **Password for Every Mailbox**

Every mailbox has a 4-digit password and the user can modify it at any time at his/her extension (Menu→Voicemail→Password). There is no default password in Ex-factory setting and the user has to create a password. [0000] is reserved for the system.

If the password is forgotten, it can be changed and reviewed by the System Configuration.

Setting : See call feature configuration: 3.1.1

## **Personal Greeting and Name**

You can record a personal greeting for your mailbox with your own voice to prompt a caller to leave a message in your mailbox.

If you don't want a personal greeting, you can record just your name. Then your name will be played each time when your mailbox is opened.

The priority is higher for the personal greeting over the name if both are recorded.

A system greeting will be played if no personal greeting or name is recorded.

Setting: use the extension to call into the system directly by pressing the Voice Mail key on the WDE or the soft key VM on the WHE when the voice mail indicator is off. (see fig. 17 Mailbox Greeting Recording flow for details)

## **Message Playback Function**

When there is a new message or a memo in a mailbox, the voice mail indicator of that extension will be turned on. (voice mail key for WDE and "MW" icon for WHE's LCD).

A user can preview the voice mail list for caller information, such as date and time of the call. The user can choose which mail to listen to first. (Menu →Voicemail→Browse Mode →all/new memo/all memo/new voice mail/all voice mail/filter/greeting).

Or the user can use the extension to call into the system directly by pressing the Voice Mail key on the WDE or the soft key VM on the WHE.

During playback, a user can go to the next message, repeat a message, delete a message and/or delete all old messages. (see fig. 16 user retrieves messages flow for details)

Operation	Key
Go to next message	3
Repeat current message	2
Delete current message	Double 0
Delete all old messages	Double 8

## Message Copying

The system can copy a message from your mailbox to another mailbox in 2 ways:

- a. When you have listened to a message, you can copy this message to another mailbox. The system will ask you for a mailbox number.
- b. You can also setup the system to copy every incoming message to another mailbox (e. g. executive and assistant pair). In this case, you need to input the destination mailbox number first in user menu. For user menu details, please refer to the section ‘Administration by Phone’.

Setting: see Fig. 18 Set Message Copy flow.

## Remote Access

- c. Mailbox can be accessed remotely. During personal greeting, user can press [\*\*] and then the password, to access the user menu remotely. For user menu details, please refer to the section ‘Administration by Phone’.

Remark: If a mailbox has no password, the remote access feature of that mailbox is disabled for security.

## Verification of Voice Mail Setup

### Leave a Message

1. To test the operation of leaving a message (by a guest) in voice mail service, use another extension or external line to call to a busy or no answer extension. For example, extension X is the owner of mailbox X.
2. Let the call being forwarded to system from extension X (i. e., keep extension X busy or no answer to invoke the busy or no answer call forward to voice mail).
3. Now the system should answer the incoming call.
4. The System should open the mailbox X automatically. The calling party can now leave a message to the mailbox owner X and then hang up.
5. The System will send the new message signal to the extension X to indicate that there is a new message in X mailbox and turn on the Voice Mail indicator (voice mail key for WDE and ‘MW’ icon for WHE’s LCD).

### Retrieve a Message

1. To test the operation of retrieving a message (by mailbox owner) in voice mail service, first record a message. See the above section ‘Leave a Message’.
2. Afterwards, use extension X to call into the system directly by pressing the Voice Mail

- key on the WDE or the soft key VM on the WHE.
- 3. Now the system should answer the incoming call.
- 4. The System should open the user menu of mailbox X for message checking.
- 5. Listen to the new message. After the message is played, hang up.
- 6. The System will send the new message signal to the extension X to indicate that there is no new message in mailbox X and turn off the Voice Mail Indicator.

**Retrieve a Message Remotely**

- 1. To test the operation of retrieving a message (e. g. mailbox owner is at home) by an external line in voice mail service, first record a message. See the section ‘Leave a Message’.
- 2. Afterwards, use an external line to call inside the system.
- 3. Now the system should answer the incoming call.
- 4. Press [\*\*] when a welcome greeting is playing, the system will ask the caller for a mailbox number and password. Enter X plus the correct password and then the system will open the user menu of mailbox X.
- 5. Listen to the new message. After the message has played, hang up.
- 6. The System will send the new message signal to the extension X to indicate that there is no new message in mailbox X and turn off the Voice Mail Indicator..

**Voice Mail Operation Flow**

**Caller Leaves a Message**

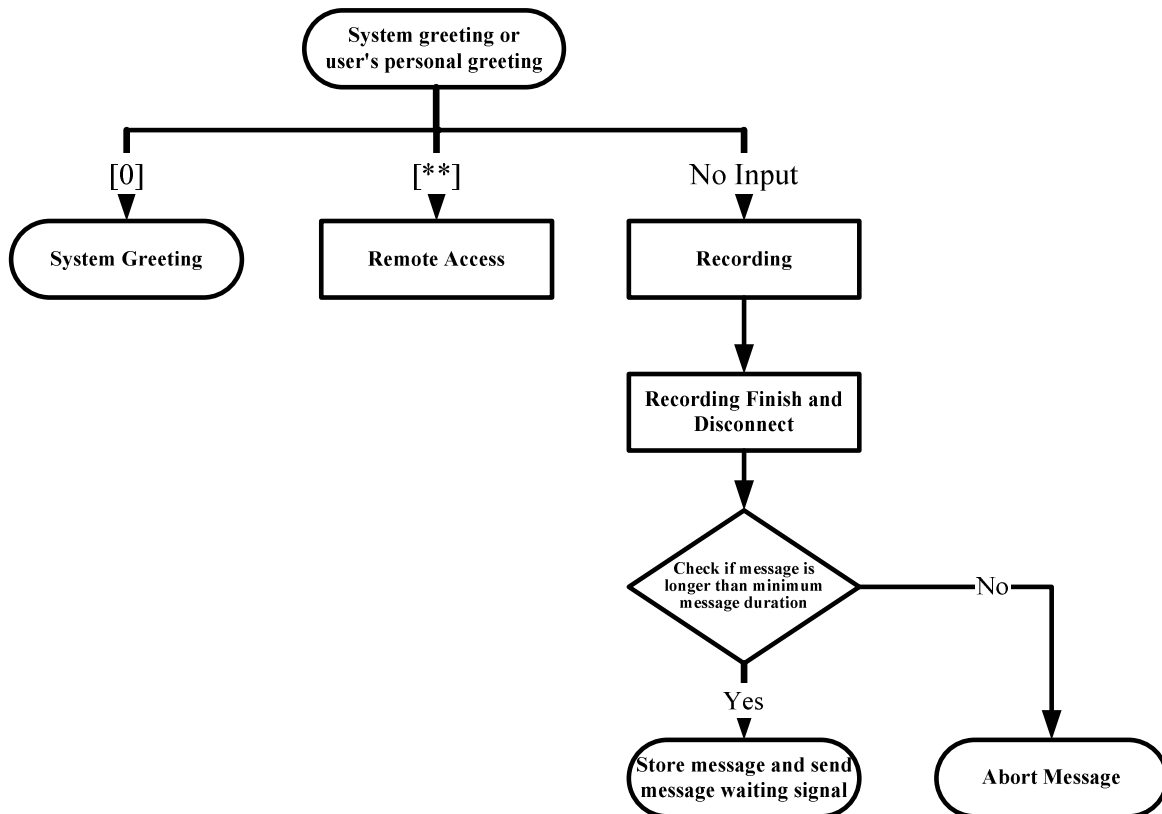

Fig. 6 Leave a Message

### User Retrieves Messages

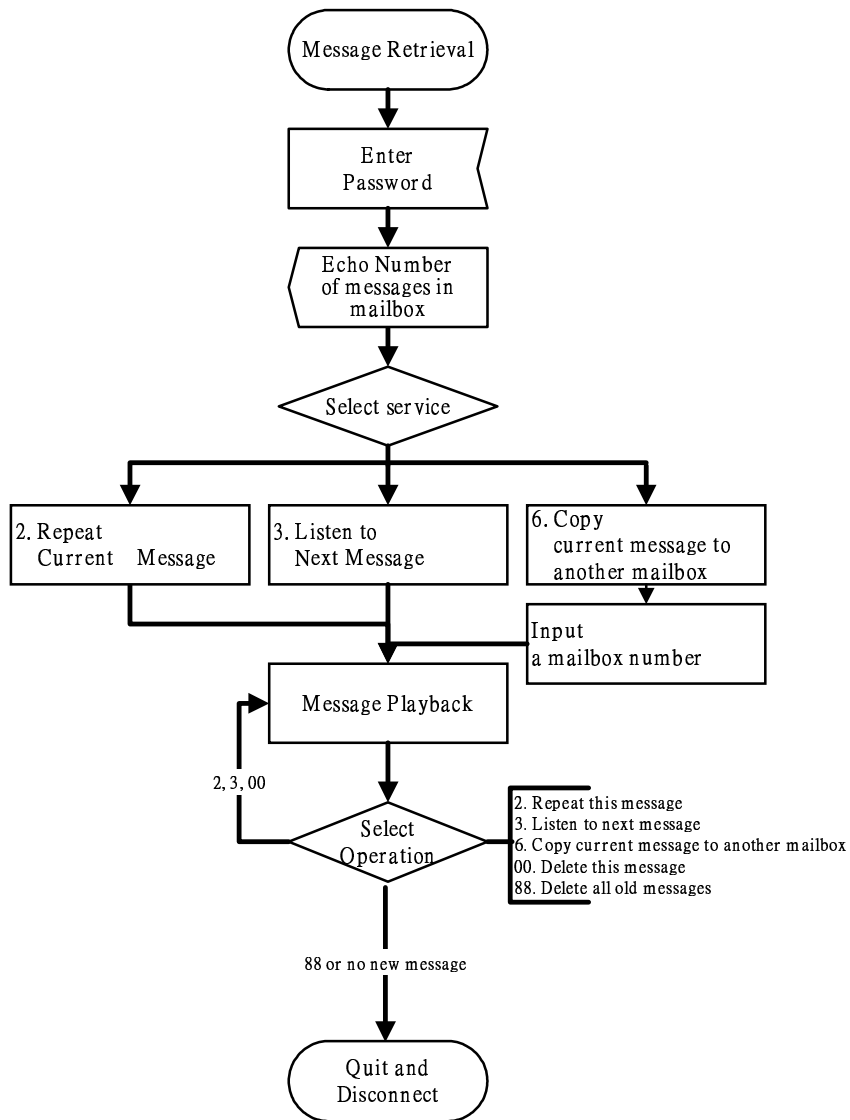

Fig. 7: Retrieve Messages

### Mailbox Greeting Recording

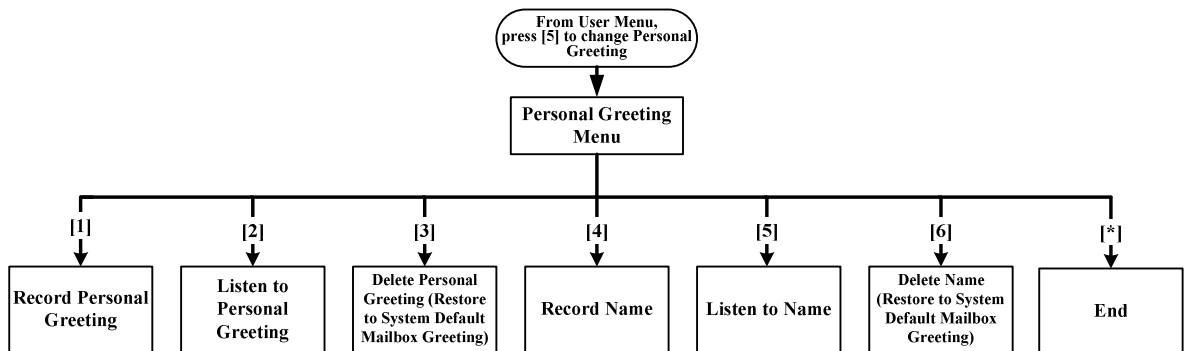

Fig. 8: Personal Greeting and Name Recording

### Set Auto Message Copy

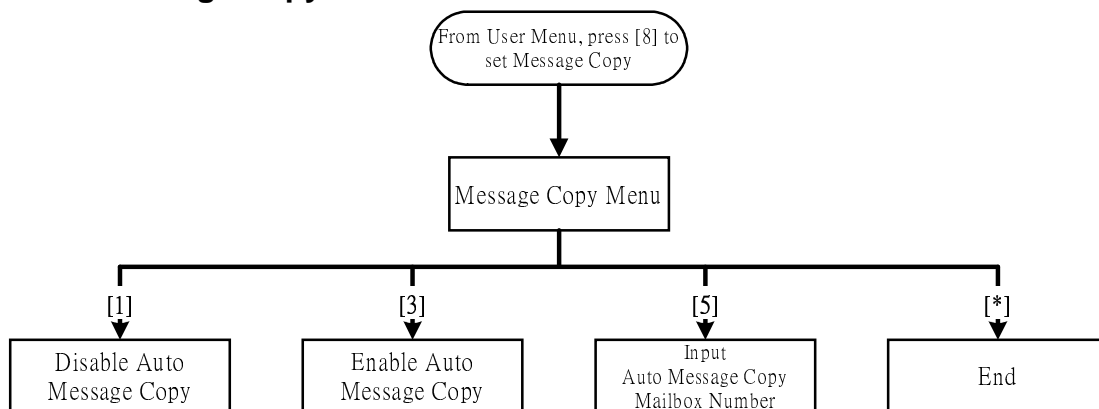

Fig. 9: Set Message Copy

### Administration by Phone

There are 2 levels of administration provided by system user level and administrator level. By a phone call, provided the system is in Auto attendant mode, user or administrator can change some parameters in the system.

#### User Level

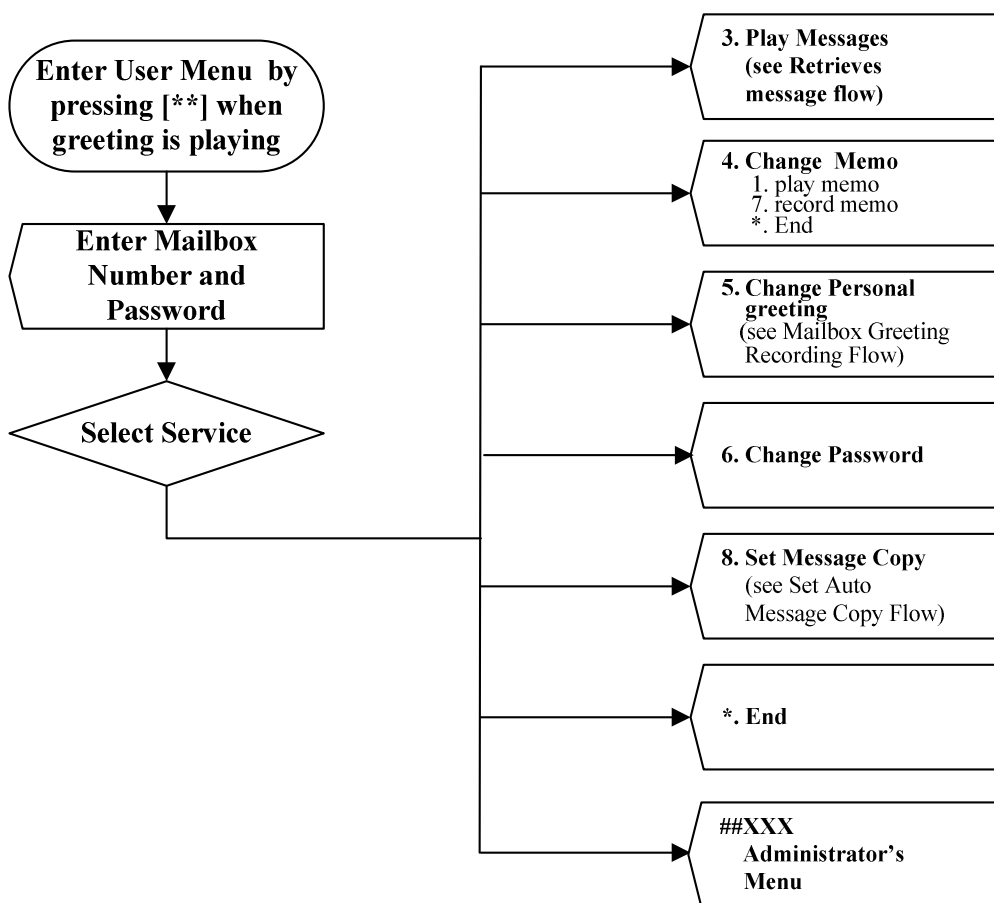

Fig. 10: User's Menu



There is a user menu providing selections to the normal mailbox user. Most of the selections are related to mailbox customization. Hence, the mailbox owner can control their mailbox by a phone call remotely.

Mailbox owners can call directly to the system by accessing the voice prompt ((Menu →voice mail→voice prompt). They will be asked for a password and then the user menu will be opened directly

### Administrator Level

The Administrator Menu is designed for both the system installer and the system administrator. The Administrator can enter this menu by a phone call and do some global modifications on system parameters. For example, make a change to the Auto Attendant greeting and recording.

To enter the administrator menu, the caller can press [## plus the supervisor password, the default setting of 000, see call feature configuration 3.2.3] while the Auto Attendant greeting or announcement box 07 greeting is playing.

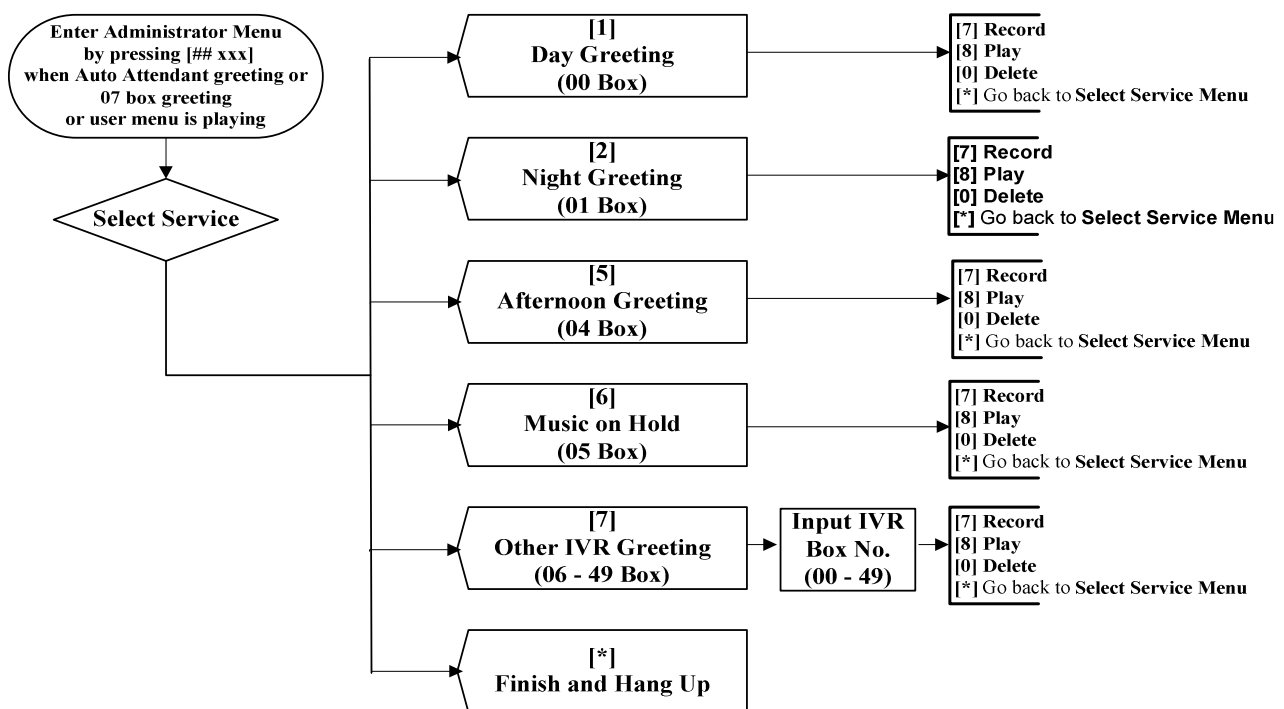

Fig. 11: Administrator's Menu

# Auto Attendant

## Day / Night / Afternoon

The Auto Attendant has several modes of operation. The System can be programmed to have either ‘Day, Night or Afternoon modes’. The Day and Night modes have two parameters: greeting and operator number. In day mode, there is day greeting (or normal company greeting) and day operator number for Auto Attendant operation. There is also a night greeting (or off duty greeting) and a night operator number for off duty hours in Night mode. The Day / Night mode feature mainly governs the information and response of the Auto Attendant service.

To provide maximum flexibility, these 3 modes can be changed:

1. automatically according to time defined by user, or
2. manually changed

## Day Mode Afternoon Greeting

In normal day mode Auto Attendant operation, you can input 2 greetings: default and afternoon. If you have enabled this function, the afternoon greeting will be activated automatically at 12:00 noontime.

For example, ‘Good morning, ...’ will be played before 12:00 noontime and ‘Good afternoon, .....’ will be played after 12:00 noontime.

Setting: see call features configuration 3.2.1

Note: the afternoon greeting should be recorded for this feature.

## Time of Silence after Announcement

If the caller does not enter an extension within a specified time after the announcement, then the mail box 0 of extension 0 will be opened for the caller to leave a message.

Setting: see call features configuration 3.2.2

## Auto Switch Day / Night Mode, Day Mode Start Time, Night Mode Start Time

Day and Night Modes of Auto Attendant are different in their greeting and operator extension. You can have the system change from Day to Night mode automatically according to a predefined time (e. g. 6:00 P.M.).

This function automatically has the system respond to incoming calls. For example, 'Welcome to xxx company, please dial an extension or press [0] for operator assistance' for Day Mode operation programmed from 9:00 AM to 6:00 PM; or for calls after 6:00P.M., a suitable after hours message can be recorded.

Setting: see call features configuration 2.1

## Other Auto Attendant Features

### Announcement Message

There are 4 announcements for Auto Attendant feature. Each announcement can have a maximum recording time of 10 minutes.

Setting see PC programming/System Configuration/Hierarchy3.3.4

The User can record a desired messages to replace the default Auto Attendant messages. On the other hand, it is unnecessary to record an announcement for night mode and afternoon mode if they are not activated.

Here is a list of Auto Attendant messages and their meanings:

Announcement Number	Description	Message Example
1	Day Greeting and Instruction Message	Good morning. This is ABC company. Please dial an extension or leave a message after the tone.
2	Night Greeting and Instruction Message	Thank you for calling ABC Company, we are closed now, please call again tomorrow
5	Afternoon Greeting Message	Good afternoon. This is ABC company. Please dial an extension or leave a message after the tone.
6	Message before Music on Hold (Optional)	Please wait. Your call is being transferred

There are 2 methods to record a customized announcement:

1. Record by a phone call to the system remotely. (see the section

- “Administration by phone” for details.)
2. Use an extension telephone to record locally by accessing the voice prompt. (see the section “Administration by phone” for details.)
  3. Use an external music source to record locally via the system configuration by using a personal computer.

### **Auto Attendant features memory Reset**

This can be accessed by system programming (see call features configuration 5.4). All the Auto Attendant features settings will return to their default values without erasing the announcement.

Note: When factory default setting is restored, the auto-attendant features memory is also reset.

# Multi-level Interactive Voice Response

The Multi-level Interactive Voice Response IVR feature allows the caller to access a function via a series of key press selections. It can be a voice prompt of a product description, a message prepared by the system owner, a call transfer option to select a person, a voice mailbox, etc.

With the Multi-level IVR feature, you can setup your system to provide a customer oriented voice service. Examples are:

- i. Customer service hot line
- ii. Company products or services introduction
- iii. Auto attendant service with direct call transfer to a person or department
- iv. Voice announcement service with multi-language prompts
- v. Access to a mailbox directly upon unsuccessful call transfer or in night mode

Here is an example of multi-level IVR call flow:

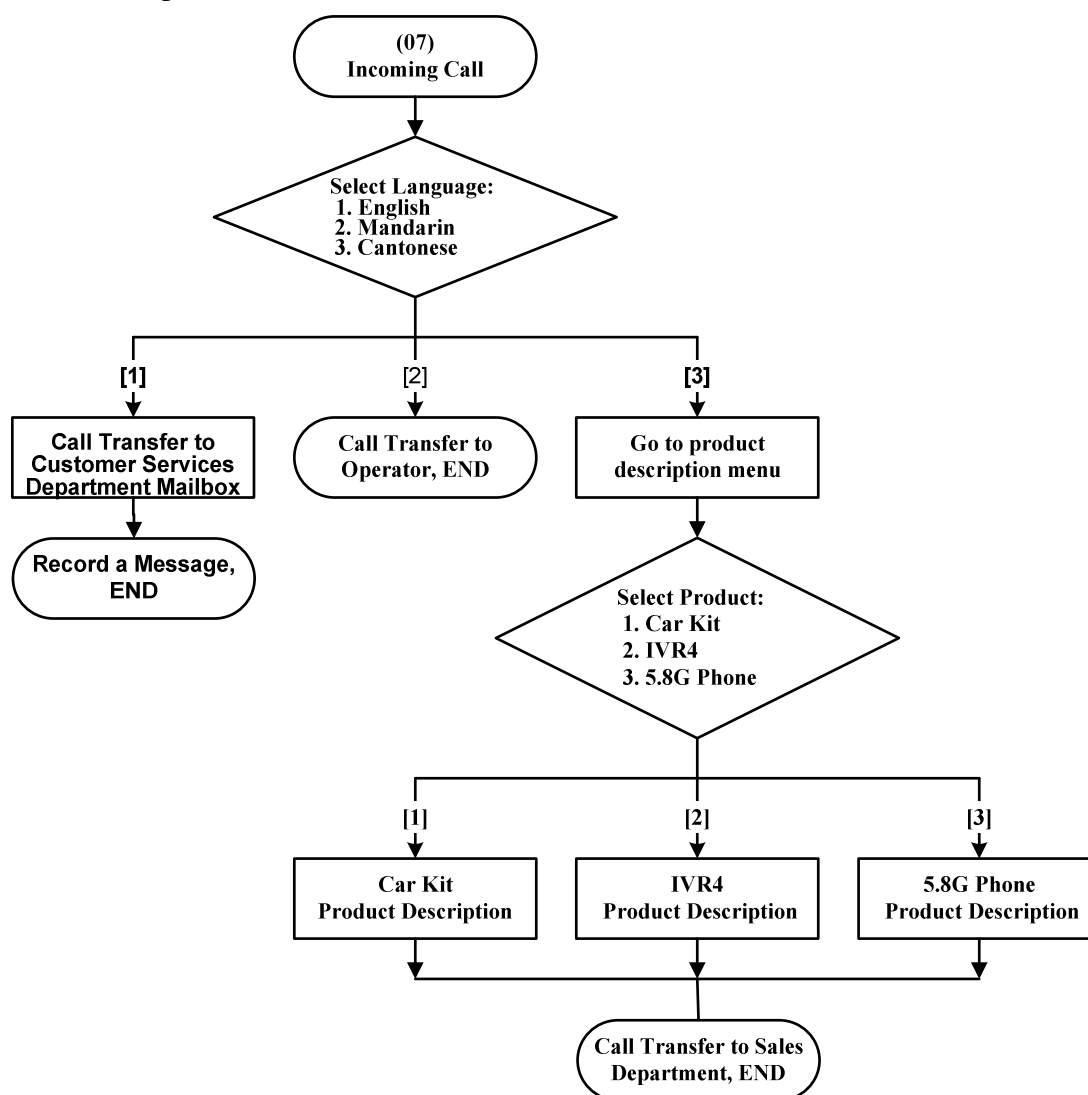

Fig. 12: Multi-level IVR Call Flow Sample

## Configuration of IVR Call Flow

This feature should be set by using PC programming. Before doing the configuration of IVR call flow, you should have finished the call flow design. It is recommended that you write down the flow on a piece of paper, so that you have a clear picture of the call flow. This procedure can prevent a lot of mistakes (such as infinite close looping or long waiting without termination) in your call flow.

The next step is to program and record every box in your call flow in the system. To start the procedure, select 'Announcement Recording' in System Configuration B ar.

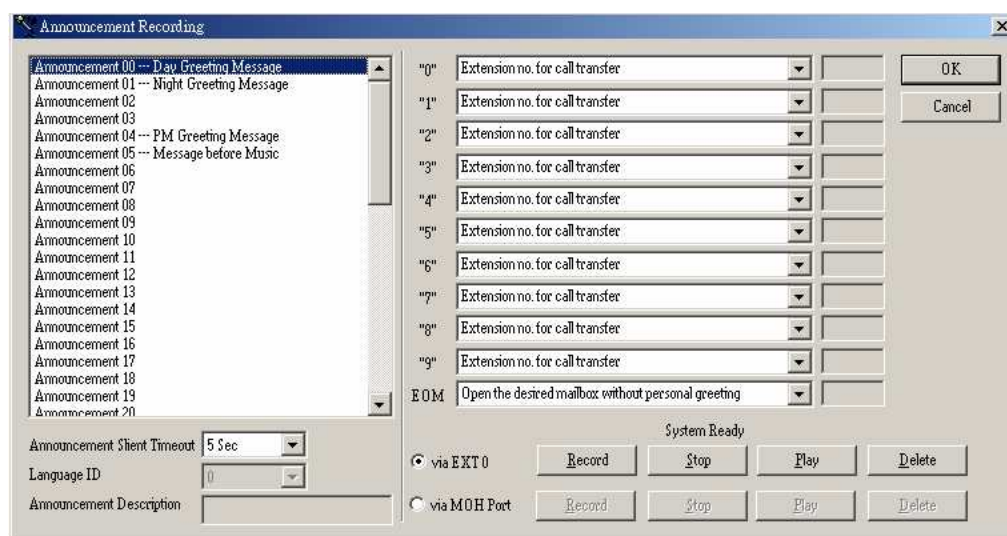

Fig. 13: Configuration Window

There are 3 portions in this Window: announcement selection, functions of announcement and announcement recording.

### Announcement Selection

The announcements represent the boxes of the call flow. There are 50 announcements (00 to 49). You need to put an announcement to each box in your call flow but you don't need to have all announcements recorded. Some announcements are just bringing some functions to your call flow.

An announcement may be a product description box, language selection box, call transfer box, etc. For each announcement, you can define the waiting time, the language, the function for each key press, and the function for no key press.

There is also a name field for each announcement. You can put a remark here to help you to remember the functionality of the announcement.

## Functions of Announcement

On the right hand side of the configuration window, you can put the function for each key press when an announcement is playing. The last row is EOM (end of message). It defines the function when there is no input from the listener upon expiration of the waiting time.

If the listener has pressed a digit (0 – 9), the announcement will stop playing and execute the corresponding function according to the definition on the digit.

Here is a list of the functions:

Function	Description
Invalid Input	Do nothing
extension number for call transfer	When the listener has pressed a digit, the function will wait until a complete extension number is received and transfer the listener to the extension number
Go to announcement xx (00-49)	Move the listener to the next level
Transfer to extension x (0-9)	Transfer the listener to a predefined extension
Go to day/night greeting	Move the listener to auto attendant operation
Open the desired mailbox with personal greeting	Open a mailbox for the listener and start with personal greeting
Open the desired mailbox without personal greeting	Open a mailbox for the listener and start with 'beep'
Transfer to voice mail user login of language ID 0	Ask the listener for a password and open the mailbox user mode, the listener is expected to be the mailbox owner
Open a mailbox x (0-9) with personal greeting	Open a predefined mailbox and start with personal greeting
Open a mailbox x (0-9) without personal greeting	Open a predefined mailbox and start with 'beep'
Input mailbox no. & transfer it with personal greeting	Open the appropriate mailbox as input by the listener and start with personal greeting
Input mailbox no. & transfer it without personal greeting	Open the appropriate mailbox as input by the listener and start with 'beep'
Disconnect	Hang up the call
Play goodbye message with language ID 0 and disconnect	Say Goodbye and hang up the call

## Announcement Recording

In the lower portion of the configuration window, there are buttons for you to play, record or delete the voice message part of an announcement box.

## IVR Call Flow and Configuration Example

Here we repeat the previous call flow diagram with announcement numbers input:

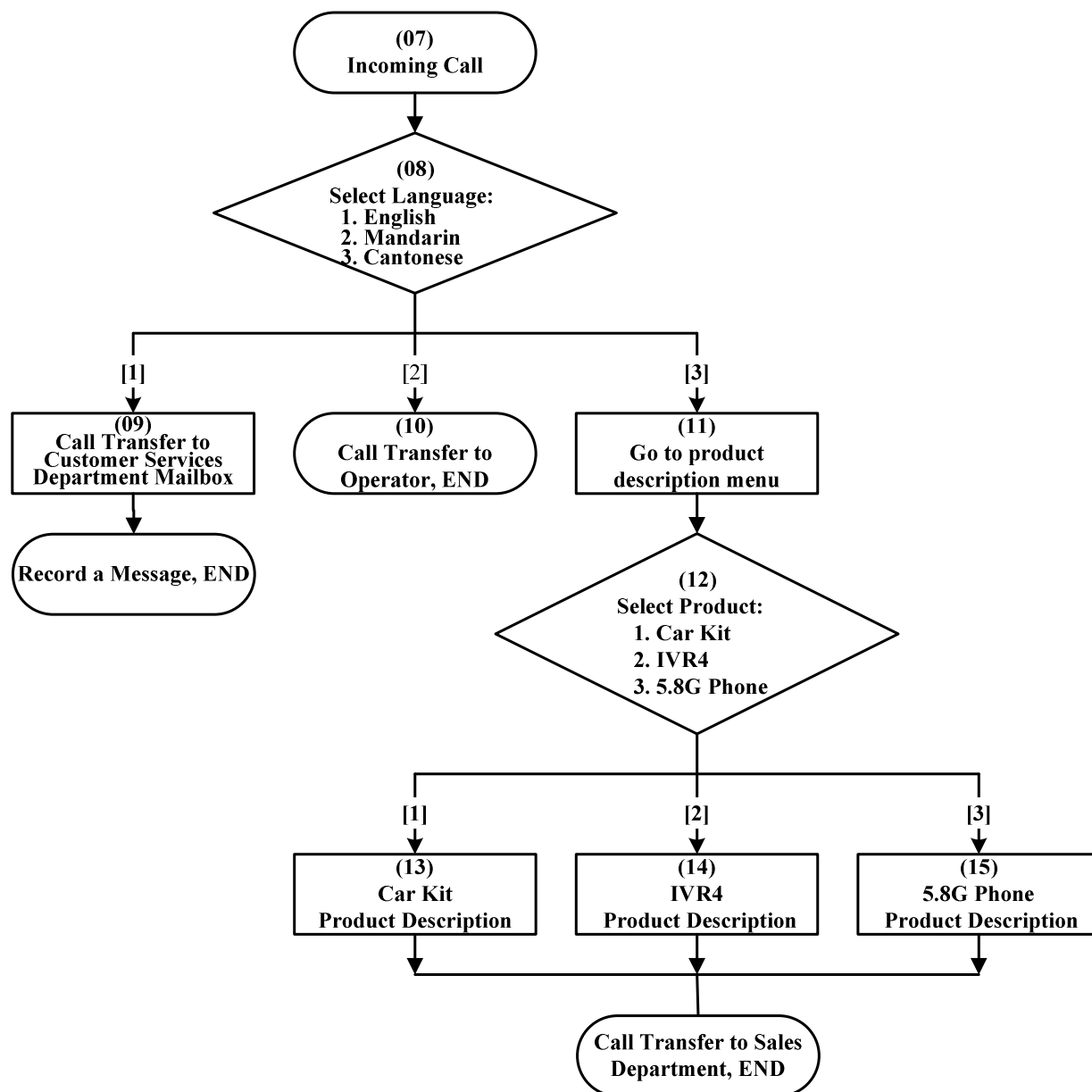

Fig. 14: Multi-level IVR Call Flow Sample with Announcement Numbers

When an announcement is executed, it plays the pre-recorded message and waits for the input from the user. The waiting time is also defined here. If there is no input from the listener when the waiting time expires, the announcement will execute the EOM function on the right hand side of the window.



You don't need to put an announcement number to the termination box in your call flow, because the termination box is always equal to the hang up operation. You can clearly define the hang up operation in the announcement boxes prior to the termination.

Let's take a look at the configuration windows for box (07) and (08) in the sample call flow:

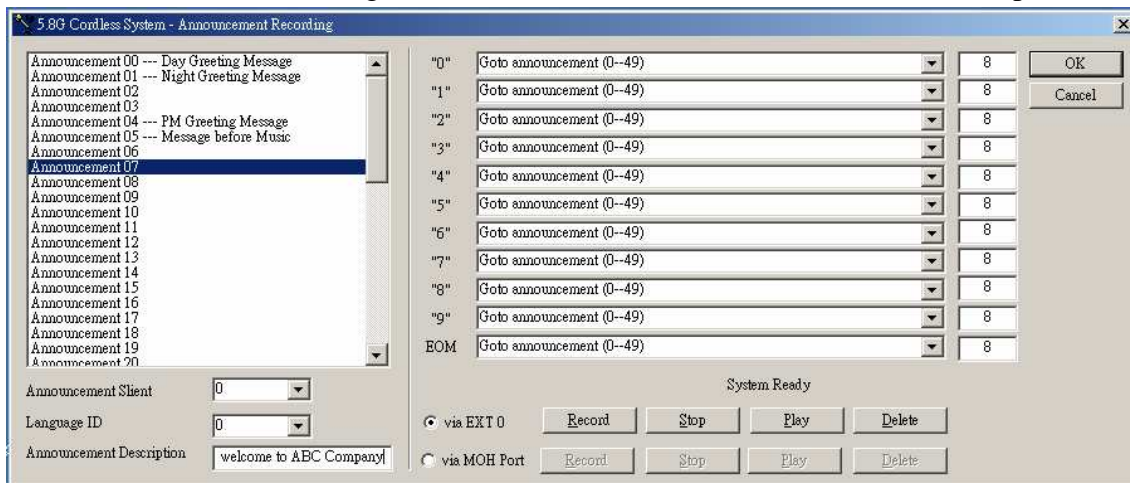

Fig. 15 Configuration for Announcement Box (07) in the Example

In this example, announcement (07) is the starting point of the call flow. You don't need any function here. You may record a message 'Welcome to ABC Company' and then move the listener to next level.

This level has announcement (08). It is a language selection box. You need to ask the listener to select a language and then move to next level.

If the listener doesn't press a selection, after 10 seconds, the call flow will go to the default branch, the English branch. The voice message of this announcement box can be 'Please select a language, press 1 for English, press 2 for Mandarin, press 3 for Cantonese'.

Here is the configuration window:

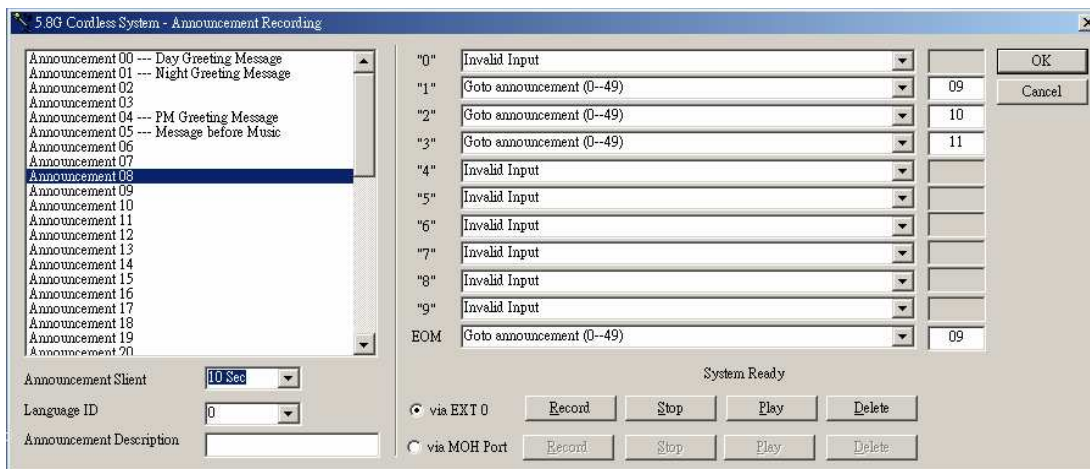

Fig. 16: Configuration for Announcement Box (08) in the Example

## Termination of Call Flow

On your call flow, you should always remember to terminate a branch appropriately. Otherwise, the listener will be directed to some unknown state. The System is then unable to bring the listener back to any announcement box if the listener has entered such an unknown state. Moreover, in a worst case, this unknown state creates a situation where the port cannot be released when the listener has hung up the phone. In such a case, you will see that the port's LED on the IVR cabinet will remain turned on even when there is no incoming call. This would require a power reset on the system.

To terminate a call flow branch, you can use these functions:

Functions
Open a desired mailbox with a personal greeting
Open a desired mailbox without a personal greeting
Transfer to voice mail for user login
Open mailbox x with a personal greeting
Open mailbox x without a personal greeting
Disconnect
Play goodbye message with language ID 0 and disconnect

## Example of Multi-level IVR Application

Multi-level IVR features provide maximum flexibility for you to create your desired call flow and call applications. You can use the following tools to configure an application:

- Multiple languages
- Voice Message
- Call Transfer
- Open a voice mailbox

Here is an example for customized application.

### Single Digit Menu (Department Call Transfer)

The example shows how to configure the system to differentiate an incoming call for different departments in a company.

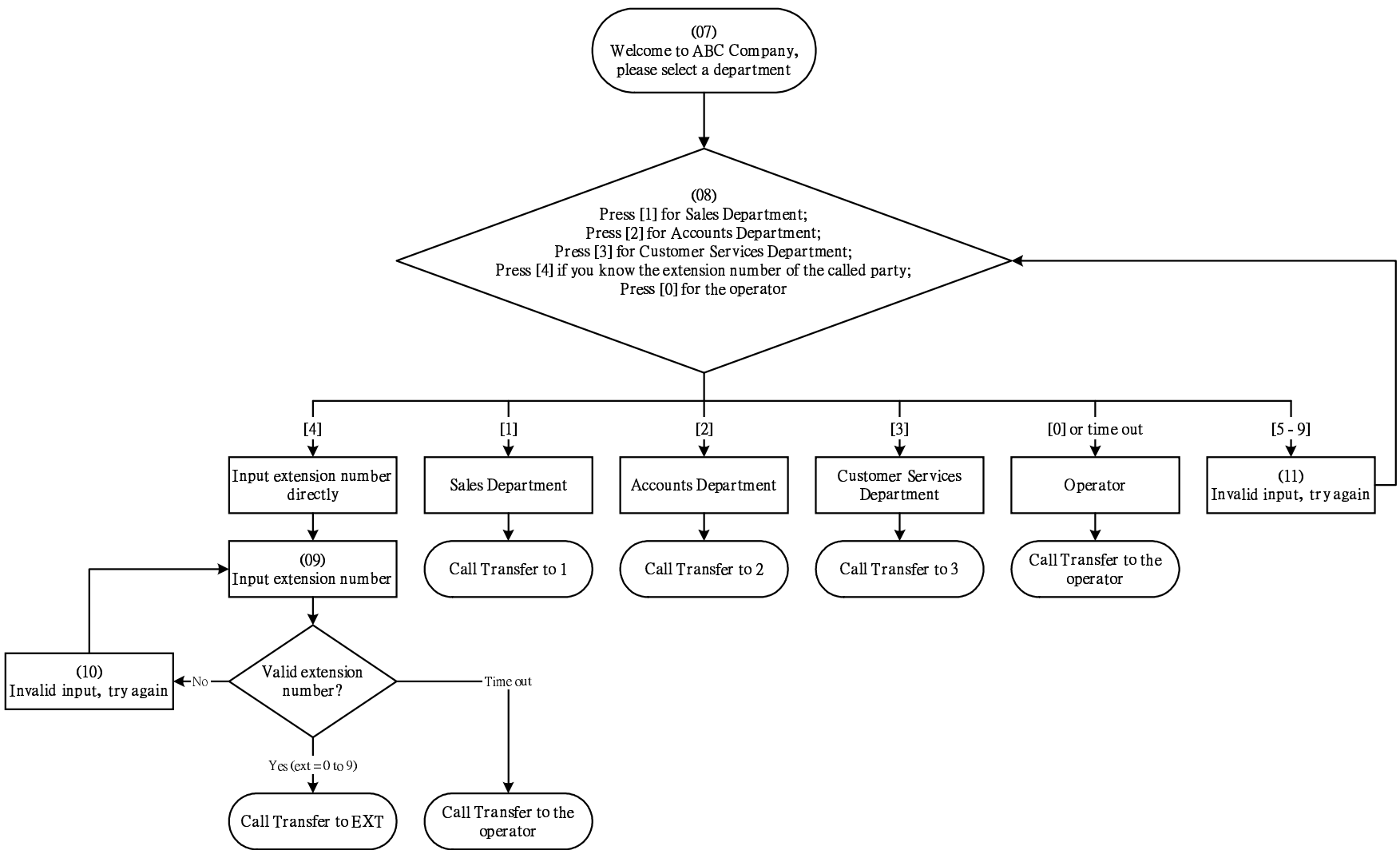

Fig. 17 Single Digit Menu

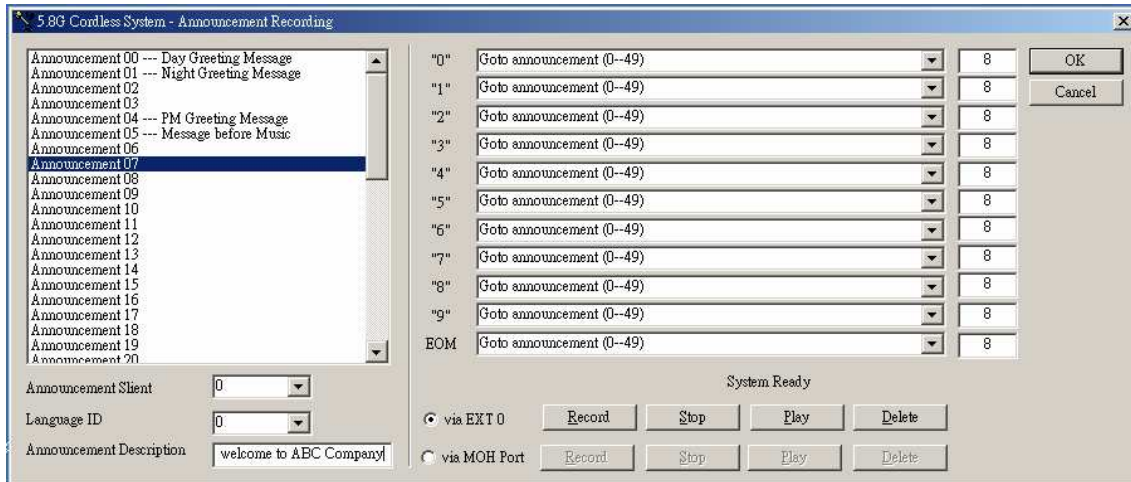

Fig. 18: Configuration Window for Single Digit Menu 07 Box

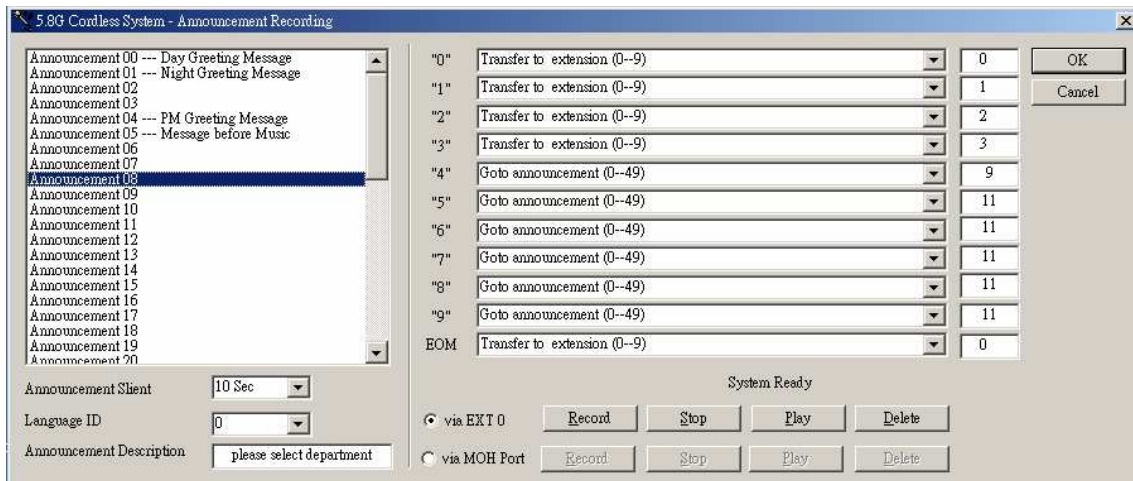

Fig. 19: Configuration Window for Single Digit Menu 08 Box

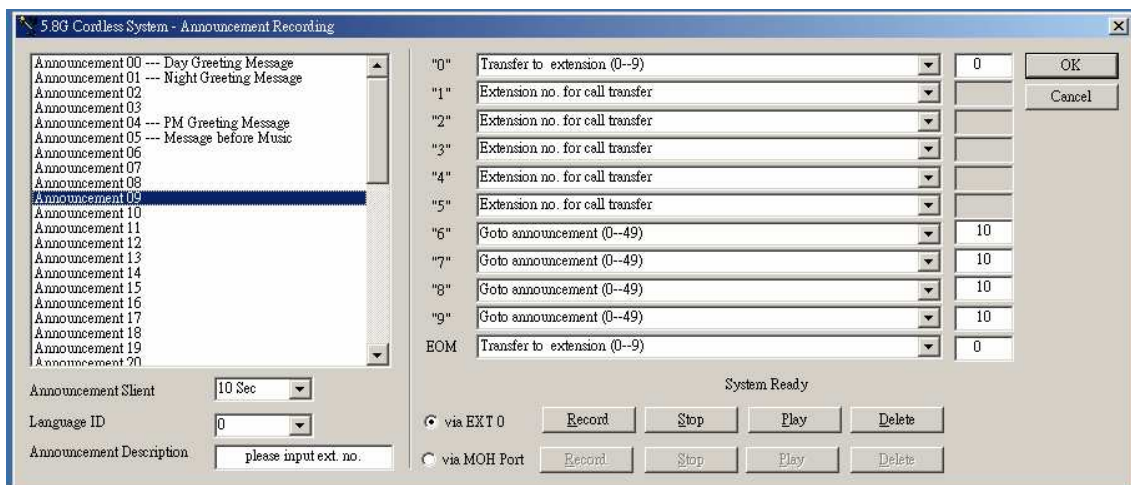

Fig. 20: Configuration Window for Single Digit Menu 09 Box

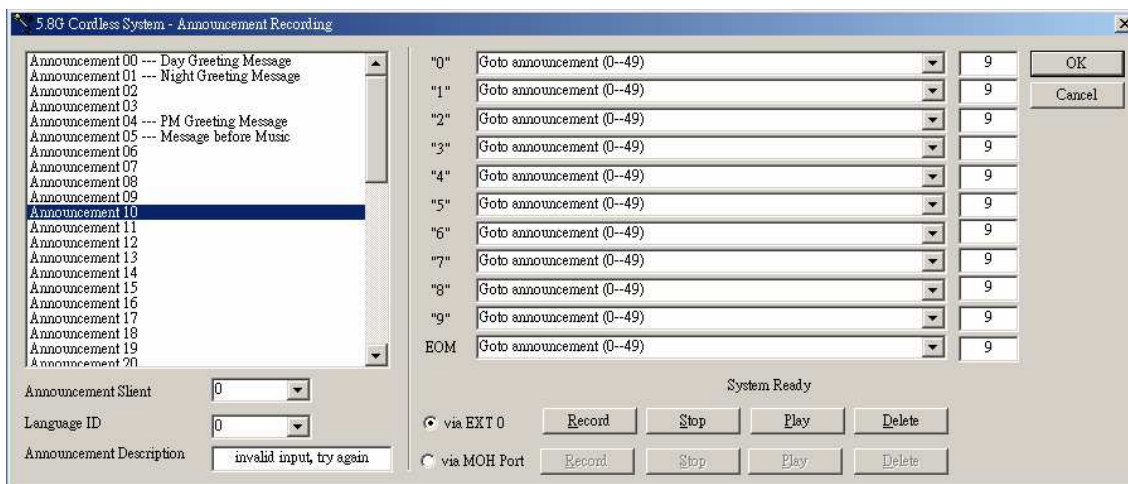

Fig. 21: Configuration window for Single Digit Menu 10 Box

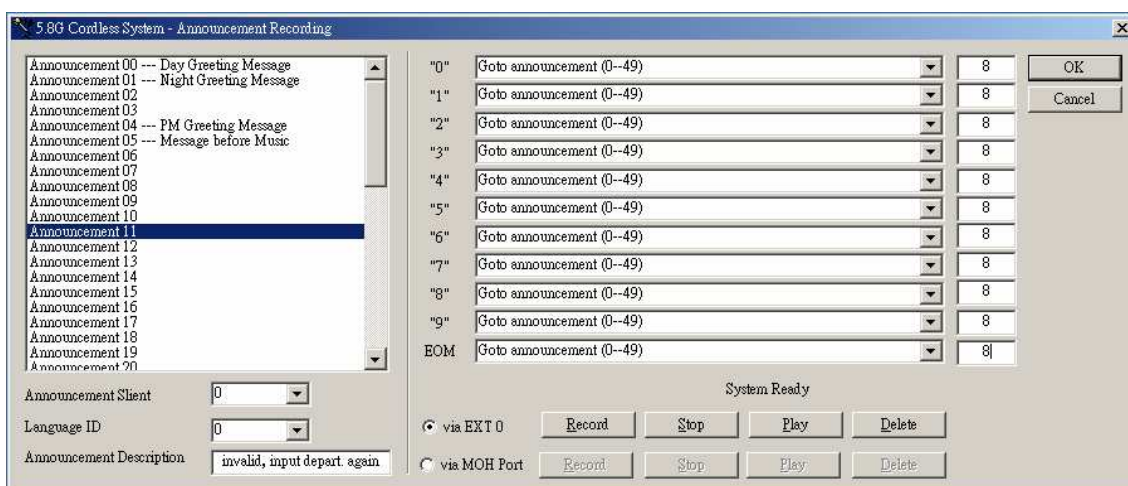

Fig. 22: Configuration window for Single Digit Menu 11 Box

The recommended voice messages for the boxes:

Box number	Voice Message Content
07	Welcome to ABC company
08	Please select a department, press [1] for the sales department, [2] for accounts department, [3] for customer service, press [4] for general information, press [0] for the operator
09	Please input the extension number or press [0] for the operator
10	Invalid extension number, please input again
11	Invalid department selection, please select department again

# Important Safety Instruction

When using this unit, basic safety precautions should always be followed to reduce the risk of fire, electric shock, or personal injury.

## Read and understand all instructions

1. Follow all warnings and instructions marked on this unit.
2. Unplug this unit from the wall outlet before cleaning. Do not use liquid or aerosol cleaners; use a damp cloth for cleaning.
3. Do not use this unit near water; for example, near a bathtub, washbowl, kitchen sink, or laundry tubs, in a wet basement, or near a swimming pool.
4. Do not place this unit on an unstable cart, stand or table. It could fall, causing serious damage or impeding operation.
5. This unit should never be placed near or over a radiator or heat register.
6. Never push objects of any kind into this unit as they may touch dangerous voltage points or short out parts that could result in the risk of fire or electrical shock. Never spill liquid of any kind on this unit.
7. Never touch bare telephone wires or terminals unless the telephone line has been disconnected.
8. Use only the power source marked on the unit. If you are not sure of the type of power supplied to your home, consult your dealer or local power company.
9. Do not place objects on the power cord. Install the unit where no one can step or trip on the cord.
10. Do not overload wall outlets and extension cords. This can result in the risk of fire or electric shock.
11. Under the following conditions the telephone unit should be returned for maintenance:
  - i. If liquid has been spilled into the unit
  - ii. If the unit has been exposed to rain or water
  - iii. If the unit does not operate normally when following the operating instructions
  - iv. If the unit has been dropped or the casing damaged
  - v. If the unit exhibits a distinct change in performance.
12. Do not disassemble this unit. It will void the warranty. Opening or removing covers may expose you to dangerous voltages or other risks. Incorrect re-assembly can cause electrical shock during subsequent use.
13. Avoid using the telephone except cordless type during a thunderstorm. There may be a slight risk of electrical shock from lightning.
14. Do not use this unit to report a gas leak, when in the vicinity of the leak.

**CAUTION:**To reduce the risk of fire or injury to persons, read and follow these instructions.

1. Use only the battery(ies) specified.
2. Do not dispose of the battery(ies) in a fire. They may explode. Check with local waste management codes for special disposal instruction.
3. Do not open or mutilate the battery(ies). Released electrolyte is corrosive and may cause burns or injury to the eyes or skin. The electrolyte may be toxic if swallowed.
4. Exercise care in handling batteries in order not to short the battery to conductive materials such as rings, bracelets, and keys. The battery may overheat and cause burns.
5. Charge the battery(ies) provided with or identified for use with this product only in accordance with the instructions in this instruction.

**Warning:**

To prevent Fire or shock hazard, do not expose this product to rain or any type of moisture

# Specification

## Hardware Specification

RF Frequency Band	5.8 GHz
Telephone Line	3
Hands Free	Hands Free Speaker Phone
LCD Display Module	4 line LCD Alpha Numeric Display
Display	Date and Time Display
Caller ID with Call Waiting	Type 1 (FSK) & Type II
Voice Mail / Message Recording	1 hour
Maximum Distance (open space, line at sight)	1000 ft.
WMC Weight	1.2 kg
Color	Dark Grey / Silver
WMC Dimension (WxDxH )	323 x 250 x 470 mm
WMC Power / Adaptor	DC 9V (1.4A)
Back Up Battery (rechargeable)	7.2V

## Operating Conditions:

Temperature	0 to 45 °C
Humidity	10% to 95%



# Limited Warranty

Circle Communication Product Inc (“Circle”) warrants that this 5.8G Multi-line & Multi-handset Cordless Telephone (“Product”) is free from defects in material and workmanship that result in

Product failure during normal usage, according to the following terms and conditions:

1. The limited warranty for the Product extends for ONE (1) year beginning on the date of the purchase of the Product.
2. The limited warranty extends to the original customer of the Product (“Customer”) and is not assignable or transferable to any subsequent customer/end-user.
3. The limited warranty extends only to the Customer who purchased the Product in the United States.
4. During the limited warranty period, Circle will repair, or replace, at Circle' s option, any defective parts, or any parts that will not properly operate for their intended use with new or factory rebuilt replacement items if such repair or replacement is needed because of product malfunction or failure during normal usage. No charge will be made to the Consumer for any such parts. Circle will also pay for the labor charges incurred by Circle in repairing or replacing the defective parts. The limited warranty does not cover defects in appearance, cosmetic, decorative or structural items, including framing, and any non-operative parts. Circle' s limit of liability under the limited warranty shall be the actual cash value of the Product at the time the Consumer returns the Product for repair, determined by the price paid by the Consumer for the Product less a reasonable amount for usage. Circle shall not be liable for any other losses or damages.

These remedies are the Customer’s exclusive remedies for breach of warranty.

5. Upon request from Circle, the Consumer must prove the date of the original purchase of the Product by a dated bill of sale or dated itemized receipt.
6. The Customer shall bear the cost of shipping the Product to Circle in United Status. Circle shall bear the cost of shipping the Product back to the Customer after the completion of service under this limited warranty.
7. The Customer shall have no coverage or benefits under this limited warranty if any of the following conditions are applicable:
  - a) The Product has been subject to abnormal use, abnormal conditions, improper storage, exposure to moisture or dampness, unauthorized modifications, unauthorized connections, un-authorized repair, misuse, neglect, abuse, accident, alteration, improper installation, or other acts which are not the fault of Circle, including damage caused by shipping.
  - b) The Product has been damaged from external causes such as collision with an object, or

from fire, flooding, sand, dirt, windstorm, lightning, earthquake or damage from exposure to weather conditions, an Act of God, or battery leakage, theft, blown fuse, or improper use of any electrical source, or damage caused by the connection to other products not recommended for interconnection by Circle.

c) Circle was not advised by the Customer in writing of the alleged defect or malfunction of the Product within fourteen (14) days after the expiration of the applicable limited warranty period.

d) The Product serial number plate or the accessory data code has been removed, defaced or altered.

8. If a problem develops during the limited warranty period, the Customer shall take the following step-by-step procedure:

a) the Customer shall contact Circle Customer Service:

Circle Communication Product Inc.

Phone: **310-335-0305**

Email : [cs@circleproducts.com](mailto:cs@circleproducts.com)

b) The Customer shall include a return address, daytime phone number and/or fax number, complete description of the problem, proof of purchase and service agreement (if applicable). Expenses related to removing the Product from an installation are not covered under this limited warranty.

c) The Customer will be billed for any parts or labor charges not covered by this limited warranty. The Customer will be responsible for any expenses related to reinstallation of the Product.

d) Circle will repair or authorize the repair of the Product under the limited warranty within 30 days after receipt of the Product by Circle or any Circle authorized service center. If Circle cannot perform repair covered under this limited warranty within 30 days, or after a reasonable number of attempts to repair the same defect, Circle at its option, will provide a replacement Product or refund the purchase price of the Product less a reasonable amount for usage.

e) If the Product is returned to Circle during the limited warranty period, but the problem with the Product is not covered under the terms and conditions of this limited warranty, the Customer will be notified and given an estimate of the charges the Customer must pay to have the Product repaired, with all shipping charges billed to the Customer. If the estimate is refused, the Product will be returned freight collect. If the Product is returned to Circle after the expiration of the limited warranty period, Circle' s normal service policies shall apply and the Customer will be responsible for all shipping charges.

9. The Product consists of newly assembled equipment that may contain used components that have been reprocessed to allow machine compliance with Product performance and reliability specifications.

10. ANY IMPLIED WARRANTY OF MERCHANTABILITY, OR FITNESS FOR A PARTICULAR PURPOSE OR USE, SHALL BE LIMITED TO THE DURATION OF THE FOREGOING LIMITED WRITTEN WARRANTY. OTHERWISE, THE FOREGOING LIMITED WARRANTY IS THE CONSUMER' S SOLE AND EXCLUSIVE REMEDY AND IS IN LIEU OF ALL OTHER WARRANTIES, EXPRESS OR IMPLIED. CIRCLE SHALL NOT BE LIABLE FOR SPECIAL, INCIDENTAL OR CONSEQUENTIAL DAMAGES, INCLUDING BUT NOT LIMITED TO, LOSS OF ANTICIPATED BENEFITS OR PROFITS, LOSS OF SAVINGS OR REVENUE, PUNITIVE DAMAGES, LOSS OF USE OF THE PRODUCT OR ANY ASSOCIATED EQUIPMENT, COST OF CAPITAL, COST OF ANY SUBSTITUTE EQUIPMENT OR FACILITIES, DOWN-TIME, THE CLAIMS OF ANY THIRD PARTIES, INCLUDING CUSTOMERS, AND INJURY TO PROPERTY, RESULTING FROM THE PURCHASE OR USE OF THE PRODUCT OR ARISING FROM BREACH OF THE WARRANTY, BREACH OF CONTRACT, NEGLIGENCE, STRICT TORT, OR ANY OTHER LEGAL OR EQUITABLE THEORY, EVEN IF CIRCLE KNEW OF THE LIKELIHOOD OF SUCH DAMAGES. CIRCLE SHALL NOT BE LIABLE FOR DELAY IN RENDERING SERVICE UNDER THE LIMITED WARRANTY, OR LOSS OF USE DURING THE PERIOD THAT THE PRODUCT IS BEING REPAIRED.

11. Some states do not allow limitation of how long an implied warranty lasts, so the above one-year warranty limitation may not apply to you (the Consumer). Some states do not allow the exclusion or limitation of incidental and consequential damages, so certain of the above limitations or exclusions may not apply to you (the Consumer). This limited warranty gives the Customer specific legal rights and the Customer may also have other rights, which vary from state to state.

12. Circle neither assumes nor authorizes any authorized service center or any other person or entity to assume for it any other obligation or liability beyond that which is expressly provided for in this limited warranty including the provider or seller of any extended warranty or service agreement.

13. This is the entire warranty between Circle and the Customer, and supersedes all prior and contemporaneous agreements or understandings, oral or written, and all communications relating to the Product, and no representation, promise or condition not contained herein shall modify these terms.

14. This limited warranty allocates the risk of failure of the Product between the Consumer and Circle. The allocation is recognized by the Customer and is reflected in the purchase price of the Product.

15. Any action or lawsuit for breach of warranty must be commenced within twelve (12) months following delivery of the Product.

16. Questions concerning this limited warranty may be directed to:

Circle Communication Products, Inc

Circle Communication Product Inc.

Phone: **310-335-0305**

Email : [cs@circleproducts.com](mailto:cs@circleproducts.com)

17. The limited warranty period for Circle supplied attachments and accessories is specifically defined within their own warranty cards and packaging.

# Important Consumer Information

When using this unit, basic safety precautions should always be followed to reduce the risk of fire, electric shock, or personal injury.

Warning: Changes or modifications to this unit not expressly approved by the party responsible for compliance could void the user's authority to operate the equipment.

## NOTE:

1) This equipment has been tested and found to comply with the limits for a Class B digital device, pursuant to Part 15 of the FCC Rules. These limits are designed to provide reasonable protection against harmful interference in a residential installation. This equipment generates, uses and can radiate radio frequency energy and, if not installed and used in accordance with the instructions, may cause harmful interference to radio communications.

However, there is no guarantee that interference will not occur in a particular installation. If this equipment does cause harmful interference to radio or television reception, which can be determined by turning the equipment off and on, the user is encouraged to try to correct the interference by one or more of the following measures:

- Reorient or relocate the receiving antenna.
- Increase the separation between the equipment and receiver.
- Connect the equipment into an outlet on a circuit different from that to which the receiver is needed.
- Consult the dealer or an experienced radio/TV technician for help.

2) This equipment complies with Part 68 of the FCC rules and the requirements adopted by the ACTA. On the bottom of this equipment is a label that contains, among other information, a product identifier in the format US:AAAEQ##TXXXX. If requested, this number must be provided to the telephone company.

3) An applicable certification jacks Universal Service Order Codes (USOC) for the equipment is provided (i.e., RJ11C) in the packaging with each piece of approved terminal equipment.

4) A plug and jack used to connect this equipment to the premises wiring and telephone network must comply with the applicable FCC Part 68 rules and requirements adopted by the ACTA. A compliant telephone cord and modular plug is provided with this product. It is designed to be connected to a compatible modular jack that is also compliant. See installation instructions for details.

5) The REN is used to determine the number of devices that may be connected to a telephone line. Excessive RENs on a telephone line may result in the devices not ringing in response to an incoming call. In most but not all areas, the sum of RENs should not exceed five (5.0). To be certain of the number of devices that may be connected to a line, as determined by the total RENs, contact the local telephone company. [For products approved after July 23, 2001, the REN for this product is part of the product identifier that has the format US:AAAEQ##TXXXX. The digits represented by ## are the REN without a decimal point (e.g., 03 is a REN of 0.3). For earlier products, the REN is separately shown on the label.]

6) If this equipment causes harm to the telephone network, the telephone company will notify you in advance that temporary discontinuance of service may be required. But if advance notice isn't practical, the telephone company will notify the customer as soon as possible. Also, you will be advised of your right to file a complaint with the FCC if you believe it is necessary.

7) The telephone company may make changes in its facilities, equipment, operations or procedures that could affect the operation of the equipment. If this happens the telephone company will provide advance notice in order for you to make necessary modifications to maintain uninterrupted service.

8) Should you experience trouble with this equipment, please contact (Circle Communication Products, 2554 Lincoln Blvd #111 Marina Del Rey CA 90291 USA) for repair or warranty information. If the equipment is causing harm to the telephone network, the telephone company may request that you disconnect the equipment until the problem is resolved.

9) Please follow instructions for repairing if any (e.g. battery replacement section); otherwise do not alternate or repair any parts of device except specified.

10) Connection to party line service is subject to state tariffs. Contact the state public utility commission, public service commission or corporation commission for information.

11) NOTICE: If your home has specially wired alarm equipment connected to the telephone line, ensure the installation of this [equipment ID] does not disable your alarm equipment. If you have questions about what will disable alarm equipment, consult your telephone company or a qualified installer.

12) This equipment is hearing aid compatible.

NOTICE: According to telephone company reports, AC electrical surges, typically resulting from lightning strikes, are very destructive to telephone equipment connected to AC power sources. To minimize damage from these types of surges, a surge arrestor is recommended.