

PRO850

Wireless Intercom



Operating Instructions



HM ELECTRONICS, INC.
14110 Stowe Drive, Poway, CA 92064 USA

Table of Contents

SECTION 1. INTRODUCTION	1
EQUIPMENT FEATURES	2
Base Station Front Panel Features	2
Base Station Rear Panel Features	2
Beltpac Top Panel Features	3
Beltpac Bottom Panel Features	3
BLOCK DIAGRAMS	4
Base Station	4
Beltpac	4
EQUIPMENT SPECIFICATIONS	5
Base Station	5
Beltpac	6
SECTION 2. EQUIPMENT SETUP.....	7
BASE STATION SETUP.....	7
Checking Status.....	11
Monitoring Audio Levels	12
Base Transmitter Configuration	13
Base Receiver Configuration.....	14
Base Configuration.....	15
Beltpac Configuration	18
Saving and Loading Settings.....	21
Advanced Settings.....	21
Displaying Information	25
Diagnostics	25
SECTION 3. PRO850 OPERATION.....	9
BASE STATION OPERATION	9
Uses of Front Panel Controls, Indicators and Connectors	9
Display Screen Navigation	10
Display Screen Functions and System Settings.....	11
BELTPAC OPERATION.....	26
Controls and Buttons	26
Indicator Lights	27
Connectors and Adjustment.....	28
Batteries.....	29
Infrared Window	29
SECTION 4. PC850 SOFTWARE	30
PC850 Installation	30
PC850 Operation	31
END-USER LICENSE AGREEMENT FOR HME PC850 SOFTWARE.....	33

FCC LICENSING

The HME PRO850 is Type Accepted under Part 74 of the United States Federal Communications Commission (FCC) Code of Federal Regulations governing general purpose applications. The system requires an FCC station license if operated within the United States or its possessions. Licensing of this equipment is the User's responsibility. Licensability depends on the User's classification, equipment application and frequency selected. The user should contact the appropriate telecommunications authority for any desired clarification.

CAUTION: Changes or modifications made by the user could void the user's authority to operate PRO850 equipment.

MANDATORY SAFETY INSTRUCTIONS FOR BASE STATION INSTALLERS AND USERS

1. Use only manufacturer or dealer supplied antennas. Antenna minimum safe distance, as calculated from FCC requirements, is 4.8cm. However, the FCC default for minimum safe distance is 20cm. Antenna gain: zero dBi referenced to a monopole.
2. The Federal Communications Commission has adopted a safety standard for human exposure to RF (Radio Frequency) energy, which is below the OSHA (Occupational Safety and Health Act) limits.
3. To comply with current FCC RF exposure limits, the antenna must be installed at or exceeding the minimum safe distance described here, and in accordance with the requirements of the antenna manufacturer or supplier.

4. Antenna substitution: Do not substitute any antenna for the one supplied by or recommended by the manufacturer or radio dealer. You may be exposing person or persons to harmful radio frequency radiation. You may contact your radio dealer or the manufacturer for further instructions.

5. **WARNING:** Maintain a separation distance from the antenna to person(s) of at least 20cm.

You, as the qualified end-user of this radio device must control the exposure conditions of bystanders to ensure the minimum separation distance (above) is maintained between the antenna and nearby persons for satisfying RF exposure compliance.

Operation of this transmitter must satisfy the requirements of the General Population/Uncontrolled Exposure Environment for work-related use. Transmit only when person(s) are at least the minimum distance from the properly installed, externally mounted antenna.



SECTION 1. INTRODUCTION

PRO850 equipment operates in the UHF band from 470 MHz to 740 Hz in 18 MHz subsets. Transmitters and receivers operate in different, non-adjacent 18 MHz bands. Synthesized frequencies can be selected in 25 kHz increments over each 18 MHz band, for 720 transmit and 720 different receive frequencies.

Base stations can be configured with up to four receivers and two transmitters, supporting up to four Beltpacs in full-time transmit, full-duplex operation. Two or three base stations interconnected can support up to twelve beltpacs operating at once. The channel lockout feature supports several beltpacs sharing the same frequency. In this mode, one beltpac user on a shared frequency can transmit at a time. If another user is already transmitting on that frequency, a “busy” signal will be heard. A total of sixteen beltpacs can be used with a system.

A feature can be selected that scans through all available intermodulation-free frequency groups to automatically configure the system for the best available set of frequencies. Specified frequencies can be saved for quick recall.

The PRO850 can be configured for fixed power output levels or automated output power control. With the automated feature selected, the PRO850 senses how far a beltpac is from the base station and automatically determines at what power level the beltpac should be operating, eliminating base station receiver overload and increasing beltpac battery life.

Two hardwired intercom channels provide simultaneous 2-wire and 4-wire operation.

The base station headset interface automatically detects and accommodates dynamic or electret microphones. It provides direct access to intercom channels 1 and 2, beltpacs only or all channels.

Any beltpac button can be configured to activate the base paging relay and, at the same time, audio is routed to the paging output.

The base can be configured to initiate an alert for various conditions, including low battery condition or button press from a beltpac.

The PRO850 is fully compatible with RTS® and ClearCom® hard-wired intercom systems.

With the provided PC850 software, the base station and beltpacs can be configured on a PC, and configuration settings can be saved to files. An RS-232 serial port and a USB port on the rear panel of the base station provide PC interface capability. Beltpacs can also be configured using a Palm-OS PDA with the optional PDA850 software.

The base station can operate from a standard 12-14VDC power source or from an external DC source such as a vehicle electrical system for mobile operation.

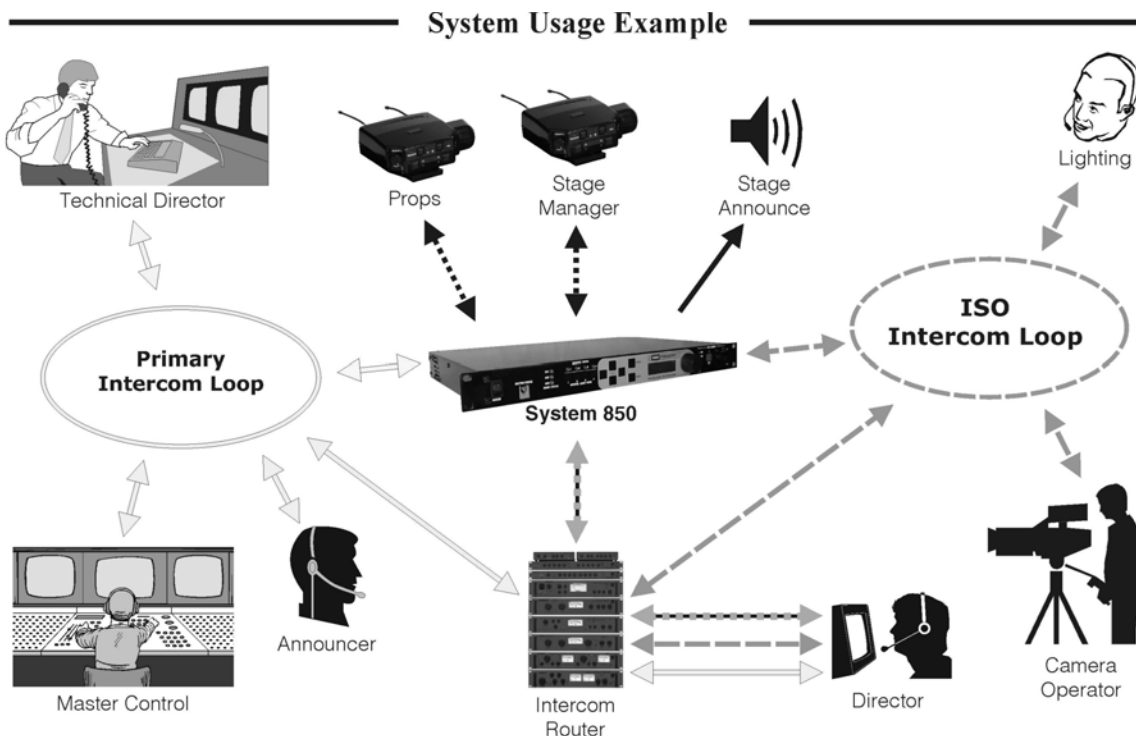

EQUIPMENT FEATURES

Base Station Front Panel Features

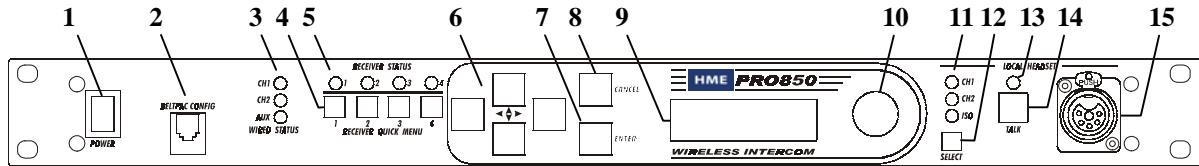

- | | |
|---|---|
| <ol style="list-style-type: none"> 1. POWER switch 2. BELTPAC CONFIGuration connector (RJ10 telephone handset cable connector) 3. WIRED STATUS lights
CH1 = Channel 1 intercom status
CH2 = Channel 2 intercom status
AUX = ISO+ mode 4. RECEIVER QUICK MENU buttons 5. RECEIVER STATUS lights 6. Arrow buttons (move cursor around on menu) 7. ENTER button (selects function or setting) | <ol style="list-style-type: none"> 8. CANCEL button (backs out of menus or cancels operation) 9. Display screen 10. Multi-function knob (headset volume control; adjustment for specific menu selections) 11. Local headset function lights 12. Local headset function select switch 13. Local headset TALK indicator light 14. Local headset TALK switch 15. Local headset connector |
|---|---|

Base Station Rear Panel Features

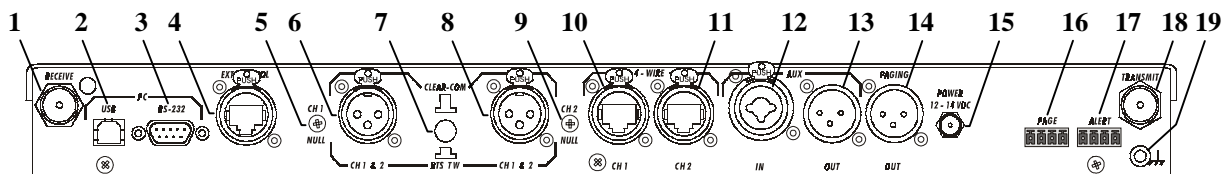

- | | |
|---|--|
| <ol style="list-style-type: none"> 1. Receiver antenna connector 2. USB type-B computer connector 3. 9-pin RS-232 computer connector 4. RS-422 interface (for connecting two or more bases together) 5. Channel 1 null adjustment 6. Channel 1 2-wire intercom interface connector 7. ClearCom RTS select button 8. Channel 2 2-wire intercom interface connector 9. Channel 2 null adjustment 10. Channel 1 RJ45 4-wire intercom interface connector | <ol style="list-style-type: none"> 11. Channel 2 RJ45 4-wire intercom interface connector 12. Auxiliary input connector (accepts XLR plug or standard phone plug) 13. Auxiliary output connector 14. Paging output connector 15. 12-14VDC power jack 16. Page relay connector 17. Alert relay connector 18. Transmitter antenna connector 19. Grounding screw |
|---|--|

Beltpac Top Panel Features

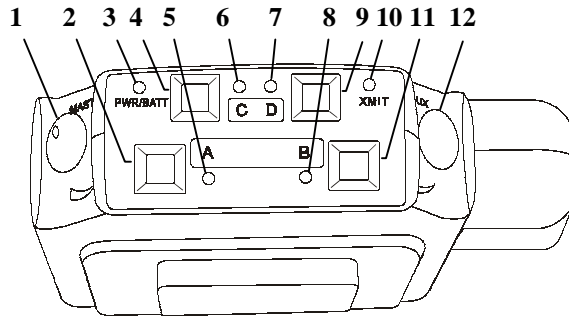

1. Master power/volume control
2. "A" button
3. Power and battery condition indicator
4. "C" button
5. "A" light – indicates Channel 1 active
6. "C" function light
7. "D" function light
8. "B" light – indicates Channel 2 active
9. "D" button
10. Transmit light – indicates transmitter on
11. "B" button
12. Auxiliary volume control

Beltpac Bottom Panel Features

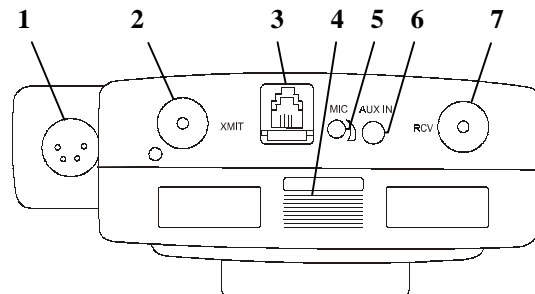

1. Headset connector
2. Transmitter antenna connector
3. Remote configuration connector
4. Battery compartment cover thumb grip
5. Microphone gain adjustment
6. Auxiliary input connector
7. Receiver antenna connector

BLOCK DIAGRAMS

Base Station

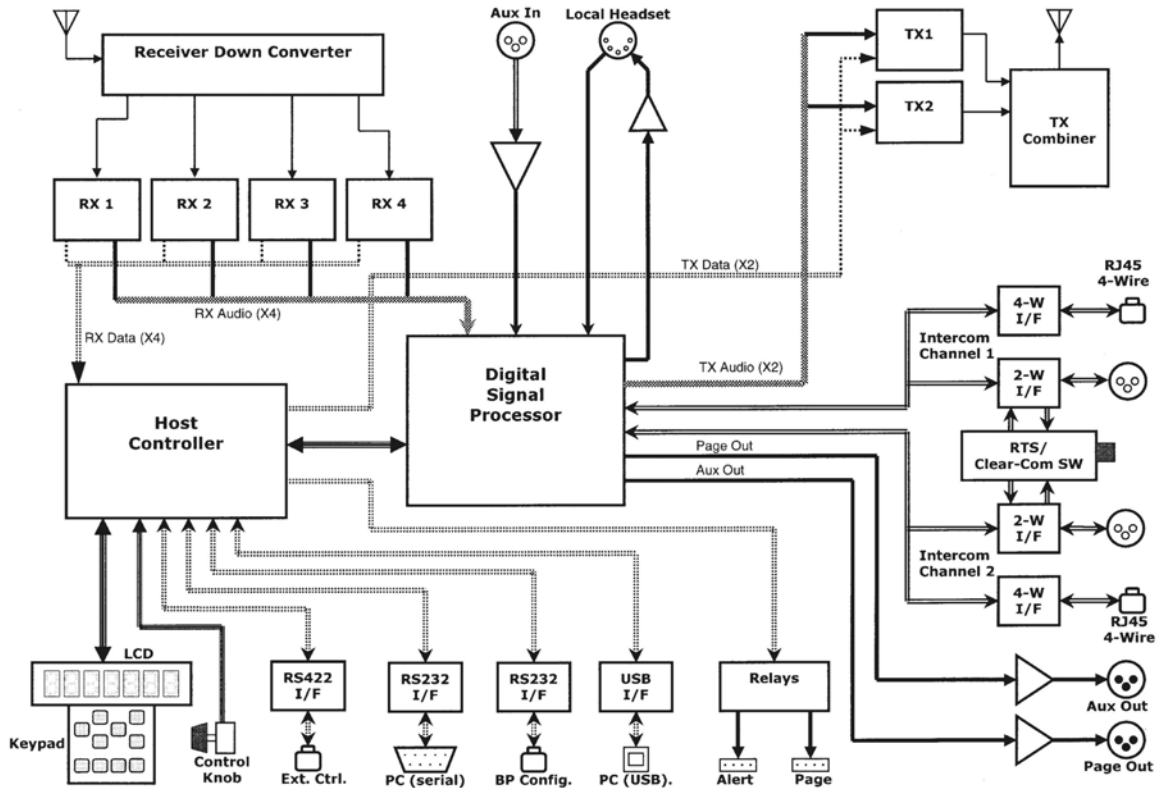

Beltpac

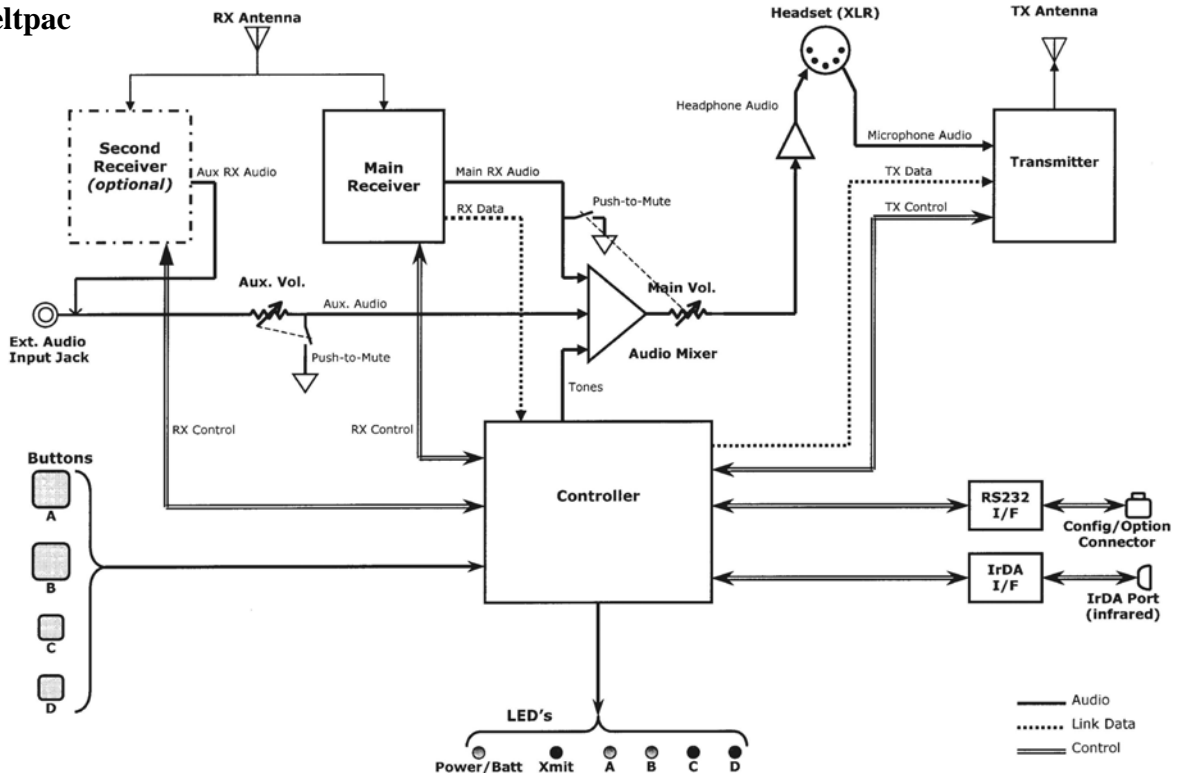

EQUIPMENT SPECIFICATIONS

Base Station

GENERAL —

Frequency Range:	470-608 MHz, 614-740 MHz in 18 MHz TX and RX bands
Frequency Response:	50 Hz to 10 kHz
Power Requirements:	100-240VAC, 50-60Hz or 12-14VDC
Temperature Range:	0-50°C
Size:	19" x 1.72" x 11.5" (1-RU)
Weight:	<11 lbs.
# of Receivers:	1 to 4, configurable
# of Transmitters:	0 to 2, configurable
4-Wire I/O:	RJ45, 600Ω balanced, level adjustable, simultaneous operation with 2-wire
2-Wire I/O:	XLR-3F, externally-switchable RTS® or ClearCom® mode, 200Ω, level adjustable, null adjustable
Auxiliary Input:	XLR-3F/¼" combo jack, 600Ω balanced, level adjustable
Auxiliary Output:	XLR-3M, 600Ω balanced, level adjustable
Paging Output:	XLR-3M, 600Ω balanced, level adjustable
Page & Alert Relay:	2 four-pin Molex, 60W switching capacity (2A @ 30VDC)
Belpac Interface:	RJ10, RS-232
PC Interface:	DB9, RS-232, 38400 baud
USB Interface:	USB 1.1 type B receptacle
External Control Interface:	RJ45, RS-422
Headset Connector:	XLR-4M, Optional field-installable XLR-5F
Mic Input:	Auto-detect, low impedance dynamic or electret microphone
Headset Output:	Stereo – 160mW per side Mono – >200mW into 50Ω
Front Panel Controls:	Power Switch Up, Down, Left, Right, Enter & Cancel Menu Buttons Receiver Quick-Menu Buttons Rotary knob for adjustments Headset channel select & PTT
Front Panel Indicators:	Graphic LCD, 4 Receiver Status LEDs, 3 Intercom Status LEDs, 3 Headset channel select LEDs, Headset PTT LED
Rear Panel Controls:	2-wire channel line null RTS®/ClearCom® mode switch

TRANSMITTER —

Type:	720 synthesized, 25 kHz channel steps
Transmit Power:	240, 100, 10 or 1 mW
Modulation Type:	FM
Deviation:	50 kHz
Occupied Bandwidth:	190 kHz maximum
Frequency Stability:	10 ppm
Harmonics/Spurious:	Exceeds FCC specifications
Antenna Type:	¼-wave whip (supplied) or external (BNC connector)

RECEIVER —

Type:	720 synthesized, 25 kHz channel steps
RF Sensitivity:	<1 μ V for 20dB SINAD
Squelch:	Adjustable
Image Rejection:	60dB
Squelch:	Data channel coded plus carrier signal level
Squelch Quieting:	90dB
Frequency Stability:	10 ppm
Distortion:	<1% at maximum deviation
Antenna Type:	¼-wave whip (supplied) or external (BNC connector)

Beltpac**GENERAL —**

Frequency Range:	470-608 MHz, 614-740 MHz in 18 MHz TX and RX bands
Antenna Type:	Flexible ¼-wave, field-replaceable
Frequency Response:	50 Hz to 10 kHz
Battery Requirements:	6 “AA” Alkaline Cells (Optional NiMH)
Battery Life:	PTE – Up to 9 hours (alkaline), PTT – Up to 15 hours (alkaline)
Temperature Range:	0-50°C
Weight:	16 oz with batteries
Base Interface:	RJ10, RS-232
PDA Interface:	IrDA
Auxiliary Input:	Connector: 1/8” miniature phone jack Impedance: 10k Ω Receive Level: 100mV minimum Overrides optional 2nd receiver if installed
Headset Connector:	XLR-4M, Optional field-installable XLR-5F
Mic Input:	Auto-detect, low impedance dynamic or electret microphone
Headset Output:	200mW @ 1% THD into 50 Ω , capable of driving 8-400 Ω
Controls:	Main Volume Control with power switch and push-to-mute, 2nd RCVR/Ext. Volume Control with push-to-mute, 4 mode/function switches Microphone gain adjustment
Indicators:	Power/low battery LED, Transmit LED, 2 channel LEDs, 2 function LEDs

TRANSMITTER —

Type:	Synthesized, 720 25 kHz channel steps
Transmit Power:	100, 50, 10 or 1 mW Configurable for fixed output or automatic power control
Transmission Modes:	Push-to-talk (PTT), push-to-talk-shared (PTS), or push-to-enable (PTE) May be configured for momentary or latch mode
Modulation Type:	FM
Deviation:	50 kHz
Occupied Bandwidth:	190 kHz maximum
Frequency Stability:	10 ppm
Harmonics/Spurious:	Exceeds FCC specifications

RECEIVER —

Type:	Synthesized, 720 25 kHz channel steps
RF Sensitivity:	<1 μ V for 20dB SINAD
Image Rejection:	60dB
Squelch:	Adjustable carrier signal level
Squelch Quieting:	80dB
Frequency Stability:	10 ppm
Distortion:	<1% at maximum deviation

SECTION 2. EQUIPMENT SETUP

BASE STATION SETUP

Connect equipment and make adjustments described below to the rear panel of the base station where indicated on this illustration.

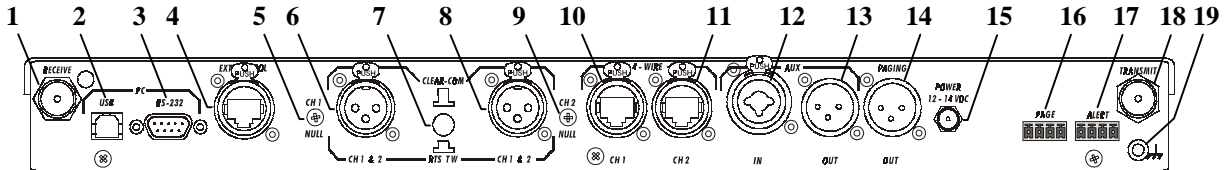

1. **RECEIVE Antenna Connector** — Connect the receiver antenna to this BNC connector. The color band (if present) around the antenna should match the color dot (if present) near the connector on the base.
2. **USB Interface Connector** — To interface the PRO850 with a PC using a computer interconnect cable with a USB 1.1 compliant type-B connector, connect the cable from this connector to the PC.
3. **RS-232 Interface Connector** — To interface the PRO850 with a PC using a computer interconnect cable with a 9-pin RS-232 serial interface connector, connect the cable from this connector to the PC.
4. **Multiple Base Station Interface Connector** — Use this RS-422 serial interface to connect master and slave base stations together.

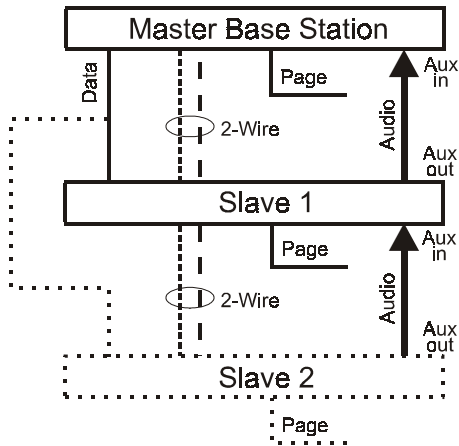

Master-Slave Base Station Configuration

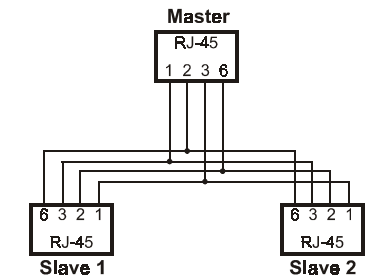

Data Cable Configuration for More Than One Slave Base Station

In the **2-Wire ISO+** mode, the headset connector on the front panel of the base station is disabled from normal headset functions and becomes available for connection to devices other than a headset.

In the **2-Wire** mode;

- If you have an RTS system, only one 2-wire cable is needed for connecting bases. The switch on the back panel of the base station must be set for **RTS TW**. One cable carries both CH1 and CH2.
- If you have a ClearCom system, two cables are needed for connecting base stations. The switch on the back panel of the base station must be set for **CLEAR-COM**.

In all multibase configurations, connect the Aux Out from Slave 1 to the Aux In of the Master Base Station and connect the Aux Out from Slave 2 (if present) to the Aux In of Slave 1.

5. **Channel 1 Line Nulling Control** — Use this adjustment to null the Channel 1, 2-wire connection when attached to other cabled intercom devices. This control is active even if the 4-wire only mode is selected.

6. **Channel 1 2-Wire Intercom Connector** — Provides 3-pin female XLR connector for interfacing other cabled intercom devices to Channel 1 on the PRO850.

NOTE: PRO850 does not provide or require 2-wire line power.

RTS® Mode:	Pin 1 = Common	ClearCom® Mode:	Pin 1 = Common
	Pin 2 = Channel 1		Pin 2 = N/C
	Pin 3 = Channel 2		Pin 3 = Channel 1

7. **ClearCom®/RTS® Select Button** — In position = RTS® Mode Out position = ClearCom® Mode

8. **Channel 2 2-Wire Intercom Connector** — Provides 3-pin female XLR connector for interfacing other cabled intercom devices to Channel 2 on the PRO850.

NOTE: PRO850 does not provide or require 2-wire line power.

RTS® Mode:	Pin 1 = Common	ClearCom® Mode:	Pin 1 = Common
	Pin 2 = Channel 1		Pin 2 = N/C
	Pin 3 = Channel 2		Pin 3 = Channel 2

9. **Channel 2 Line Nulling Adjustment** — Use this adjustment to null the Channel 2, 2-wire connection when attached to other cabled intercom devices. This control is active even if the 4-wire only mode is selected.

10. **Channel 1 RJ45 4-wire Intercom Interface Connector** — Use this RJ45 connector for 600Ω balanced interface of PRO850 Channel 1 with other cabled intercoms. Pin designations are as follows.

Pins 1, 2, 7 & 8 have no connection
 Pin 3 = Intercom Out +
 Pin 4 = Intercom In +
 Pin 5 = Intercom In –
 Pin 6 = Intercom Out –

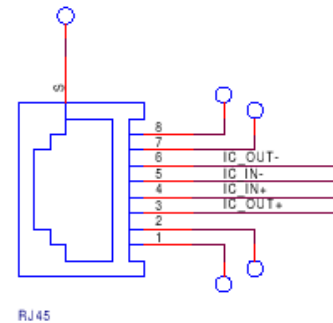

11. **Channel 2 RJ45 4-wire Intercom Interface Connector** — Same as #10, but for Channel 2.

12. **Auxiliary Input Connector** — Use this 3-pin female XLR/standard-phone-jack connector for balanced +20dBV maximum auxiliary audio input.

Pin 1 = Ground
 Pin 2 = Audio +
 Pin 3 = Audio –

13. **Auxiliary Output Connector** — Use this 3-pin male XLR connector for balanced +20dBV maximum auxiliary audio output.

Pin 1 = Ground
 Pin 2 = Audio +
 Pin 3 = Audio –

14. **Paging Output Connector** — Use this 3-pin male XLR connector for balanced +20dBV maximum paging audio output.

Pin 1 = Ground
 Pin 2 = Audio +
 Pin 3 = Audio –

15. **12-14VDC Power Jack** — Use this connector for DC power input.

16. **Page Relay Connector** — Use this 4-pin Molex connector for relay closure based on belt pac page control. Switching capacity of the relay is 60W (2A @ 30VDC). Pin designations are as follows.

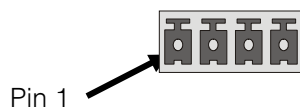

Pin 1 = Common
 Pin 2 = Normally Closed
 Pin 3 = Normally Open
 Pin 4 = Ground

17. **Alert Relay Connector** — Use this 4-pin Molex connector for relay closure based on alert conditions. Switching capacity of the relay is 60W (2A @ 30VDC). Pin designations are the same as for #16 above.

18. **TRANSMIT Antenna Connector** — Connect the transmitter antenna to this BNC connector. The color band (if present) around the antenna should match the color dot (if present) near the connector on the base.

19. **Grounding Screw** — If necessary, tie this connector to earth ground.

SECTION 3. PRO850 OPERATION

BASE STATION OPERATION

Uses of Front Panel Controls, Indicators and Connectors

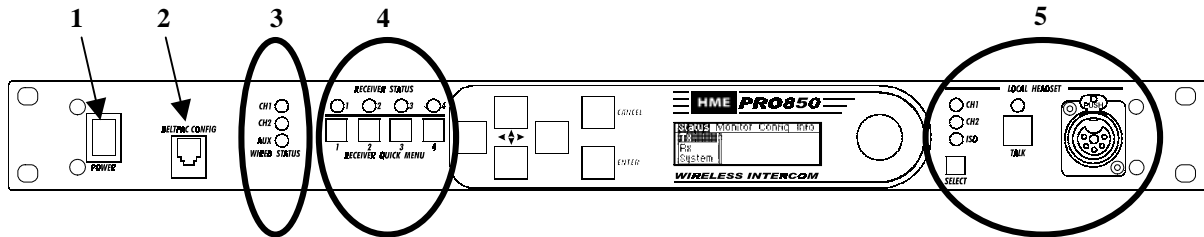

1. Power Switch

Press the upper part of the switch to turn the power on. A red light on the switch will be lit when the base station power is on. Press the lower part of the switch to turn the power off. The red light will go off.

2. Belpac Configuration Connector

After belpac configuration settings have been made in the base station, plug one end of the enclosed RJ10 interconnect cable into this connector, and plug the other end into the RMT receptacle on the bottom of a belpac to upload the settings into the belpac. Repeat this to upload settings for each belpac to be used.

CAUTION: Be sure not to turn the belpac power off and on again while it is connected to the base station. If this does happen, unplug the cable and cycle the belpac power again.

3. Wired Status Indicator Lights

CH1 and CH2 lights:

If a 4-wire intercom channel is enabled, the respective CH1/CH2 light will blink when the PRO850 is sending audio on that intercom line.

If a 2-wire interface channel is enabled, the respective CH1/CH2 light will be on steady when the user is not talking. When the user is talking, the light will be on steady and blinking off.

AUX light:

The auxiliary light indicates use of the ISO+ mode. When ISO+ is on, the AUX light will be on steady. When someone is talking on the ISO channel, the light will be on steady and blinking off.

4. Receiver Status Indicators and Buttons

RECEIVER STATUS lights 1 – 4:

Steady red if the respective receiver squelch is turned down, or if it is receiving a signal (squelch is open).

Blinking amber when the respective receiver is receiving status update from a belpac.

Steady green when the belpac user is talking through the receiver.

Blinking red or green if the belpac being received has a low battery condition.

RECEIVER QUICK MENU buttons 1 – 4:

When pressed, squelch and audio controls for the respective receiver are provided immediately on the display screen.

5. Local Headset Connector and Controls

Plug your local headset connector into the receptacle at the right end of the PRO850 front panel.

Use the SELECT button to choose communication channels CH1, CH2, CH1 and CH2 together, or ISO.

The respective indicator light above the button will remain lit for the selection you make.

Press and release the TALK button quickly to “latch on” for open communication. Press and release the button again quickly to “latch off.”

Press and hold the TALK button for more than one second for momentary communication. In this mode, the selected channel will remain open only as long as you are pressing the TALK button.

Display Screen Navigation

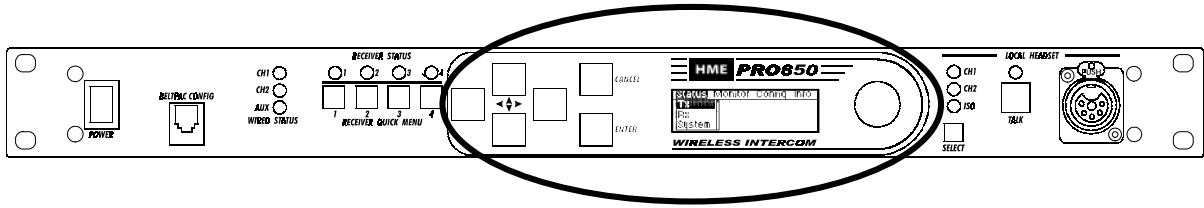

To navigate through PRO850 screen displays, use the ◀▶▲▼, *ENTER* and *CANCEL* buttons and the control knob adjacent to the screen as follows.

- ◀▶ Use the left and right arrow buttons to move through horizontal selections on the bar at the top of the main menu, and to move to the left and right on advanced screens.

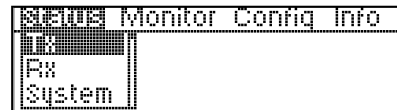

Main Menu

- ▲▼ Use the up and down arrow buttons to move through vertical selections on the main menu, such as **Tx**, **Rx** and **System**, and to move up and down on the screen.



The bar next to vertical selections has an indicator in it that moves up or down as you use the up and down arrow buttons to move through selections. The indicator will move up and down the bar in increments, from the top of the bar for the first selection to the bottom of the bar for the last selection.

NOTE: Holding an arrow button continuously will allow you to move rapidly through selections.

- ▲▼ When a **cursor** appears on the screen, use any of the four arrow buttons to move it around to desired selectable items, or to change the content of a box adjacent to the cursor.

Currently selected items are highlighted.

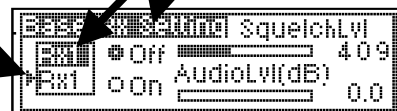

Use the *ENTER* button to make a selection indicated by a cursor or highlighted button (e.g. Off/On), or to advance to the next screen from a highlighted selection.

Use the *CANCEL* button to move back to a previous screen. Press *CANCEL* repeatedly to return to the main menu.

Use the **control knob** to adjust values selected with the cursor such as frequencies, squelch levels and auxiliary output mix levels.

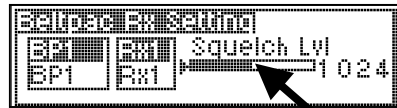

Use the **control knob together with the up and down arrow buttons** to change numbers such as frequency numbers, or words such as belt pac user names in selected boxes. The arrow buttons move highlighted numbers left and right, while the control knob changes the numbers, letters or symbols.

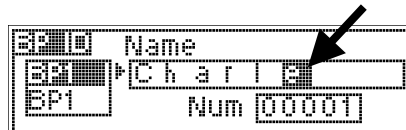

Display Screen Functions and System Settings

Status displays provide information indicating the status of the system, or of parts or functions of the system.

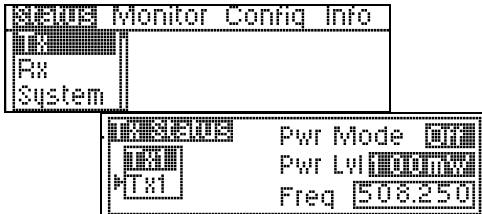

Transmitter Status:

Select transmitter 1 or 2, then press the **ENTER** button to obtain the status of the selected transmitter.

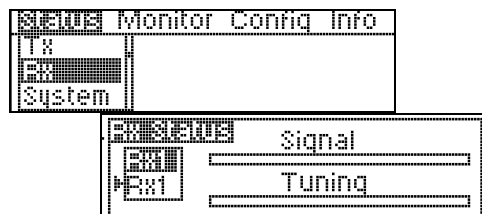

Receiver Status:

Select receiver 1 through 4, then press the **ENTER** button to observe signal and tuning levels at the selected receiver.

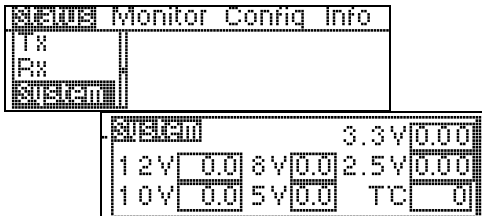

System Status:

Base station power supply voltages are shown. The **12V** box shows the actual input voltage supplied to the base station. The **T°C** box shows base station internal temperature in degrees Celsius.

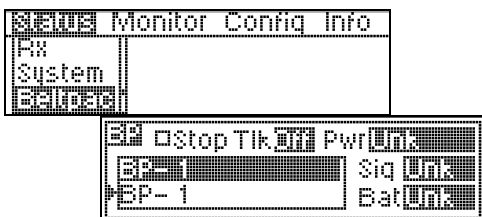

Beltpac Status:

Select a beltpac by the name or number shown, then press the **ENTER** button to obtain its status.

Select **Stop Tlk** to stop a latched-on beltpac from transmitting.

The **Pwr** box shows the current transmitter power level of the selected beltpac.

The **Sig** box indicates how well the beltpac is receiving transmission (Low, OK or High) from the base station.

The **Bat** box shows battery status of the selected beltpac (OK, Low or Dead).

NOTE: In Push-To-Talk (PTT) or Push-To-Enable (PTE) modes, beltpacs automatically update status to the base station every 5 seconds. In Push-To-Share (PTS) mode, beltpacs only update status while they are transmitting. If no transmission is received from a beltpac within 20 seconds, its status will be shown as Unk (unknown). Also, if a beltpac is out of range, or its power is off, its status will be shown as Unk.

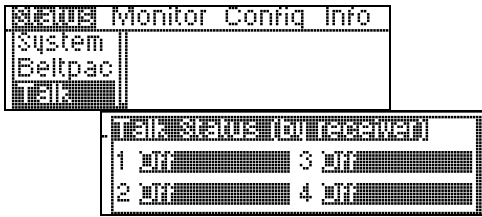

Talk Status:

Belpac user identification is shown when belpac user is pressing Talk button.

Monitor displays provide input/output levels and input level adjustments for all devices connected to the base station.

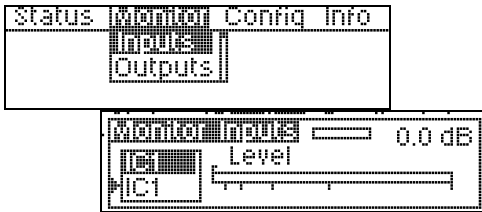

Monitors Audio Levels at Base Station Inputs:

Select the desired input source, then move the cursor to the bar at the top of the screen. Use the control knob to adjust the audio input level from the selected source in 1.5dB increments.

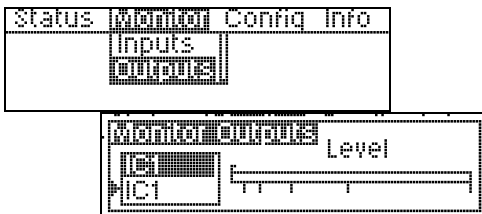

Monitors Audio Levels at Base Station Outputs:

Use the up/down arrow button to view the output level from the DSP of the desired output to be monitored.

Configuration displays provide customized configuration settings for the base station and belt-pacs. They also allow you to save your settings to a file for future access. Advanced settings are provided for output mixing, alert signals and paging capabilities. Belt-pac ID name and number settings made at the main base station can be synchronized in added slave base stations via the Configuration, Sync Bases display.

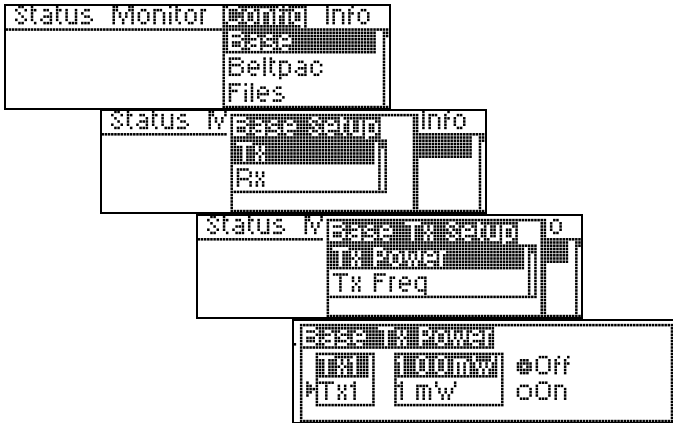

Base Station Transmitter Power:

Select transmitter 1 or 2, then press the **ENTER** button.

At the power level box, select 1, 10, 100 or 250mW, then press ENTER. To change the Off/On status of the transmitter, select the Off or On button, then press ENTER.

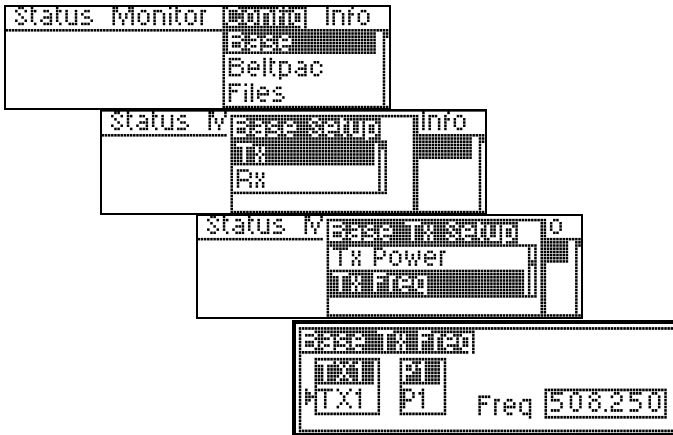

Base Station Transmitter Frequency:

Frequencies P1 – P4, S1 – S4 and T1 – T4 are preset in the system and cannot be changed. Frequencies U1 – U5 can be set by the user.

Select transmitter TX1 or TX2, then select a frequency for that transmitter. If you select a user frequency, U1 – U5, move the cursor to the frequency box and use the up and down arrow buttons together with the control knob to select a frequency. User frequencies can be selected in 25kHz increments.

NOTE: Frequencies within the same group (P, S or T) are compatible with each other and free of intermodulation.

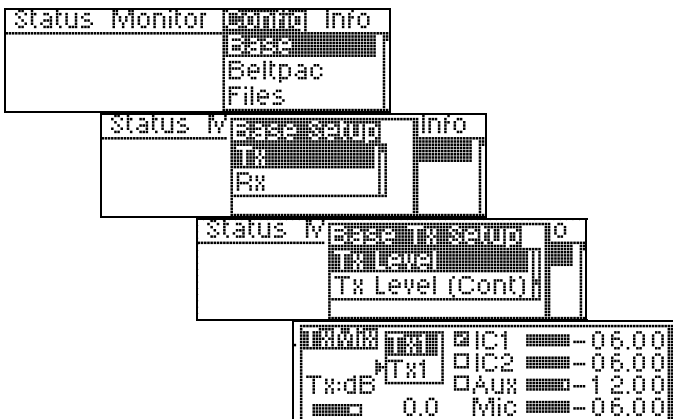

Base Station Transmitter Mix Levels:

Select transmitter 1 or 2, then press the **ENTER** button.

Use the left arrow button to select the Tx box, then use the control knob to adjust the transmitter master level in 1.5dB increments.

Select the box next to IC1, IC2 and Aux to enable that input in the output mix. Mic is a standard output.

Place the cursor to the left of any slider bar and use the control knob to adjust each output level in increments of .25dB (fine) or 2.25dB (coarse).

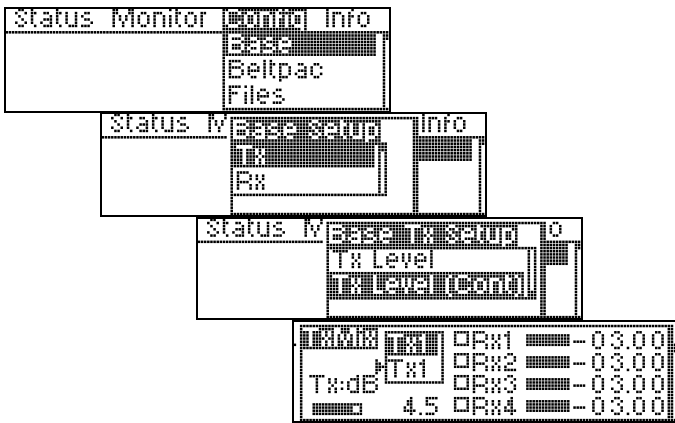

Base Station Transmitter Mix Levels (continued):

Select transmitter 1 or 2, then press the **ENTER** button.

Use the left arrow button to select the **Tx:dB** box, then use the control knob to adjust the transmitter output level in 1.5dB increments.

Select the box to the left of RX1 through RX4, to continuously enable a particular receiver to the transmitter. **NOTE:** Leave these boxes unchecked for normal operation.

Place the cursor to the left of any slider box and use the control knob to adjust each output level in increments of .25dB (fine) or 2.25dB (coarse).

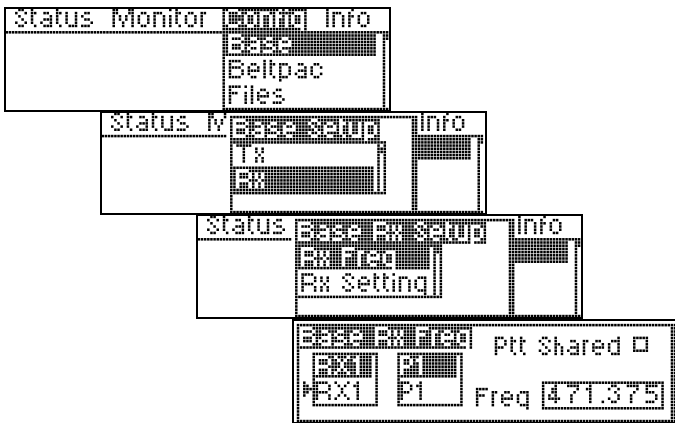

Base Station Receiver Frequency:

Frequencies P1 – P4, S1 – S4 and T1 – T4 are preset in the system and cannot be changed. Frequencies U1 – U5 can be set by the user.

Select receiver RX1 or RX2, then select a frequency for that receiver. If you select a user frequency, U1 – U5, move the cursor to the frequency box and use the up and down arrow buttons together with the control knob to select a frequency. User frequencies can be selected in 25kHz increments.

For multiple beltpacs to share a receiver frequency (PTS), check the **Ptt Shared** box.

NOTE: Frequencies within the same group (P, S or T) are compatible with each other and free of intermodulation.

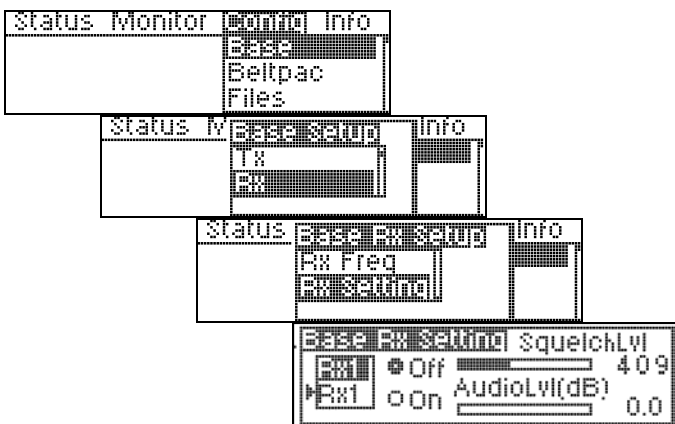

Base Station Receiver Control:

Select a receiver and select the **Off** or **On** button to turn it off or on. Use the up and down arrow buttons together with the control knob to adjust the squelch and audio levels.

NOTE: The amount of gain applied here to receiver audio level at input of DSP will also be shown on the Monitor Input display screen for that receiver.

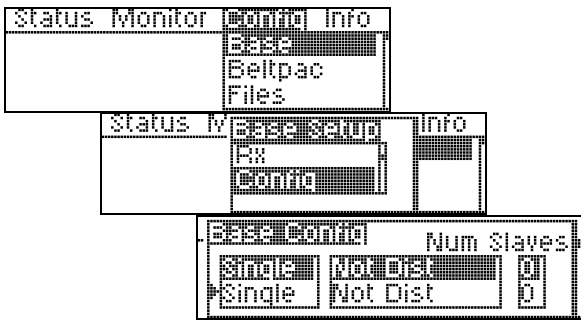

Single Base Station Configuration:

Select **Single, Not Dist** for a single base station without the ISO+ feature for communication only among belt-pacs.

Select **Single, ISO+** for a single base station with the ISO+ feature for communication among belt-pacs and auxiliary input and output (Aux In/Out) connections.

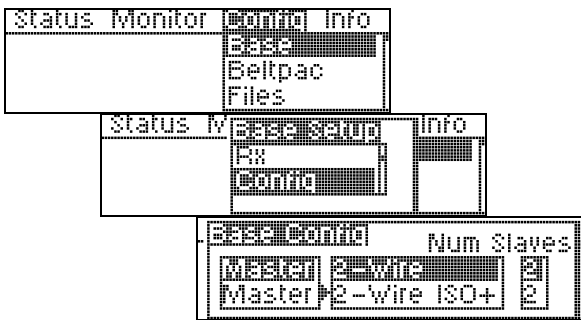

Master / Slave Base Station Configuration:

If Master and Slave base stations will be used, there can only be one master base station, with one or two slaves. Select Master, Slave 1 or Slave 2, then select the multibase wiring configuration; 2-Wire, 2-Wire ISO+ or Aux Dist.

Master:

In the **2-Wire ISO+** mode, belt-pacs having a button configured for Talk Aux must transmit on frequencies for the master base station for the feature to work.

Slaves:

In the **Aux Dist** mode, belt-pacs on slave base stations can only talk on the same channel at once. If they try to talk on a different channel than the user already talking, they will hear a busy signal in their belt-pac headset.

A slave cannot have slaves. Therefore, when Slave 1 or 2 is selected, the **Num Slaves** (number of slaves) will automatically be 0.

If a slave base station has a transmitter installed, it must be turned off. See **Base TX** setup.



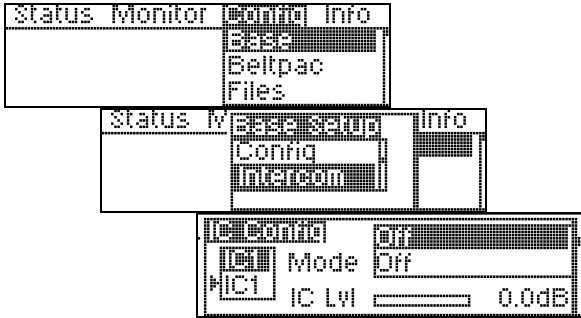

Base Station Intercom Configuration:

Select intercom IC1 or IC2, then use the up and down buttons to select what mode the intercom is in.

Select the **IC Lvl** box, and use the control knob to adjust the input gain level.

NOTE: If the Mode is set to Off, the input and output of that intercom will be off. If set for 2-wire, both 2 and 4-wire will be active. If set for 4-wire, only 4-wire interface will be active.

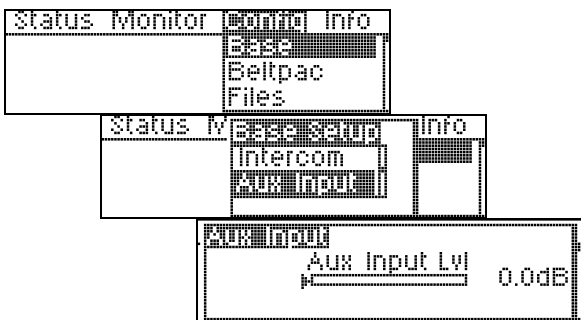

Base Station Auxiliary Input Level:

Use the control knob to adjust the auxiliary input level. Any change made here will be reflected in the Monitor Input display for Aux Input.

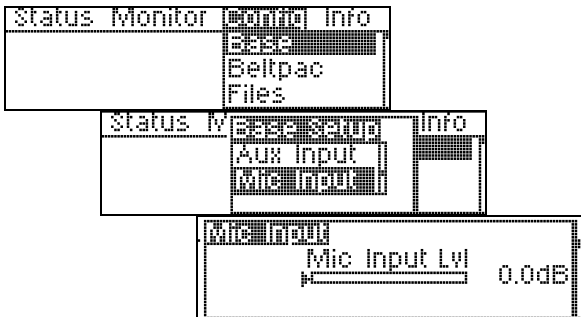

Base Station Microphone Input Level:

Use the control knob to adjust the front-panel headset microphone input level. Any change made here will be reflected in the Monitor Input display for the Mic Input.

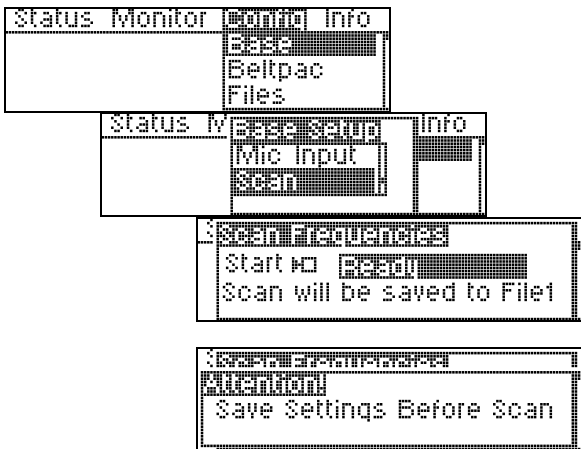

Frequency Scan:

Connect a belt pac to the BELTPAC CONFIG connector on the front panel of the base station to enable scanning of base transmit frequencies.

In this operation, the belt pac and base station receivers are scanned to find the cleanest group of frequencies for the base station to transmit on, and they are assigned to TX1 and TX2 in the base station. Also, based on the number of receivers in the system (up to 12), it determines the best group of frequencies for the base station(s) to receive on. Those frequencies are distributed (first-come, first-served) to the belt pacs (with the assumption that 16 belt pacs will be used) as belt pac transmit frequencies. Belt pac receiver frequencies are always the same as the base station TX1 and TX2 frequencies.

Belt pac frequency settings will not be operational until they are uploaded to the belt pacs, which should be done after completion of belt pac configuration settings.

These settings will automatically be saved to **File 1** as active settings for the base station until the frequencies are scanned again. They can also be saved to another file name for future use.

To begin frequency scanning, press the **ENTER** button.

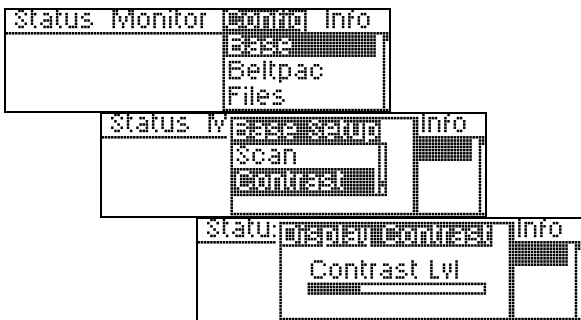

Base Station Display Contrast Level:

Use the control knob to adjust the base station display screen contrast level.

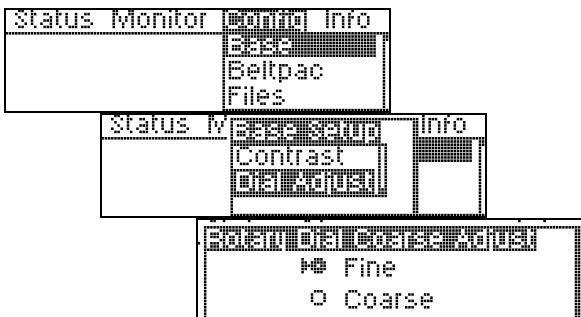

Base Station Dial Adjustment Setting:

Select Fine or Coarse for the control knob, for mix level dial adjustments. In the Fine mode, mix level adjustments made by the control knob occur in 0.25dB increments. In the Coarse mode, they occur in 2.25dB increments.

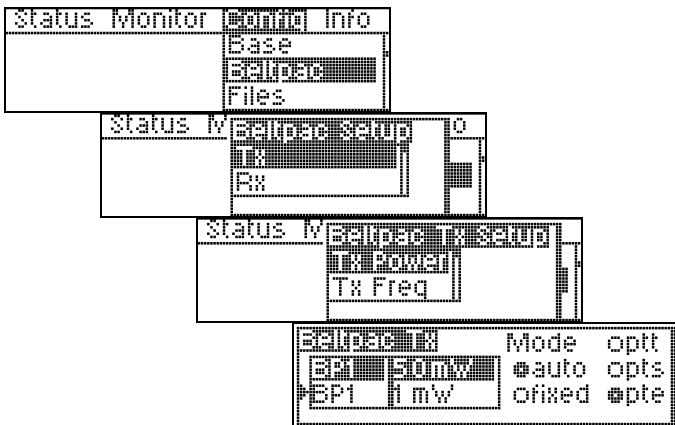

Beltpac Transmitter Power:

Select the desired beltpac and its transmitter power level (1, 10, 50 or 100mW).

Select the transmit mode and press the **ENTER** button.

NOTE: Settings for beltpacs B1-B16 are stored in the base station. Changes to beltpac settings will not be effective until they are uploaded to the beltpac. BPCN is the beltpac that is plugged into the base station, therefore changes to its settings are effective immediately.

In the **auto** mode, transmitter power will be automatically controlled by the base station, changing between 1 and the specified maximum. In the **fixed** mode, the setting you select will not change.

If you select **ptt**, the beltpac transmitter will be on briefly every 5 seconds to transmit status. If you select **pts**, the beltpac will only transmit while a user is talking. If you select **pte**, the beltpac will transmit constantly.

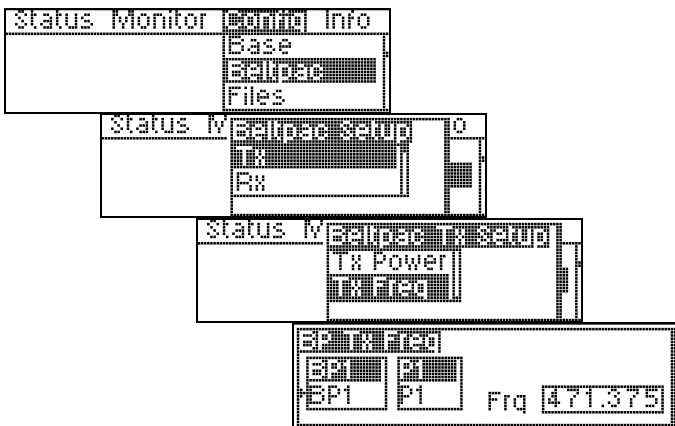

Beltpac Transmitter Frequency:

Select the desired beltpac and the transmitter frequency for that beltpac's operation (P1-12, S1-12, T1-12 and U1-16). If U1-16 is selected, use the control knob and the up and down arrow buttons to select the desired frequency, in 25kHz increments.

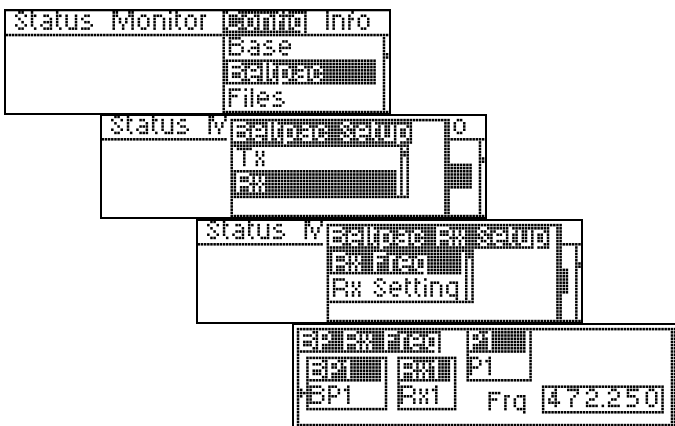

Beltpac Receiver Frequency:

Select the desired beltpac and the receiver frequency for that beltpac's operation (P1-4, S1-4, T1-4 and U1-16). If U1-16 is selected, use the control knob and the up and down arrow buttons to select the desired frequency, in 25kHz increments.

NOTE: RX1 is for intercom CH1. RX2 is for intercom CH2. Normally beltpac RX1 is the same as base station TX1, and beltpac RX2 is the same as base station TX2.

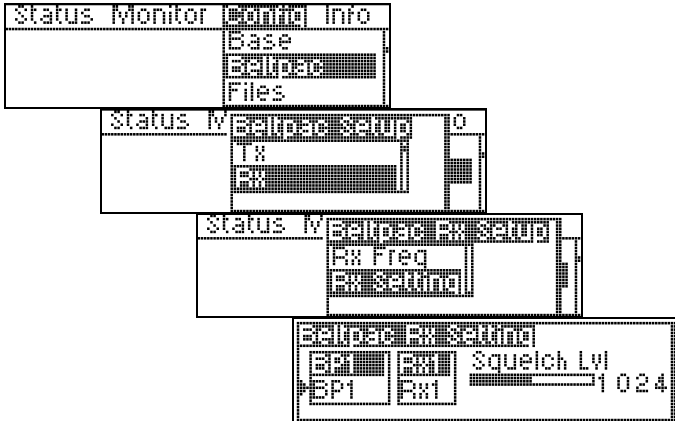

Belpac Receiver Squelch Level:

Select the belpac and receiver, then use the control knob to adjust its squelch level.

NOTE: RX2 is reserved for a second receiver, when a belpac has two receivers.

BPCN is the belpac that is plugged into the base station, therefore adjustments to its squelch level are effective immediately.

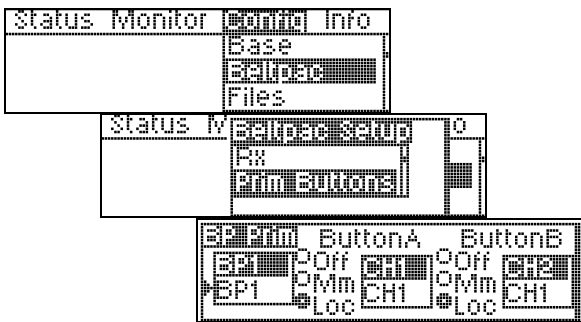

Belpac Buttons A and B Setup:

Select the belpac and select the desired functions for Button A and Button B on each belpac.

- CH1 = Talk, Channel 1
- CH2 = Talk, Channel 2
- Curr = Talk, Current Channel
- ISO = Talk, ISO/ISO+
- Page = Talk, Page (Stage announcement)
- Aux = Talk, Auxiliary Out

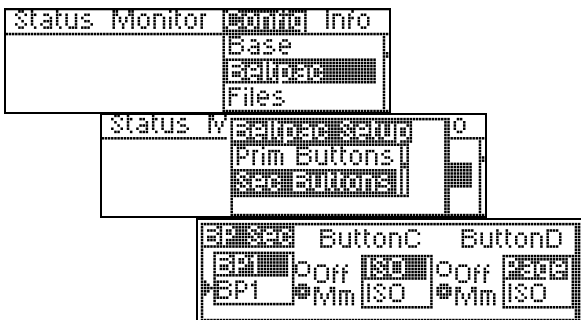

Belpac Buttons C and D Setup:

Select the belpac and select the desired functions for Button C and Button D on each belpac.

- ISO = Talk, ISO/ISO+
- Page = Talk, Page (Stage announcement)
- Aux = Talk, Auxiliary Out
- Chan = Toggle CH1/CH2
- Call = Call Signal
- Alert = Alert Signal

NOTE: Call and Alert Signals only function while the Talk function is active.

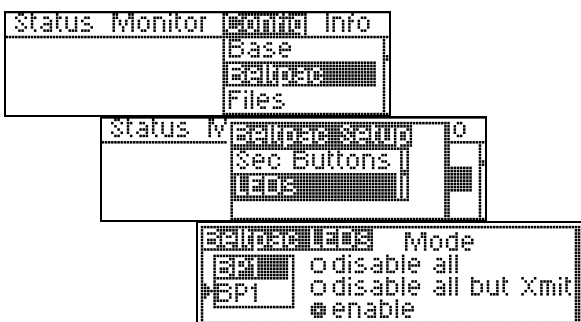

Belpac LED settings:

Select the belpac and select the desired functions the LEDs on each belpac.

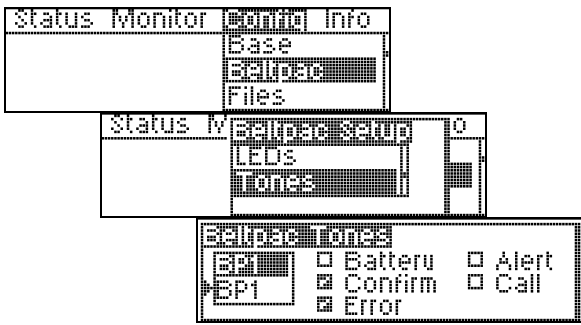

Belpac tone settings:

Select a belpac, then select the events for which you would like tones to sound in that belpac user's headset.

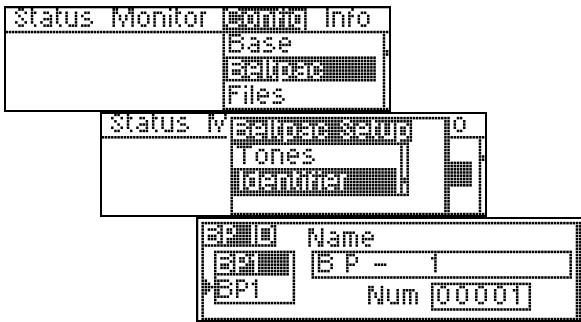

Belpac user identifier settings:

To assign identification to a belpac, such as a user's name, select a belpac then use the arrow buttons and selector knob to assign a name and number to each belpac.

NOTE: Each belpac must have a different number, and each assigned number must be programmed into the base, or the base will not recognize the belpac.

Names can also be used if desired.

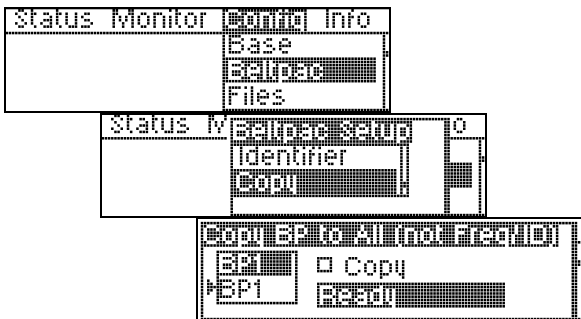

Copy Belpac Settings:

To copy settings from one belpac to all others for all settings except ID numbers, names and frequencies, select Copy and press the **ENTER** button.

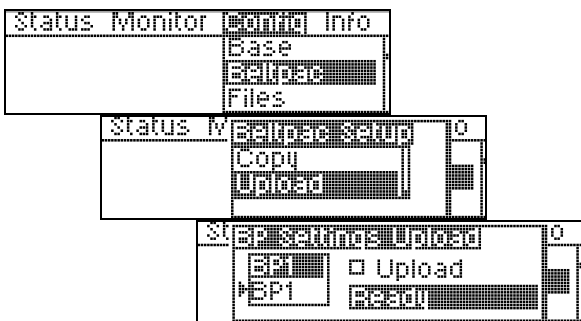

Upload Belpac Settings:

To upload all belpac settings from the base station to a belpac, select a belpac then select the upload box and press the **ENTER** button.

NOTE: A belpac must be connected to the BELTPAC CONFIG connector on the front panel of the base station to enable uploading of belpac settings.

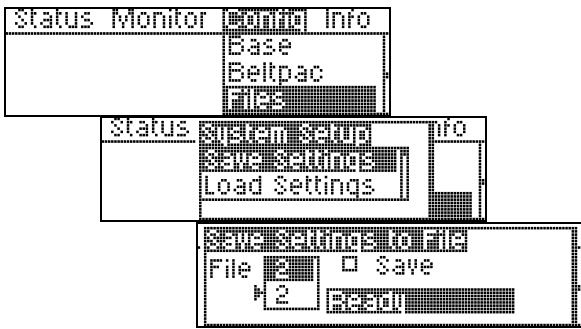

Save Configuration Settings to File:

To save your configuration settings to a file, select the **File** number then select **Save** and press the **ENTER** button.

NOTE: File number 1 is reserved for frequency scans. Files can be saved to 2 through 10.

Be sure to save any changes before turning a base station off. Files are not automatically saved when the power is turned off.

The last file used before a base station is turned off will be used the next time the base station is turned on.

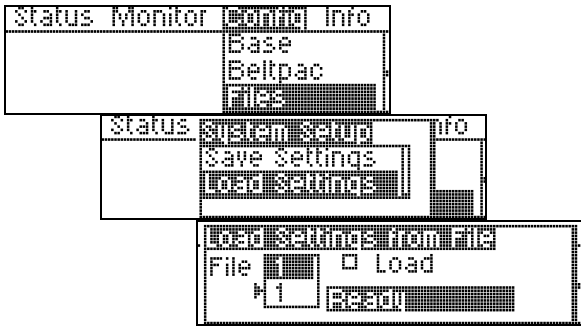

Load Configuration Settings from File:

To load configuration settings from a previously saved file, select the **File** number then select **Load**. When the settings have been successfully loaded, **Ready** will be replaced by **Busy**, then **Success**.

After loading settings, that file becomes the current file and will be used again if the power is turned off.

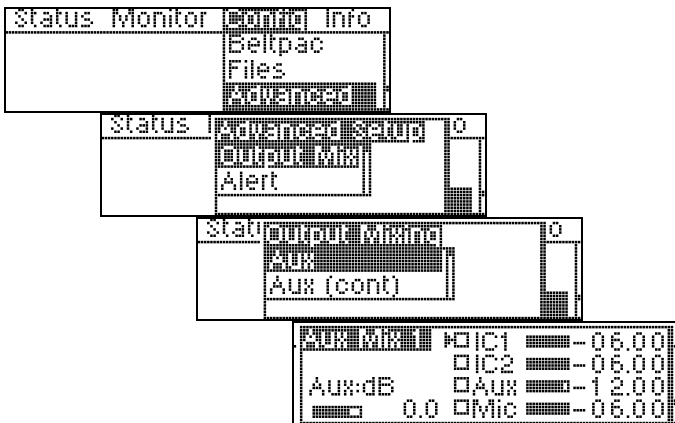

Auxiliary Output Mixing:

Select the box next to IC1, IC2, Aux and/or Mic to enable input, then use the control knob to adjust output level in 0.25dB or 2.25dB increments for the desired mix.

Place the cursor to the left of the bar below Aux:dB and use the control knob to adjust the overall Aux audio output level in 1.5dB increments.

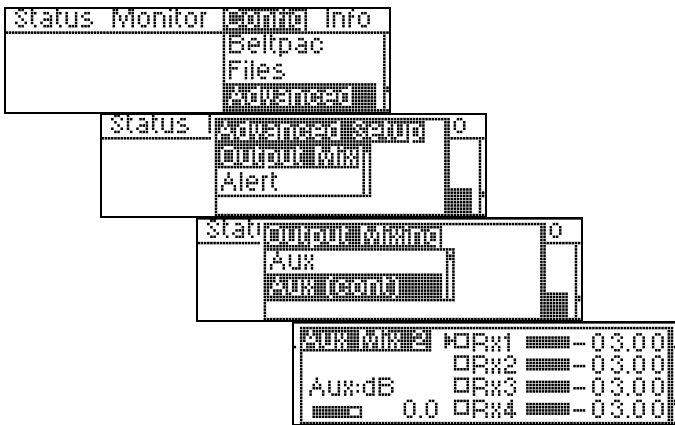

Auxiliary Output Mixing (continued):

Select the box(es) next to RX1-RX4, then use the control knob to adjust output level in 0.25dB or 2.25dB increments for the desired mix.

Check these boxes only if you want receiver audio continuously fed to the Aux Output. Leave them unchecked for normal operation.

Place the cursor to the left of the bar below Aux:dB and use the control knob to adjust the overall Aux audio output level in 1.5dB increments.

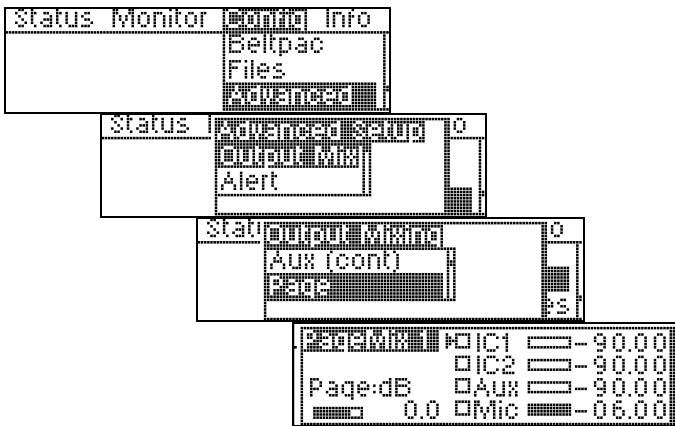

Page Output Mixing:

Select the box next to IC1, IC2, Aux and/or Mic to enable input, then use the control knob to adjust output level in 0.25dB or 2.25dB increments for the desired mix.

Place the cursor to the left of the bar below Page:dB and use the control knob to adjust the overall Page audio output level in 1.5dB increments.

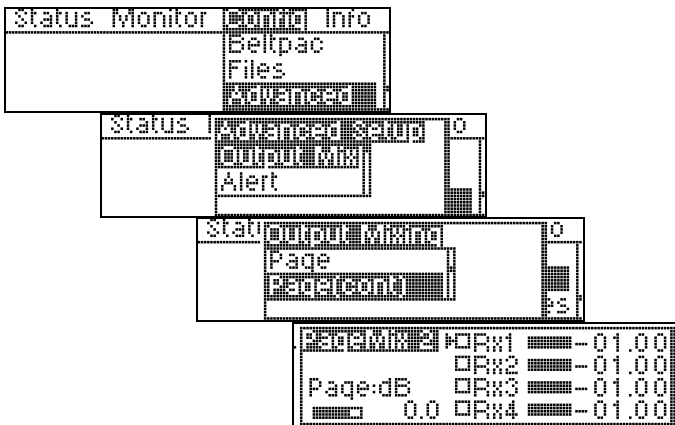

Page Output Mixing (continued):

Select the box(es) next to RX1-RX4, then use the control knob to adjust output level in 0.25dB or 2.25dB increments for the desired mix.

Check these boxes only if you want receiver audio continuously fed to the Page Output. Leave them unchecked for normal operation.

Place the cursor to the left of the bar below Page:dB and use the control knob to adjust the overall Page audio output level in 1.5dB increments.

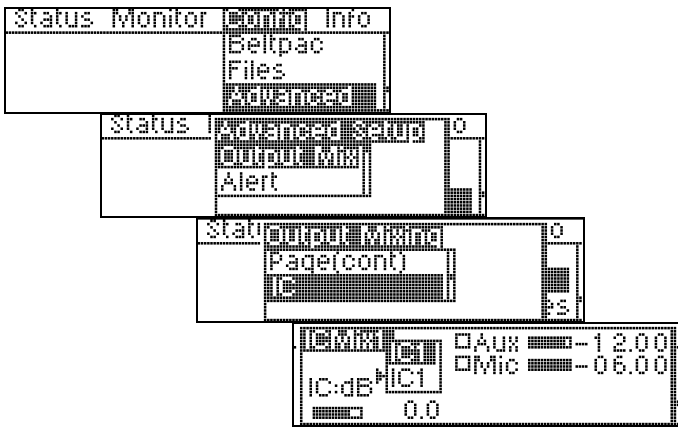

Intercom Output Mixing:

Select IC1 or IC2, then select the box next to Aux and/or Mic to enable input. Use the control knob to adjust output level in 0.25dB or 2.25dB increments for the desired mix.

Place the cursor to the left of the bar below IC:dB and use the control knob to adjust the overall IC audio output level in 1.5dB increments.

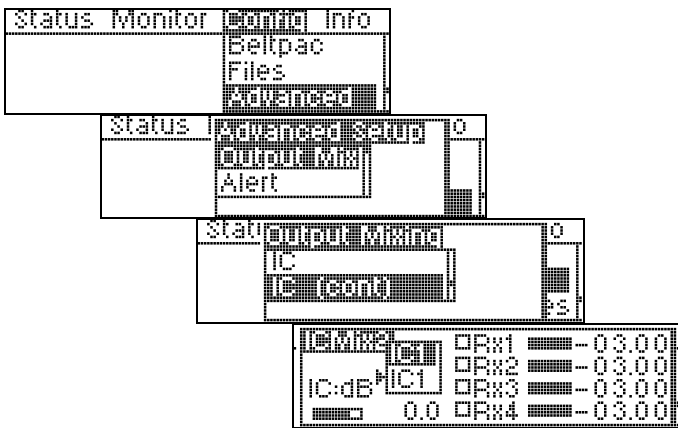

Intercom Output Mixing (continued):

Select IC1 or IC2, then select the box(es) next to RX1-RX4 to enable input. Use the control knob to adjust output level in 0.25dB or 2.25dB increments for the desired mix.

Check these boxes only if you want receiver audio continuously fed to the Intercom Output. Leave them unchecked for normal operation.

Place the cursor to the left of the bar below IC:dB and use the control knob to adjust the overall IC audio output level in 1.5dB increments.

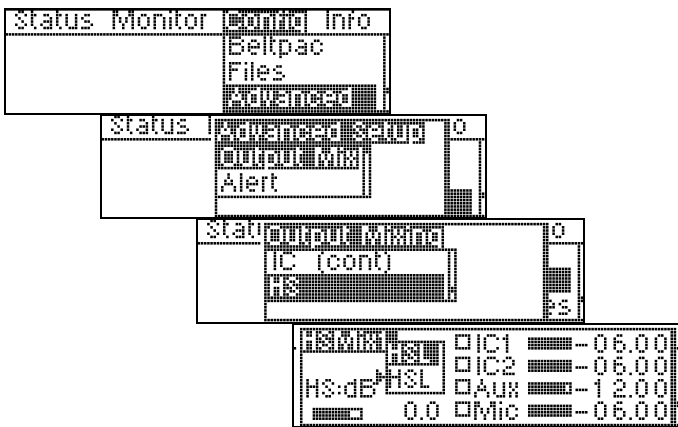

Headset Output Mixing:

Select HSL (headset left) or HSR (headset right), then select the box next to IC1, IC2, Aux and/or Mic to enable input. Use the control knob to adjust output level in 0.25dB or 2.25dB increments for the desired mix.

Place the cursor to the left of the bar below HS:dB and use the control knob to adjust the overall headset audio output level in 1.5dB increments.

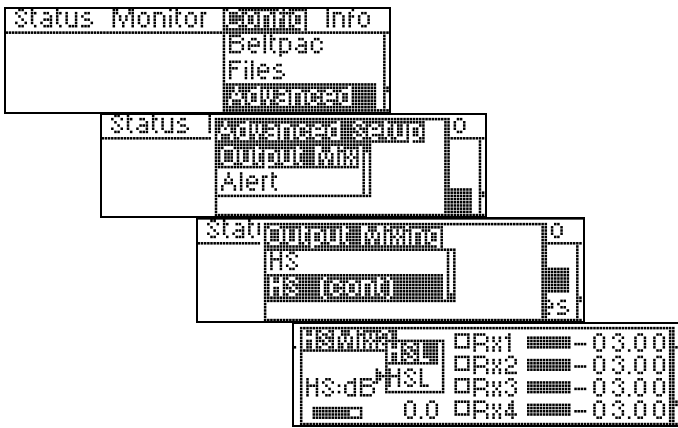

Headset Output Mixing (continued):

Select HSL (headset left) or HSR (headset right), then select the box(es) next to RX1-RX4 to enable input. Use the control knob to adjust output level in 0.25dB or 2.25dB increments for the desired mix.

Check these boxes only if you want receiver audio continuously fed to the Headset Output. Leave them unchecked for normal operation.

Place the cursor to the left of the bar below HS:dB and use the control knob to adjust the overall headset audio output level in 1.5dB increments.

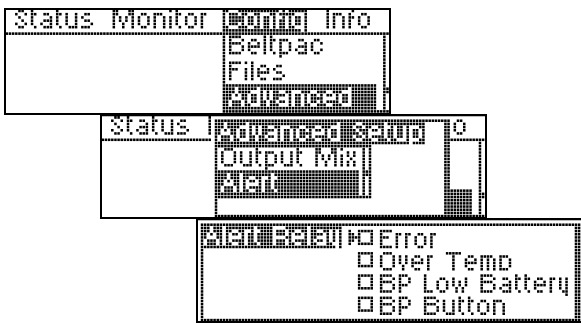

Alert Settings:

To set the **Alert** relay to close under the desired conditions select any or all of the boxes by moving the cursor to a box and pressing the **ENTER** button. If no boxes are checked, the alert relay will not be used.

NOTE: **Error** indicates the base station detects an error condition. **Over Temp** indicates the internal base station temperature is excessive.

BP Low Battery indicates that any belt pac in the system has a low battery. **BP Button** indicates any belt pac button that has been programmed as an alert button.

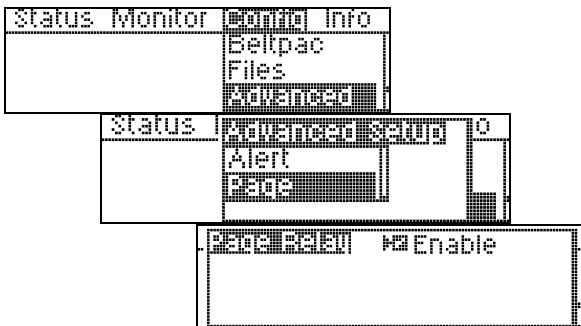

Page Settings:

To activate the page feature, select **Enable** and press the **ENTER** button.

NOTE: If the page relay is not enabled and a belt pac page button is pushed, a reject tone will be heard in the belt pac's headset.

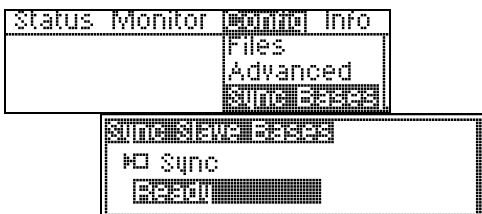

Synchronize Base Station Settings:

To configure synchronized base station settings, press the **ENTER** button.

NOTE: This only pertains to systems with master and slave base stations. All belt pac settings are done in the master base station. Synchronizing the slave bases will cause all settings from the master base station to be transferred to the slaves.

Information displays provide information about the base station and its current configuration settings file, and testing capability for transmitter and receiver sub carriers.

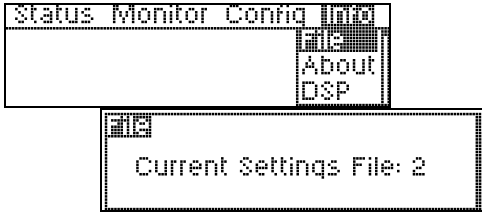

The **file number** displayed is for current configuration settings. It was the settings file being used the last time the base station was turned off, or the last settings file you saved since the base station was turned on.

This is the file that will be used next time the base station power is turned on.

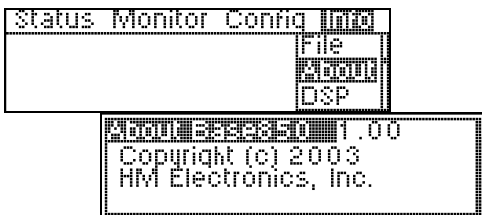

Base station software version number and date are displayed.

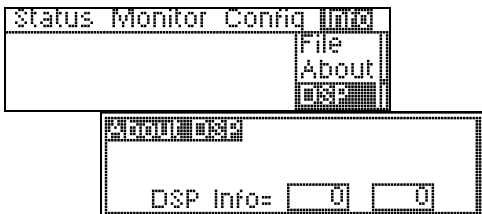

DSP software version number is displayed.

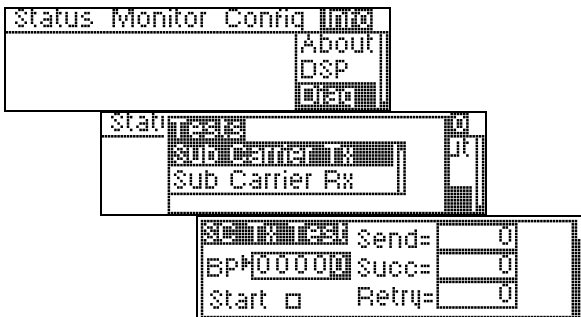

To perform a **sub carrier transmitter test**, with the cursor at the **BP** box, enter a beltpac ID number then select **Start**. Let the test run for a few seconds then press the **ENTER** button to stop it. The results will be shown at the right side of the display.

NOTE: The beltpac must be turned on and set to the PTT or PTE transmit mode.

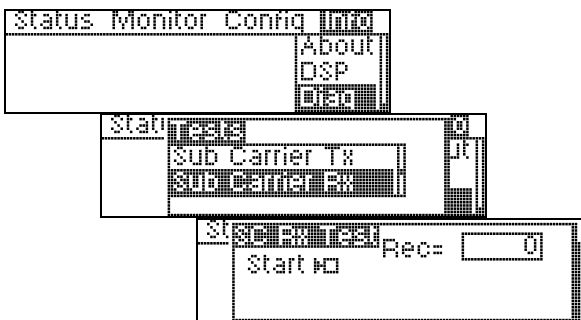

Press the beltpac C and D buttons on a beltpac simultaneously. To perform a **sub carrier receiver test**, select **Start** then press the **ENTER** button.

BELTPAC OPERATION

Controls and Buttons

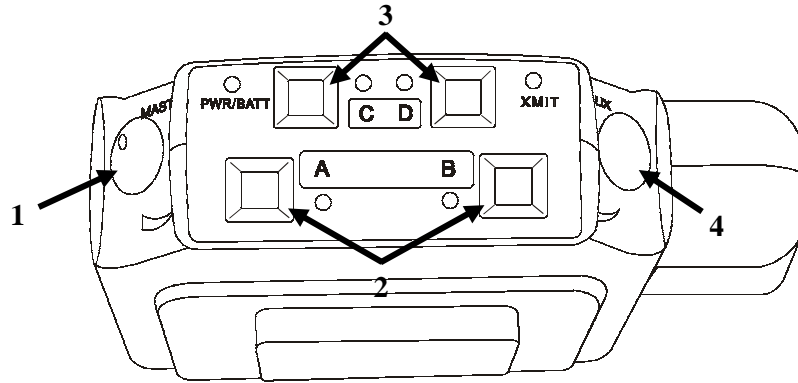

1. Master On/Off Volume Control

Turns beltpac on and off.
Controls volume levels and beep intensity.
Press and hold control button in to mute primary receiver input.

2. A and B Buttons

Perform functions set up in beltpac programming. Refer to Equipment Setup in Section 2.
If set up for Lock function, press and release button in less than one second to lock on.
Press and hold for momentary function, to remain on only while button is held.
If set up for Momentary function, button will remain on only while held. Lock feature cannot be used.
Either or both of these buttons can be turned off in beltpac setup.

3. C and D Buttons

Perform functions set up in beltpac programming. Refer to Equipment Setup in Section 2.
Only momentary function can be used. If set for momentary function, button will remain on only while held. C and D buttons have no lock function.
Either or both of these buttons can be turned off in beltpac setup.

4. Auxiliary Volume Control

Controls mix levels of auxiliary input or an optional second receiver.
Press and hold control button in to mute auxiliary input or second receiver.

Indicator Lights

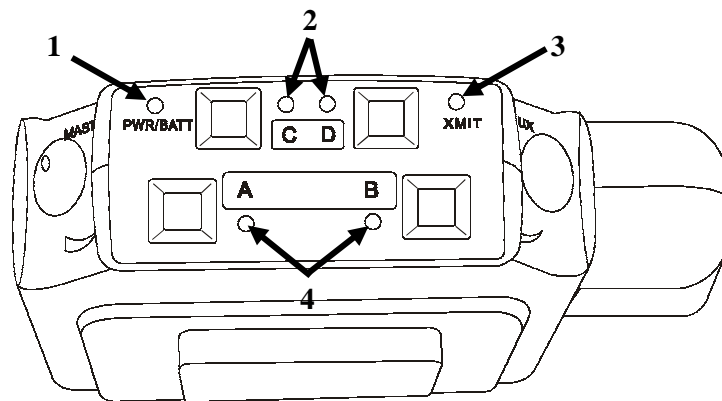

1. Power/Battery Light

Remains lit when power is on. Green = good batteries
Amber = low batteries
Red = nearly dead batteries

2. C and D Lights

On while any functions programmed into C and D buttons are activated.

3. Transmit Light

On steady red while belt pac is transmitting.

4. A and B Channel Indicator Lights

A-green while listening on Channel 1.

B-green while listening on Channel 2.

A-red while talking on Channel 1.

B-red while talking on Channel 2.

If indicator lights (LEDs) are configured on, holding the C and D buttons while turning the belt pac power on will disable them until the next time the belt pac is turned off and on again.

If LEDs are configured off, holding the C and D buttons while turning the belt pac power on will turn the LEDs back on until the next time the belt pac is turned off and on again.

If LEDs are configured off, when normally turning the belt pac power on, all LEDs will blink on momentarily.

Connectors and Adjustment

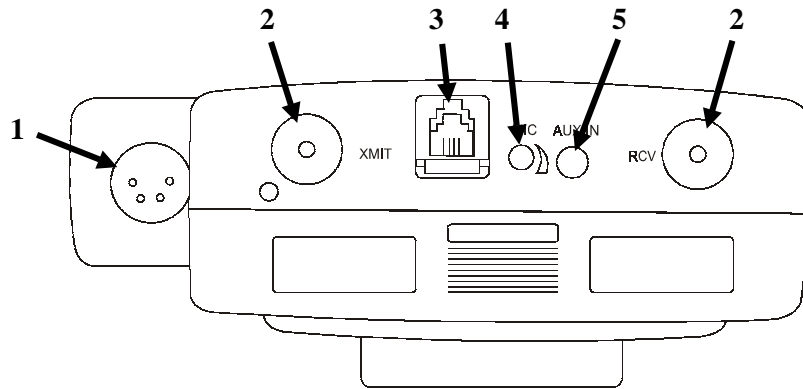

1. Headset Connector

XLR type connector.

2. Antenna Connectors

Transmitter antenna connector has color dot (or none), matching color band (or none) on transmitter antenna. Receiver antenna connector has color dot (or none), matching color band (or none) on receiver antenna.

Screw antennas securely into connectors.

3. RMT Connector

Used for interconnect cable to base station, for uploading beltpac configuration settings and frequency scans.

CAUTION: *Beltpac should not be turned off and back on while connected to base station or controller malfunction may occur. If this happens, unplug the connector, turn the beltpac power off, wait at least one second and turn the power back on. An ordinary telephone handset cable may be used to connect the beltpac to the base station.*

Interconnect cable has RJ-10 type connectors.

4. Headset Microphone Gain Adjustment

Adjusts headset microphone gain ± 10 dB.

NOTE: Beltpac automatically detects electret or dynamic microphone.

5. Auxiliary Input Connector

1/8 inch jack receptacle for line level monaural audio source.

If the beltpac includes a second (optional) receiver, plugging into this location will disconnect the second receiver and connect the auxiliary input device in its place.

Batteries

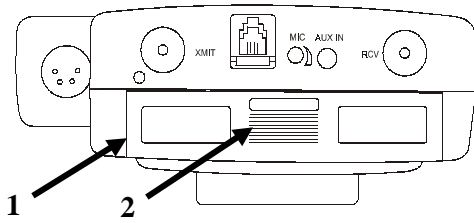

1. Battery Compartment Cover
2. Battery Cover Release Grid

To change batteries:

Place your thumb on the battery cover release grid and pull back on the battery compartment cover to open the battery compartment. Carefully flip the cover up and slide it to the back of the opening and push it slightly downward to release the battery sled into your hand.

Remove the six 1.5V AA batteries from the sled and replace them with six fresh ones.

Carefully slide the battery compartment cover back over the compartment until its latches securely in place.

Infrared Window

The infrared window provides capability for interfacing with a PDA for easy PRO850 configuration setups.

Optional HME PDA850 software is required.

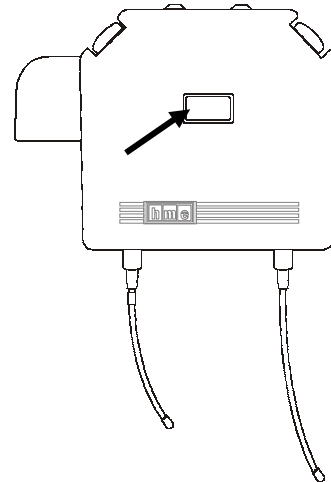

SECTION 4. PC850 SOFTWARE

PC850 is a Microsoft Windows® application which enables the user to make all PRO850 base station and belt pac configuration settings on a PC and save the settings to files. An RS-232 interface cable must be used to connect the PRO850 base station to the PC in which PC850 software is installed.

PC850 Installation

Minimum Requirements for Use of PC850 Software

- IBM compatible PC with a Pentium™ microprocessor
- Minimum of 32 megabytes RAM
- Minimum of 100 megabytes available hard disk space
- One available RS-232 serial port or a modem interface
- Serial interface cable appropriate for your PC (See Section 2.1)
- Microsoft Windows™ 95, Windows™ 98, Windows™ NT4.0 Svc Pac, Windows™ 2000, Windows™ ME or Windows™ XP
- Familiarity with Windows™ operating system
- Internet Explorer 4.1 or later

NOTE: Before installing PC850, close all other programs that are open.

To install PC850 under Windows 95, Windows 98, Windows NT4.0 Svc Pac 3, Windows 2000, Windows ME or Windows™ XP, follow the instructions below.

To install PC850 for Windows NT/2000, you must be a System Administrator. For Windows NT/2000, if you have installed this product for multiple users, you may give authorization to all PC850 users at once. To do this, log into the computer as System Administrator and install PC850 according to these instructions. After successful installation, all users will have access to PC850. To be able to run PC850, each user must have "Read, Write and Execute" permission for the **ProgramFiles\HME\PC850** directory.

1. Insert the CD into a selected CD-ROM drive.
 - If the CD-ROM drive is set for AutoPlay, the PC850 installation will begin automatically. Skip steps 2 and 3.
 - If the CD-ROM drive is not set for AutoPlay, continue with steps 2 and 3 below.
2. Under Windows Explorer or File Manager, double click on the CD-ROM drive where the CD is inserted.
3. Double click on the **setup.exe** file, and the PC850 installation will begin.

Proceed as instructed on the installation screens. When the installation has been completed, select Finish to end the installation process.

PC850 Operation

To open the PC850 software, double click on the PC850 icon on your desktop screen. When the PC850 opens, the screen below will appear on your PC.

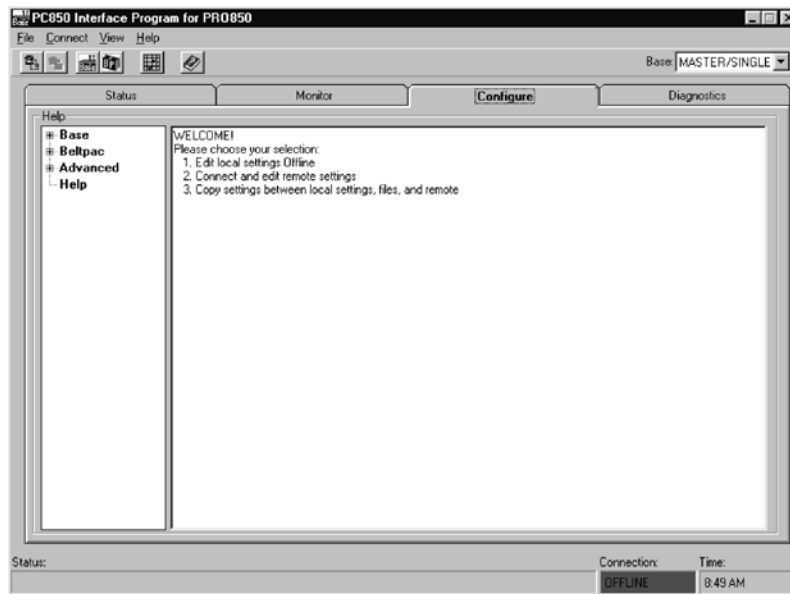

Select the **Status**, **Monitor**, **Configuration** or **Information** tab with your cursor. The respective screen will appear with all the same functions and system settings that are available on the PRO850 base station. Place your cursor over the desired setting on the screen and a drop-down menu will appear with the applicable selections or information.

PC850 can be operated in either of two modes: Offline or Online. Offline means that the program is operated without any connection to a PRO850 base station. In this mode, the only screens that can be accessed are under the Configuration tab. This allows a user to set up configurations and save them to disk so that they can be loaded into the base station later. While offline, the connection status indicator on the status bar at the bottom of the window will be red. Online means that the base station is connected to the PC and that a logical connection between the two has been established.

To switch to online mode, first be sure that an appropriate cable is connected between the base station and the PC. Then select Connect from the Connect menu or press the Connect button on the toolbar. This will open the Connect to System dialog box. There, choose the appropriate connection and click Connect. Once online, the connection status indicator will be green.

The first three tabs on the PC850 window match the first three menus on the BS850 LCD screen: Status, Monitor, and Configure. The fourth tab, Diagnostics, matches the base station diagnostics menu item under the Info menu. The functions available on each tab match those available on the base station itself. Depending on the speed of the PC, it may be necessary to click the Freeze Screen button at the bottom of the window to make it possible to move away from the Status or Monitor tabs. It is necessary to freeze these screens if you wish to select a menu item while displaying Status or monitoring audio levels.

A particularly useful feature of PC850 is the ability to display (and alter) the audio connection matrix. This window shows all possible and active audio connections. To open the window, select Audio Connection Matrix from the View menu. Once open, the window will display all active connections as check marks beside a green square. As connections change, the screen will be updated with the new information. To force a manual

connection, simply check the desired box(es). To break a connection, uncheck the desired box(es). Note that two types of connections are shown: Manual connections and dynamic connections. Manual connections result from configuration settings or functions. Dynamic connections result from Beltpac operations or the front panel Talk button. Checking a box in the window always results in a manual connection. Manual connections are not overridden by dynamic operations. However, clearing a connection manually does not prevent a later dynamic or manual connection from being established. Note that the Audio Connection Matrix window can only be opened while PC850 is “online”.

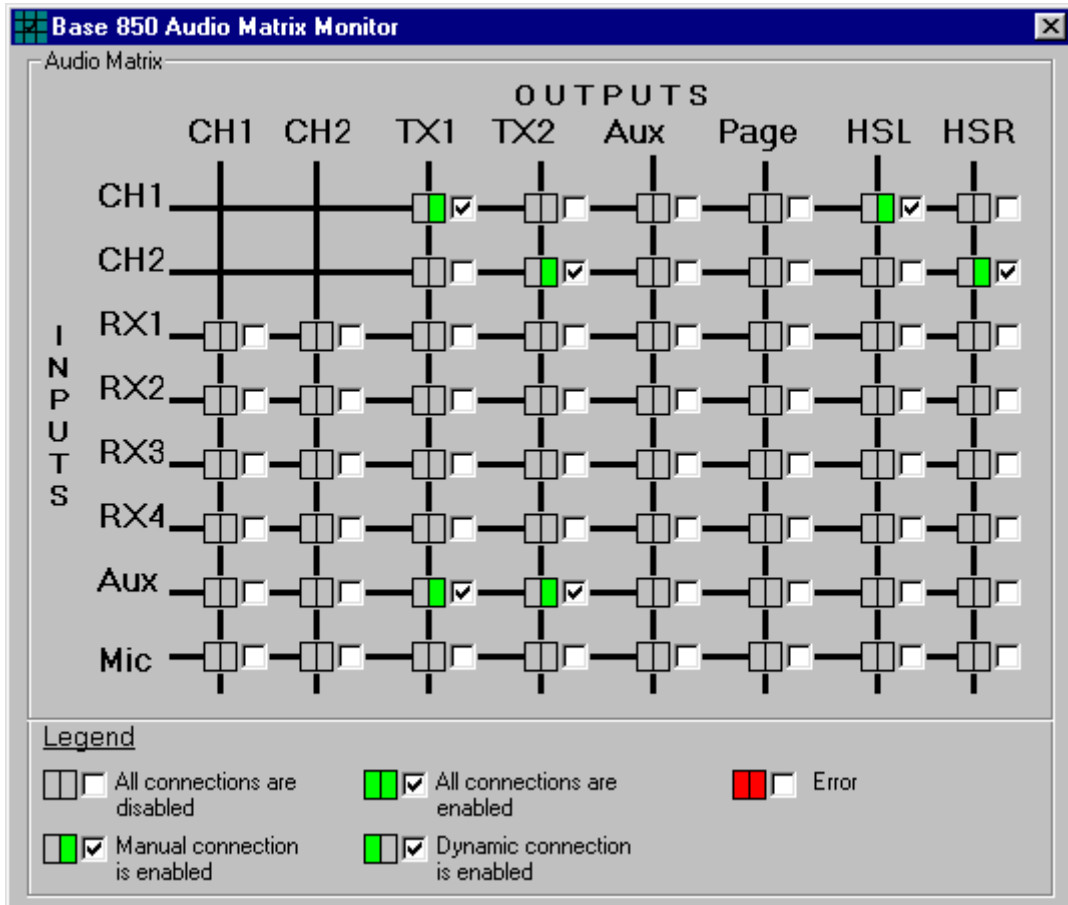

END-USER LICENSE AGREEMENT FOR HME PC850 SOFTWARE

IMPORTANT — READ CAREFULLY: This HME End-User License Agreement ("AGREEMENT") is a legal agreement between you (either an individual or a single entity) and HM Electronics, Inc. ("HME") for the HME software product PC850, which includes computer software and may include associated registration files, media, printed materials, sample documents, and "online" or electronic documentation ("SOFTWARE PRODUCT"). The SOFTWARE PRODUCT also includes any updates and supplements to the original SOFTWARE PRODUCT provided to you by HME. Any software provided along with the SOFTWARE PRODUCT that is associated with a separate end-user license agreement is licensed to you under the terms of that license agreement.

By installing, copying, downloading, accessing, or otherwise using the SOFTWARE PRODUCT, you agree to be bound by the terms of this AGREEMENT. If you do not agree to the terms of this AGREEMENT, do not install or use the SOFTWARE PRODUCT; you may, however, return it to your place of purchase for a full refund.

SOFTWARE PRODUCT LICENSE

The SOFTWARE PRODUCT is protected by copyright laws and international copyright treaties, as well as other intellectual property laws and treaties. The SOFTWARE PRODUCT is licensed, not sold.

- 1) **GRANT OF LICENSE.** This AGREEMENT grants you the following rights:
 - a) **Applications Software.** As an individual, you are granted a world-wide non-exclusive license, which includes only the right to install, use, access, display, run, or otherwise interact with ("RUN") one copy of the SOFTWARE PRODUCT, or any prior version for the same operating system, on a single computer. If you are an entity, you are granted the right to designate one individual within your organization to have the right to use the SOFTWARE PRODUCT in the manner provided above.
 - b) **Storage/Network Use.** As an alternative to installing the SOFTWARE PRODUCT on a dedicated computer, you may store or install the SOFTWARE PRODUCT on a storage device, such as a network server, used only to RUN the SOFTWARE PRODUCT on your other COMPUTERS over an internal network; however, you must acquire and dedicate a license for each separate COMPUTER on which the SOFTWARE PRODUCT is RUN from the storage device. A license for the SOFTWARE PRODUCT may not be shared or used concurrently on or by different COMPUTERS.
 - c) **Reservation of Rights.** All rights not expressly granted are reserved by HME.

- 2) **DESCRIPTION OF OTHER RIGHTS AND LIMITATIONS.**
 - a) **Limitations on Reverse Engineering, Decompilation, and Disassembly.** You may not reverse engineer, decompile, or disassemble the SOFTWARE PRODUCT.
 - b) **Separation of Components.** The SOFTWARE PRODUCT is licensed as a single product. Its component parts may not be separated for use on more than one COMPUTER.
 - c) **Trademarks.** This AGREEMENT does not grant you any rights in connection with any trademarks or service marks of HME.
 - d) **Rental.** You may not rent, lease, or lend the SOFTWARE PRODUCT.
 - e) **Support Services.** HME may provide you with support services related to the SOFTWARE PRODUCT ("Support Services"). Use of Support Services is governed by the HME policies and programs described in the user manual, in "online" documentation, and/or in other HME-provided materials. Any supplemental software code provided to you as part of the Support Services shall be considered part of the SOFTWARE PRODUCT and subject to the terms and conditions of this AGREEMENT. With respect to technical information you provide to HME as part of the Support Services, HME may use such information for its business purposes, including for product support and development. HME will not utilize such technical information in a form that personally identifies you.

f) Software Transfer. The initial licensee of the SOFTWARE PRODUCT may make a one-time permanent transfer of this AGREEMENT and SOFTWARE PRODUCT only directly to an end user. This transfer must include all of the SOFTWARE PRODUCT (including all component parts, the media and printed materials, any upgrades, this AGREEMENT, and, if applicable, the Certificate of Authenticity). Such transfer may not be by way of consignment or any other indirect transfer. The transferee of such one-time transfer must agree to comply with the terms of this AGREEMENT, including the obligation not to further transfer this AGREEMENT and/or SOFTWARE PRODUCT.

g) Termination. Without prejudice to any other rights, HME may terminate this AGREEMENT if you fail to comply with the terms and conditions of this AGREEMENT. In such event, you must destroy all copies of the SOFTWARE PRODUCT and all of its component parts.

3) UPGRADES. If the SOFTWARE PRODUCT is labeled as an upgrade, you must be properly licensed to use a product identified by HME as being eligible for the upgrade in order to use the SOFTWARE PRODUCT. A SOFTWARE PRODUCT labeled as an upgrade replaces and/or supplements (and may disable) the product that formed the basis for your eligibility for the upgrade. You may use the resulting upgraded product only in accordance with the terms of this AGREEMENT. If the SOFTWARE PRODUCT is an upgrade of a component of a package of software programs that you licensed as a single product, the SOFTWARE PRODUCT may be used and transferred only as part of that single product package and may not be separated for use on more than one COMPUTER.

4) COPYRIGHT. All title and copyrights in and to the SOFTWARE PRODUCT (including but not limited to its code, appearance, structure, organization along with any documents, forms, text, and images incorporated into the SOFTWARE PRODUCT), the accompanying printed materials, and any copies of the SOFTWARE PRODUCT are owned by HME or its suppliers. All title and intellectual property rights in and to the content that may be accessed through use of the SOFTWARE PRODUCT are the property of the respective content owner and may be protected by applicable copyright or other intellectual property laws and treaties. This AGREEMENT grants you no rights to use such content. If this SOFTWARE PRODUCT contains documentation that is provided only in electronic form, you may print one copy of such electronic documentation. You may not copy the printed materials accompanying the SOFTWARE PRODUCT.

5) BACKUP COPY. After installation of one copy of the SOFTWARE PRODUCT pursuant to this AGREEMENT, you may keep the original media on which the SOFTWARE PRODUCT was provided by HME solely for backup or archival purposes. If the original media is required to use the SOFTWARE PRODUCT on the COMPUTER, you may make one copy of the SOFTWARE PRODUCT solely for backup or archival purposes. Except as expressly provided in this AGREEMENT, you may not otherwise make copies of the SOFTWARE PRODUCT or the printed materials accompanying the SOFTWARE PRODUCT.

6) EXPORT RESTRICTIONS. You agree that you will not export or re-export the SOFTWARE PRODUCT, any part thereof, or any process or service that is the direct product of the SOFTWARE PRODUCT (the foregoing collectively referred to as the "Restricted Components"), to any country, person or entity subject to U.S. export restrictions. You specifically agree not to export or re-export any of the Restricted Components (i) to any country to which the U.S. has embargoed or restricted the export of goods or services, which currently include, but are not necessarily limited to Cuba, Iran, Iraq, Libya, North Korea, Sudan and Syria, or to any national of any such country, wherever located, who intends to transmit or transport the Restricted Components back to such country; (ii) to any person or entity who you know or have reason to know will utilize the Restricted Components in the design, development or production of nuclear, chemical or biological weapons; or (iii) to any person or entity who has been prohibited from participating in U.S. export transactions by any federal agency of the U.S. government. You warrant and represent that neither the BXA nor any other U.S. federal agency has suspended, revoked or denied your export privileges.

7) NO LEGAL ADVICE. You agree and acknowledge that HME is not engaged in rendering legal, accounting, or other professional advice. If legal advice or other expert assistance is required, the services of a competent professional person should be sought. Any sample documents included with the SOFTWARE PRODUCT are for illustration only and should not be used as the basis for any transaction or advice.

8) MISCELLANEOUS

- a) If you acquired this SOFTWARE PRODUCT in the United States, this AGREEMENT is governed by the laws of the State of California.
- b) If you acquired this SOFTWARE PRODUCT in Canada, unless expressly prohibited by local law, this AGREEMENT is governed by the laws in force in the Province of Ontario, Canada; and, in respect of any dispute which may arise hereunder, you consent to the jurisdiction of the federal and provincial courts sitting in Toronto, Ontario. If this SOFTWARE PRODUCT was acquired outside the United States, then local law may apply.
- c) If you have any questions concerning this AGREEMENT, or if you desire to contact HME for any reason, please write to: HM Electronics, Inc., 14110 Stowe Drive, Poway, California, 92064 U.S.A.

9) LIMITED WARRANTY

- a) **LIMITED WARRANTY FOR SOFTWARE PRODUCTS ACQUIRED IN THE U.S. AND CANADA.** HME warrants that (a) the SOFTWARE PRODUCT will perform substantially in accordance with the accompanying written materials for a period of ninety (90) days from the date of receipt, and (b) any Support Services provided by HME shall be substantially as described in applicable written materials provided to you by HME, and HME support engineers will make commercially reasonable efforts to solve any problem issues. Some states and jurisdictions do not allow limitations on duration of an implied warranty, so the above limitation may not apply to you. To the extent allowed by applicable law and not disclaimed in this Agreement, implied warranties on the SOFTWARE PRODUCT, if any, are limited to ninety (90) days.

CUSTOMER REMEDIES. HME's and its suppliers' entire liability and your exclusive remedy shall be, at HME's option, either (a) return of the price paid, if any, or (b) repair or replacement of the SOFTWARE PRODUCT that does not meet HME's Limited Warranty and which is returned to HME with a copy of your receipt. This Limited Warranty is void if failure of the SOFTWARE PRODUCT has resulted from accident, abuse, or misapplication. Any replacement SOFTWARE PRODUCT will be warranted for the remainder of the original warranty period or thirty (30) days, whichever is longer. Outside the United States, neither these remedies nor any product support services offered by HME are available without proof of purchase from an authorized international source.

- c) **NO OTHER WARRANTIES.** THE LIMITED WARRANTY ABOVE IS EXCLUSIVE AND IN LIEU OF ALL OTHER CONDITIONS AND WARRANTIES FOR THE SOFTWARE AND DOCUMENTATION. HME AND ITS SUPPLIERS MAKE NO OTHER CONDITIONS OR WARRANTIES, EXPRESS, IMPLIED, STATUTORY OR OTHERWISE, AND EXPRESSLY DISCLAIM ALL OTHER CONDITIONS AND WARRANTIES, INCLUDING BUT NOT LIMITED TO IMPLIED CONDITIONS OR IMPLIED WARRANTIES OF MERCHANTABILITY, FITNESS FOR A PARTICULAR PURPOSE, AND NONINFRINGEMENT FOR THE SOFTWARE AND DOCUMENTATION, TO THE FULLEST EXTENT PERMITTED BY APPLICABLE LAW.

- d) **LIMITED LIABILITY.** TO THE MAXIMUM EXTENT PERMITTED BY APPLICABLE LAW, IN NO EVENT AND UNDER NO LEGAL THEORY SHALL HME OR ITS SUPPLIERS BE LIABLE TO YOU FOR ANY COSTS OF SUBSTITUTE PRODUCTS, OR FOR ANY CONSEQUENTIAL, SPECIAL, INCIDENTAL, PUNITIVE OR INDIRECT DAMAGES OF ANY KIND ARISING OUT OF THE LICENSE OF, USE OF, OR INABILITY TO USE ANY HME SOFTWARE OR DOCUMENTATION, EVEN IF HME HAS BEEN ADVISED OF THE POSSIBILITY OF SUCH DAMAGES. IN NO EVENT SHALL HME'S OR ITS SUPPLIERS' LIABILITY EXCEED THE LICENSE FEE PAID BY YOU. THIS LIMITATION OF LIABILITY AND RISKS IS REFLECTED IN THE PRICE OF THE SOFTWARE LICENSE.

- 10) AUDIT.** During the term of this Agreement and for three (3) years after termination or expiration, you will maintain complete records regarding your use and distribution of the Software. Upon reasonable notice to you, HME may audit, at HME's expense, your books and records to determine your compliance hereunder. In the event any such audit reveals that you have underpaid HME by an amount greater than five percent (5%) of the amounts due HME in the period being audited, or that you have knowingly breached any material obligation hereunder, then, in addition to such other remedies as HME may have, you shall pay or reimburse to HME the cost of the audit.

11) U.S. GOVERNMENT RESTRICTED RIGHTS. The Software and accompanying documentation are deemed to be "commercial computer software" and "commercial computer software documentation," respectively, pursuant to DFAR Section 227.7202 and FAR Section 12.212, as applicable. Any use, modification, reproduction, release, performance, display or disclosure of the software and accompanying documentation by the U.S. Government shall be governed solely by the terms of this Agreement and shall be prohibited except to the extent expressly permitted by the terms of this Agreement.

You must affix the following legend to each copy of the Software:

Use, duplication, reproduction, or transfer of this commercial Software and accompanying documentation is restricted in accordance with FAR 12.212 and DFARS 227.7202 and by a license agreement.
Contact HM Electronics, Inc., 14110 Stowe Drive, Poway, California, 92064 U.S.A.

HME DISCLAIMS ANY REPRESENTATION OR WARRANTY MADE BY ANY DISTRIBUTOR, RESELLER OR DEALER TO YOU WHETHER EXPRESS OR IMPLIED.

Should you have any questions concerning this AGREEMENT, or if you desire to contact HME for any reason, please contact us: HM Electronics, Inc., 14110 Stowe Drive, Poway, California, 92064, U.S.A.