

User Guide



FreeSpeak II™ Base Station Version

Part Number: 399G087 Rev 21

Date: December 19, 2014

Document Reference

Clear-Com FreeSpeak II User Guide

Part Number: 399G087 Revision: 21

Legal Disclaimers

Copyright © 2014 HME Clear-Com Ltd.

All rights reserved.

Clear-Com and the Clear-Com logo are registered trademarks of HM Electronics, Inc.

The software described in this document is furnished under a license agreement and may be used only in accordance with the terms of the agreement.

The product described in this document is distributed under licenses restricting its use, copying, distribution, and decompilation/reverse engineering. No part of this document may be reproduced in any form by any means without prior written authorization of Clear-Com, an HME Company.

Clear-Com Offices are located in California, USA; Cambridge, UK; Dubai, UAE; Montreal, Canada; and Beijing, China. Specific addresses and contact information can be found on Clear-Com's corporate website:

www.clearcom.com

Clear-Com Contacts

Americas and Asia-Pacific Headquarters

California, United States

Tel: +1.510.337.6600

Email: CustomerServicesUS@clearcom.com

Europe, Middle East, and Africa Headquarters

Cambridge, United Kingdom

Tel: +44 1223 815000

Email: SalesSupportEMEA@clearcom.com

Canada Office

Quebec, Canada

Tel: +1 (450) 653-9669

China Office

Beijing Representative Office

Beijing, P.R.China
 Tel: +8610 65811360 / 65815577

Contents

Document Reference	2
1	Important Safety instructions 10
1.1	Safety symbols 11
2	Introduction to FreeSpeak II™ 12
2.1	An FS II communication system 13
2.1.1	FreeSpeak II system capacity..... 14
3	Installing a system..... 14
3.1	Placing the Base station 16
3.2	Placing the antennas and splitters 16
3.2.1	Wiring the antennas and splitters 17
3.2.2	Power supplies to the components of an FS II System..... 18
3.2.3	Determining coverage areas..... 19
3.3	Doing a site survey to determine coverage areas..... 20
3.3.1	Doing a site survey with a beltpack..... 20
3.3.2	Testing antenna handoff 22
3.3.3	Getting information on active antenna status 23
3.3.4	Assigning beltpacks to coverage areas..... 23
3.3.5	Conditions affecting coverage areas 24
3.4	Registering beltpacks..... 24
3.4.1	Over the air (OTA) registration of a beltpack from the Base station 25
4	Connecting the Base station 28
4.1	Understanding the Back-Panel Connectors 29
4.2	Connecting to partyline intercom systems 32
4.2.1	Clear-Com and compatible partyline..... 32
4.2.2	Connecting directly to Clear-Com partyline beltpacks 33

4.2.3	Connecting to an RTS™ wired beltpack.....	34
4.2.4	Front-panel adjustments for partyline connections.....	34
4.2.5	Troubleshooting partyline connections.....	35
4.3	Wireless partyline.....	37
4.4	Connecting to 4-Wire and digital matrix intercom.....	38
4.4.2	Connecting to Clear-Com matrix plus.....	40
4.4.3	Connecting to Clear-Com Eclipse digital matrix.....	40
4.4.4	Connecting with other digital matrix intercom systems.....	41
4.4.5	Connecting with other 4-wire devices.....	41
4.5	Connecting to a program audio source.....	42
4.6	IFB configuration.....	42
4.7	Connecting to the stage announce output.....	43
4.8	Connecting to a PC.....	44
4.8.1	Connecting using the serial port.....	44
4.8.2	Connecting using the LAN port.....	46
4.9	Connecting to transceiver/antennas.....	46
4.9.1	Connecting one transceiver/antenna directly to a transceiver port.....	46
4.9.2	Connecting transceiver/antennas with a splitter (PD2203).....	47
4.9.3	Powering an antenna or antenna splitter.....	48
5	Operating the Base station.....	49
5.1	Introduction.....	49
5.2	Understanding Front-Panel Operation.....	50
5.2.1	Call Channel A.....	50
5.2.2	Call Channel B.....	50
6	Programming a system from the Base station.....	54
6.1	Introduction.....	55
6.2	Using the Base station's programming menus.....	56
6.3	Saving changes.....	56
6.4	Changing beltpack labels.....	56
6.4.1	To change a beltpack label.....	56
6.5	Setting and changing port labels.....	58

6.5.1	To create a port label	58
6.6	Setting and changing group labels	60
6.6.1	To create a group label.....	60
6.7	Adding group members	62
6.7.1	To assign members to a group	62
6.8	Beltpacks	63
6.9	Assigning audio routes to a beltpack.....	63
6.10	Setting the beltpack audio level.....	66
6.11	Setting beltpack latching	67
6.12	Over the Air (OTA) beltpack registration from the Base station.....	67
6.13	Setting input and output port levels.....	67
6.13.1	Input level	68
6.13.2	Output level	68
6.13.3	To set the audio level for a port.....	68
6.14	Setting port call destination	69
6.15	Configuring a wired partyline	71
6.15.1	To select the type of partyline system for a partyline port.....	72
6.15.2	To configure the Noise Gate for a partyline port.....	73
6.15.3	To configure the levels for a partyline port	74
6.16	Base station System Menu.....	76
6.17	System Info.....	77
6.18	Restoring the Defaults.....	77
6.19	Antennas.....	78
6.20	Setting the IP address.....	79
6.21	Locking front-panel enable buttons	79
6.22	Remote microphone kill.....	80
6.22.1	Kill beltpack microphones	80
6.22.2	Kill partyline microphones.....	80
6.22.3	Kill all microphones.....	80
6.23	Battery indicator	80
7	Operating the wireless beltpack	81
7.1	Overview of the wireless beltpack.....	81

7.2	Beltpack user controls	84
7.2.1	Top controls.....	84
7.2.2	Beltpack display	85
7.2.3	Beltpack headset tones/alerts	85
7.2.4	Front controls.....	86
7.2.5	Beltpack bottom connectors	88
7.2.6	Beltpack rear panel.....	89
7.3	Using the beltpack	90
7.3.1	Registering the beltpack	90
7.3.2	Charging the beltpack	90
7.3.3	Powering on the beltpack.....	91
7.3.4	Using the beltpack to communicate.....	91
7.3.5	Entering and exiting Menu mode.....	92
7.3.6	Setting and Adjusting Listen Levels.....	92
7.3.7	Upgrading beltpack firmware.....	92
8	Programming on the beltpack	94
8.1	Introduction to programming on the beltpack	94
8.2	Configuring the beltpack volume settings	95
8.2.1	Configuring the beltpack channel volumes and master volume	96
8.2.2	Configuring the volume level of the line input.....	96
8.2.3	Configuring the rotary controls	96
8.3	Configuring the beltpack headset.....	97
8.3.1	Setting headset autodetect	97
8.3.2	Setting the sidetone level	98
8.3.3	Setting the headset limiter.....	98
8.4	Configuring the beltpack microphone	98
8.4.1	Setting the microphone type	99
8.4.2	Setting the microphone echo cancellation	99
8.5	Configuring the beltpack display and LEDs.....	99
8.5.1	Setting the display and LED brightness.....	100
8.5.2	Setting the display dim timeout.....	100
8.5.3	Setting the display off timeout	100
8.6	Configuring the beltpack alarm options	101

8.6.1	Setting the low battery alarm.....	101
8.6.2	Setting the low battery alarm threshold.....	102
8.6.3	Setting the out of range alarm	102
8.6.4	Setting the call alert.....	102
8.7	Selecting the beltpack role default set.....	103
8.8	Selecting the beltpack administration.....	103
8.8.1	Enabling OTA registration mode.....	104
8.8.2	Setting full menu access.....	104
8.8.3	Setting system sync mode.....	105
8.9	Setting the listen again option.....	105
8.10	Accessing beltpack information	106
8.11	Setting display mode	106
8.12	Setting system connect.....	106
8.13	Enabling over the air (OTA) registration mode from a beltpack....	107
8.14	Performing a site survey.....	107
9	Operating the transceiver/antenna	109
9.1	Transceiver/antenna	109
9.1.1	IP rating (International Protection Marking)	109
9.1.2	FS II transceiver/antenna connector panel.....	110
9.1.3	Cabling the antennas	111
9.1.4	Beltpack support capacities for transceiver/antennas	111
9.1.5	Coverage areas under various conditions.....	112
9.1.6	Transceiver/antenna setup rules and tips.....	112
9.1.7	Upgrading the antenna/transceiver firmware.....	113
9.2	Transceiver/antenna splitter (PD2203).....	113
9.2.1	PD2203 Front connector panel.....	114
9.2.2	PD2203 rear panel	115
9.2.3	Connecting an antenna splitter to the FS II Base station and to transceiver/antennas	116
10	FS II Configuration Editor	117
10.1	Loading configurations	118
10.1.1	Loading a local configuration file.....	118

10.1.2	Loading a configuration file from a Base station using a serial link	119
10.1.3	Loading a configuration from a Base station using Ethernet.....	120
10.1.4	Loading a configuration file to the Base station from the Configuration Editor	121
10.2	Configuration Editor Screen basics.....	122
10.3	Registering beltpacks using the over the air (OTA) facility	123
10.4	Configuring beltpacks.....	126
10.4.1	Selecting the beltpack to register or edit.....	126
10.4.2	Registering beltpacks using the micro USB cable	126
10.4.3	Viewing beltpack registration information	127
10.4.4	Viewing beltpack properties	127
10.4.5	Beltpack audio levels.....	129
10.4.6	Beltpack alarm options	130
10.4.7	Setting the beltpack role options	131
10.4.8	Assigning beltpack keys.....	133
10.4.9	Configuring the Reply key	134
10.4.10	Key assignment types	135
10.5	Configuring ports.....	135
10.5.1	Selecting the port to edit	136
10.5.2	Changing the label of the port	136
10.5.3	Selecting the port type	136
10.5.4	Selecting a communication path for the port	137
10.5.5	Setting the input, output and VOX levels	139
10.6	Configuring groups and wireless partylines	139
10.6.1	Selecting the group to edit.....	140
10.6.2	Changing the label of the group.....	140
10.6.3	Changing the members of the group	141
10.6.4	Displaying a group overview	141
10.7	Reducing antenna interference	142
10.8	Configuring IFBs.....	142
10.8.1	Selecting the IFB to edit	143
10.8.2	Changing the label of the IFB	143
10.8.3	Changing the IFB sources	143

10.8.4	Setting the IFB dim level	143
10.9	Configuring Base station system parameters.....	144
10.9.1	Editing the system parameters:	144
10.9.2	Enabling Over The Air (OTA) registration	145
10.10	Diagnostics	145
10.10.1	Beltpack status.....	146
10.10.2	Static log	147
10.10.3	Antenna status	148
10.10.4	Antenna roles.....	149
10.10.5	Event Log	149
10.11	Upgrading the Configuration Editor	150
11	Upgrading the Base station from FS to FS II	151
11.1	Setting the Base station IP address	151
11.2	Upgrading the Base station firmware	151
11.3	Upgrading the Base station FPGA	151
11.4	Loading the default map.....	152
12	Specifications	154
12.1	FreeSpeak II Base station.....	154
12.2	FreeSpeak II Beltpack	155
12.3	FreeSpeak II Transceiver/Antenna.....	156
12.4	FreeSpeak II Transceiver/Antenna Splitter.....	156
12.5	Transmission Method	157
13	Compliance.....	158

1 *Important Safety instructions*

- Read these instructions.
- Keep these instructions.
- Heed all warnings.
- Follow all instructions.
- Do **not** use this apparatus near water.
- Clean only with dry cloth.
- Do **not** block any ventilation openings. Install in accordance with the manufacturer's instructions.
- Do **not** install near any heat sources such as radiators, heat registers, stoves, or other apparatus (including amplifiers) that produce heat.
- Do **not** defeat the safety purpose of the polarized or grounding-type plug. A polarized plug has two blades and a third grounding prong. The wide blade or the third prong is provided for your safety. If the provided plug does not fit into your outlet, consult an electrician for replacement of the obsolete outlet.
- Protect the power cord from being walked on or pinched particularly at plugs, convenience receptacles, and the point where they exit from the apparatus.
- Only use attachments/accessories specified by the manufacturer.
- Use only with the cart, stand, tripod, bracket, or table specified by the manufacturer, or sold with the apparatus. When a cart is used, use caution when moving the cart/apparatus combination to avoid injury from tip-over.
- Unplug this apparatus during lightning storms or when unused for long periods of time.
- Refer all servicing to qualified service personnel. Servicing is required when the apparatus has been damaged in any way, such as power-cord supply or plug is damaged, liquid has been spilled or objects have fallen into the apparatus, the apparatus has been exposed to rain or moisture, does not operate normally, or has been dropped.
- Use only chargers provided by HME/Clear-Com to charge the battery packs or beltpacks. These include:
 - BAT60 Battery pack and beltpack charger manufactured by HME/Clear-Com

- USB Charger model PA1015-050SIB200/PA1015-1SI/ PA1015-1SI050200 provided by HME/Clear-Com with your beltpack.
- This product uses Lithium Ion Batteries which can be a fire hazard, if used improperly. Use only HME/Clear-Com supplied BAT60 or equivalent battery packs to ensure safe operation of the beltpack.
- When using AA Batteries follow all safety instructions from manufacturer. Do not mix different battery chemistries. When depleted, replace all batteries.
- The in-beltpack USB charging feature has only been tested utilizing USB2.0 port.

Warning: To reduce the risk of fire or electric shock, do not expose this product to rain or moisture.

1.1 Safety symbols

Familiarize yourself with the safety symbols in **Figure 1: Safety symbols**. These symbols are displayed on the apparatus and warn you of the potential danger of electric shock if the system is used improperly.

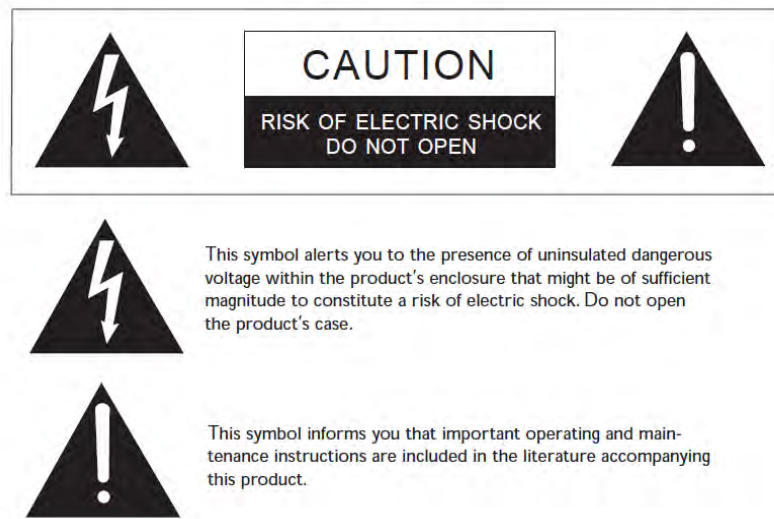

Figure 1-1: Safety symbols

Note: For compliance notices, see **13 Compliance**.

2 Introduction to FreeSpeak II™

This chapter provides an overview of the FreeSpeak II digital wireless beltpack system.

With a FreeSpeak II (FS II) wireless beltpack you can roam freely around a studio or production facility while talking and listening to all, or selected, members of the production team. With its four communication routes, the beltpack gives you the flexibility to communicate quickly and seamlessly with individuals or groups, and to change communication routes as often as needed.

The system operates in the unlicensed 1.9 and 2.4 GHz bands. With its unique and innovative digital technology, which continually searches for unused radio frequency (RF) channels, FS II avoids the noise and interference issues associated with traditional wireless systems using congested UHF and VHF bands.



Figure 2-1 An FS II Base station, antenna, and beltpack

With FS II you can set up a wireless system specifically tailored to local needs by locating antennas and beltpacks in areas where they are needed most. And because the beltpacks operate in the unlicensed 1.9 and 2.4 GHz frequency ranges, there is no interference with existing wireless systems, even those located in the same production area.

The Base station holds connections for several wired interfaces, including partylines, 4-wire sources, a program audio source, and a stage announce output device. When connected to the Base station, these devices communicate seamlessly with the wireless beltpacks. Partyline beltpacks and 4-wire matrix stations and panels can key directly to wireless beltpack by name.

Note: This manual covers the use of FS II with a Base station only. For more information on running an FS II system with a matrix, please see *FreeSpeak II™ Integra User Guide (Eclipse HX 7.6 Version)*.

You can configure FS II either from the Base station or from a PC Configuration Editor.

FreeSpeak II components can be used either with a Base station or with a matrix equipped with E-Que cards in antenna or splitter mode. For more information, see the Eclipse HX Configuration Software User Guide.

2.1 An FS II communication system

An FS II system consists of three main elements:

- The wireless beltpacks.
- The Base station that routes communication to and from wireless beltpacks and other audio devices, and also allows you to configure the FS II system.
- The antennas that provide custom coverage zones in which beltpacks can operate. Beltpacks can roam freely between coverage zones.

FS II also includes a drop-in battery charger for the beltpack Li-Ion batteries. You can conveniently charge the battery by placing the whole beltpack into the charger.

FS II operates using a cellular network of antennas located around a working environment. The antennas connect directly to the FS II Base station with CAT-5 cable. Each antenna provides an area or cell in which four to five full-duplex beltpacks can operate. Figure 2-2 shows an example configuration.

Beltpacks can roam among and between cells without disconnecting because each beltpack continually signals an antenna as to the strongest available signal. When the signal from an antenna starts to diminish due to the distance from a beltpack, the beltpack automatically “hands off” its signal to the nearest antenna, ensuring smooth transfer.

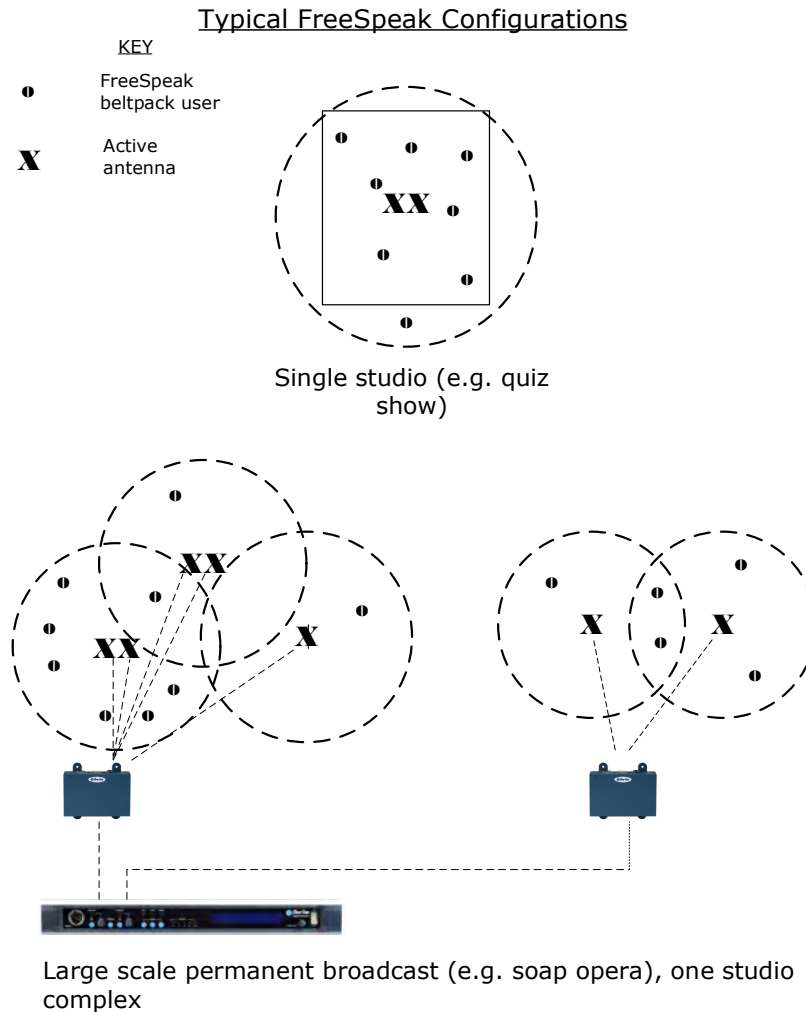

Figure 2-2 Configurations for a studio and large-scale broadcast facility

2.1.1 FreeSpeak II system capacity

The FreeSpeak II Base station supports up to 20 beltpacks.

Connecting an antenna splitter to the transceiver port on the back of the Base Station allows up to 5 antennas to be connected to the system. The Base station can connect to two splitters and so support up to 10 antennas, giving a wider coverage area and a great deal of flexibility in placing beltpacks where they are needed most. Figure 2-2 illustrates how an FS II system can be set up to operate in a single studio or in a large-scale permanent broadcast facility.

Note: Each antenna is designed to handle five beltpacks simultaneously in good conditions. However, if interference or propagation problems occur in an area, to ensure proper operation and reliability, it may be more practical to install four beltpacks for each antenna.

For zones which are likely to need coverage for five or more beltpacks simultaneously you must install a second antenna. Similarly, for good coverage for nine or more beltpacks simultaneously, a third antenna may be required.

If more than 20 beltpacks are required, you should upgrade to FreeSpeak II Integra.

3 *Installing a system*

This chapter explains how to install a FreeSpeak II system, including cable connections, positioning the equipment, registering beltpacks and performing a site survey to optimize system performance. It contains the following sections:

- *Placing the Base station*
- *Placing the antennas and splitters*
- *Doing a site survey to determine coverage areas*
- *Registering beltpacks*

3.1 **Placing the Base station**

The first stage in setup is placing the Base station in a convenient location, knowing that it is the central routing unit of the FS II system. It should be made accessible.

At this stage you might choose to register all of the beltpacks with the Base station, or at least register one or two for system setup and testing.

3.2 **Placing the antennas and splitters**

The next step is to begin placing antennas and splitters to provide the necessary coverage areas for all of the beltpacks. The first placements of antennas and splitters will be experimental and temporary. After placing the antennas, walk through the coverage areas to check for gaps and then re-locate the antennas accordingly.

More information on checking coverage areas is given later in this chapter, in sections:

- **3.2.3 Determining coverage areas**
- **3.3 Doing a site survey to determine coverage areas**

Consider the following:

- What areas will have more than five active beltpack users in them at any time? Co-locate a second antenna there.
- Is there a central place to locate an antenna so that it will provide omnidirectional (all directions / circular) coverage?
- Are there balcony areas, corridors, or other rooms or areas that will require coverage with antennas?

For systems with only one or two transceiver/antennas, the cable runs will go directly from the two transceiver ports on the Base station. If you need more than

two transceiver/antennas you will need to decide where the splitters that feed these will be located.

The Base station supports two splitters.

If you need more than one antenna splitter, the second splitter must be connected directly to the Base station. Splitters cannot be connected in a daisy chain configuration. Each splitter supports up to 5 antenna/transceivers which in turn support up to 5 beltacks.

For antenna coverage options, see **3.2.3 Determining coverage areas**.

3.2.1 Wiring the antennas and splitters

To wire antennas and splitters:

- 1) Run 4-pair shielded Ethernet cable from the Base station to the antenna or splitter, and determine that the antenna or splitter is showing both power (green) and signal (amber) LEDs alight when the Base station is on.

Note: To meet FCC emissions requirements, a ferrite must be fitted on any shielded Ethernet cable plugged into either of the two ports labeled "transceivers." The ferrite should be fitted at the Base station end of the CAT-5 cable. Position the ferrite as close to the Base station as possible. The manufacturer of the ferrite is Wurth Elektronik (part number is 742 711 32).

- 2) Run 4-pair shielded Ethernet cable from the splitter to each of the transceiver/antennas.
- 3) Make sure that the local power supplies are plugged into the antennas.

If the green power LED and the amber data LED light up, then the transceiver/antenna has sufficient power from the cable. If the amber data LED flashes, a data link is established, and if the LED is solid, Base station synchronization is established and the system is ready to use. If there are several longer runs and you are attempting to power the transceiver/antennas from the Base station / splitter connection, check each one again when they are all connected. Local powering for the transceiver/antenna is recommended in most cases to provide the most reliable long-term FS II installation.

During the initial system setup, before walking through the system with a beltack to check for gaps in coverage, it is wise to avoid "permanently" installing the transceiver/antennas. Hold them in place in some temporary way until their optimal position is determined.

Note: 4-pair shielded Ethernet cable (CAT-5/5e/6) with RJ-45 connectors on each end is specified for connection between the Base station and the transceiver/antennas. Use of other cable can result in markedly shorter distances of cable runs and other possibly other performance problems.

3.2.2 Power supplies to the components of an FS II System

See figure 3-1 and figure 3-2 below for recommended powering and cable lengths for an FS II system.

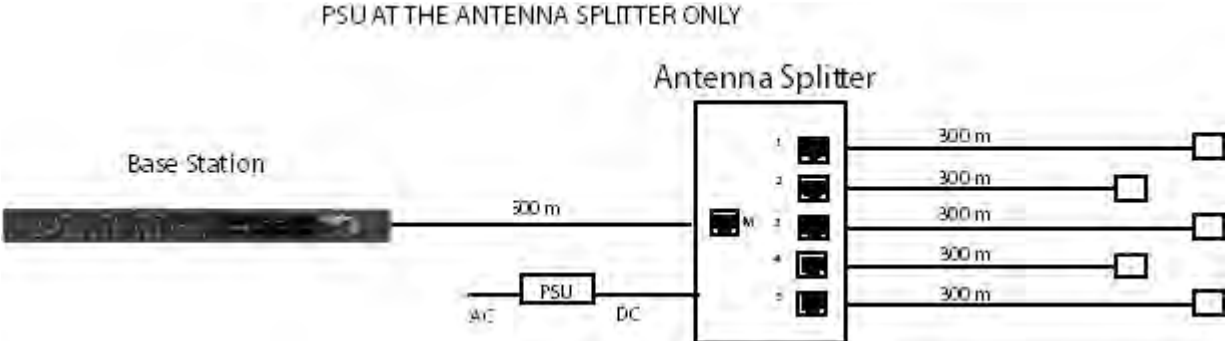

Figure 3-1 Recommended antenna and splitter powering schemes and cable lengths, PSU at splitter only

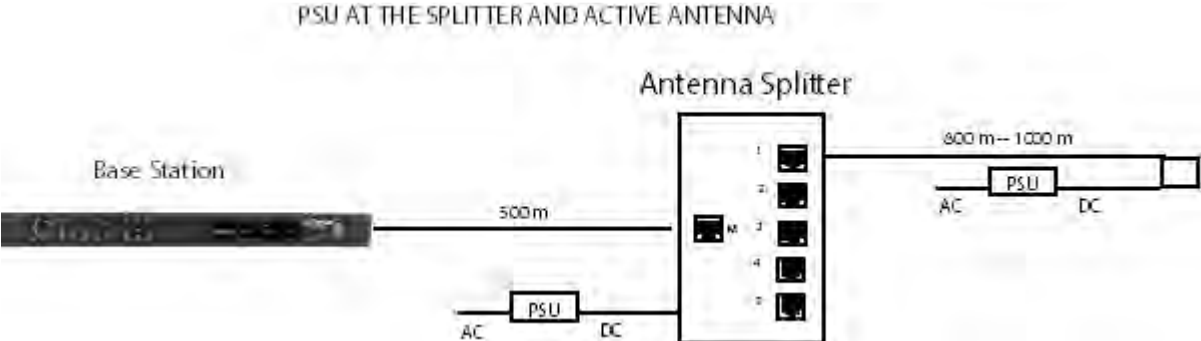
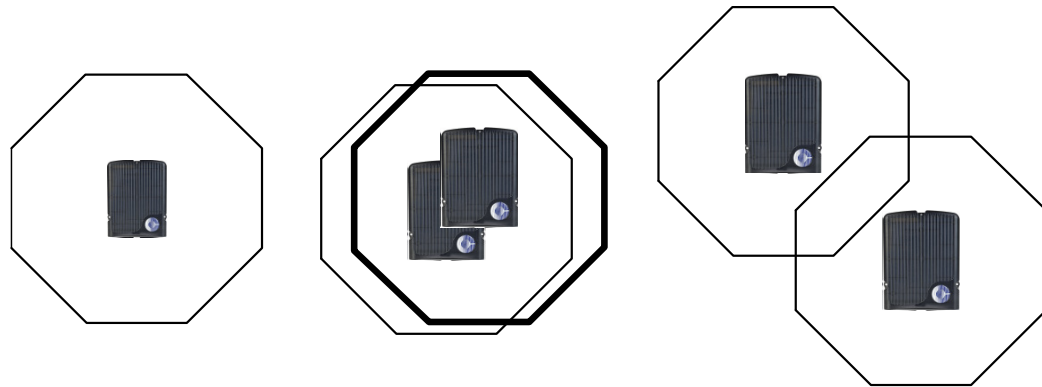

Figure 3-2 Recommended splitter and antenna powering schemes and cable lengths, PSU at splitter and antenna/transceiver

3.2.3 Determining coverage areas

After the transceiver/antennas and splitters have been initially set up proceed to test the coverage areas and re-locate antennas and splitters, if necessary, for optimal coverage.

The following figure illustrates some FreeSpeak II coverage scenarios.



- Each antenna covers a certain range or cell size.
- Maximum line of sight range: up to 500m (1640ft).
- Typical range: 50 - 150m (160 - 490ft).
- Each antenna covers 5 full duplex users (beltpacks).
- If two or more antennas are placed in the same area the cell size is the same.
- However, cell density has increased to handle up to 10 users in the same area.
- If antennas are placed across the site then this increases radio coverage area.
- Beltpacks can roam from one antenna to another and stay in constant communication.

Figure 3-3 Coverage areas for FS II TAs

Note: Cells can be completely overlapped for density (by co-locating multiple antennas). Cells can be overlapped at boundaries (increases radio coverage). For most working systems Clear-Com uses a ratio of 3-4 users per antenna. This is due to system losses.

To determine coverage areas:

- 1) When the Base station, splitter(s), and transceiver/antennas have been placed and wired, turn on an FS II beltpack (assuming that it has been registered with the Base station) and walk the coverage area.

Alternatively, use the "site survey" mode on the beltpack (see "Doing a Site Survey to Determine Coverage Areas" below). It is often best to begin with one antenna in place, and then place additional units to enhance coverage.

- 2) Walk through all of the areas where beltpack users will typically be moving, and note any areas of weak signal, dropout, or disconnection from the system. Pay special attention to the overlap areas between antenna coverage zones, making sure sufficient signal strength is there from each of the transceiver/antennas to make a clean handoff between them for the beltpack.
- 3) Finally, when the coverage zones have been properly and effectively set up, it is time to program the system. See Chapter 5, "Programming a System from the Base station" for instructions.

3.3 Doing a site survey to determine coverage areas

You might want to test coverage areas more extensively before setting up a complete system. Testing a system in the setting in which it will be located helps to meet operational needs. Factors in the local setting may affect the areas a system can cover, so it is important to plan a site setup accordingly.

Doing a complete site survey, as described below, helps to set up an optimal system. You can do a site survey using a beltpack that is connected to the system or one that is not connected to the system.

3.3.1 Doing a site survey with a beltpack

- 1) Place the FS II Base station in a convenient location. Link one beltpack to the Base station.
- 2) Place one connected antenna in the center of the coverage area.
- 3) Put the beltpack into **Site Survey** mode using the beltpack menu. See **7 Operating the wireless beltpack**. The following figures show the information that the Site Survey mode displays for connected and unconnected beltpacks.



Figure 3-4 An unconnected beltpack site survey screen

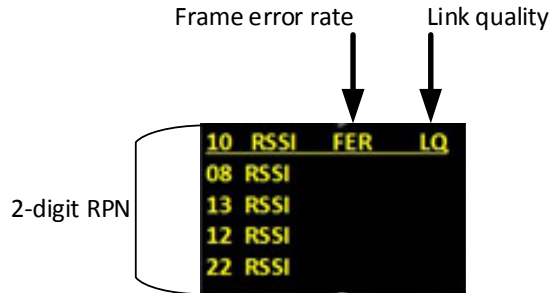

Figure 3-4 A connected beltpack site survey screen

Parameter	Meaning
Received Signal Strength Indication (RSSI)	A measure of the signal strength in a wireless environment. The higher the value, the stronger the signal.
Frame Error Rate (FER)	A measure of the signal connection quality. The lower the FER, the better the signal connection.
Link Quality (LQ)	A combined quality metric ranging from 1 (poor) to 5 (high).

Table 3-1 Key to site survey terms

- 4) Walk around the antenna with the beltpack, monitoring the beltpack *signal strength* and *goodness rating* at various distances.

The *signal strength* is shown in the Received Signal Strength Indication (RSSI) field.

- The signal strength number will fluctuate, ranging between 0 - 59 as you walk through the coverage area, and may even fluctuate as you stand still. As a rule-of-thumb the best system performance will be obtained when the signal strength remains at 30 or above. If the signal strength falls below 30 the beltpack may start losing audio. This is the limit of the coverage zone.
- A high Received Signal strength indication and a high Error rate may indicate that there is another RF system causing interference.

A beltpack can transmit to an antenna at a range of approximately 500m in good conditions.

- 5) Draw a map of the coverage zone for the antenna. The coverage zone is the area where the signal strength, as a rule-of-thumb, is 30 or above and the Line Quality is 3-5.

- 6) Repeat this process for as many antennas as necessary to cover the required area. Overlap coverage zones so that there is no area where the signal strength is below 30, and no area where the error rate is above a few percent.
- 7) The antenna placement will need to be adjusted to get the best coverage.

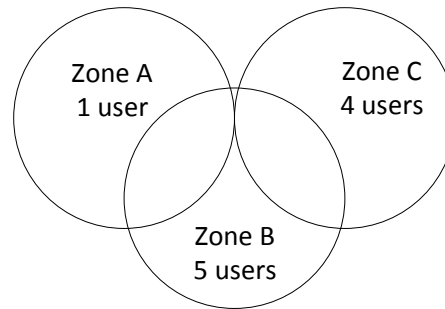

Figure 3-5 Mapping overlapping coverage zones

In some environments you might observe that despite having a high signal strength, the beltpack consistently reports a high error rate.

This could be due to two things:

- In-band interference from an RF source broadcasting in the 1.9/2.4 GHz area of the spectrum. This can be verified using a band monitor or by using a Spectrum Analyzer.
- Long Delay Spread Multipath, where the signal is bounced off a number of reflective surfaces, such as metal ceilings, gantries, walkways or other large structures. This problem is greatest where the reflective surface is large and exists at a range of distances from the antenna. To reduce the problem, consider siting the antenna where it cannot “see” the reflective surface or installing a reflector close to the antenna between it and the reflective surface.

3.3.2 Testing antenna handoff

After testing the coverage areas for individual antennas, test the handoff between the antennas. When you walk through a coverage area with the beltpack, the beltpack searches to find the antenna with the best signal strength, and switches transmission to that antenna. Therefore the beltpack continually hands off transmission among antennas as you move through the coverage area. You can determine which antenna the beltpack is connected to using the Configuration Editor Diagnostics Tool.

To test antenna handoff, connect any additional antennas in the installation and walk through the coverage areas to ensure that the coverage is continuous and complete, without audio breakups. Reposition antennas if necessary.

3.3.3 Getting information on active antenna status

You can also monitor which beltacks are connected to which antennas using the Base station SYSTEM menu and using the Configuration Editor Diagnostics Tool.

When you select ANTNS from the SYSTEM menu, the display shows the status of the active antennas that are connected to the Base station, and shows the slots on each antenna that are occupied by beltacks. This information may be useful during a site survey, or when troubleshooting coverage areas or antenna connections.

A typical display is shown below:



Figure 3-6 ANTNS menu

The numbers 1 through 10 represent the maximum number of antennas that can be connected to the Base station. Numbers 1 through 5 can be positions on a splitter connected to transceiver port 1, while 6 through 10 can be positions on a splitter connected to transceiver port 2. An antenna connected directly to transceiver port 2 would appear at position 6.

"_" indicates an empty slot on an active antenna that is connected to the Base station. A number in place of a "_" indicates that this slot is occupied by the indicated beltack.

Blank spaces next to an antenna number indicate that no connected antenna has been detected in this position.

So the above display would indicate that five antennas are connected to the Base station in positions 1, 2, 3, 6, and 7. There are no active antennas in positions 4, 5, 8, 9, and 10.

There are 4 beltacks currently connected. Beltacks 2 and 4 occupy the first 2 slots of antenna 3; beltack 1 occupies the first slot of antenna 6; and beltack 3 occupies the first slot of antenna 7.

The display updates every 4 seconds to reflect changes in antenna status and beltack connections.

Rotate or push in the setup/enter encoder to exit this menu.

3.3.4 Assigning beltacks to coverage areas

Each antenna is designed to handle five beltacks simultaneously. Although it can achieve this in good conditions, this may not always be possible for a number of reasons. First, interference or propagation problems may mean that not all

antenna slots are available all the time. Second, a belt-pack constantly searches for the best antenna signal, and may frequently switch antennas. To make this transmission seamless, a belt-pack maintains the connection to its current antenna until it is confident that the new antenna is functioning well. Therefore, for a short period of time during this transition, a single belt-pack can occupy slots on more than one antenna.

This means that for zones likely to need coverage for five or more belt-packs simultaneously it is recommended that a second antenna is installed. Similarly, for good coverage for nine or more belt-packs simultaneously, a third antenna may be required.

3.3.5 Conditions affecting coverage areas

The environment in which a system is located affects the coverage area for any particular belt-pack/antenna combination. The presence of walls, floors, ceilings, trees, shrubbery, people, and numerous other items may affect the coverage zone. Metallic objects, safety doors, lighting equipment, and bodies of water may possibly block transmission. These factors must be taken into consideration when planning the installation.

3.4 Registering belt-packs

Before you can use a belt-pack, you must first register it with the FreeSpeak II system.

You can register the belt-packs using a USB cable or over the air (OTA).

- For USB cable registration, use:
 - The FS II configuration editor (see **10.4.2 Registering belt-packs using the micro USB cable** to register the belt-pack to the Base station.
- For Over the air (OTA) registration, use:
 - The FS II Base station (see below)
 - The FreeSpeak Configuration Editor (**10.3 Registering belt-packs using the over the air (OTA) facility.**)

When registering belt-packs OTA, the basic steps are the same in each context though the detail is slightly different in each case.

- 1) The registration process must be enabled.
- 2) The belt-pack must be registered over the air (a radio frequency connection must be opened between the belt-pack and the antenna).

- 3) The beltpack registration details must be added to the software configuration.

3.4.1 Over the air (OTA) registration of a beltpack from the Base station

Belpack registration mode can be registered OTA from the Base station.

Note: You can also use a previously registered beltpack to enable registration mode. See **8.8.1 Enabling OTA registration mode**.

- 1) From the Base station menu go to MAIN MENU ->SYSTEM->REG->START using the setup/enter rotary encoder on the front panel of the Base station.

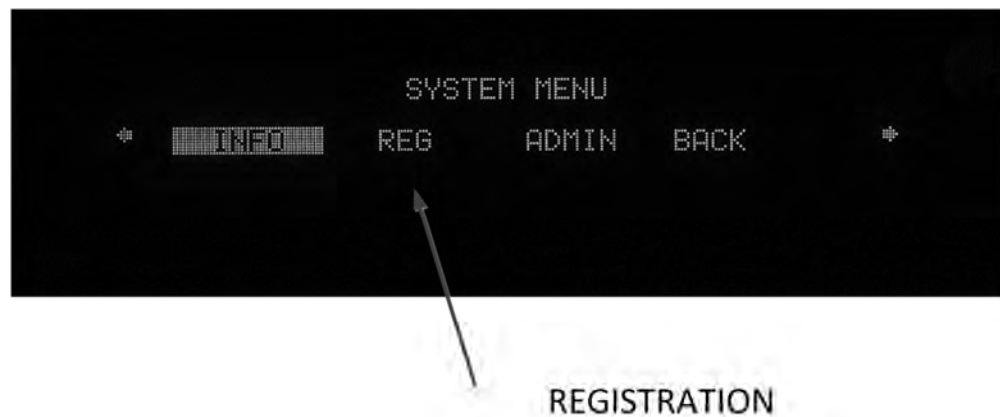

Figure 3-6 OTA registration from the Base station

This enables registration mode. Enable registration mode has a two minute inactive time-out. This is so that several beltpacks can be registered sequentially without the user having to re-enable registration mode. It also prevents unauthorized users from registering beltpacks.

- 2) On the beltpack to be registered, hold the menu key for two seconds to enter MENU options. Scroll to SYSTEM CONNECT using the rotary controllers and select it using key D. In menu mode the D key on the beltpack operates as SELECT and the C key exits the menu level and cancels the selection.

Note: On a new system there will be no previous connections at this point. However, if the beltpack is currently connected to an active system, a confirmation screen will appear. Select **Yes** to connect to a new system or **No** to remain connected to the current system.

- 3) Available systems, and previously registered systems, will be visible on the beltpack menu screen.

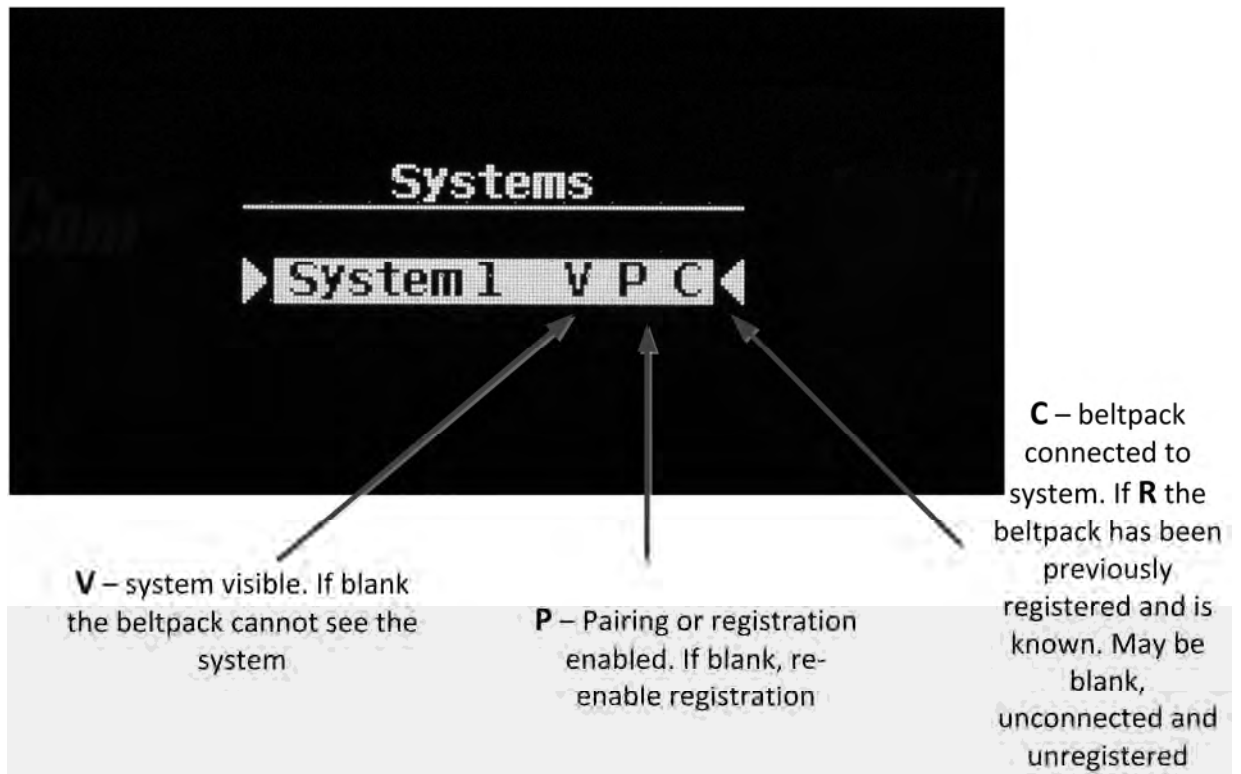

Figure 3-7 Beltpack systems

To connect the beltpack to the system, the system must be visible (V) and in registration (pairing) mode (P) on the beltpack screen. If the system is not in registration mode, registration should be re-enabled on the Base station. (Step 1).

Note: If a beltpack is currently registered to a system 'C' will be visible in this screen. If a beltpack is not currently registered but has been in the past 'R' will be visible. This shows that the beltpack has been previously registered with the system which might recognize it.

- 4) Enter the four digit pairing code for the system using both rotary controllers and the menu select key (D). The default code is 0000.

Note: The OTA registration code is available from the Base station menu. Go to **MENU->SYSTEM->REG->PIN**. It can also be found in Eclipse HX software, **Configuration > Preferences > Wireless Beltpacks** and in the Configuration Editor, under the **System** tab.

If you change the registration code from the Base station, do a black restart before continuing.

- 5) Select an available role from the list displayed on the beltpack.

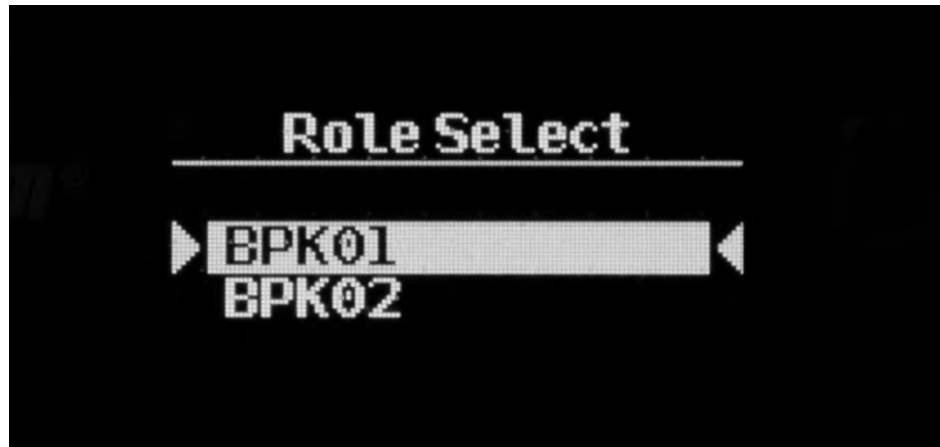

Figure 3-8 Select beltpack role

- 6) The beltpack is now registered and ready for operation. The inactive timer on enable registration is restarted now. The role is now associated with the beltpack until association is removed using the Configuration Editor or Base station.
- 7) If required, the next beltpack can now be registered (Step 2).

Note: On the Base station these changes are persistent, but should still be retrieved from the unit by the Configuration Editor so they can be backed up.

4 **Connecting the Base station**

This chapter explains how to connect the Base station to various wired and wireless audio interfaces through its rear-panel connectors. It contains the following sections:

- *Understanding the Back-Panel Connectors*
- *Connecting to partyline intercom systems*
- *Wireless partyline*
- *Connecting to 4-Wire and digital matrix intercom*
- *Connecting to a program audio source*
- *IFB configuration*
- *Connecting to the stage announce output*
- *Connecting to a PC*
- *Connecting to transceiver/antennas*

4.1 Understanding the Back-Panel Connectors

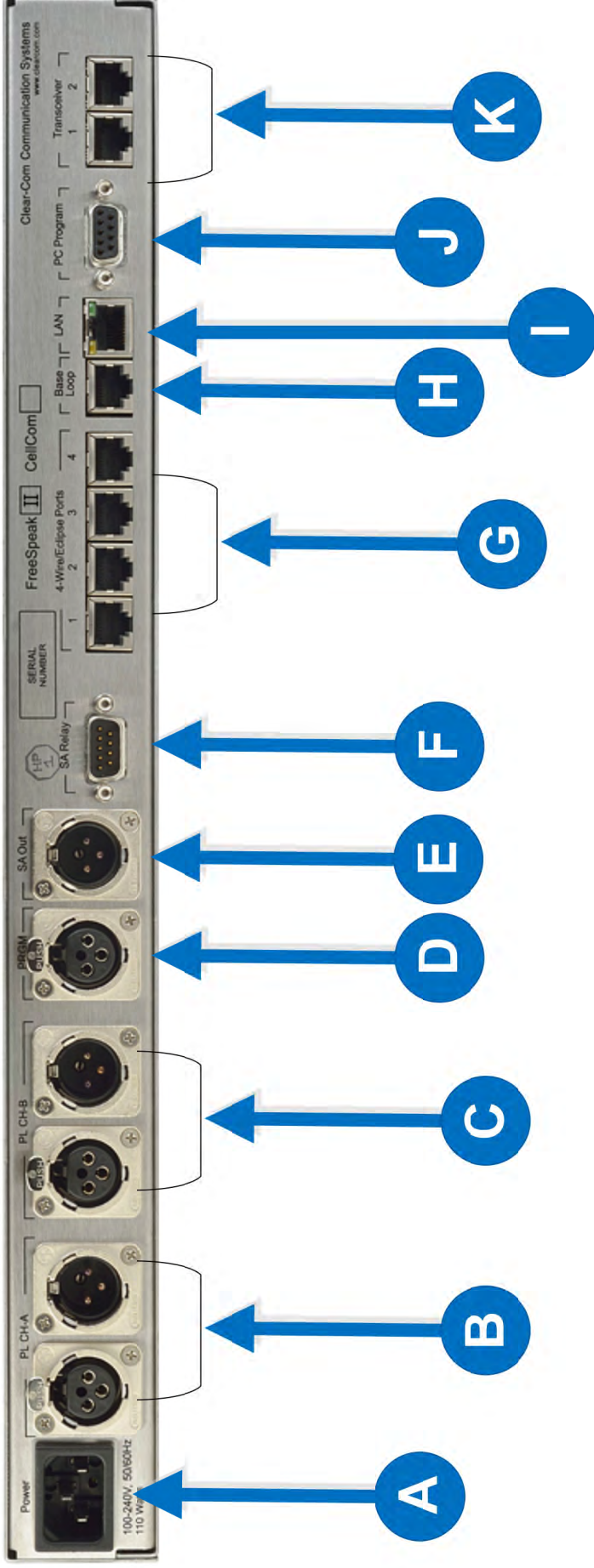

Figure 4-1 FS II Base station Back Panel

Key to FS II Base station rear panel											
Feature	Description										
A	<p>Power connector</p> <p>The 3-conductor AC power connector and universal power supply accepts voltages from 90 to 250 volts, at 50/60 Hz. Power consumption is 80 watts.</p>										
B	<p>Partyline channel A connectors</p> <p>The FS II Base station provides two pairs of partyline connectors, labeled “Channel A” and “Channel B.” Each pair of female and male 3-pin XLR connectors joins a channel of partyline intercom to the FS II, allowing communication between the wired partyline equipment and FS II wireless belt packs. Input and Output level control is set via the front-panel display programming.</p> <p>The second connector of each pair is a loop-through, so that the user can continue the connection to another FS II Base station or to another partyline belt pack or station. This connector auto-detects a connection with a powered partyline channel (30-VDC on Pin 2), and the Base station’s internal 200-ohm partyline termination and DC voltage to power PL belt packs is not activated.</p> <p>Alternatively, when a wired, unpowered partyline belt pack (up to four) is connected to PL CH-A with standard two-conductor shielded microphone cable, the Base station engages the 200-ohm termination and supplies 24-VDC to the belt pack(s) – allowing them to operate and communicate with the wireless belt packs in the system.</p> <table border="1" style="margin-left: auto; margin-right: auto;"> <thead> <tr> <th style="text-align: center;">Pin</th> <th style="text-align: center;">Function</th> </tr> </thead> <tbody> <tr> <td style="text-align: center;">1</td> <td style="text-align: center;">Mic ground</td> </tr> <tr> <td style="text-align: center;">2</td> <td style="text-align: center;">Mic +</td> </tr> <tr> <td style="text-align: center;">3</td> <td style="text-align: center;">Earphone ground</td> </tr> <tr> <td style="text-align: center;">4</td> <td style="text-align: center;">Earphone</td> </tr> </tbody> </table> <p style="text-align: center;">Table 2-1: Headset socket pin out</p>	Pin	Function	1	Mic ground	2	Mic +	3	Earphone ground	4	Earphone
Pin	Function										
1	Mic ground										
2	Mic +										
3	Earphone ground										
4	Earphone										
C	<p>Partyline channel B connectors</p> <p>These connectors are the same as the partyline channel A connectors.</p>										
D	<p>Program input.</p> <p>This female 3-pin XLR connector accepts a line-level audio signal from an outside source such as a mixing console or audio player. It is transformer- isolated. Level adjustment is done via the front-panel display programming. The program input can be assigned as an IFB source from the front panel.</p>										

Key to FS II Base station rear panel	
Feature	Description
E	<p>Stage announce output</p> <p>This male 3-pin XLR connector allows a line-level audio signal, typically from wireless beltacks or 4-Wire sources, to be sent to a paging system or other audio system. It is transformer-isolated. Level adjustment is done via the front-panel display programming. More than one audio source at a time can be routed to the Stage Announce, with the audio being combined to give a single audio output.</p>
F	<p>Stage announce relay</p> <p>This DB-9 male connector provides a relay closure that is triggered simultaneously with the SA Output. The relay may be used to open an audio pathway for the signal from the SA Output, or could also be used to activate a light or lock or some other device. The relay may be wired for normally closed or normally open operation, and the signal appears on pins 1 & 6 or 2 & 6. It is rated to a maximum of 30-VDC at 1 amp.</p>
G	<p>Four-wire matrix ports</p> <p>These four RJ-45 connectors can connect four full-duplex (input pair and output pair) audio connections from a 4-wire communications device, digital matrix intercom, or similar – making them available to the wireless beltacks. Any of the 4-wire ports or the program input can be assigned as IFB sources from the front panel.</p> <p>Each of these connectors has its own time slot, and can be addressed separately from a beltack, or combined with other beltacks and rear-panel connectors in a group. Level adjustment is done via the front-panel display programming.</p>
H	<p>Base loop connector</p> <p>The connector has no function in FS II.</p>
I	<p>LAN connector</p> <p>This RJ-45 connector allows the Base station to be connected to a LAN for system software upgrades and configuration downloads from the Configuration Editor. It is a 10BaseT Ethernet port.</p>
J	<p>PC connector.</p> <p>This female DB-9 connects to a PC computer for firmware updates and monitoring of the system configuration. It functions as a serial port.</p>
K	<p>Transceiver connectors</p> <p>These two RJ-45 connectors connect the Base station to two remote FS-TA transceiver/antennas or antenna splitters.</p> <p>Each wired transceiver/antenna communicates with five wireless</p>

Key to FS II Base station rear panel	
Feature	Description
	<p>beltpacks. Each antenna splitter provides connection for five transceiver antennas, providing communication with up to a maximum of 10 beltpacks depending upon available bandwidth.</p> <p>To meet FCC emissions requirements a ferrite must be fitted on any CAT-5 cable plugged into either of the two ports labeled "transceivers." The ferrite should be fitted at the Base station end of the CAT-5 cable. Position the ferrite as close to the Base station as possible. A suitable ferrite is available from Würth, part number 742 711 32.</p>

4.2 Connecting to partyline intercom systems

Up to two channels of partyline intercom can be connected to the FS II Base station. The descriptions below will discuss connections with Clear-Com and compatible partyline, RTS partyline, the ability of FS II to power up to four Clear-Com partyline beltpacks by itself, and the front-panel settings associated with these partyline connections.

Using the front-panel display and rotary encoder, the user may go into the PORTS menu, select the desired partyline channel, and create a five-character alphanumeric label for it. This is the label that would then appear on any beltpacks to which that partyline connection was assigned for communications. In the GROUPS menu, the partyline connection can be assigned as a member of any of the groups, as desired.

4.2.1 Clear-Com and compatible partyline

Clear-Com and Clear-Com-compatible wired partyline intercoms connect to the PL CH-A and PL CH-B connectors in a similar manner to connecting beltpacks or remote stations to the intercom line. Typically that wired intercom connection would have a 30-VDC current on Pin 2, coming from a main station or an intercom power supply. The second connector in the pair may be used as a loop-through to go to other wired partyline stations or beltpacks, or to a second FS II Base station. The pinout for partyline connector is shown in Table 4-1.

Pin	Description
1	Ground (shield)
2	Power
3	Audio

Table 4-1 Partyline pinout**4.2.1.1 To connect partyline equipment to the Base station**

- 1) Check that the partyline LED on the front-panel is out, which indicates that the partyline connection is disabled from the Base station.
- 2) Connect, and if appropriate, power up, the external partyline equipment.
- 3) Enable the partyline by pressing the "enable" button on the Base station's front panel.

The Base station detects power and termination settings when the partyline is enabled by pressing the "enable" button on the Base station's front panel, or when the Base station is powered up after having enabled the partyline. The Base station remembers that the partyline is enabled when it powers up.

When the FS II Base station detects a wired partyline being connected with 30 VDC on Pin 2, it does not enable the 24-VDC power supply that the FS II Base station supplies to the connector to support a handful of locally connected wired partyline beltacks. The Base station then appears to the wired partyline system as a remote station.

The first call to a Partyline channel A or B results in the call alert and subsequent ones do not give any further alerting unless the Partyline channel buttons on the Base station are toggled. This prevents all calls giving alerts when this is not necessary.

4.2.2 Connecting directly to Clear-Com partyline beltacks

PL CH-A and PL CH-B have the ability to directly support up to four Clear-Com RS-501/601/701 partyline beltacks each, without any other connection to a wired partyline system. This feature gives the convenience of being able to add a few wired beltacks when needed to an FS II installation.

Connect a standard two-conductor shielded microphone cable to the PL CH-A connector, and then connect it to a Clear-Com single-channel partyline beltack. Enable the partyline and the Base station will enable the required 200-ohm termination, and will supply 24-VDC to Pin 2 to power the beltack(s)

It is possible to daisy-chain up to four beltacks, or use an intercom XLR splitter at the Base station to feed microphone cables connected to the individual beltacks. Because it is a 24-volt rather than a 30-volt current, the maximum length of cable that can be connected (the sum of all of the runs) will be shorter than what is expected with the standard partyline voltage. Do the same with PL CH-B to support an additional four beltacks.

4.2.2.1 To connect to the partyline

- 1) From the main menu, scroll to PORTS and select by pressing the setup/enter encoder in.
- 2) Scroll to PLCHA or PLCHB and press to select.
The SELECTED PORT screen appears.
- 3) Scroll to and select CALLS.
The CALL DESTINATION screen appears.
- 4) Select the port or group to be connected to the partyline by scrolling to it and pressing the rotary encoder. Doing so creates a route to the selected destination—this port or group can now hear the activity on the partyline.
Note: This option can also be set to NONE.
- 5) Select TYPE from the menu.
- 6) Select either Clear-Com, Drake, or RTS.
- 7) The Base station automatically sets the termination, audio levels, and call signaling options for the selected partyline system.
Note: The Base station does not detect the RTS call signal.
- 8) If the changes are saved the route will be reinstated on power up.

Note: Suggested settings for a partyline connection are that the VOX should be set to -26dB, the gain output to -6dB and the input to 0dB.

4.2.3 Connecting to an RTS™ wired beltpack

FS II can only transmit and receive audio from channel 2 of an RTS wired beltpack. Connect using a standard XLR cable. Ensure that the partyline type is set to "RTS" using the menu on the Base station before enabling the partyline. See the chapter "Programming a System from the Base station" for more information.

Warning: Previous versions of this manual described a cable which would allow access to channel 1 of a dual channel RTS beltpack. DO NOT attempt to use a cable like this as it could result in damage to the FS II Base station.

4.2.4 Front-panel adjustments for partyline connections

To connect the partyline channels to FS II and make the communication available to the rest of the system, press the CH-A and/or CH-B enable switches. The LED

will light, and the connection is made. To disconnect the partyline connections, press these switches again. The switch may be “locked” in the SYSTEM menu so that the partylines may not be disconnected.

Because partyline intercom does not have global level control on a channel, input and output level controls are provided via the front panel programming. Scroll to PORTS on the main display screen and press the rotary encoder to select. Scroll to PLCHA or PLCHB and press to select. Select LEVELS, then select the input or output level. This notation is relative to the Base station—input level refers to the level at which everyone else hears the partyline, and output level refers to the level at which the users on the partyline channel hear everyone else. Use the rotary encoder to adjust the numerical level—clockwise to increase the level and counter-clockwise to decrease the level.

Make the estimated changes in level and press the rotary encoder to save the changes. Test the levels between the partyline and FS II beltpack, and make additional changes as needed. When the levels are set as desired, press to select and the display will go to the previous INPUT/OUTPUT screen. When both are adjusted, select BACK on each screen until the main screen is displayed.

Users connected to the Base station can be forced to listen to the activity on the partyline by initiating a “call”.

For more information on programming the Base station, see the chapter “Programming a System from the Base station”.

4.2.5 Troubleshooting partyline connections

4.2.5.1 Reducing FS II beltpack echo when talking to a analogue partyline

If the Base station and beltpack are not set up correctly the FS II user will experience an echo when talking to a partyline (either directly or via a group or a wireless partyline). The echo is caused by either local audio coupling in the headset due to the microphone gain being set too high or audio reflections from the partyline that can be minimized by setting a VOX gate on the partyline and the partyline being auto nulled. An FS II system has a built-in microphone gain control, but a VOX gate level can also be set in the configuration editor (see next section).

4.2.5.2 Include the partyline channel inside a wireless partyline group

It is recommended that when connecting to an analogue partyline system that the user includes the wireless partylines (WPL). The WPLs reduce the variation in audio levels heard when talking to analogue partylines. The WPLs are created in the configuration editor in a similar way to a user creating a group.

4.2.5.3 How to set the VOX gating level on the partyline connected to the Base station

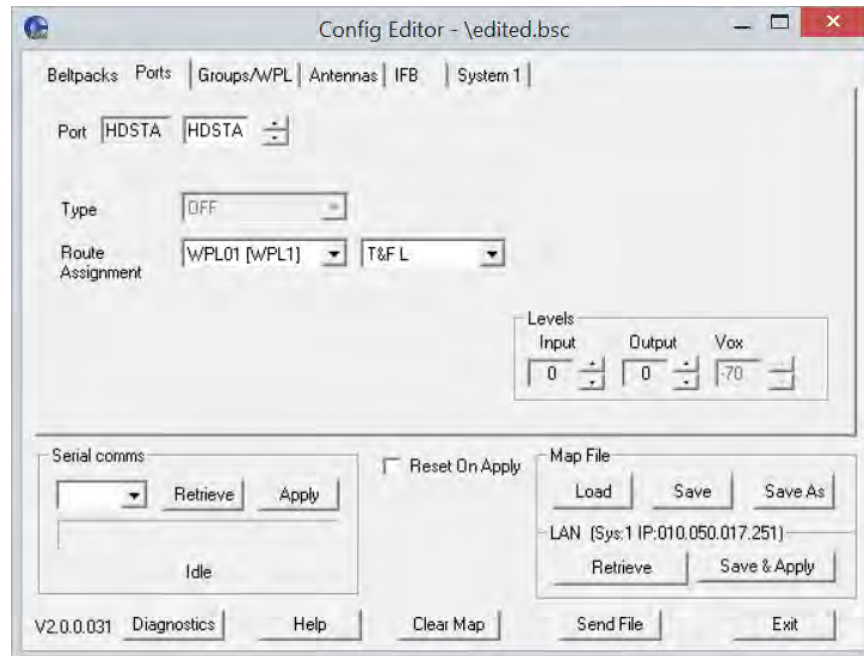

Figure 4-2 VOX Gating Level on partyline connection

The VOX gate allows the user to set limits to the audio that will be passed from the partyline to the Base station mixer; by setting the VOX level at the correct level the user can cut the audio reflections (which cause the echo) from the partyline when a wireless beltpack user speaks. This is achieved when the VOX level is set above the audio level of the reflections, thus allowing a partyline user's voice to pass through the VOX gate in the Base station mixer but the VOX gate will reject the audio reflections.

Note: If both the partyline user and the FS II user speak at the same time, the FS II user may hear the echo as the audio reflections piggy back the partyline audio.

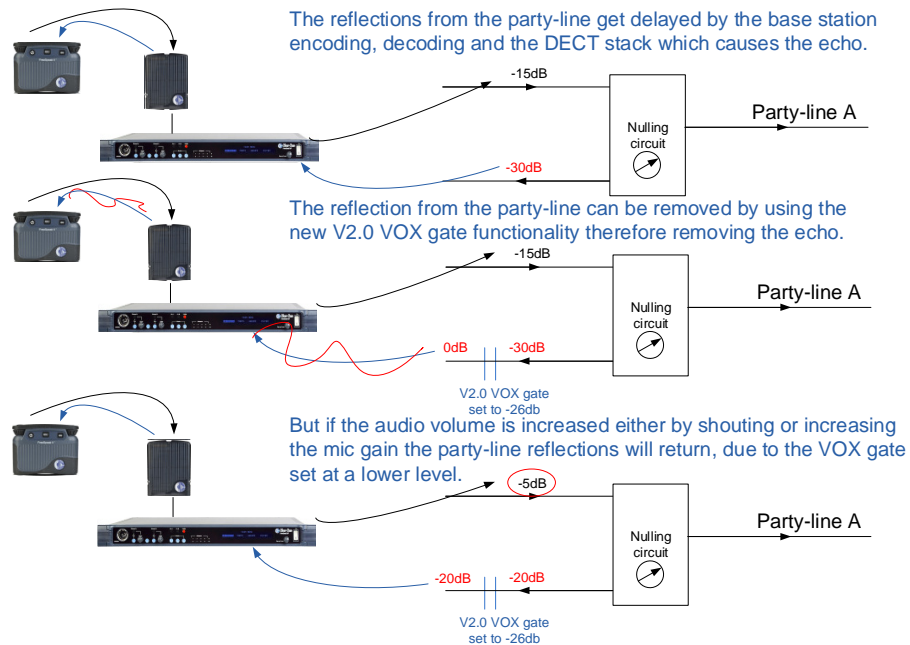

Figure 4-3 VOX Gate Setting Examples

Note: If the FS II beltpack users shouts or increases the microphone gain into the beltpack the echo might return if the audio reflections are above the VOX gate level.

4.2.5.4 Auto null the partyline channel at the Base station

Partylines connected to the Base station can be auto nulled by first enabling partyline channel by pressing the partyline button on the front of the Base station.

The auto nulling is then activated by pressing and holding the enable partyline button. The Base station will go then into an auto null routine.

4.3 Wireless partyline

The FS II Base station provides five wireless partyline groups which allow up to twenty eight members to be connected together in a conference call. The beltpack keys assigned to the wireless partyline group are assigned as dual talk and listen and partylines connected to the group are assigned as talk and listen.

When a beltpack or partyline talks to a wireless partyline group the talk signal from the beltpack or partyline is subtracted from the listen signal to remove the sidetone resulting from the user's voice being looped back in the conference audio, leaving only the audio from other members.

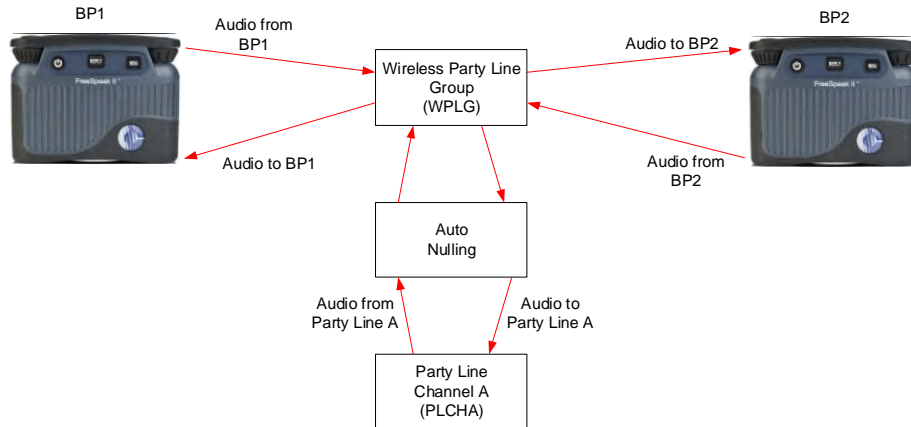

Figure 4-4 Wireless partyline Audio Flow

This facility allows conferencing over a large area between a mix of beltpacks, partyline stations and Eclipse system panels through an FS II Base station.

FS II beltpacks can only connect to a wired partyline via a wireless partyline. Therefore in order to allow beltpacks to talk to each other and a wired partyline a wireless partyline must be set up that includes the wired partyline (PLCHA or PLCHB) and the beltpacks (see Figure 4-5 Connecting beltpacks to a wired partyline). This ensures that the audio on the beltpacks is the talk audio and not the sidetone audio.

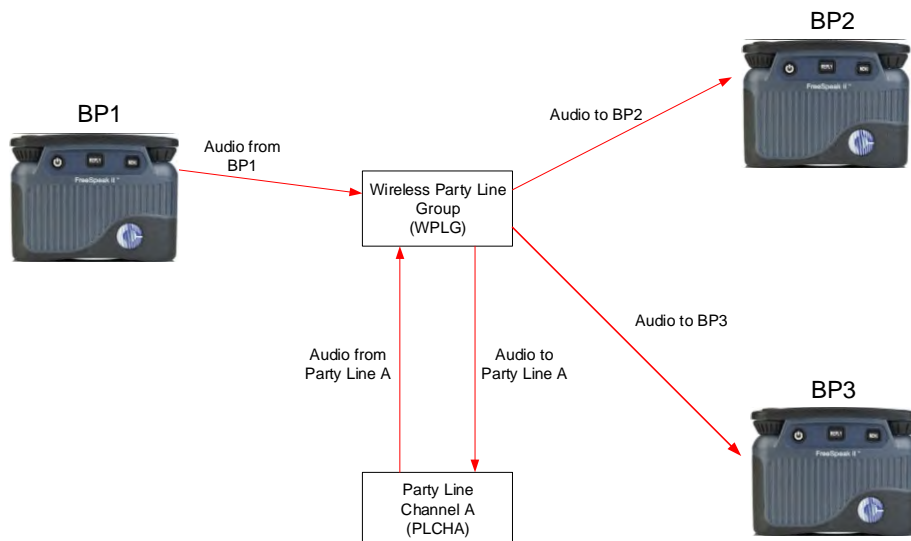

Figure 4-5 Connecting beltpacks to a wired partyline

4.4 Connecting to 4-Wire and digital matrix intercom

Up to four channels of 4-wire/digital matrix intercom can be connected to the FS II Base station. The descriptions below will discuss connections with Clear-Com Matrix Plus digital matrix, Clear-Com Eclipse digital matrix, other brands of digital

matrix intercoms, other 4-wire audio devices, and the front-panel settings associated with these 4-wire connections.

4.4.1.1 To connect the Base station to a matrix port:

- 1) Scroll to PORTS on the main display screen and press the rotary encoder to select.
- 2) Scroll to 4-WIRE and press to select.
- 3) Scroll to CALLS and press to select.
- 4) Select the port or group to create an audio path to and press to select. Doing so creates a route to the selected destination—this port or group can now hear the activity on the partyline.

Note: This option can also be set to NONE.

- 5) Once the changes have been saved, the route will be reinstated on power up.

Note: Call signaling is not currently supported on 4-wire connections.

In the GROUPS menu, the 4-wire port can be assigned as a member of any of the groups, as desired.

4.4.1.2 4-Wire Pinout

The pinout for the RJ-45 4-wire port is shown in Table 4-2 FS II Base station 4-wire pinout.

Pin	Description
1	Not used
2	Not used
3	Audio Output +
4	Audio Input +
5	Audio Input -
6	Audio Output -
7	Not used
8	Not used

Table 4-2 FS II Base station 4-wire pinout

4.4.2 Connecting to Clear-Com matrix plus

The connection between a Matrix Plus digital intercom port and an FS II 4-wire port is accomplished with a standard 4-pair straight-through CAT-5 data cable with RJ-45 connectors on both ends. In the current generation of FS II, the audio input and audio output pairs are all that will be used.

In the Matrix Plus PGM-WIN configuration software, set the matrix port that is connected to the FS-BASE Base station 4-wire port to "4-Wire". If the label of this FS II 4-wire port is to be put onto more than one intercom panel within the matrix system, and any and all people who have activated a talk/listen to that port are to be able to hear each other, as well as hearing the person talking to them from the FS II wireless beltpack, also check "Partyline Enable" for that 4-Wire connection in the configuration software.

Within the FS II Base station configuration software, the user can adjust the input and output level for that port. Alternately, the input and output levels can be adjusted on the FS II Base station for the particular 4-wire port, using the front-panel display. Repeat the procedure for each FS II 4-wire port that is connected with the Matrix Plus system.

Note: FS II does not currently generate a call signal to the Matrix port.

4.4.3 Connecting to Clear-Com Eclipse digital matrix

The procedure to connect between an FS II 4-wire port and the Eclipse digital matrix is similar to that of Matrix Plus 3. An identical connection is made with 4-pair straight-through CAT-5 cable between an Eclipse port and the FS II port.

Within the Eclipse Configuration System software (EHX) or ECS 5.2, set the port to "Direct." This will allow intercom stations in the Eclipse system to converse with the FS II Base station and beltpacks. Because there is not a "Partyline Enable" within Eclipse, if several users of intercom stations connected with Eclipse need to hear each other as well as the wireless FS II beltpack, another procedure will need to be added. Within the configuration software, the user would create a new partyline label, with members including the desired intercom stations and the particular FS II 4-wire port. That label would then be assigned to a key on each of the intercom stations, allowing connection with the FS II 4-wire port and the other members of the new partyline.

Within the FS II Base station configuration software, the user can adjust the input and output level for that port. Alternately, the input and output levels can be adjusted on the FS II Base station for the particular 4-wire port, using the front-panel display. Repeat the procedure for each FS II 4-wire port that is connected with the Eclipse system.

4.4.4 Connecting with other digital matrix intercom systems

Because FS II features standard 4-wire ports, with an input pair and an output pair, virtually any 4-wire signal can be connected with it. Make sure to properly match the input and output pairs between the digital matrix port and the FS II 4-wire port (see diagram below).

The pinouts for the first two 4-wire ports contain both audio and data connections, though the data connections are not currently used. Those pinouts are shown in the following table.

Pin	Function
1	Data Tx+
2	Data Tx-
3	Audio Out+
4	Audio In+
5	Audio In-
6	Audio Out-
7	Data Rx+
8	Data Rx-

Table 4-3 Pinouts for connecting to other digital matrix intercom systems

The remaining two 4-wire connections are audio only, and the data connections are unterminated (see Table 4-2 FS II Base station 4-wire pinout).

Within the configuration software of the other digital intercom system, configure its connected port to 4-wire or similar. Adjust the input and output levels either at matrix side or within the FS II front-panel display for the particular FS II 4-wire port.

4.4.5 Connecting with other 4-wire devices

Various other 4-wire audio devices can be connected with FS II. The Clear-Com EF-701M 4-wire interface can be used to attach additional partyline channels to FS II, converting them from partyline on the wired side to 4-wire on the FS II side.

The Clear-Com IF4W4 interface can be used similarly. The audio input side of the FS II 4-wire connectors could be used for additional program or other audio inputs that could then be accessed by FS II beltpacks. The audio output side of the FS II

4-wire connectors could be used to route an FS II wireless beltpack user's voice out of the system for paging or other reasons, similar to the SA OUT connector.

When using the FS II 4-wire ports in this way, make sure that proper connections are made between FS II and the other device. Adjust the input and/or output levels either at the 4-wire device or within the FS II front-panel display for that particular 4-wire port.

4.5 Connecting to a program audio source

FS II can connect with a program audio source, making it accessible to be assigned by itself to a communication path to one or more FS-BP wireless beltpacks, or to be added to a group with other communications and assigned to beltpacks. Using the two separate rotary encoder volume controls on the beltpack, the user can monitor the program on one control while talking and listening on an intercom channel with the other.

The balanced female 3-pin XLR connector accepts a standard audio signal from a mixing console or similar, with Pin 1 ground, Pin 2 audio hot (+), and Pin 3 audio cold (-). This connector is transformer-isolated.

To make the program input signal available to the system, the front-panel PRGM enable button must be activated/on. The red LED above it will light, indicating that it is now available. This front-panel switch may be "locked" to prevent accidental disengagement, using the front panel display.

Using the front-panel display and rotary encoder, the user may select PORTS and give the connector a five-character alphanumeric label. The user may assign that program input by itself to a beltpack using the BELTPACKS menu, or use the GROUPS menu to assign the program input to any group or wireless partyline. Program input can be assigned to multiple groups or wireless partylines using the GROUPS menu.

4.6 IFB configuration

One of five FS II Base station inputs can be defined as a source for an IFB. These inputs are the Program Input and the four 4-Wire ports. All the 4-Wire ports, partyline channels, beltpacks, wireless partylines and stage output can be defined as IFB destinations.

Up to ten IFB key configurations can be set up that group together an IFB source and a number of IFB destinations and set the dimming level for that IFB key configuration.

IFB Source	IFB Destination	IFB Talks
Program Audio	Four-wire 3 Four-wire 4 All beltpacks	All beltpacks
Four-wire 4	Four-wire 4 All beltpacks	All beltpacks

Table 4-4 IFB key configurations

An IFB talk is a panel or beltpack with a key set up to talk to the IFB key configuration. Whenever an IFB talk key is pressed the audio from the IFB source to the IFB destinations configured in the IFB key configuration is dimmed by the set amount and the audio from the IFB talk is heard by all the IFB destinations set up in that IFB key configuration.

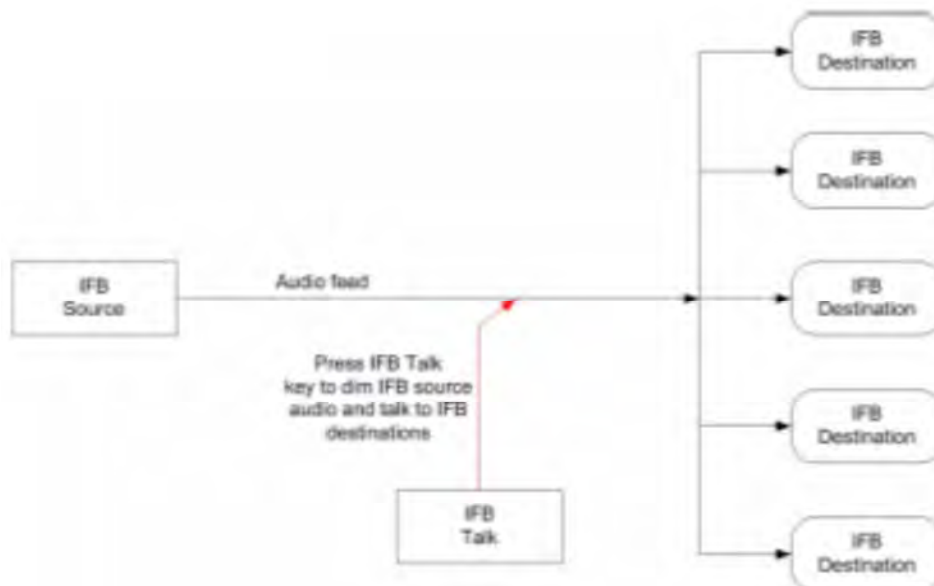

Figure 4-6 IFB Audio Path

The IFB source audio will be dimmed on the IFB destinations for as long as the IFB talk key is active. When the IFB talk key is released the IFB source audio to the destinations will return to normal level.

4.7 Connecting to the stage announce output

The stage announce feature allows a talker to route their voice to an external paging system or other audio destination by pressing one of the rotary encoders to which the SA OUT connector is assigned. The adjacent SA RELAY is simultaneously triggered. One beltpack user at a time may use this feature,

though the capability may be assigned to any or all of the wireless beltpacks, as desired.

Connect a microphone cable to the male 3-pin XLR connector on the rear of the FS II Base station, and connect the other end to the external audio system. When the output is activated, the beltpack user's voice will be sent at line level to the audio system. The audio output ceases when the beltpack user stops pressing the rotary encoder; it is good practice to make sure that any rotary encoder to which the SA OUT is assigned is set to momentary/non-latching mode.

Pin	Function
1	Normally Closed
2	Normally Open
3	N/C (no connection)
4	N/C
5	N/C
6	Pole
7	N/C
8	N/C
9	N/C

Table 4-5 Pin assignments for stage announce connector

The associated SA RELAY can be assigned to open an audio route for the paging or announcement, or can be assigned to initiate any other event such as turning on a light or activating a lock. It is rated at a maximum of 30 VDC at 1 ampere. The relay can be wired to be either normally open or normally closed, using the pinout information in Table 4-5 Pin assignments for stage announce connector .

4.8 Connecting to a PC

4.8.1 Connecting using the serial port

The PC serial port on the rear of the FS II Base station is mainly used for firmware version upgrades of the system.

A specially wired cable is required for these updates, consisting of two 9-pin D-type connectors for the PC and the FS II ends. On the FS II end, a male 9-pin D connector is used, and is wired as follows in relation to the D connector pins on the PC end. Pin 2 goes to pin 3, pin 3 goes to pin 2, and pin 5 goes to pin 5; in

other words, the data Tx and Rx lines on pins 2 and 3 are reversed. Those are the only wiring connections on the FS II end of the cable.

PC Connection (9-pin F)	Base station (9-pin M)
1	N/C
2	3
3	2
4	N/C
5	5
6	N/C
7	N/C
8	N/C
9	N/C

Table 4-6 Pinout for cable to upgrade Base station firmware

On the PC end, a female 9-pin D connector is used. Make sure that the data connections of pin 2 to pin 3 and pin 3 to pin 2 are followed, and that pin 5 goes through to pin 5. Then short pins 1, 4, 6, and 8 together on the PC end of the cable. The cable will now be ready to use with the any upgrade files from the factory. Table 4-6 Pinout for cable to upgrade Base station firmware gives the pin configuration for this cable. Table 4-7 Pinout for cable to upgrade belt-pack firmware shows the pin configuration for the cable used to upgrade belt-pack firmware.

PC Connection (9-pin)	BELTPACK (3.5 MM JACK)
1	N/C
2	tip
3	ring
4	N/C
5	screen
6	N/C
7	N/C
8	N/C
9	N/C

Table 4-7 Pinout for cable to upgrade beltpack firmware

4.8.2 Connecting using the LAN port

This connection is used for rapid firmware updates, as well as in the future for system configuration and intelligent connection with the Eclipse digital matrix. It is wired as a standard Ethernet connection.

The Base station has a fixed IP address. This can be found by selecting SYSTEM and then INFO from the front-panel display menu. Refer to the chapter “FS II Toolkit” for more information on using the LAN port to upgrade firmware.

4.9 Connecting to transceiver/antennas

4.9.1 Connecting one transceiver/antenna directly to a transceiver port

A transceiver/antenna connects to the transceiver port on the FS II Base station using a standard 4-pair CAT-5 data cable with RJ-45 connectors. It may be located up to 1,000 meters from the Base station if 24AWG cable is used or for 500 meters if 26AWG cable is used creating a coverage area for five FS-BP wireless beltpacks in that location. The port is able to provide the required power to the transceiver/antenna at a distance of up to 300 meters (approximately 900 feet); beyond that distance, the FS-TA transceiver/antenna must be locally powered via its in-line external universal power supply.

Note: It is recommended that shielded CAT-5 cable or better is used.

To know that a transceiver/antenna is active, observe the green power LED and the yellow signal LED on the face of the unit where the RJ-45 connector is connected. Both must be lit. Also, wireless beltacks in the vicinity of the active transceiver/antenna will be connected to the system and their displays will show labels and other information.

Using both transceiver ports, a Base station may be connected with up to two transceiver/antennas via a direct connection with the Base station. For the best, most reliable coverage, it is advisable to use a minimum of two transceiver/antennas in any installation, positioned in different locations in the coverage area. When more antennas are required to support a larger coverage area or more wireless beltacks, an antenna splitter will need to be introduced between the Base station and the transceiver/antennas.

Note: In some situations, particularly in outdoor venues, interference from external radio sources can severely reduce the range of the system. In these cases we recommend a site survey as described in Chapter 8, "Installing a System".

4.9.2 Connecting transceiver/antennas with a splitter (PD2203)

A splitter (PD2203) will connect up to five transceiver/antennas to one of the transceiver ports on the FS II Base station, creating up to five coverage zones that can be overlapped to make large areas where FS-BP wireless beltacks can have continuous coverage. The use of the splitter also extends the distance that the transceiver antennas can be located from the Base station to 2,000 meters (6,400 feet) if 24AWG cable is used or 1,000 meters (3,200 feet) if 26AWG cable is used (assuming the same cable type is used to connect the antenna to the splitter and the splitter to the Base station).

Note: It is recommended that shielded CAT-5 cable or better is used.

For example, a splitter can be used to connect to an FS II Base station that is located in a production truck outside an arena or stadium, with a single CAT-5 cable going to the splitter which is then located just inside the stadium. From that splitter, up to five transceiver/antennas are distributed throughout the stadium to create wide coverage – each with a run of CAT-5 cable back to the splitter. A similar arrangement may be used in a large theatre or performing arts facility.

The connection between a transceiver port on the FS II Base station and a PD2203 splitter is accomplished with standard 4-pair CAT-5 data cable with RJ-45 connectors. It is connected to the port labeled MATRIX on the splitter. This cable can be as long as 1,000 meters (3,200 feet) if 24AWG cable is used or 500 meters (1,600 feet) if 26AWG cable is used. The splitter must be locally powered via its DC IN connector, using the in-line external universal power supply. The RJ-45 ports on the splitter labeled "1" through "5" are the connections to the FS-TA transceiver/antennas.

4.9.3 Powering an antenna or antenna splitter

Provision of 24 VDC power to an FS II antenna is done as follows:

- Connect the antenna to a 150/UNI-DIN power supply unit through the 4-pin DIN connector at the antenna.
- Connect the antenna to an antenna splitter which is powered by a power-supply unit.

The preferred method is to connect the antenna to a powered antenna splitter, as illustrated in Figure 4-9 Powering an antenna splitter . An antenna splitter distributes power to all antennas connected to it. A single power-supply unit can power the maximum 5 antennas. However, maximum cable lengths will be reduced.

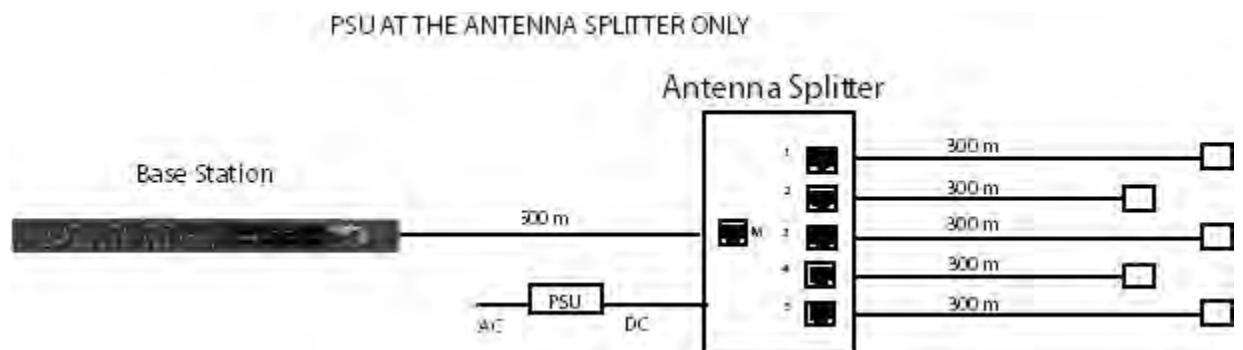

Figure 4-7 Recommended antenna and splitter powering schemes and cable lengths, PSU at splitter only

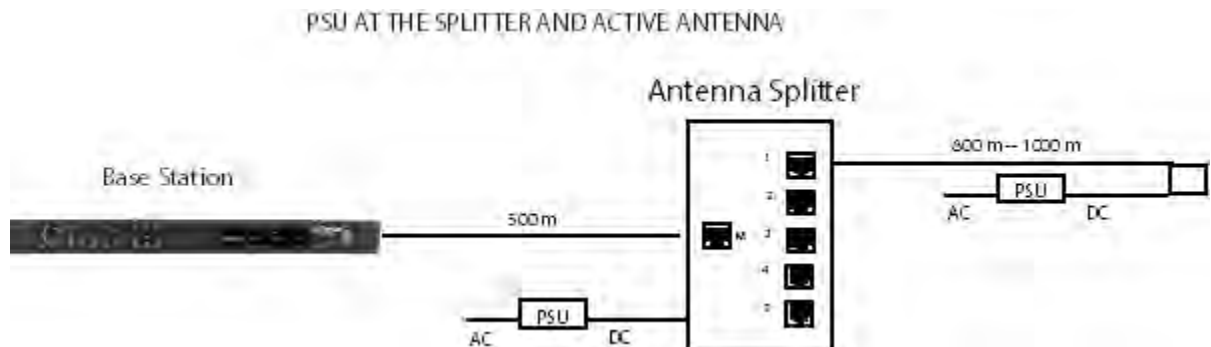

Figure 4-8 Recommended splitter and antenna powering schemes and cable lengths, PSU at splitter and antenna/transceiver

Figure 4-9 Powering an antenna splitter

5 *Operating the Base station*

This chapter explains how to operate the FreeSpeak II Base Station. It contains the following sections:

- *Introduction*
- *Understanding Front-Panel Operation*

5.1 **Introduction**

The FS II Base station provides all of the intelligence and signal routing for the FS II digital wireless intercom system. The Base station is a full-duplex digital matrix communications system, with virtual “ports” for the wireless beltpacks rather than physical ports.

In its memory, the Base station contains all of the labels and communications paths assigned to each beltpack, and this information is sent to the beltpacks via the transceiver/antennas as soon as they are switched on and recognized by the base.

The Base station also functions as the interface between wired and wireless communication devices. The two partyline intercom connectors, four 4-Wire connectors, and program input/stage-announce output each have their own full-duplex time slot. They can be labeled, added to communication groups, and assigned to beltpacks as desired. Additionally the program input or one of the four 4-Wire connections can be assigned as IFB sources on the Base station.

5.2 Understanding Front-Panel Operation

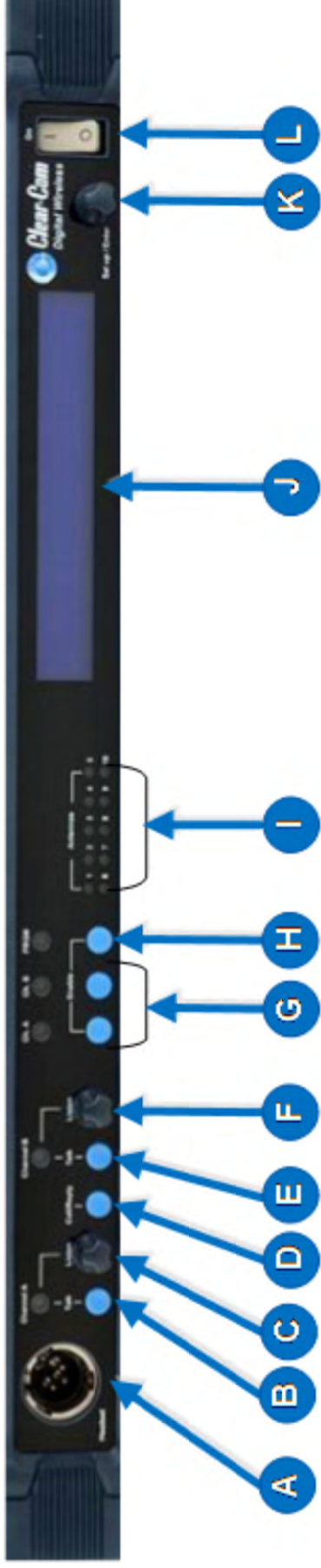

Figure 5-1 FS II Base station Front Panel

5.2.1 Call Channel A

Pressing buttons (B) & (D) together will send a call signal to the port, group or wireless partyline (WPL) assigned under headset channel A. The Talk button (B) must be engaged momentarily before the Call/Reply (D).

5.2.2 Call Channel B

Pressing buttons (E) & (D) together will send a call signal to the port, group or WPL assigned under headset channel B. The Talk button (E) must be engaged momentarily before the Call/Reply (D).

Key to FS II Base station front panel	
Feature	Description
A	<p>Headset connector</p> <p>The 4-pin male XLR-type headset socket connects to Clear-Com headsets and other headsets with 4-pin female connectors. This headset connector is for the on-board two-channel intercom, with controls just to the right of the connector.</p>
B C	<p>Headset channel A talk control/listen control</p> <p>The channel A talk switch and associated light, and listen level encoder, allow full-duplex conversations with any FS II wireless belt packs or other communications systems wired to the rear of the Base station to which the on-board Channel A has been assigned. Assignments are done via the front-panel programming.</p> <p>The talk switch is momentary/latching, such that pressing it and holding down will create a talk path that ends when the user releases the switch, while quickly tapping it will latch the talk, and a second tap will release it. The LED lights red when a talk is active.</p> <p>Turning the listen level encoder clockwise will allow the user to hear the other party's voice, increasing the level to maximum when fully clockwise.</p>
D	<p>A/B reply button.</p> <p>Pressing this button will reply to the last caller to call A or B.</p>
E F	<p>Headset channel B talk control/listen control</p> <p>The channel B talk switch and associated light, and listen level encoder, function the same as the controls for Channel A.</p>
G	<p>Partyline channels A and B</p> <p>The channel A and channel B enable switches and associated lights activates the power only on the rear-panel to partyline intercom channels A and B. Activating one or both of these switches enables the power to that party line but does not affect the audio to the partyline which is always connected. These switches may be "locked" via the front-panel SYSTEM programming menu so that they may not be disengaged accidentally. See 6.21 Locking Front Panel Enable Buttons.</p> <p>If the button is held in for more than 8 seconds autonulling mode will be enabled for the current partyline and the following message will be displayed:</p> <p>"Release button to begin autonulling"</p> <p>When the button is release the Base station will perform an autonulling on the current partyline. On completion the following</p>

Key to FS II Base station front panel	
Feature	Description
	<p>message will be displayed:</p> <p>“Partyline A/B Autonulling complete”</p> <p>The autonulling process is recommended on initial system set up and when the partyline system has been changed.</p>
H	<p>Program audio enable switch</p> <p>This latching switch makes any program audio signal that enters via the rear-panel line-level 3-pin XLR connector available to be assigned to wireless beltpacks, either separately or mixed with communications groups. This switch may be “locked” via the front-panel SYSTEM programming menu so that it may not be disengaged accidentally.</p>
I	<p>Antenna ready light display</p> <p>These green LEDs, one for each of the ten antennas that the Base station will support, light when an antenna is connected and ready.</p>
J	<p>Display screen.</p> <p>The display screen shows all of the menus and programming options that are available within the FS II system. The user can select a particular beltpack and view all of its current talk/listen assignments, or see all of the current members of a particular group. Via the screen and rotary encoder, labels (5-character user names) can be created and/or changed, new members assigned to groups, input and output levels adjusted, and so on.</p>
K	<p>Scroll/enter control</p> <p>The setup/enter encoder is used to scroll through the various menu options within the FS II Base station, in order to discover specific information regarding users or to program communications routes and groups. Turning the encoder clockwise scrolls display items toward the right, and turning the encoder counter clockwise scrolls display items toward the left.</p> <p>When a desired menu item is highlighted, pushing the setup/enter encoder inward will select that item. The lists of available beltpacks and groups typically span two or more screens, so when the highlight is at the leftmost or rightmost part of the screen and the user continues to turn the rotary encoder in that direction, the display will jump to the next screen selections (Example: in the beltpack sections, the first screen shows beltpacks 1 through 5, and the second shows 6 through 10.)</p> <p>Pressing and holding the setup/enter encoder for more than three</p>

Key to FS II Base station front panel	
Feature	Description
	seconds will return the display to the battery monitor.
	Power switch The power switch will turn the FreeSpeak Base station on and off.

6 ***Programming a system from the Base station***

This chapter describes how to program the FreeSpeak II system using the Base station front panel controls and menu. It contains the following sections:

- *Introduction*
- *Using the Base station's programming menus*
- *Saving changes*
- *Changing beltpack labels*
- *Setting and changing port labels*
- *Setting and changing group labels*
- *Adding group members*
- *Beltpacks*
- *Assigning audio routes to a beltpack*
- *Setting the beltpack audio level*
- *Setting beltpack latching*
- *Over the Air (OTA) beltpack registration from the Base station*
- *Setting input and output port levels*
- *Setting port call destination*
- *Configuring a wired partyline*
- *Base station System Menu*
- *System*
- *Restoring the Defaults*
- *Antennas*
- *Setting the IP address*
- *Locking front-panel enable buttons*
- *Remote microphone kill*
- *Battery indicator*

6.1 Introduction

An FS II system is programmed using the menus displayed on the Base station's front panel. Programming the system requires four basic steps:

- 1) Create individual names ("labels") for the wireless beltacks and for the wired devices connected to the Base station. Use individual labels for building "point-to-point" communication paths.

Labels are composed of five alphanumeric characters. Labels can be created for users' names ("John" or "Susan"), roles ("AUDIO" or "DIR"), or for connections ("PL_A" or "PL_B").

Alternatively a device's generic name can be used, which never changes. An example of a generic name is "BPK01" for Beltack 1. Generic names are always displayed on the programming menus.

- 2) **Create names ("labels") for groups.** A group label is used when an FS II beltack needs to communicate with all members of a group simultaneously, as in a partyline. Up to ten groups can be created, with five groups being standard groups and five groups being wireless partyline groups. Up to fifteen members can be assigned to a standard group and up to twenty eight members can be assigned to a wireless partyline group.

A label can be customized to reflect the group's function, such as "STG-A" for communicating with the production staff on Stage A.

Alternatively the generic names assigned for the ten possible groups can be used. For example, "GP#01" is the generic name for Group 1.

- 3) **Assign members to the groups created.** Group members are drawn from the wireless beltacks and from the wired devices connected to the Base station. A group created from these devices functions as a partyline, in which all members of the group can communicate simultaneously with all other members of the group.
- 4) Assign individual and grouped devices each FS II beltack by using the programming screens on the Base station's front panel. Each assignment creates a communication route from the FS II beltack to the selected device or group. Up to four communication routes can be assigned to a beltack.

These steps are discussed in more detail in the following sections.

6.2 Using the Base station's programming menus

An FS II system can be programmed using the programming menus that appear on the Base station's front-panel display screen. The user navigates through the menus to select programming options for the system.

Rotating the setup/enter encoder allows the user to scroll through the selections on the screen. As the user scrolls through the menu items are highlighted on the screen. To select an item as a new programming option, press the setup/enter encoder in, as if it were a pushbutton, when the desired item is highlighted on the screen.

6.3 Saving changes

The changes are saved and applied automatically when changes are made to the unit's programming. Five seconds after the last time the setup/enter encoder was turned or pressed, the front-panel display flashes to indicate that the changes are being saved and applied.

6.4 Changing beltpack labels

The first step in creating an FS II system is to create individual names ("labels") for the wireless beltpacks and for the wired devices connected to the Base station. Use individual labels for building "point-to-point" communication routes.

6.4.1 To change a beltpack label

- 1) From the MAIN menu on the Base station's front panel display, scroll to and select BELTPACKS, as shown in Figure 6-1 From the MAIN menu, select BELTPACKS.



Figure 6-1 From the MAIN menu, select BELTPACKS

The AVAILABLE BELTPACKS menu appears, as shown in Figure 6-2 Available beltpacks menu below. The first page shows the first five beltpack labels.



Figure 6-2 Available beltpacks menu

- The beltpacks' generic labels BPK01 through BPK05 appear on the upper row, while the labels given to the beltpacks appear just under the generic

labels. At first both upper and lower labels will have the same generic designations.

- To get to the second, third and fourth pages of beltpacks, scroll all the way to the right of the screen, and then continue to scroll. The second, third and fourth pages will be displayed showing beltpacks 6 - 10, 11 - 15 and 16 - 20 (BPK06 - BPK10, BPK11 - BPK15, BPK16 - BPK20).

- 2) Scroll to and select the desired beltpack.

The next menu that appears gives the options for programming the selected beltpack, as shown in Figure 6-3 First beltpack programming options menu.



Figure 6-3 First beltpack programming options menu

- 3) Scroll all the way to the right of the screen and continue to scroll. The second beltpack programming options menu will be displayed.



Figure 6-4 Second beltpack programming menu

- 4) Scroll to and select LABEL from the menu.

A menu to edit the selected beltpack label appears, as shown in Figure 6-5 editing a beltpack label. The current 5-character label appears, just under its generic name.



Figure 6-5 editing a beltpack label

- 5) Scroll to and select the alphanumeric character to be changed. A box appears around the character.
- 6) Rotate the setup/enter encoder. As the encoder is rotated the entire range of available characters appears, starting with upper-case characters,

proceeding to lower-case characters, then to digits, and finally to punctuation characters.

- 7) When the desired new character appears, press the setup/enter encoder to select it. The box disappears, and is replaced by the solid highlight.
- 8) Repeat steps 4 through 6 for all the characters in the label that are to be changed.
- 9) When editing the label has been completed, select BACK to return to the PROGRAMMING OPTIONS menu.
- 10) The changes are saved and applied automatically five seconds after the last time the setup/enter encoder was pressed or turned. The front-panel display flashes to indicate that the changes are being saved and applied.
- 11) The beltpack that has had a new label assigned to it should be power cycled to ensure it is updated with the new label.

To edit another beltpack label, scroll clockwise to the BACK command and select the beltpack. The AVAILABLE BELTPACKS screen appears. Select a new beltpack label to edit, and repeat steps 2 through 9.

6.5 Setting and changing port labels

Port labels are created to identify the audio devices wired to the Base station's rear panel ports, such as partyline beltpacks, 4-wire devices, program sources, and stage-announce outputs and relays.

6.5.1 To create a port label

- 1) From the Base station's MAIN menu, scroll to and select PORTS (see Figure 6-6 Select "Ports" from the main menu).



Figure 6-6 Select "Ports" from the main menu

The first AVAILABLE AUDIO PORTS menu is displayed, as shown in Figure 6-7 First available ports menu.



Figure 6-7 First available ports menu

The first page of the menu shows the first 5 ports, starting with HDSTA (front-panel headset A) and continuing through 4WIR3 (the third 4-wire connector on the rear panel), as shown in Figure 6-7 First available ports menu.

By scrolling all the way to the right, and then continuing to scroll, 4WIR4 through PRGRM (program) will be displayed (Figure 6-8 Second available ports menu).



Figure 6-8 Second available ports menu

Note: The upper character of the pair is a generic label, while the lower character is editable.

- 2) Select an audio port from the menu. A screen appears that gives the options for programming the selected port, as shown in Figure 6-9 Port programming options menu.



Figure 6-9 Port programming options menu

- 3) Select LABEL from the menu.

A menu to edit that port's label appears as shown in Figure 6-10 Editing a port's label.



Figure 6-10 Editing a port's label

- 4) Scroll to and select the alphanumeric character to be changed. A box appears around the character.

- 5) Rotate the setup/enter encoder. As the encoder is rotated the entire range of available characters appears, starting with upper-case characters, proceeding to lower-case characters, then to digits, and finally to punctuation characters.
- 6) When the desired new character appears, press the setup/enter encoder to select it. The box disappears, and is replaced by the solid highlight.
- 7) Repeat steps 4 through 6 for all the characters in the label that are to be changed.
- 8) Select 'BACK' to save the label. The front-panel display flashes to indicate that the changes are being saved and applied.

To edit another port label, scroll clockwise to the BACK command and select it. The AVAILABLE AUDIO PORTS menu appears. Select a new audio port to edit, and repeat steps 2 through 9.

6.6 Setting and changing group labels

A group label is used when an FS II beltpack needs to communicate with all members of a group simultaneously, as in a partyline. The user can create up to ten groups. Five of these can be standard groups with up to twelve members per group and five can be wireless partyline groups with up to thirty members per group.

Group members can be individual beltpacks or wired devices connected to the Base station. To form a group, the user must first create a name or "label" for the group, and then assign members to the group.

6.6.1 To create a group label

- 1) From the main menu, select GROUPS. The first page of the AVAILABLE GROUPS menu appears, as shown in The 5 standard group labels appear on the first page of the menu. The generic labels GP#01 through GP#05 appear on the top row, and their editable versions appear on the lower row. The default values are GRP01 through GRP05.

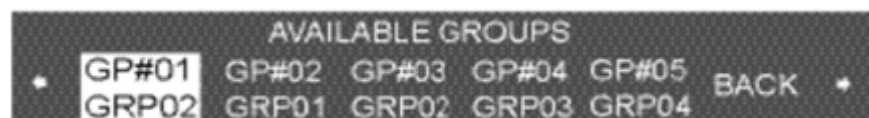

Figure 6-11 Standard group labels

By scrolling all the way to the right, and then continuing to scroll, the wireless partyline groups appear on the second page of the menu.

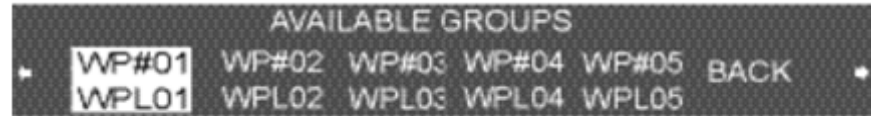

Figure 6-12 Wireless partyline group labels

The generic wireless partyline group labels WP#01 through WP#05 appear on the top row, and their editable versions appear on the lower row. The default values are WPL01 through WPL05.

- 2) From the AVAILABLE GROUPS menu, select a group label. A menu appears that gives the options for programming the selected group, as in Figure 6-13 Select label from the menu.



Figure 6-13 Select label from the menu

- 3) Select LABEL from the menu.

A menu to edit that group label appears, as shown in Figure 6-14 Group name edit menu.

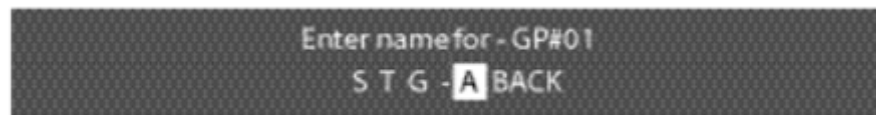

Figure 6-14 Group name edit menu

- 4) Scroll to and select the alphanumeric character to be changed. A box appears around the character.
- 5) Rotate the setup/enter encoder. As the encoder is rotated the entire range of available characters appears, starting with upper-case characters, proceeding to lower-case characters, then to digits, and finally to punctuation characters.
- 6) When the desired new character appears, press the setup/enter encoder to select it. The box disappears, and is replaced by the solid highlight.
- 7) Repeat steps 4 through 6 for all the characters in the label that are to be changed.

- 8) Select 'BACK' to save the label. The front-panel display flashes to indicate that the changes are being saved and applied.

In order to edit another group label scroll clockwise to the BACK command and select it. The AVAILABLE GROUPS menu appears. Select a new group label to edit, and repeat steps 2 through 9.

6.7 Adding group members

When a group name or "label" has been chosen the user may then "populate" that group. Group members are drawn from the individual wireless belt packs and individual wired devices connected to the FS II Base station. A group created from these devices functions as a partyline, in which all members of the group can communicate simultaneously with all other members of the group. A standard partyline group may contain up to fifteen members and a wireless partyline group may contain up to twenty eight members.

Note: Headsets cannot be added to a wireless partyline type group by this method.

6.7.1 To assign members to a group

- 1) From the MAIN menu, select GROUPS. The AVAILABLE GROUPS menu appears.
- 2) Select the group to which members are to be added. The PROGRAMMING OPTIONS menu appears, as shown in Figure 6-15 Group programming options menu.



Figure 6-15 Group programming options menu

- 3) Select MEMBERS from the menu.

The MEMBERS menu appears, as shown in Figure 6-16 Adding members to a group. On this set of pages, all of the Base station wired ports appear (HDSTA through PRGRM, "headset A" through "program"), followed by the labels for all twenty FS II belt packs. The menu header displays the number of members currently in the group out of a possible maximum of twelve members e.g. 4/12 for four members.



Figure 6-16 Adding members to a group

- 4) Scroll through the pages of this list to find the desired members for the group. When a desired member is highlighted, press the setup/enter encoder to select that member. A box appears around it.
- 5) To de-select a member that has already been selected, highlight that member and press the setup/enter encoder. Pressing the setup/enter encoder effectively works as a toggle switch, first selecting the item by putting a box around it, and then de-selecting it and removing the box.
- 6) When all of the desired beltpack labels and Base station port labels have been selected, scroll clockwise to BACK and select it to exit the selection process. Continue selecting the BACK command until the desired screen is reached.
- 7) The changes are saved and applied automatically five seconds after the last time the setup/enter encoder was pressed or turned. The front-panel display flashes to indicate that the changes are being saved and applied.

To edit a group that already has members, go through the procedure above to reach the member labels. Scroll through the list, using presses of the rotary encoder to select and de-select members. Exit as above, and save the changes in the system memory.

6.8 Beltpacks

The following steps have been completed in setting up the system:

- Created names ("labels") for the FS II beltpacks and for the devices wired to the Base station's rear panel
- Created names ("labels") for communication groups and assigned members to the each group.

6.9 Assigning audio routes to a beltpack

The next step is to assign communication routes to the individual FS II beltpacks.

For this example, communication routes are assigned to the beltpack in position one—BPK01. The procedure is identical for all remaining beltpacks.

- 1) From the MAIN menu, select BELTPACKS.

The AVAILABLE BELTPACKS screen is displayed.

- 2) Select the required beltpack. The BELTPACK menu is displayed. Scroll through the screens to KEYS.



- 3) Select KEYS. The KEY EDITING screen appears,
- 4) A list of the audio routes and groups available for selection is visible. Select the beltpack key to assign communication to (A, B, C or D). See Figure 6.17 below.

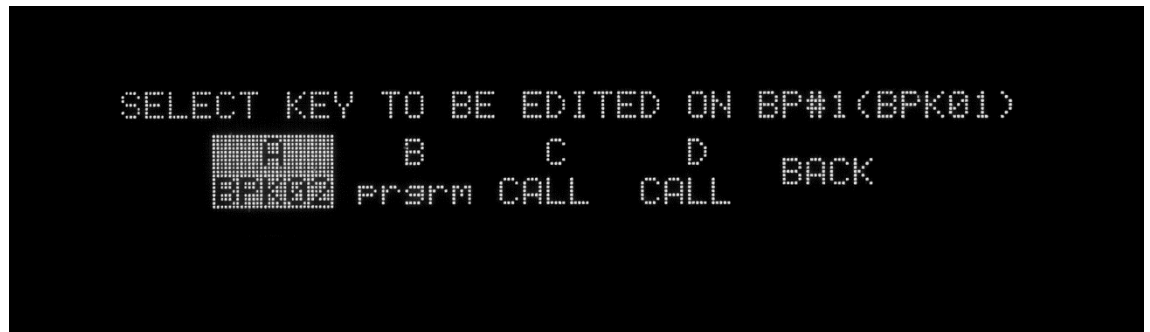

Figure 6-17 Select beltpack key

- 5) A screen appears with a list of available sources and destinations to assign to this key. This list will include:
 - Headset A and B
 - 4 wire ports 1-4
 - Stage announce
 - Program feed
 - Beltpacks 1-20
 - Groups 1-5
 - Wireless partylines 1-5
 - Interruptible foldback (IFB) 1-10



Figure 6-18 Select the source/destination to assign to that beltpack key

- 6) Scroll through the list and select the desired source or destination to assign to that beltpack key. A box appears around the selection and the next screen appears for assigning the key type.
- 7) For some destinations and sources (headsets, stage and program announce, beltpacks and IFB's) the system will assign the feed to the beltpack key when you press the setup/Enter rotary controller. You will be returned to the previous screen and it will flash to show a change has been accepted by the system.

For other audio routes (4 wire ports, groups and wireless partylines) it will be necessary to select a key assignment type. See step 8 below.

- 8) Select either talk (TLK), listen (LIS), talk/listen (T+L), dual talk/listen (DTL), forced listen (FL) or talk/forced listen (TFL) for that key.



Figure 6-19 Key type menu

Note: For more information on audio route key types see 10.4.10 Key Assignment Types.

- 9) The display automatically returns to the screen for selecting the next key to program.
- 10) Select the next key and follow steps 4 through 6. Continue until sources and destinations have been assigned to all desired keys on that beltpack.

Note: Keys C & D default to call keys for A & B respectively if not assigned.

To assign keys for another beltpack continue selecting the BACK command on each successive screen until reaching the AVAILABLE BELTPACKS menu. Highlight and select the next beltpack, and repeat the above procedures.

- 11) The screen will flash after a change has been made to show that it has been accepted by the system.

6.10 Setting the beltpack audio level

- 1) From the MAIN menu, select BELTPACKS.

The AVAILABLE BELTPACKS screen is displayed (Figure 6-2 Available beltpacks menu).

- 2) Select the beltpack for which audio levels are to be set. The BELTPACK menu is displayed.
- 3) Select 'LEVELS'. The beltpack levels editing menu is displayed, as shown in Figure 6-20 Beltpack levels menu.



Figure 6-20 Beltpack levels menu

- 4) Use the setup/enter encoder to select the input level to display the beltpack input level setup.



Figure 6-21 Beltpack Input level setup

- 5) Use the setup/enter encoder to set the beltpack input level in the range -20dB to +6dB by rotating it anticlockwise to reduce the level and clockwise to increase the level. Press the setup/enter encoder to select the input level.
- 6) Use the setup/enter encoder to select the output level to display the beltpack output level setup.



Figure 6-22 Beltpack output level setup

- 7) Use the setup/enter encoder to set the beltpack output level in the range -20dB to +6dB by rotating it anticlockwise to reduce the level and

clockwise to increase the level. Press the setup/enter encoder to select the output level.

6.11 Setting beltpack latching

Beltpack latching determines whether the beltpack A and B latch when pressed so that the user does not have to keep the button pressed to maintain an audio route, or are non-latching so the audio route is only open when the button is pressed.

- 1) From the MAIN menu, select BELTPACKS.

The AVAILABLE BELTPACKS screen is displayed (see Figure 6-2 Available beltpacks menu).

- 2) Select the beltpack for which audio levels are to be set. The BELTPACK menu is displayed.
- 3) Select 'LATCH'. The beltpack latching menu is displayed, as shown in Figure 6-23 Beltpack latching menu.



Figure 6-23 Beltpack latching menu

- 4) Use the setup/enter encoder to select 'NON-LATCHING' or 'LATCHING' on the menu and press the setup/enter encoder to set the latching status.

6.12 Over the Air (OTA) beltpack registration from the Base station

Before beltpacks can be used they must be registered to the Base station. There are a number of ways of doing this, either OTA or via a USB cable using the configuration software.

For more information, see **3.4.1 Over the air (OTA) registration of a beltpack from the Base station** for the procedure.

6.13 Setting input and output port levels

The settings at the Base station determine the input and output audio levels of a device connected to a port. The user can adjust the levels from -20 to +6 dB.

6.13.1 Input level

The input level affects the volume of a signal coming into the Base station, for example from the Program (PRGRM) port. Adjusting this level will affect the volume of this channel to ALL the users of the Base station.

- Setting the “input” level alters how loudly all users of the system will hear a channel; it is a global volume control.

6.13.2 Output level

The output level refers to the signal output to individual ports.

- Setting the “output” level alters how loudly individual ports hear audio sources.

For example, to adjust the program audio to head set A only, adjust the Output level on that port (HDSTA). See instructions below.

6.13.3 To set the audio level for a port

- 1) From the MAIN menu, select PORTS. A menu of the available audio ports is displayed.



Figure 6-24 Available audio ports menu

- 2) Select the port for which the audio levels are to be adjusted from the AVAILABLE AUDIO PORTS menu. The SELECTED PORT menu will be displayed.

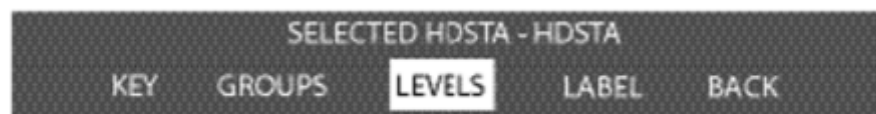

Figure 6-25 Selected port menu for level setting

- 3) Select 'LEVELS' from the next menu.

The EDITING LEVELS menu appears.



Figure 6-26 Port levels menu

- 4) Select 'INPUT' to display the input level setup menu.



Figure 6-27 Port input level setup

- 5) Rotate the setup/enter encoder clockwise or counter clockwise to increase or decrease the input level in 1 dB increments.
- 6) When the desired audio level appears on the screen, press and release the setup/enter encoder to select it,
- 7) The changes are saved and applied automatically five seconds after the last time the setup/enter encoder was pressed or turned. The front-panel display flashes to indicate that the changes are being saved and applied.
- 8) Select 'OUTPUT' to display the output level setup menu.



Figure 6-28 Port output level setup

- 9) Rotate the setup/enter encoder clockwise or counter clockwise to increase or decrease the output level in 1 dB increments.
- 10) When the desired audio level appears on the screen, press and release the setup/enter encoder to select it.
- 11) The changes are saved and applied automatically five seconds after the last time the setup/enter encoder was pressed or turned. The front-panel display flashes to indicate that the changes are being saved and applied.

In some cases, the audio paths must be re-made before the changes will take effect.

6.14 Setting port call destination

Partyline, 4-Wire, Stage Announce and Program ports can also have call destinations configured. In this case any audio on the port will immediately be routed to the specified destination which may be any of the other available ports. If the VOX trigger is set then audio on this port will be routed to the destination when the specified threshold is exceeded.

- 1) From the MAIN menu, select 'PORTS'. A menu of the available audio ports is displayed.

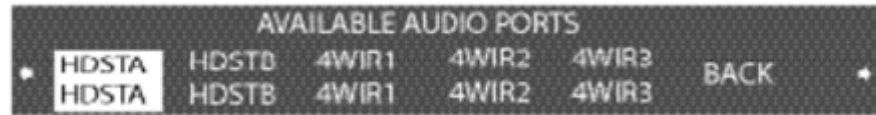

Figure 6-29 Available audio ports menu

- 2) Select the port for which the call destination is to be set (excludes headset ports). The menu for the selected port will be displayed.



Figure 6-30 Selected port menu for calls

- 3) Select 'CALLS' from the menu. The call destination menu will be displayed.



Figure 6-31 Port call menu

- 4) Use the setup/enter encoder to scroll through the available ports and select the required destination port. It is possible to select the source port as the call destination to create an audio loopback system. This may be used for audio testing purposes.



Figure 6-32 Port destination select menu

- 5) When the port is selected, the user is returned to **Selected Port Menu for Calls** (Step 2). The screen will flash momentarily to indicate that the port change has been accepted by the system.
- 6) The port destination can be cleared by repeating the process and selecting the 'NONE' entry.

If one of the headset ports (HDSTA, HDSTB) is selected the port menu is different in that 'KEY' is displayed rather than 'CALL'. This indicates that in order to trigger

an auto route from the headset to the chosen destination the key on the Base station front panel should be used.

- 7) From the MAIN menu, select 'PORTS'. A menu of the available audio ports is displayed.

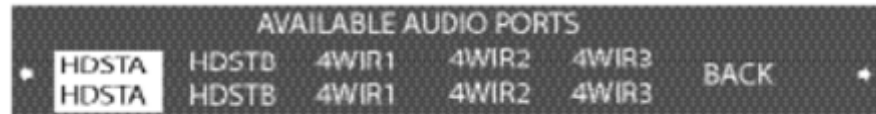

Figure 6-33 Available audio ports menu

- 8) Select the head set for which the call destination is to be set. The menu for the selected headset will be displayed.



Figure 6-34 Selected port menu for calls

- 9) Select 'KEY' from the menu. The audio destination menu will be displayed.



Figure 6-35 Port call menu

- 10) Use the setup/enter encoder to scroll through the available ports and select the required destination port. It is possible to select the source port as the call destination to create an audio loopback system. This may be used for audio testing purposes.
- 11) The port destination can be cleared by repeating the process and selecting the 'NONE' entry.

6.15 Configuring a wired partyline

Before enabling a partyline from the Base station's front panel the type of partyline must be set on the Base station so that it can set the proper termination, gain level, and call signaling for that system.

The three types of partyline systems are: Clear-Com, Drake, and RTS.

6.15.1 To select the type of partyline system for a partyline port

- 1) Select PORTS from the main menu, then select PLCHA or PLCHB from the AVAILABLE AUDIO port menu which appears.



Figure 6-36 Select audio port

- 2) The port configuration menu is displayed. Scroll rightwards to display the second page of the menu.



Figure 6-37 Select type of partyline

- 3) Select TYPE. The first port type menu is displayed.

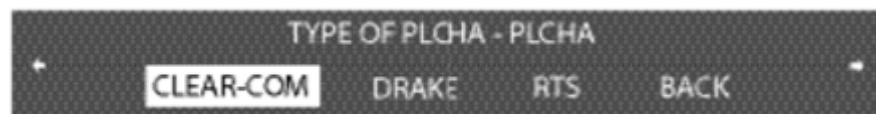

Figure 6-38 First partyline connection type menu

- 4) All the options on the first menu imply that the partyline port will have termination enabled. If this is correct select either Clear-Com, Drake, or RTS. If the partyline port should have termination disabled because the partyline is already terminated by another device scroll rightwards to display the second partyline type menu.



Figure 6-39 Second partyline connection type menu

- 5) Select 'OFF' to disable partyline termination on the port. This will apply regardless of the type of partyline connected to the port. For example if the partyline is connected to an MS-702 master station with termination enabled the Base station termination must be disabled.
- 6) The changes are saved and applied automatically five seconds after the last time the setup/enter encoder was pressed or turned. The front-panel display flashes to indicate that the changes are being saved and applied.

The Base station automatically sets the port's termination, gain, and call signaling options for the selected partyline type.

6.15.2 To configure the Noise Gate for a partyline port

The noise gate sets a cutoff level below which audio input is ignored in order to avoid transmitting low levels of background noise. The noise gate can be set to a value in the range -70dB to -10dB when enabled.

- 1) Select PORTS from the main menu, then select PLCHA or PLCHB from the AVAILABLE AUDIO port menu which appears.
- 2) The port configuration menu is displayed. Scroll rightwards to display the second page of the menu.
- 3) Select GATE. The Noise Gate menu is displayed.



Figure 6-40 Partyline noise gate menu

- 4) Scroll to the 'STATE' option and press the setup/enter encoder to display the noise gate state menu.

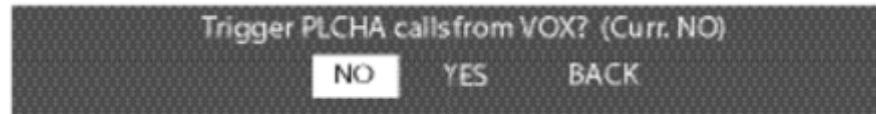

Figure 6-41 Partyline noise gate options menu

Scroll through the options to enable or disable the noise gate and use the enter function to select the required state. The main noise gate menu will be redisplayed.

- 5) Select the level entry to display the partyline level setup menu.

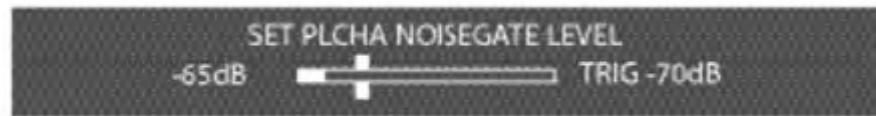

Figure 6-42 Partyline noise gate trigger level

The vertical bar indicates the noise gate trigger level. Turning the setup encoder clockwise increases the noise gate level (towards the maximum -10dB) and turning it counter clockwise reduces the noise gate level (towards -70dB). The horizontal bar indicates the current input audio level in real-time to assist in setting the noise gate level.

- 6) Select the 'DELAY' option on the noise gate menu to set the VOX off delay level. This allows the operator to set a delay in milliseconds before audio is cut by the noise gate.



Figure 6-43 VOX delay setup

The VOX delay can be set to values between 50ms and 5000ms in 50ms steps. Turn the Setup encoder clockwise to increase the delay and anticlockwise to reduce the delay.

6.15.3 To configure the levels for a partyline port

The Levels menu allows Input, Output and nulling levels to be set for a partyline.

Note: Please do not auto-null from this menu option.

- 1) Select the partyline port and then select 'LEVELS' from the partyline menu to display the levels menu.

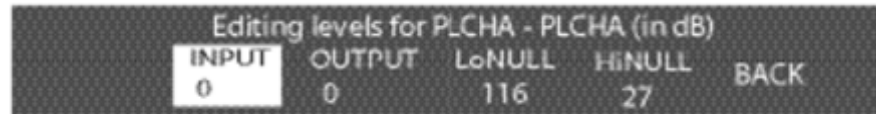

Figure 6-44 Level editing menu for partyline

- 2) Select the 'INPUT' item to display the input level setup menu.

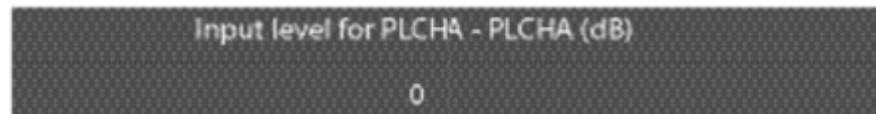

Figure 6-45 Partyline input level

- 3) Rotate the setup/enter encoder clockwise or counter clockwise to increase or decrease the level in 1 dB increments between -20dB and +6dB.
- 4) When the desired audio level appears on the screen, press and release the setup/enter encoder to select it,
- 5) The changes are saved and applied automatically five seconds after the last time the setup/enter encoder was pressed or turned. The front-panel display flashes to indicate that the changes are being saved and applied.
- 6) Select the 'OUTPUT' item to display the output level setup menu.



Figure 6-46 Partyline output level

- 7) Rotate the setup/enter encoder clockwise or counter clockwise to increase or decrease the level in 1 dB increments between -20dB and +6dB.
- 8) When the desired audio level appears on the screen, press and release the setup/enter encoder to select it.
- 9) The changes are saved and applied automatically five seconds after the last time the setup/enter encoder was pressed or turned. The front-panel display flashes to indicate that the changes are being saved and applied.
- 10) Select the LoNULL item to display the output level setup menu.



Figure 6-47 Partyline LoNULL level

- 11) Rotate the setup/enter encoder clockwise or counter clockwise to increase or decrease the nulling level in increments of 1 between 0 and 127.
- 12) When the desired audio level appears on the screen, press and release the setup/enter encoder to select it,
- 13) The changes are saved and applied automatically five seconds after the last time the setup/enter encoder was pressed or turned. The front-panel display flashes to indicate that the changes are being saved and applied.
- 14) Select the HiNULL item to display the output level setup menu.



Figure 6-48 Partyline HiNULL level

- 15) Rotate the setup/enter encoder clockwise or counter clockwise to increase or decrease the nulling level in increments of 1 between 0 and 127.
- 16) When the desired audio level appears on the screen, press and release the setup/enter encoder to select it.
- 17) The changes are saved and applied automatically five seconds after the last time the setup/enter encoder was pressed or turned. The front-panel display flashes to indicate that the changes are being saved and applied.

6.16 Base station System Menu

The Base station System menu offers several system-wide capabilities, including giving information on firmware, system ID, IP address, and active antenna status, in addition to locking the front-panel enable buttons, remote microphone kill, and restoring the most recent downloaded configuration.

The left and right arrows at the edges of the display allow scrolling backwards and forwards between screens on the system menu.

From the MAIN menu, select SYSTEM. The SYSTEM menu appears as shown in Figure 6-49 System menu 1.



Figure 6-49 System menu 1

Rotate the setup/enter encoder clockwise to scroll through the list and display further options.



Figure 6-50 System menu 2



Figure 6-51 System menu 3

The following sections describe the items on this menu.

6.17 System Info

When Info is selected the screen displays the system's current firmware version, system ID (for registering beltpacks), and if applicable, IP address.

```
BUILD: TUN15 2014 19:04:36 V1.15.46.0 FPGA:2.348.0
SYSTEMID: 12789224 (SYSTEM1) IP ADDRESS: 10.50.18.224
RAM:0MB UP TIME: DAYS(0) HRS(0) MINS(27)
COPYRIGHT 2004-2014 CLEAR-COM, AN HME COMPANY
```

Figure 6-52 System info menu

To return to the SYSTEM menu, press the setup/enter button.

6.18 Restoring the Defaults

When F.DEFAULT is selected the factory default map is loaded into memory, the IP address is set to 172.30.3.100 and the IP mask is set to 255.255.0.0

Note: The F.DEFAULT feature will only work on Base stations that have been upgraded by Clear-Com or a qualified Clear-Com representative.



Figure 6-53 Restore defaults menu

6.19 Antennas

When Antennas is selected the display shows the status of the active antennas that are connected to the Base station, and shows the slots on each antenna that are occupied by beltacks. This information may be useful during a site survey, or when troubleshooting coverage areas or antenna connections.

A typical display is shown below:



Figure 6-54 Antennas menu

The numbers 1 through 10 represent the maximum number of antennas that can be connected to the Base station. Numbers 1 through 5 can be positions on a splitter connected to transceiver port 1, while 6 through 10 can be positions on a splitter connected to transceiver port 2. An antenna connected directly to transceiver port 2 would appear at position 6.

"__" indicates an empty slot on an active antenna that is connected to the Base station. A number in place of a "__" indicates that this slot is occupied by the indicated beltack.

Blank spaces next to an antenna number indicate that no antenna has been detected in this position.

So, for example, the above display would indicate that five antennas are connected to the Base station in positions 1, 2, 3, 6, and 7. There are no active antennas in positions 4, 5, 8, 9, and 10.

There are 4 beltacks currently connected. Beltacks 2 and 4 occupy the first 2 slots of antenna 3; beltack 1 occupies the first slot of antenna 6; and beltack 3 occupies the first slot of antenna 7.

The display updates every 4 seconds to reflect changes in antenna status and beltack connections.

Rotate or push in the setup/enter encoder to exit this menu.

When you upgrade the Antenna software using the Configuration Editor, a screen appears showing the status of the upgrade for each connected antenna.

6.20 Setting the IP address

When IP is selected a screen appears allowing the IP address of the Base station to be set.



Figure 6-55 IP address menu

The IP address may be changed by use of the Enter/Setup rotary encoder. The current part of the IP address that will be changed is highlighted and slowly rotating the encoder increases the IP address in increments of 1 per step whilst rapidly rotating the encoder increases the IP address in increments of 10 per step. When the required value is set press the encoder to confirm it and then rotate the encoder one step to select the next part of the IP address and repeat the procedure.

When the required IP address has been set select 'BACK' to save the IP address and exit the menu.

Note: You cannot set the subnet or gateway information in this screen.

To exit without saving any changes to the IP address allow the menu to timeout (about 30 seconds).

6.21 Locking front-panel enable buttons

From the main menu go to SYSTEM -> LOCK.

When LOCK is selected a menu appears that allows the user to lock the front-panel enable buttons for partyline channel A, partyline channel B, and the wired program source.

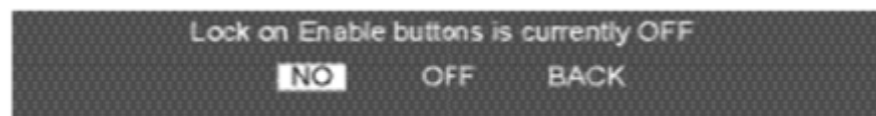

Figure 6-56 Lock enable menu

Selecting ON for the lock maintains whatever state the buttons are in when they are locked. That state is maintained even when the Base station is turned off and re-started. The buttons can be locked either in the enabled or disabled position, in any desired combination.

Selecting OFF allows the buttons to be toggled on and off with a single push.

6.22 Remote microphone kill

When RMK is selected the remote microphone kill menu will be displayed.



Figure 6-57 Remote MIC kill menu

6.22.1 Kill beltpack microphones

Selecting this function will kill the microphones on all the wireless beltpacks connected to the Base station. Beltpack users will have to press a talk key again to re-enable the beltpack microphone.

6.22.2 Kill partyline microphones

Selecting this function will kill the microphones on all the partyline stations connected to the Base station. As this operates by interrupting the power to the partyline stations it does not kill microphones on partyline stations that are externally powered, that is not powered from the FS II Base station.

6.22.3 Kill all microphones

Selecting this function will kill the microphones on all beltpacks and partyline stations attached to the FS II Base station other than partyline stations that are externally powered.

Beltpack and partyline users must press a talk button in order to re-enable microphones afterwards.

6.23 Battery indicator

Selecting the "BATT" function will display the battery life monitor screen.



Figure 6-58 Battery level menu

The line below the title line is battery monitor that shows the battery levels of all beltpacks that are connected to the Base station. When the battery level of a beltpack drops to the alarm level and the battery low alarm is triggered the display for that beltpack will be displayed highlighted.

7 Operating the wireless beltpack

This chapter explains how to operate the FS II beltpack. It contains the following sections:

- *Overview of the wireless beltpack*
- *Beltpack user controls*
- *Using the beltpack*

7.1 Overview of the wireless beltpack



Figure 7-1 FreeSpeak II beltpack

An FS II wireless beltpack gives you simultaneous access to up to five channels of talk/listen communication, with the ability to switch among them as desired. Any or all of these routes may be kept open during use. You can adjust Incoming volume levels (“listen levels”) using the two rotary level controls, so that one conversation can be monitored in the background while a primary conversation is held.

Note: The FS-II beltpack has an IP rating of 65.

The panel display contains the role (label) of the beltpack user, identifies up to four talk/listen labels currently selected, and gives other information such as signal strength and battery level. You can choose between two display modes:

- Intercom display mode – displays key labels, role name, signal strengths, battery level and volume levels.

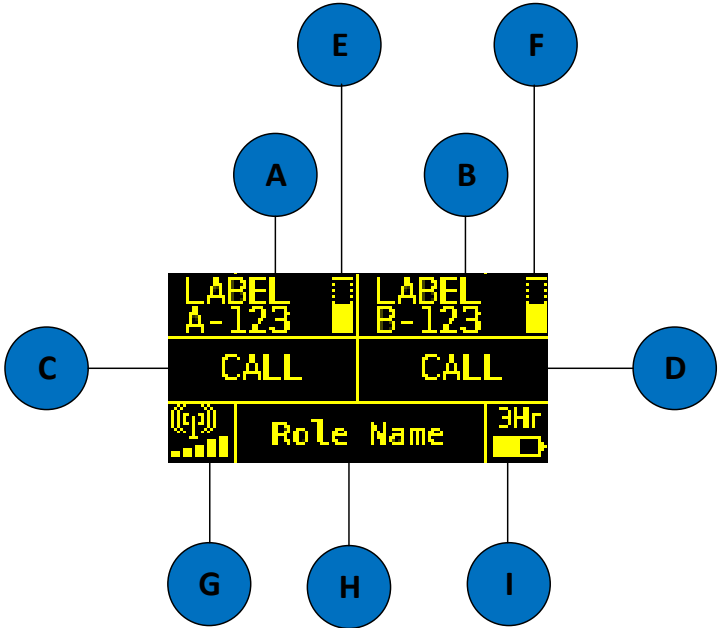

Figure 7-2 Intercom display mode

- Partyline display mode – displays role name, signal strength, battery level and volume levels for channel A and channel B.

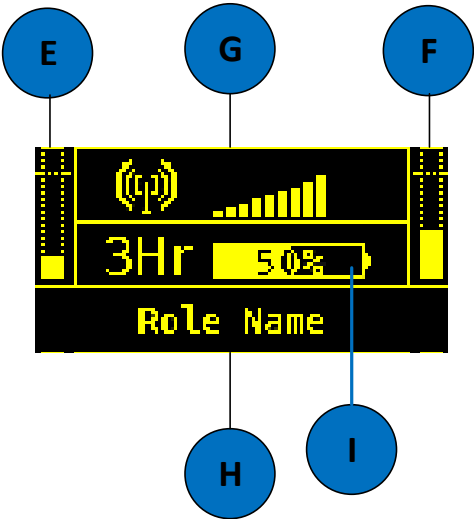

Figure 7-3 Partyline display mode

Key to display layout	
Feature	Description
A	Label for key A assignment.
B	Label for key B assignment.
C	Label for Key C Assignment or CALL key for Key A if not assigned.
D	Label for Key D Assignment or CALL key for Key B if not assigned.
E	Volume level for Key A assignment.
F	Volume level for Key B assignment.
G	Signal strength.
H	Role name for the role assigned to the Beltpack.
I	Battery life remaining (in hours for Li-Ion, in % for AA battery).

Table 7-1 Key to display layout

A 4-pin male headset connector is provided for connection with a standard Clear-Com headset or similar device. The FS II beltpack will operate for approximately 18 hours using a rechargeable Li-Ion battery. Real operational times depend on usage and quality of batteries used. You can also use AA batteries, but you must not attempt to recharge them.

On the bottom of the beltpack, there is an LED torch with a latching key that provides a quick and convenient source of illumination when working in poorly lit areas.

7.2 Beltpack user controls

7.2.1 Top controls

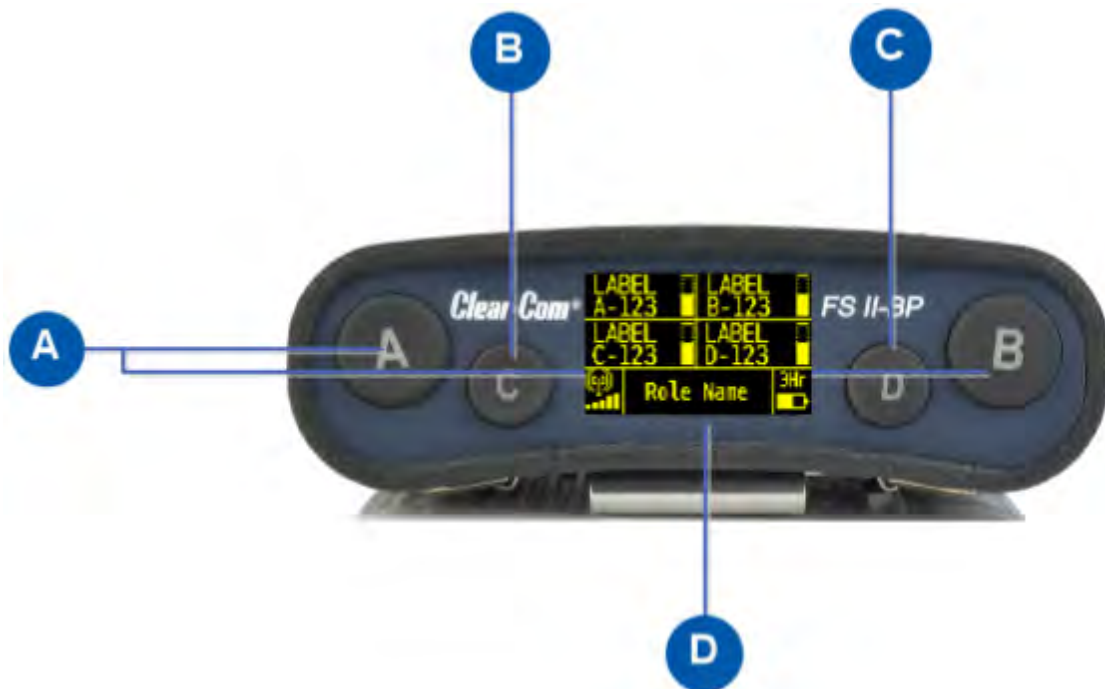

Figure 7-4 View of top of beltpack

Key to beltpack top controls	
Feature	Description
A	Talk key A and B. Press to talk or listen on channel A and channel B.
B	Talk key C. Press to talk or listen on channel C. In menu mode, press to cancel menu.
C	Talk key D. Press to talk or listen on channel D. In menu mode, press to select menu.
D	Display. When the beltpack is not in menu mode, information about each of the four channels supported by the beltpack is displayed on screen. Exactly what is present on the screen depends on the display mode (intercom or partyline).

Table 7-2 Key to beltpack top controls

7.2.2 Beltpack display

The following table lists the beltpack display icons and indicators.





Beltpack display icons and indicators		
Name	Icon	Description
Key label		A descriptive name for the channel. The maximum length is 10 characters (5 characters for the Base station system).
Role name		A descriptive name for the beltpack role.
Channel listen volume level		The volume of the channel audio.
Signal strength		Bars that indicate the strength of the signal from the Main Station.
Battery level		Indicates the battery time remaining.

Table 7-3 Beltpack display icons and indicators

7.2.3 Beltpack headset tones/alerts

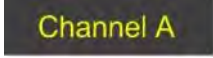
Note: To change call signal, low battery or out-of-range alerts go to **Menu** (press and hold) -> **Settings** -> **Alarm options** on your beltpack. Choose from **Vibrate & audio/Vibrate only/Audio only/Off**.

Beltpack headset tones/alerts	
Event	Tone
Call signal	Mid to high beep, as long as call is active Mid on 200ms, mid off 0ms, high on 200ms, high off 400ms. Repeat if key held.
Low battery	High beep, long then short. High, on 400ms, off 100ms, on 100ms. Repeats intermittently.
Out-of-range	High beep, long then short (as above). Repeats as long as beltpack is out of range.

Menu button	Mid beep. Mid, on 100ms, off 100ms. Triggers on entering menu mode.
Power button	Mid beep. Mid, on 100ms, off 100ms, repeated while power button pressed.
Listen again	Low beep. Low, on 100ms, off 100ms.

Table 7-4 Beltpack headset tones/alerts

7.2.4 Front controls



Figure 7-5 Beltpack front controls

Key to beltpack front controls	
Feature	Description
A	Right rotary level control. Turn clockwise or counter-clockwise to adjust volume. In menu mode, turn clockwise or counter-clockwise to navigate the menus.
B	Power button. Press to power up or power down the beltpack.
C	Reply key. Reply key can be configured as an extra fifth channel using the Configuration Editor or EHX software.
D	Menu key. Press firmly for about two seconds to enter menu mode. To exit menu mode, press the menu key again. If you tap the Menu key, the Listen Again feature is activated. See 8.9 Setting the listen again option.
E	Left rotary level control. Turn clockwise or counter-clockwise to adjust volume. In menu mode, turn clockwise or counter-clockwise to navigate the menus.

Table 7-5 Key to beltpack front controls

7.2.5 Beltpack bottom connectors

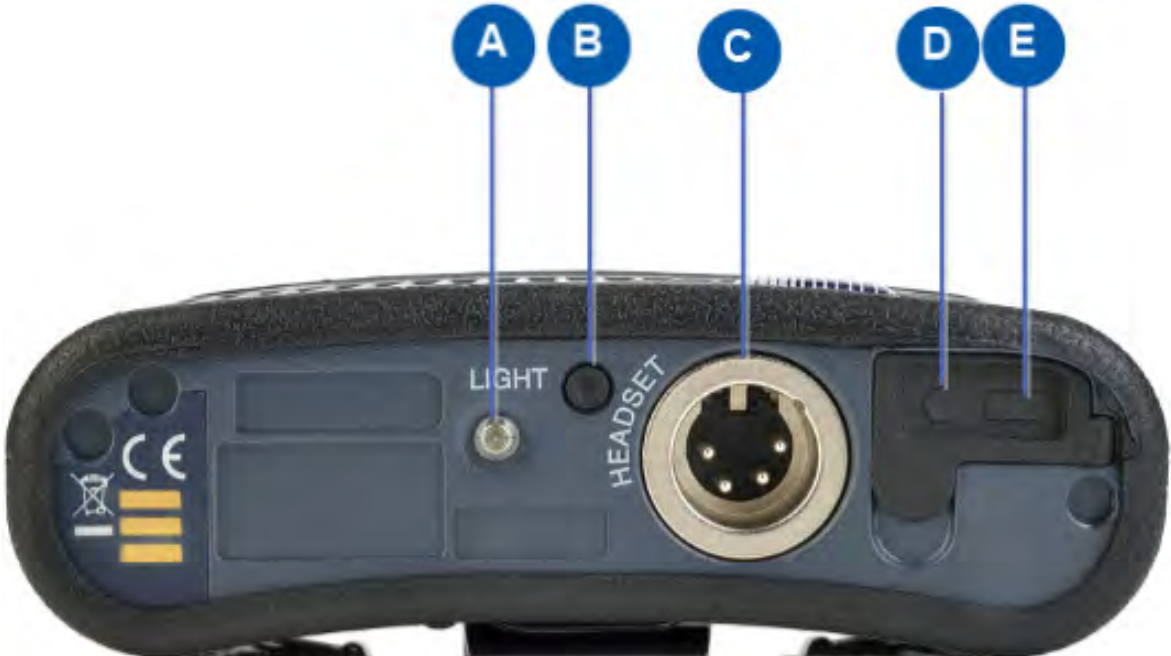

Figure 7-6 Beltpack bottom connectors

Key to beltpack bottom connectors											
Feature	Description										
A	LED torch										
B	LED torch control										
C	Headset socket (4-pin XLR-M) <table border="1" style="margin: 10px auto;"> <thead> <tr> <th>Pin</th> <th>Function</th> </tr> </thead> <tbody> <tr> <td>1</td> <td>Mic ground</td> </tr> <tr> <td>2</td> <td>Mic +</td> </tr> <tr> <td>3</td> <td>Earphone ground</td> </tr> <tr> <td>4</td> <td>Earphone</td> </tr> </tbody> </table> <p style="text-align: center;">Table 7-6: Headset socket pin out</p>	Pin	Function	1	Mic ground	2	Mic +	3	Earphone ground	4	Earphone
Pin	Function										
1	Mic ground										
2	Mic +										
3	Earphone ground										
4	Earphone										
D	3.5 mm stereo jack.										

Key to beltpack bottom connectors	
Feature	Description
E	Micro USB connector.

Table 7-7 Key to beltpack bottom connectors

7.2.6 Beltpack rear panel

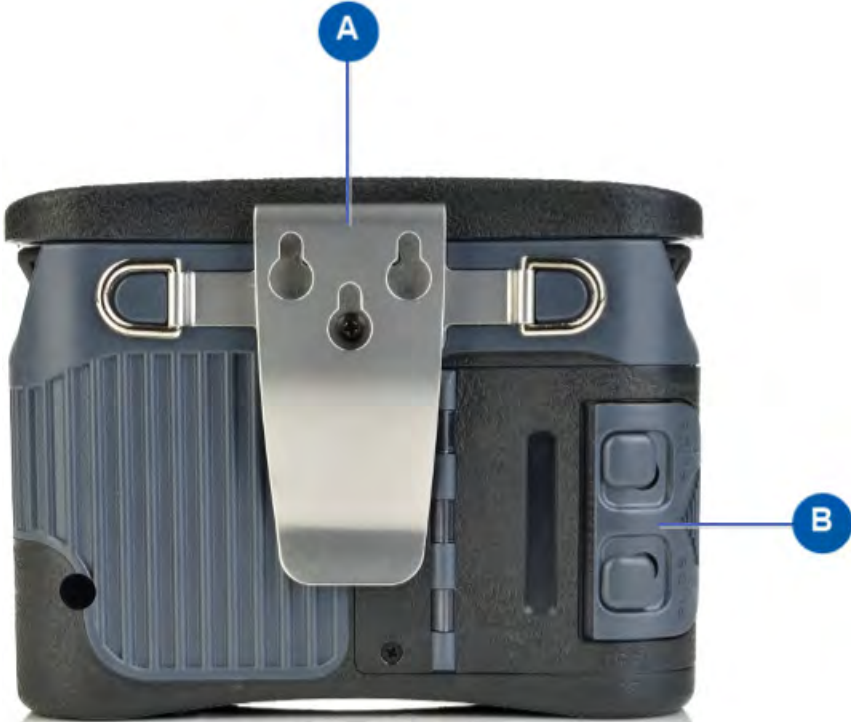

Figure 7-7 Beltpack rear panel

Key to beltpack rear panel	
Feature	Description
A	Beltpack clip
B	Beltpack battery compartment

Table 7-8 Key to beltpack rear panel

7.3 Using the beltpack

7.3.1 Registering the beltpack

Before you can use a beltpack, you must first register it with the FreeSpeak II system. For more information, see **3.4 Registering beltpacks**.

7.3.2 Charging the beltpack

The beltpack batteries are located inside the beltpack battery compartment. The beltpack can use a Clear-Com rechargeable Li-Ion battery or AA batteries. A dedicated battery charger can charge up to five batteries simultaneously.

Note: You can also recharge batteries by using the supplied USB charger. Do not use any other USB charger.

Caution: Only use the battery charger with the supplied rechargeable batteries. If you use the charger with any other batteries, serious damage or injury could result.

To recharge the beltpack battery:

- 1) Insert either the beltpack containing the battery, or the battery itself into one of the recharging bays on the battery charger. A red LED indicates that the battery is recharging.

If you are recharging the battery while it is still in the beltpack battery compartment, an illuminated beltpack key (Talk key A) indicates the charging status. The beltpack charging sequence depends on whether you insert a powered on unpowered beltpack into the charger. The table below shows the charging status conditions.

Talk key A red	Talk key A green	RF component	Beltpack screen
Battery charging	Battery fully recharged	Disabled	Displays current percentage charge and software version

Note: If a beltpack is powered on when placed in the charger, on removal the RF component is re-enabled and the beltpack attempts to reconnect to its previous connection.

Note: If a beltpack is powered off when placed in the charger, on removal it will power off.

- 2) Wait until the recharging LED turns from red to green. The battery is now fully recharged.



Figure 7-8 FreeSpeak II battery charger

7.3.3 Powering on the beltpack

The recessed power button is used to turn the FS II beltpack on and off. Press and hold the button for about three seconds to turn the beltpack on. To turn it off, press and hold the button for about three seconds.

7.3.4 Using the beltpack to communicate

The beltpack has four keys labelled A, B, C, D and Reply. You can program each of these keys to determine their communication destinations, and the type of communication possible. For example, a key could be programmed to call a partyline channel, with both talk and listen enabled. You can program the beltpack keys by using:

- The Eclipse HX software. For more information, see the **Eclipse HX Configuration Software User Guide**.
- The FreeSpeak II Configuration Editor. For more information, see **10 FS II Configuration Editor**.
- The FreeSpeak II Base station.

To **talk** to all the devices connected to the channel:

- 1) Connect a headset, using the 4-pin XLR-M connector on the base / rear of the beltpack.
- 2) Press the appropriate key.

While the key is held down audio transmits on that channel. When the key is released audio no longer transmits. To latch a key on for hands-free use, quickly tap the key. Another quick tap releases the latch.

- 3) Speak into the headset microphone.

To adjust the volume of incoming audio for a channel, turn the appropriate side-mounted **rotary control**. Turn the rotary control clockwise to increase the volume, and counter-clockwise to decrease volume. The current volume level for the channel is shown on screen.

7.3.5 Entering and exiting Menu mode

Use **Menu mode** to:

- Configure the settings for the beltpack.
- Read beltpack information such as software version
- Perform a site survey to maximize signal strength and coverage.

To enter Menu mode, press and hold the **Menu key** for three seconds. To exit Menu mode, press the **Menu** key again.

For more information about using Menu mode on the beltpack, see **8 Programming on the beltpack**.

7.3.6 Setting and Adjusting Listen Levels

You can adjust a beltpack's incoming audio volume in two ways:

- The master volume level for the beltpack can be set by using the beltpack menu options. See **0 Figure 8-1 B beltpack controls**
- Configuring the beltpack volume settings.
- The incoming audio level can be adjusted during talk or listen on the beltpack using the beltpack's rotary level controls.

To adjust the listen level during talk or listen from the beltpack:

- During talk and listen, use the rotary level control to increase or decrease the incoming volume level ("listen level") for that assignment.

Note: You can also configure the incoming audio volume using the Configuration Editor or the EHX software.

7.3.7 Upgrading beltpack firmware

Note: Before attempting an upgrade, ensure that all the antennas are connected.

Note: While the beltpack software is being upgraded, do not attempt to retrieve a Base station configuration file or the upgrade may not successfully complete.

From the Configuration Editor, you can upgrade the beltpack firmware using a USB connection or central upgrade Over The Air (OTA).

Note: If you have a matrix connection, you can also do an Over The Air upgrade. For more information, see the Eclipse HX Configuration Software User Guide.

7.3.7.1 Upgrading using a USB connection.

- 1) Connect the beltpack to a USB port on the computer running the Configuration Editor.
- 2) Select **Diagnostics > Tools > Apply Wireless Firmware Via USB**.
- 3) Browse to the location of the upgrade file (**.FWS**), and then select **Update Firmware**.

The upgrade file is downloaded to the beltpack.

Note: You can connect more than one beltpack to the computer if you have multiple USB ports. The units will be upgraded sequentially.

7.3.7.2 Upgrading by Over The Air Upgrade

- 1) From the Configuration Editor, Select **Send File**, and then browse to the location of the upgrade file (**.FWW**).
- 2) Select **Open**. The download will begin. The beltpacks will be disconnected while the download file is loaded onto the antennas.

The beltpacks will only be upgraded, when the download file has successfully loaded on all the connected antennas.

Note: The Base station front panel will display a download progress screen.

- 3) To cancel the download, press **Enter** on the Base station.

8 Programming on the beltpack

This chapter explains how to program the beltpack using the beltpack's menu system. It contains the following sections:

- *Introduction to programming on the beltpack*
- *Configuring the beltpack volume settings*
- *Configuring the beltpack headset*
- *Configuring the beltpack microphone*
- *Configuring the beltpack display*
- *Configuring the beltpack alarm options*
- *Selecting the beltpack role default set*
- *Selecting the beltpack administration*
- *Setting the listen again option*
- *Accessing beltpack information*
- *Setting display mode*
- *Setting system connect*
- *Enabling over the air (OTA) registration mode from a beltpack*
- *Performing a site survey*

8.1 Introduction to programming on the beltpack

You can access the beltpack menu by pressing and holding the **menu** key. The Master Menu screen is displayed. This consists of the following submenus:

- Volume Level Control
- Volume Operation
- Line In Volume Level
- Settings
- Information
- Display Mode
- System Connect
- Site Survey

Note: The menus that appear depend on the menu access level. See **8.8.2 Setting** full menu access.

To select a submenu turn either of the two rotary dials clockwise. This will scroll down the submenu options. If you turn the rotary dials counter-clockwise, you will scroll upwards.

To select a submenu, press the **Menu Select** key (D).

To return to the previous screen, press the **Menu Cancel** key (C). You can also return to the previous screen by pressing the **Menu** key.

Each menu screen on the beltpack has the following structure:

- Header - this displays the menu title
- Body - this displays a scrollable list of menu items
- Footer - this displays the current value of the current menu selection

To exit the beltpack menus, press and hold the **Menu** key.

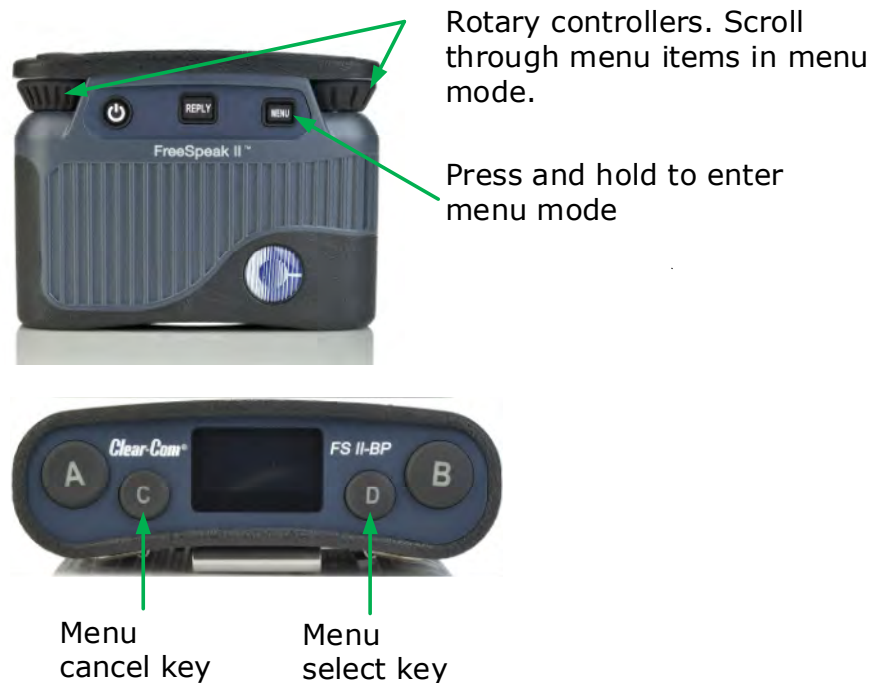

Figure 8-1 Beltpack controls

8.2 Configuring the beltpack volume settings

You can configure the following:

- The volume on each of the four channels
- The beltpack master volume

- The volume of the line-in feed.

8.2.1 Configuring the beltpack channel volumes and master volume

Each of the four beltpack channel volume levels is configurable separately.

Note: You can only change volume levels on keys that have been configured.

To configure a channel volume:

- 1) To enter the beltpack menu, press and hold the **Menu** key.
- 2) Turn either rotary control clockwise to highlight **Vol Level Ctrl**, and press the **Menu Select** key (D). The Volume Level Control screen appears:

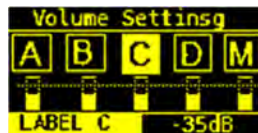

- 3) Use the left-hand rotary control to select the required channel, or select M for the master volume
- 4) Use the right-hand rotary control to adjust the volume level. The default is 0dB for channel audio, and -9.6dB for master volume.

Note: The volume level appears in the footer.
- 5) To confirm the selection, press the **Menu Select** key (D).

8.2.2 Configuring the volume level of the line input

You can configure the volume of an audio line input:

- 1) To enter the beltpack menu, press and hold the **Menu** key.
- 2) Turn either rotary control clockwise to highlight **Line In Vol Lvl**, and press the **Menu Select** key (D).
- 3) Use either rotary control to select between -15 dB to 6dB
- 4) To confirm the selection and exit the menu screen, press the **Menu Select** key (D).

8.2.3 Configuring the rotary controls

You can configure the rotary controls on the beltpack to either:

- Control the volume of the audio on keys A and B
 - Control the master volume of the beltpack audio.
- 1) To enter the beltpack menu, press and hold the **Menu** key.
 - 2) Turn either rotary control clockwise to highlight **Vol Operation**, and press the **Menu Select** key (D).
 - 3) Use either rotary control to select between:
 - Talk Key
 - Master
 - 4) To confirm the selection and exit the menu screen, press the **Menu Select** key.

8.3 Configuring the beltpack headset

You can configure the following headset settings:

- Headset autodetect
- Headset sidetone level
- Headset limiter

The menus that appear depend on the menu access level. See **8.8.2 Setting** full menu access.

8.3.1 Setting headset autodetect

Use this setting to allow the beltpack to automatically detect when you plug in a headset, and route the audio to the headset.

Note: To use this feature, first set **Mic Type** to **Auto**. See **8.4.1 Setting the microphone type**.

- 1) To enter the beltpack menu, press and hold the **Menu** key.
- 2) Use the rotary and **Menu Select** keys to select **Settings > Headset Options > Auto Detect**.
- 3) Use either rotary control to select between:
 - On
 - Off

- 4) To confirm the selection and exit the menu screen, press the **Menu Select** key (D).

8.3.2 Setting the sidetone level

Use this setting to set the level of the sidetone. You can either set the sidetone to a fixed level, or choose to have the sidetone track the master volume level. To set sidetone to a fixed level:

- 1) To enter the beltpack menu, press and hold the **Menu** key.
- 2) Use the rotary and **Menu Select** keys to select **Settings > Headset Options > Sidetone > Sidetone Level**.
- 3) Use either rotary control to select the sidetone level between -70dB and 0dB.
- 4) To confirm the selection and exit the menu screen, press the **Menu Select** key.

8.3.3 Setting the headset limiter

Use this setting to limit the incoming headset audio level to prevent excessive sound levels.

- 1) To enter the beltpack menu, press and hold the **Menu** key.
- 2) Use the rotary and **Menu Select** keys to select **Settings > Headset Options > Limiter**.
- 3) Use either rotary key to select the sidetone level between -32dB and 16dB. The default is 0dB.
- 4) To confirm the selection and exit the menu screen, press the **Menu Select** key (D).

8.4 Configuring the beltpack microphone

You can configure the following microphone settings:

- Microphone type
- Microphone echo cancellation

The menus that appear depend on the menu access level. See **8.8.2 Setting** full menu access.

8.4.1 Setting the microphone type

Use this setting to specify the type of microphone you are using. You can also allow the beltpack to automatically detect what kind of microphone is present.

- 1) To enter the beltpack menu, press and hold the **Menu** key.
- 2) Use the rotary and **Menu Select** keys to select **Settings > Mic Options > Mic Type**.
- 3) Use either rotary control to select between:
 - Automatic (default)
 - Electret
 - Dynamic Unbalanced
- 4) To confirm the selection and exit the menu screen, press the **Menu Select** key (D).

Note: If automatic headset detection is ON:

- Dynamic headset is detected if microphone impedance is between 90 – 320 Ohms
- Electret headset is detected if microphone impedance is between 1.3 – 6.5 kOhms.

8.4.2 Setting the microphone echo cancellation

Use this setting to improve the microphone audio quality.

- 1) To enter the beltpack menu, press and hold the **Menu** key.
- 2) Use the rotary and **Menu Select** keys to select **Settings > Mic Options > Echo Cancellation**.
- 3) Use either rotary control to select between:
 - On
 - Off (default)
- 4) To confirm the selection and exit the menu screen, press the **Menu Select** key.

8.5 Configuring the beltpack display and LEDs

You can configure the following display options:

- Display brightness level
- Display dim timeout
- Display off timeout

8.5.1 Setting the display and LED brightness

Use this setting to control the brightness of the display. The beltpack automatically dims after a timeout period if no key is used or there is no incoming call or call alert. You can adjust the timeout period.

When the beltpack is dimmed, the display goes off after a timeout period if no key is used or there is no incoming call or call alert. You can adjust the timeout period.

- 1) To enter the beltpack menu, press and hold the **Menu** key.
- 2) Use the rotary and **Menu Select** keys to select **Settings > Display Options > Brightness Level**
- 3) Use either rotary control to select the dim level between 1 and 5 (default).
- 4) To confirm the selection and exit the menu screen, press the **Menu Select** key.

8.5.2 Setting the display dim timeout

Use this setting to determine when the beltpack display will dim if no key is used or there is no incoming call or call alert.

- 1) To enter the beltpack menu, press and hold the **Menu** key.
- 2) Use the rotary and **Menu Select** keys to select **Settings > Display Options > Dim Timeout**
- 3) Use either rotary control to select the dim level between Off and 120 seconds (default).
Note: Setting the dim timeout to Off disables the timeout function.
- 4) To confirm the selection and exit the menu screen, press the **Menu Select** key.

8.5.3 Setting the display off timeout

Use this setting to determine when a dimmed beltpack display will switch off.

- 1) To enter the beltpack menu, press and hold the **Menu** key.
- 2) Use the rotary and **Menu Select** keys to select **Settings > Display Options > Off Timeout**
- 3) Use either rotary control to select the dim level between Off and 120 seconds (35 second default).
Note: Setting the display off timeout to Off disables the timeout function.
- 4) To confirm the selection and exit the menu screen, press the **Menu Select** key (D).

8.6 Configuring the beltpack alarm options

You can configure the following alarm options:

- Low battery alarm
- Low battery alarm threshold
- Out of range alarm
- Call alert mode

Note: See 7.2.3 Beltpack headset tones/alerts for a description of tones.

8.6.1 Setting the low battery alarm

Use this setting to determine how the beltpack behaves when battery power is low. You can set the following types of alarm:

- Audio warning
 - Vibrate
 - Audio warning and vibrate
 - Off
- 1) To enter the beltpack menu, press and hold the **Menu** key.
 - 2) Use the rotary and **Menu Select** keys to select **Settings > Alarm Options > Alarm Mode.**
 - 3) Use either rotary control to select between:
 - Vibrate & Audio (default)
 - Vibrate Only
 - Audio Only

- Off
- 4) To confirm the selection and exit the menu screen, press the **Menu Select** key (D).

8.6.2 Setting the low battery alarm threshold

Use this setting to determine the battery power level that triggers the low battery alarm.

- 1) To enter the beltpack menu, press and hold the **Menu** key (D).
- 2) Use the rotary and **Menu Select** keys to select **Settings > Alarm Options > Low Battery Threshold**.
- 3) Use either rotary control to select a value between 0 and 100%.
- 4) To confirm the selection and exit the menu screen, press the **Menu Select** key (D).

8.6.3 Setting the out of range alarm

Use this setting to determine what kind of alarm the beltpack issues when it moves out of range of an antenna. You can set the following alarms:

- Audio on
 - Off
- 1) To enter the beltpack menu, press and hold the **Menu** key.
 - 2) Use the rotary and **Menu Select** keys to select **Settings > Alarm Options > Out of Range Alarm**.
 - 3) Use either rotary control to select between:
 - Audio only
 - Off
 - 4) To confirm the selection and exit the menu screen, press the **Menu Select** key (D).

8.6.4 Setting the call alert

Use this setting to determine what kind of alert the beltpack issues when it receives an incoming call. You can set the following alerts:

- Audio warning

- Vibrate
 - Audio warning and vibrate
 - Off
- 1) To enter the beltpack menu, press and hold the **Menu** key.
 - 2) Use the rotary and **Menu Select** keys to select **Settings > Alarm Options > Call Alert Mode**.
 - 3) Use either rotary control to select between:
 - Vibrate & Audio (default)
 - Vibrate Only
 - Audio Only
 - Off
 - 4) To confirm the selection and exit the menu screen, press the **Menu Select** key (D).

8.7 Selecting the beltpack role default set

Use this setting to set the beltpack configuration to the default settings downloaded from the configuration editor.

- 1) To enter the beltpack menu, press and hold the **Menu** key.
- 2) Use the rotary and **Menu Select** keys to select **Settings > Role Default Set**.
- 3) Use either rotary control to select between:
 - On (default)
 - Off
- 4) To confirm the selection and exit the menu screen, press the **Menu Select** key (D).

8.8 Selecting the beltpack administration

You can select the following administration settings:

- System pairing mode
- Full menu access

- System sync mode

8.8.1 Enabling OTA registration mode

Use this setting to enable or disable system pairing mode. Enable this mode if you want to register a beltpack over the air.

- 1) To enter the beltpack menu, press and hold the **Menu** key.
- 2) Use the rotary and **Menu Select** keys to select **Settings > Admin Options**. You will be prompted to enter a four digit code. The default code is 4632.
- 3) Select **Enable Pair Mode**.
- 4) Use either rotary control to select between:
 - Disable
 - Enable
- 5) To confirm the selection and exit the menu screen, press the **Menu Select** key (D).

8.8.2 Setting full menu access

Use this setting to override the menu access for the beltpack role. The following menu access levels apply:

- None
- Basic
- Normal
- Advanced

If this setting is not enabled, the menu access is set in the EHX software to one of the above four levels. When it is enabled, the beltpack has full menu access.

Note: If you change this setting, it will apply until the beltpack role changes, or the beltpack is power cycled.

- 1) To enter the beltpack menu, press and hold the **Menu** key.
- 2) Use the rotary and **Menu Select** keys to select **Settings > Admin Options**. You will be prompted to enter a four digit code. The default code is 4632.
- 3) Select **Full Menu Access**.

- 4) Use either rotary control to select between:
 - Disable (default)
 - Enable

8.8.3 Setting system sync mode

Use this setting to make antenna synchronization readings.

- 1) To enter the beltpack menu, press and hold the **Menu** key.
- 2) Use the rotary and **Menu Select** keys to select **Settings > Admin Options**. You will be prompted to enter a four digit code. The default code is 4632.
- 3) Select **System Sync**.
- 4) Use either rotary control to select the antenna group to synchronize.

8.9 Setting the listen again option

Use this setting to configure an option to allow you to play back an incoming message. When Listen Again is active, if you tap the Menu key on the beltpack, the last received message is played back. You can select the length of the recorded message, and also how long the message is stored on the beltpack before automatic deletion. To play back a recorded message, press the **Menu** button.

To select the length of the recording:

- 1) To enter the beltpack menu, press and hold the **Menu** key.
- 2) Use the rotary and **Menu Select** keys to select **Settings > Listen Again Opt > Recording Time**.
- 3) Use either rotary control to select a value between Off and 15 seconds.

To determine how long the message is stored:

- 1) To enter the beltpack menu, press and hold the **Menu** key.
- 2) Use the rotary and **Menu Select** keys to select **Settings > Listen Again Opt > Auto Delete Time**.
- 3) Use either rotary control to select a value between Off and 240 minutes.

8.10 Accessing beltpack information

You can access a list of beltpack information, including battery and fault-finding information.

- 1) To enter the beltpack menu, press and hold the **Menu** key.
- 2) Use the rotary and **Menu Select** keys to select **Information**.

You can read the following information:

Item	Value
Beltpack role	Role name
SW (software)	Version number
Beltpack. ID (beltpack identity)	ID number
RFP (Remote Fixed Part – antenna/receiver)	ID number
Regional (radio frequency area)	Radio frequency region.
Battery Level	Percentage charge, hours of use

Table 8-1 Beltpack information

8.11 Setting display mode

You can select between two display modes: Intercom mode and Partyline mode.

Note: You can only access this option if you have advanced menu access.

- 1) To enter the beltpack menu, press and hold the **Menu** key.
- 2) Use the rotary and **Menu Select** keys to select **Display Mode**.
- 3) Use either rotary control to select between:
 - Intercom mode
 - Partyline mode

8.12 Setting system connect

Use this option to connect to an antenna.

- 1) To enter the beltpack menu, press and hold the **Menu** key.
- 2) Use the rotary and **Menu Select** keys to select **System Connect**.

A list of available systems appears on the beltpack screen.

- 3) Use the rotary control to select a system.

8.13 Enabling over the air (OTA) registration mode from a beltpack

In some circumstances you may need to enable registration of beltpacks without having access to a Base station or computer. In this case it can be done from a beltpack.

The beltpack needs to be previously registered and connected. You need the system admin code, available from Eclipse EHX, the Configuration Editor or the Base station. (The default code is 4632).

Note: The admin code is available on the **System** tab in the FS II Configuration Editor. On the Base station go to MENU->SYSTEM->REG->PIN to find this code.

- 1) From the registered, connected beltpack press and hold the MENU button for 2 seconds to enter the menu options.
- 2) Go to SETTINGS -> ADMIN OPTIONS
- 3) Enter the admin code using the left and right hand rotary controllers on the beltpack.
- 4) If the admin code is successful, the beltpack will display the 'Enable Pair Mode' screen.
- 5) Press the D key on the beltpack to select this option.
- 6) A confirmation screen will appear. Select Y to confirm.
The system will now be open for registration for 2 minutes.
- 7) From the beltpack to be registered, follow the registration procedure. See **3.4.1 Over the air (OTA) registration of a beltpack from the Base station**, step 2.

8.14 Performing a site survey

Note: You can only access this option if you have advanced menu access.

You can survey an intercom installation to determine how many FreeSpeak II antennas are present. You can do this in two ways:

- Connecting to a system and detecting all FreeSpeak II antennas connected to that system

- Performing a survey with no system connection. All FreeSpeak II antennas are detected regardless of which system they are connected to.
- 1) To enter the beltpack menu, press and hold the **Menu** key.
 - 2) Use the rotary and **Menu Select** keys to select **Site Survey**.

9 Operating the transceiver/antenna

This chapter describes how to use the FreeSpeak II transceiver/antenna. It contains the following sections:

- *Transceiver/antenna*
- *Transceiver/antenna splitter (PD2203)*

9.1 Transceiver/antenna

The FS II transceiver/antennas form the transmission link between the FS II beltpacks and the FS II Base station. It has internal omnidirectional (all directions/circular coverage) antennas. Multiple units are used to support the beltpacks and to create larger, customized coverage areas. Each transceiver/antenna is connected to the Base station, either directly or via a PD2203 splitter.

The unit has two methods of fixing:

- Three screw points for mounting on a flat surface.
- Two microphone stand connectors, 3/8 in and 5/8 in.

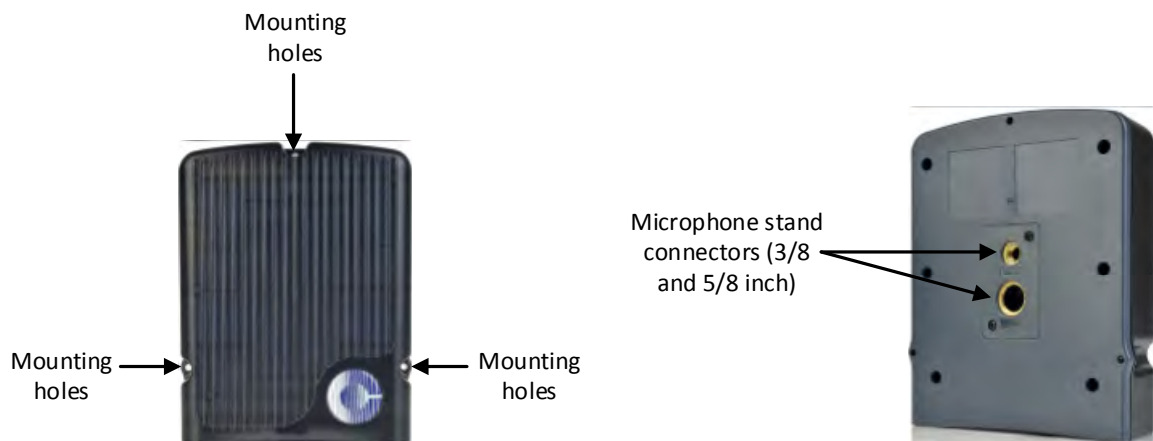

Figure 9-1 FS II Transceiver/Antenna

9.1.1 IP rating (International Protection Marking)

The transceiver/antenna has an IP rating of 65 so it can be mounted outside and will be resistant to weather conditions.

9.1.2 FS II transceiver/antenna connector panel



Figure 9-2 FS II Transceiver/Antenna Connector Panel

Key to transceiver/antennas	
Feature	Description
	USB connector. Used to upgrade the firmware in the FS II-TA.
	Base/Matrix connector. This RJ-45/etherCON connector is used to connect the bi-directional signal from the Base station, directly or via the splitter. Up to 1,000 meters (3,200 feet) of 4-pair 24AWG shielded Ethernet cable (CAT5/5e/6) can be used for this connection between Base station and transceiver/antenna. If 26AWG cable is used the maximum distance is 500 meters (1,600 feet).
	DC in power connector. This connector is used to locally power the transceiver/antenna with the supplied universal power supply. Use of local power is required when the transceiver/antenna is located more than 300 meters (925 feet) from the FS II Base station or the splitter, and is recommended even when the transceiver/antenna is closer whenever it is available and convenient.
	Data signal/Power LEDs. This amber LED indicates that a connection has been established between the Base station and the transceiver/antenna, and that it is actively creating a coverage zone within which the beltacks can operate. A flashing amber LED indicates that a data connection has been established with the Base station. A solid amber light shows that

Key to transceiver/antennas	
Feature	Description
	there is a radio frequency synchronization lock between the devices. A solid light is required for normal operation of the system.
	Power LED. This green LED indicates that the transceiver/antenna is receiving power, either from its local power supply or from the connected CAT-5 cable (distances up to 300 meters, or 925 feet, from the Base station or the splitter) being powered via the FS II Base station.
E	Mode button. The mode button is currently not in use.

9.1.3 Cabling the antennas

See 3.2.1 *Wiring the antennas and splitters.*

9.1.4 Beltpack support capacities for transceiver/antennas

Each transceiver/antenna can support five beltpacks within one coverage zone. With the omnidirectional antennas, the coverage pattern is circular, with a maximum range of up to 500 meters.

When designing the system, determine how many beltpack users will be in or passing through a given coverage zone. If it will be five or fewer users, then place one transceiver/antenna in the center of that area. If it is between 6 and 10 users, place two transceiver/antennas next to each other, both with a direct connection to the FS II Base station or splitter. In larger systems – approaching 20 beltpacks – it is wiser to allow one transceiver/antenna for every 3 to 4 users to ensure smooth handoffs between transceiver/antennas. It is good practice to have each beltpack “seeing” two or more antennas, so a minimum of two antennas in any system is to be considered.

If a sixth beltpack user goes into a coverage zone with only one transceiver/antenna, and that user is out of range from another transceiver/antenna, it will lose connection with the system. This is because the transceiver/antenna has a maximum capacity of five beltpacks at a time. If one of the existing users in that coverage area turns off a beltpack or leaves the area, then the sixth beltpack will find an open slot and will be reconnected with the system.

The proprietary technology within FS II permits the beltpack user to go between coverage zones created by different transceiver/antennas connected to the Base station, and for the system to hand over the communication between beltpack and Base station from one transceiver/antenna to the next one. Thus, a larger, customizable communications area may be designed.

For more information on the coverage range of the FS II-TA, see **4.2.3 Determining coverage areas**.

Note: For most working systems, Clear-Com recommends a ratio of 3-4 users per antenna due to system losses.

9.1.5 Coverage areas under various conditions

Just as with any other product communicating via radio waves, the effective distance between the beltpack and the transceiver/antenna (the range) will differ depending on the particular environment in which it is being used. Radio waves can be attenuated by walls, floors, ceilings, trees, shrubbery, the human body (such as an audience), and numerous other objects. They can be reflected and/or stopped by metallic objects such as structural beams, safety doors, lighting equipment and truss, bodies of water, and so on.

Under ideal conditions, the maximum range between an FS II beltpack and a transceiver/antenna is 500 meters. Typical distances are between approximately 50 meters (about 160 feet) and 150 meters (about 485 feet), depending on the particular environment.

As the transceiver/antenna requirements for a particular installation are being determined, keep in mind both the number of beltpack users who will be working in a particular area (based on the five-beltpack capacity of each transceiver/antenna), and the layout and potential RF attenuating and reflecting items in the location. Be conservative in distance estimates to make sure that enough transceiver/antennas are included to provide the necessary coverage for the installation. Remember that additional transceiver/antennas may be added to a Base station, up to a maximum of 10.

9.1.6 Transceiver/antenna setup rules and tips

Keep the following general rules and tips in mind:

- Keep antennas high (typically, though lower placements away from interfering objects can at times be beneficial) and line-of-sight.
- Keep them away from larger metallic objects and surfaces, and from lighting truss.
- Antenna coverage is circular so put the transceiver/antennas in the center of the area in which coverage is required.
- When overlapping the coverage zones of transceiver/antennas to create larger continuous coverage areas, test the in-between areas with a beltpack for potential areas of low RF signal; adjust the positioning of the antennas as needed.
- Because of potential body shielding during movement, it is useful to place two transceiver/antennas in different locations within larger working areas to minimize low-level signals and potential signal dropouts.

- Going between a larger area and a corridor via a door, especially a heavy or shielded one, or where the walls are thick, place a second antenna in the corridor near the doorway to assure continuous coverage.

9.1.7 Upgrading the antenna/transceiver firmware

From the Configuration Editor, you can upgrade the antenna/transceiver firmware using a USB connection or centrally upgrade using the Base station.

Note: Before you upgrade the firmware, ensure that all the antennas are connected.

Note: If you have a matrix connection, you can also centrally upgrade. For more information, see the Eclipse HX Configuration Software User Guide.

9.1.7.1 Upgrading using a USB connection.

- 1) Connect the antenna to a USB port on the computer running the Configuration Editor.
- 2) Select **Diagnostics > Tools > Apply Wireless Firmware Via USB**.
- 3) Browse to the location of the upgrade file (**.FWS**), and then select **Update Firmware**.

The upgrade file is downloaded to the antenna.

Note: You can connect more than one antenna to the computer if you have multiple USB ports. The units will be upgraded sequentially.

9.1.7.2 Centrally upgrading using the Base station

- 1) From the Configuration Editor, Select **Send File**, and then browse to the location of the upgrade file (**.FWS**).
- 2) Select **Open**. The download will begin. Each antenna will upgrade as soon as the upgrade file is loaded.

The beltpacks will be disconnected while the download file is loaded onto the antennas.

Note: The Base station front panel will display a download progress screen.

- 3) To cancel the upgrade, press **Enter** on the Base station.

9.2 Transceiver/antenna splitter (PD2203)

The PD2203 antenna splitter is the device that connects multiple transceiver/antennas to the FS II Base station. It has an RJ-45 connector that

carries the data between a Base station transceiver port and the splitter, and five RJ-45 connectors to feed that information to and from up to five antennas. The splitter must be locally powered via the supplied external in-line universal power supply.

Note: You must power on the splitter before you power on the Base station, otherwise the Base station might power the splitter. In this case there might be insufficient power.

9.2.1 PD2203 Front connector panel

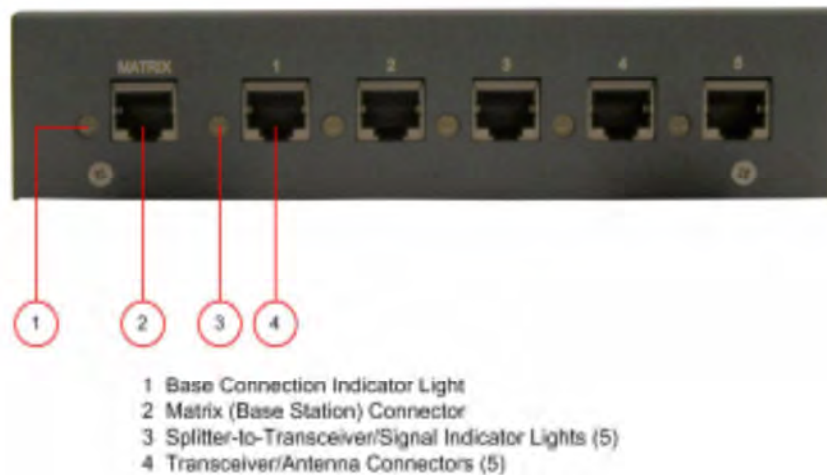

Figure 9-3 FS II Splitter Front Connector Panel

9.2.1.1 Base station connection indicator light

This yellow light indicates that the PD2203 splitter is receiving data from the FS II Base station.

9.2.1.2 Matrix (FS II Base station) connector

This RJ-45 connector accepts a 4-pair data cable from the FS II Base station transceiver port. This cable can be up to 1,000 meters (3,200 feet) in length if 24AWG cable is used or up to 500 meters (1,600 feet) if 26AWG cable is used.

Note: It is recommended that shielded Ethernet cable (for instance, CAT-5/5e/6) is used.

9.2.1.3 Splitter-to-transceiver/antenna signal indicator light

These yellow lights indicate that a connection from the FS II Base station is available to the particular transceiver connected to that port.

9.2.1.4 Transceiver/antenna connectors

These five RJ-45 connectors are used to connect up to five remote transceiver/antennas to the splitter, and via the splitter to the FS II Base station. Each of these cables can be up to 1,000 meters (3,200 feet) in length if 24AWG cable is used or up to 500 meters (1,600 feet) long if 26AWG cable is used.

Note: It is recommended that shielded Ethernet cable (for instance, CAT-5/5e/6) is used.

9.2.2 PD2203 rear panel

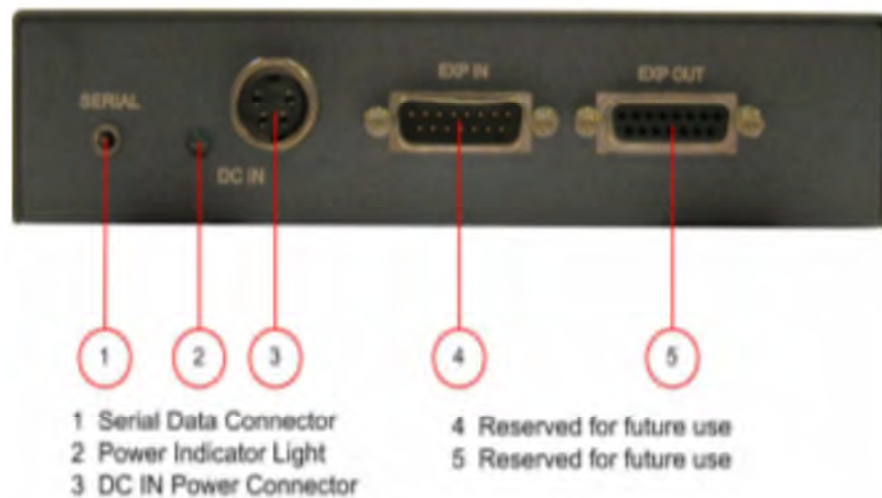

Figure 9-4 FS II Splitter Rear Connector Panel

9.2.2.1 Serial data connector

This 3.5 mm (1/8 inch) tip-ring-sleeve (TRS) connector is used for upgrading the firmware in the PD2203. It will typically be unused.

9.2.2.2 Power Indicator

This green LED indicates that the splitter is receiving power from the external power supply.

9.2.2.3 DC IN power connector

This connector is used to locally power the antenna splitter with the supplied universal power supply. Use of local power is required.

9.2.2.4 EXP IN connector

This male DB-15 connector is reserved for future use.

9.2.2.5 EXP OUT connector

This female DB-15 connector is reserved for future use.

9.2.3 Connecting an antenna splitter to the FS II Base station and to transceiver/antennas

After the connections have been made between the splitter and the transceiver/antennas, make sure that the data LED's are lit at the individual ports on the antenna splitter. Also make sure that the both the green power LED and the yellow data LED are lit on each FS II-TA. If all are properly lit, then the connection has been successfully made and the coverage zones will be active and will support belt packs. If the transceiver antennas are not lit, check the connections.

10 FS II Configuration Editor

This chapter explains how to use the Configuration Editor software to program the FreeSpeak II system. Configuration Editor is a convenient and flexible tool that allows you to quickly and easily create or edit configurations.

You can use the FS II Configuration Editor to extract, backup, edit and restore configurations from the FS II Base stations. Configurations are initially extracted from an FS II Base station via Ethernet or the serial cable, and once extracted they can be edited and either sent back to the Base station or saved to disk for future use.

It can also be used to clone a Base station in case of systems failure - all beltpack registrations and the system ID are stored within the configuration.

This chapter contains the following sections:

- *Loading configurations*
- *Configuration Editor Screen basics*
- *Registering beltpacks using the over the air (OTA) facility*
- *Configuring beltpacks*
- *Configuring ports*
- *Configuring groups and wireless partylines*
- *Reducing antenna interference*
- *Configuring IFBs*
- *Configuring Base station system parameters*
- *Diagnostics*
- *Upgrading the Configuration Editor*

10.1 Loading configurations

When you start the Configuration Editor the following screen appears:

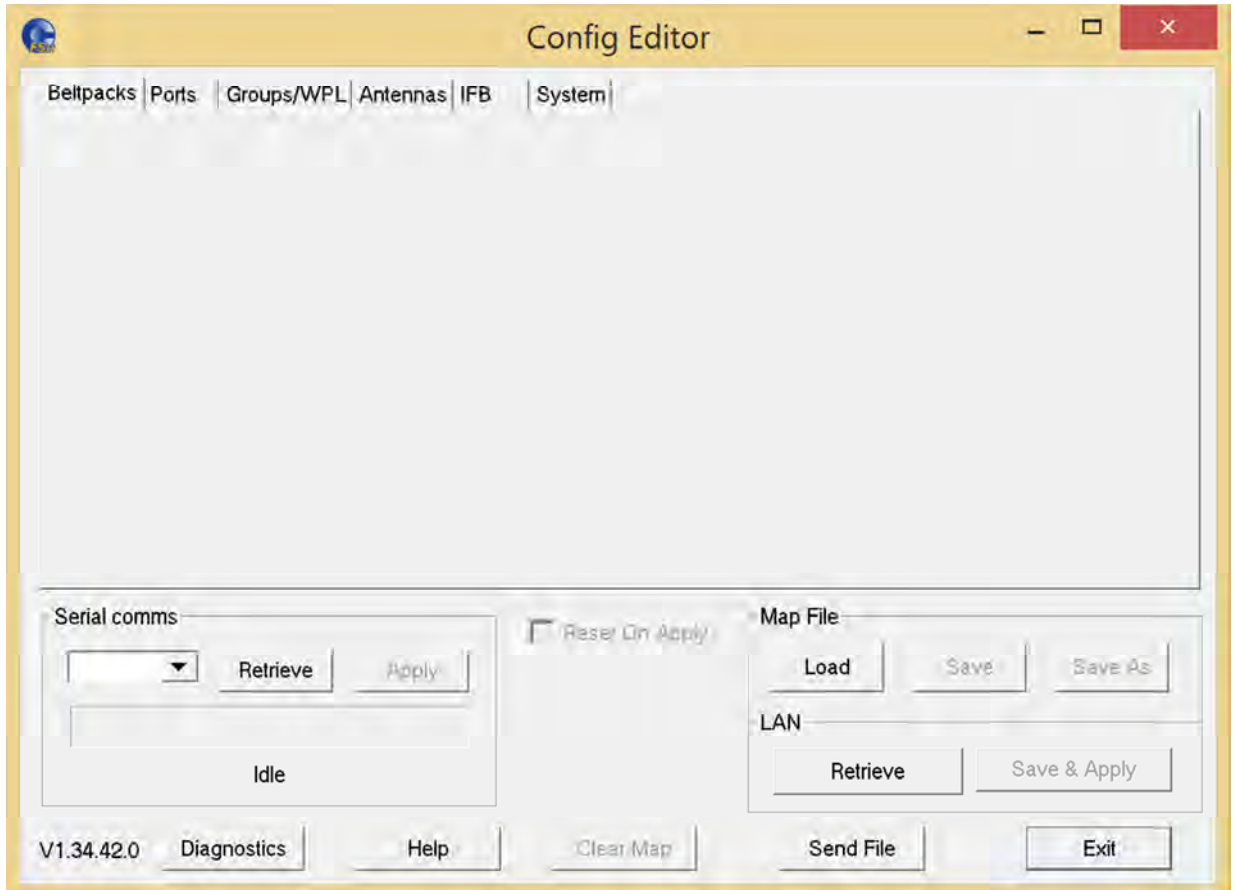

Figure 10-1 Configuration Editor Initial Screen

You can either load a local configuration file from disk, or extract one from a Base station.

10.1.1 Loading a local configuration file

To load a configuration from disk:

- 1) Click **Load**.
- 2) Browse on your local disk for the configuration file.
Note: Configuration files end in a **.bsc** extension.
- 3) Click **Open**. The configuration loads into the Configuration Editor.

10.1.2 Loading a configuration file from a Base station using a serial link

- 1) Connect the PC to the Base station using a standard FreeSpeak II serial cable.
- 2) From the **Serial comms** list, select a COM port. Power on the FS II Base station and wait for at least 30 seconds.
Note: The **Serial comms** list shows only those ports that are available for connection to the Base station. If the required port is not shown, it may be that another program is using this port. Close the other program, and try again.
- 3) In the Serial Comms section of the screen, click **Retrieve**. If the program fails to connect to the Base station, the following dialog appears:

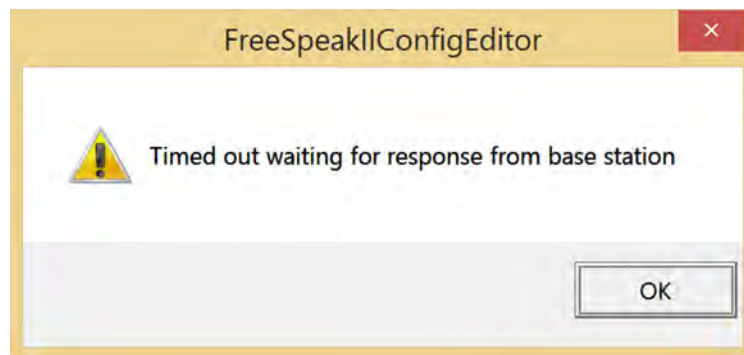

Figure 10-2 Configuration Editor Serial Timeout

If this occurs, check the cable, PC and Base station connection, and also make sure that 30 seconds have elapsed since powering on the Base station to ensure that serial comms have been activated.

The following screen is an example of a loaded configuration (with **beltpacks** selected):

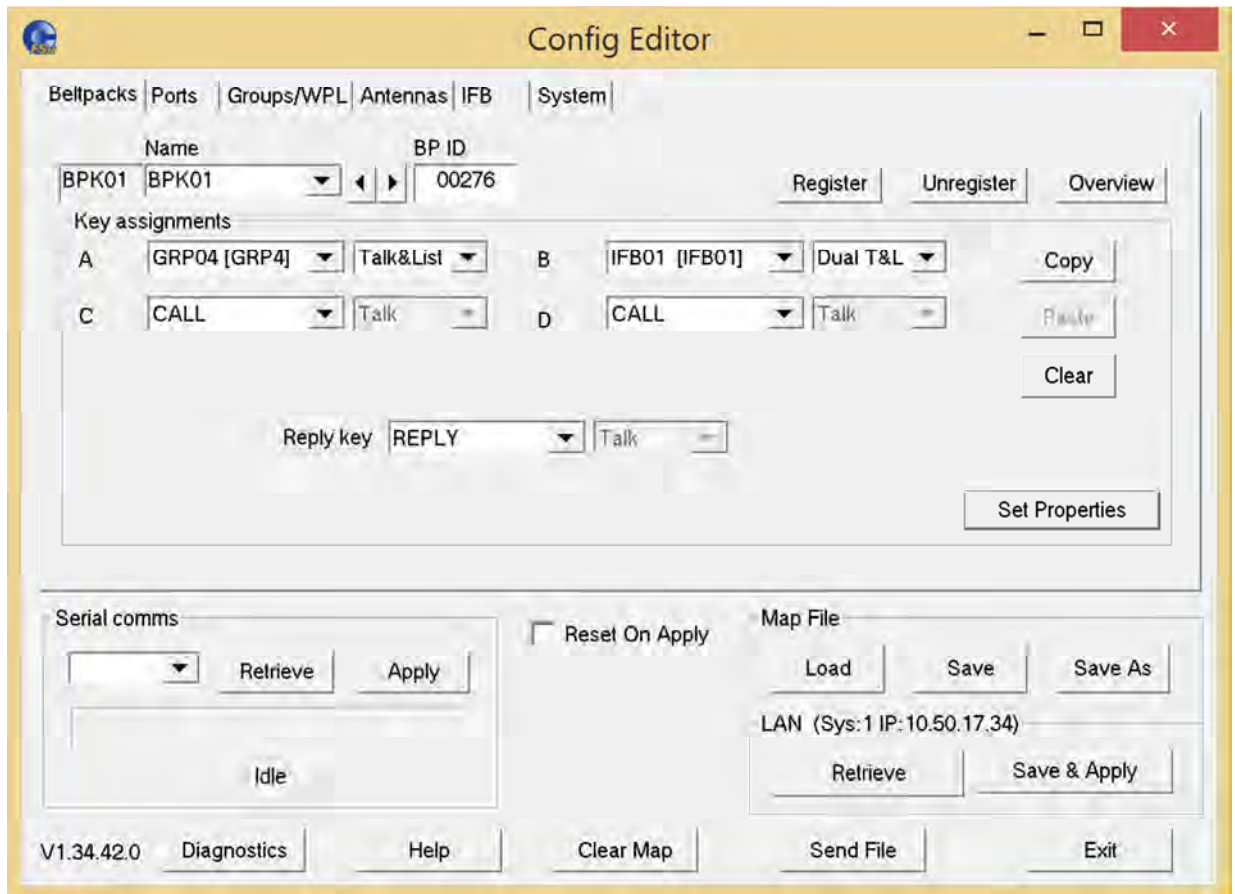

Figure 10-3 Configuration Setup

10.1.3 Loading a configuration from a Base station using Ethernet

- 1) Connect the PC and the Base station to the local network and set up an IP address on the Base station.

Note: You can set the Base station IP address in the Configuration Editor under the **System** tab, and on the Base station using the **System** menu. The procedure for setting the Base station IP address using the configuration editor is described in this chapter and the procedure for setting up the IP address on the Base station is described in **6.20 Setting the IP address**.

Note: Make sure the IP address set on the Base station matches the address in the system tab.

- 2) In the LAN section of the screen, click **Retrieve**. A progress window appears.

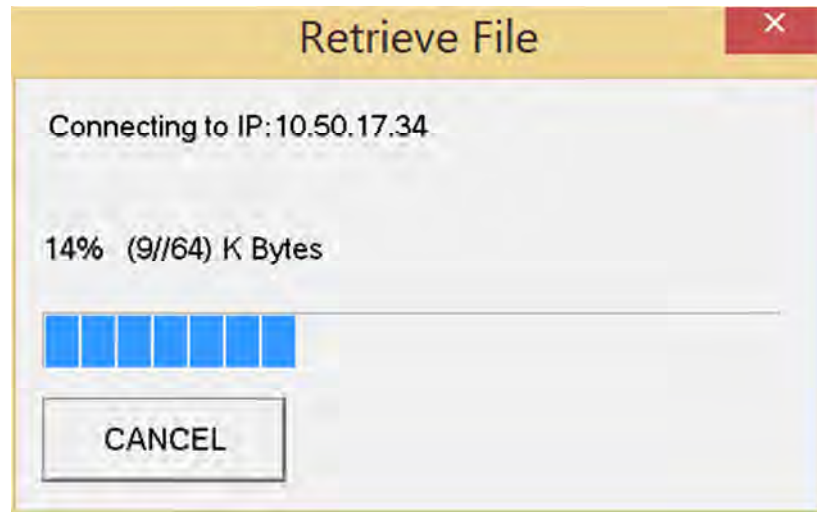

Figure 10-4 Map Upload Progress

Retrieval of the configuration should take about 15 seconds. If the program fails to connect to the FS II Base station, the following dialog appears:

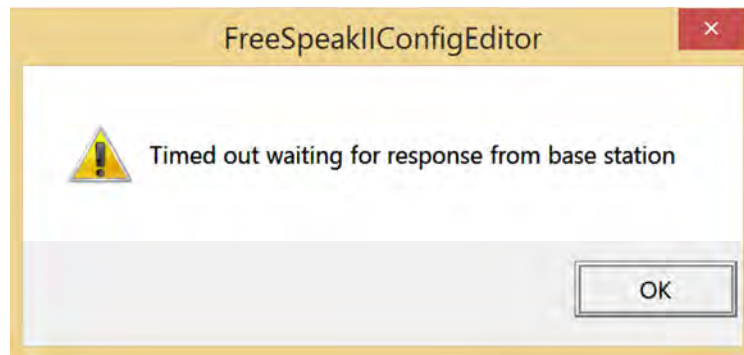

Figure 10-5 Configuration Editor Ethernet Timeout

If this occurs, check the Ethernet connections at the PC and the Base station. Ensure that the IP address is correct and that it is valid for use on the local network.

10.1.4 Loading a configuration file to the Base station from the Configuration Editor

You can load an edited configuration file from the Configuration Editor to the Base station using:

- A serial link
- Ethernet

10.1.4.1 Using the Serial Link

- 1) Re-connect the Base station (if it has been disconnected) and ensure that at least 30 seconds elapse since Base station power-up to allow serial comms to be activated.
- 2) In the Serial comms area of the Configuration Editor screen, click **Apply**.
- 3) If you want to reset the Base station after the file is uploaded, select the **Reset On-Apply** checkbox. The Base station reboots and the levels are reset to the default values. If a reset is not requested, the file is applied but the levels are not reset to the defaults.

10.1.4.2 Using Ethernet

- 1) Ensure that there is an Ethernet link between the computer and the Base station.
- 2) In the LAN area of the screen, click **Save & Apply**.
- 3) If you want to reset the Base station after the file is uploaded, select the **Reset On-Apply** checkbox. The Base station reboots and the levels are reset to the default values. If a reset is not requested, the file is applied but the levels are not reset to the defaults.

10.2 Configuration Editor Screen basics

There are six tabs at the top of the Configuration Editor screen:

- Beltpacks – Allows you to register and unregister beltpacks, set beltpack properties and assign beltpack keys.
- Ports – Allows you to configure ports.
- Groups/WPL – Allows to create and edit groups.
- Antennas – Allows you to set cable lengths for transceiver/antennas
- IFB – Allows you to configure IFBs.
- System – Allows you to configure system parameters such as system IP, pin numbers and access codes.

There are five buttons at the bottom of the Configuration Editor screen:

- Diagnostics – Opens the FS II Diagnostics Tool. Allows you to view the current state of the Base station, including beltpack and transceiver/antenna statuses and the Base station event log.

- Help - Opens the online help for the Configuration Editor
- Clear Map - Clears the current file from the Configuration Editor buffer. All the parameters set in the editor will be reset to the startup defaults.
- Send File - Sends a firmware file (normally a 4kr file) to the Base station. This is normally only used to update the Base station firmware, and to send antenna and beltback software.
- Exit - Exits the Configuration Editor. If a file has been changed or retrieved from the Base station and not saved, you are prompted to save the file before exiting the editor.

10.3 Registering beltbacks using the over the air (OTA) facility

Beltbacks can be registered wirelessly from the Configuration Editor.

- 1) Go to the System tab in the editor. Click **Start Over the Air Registration**.



- 2) If the Base station is unavailable for any reason there will be an error message, otherwise you will see **Over the Air Registration Mode Active**.

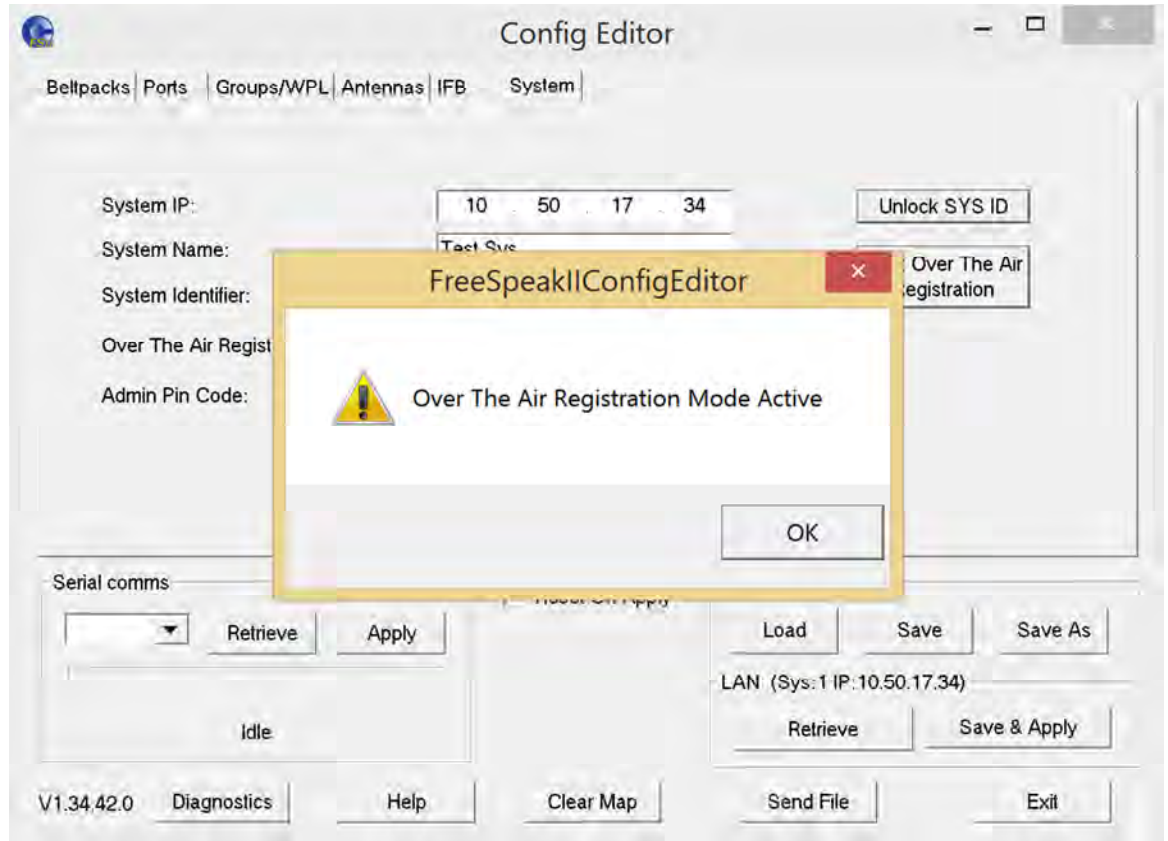

- 3) Now take the beltback you wish to register. On the beltback to be registered, hold the menu key for two seconds to enter MENU options. Scroll to SYSTEM CONNECT using the rotary controllers and select it using key D. In menu mode the D key on the beltback operates as SELECT and the C key exits the menu level and cancels the selection.

Note: On a new system there will be no previous connections at this point. However, if the beltback has been connected previously, a confirmation screen will appear. Select **Yes** to connect to a new system or **No** to remain connected to the current system.

- 4) Available systems will be visible on the beltback menu screen.

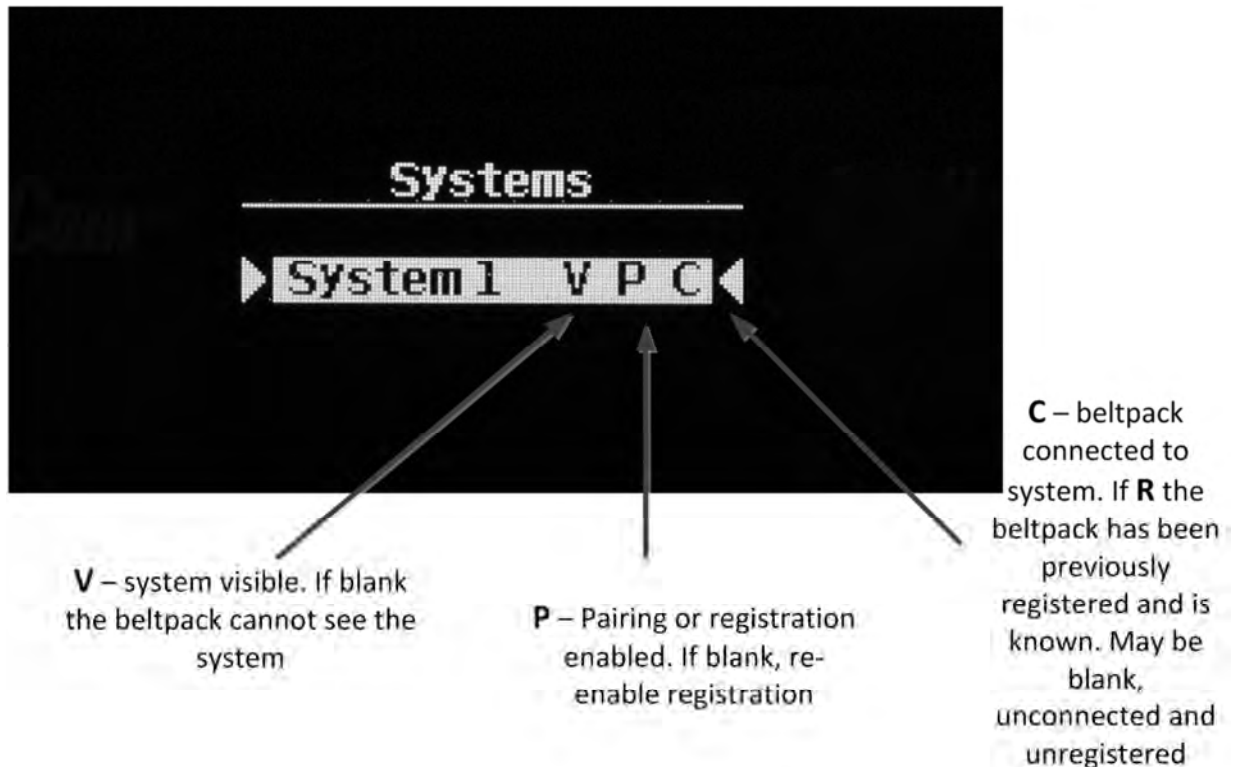

Figure 10-6 Beltback systems

In order to connect the beltback to the system, the system must be visible (V) and in pairing mode (P) on the beltback screen. If the system is not in pairing mode, registration should be re-enabled.

Note: If a beltback is connected to a system 'C' will be visible in this screen. If a beltback is not currently connected but has been in the past 'R' will be visible. This shows that the beltback has been previously registered with the system which will recognize it.

- 5) Enter the four digit pairing code for the system using both rotary controllers and the menu select key (D). The default code is 0000.
- 6) Select an available role from the list displayed on the beltback.
- 7) The beltback is now paired and ready for operation. The role is now associated with the beltback until association is removed using the Configuration Editor or Base station.
- 8) If required, the next beltback can now be registered (step 3). You may need to re-enable registration mode before registering another beltback. Registration mode has a two minute inactive time-out.

10.4 Configuring beltpacks

From the Configuration Editor, you can use the **Beltpacks** tab to:

- Register beltpacks with the Base station
- Edit key assignments
- Change input and output levels.

10.4.1 Selecting the beltpack to register or edit

- 1) From the **Name** list, select a beltpack slot.
The Name list contains all the beltpacks and their serial numbers.
- 2) In the **Name** field, enter an ID for the beltpack. Enter a maximum of five characters.
Note: You can also use the **Next** and **Previous** buttons between the **Name** and **Serial Num** fields to step through the beltpacks.
- 3) In the **Serial Num** field, enter the serial number of the beltpack. The beltpack serial number is a four digit number on a label on the back of the beltpack.



Figure 10-7 Beltpack Label

10.4.2 Registering beltpacks using the micro USB cable

When beltpacks are first registered with a Base station they must be paired with the Base station using the procedure below. You can now edit the beltpacks using the Configuration Editor or the Base station front panel menus.

- 1) First load or retrieve a configuration file. See **10.1 Loading configurations**.
- 2) Connect the beltpack to the PC using the standard beltpack micro USB cable and power it on.

- From the **Name** field, select a beltpack slot. See **10.4.1 Selecting the beltpack to register or edit**.

Note: You can also change the name of the beltpack by over typing the value in the **Name** field.

- Select **Register**. The Configuration Editor now sends the system number and carrier mask information to the beltpack, and also stores the serial number of the beltpack in the Base station configuration.

If the program connects successfully with the beltpack, the **BP ID** field displays its ID number.

Note: You can reassign the beltpacks to different slots on the same Base station using the Configuration Editor.

10.4.3 Viewing beltpack registration information

- To view a summary of the labels and serial numbers of the beltpacks, click **Overview**. The following screen is an example:

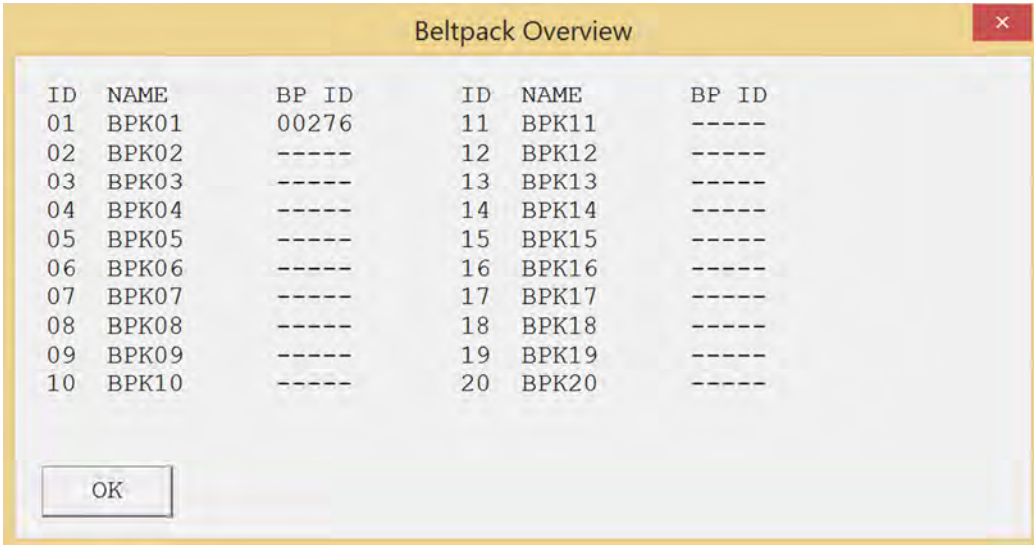

ID	NAME	BP ID	ID	NAME	BP ID
01	BPK01	00276	11	BPK11	-----
02	BPK02	-----	12	BPK12	-----
03	BPK03	-----	13	BPK13	-----
04	BPK04	-----	14	BPK14	-----
05	BPK05	-----	15	BPK15	-----
06	BPK06	-----	16	BPK16	-----
07	BPK07	-----	17	BPK17	-----
08	BPK08	-----	18	BPK18	-----
09	BPK09	-----	19	BPK19	-----
10	BPK10	-----	20	BPK20	-----

Figure 10-8 Beltpack overview

- Click **OK** to close the **Overview** window.

10.4.4 Viewing beltpack properties

The Set Properties button opens the beltpack properties screen. This allows the beltpack defaults to be configured and downloaded to a beltpack as part of the map. Beltpack setting defaults can be stored and restored in the editor and factory default settings recalled. To view the beltpack properties:

- 1) Connect the beltpack to the computer.
- 2) Switch on the beltpack.
- 3) Click **Set Properties**. The **Properties** window appears.

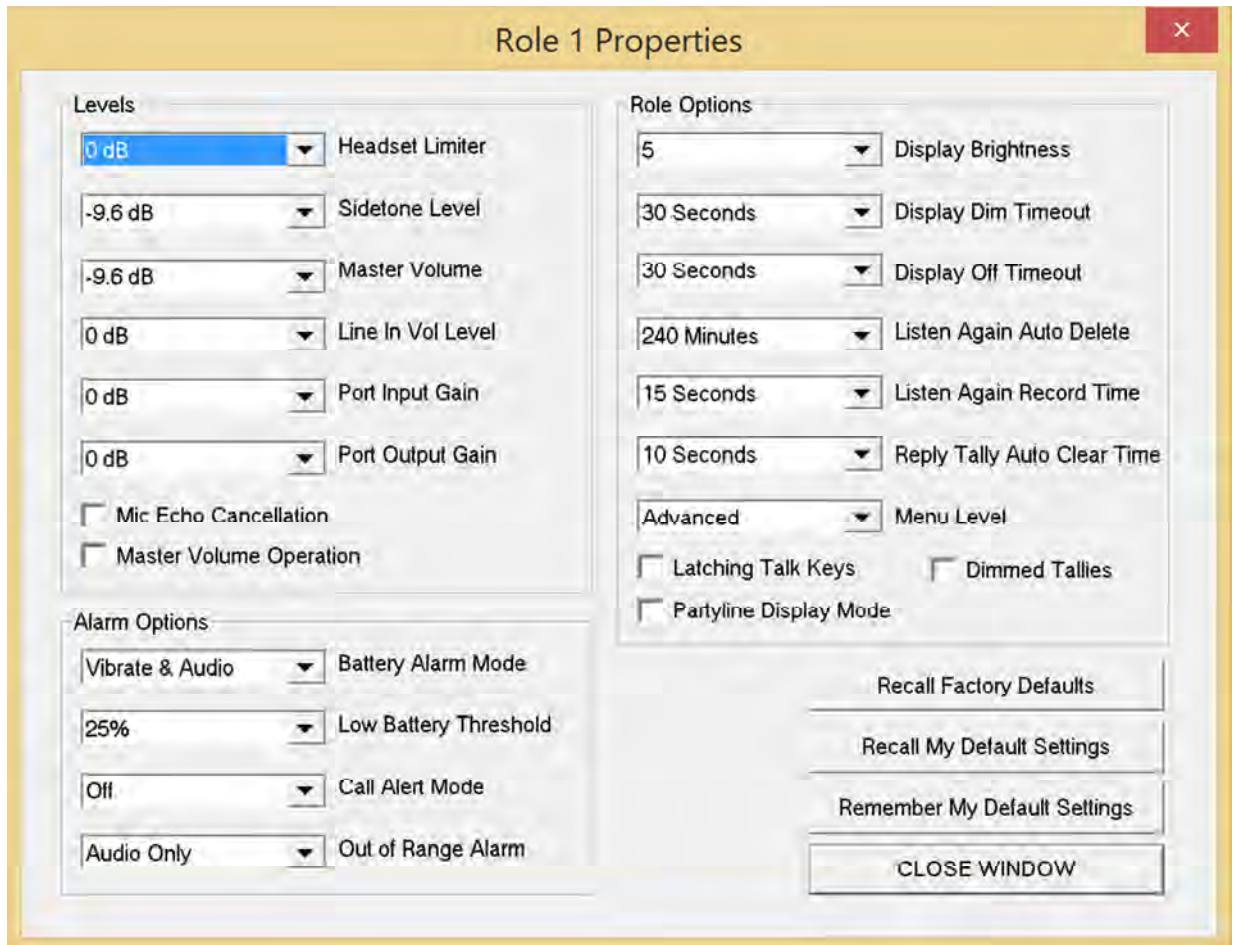

Figure 10-9 Beltpack properties

10.4.4.1 Recalling default settings

Recall defaults resets the properties to a previously stored set of values saved using Remember My Default Settings.

- Click **Recall My Default Settings** to read back and display the default settings stored on your PC.

Note: The settings read back are NOT the same settings entered via the beltpacks menu options.

10.4.4.2 Recalling the factory defaults

- Click **Recall Factory Defaults** to read back and display the factory default settings. You can use this option to reset beltpacks to the factory settings if the saved default settings have been lost or are not suitable.

10.4.4.3 Saving default settings

- Click **Remember My Default Settings** to save the currently displayed default settings (of the Configuration Editor) for later recall. This allows you to ensure that all beltpacks are set up to the same default settings if required.

10.4.4.4 Closing the Properties window

- Click **CLOSE WINDOW** to return to the Configuration Editor main screen.

10.4.5 Beltpack audio levels

The following sections describe how to configure the beltpack audio levels.

Headset Limiter

Use this option to assign a limit to the headset audio.

- From the **Headset Limiter** list, select a headset limiter setting. The settings run from -12dB to +8dB in steps of 1dB. The default is 0dB.

Note: The lowest level may vary depending on model type and software version.

Sidetone Level

Use this option to assign a microphone sidetone level.

- From the **Sidetone Level** list, select a sidetone level setting. The settings run from -70dB to 0dB. The factory default is -9.6dB.

Master Volume

Use this option to assign a master volume level.

- From the **Master Volume** list, select a master volume setting. The settings run from -70dB to 0dB. The factory default is -9.6dB.

Line In Vol Level

Use this option to set the level of the line in (program) feed.

- From the **External Line In Gain** list, select a setting. The settings run from -15dB to 6dB. The factory default is 6dB.

Port input gain

Use this option to set the level of gain on the input from the Base station

Port output gain

Use this option to set the level of gain on the output from the Base station

Microphone Echo Cancellation

Use this option to improve audio quality by reducing microphone echo.

- Select the **Mic Echo Cancellation** check box.

Master Volume Operation

If checked rotaries A and B both adjust the beltback master volume level. If not checked rotary A adjusts the volume for the assignment on Key A and rotary B adjusts the volume for the assignment on Key B.

10.4.6 Beltback alarm options

The following sections describe how to configure the beltback alarm options. The beltback issues alarms when:

- The beltback battery is low
- The beltback is out of antenna reception range
- The beltback receives an incoming call

Setting the battery alarm mode

Use this option to determine what kind of alarm the beltback issues.

From the **Battery Alarm Mode** list, select from the following options:

- Vibrate & Audio - the beltback vibrates and issues an audible alarm
- Vibrate only - the beltback vibrates
- Audio only - the beltback issues an audible alarm
- Off - the beltback issues no alarms

Note: The factory default is Vibrate & Audio

Setting the low battery alarm threshold

Use this option to determine the battery level at which the beltback issues a low battery alarm.

- From the **Low Battery Threshold** list, select a low battery threshold level. The settings run from 0% to 100%. The factory default is 25%.

Setting the call alert mode

Use this option to determine what kind of alarm the beltback issues when it receives an incoming call.

From the **Call Alert Mode** list, select from the following options:

- Vibrate & Audio - the beltpack vibrates and issues an audible alarm
- Vibrate only - the beltpack vibrates
- Audio only - the beltpack issues an audible alarm
- Off - the beltpack issues no alarms

Note: The factory default is Off.

Setting the out of range mode

Use this option to determine what kind of alarm the beltpack issues when it is no longer within range of an antenna.

From the **Out of Range Alarm** list, select from the following options:

- Audio only - the beltpack issues an audible alarm
- Off - the beltpack issues no alarms

10.4.7 Setting the beltpack role options

Use this option to determine the beltpack role options.

Setting the display brightness

Use this option to adjust the display brightness.

- From the **Display Brightness** list, select a display brightness from 1 to 5.

Note: The factory default is 5.

Setting when the screen automatically dims

The beltpack display will dim if no key is used or there is no incoming call or call alert after a certain timeout period. To determine the timeout period:

- From the **Display Dim Timeout** list, select a timeout period. The settings run from Off to 120 seconds. The factory default is 30 seconds.

Setting when the screen automatically turns off

The beltpack display will turn off if no key is used or there is no incoming call or call alert after a certain timeout period. To determine this threshold period:

- From the **Display Off Timeout** list, select a timeout period. The settings run from Off to 120 seconds. The factory default is 30 seconds.

Setting when the listen again auto is automatically deleted

You can configure the beltpack to automatically record incoming audio to allow you to replay the audio. These recordings are automatically deleted after a certain period. To determine this period:

- From the **Listen Again Auto Delete** list, select a timeout period. The settings run from Off to 240 minutes. The factory default is 240 minutes.

Setting the listen again recording time

You can configure the beltback to automatically record incoming audio to allow you to replay the audio. To determine the recording period:

- From the **Listen Again Record Time**, select a recording time. The settings run from 0 seconds to 15 seconds. The factory default is 15 seconds.

Setting the Reply Tally Auto Clear time

You can configure the beltback to automatically clear the reply tally.

- From the **Reply Tally Auto Clear** list, select a time. The settings run from Off to 60 seconds. The factory default is 10 seconds.

Menu Level

Use this option to determine what menu options are available to beltback users.

From the **Menu** list, select from the following settings:

- Advanced- all menu options are available.
- Normal – all menu options are available except:
 - **Main > Volume Operation**
 - **Main > Display Mode**
 - **Main > Settings > Headset Options > Headset Limiter**
- Basic – all menu options are available except:
 - **Main > Volume Level Control**
 - **Main > Line In Volume Level**
 - **Main > Admin Options**
 - **Main > System Connect**
 - **Main > Information**
- None – no menu options are available except:
 - **Main > Admin Options** (admin code required)

The factory default is Normal.

Enabling key latching

Key latching determines whether the beltback keys latch when pressed so that you do not have to keep the key pressed to maintain an audio route. If latching is

disabled the audio route is only open when the key is pressed. To enable key latching:

- Select the **Latching Talk Keys** checkbox. The factory default is latching disabled.

Partyline display mode

Use this option to determine whether the beltpack can display in partyline mode.

Dimmed tallies

Use this option to enable dimmed tally lights. When enabled, keys will always show a dimmed state of the active state. The factory default is enabled.

10.4.8 Assigning beltpack keys

You can use Configuration Editor to assign destinations for each of the four beltpack talk keys, A, B, C and D.



Figure 10-10 Beltpack Key Assignments

- 1) From the **Name** list, select the beltpack.
- 2) Click on the down arrow beside each window to open a drop-down menu of all the available ports or key types and select the required item. The selected item will appear in the window.

Note: If the key assignment is '----' then the beltpack key is locked and cannot be used.

For an explanation of the available port types abbreviations see **Table 10-1 Available port types**.

Abbreviation	Meaning
HDSTA	Front panel headset on channel A
HDSTB	Front panel headset on channel B
4WIR1, 4WIR2, 4WIR3, 4WIR4	Four Base station 4-wire output ports
PLCHA	Partyline channel A
PLCHB	Partyline channel B
STGAN	Stage announce output
PRGRM	Program input
BPK01 to BPK20	One of up to twenty beltacks
GRP01 to GRP05	One of up to five configured groups
WPL01 to WPL05	One of up to five wireless partylines
IFB1 to IFB10	One of up to 10 interruptible foldbacks

Table 10-1 Available port types

Use the **Copy** and **Paste** buttons to copy the setup of the current beltack and paste that setup onto another beltack. This allows you to quickly configure beltacks when many have the same setup.

Use the **Clear** button to clear all key assignments for the current beltack.

10.4.9 Configuring the Reply key

You can configure the Reply key in the following ways:

- As a Reply key. You can reply to the call by pushing the **REPLY** key (this is the default setting for this key).
- Assigning a talk/listen destination. Pushing the **Reply** key calls this destination. For example, if you select **STGAN** from the list, the label **STGAN** appears in the display. You can always activate the stage announce by pushing the **REPLY** key. The key type will be enabled allowing the reply key to be configured.
- Locked. Selecting ----- de-activates the reply key. Five dashes ----- appear in the reply key label.

Note: In the last two cases there is no mechanism for replying to sources that call the beltack which do not have keys on the beltack assigned to them.

To configure as a reply key:

- 1) From the **Name** list, select the beltack.
- 2) From the **Reply key** list, select **REPLY**.

To assign a call destination:

- 3) From the **Name** list, select the beltpack.
- 4) From the **Reply key** list, select a destination from the drop-down list.

To deactivate the **REPLY** key:

- 5) From the **Name** list, select the beltpack.
- 6) From the **Reply key** list, select ----.

10.4.10 Key assignment types

By default an assignment is talk only; however 4-wire and partyline inputs can be selected as the following:

- **Listen**. The caller can be heard, but no outgoing audio path is created when the key is pressed.
- **Talk and listen (Talk&List)**. An outgoing and incoming audio path is created when the key is pressed.
- **Dual talk and listen (Dual T&L)**. A short press produces a latching listen path, while a long press produces a momentary talk.
- **Forced listen (Frc L)**. Assigning a key in this way forces a permanent listen path - that is the remote source can be heard on the beltpack even when the key is not latched on. No talk path is created when the key is pressed. This is useful for monitoring a program input or directors feed.
- **Talk and forced listen (T&F L)**. This is the same as a Forced Listen key, except a talk path is created when the key is pressed.
- **Talk**. The key will only create an outgoing audio path when pressed.

The type of a key is indicated on the beltpack with the use of different cases for the label: a Talk key is shown in all capitals, for example **TEST**. A listen key is shown in all lower-case, for example **test**. Dual Talk and Listen, and Talk and Forced Listen keys are indicated by an initial capital, with the rest in lower case, for example **Test**.

10.5 Configuring ports

From the Configuration Editor, you can use the **Ports** tab to:

- Select, name and configure ports
- Set the input output and VOX levels for ports

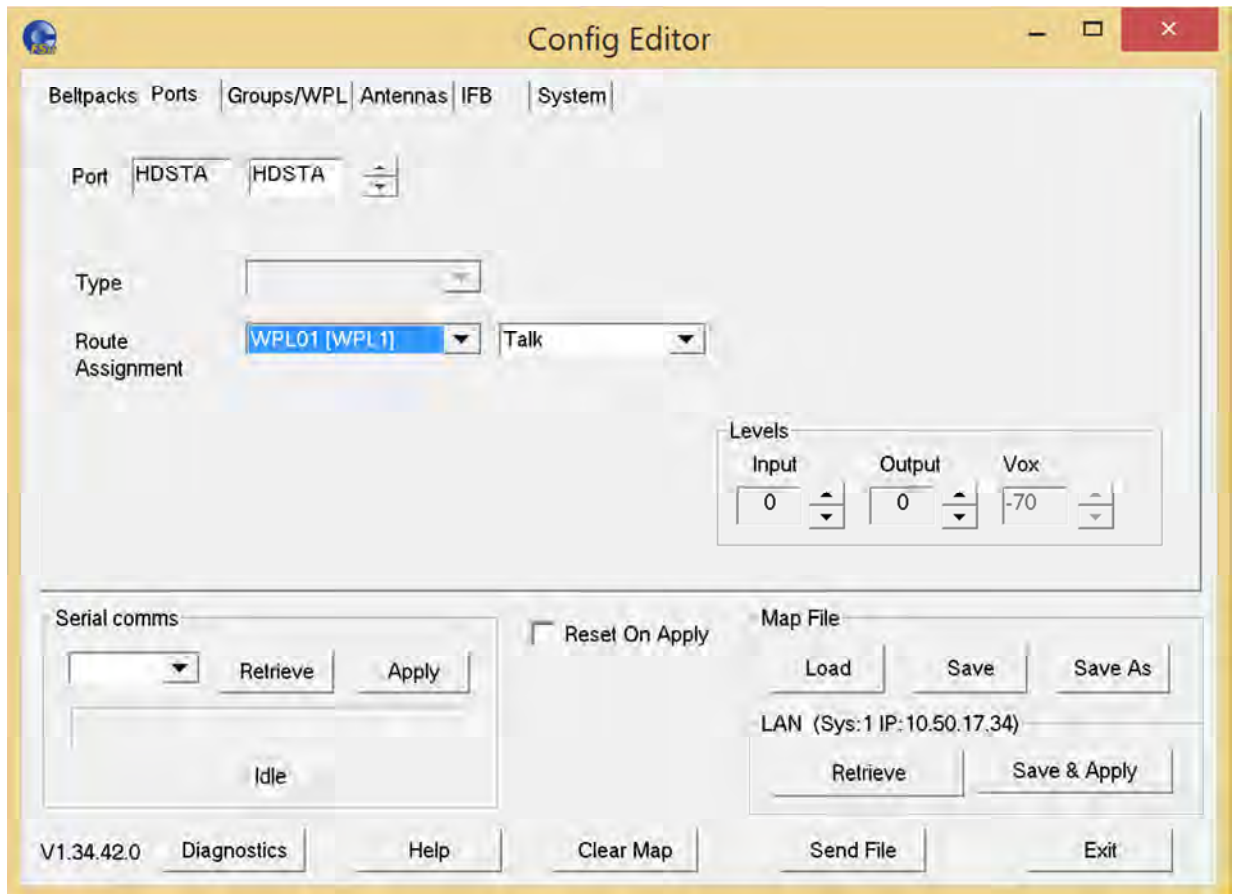

Figure 10-11 Ports Tab

10.5.1 Selecting the port to edit

To select a port to edit:

- Use the arrow buttons next to the **Port** edit box to make a selection.

10.5.2 Changing the label of the port

To change the port label:

- Select the port to be changed, and then over-type the text in the **Port** edit box.

10.5.3 Selecting the port type

You can only select a port type when a partyline port is selected. You can select between the following:

- Clear-Com - selects Clear-Com partyline compatibility with termination enabled.
- Drake - selects Drake partyline compatibility with termination enabled.

- RTS - selects RTS compatibility with termination enabled.
- OFF - termination disabled on partyline port.

The selection affects the gain, termination and call signaling used when communicating with this port.

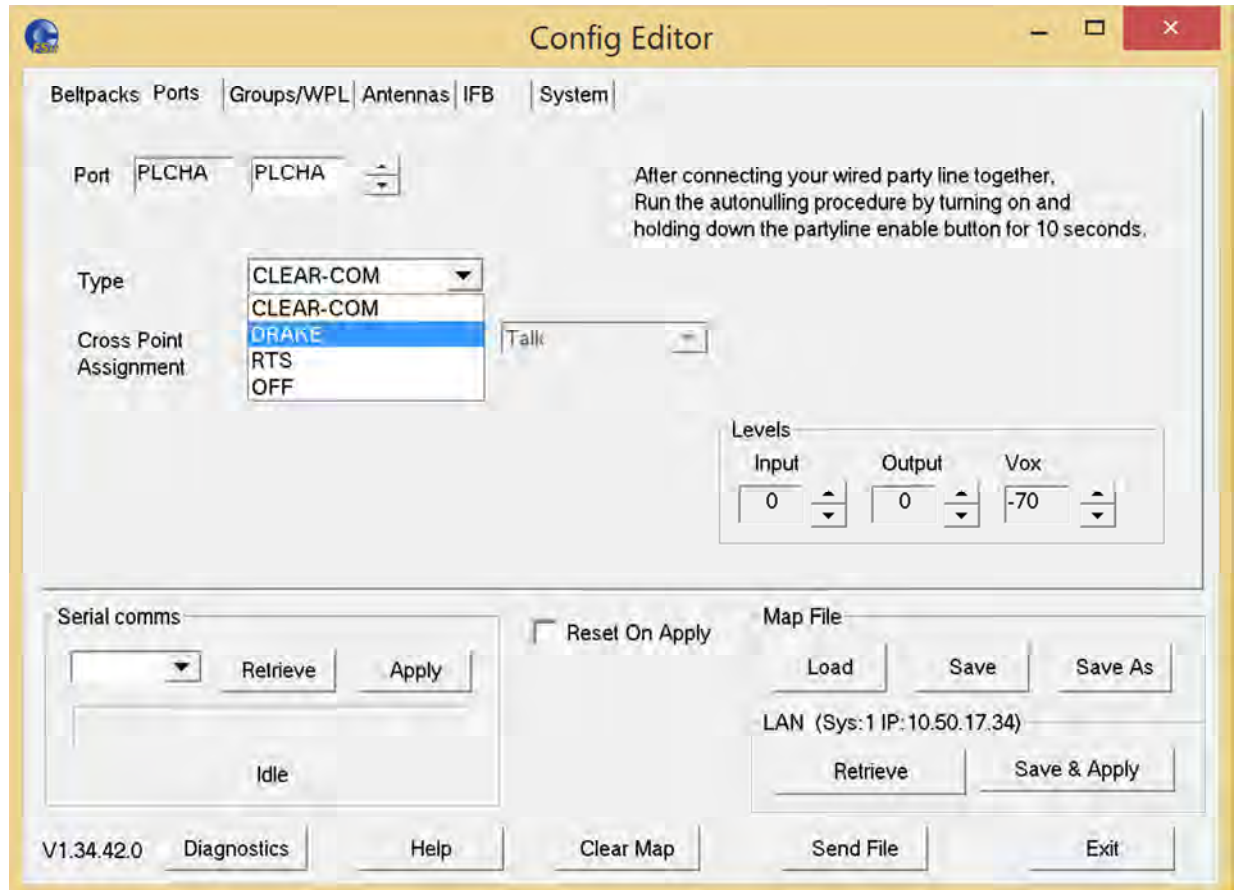

Figure 10-12 Partyline Port Type Menu

10.5.4 Selecting a communication path for the port

For headset, partyline, 4-wire ports and IFBs, you can select an audio path to determine the destination for the port. To do so:

- 1) From the Cross Point Assignment left list, select the audio destination for the port.

For a front panel headset port, you can specify the port which is called when the **Talk** button for that port is pushed.

For a partyline or 4-wire port, it causes a permanent talk path to be created from the port to this destination.

For an IFB it creates an IFB from the port to the destination.

- 2) For 4-wire and partyline destination ports you can select talk and listen functions as described in **10.4.10 Key assignment types**. From the Cross Point Assignment right list, select the required function.

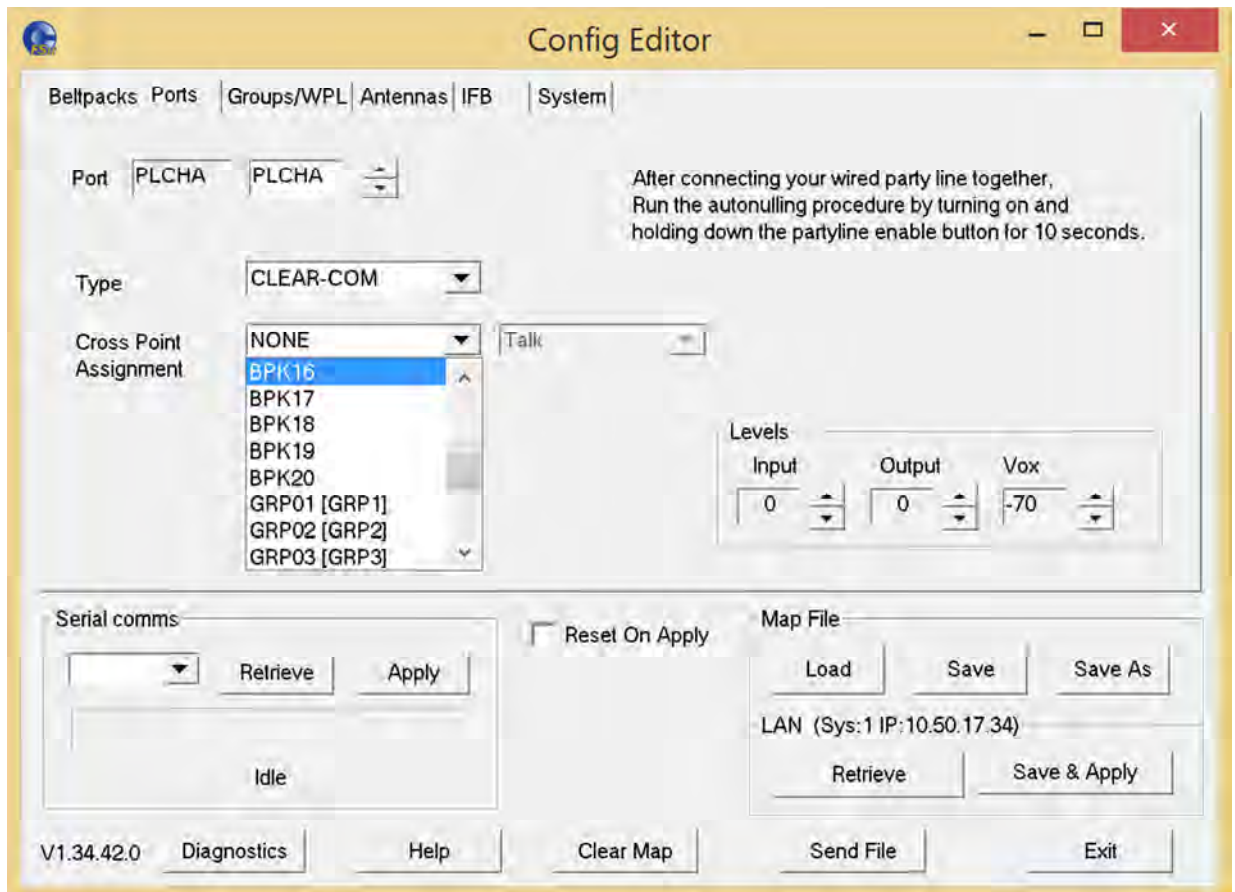

Figure 10-13 Cross Point List for Port

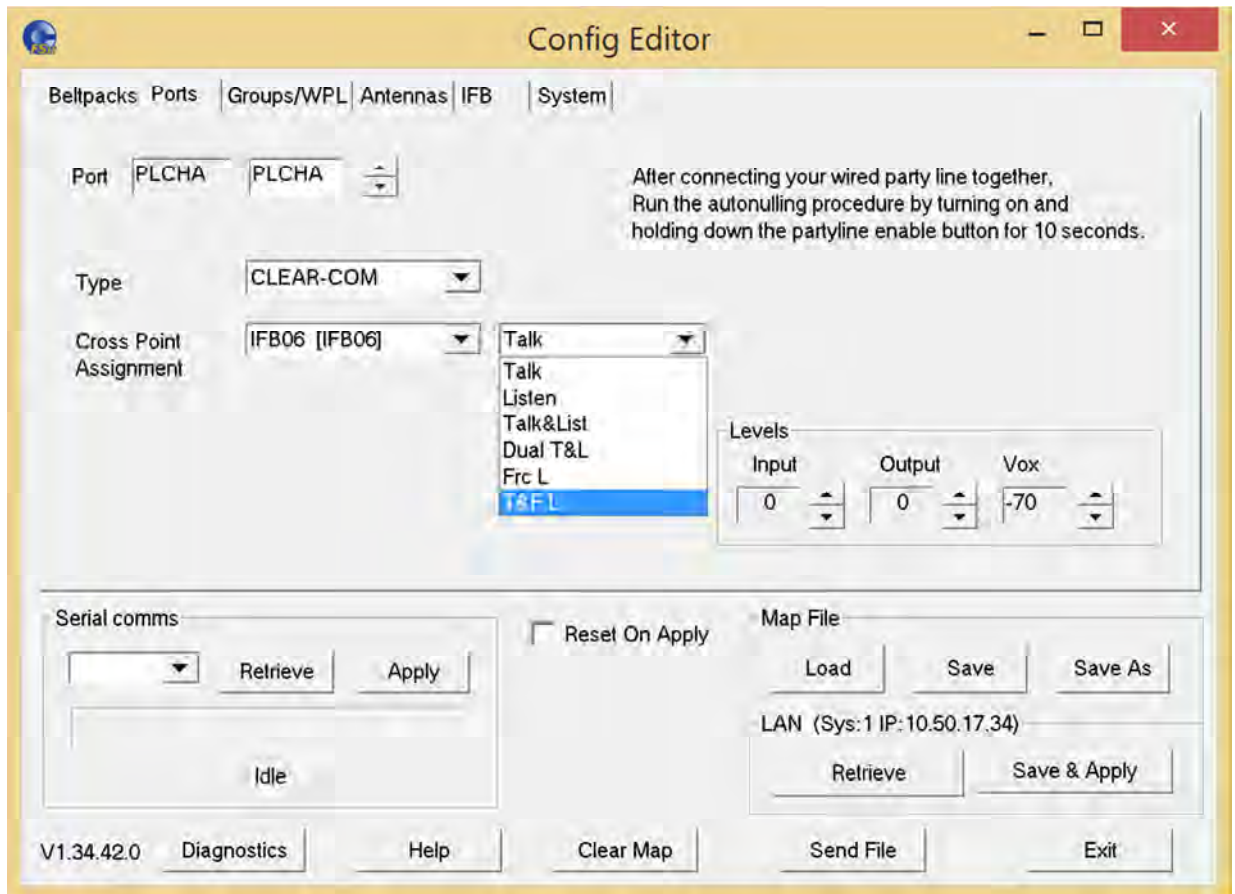

Figure 10-14 Partyline Crosspoint Type

10.5.5 Setting the input, output and VOX levels

The input level determines the level at which other users will hear a port, and the output level determines the level at which the port hears other users.

If VOX is enabled, the VOX level specifies the audio level at which a VOX triggered audio path is set. The VOX trigger level can be set in the range -70dB to -10dB.

To set an input, output or VOX level,

- From the **Input**, **Output** or **VOX** list, select an input value. The values run from 6dB to -20dB for input and output levels. For VOX level, the values run from -10dB to -70dB.

10.6 Configuring groups and wireless partylines

From the Configuration Editor, you can use the **Groups/WPL** tab to:

- Select and name groups*
- Populate groups

- See an overview of configured groups

* **Within the Groups tab, groups include wireless partylines (WPL).**

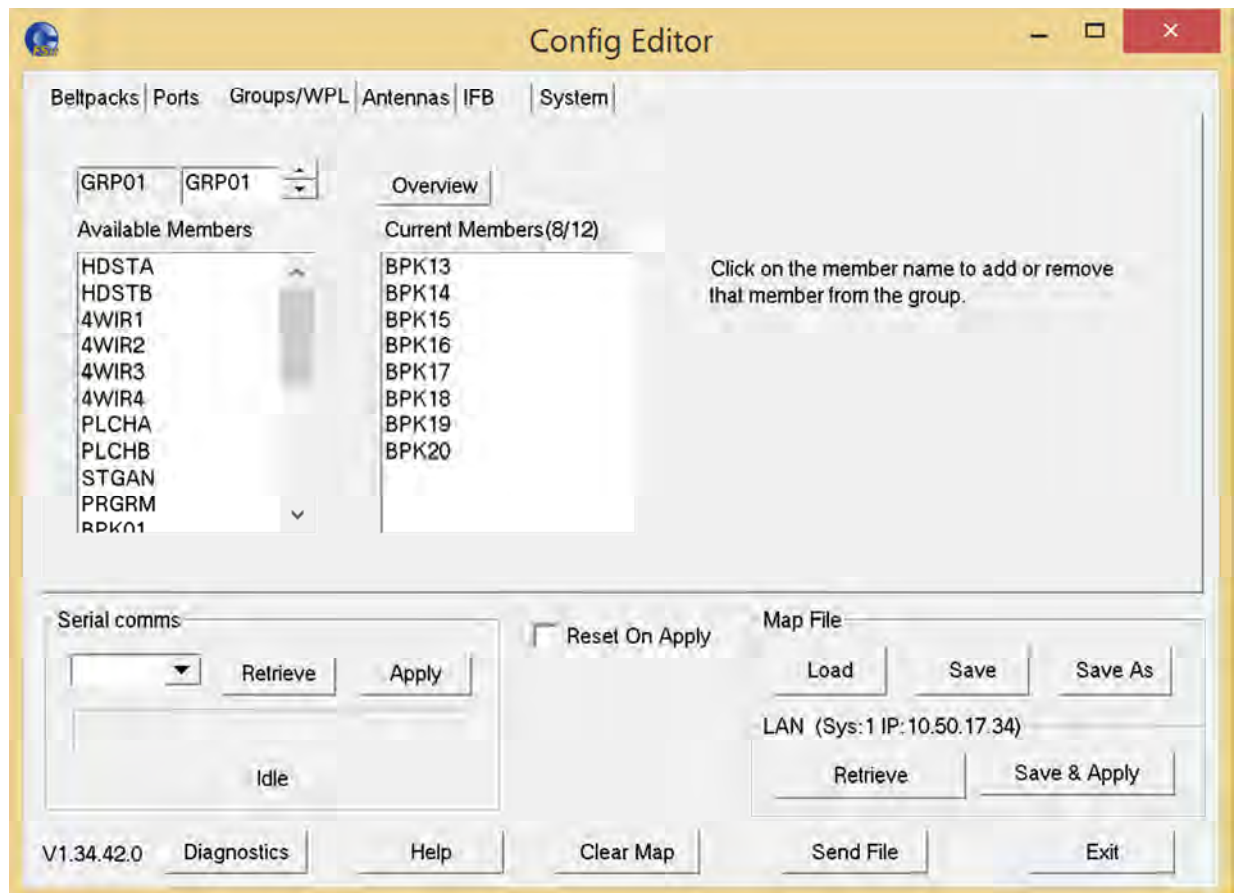

Figure 10-15 Groups Tab

10.6.1 Selecting the group to edit

To select a group to edit:

- Use the arrow buttons next to the **Group** edit box to make a selection.

10.6.2 Changing the label of the group

To change the group label:

- Select the group to be changed, and then over-type the text in the **Group** edit box.

10.6.3 Changing the members of the group

The **Groups/WPL** tab displays two lists of members. The **Available Members** list shows the members available to be placed in the current group, and the **Current Membership** list shows the current group members.

To edit the group lists:

- Move the mouse pointer over the member in the list and click. The member will be transferred from one list to the other.

10.6.4 Displaying a group overview

To display a group overview:

- Click **Overview** to display an overview of group membership for all groups.

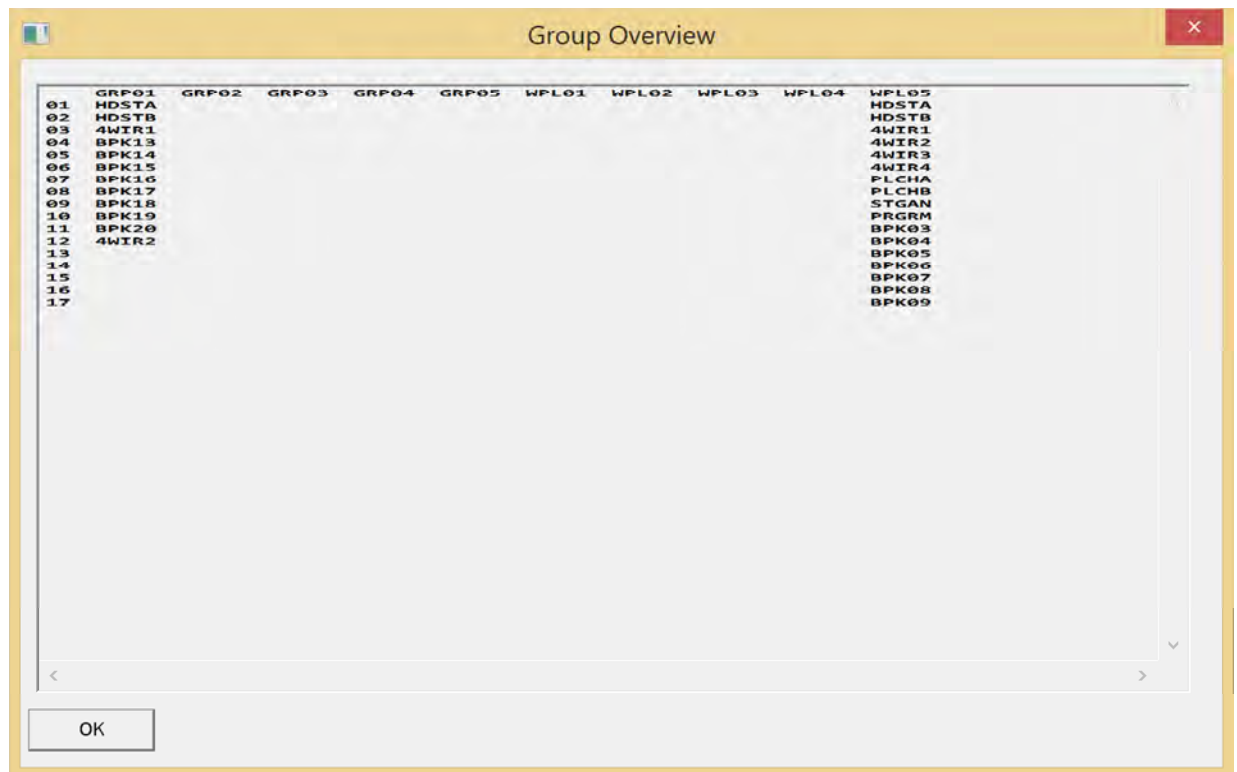

Figure 10-16 Group Overview Display

The groups are listed along the top and the total membership of all the groups is listed down the side. Wherever a member of a group is online an **x** will be displayed on the view at the intersection between the member and the group.

10.7 Reducing antenna interference

From the Configuration Editor, you can use the **Antennas** tab to reduce interference between antennas that are close to each other.

Because of propagation delays along the cables, antennas which are in close proximity but which have effective cable lengths which differ by more than approximately 150m can interfere with each other. This screen allows you to compensate for the length of the connection of each of the 10 available antennas.

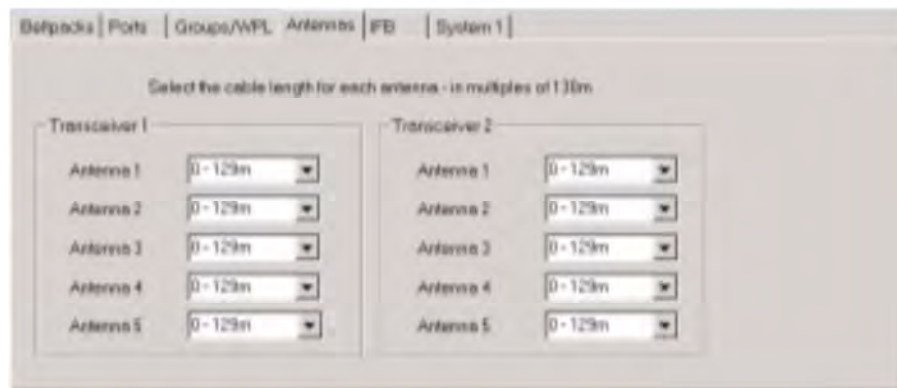

Figure 10-17 Antennas Tab

- 1) From each Antenna list, select the appropriate cable length.

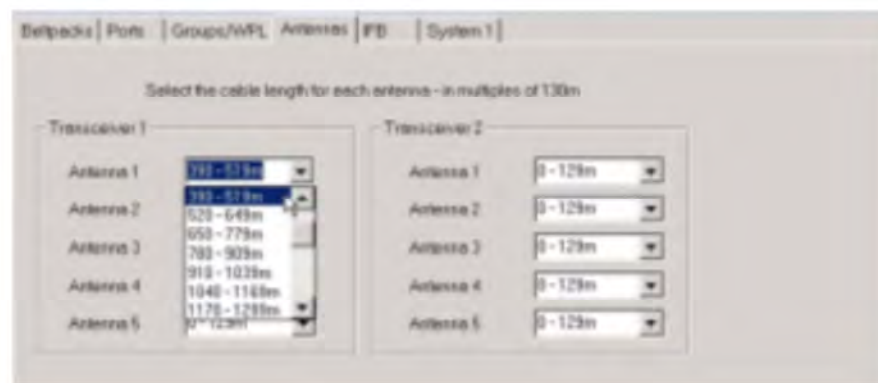

Figure 10-18 Antenna Cable Length Setup

- 2) Download the changes to the Base station with reset.

10.8 Configuring IFBs

From the Configuration Editor, you can use the IFB tab to:

- Assign IFB sources and destination to an IFB label
- Set the dim level for the IFB

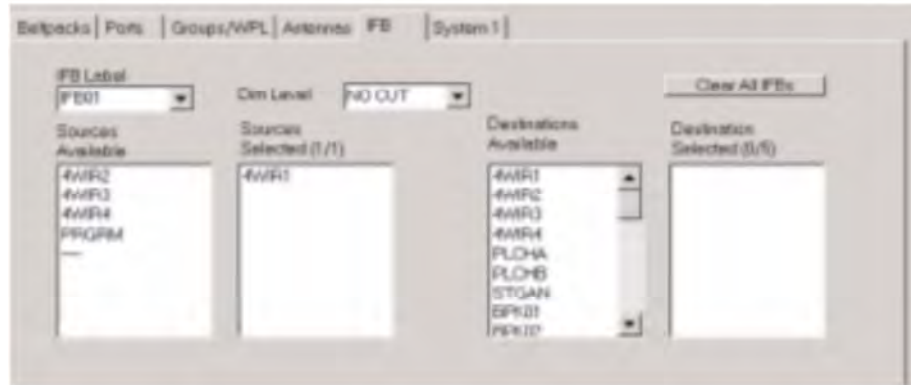

Figure 10-19 IFB Configuration Tab

10.8.1 Selecting the IFB to edit

To select an IFB to edit:

- From the **IFB Label** list, select the required label.

10.8.2 Changing the label of the IFB

To change the IFB label:

- Select the label to be changed, and then over-type the text in the **IFB Label** edit box.

10.8.3 Changing the IFB sources

The **IFB** tab displays two lists of sources. The **Sources Available** list shows the sources available, and the **Sources Selected** list shows the current sources.

To edit the IFB lists:

- Move the mouse pointer over the member in the list and click. The member will be transferred from one list to the other.

10.8.4 Setting the IFB dim level

When an IFB is activated, its associated audio feed is dimmed. You can adjust the level of this dimming.

To set the dim level:

- From the Dim Level list, select the required level

You can choose between the following levels:

- No cut - the audio feed is not reduced

- -3dB to -27dB - the audio feed is reduced by the selected amount
- Full cut - the audio feed is reduced to zero

10.9 Configuring Base station system parameters

From the Configuration Editor, you can use the **System** tab to assign IP addresses to the Base station and set pin numbers and access codes. You can also enable Over The Air (OTA) beltpack registration.

10.9.1 Editing the system parameters:

To edit the system parameters:

- 1) Select the **System** tab. The following screen appears.



Figure 10-20 System Tab

- 2) Edit the required system fields.

10.9.2 Enabling Over The Air (OTA) registration

To enable OTA, see **10.3 Registering beltpacks using the over the air (OTA) facility**.

10.10 Diagnostics

You can use the diagnostics tool to view the current state of the Base station, beltpacks and transceivers/antennas. To access the diagnostics tool:

- 1) At the bottom of the screen, select **Diagnostics**. The following screen appears:

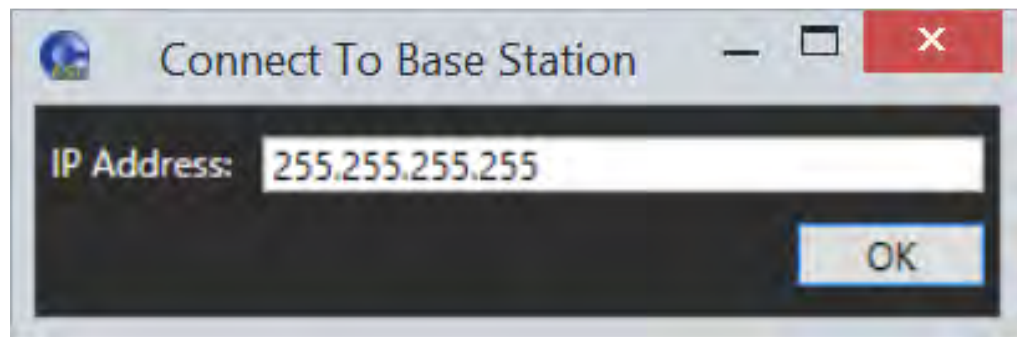

Figure 10-21 Diagnostics connection

- 2) Enter the IP address of the Base station and click **OK**. After connection, the following screen appears.

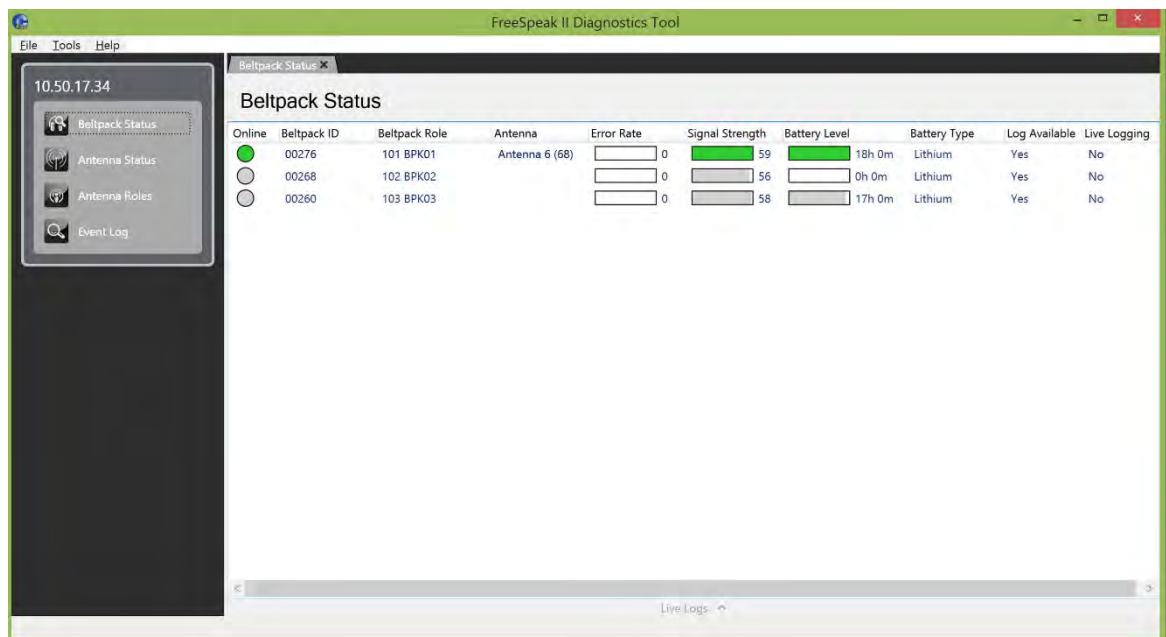

Figure 10-22 Diagnostics screen

3) From the list on the upper left of the screen, select the option you require.

10.10.1 Beltpack status

The Beltpack Status screen shows the current status of each FreeSpeak II beltpack on the matrix.

For beltpacks, users can see:

- Whether the beltpack is online or not
- The beltpack ID
- The beltpack role currently assigned to the beltpack
- The antenna currently used by the beltpack
- The error rate of the beltpack
- The signal strength of the beltpack
- The battery level of the beltpack, in hours and minutes if using Li-Ion batteries, or percentage remaining if using AA.
- The type of the battery (Li-Ion or AA)
- Whether a log is available on the beltpack
- Whether the beltpack is live logging

For the error rate, signal strength and battery levels, values are provided in both graphical and text forms. The graphs for these values are colored using standard traffic light colors to indicate good, acceptable and potentially problematic values.

Online	Beltpack ID	Beltpack Role	Antenna	Error Rate	Signal Strength	Battery Level	Battery Type	Log Available	Live Logging
●	00276	101 BPK01	Antenna 6 (68)	0	59	18h 0m	Lithium	Yes	No
○	00268	102 BPK02		0	56	0h 0m	Lithium	Yes	No
○	00260	103 BPK03		0	58	17h 0m	Lithium	Yes	No

Figure 10-23 Beltpack Status screen

You can right-click on an online beltpack and select live logging of a beltpack's status.

When live logging is turned on, the beltpacks currently live logging will be indicated on the beltpack status and the live logging pane will appear at the bottom of the beltpack status screen.

Time	Category	Peripheral	Port	Detail
10:56:12	BMC Trace	Beltpack	603	RSSI=11, Phase=11, ACRC=1, ACRC=12, Q1=5, Q2=16
10:56:12	BMC Trace	Beltpack	604	RSSI=11, Phase=11, ACRC=1, ACRC=12, Q1=5, Q2=16
10:56:12	Event Log	Beltpack	603	Reason=12, RPN=12, Events=12
10:56:12	Event Log	Beltpack	604	Reason=12, RPN=12, Events=12
10:56:12	Handover Event	Beltpack	603	Reason=13, Original RPN=13, New RPN=13, Events=13
10:56:12	Handover Event	Beltpack	604	Reason=13, Original RPN=13, New RPN=13, Events=13
10:56:12	RPN Event	Beltpack	603	Current RPN=224
10:56:12	RPN Event	Beltpack	604	Current RPN=224
10:56:12	FP Scan	Beltpack	603	Current RSSI=15, Current RPN=15, Next RSSI=3, Next RPN=195, Phase=195
10:56:12	FP Scan	Beltpack	604	Current RSSI=15, Current RPN=15, Next RSSI=3, Next RPN=195, Phase=195
10:56:12	PP/RFP Health	Beltpack	603	Battery Level=0, Battery Type=Lithium, Log Available=False, RSSI=16, BER=16
10:56:12	PP/RFP Health	Beltpack	604	Battery Level=0, Battery Type=Lithium, Log Available=False, RSSI=16, BER=16
10:56:12	BMC Trace	Beltpack	603	RSSI=1, Phase=17, ACRC=2, ACRC=4, Q1=8, Q2=17
10:56:12	BMC Trace	Beltpack	604	RSSI=1, Phase=17, ACRC=2, ACRC=4, Q1=8, Q2=17
10:56:12	BMC Trace	Beltpack	603	RSSI=1, Phase=17, ACRC=2, ACRC=4, Q1=8, Q2=17
10:56:12	BMC Trace	Beltpack	604	RSSI=1, Phase=17, ACRC=2, ACRC=4, Q1=8, Q2=17

Figure 10-24 Live logging screen

You can save the current log, clear the values currently displayed or open the live log in a new window:

When the live log is open in a new window, users have the option of also seeing any live logging data for antennas that is currently being output from the matrix.

The Live Log window shows the following details for each log:

- Time
- Category
- Peripheral Type (Beltpack or antenna)
- Port
- Detail

When a log is saved, the output file is a CSV file containing the same information shown in the log window.

10.10.2 Static log

When a static log has been generated by the beltpack, this will be shown in the **Is Log Available** column of the **Beltpack Status** screen. To get the current log, the user right clicks on the beltpack and selected **Get Log**. A **Diagnostic Log** window opens and shows the static log – users have the ability to save the log for future reference.

The static log window shows the same details as the live log window. When a log is saved, this is CSV format.

You can clear the log by right-clicking on the beltpack and selecting **Clear Log**.

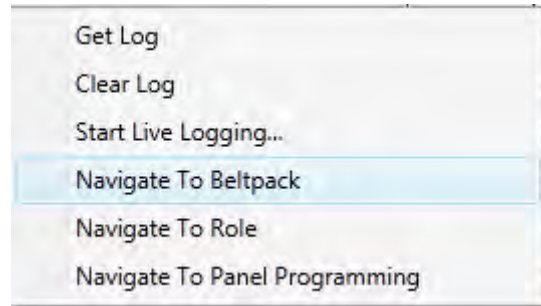

You can also navigate to the Beltpack, Role and Panel Programming entries for the role from here.

10.10.3 Antenna status

The Antenna status screen behaves in a similar fashion to the Beltpack Status screen, however with a different set of information available for the antennas.

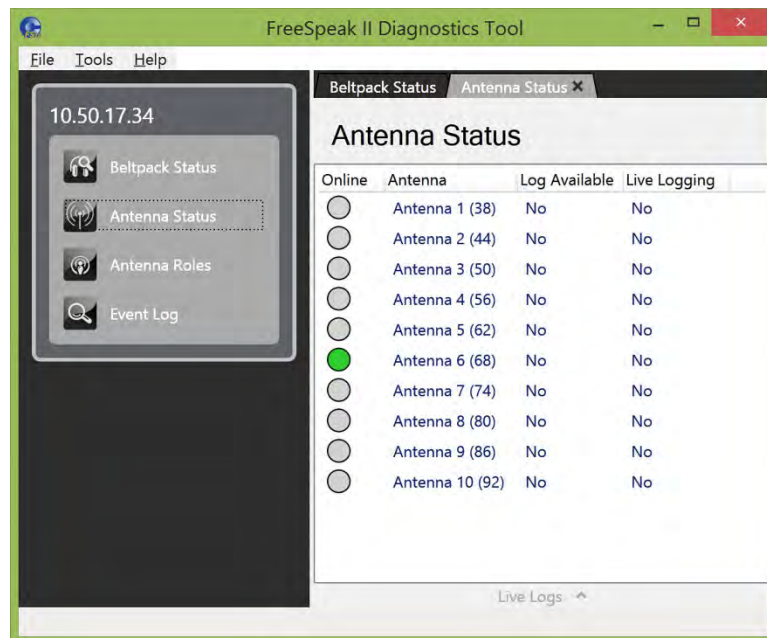

For antennas, you can see:

- Whether the antenna is online or not
- The antenna port and antenna label
- The cable length compensation
- Whether a log is available on the antenna
- Whether the antenna is live logging

10.10.4 Antenna roles

The Antenna Roles screen shows which beltpack roles are currently operating on each transceiver/antenna.

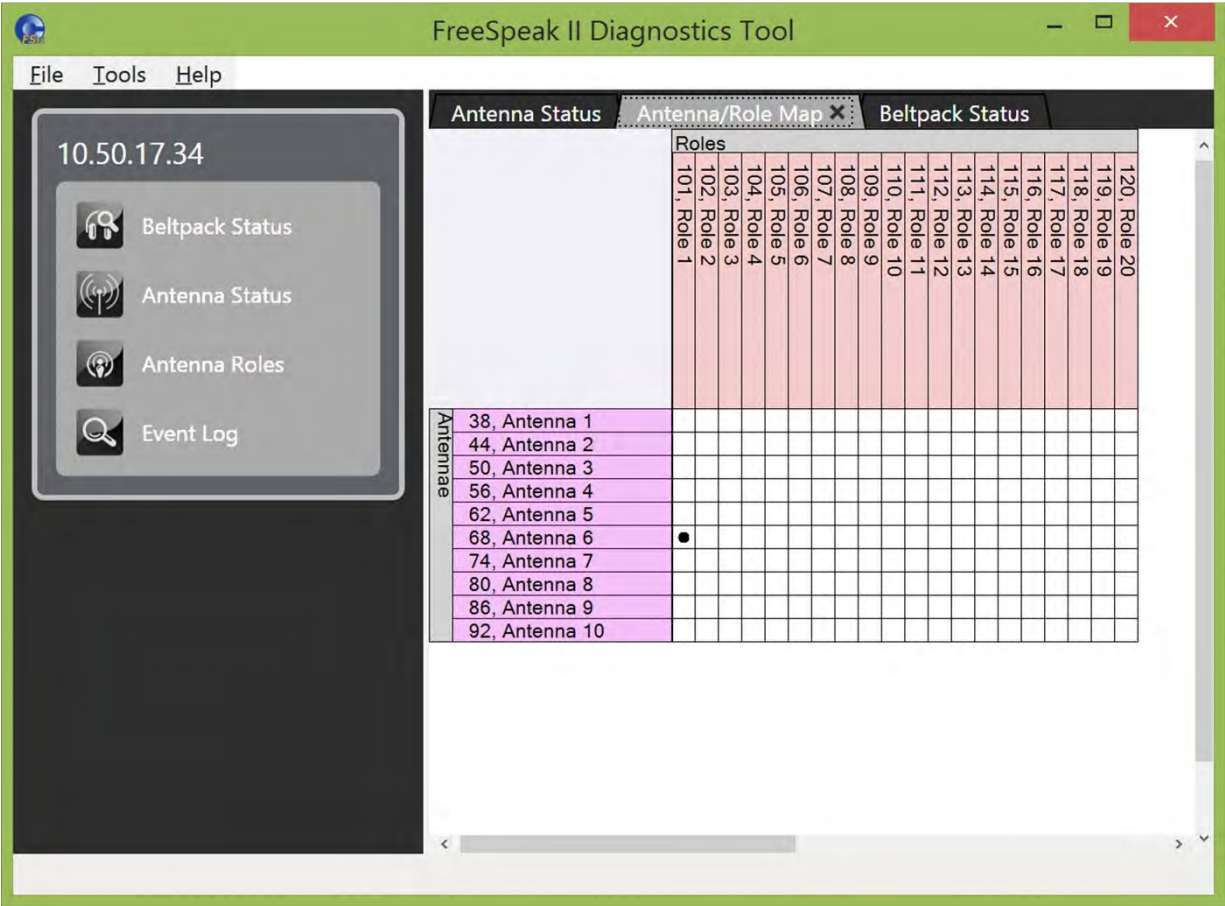

Figure 10-25 Antenna roles

10.10.5 Event Log

The Event Log shows a list of log messages produced by the Base station. An example is shown below:

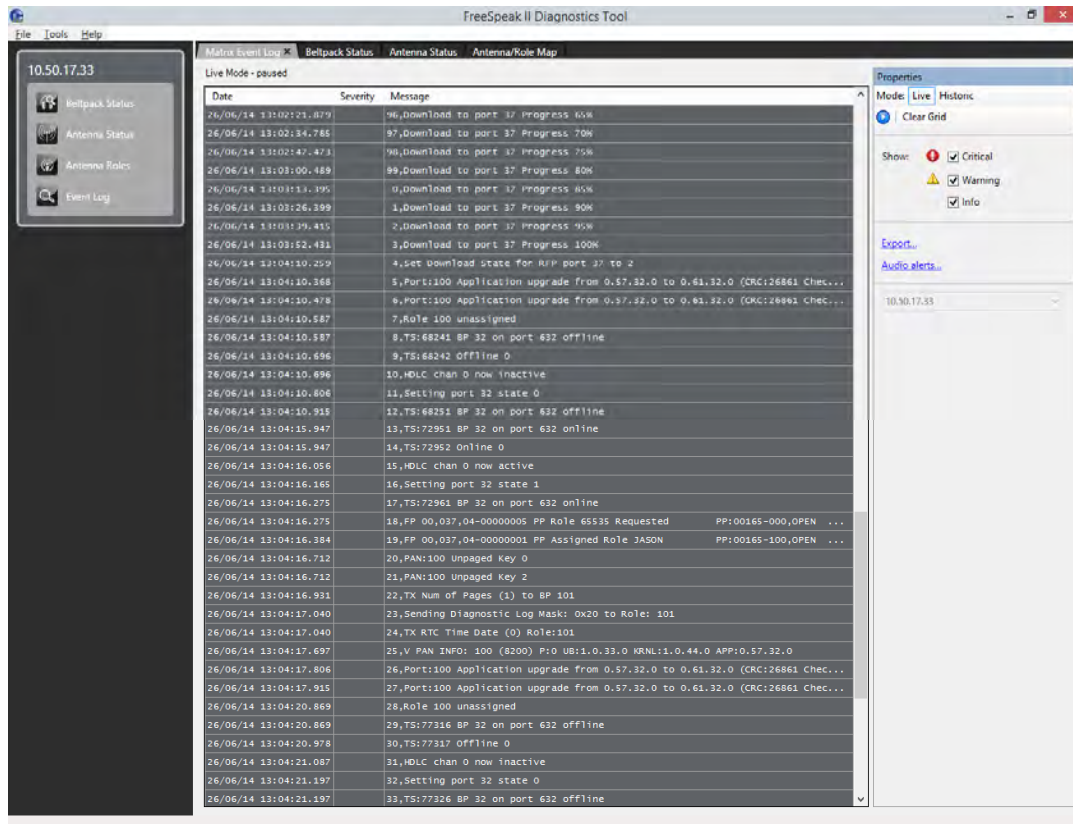

Figure 10-26 Event Log

To start receiving messages from the Base station, from the right hand pane click the **Play** icon at the top right of the screen.

10.11 Upgrading the Configuration Editor

Update the Configuration Editor using the update file supplied.

11 Upgrading the Base station from FS to FS II

This section explains how to upgrade a FreeSpeak/CellCom Base station to FreeSpeak II using the Configuration Editor.

11.1 Setting the Base station IP address

- 1) Power up the Base station, and select **SYSTEM > IP**.
- 2) Enter the IP address for the Base station.
- 3) Reboot the Base station. The Base station is now configured for the new IP address.
- 4) Install and start the Configuration Editor.

11.2 Upgrading the Base station firmware

- 1) From the Configuration Editor, click **Send File**, and ensure that the correct Base station IP address is present.
- 2) Navigate to the location of the upgrade file.

Note: Make sure that the drop-down list in the lower right-hand corner of the screen is set to Firmware files.

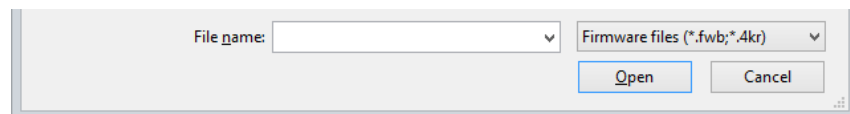

- 3) Click **Open**.

11.3 Upgrading the Base station FPGA

- 1) From the Configuration Editor, click **Send File**, and ensure that the correct Base station IP address is present.
- 2) Navigate to the location of the upgrade file.

Note: Make sure that the drop-down list in the lower right-hand corner of the screen is set to FPGA Files.

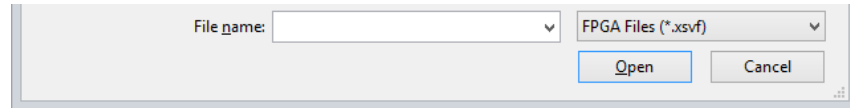

- 3) Click **Open**.

11.4 Loading the default map

- 1) From the Configuration Editor, click **Load**, and navigate to the location of the default map file.

Note: The default map file has a **.bsc** extension.

- 2) Select **System > Unlock SYS ID**.
- 3) In the **Config Password** screen, enter the following password: Clear-ComMap. A password confirmation message appears.
- 4) Close the Configuration Editor, and then restart it and reload the default map file.
- 5) Select **System**, and select the **Reset On Apply** check box.
- 6) In drop-down list below the **Reset On Apply** check box, select **DEFAULT**.



- 7) From the **Map File** area of the screen, select **Save As**, and save the file in the required location.
- 8) Click **Save & Apply**.
- 9) Click **Unlock SYS ID**, and enter the following password: Clear-ComMapOff.
- 10) Close the Configuration Editor.

12 Specifications

12.1 FreeSpeak II Base station

Base station-to-Beltpack Frequency Response	100 Hz – 7.1 kHz
Number of FS-BP Beltpacks per Base station	20
Number of FS-TA Transceiver/ Antennas Supported by Base station:	10
Number of transceiver/ antenna Ports	2
Programming port	DB9
Relay port	DB9; normally open and normally close wiring
Party-Line Intercom A and Intercom B (each)	XLR-3F with XLR-3M loop through, on/off termination switch (via software), Clear-Com RTS selection (via software)
4-Wire/Matrix Connection	4 RJ-45 for 4-wire (Intercom 3 – 6)
Program Input	XLR-3F, transformer isolated, line-level input
Stage Announce Output	XLR-3M, transformer isolated, line-level output
Front-Panel Headset	4-pin male connector with 2-channel, mono-summed capability and individual talks and listens
Front Panel Display	254 x 32 dot-graphic VFD
Front Panel Indicators	2 Talk LED's for front-panel headset; CH A and B party-line enable LED's; Program Input enable LED; 10 individual

beltpack LEDs

Base station Programming/Editing Push-to-enter rotary encoder

Dimensions 1-RU unit, 44 x 483 x 312 mm (hwd)
(1.75 x 19.0 x 12.5 inches)

Weight Approx. 4.5 Kg (10 lb).

12.2 FreeSpeak II Beltpack

Beltpack Frequency Response 100 Hz – 7.1 kHz

Beltpack Assignment-Select Buttons 2, used to edit beltpack menu options

Number of Full-Duplex Audio Paths 4, with individual level control

Level/Talk Controls 2 top-mounted rotary encoders

Headset Connector XLR-4M, Clear-Com standard

Headphone Impedance 32 ohm to 2000 ohm

Microphone Type Dynamic or electret, selectable in beltpack menu

Input Level -70 to -40 dBu

Electret headphone voltage 2.3V

Microphone and Headset Limiters Selectable in beltpack menu

Powering Li-Ion Battery, 3 AA alkaline cells

Battery Charging In unit, via supplied 5 way AC60 charger

Battery Life Approximately 18 hours

Range from Single FSII-TCVR-19

Transceiver/Antenna 500 m from transceiver/antenna in line-of-sight conditions; 50 m indoors; use multiple antennas for larger, custom coverage areas

Approx. dimensions 38 x 130 x 100 mm (dwh)
(1.5 x 5 x 3.75 inches)

Weight (with batteries) Approx. 400g (9 oz).

12.3 FreeSpeak II Transceiver/Antenna

Beltpacks Supported Per
Transceiver/Antenna 5, in one cellular zone

Transceiver Antenna Transmission
Range Up to 500 m (1475 ft.), line of sight

Maximum Distance, Base station to Transceiver
Via Base station Port 1,000 m (3,200 ft.) using 24 AWG cable
500 m (1,600 ft.) using 26 AWG cable

Maximum Distance, Transceiver Powered
By Base station Port 300 m (975 ft.)

Local Powering Via 24VDC power supply

Connection to FreeSpeak Base station RJ-45

Mounting 3 fixing holes

Dimensions 50 x 140 x 175 mm (dwh)
(2.0 x 5.5 x 6.9 inches)

Weight Approx. 460g (16.1 oz).

12.4 FreeSpeak II Transceiver/Antenna Splitter

Number of Transceiver/Antennas
Supported 10

Number of Splitters Per Base station 2

Connection Between Base station
and Splitter 4-pair CAT5 cable with RJ-45

Connection Between Splitter and
Transceiver/Antennas 4-pair CAT5 cable with RJ-45

Powering of Splitter Locally powered via external power
supply

12.5 Transmission Method

Method of RF Operation	1.9 and 2.4 GHz radio frequency bands
Modulation	GFSK
Frequencies of Operation	FS II-EU 1880–1900 MHz (Europe) FS II-US 1920 – 1930 MHz (North America) FS II-24 2400 – 2483.5 MHz
Maximum RF Output	FS II-EU 250 mW burst, average level 2 - 4 mW (Europe) FS II-US 100 mW burst, average level 2 - 4 mW (US) FS II-24 250 mW burst (Global, non-EU) FS II-24-EU 100 mW burst (Europe)

Theory of Operation

Dynamic allocation of frequencies and handoff of beltacks among the transceiver/antennas up to their individual limit of 5 connected beltacks at a time; each beltack is assigned a "virtual port" within the FreeSpeak Base station.

NOTICE ABOUT SPECIFICATIONS

While Clear-Com makes every attempt to maintain the accuracy of the information contained in its product manuals, that information is subject to change without notice. Performance specifications included in this manual are design-center specifications and are included for customer guidance and to facilitate system installation. Actual operating performance may vary.

13 Compliance

FCC Notice:

Changes or modifications to the equipment not expressly approved by the party responsible for compliance could void the user's authority to operate the equipment.

This device complies with Part 15 of the FCC Rules. Operation is subject to the following two conditions: (1) this device may not cause harmful interference, and (2) this device must accept any interference received, including interference that may cause undesired operation.

This equipment has been tested and found to comply with the limits for a Class A digital device, pursuant to Part 15 of the FCC Rules. These limits are designed to provide reasonable protection against harmful interference when the equipment is operated in a commercial environment. This equipment generates, uses, and can radiate radio frequency energy and, if not installed and used in accordance with the instruction manual, may cause harmful interference to radio communications. Operation of this equipment in a residential area is likely to cause harmful interference in which case the user will be required to correct the interference at his own expense.

Beltpack FCC/IC RF Exposure Warning:

- This product complies with FCC / IC radiation exposure limits set forth for an uncontrolled environment.
- This product may not be collocated or operated in conjunction with any other antenna or transmitter.
- The beltpack has been tested to comply with FCC / IC RF Exposure requirements in body-worn position. Use of third party clips or holsters with the beltpack may not ensure compliance with FCC / IC RF exposure requirements and should be avoided.
- To comply with FCC / IC RF exposure requirements, the Antenna/Transceiver unit must be installed and operated at least 20 cm (8 inches) from any person.

Avertissement de la FCC / IC sur l'exposition humaine aux radiofréquences de l'appareil:

- Ce produit est conforme aux normes FCC / IC concernant les limites de champ RF définies pour l'utilisation par le grand public
- Ce produit ne peut pas être installé à proximité ou utilisé en conjonction avec une autre antenne ou émetteur.

- Le produit a été testé pour se conformer aux exigences sur l'exposition aux radiofréquences de la FCC / IC pour un appareil porté sur le corps. L'utilisation de pinces ou d'étuis d'un tiers ne peuvent assurer la conformité aux normes FCC / IC sur l'exposition aux radiofréquences et doivent donc être évitée.
- Pour se conformer aux exigences sur l'exposition aux radiofréquences de la FCC / IC, l'antenne émettrice doit être installée et utilisée à plus de 20 cm (8 po) de tout utilisateur.

Regulatory model numbers:

Beltpack: BP2G4A

Transceiver: XCVR2G4A (Modular)

Transceiver: MER2G4TCVR (Transceiver)

IC Notice:

This device complies with Industry Canada licence-exempt RSS standard(s). Operation is subject to the following two conditions: (1) this device may not cause interference, and (2) this device must accept any interference, including interference that may cause undesired operation of the device.

Le présent appareil est conforme aux CNR d'Industrie Canada applicables aux appareils radio exempts de licence. L'exploitation est autorisée aux deux conditions suivantes : (1) l'appareil ne doit pas produire de brouillage, et (2) l'utilisateur de l'appareil doit accepter tout brouillage radioélectrique subi, même si le brouillage est susceptible d'en compromettre le fonctionnement.

Industry Canada Compliance Statement

This Class A digital apparatus complies with Canadian ICES-003.

Avis de conformité à la réglementation d'Industrie Canada

Cet appareil numérique de la classe A est conforme à la norme NMB-003 du Canada.



Changes or modifications to the equipment not expressly approved by the party responsible for compliance could void the user's authority to operate the equipment.

Hereby, HM Electronics, Inc. declares that FreeSpeak II products are in compliance with the essential requirements and other relevant provisions of R&TTE Directive 1999/5/EC.

Waste Electrical And Electronic Equipment (WEEE)

The European Union (EU) WEEE Directive (2002/96/EC) places an obligation on producers (manufacturers, distributors and/or retailers) to take-back electronic products at the end of their useful life. The WEEE Directive covers most Clear-Com products being sold into the EU as of August 13, 2005. Manufacturers, distributors and retailers are obliged to finance the costs of recovery from municipal collection points, reuse, and recycling of specified percentages per the WEEE requirements.

Instructions for Disposal of WEEE by Users in the European Union

The symbol shown below is on the product or on its packaging which indicates that this product was put on the market after August 13, 2005 and must not be disposed of with other waste. Instead, it is the user's responsibility to dispose of the user's waste equipment by handing it over to a designated collection point for the recycling of WEEE. The separate collection and recycling of waste equipment at the time of disposal will help to conserve natural resources and ensure that it is recycled in a manner that protects human health and the environment. For more information about where you can drop off your waste equipment for recycling, please contact your local authority, your household waste disposal service or the seller from whom you purchased the product.



Figure 13-1: WEEE Symbol