

GPSmile 55 Portable Automobile Navigation System

Product User Manual



Version: V1.0

May 2007

Registered info

HOLUX and GPSmile are trademarks of HOLUX Technology, Inc.

All other trademarks belong to registered companies.

Note

- The contents of this manual will be modified without further notice.
- The operation temperature for the product is between 0 ~40 . Operating or recharging in an environment with a temperature over 45 might cause the system to stop functioning. However, this should be considered a normal phenomenon. Please do not operate under extreme temperatures.

Safety Precautions

- Use the power adapter included with the package. Using other power adapters than the one provided will result in malfunction and could prove to be dangerous.
- The device should only be used with the supplied batteries.
- About the power adapter:
 1. Do not use the power adapter in a wet environment. When hands and feet are wet, do not touch the power adapter.
 2. While using the power adaptor, ensure that the area is well ventilated. Do not let paper or other material cover the power adaptor, as this will interfere with cooling. Do not use the power adaptor whilst it is in a bag.
 3. Do not attempt to repair the device. If device is damaged or is in a wet environment, replace the device immediately.
 4. It is not recommended to charge from a PC because the PC power voltage is not enough to supply the device.
- About the battery
 1. Use only the original factory approved charger.
 2. A Lithium battery is built into the device. To prevent fire or skin burns, do not disassemble, pierce, impact, or expose the battery to fire. The battery will crack, explode, or release dangerous chemicals if placed in a fire.
- Important instructions
 1. Note: Replacing with an incorrect battery may result in an explosion. When disposing of the battery, follow the instructions. The replacement battery must be a factory approved original.
 2. Regulations must be observed when recycling or disposing of batteries.
 3. The battery should only be used in this device.

Warranty Statement

- This warranty applies to parts and services of GPSmile55 that are manufactured and sold through Holux Technology Inc. The local area covered is Taiwan; the warrantee length is one year from date of purchase (starting from the date on the sales receipt). Under normal user operation, Holux Technology provides free repair services.
 - ❖ After repair, the replaced parts are the properties of Holux Technology Inc.
- Holux Technology is not responsible for providing repairs or replacements of any software; Holux Technology does not provide any warranty service for third party software/hardware.
- Important instructions

Note: This warranty does not cover damage or malfunction from the below causes: unauthorized disassembly/modification of unit, abuse or incorrect usage, accidental and other unpreventable causes, operation under variables mentioned that are different from those in this product user manual, using parts not made or sold by Holux Technology, or repairs done by anyone other than Holux Technology and authorized retail/service providers.

- ❖ Expendable parts are not covered in the warranty.
- ❖ Holux Technology is not responsible for any program, data, or portable storage media damages or loss. Please contact your local Holux Technology authorized service provider to learn more about geographical limitations, proof of purchase requests, response time agreements, and other specific maintenance service requests.

Technical Support

- If there are any questions regarding the use of this product, please logon to the website www.holux.com and see the FAQ.
- If answers cannot be found on the website, please send us an e-mail at info@holux.com, stating your query and location.

Maintenance Service

HOLUX Technology, Inc.

+886-3-6687000

Web Site: www.holux.com

E-mail: info@holux.com

HOLUX Technology, Inc.

www.holux.com

Table of Contents

Warranty Statement	iv
Technical Support.....	v
Maintenance Service.....	v
Preface	1
Symbols	1
Important Notice	1
Other Functions	2
First time use.....	3
<i>Copyright</i>	3
<i>Important Notice</i>	3
Package Contents	4
Basic Operation	5
<i>Introduction</i>	5
Front View	5
Rear View	5
Left Side	6
Right Side	6
Top View	6
Getting Started	7
<i>SD memory card installation</i>	7
<i>Using the stylus</i>	8
<i>Charging</i>	9
Using Home / Travel adapter:	9
<i>Using the In-vehicle Bracket</i>	12
Operating Methods	14
<i>Startup</i>	14

<i>Shutdown</i>	14
Using Functions	15
<i>Function Menu Music Playback Function</i>	16
<i>Storing MP3 files onto SD memory cards</i>	16
<i>Starting music playback</i>	16
<i>Image Browsing Function</i>	19
<i>Setting</i>	23
Power.....	23
Time.....	25
Time.....	25
Panel Adjustment.....	26
Reset GPS	28
Version	30
Bluetooth	31
Bluetooth PhoneLink.....	34
Phonebook	35
Dial pad.....	36
Message.....	37
File transfer	38
Hands-free	39
Setup.....	40
Setup message.....	41
Using the CD	43
Troubleshooting	43
<i>System reset</i>	44
<i>Quick Troubleshooting</i>	44
<i>Normal Care and Maintenance</i>	44
Keep dry.....	44
Do not drop the unit.....	44
Avoid sudden temperature changes	44
Keep away from strong magnetic fields	44

Operating temperature.....	45
Avoid exposure to sunlight.....	45
Using the stylus.....	45
Cleaning the screen.....	45
Do not disassemble.....	45
<i>Storage.....</i>	<i>45</i>
Appendix.....	46
<i>Specifications</i>	<i>46</i>
Federal regulations	48



Preface

We appreciate your purchase of the GPSmile 55.

Please read all instructions thoroughly for a full understanding of the products' features.

Symbols

For fast reference of the data you wish to find, this manual uses the following symbols.

- ✓ This icon means you should take note of the message and read during use.
-  This icon means warning and you should take care not to damage the unit.
-  This icon means useful tips for extra information while using.

Important Notice

- This system only provides a navigational reference. Do not use this system for any directional, distance, and geographic precise measurements.
- The first GPS positioning should be performed at a single set point in a wide-open area without building shelters. The length of time it takes to position will depend on the satellite signal strength, and cloud levels. It will possibly taking up to 10 minutes.
- GPS (Global Positioning System) is the satellite system used by the United States of America Department of Defense. All maintenance and operations are also managed by the United States of America Department of Defense. Should the system be modified and adjusted, the precision and operation of the GPS related systems might be affected.
- Any wireless communication products (mobile phone, radio, speed detection unit etc) might affect the GPS signal and result in a poor signal.
- For safety reasons, do not operate this system while driving a vehicle.

- Do not leave this unit under your front windshield after you leave the vehicle. Exposure to high temperatures might be dangerous and cause the battery to overheat, resulting in malfunction of the device.
- Window tinting might interfere with the reception of satellite signals. We recommend that you install a vehicle antenna to strengthen and stabilize the signal.
- The planned navigational route is for reference only; changes in roadside conditions (one way streets, no right turns) may happen so please respond according to the situation and decide whether or not to follow the planned course.
- When placing this system in the vehicle, please secure it on the car with brackets to ensure safety. The recommended installation location is illustrated below.

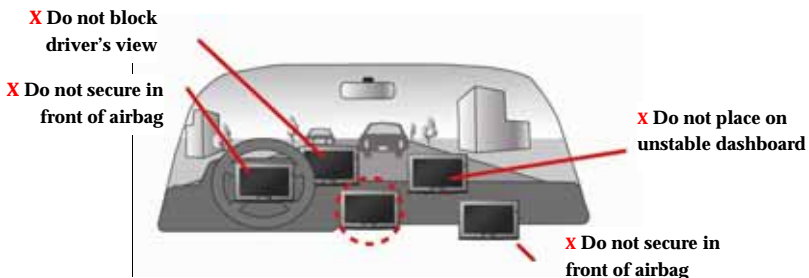

- Differences between manufactured and shipped versions may be present; this software may be updated frequently. If the descriptions in this manual are different from your software version, please follow the software version currently on hand.

Other Functions

- Music playback: plays MP3 music files.
- Image display: displays photographs or image files
- Video play films
- eBook display text file

First time use

Copyright

Without the written consent of HOLUX Technology, Inc, this manual, including the product and the software, may not be duplicated, transmitted, recorded or saved on storage devices. Furthermore, it shall not be translated under any circumstances into any other languages.

Copyright ©2006 HOLUX Technology, Inc. All rights reserved.

Important Notice

Please thoroughly read this manual of operating instructions and explanations. Only use original factory approved batteries and accessories to prevent unexpected damage. If the correct procedures were not followed for operation or incompatible accessories were connected, this is a violation of the warrantee agreement and will automatically void the warrantee. This may also cause personal safety issues.

Package Contents

Your product should include the following accessories:



NAV-55 Unit



In-vehicle Bracket



Bracket fixing



Car Adapter



Home / Travel Adapter
(Optional)



SD Memory Card
(Optional)



CD-ROM

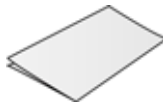

Quick Guide

Basic Operation

Introduction

Front View

4.3" TFT LCD with touch screen



Bluetooth LED
Charging indicator LED

Bluetooth LED:
Bluetooth ON: Blinking Blue
Bluetooth OFF: LED off

Charging indicator LED:
Charging: Orange
Full: Green

Rear View

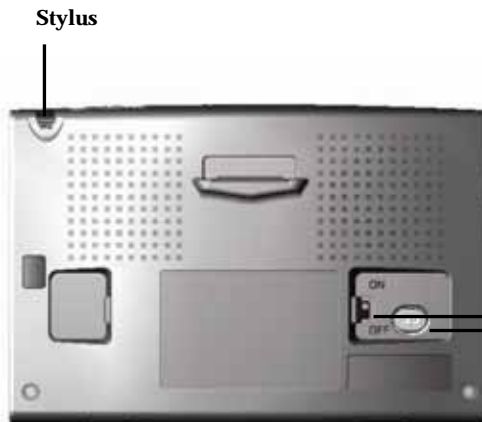

System power switch
I/O interface

Left Side

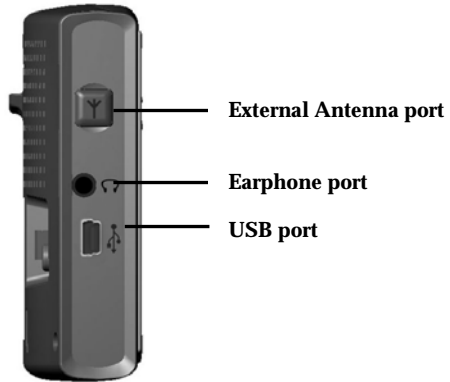

Right Side

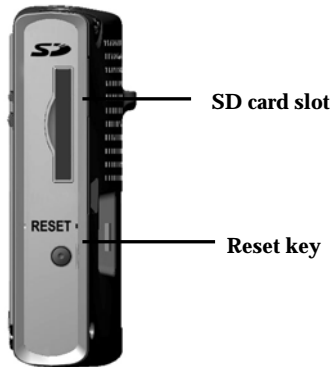

Top View

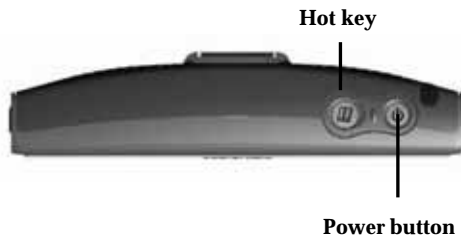

Getting Started

If you are a first-time system user, the following explanations will help you quickly understand the system operations, and experience the system's powerful and convenient functions.

SD memory card installation

This unit is equipped with a SD memory card slot. You can purchase SD (Secure Digital) Cards to expand the memory capacity.

To insert the memory card:

With the metal contacts of the memory card facing back, insert the card into the slot on the right side of the unit.

To remove the memory card:

1. Gently press the top of the memory card, and the card will eject automatically.
2. Then, pull to remove the memory card.



- ✓ The included memory card contains the digital map files that are required for the GPS navigational data. Please do not delete.
- ✓ When removing the memory card, please make sure the card is not reading data, or it will cause a system crash.
- ✓ Do not set the SD memory card as write protected, or the system will not operate properly.
- When operating, accidental removal of the memory card will result in showing an error message. Please reinsert the memory card and the system may need to be reset before further use.

Using the stylus

This unit can be controlled easily through the touch screen. The stylus is an assist tool for operating this unit and is concealed in a pen slot at the rear. Pull out to use.

Stylus



Charging

Using Home / Travel adapter:

Before using the device for the first time, we strongly suggest you use a fully charged battery.

1. Insert the USB connector into the unit.
2. Plug the adapter into a power outlet.



Using the car charger:

While using the device in a vehicle, use the included car charger for long periods of usage.

1. Plug the small plug into the power jack on the rear of the in-vehicle bracket.
2. Insert the other end into the cigarette lighter.

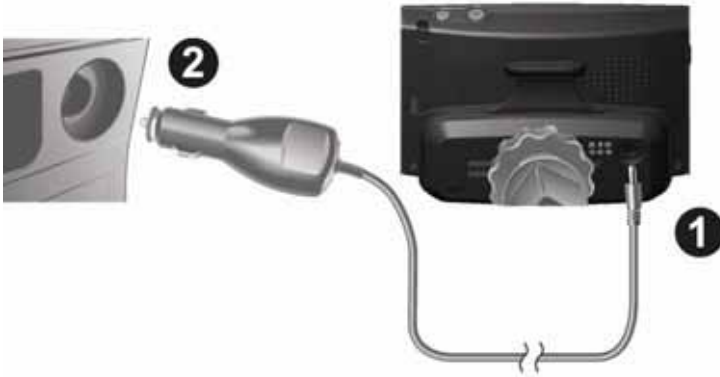

- ✓ This device uses a built-in rechargeable battery. Please note the following:
- Please do not charge in a hot environment, such as on a balcony or an area exposed to direct sunlight.
 - Do not wait until the battery is depleted to recharge.
 - When not using the unit for a long time, please turn off the system switch.
 - When charging a completely depleted battery, wait at least one minute before starting up the system. This will prevent excessive battery discharge.
 - When charging starts, the charging indicator light will be red, please wait for the charging to complete (this might take several hours). After charging is completed, the indicator light will be green.

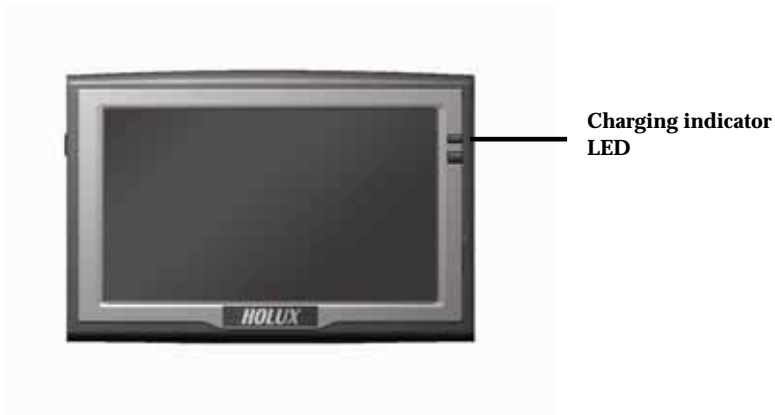

Using the In-Vehicle Bracket

The included in-vehicle bracket set can be securely suctioned on the front windshield, or secured on top of the glove compartment using the adhesive plate. This device will effectively secure the GPS unit in the vehicle. Follow the procedures below to secure the bracket:

1. Follow the arrows and secure the unit into the in-vehicle bracket fitting holes.
2. Gently push the unit until the unit is tightly fixed with the bracket.



Note: Please note the directions of the arrows. When secured, the assembly should be tight. If these directions are not followed, a loose fit will result, and components must be reassembled.

3. Bend the bracket support to a proper angle. Suction the vehicle bracket securely to the windshield, ensuring its base is resting firmly on the dashboard.

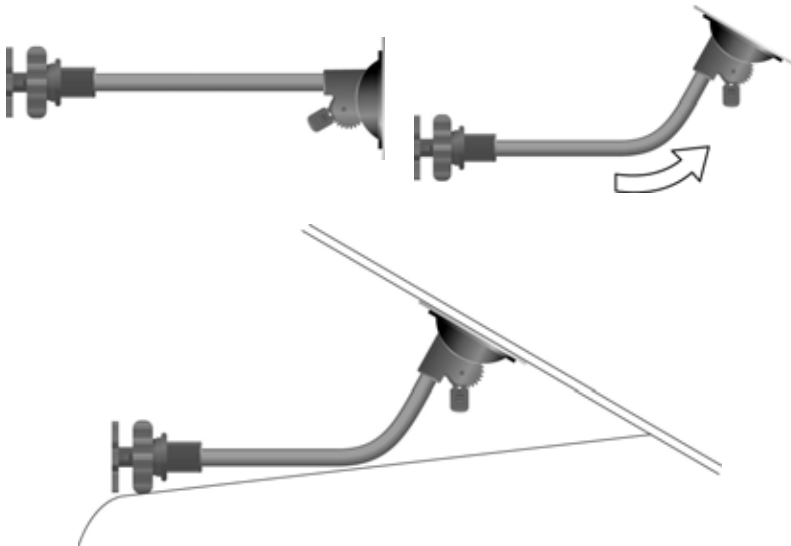

4. Follow the directions to insert the bracket into the slots on the bracket, and slide to fix the set (**A → B**).

5. The in-vehicle bracket assembly is complete.

✓ When using the in-vehicle secure bracket, do not install it in a location that will block the view of the driver

✓ Recommended installation requirements:

The bracket base should rest securely on the dashboard to prevent excessive shock.



Operating Methods

Startup

1. For first time use, please turn the system power switch at the rear side **On**.
2. Press and hold the power button for about two seconds to turn on the power.

Note: Before using for the first time, please switch the system power on.

Shutdown

1. While power is on, press the power button to turn the power off.
2. If the unit will not be used for a long time, turn the system power switch at the rear side **Off**.



Using Functions

During the first startup, the screen will show the main screen consisting of six functions: navigation, music, photo, video, ebook and settings. Directly select an icon on the screen to use the function.



- | | |
|----------------|---|
| GPS | Loads the navigation program and navigation screen
Note: If an SD card with navigator software is inserted, the system will automatically enter GPS function after startup. |
| MP3 | Plays MP3 music |
| PHOTO | Plays images |
| VIDEO | Plays video |
| eBOOK | Can read file with __txt format |
| SETTING | System setup |

Function Menu

Music Playback Function

This unit has an MP3 Music Playback function that is capable of playing back MP3 files stored on SD memory cards.

Storing MP3 files on SD memory cards

You must first convert the music from an audio CD into MP3 files on your computer. Then, save them onto the SD memory card.

All the files need to be stored under the **MP3** directory, and the file format needs to be “*.mp3”.

Starting music playback

1. Insert the SD memory card with stored MP3 files into the SD memory card slot on the unit.
2. Turn the power on, and select the **[MP3]** icon on the main menu.



3. The Music Playback Window. Use the buttons to control each playback function.



- | | | | |
|---|-------------------------------------|----|-----------------------|
| 1 | Play / Pause | 8 | Music Status |
| 2 | Stop | 9 | Progress bar |
| 3 | Previous | 10 | Repeat mode indicator |
| 4 | Next | 11 | Battery indicator |
| 5 | Normal / All / Random / Repeat mode | 12 | Timer |
| 6 | Exit | 13 | Help |
| 7 | Volume display | 14 | Play List |



2

- | | | | |
|---|---------------------|---|------------------------|
| 1 | MP3 List On SD Card | 5 | Delete One |
| 2 | Add All | 6 | Exit |
| 3 | Add One | 7 | MP3 List on the Device |
| 4 | Delete All | | |

Image Browsing Function

1. The system has an Image Browsing function that is capable of displaying images/photographs stored on SD memory cards.

All the files need to be stored under the **Image** directory, and the file format needs to be “*.jpg”.



2. Insert the SD memory card with stored image files into the SD memory card slot on the unit.
3. Turn the power on, and select the [Photo] icon on the Main Menu.
4. The Image Browsing Window.

Help |



Photo title



Previous

Information

Slide show

Rotate

Zoom in

Viewing Size

Zoom out

Delete

Exit

Video

Video can read the film with the following data format: __.wmv, __.asf.
Please convert files into a readable format and save them on the SD memory card in a folder named "film".

1. Insert the SD memory card with Video files into the SD memory card slot on the unit.
2. Turn the power on, and select the [**Video**] icon from the Main Menu Screen.



3. Use the Up/Down arrow key to select the film.

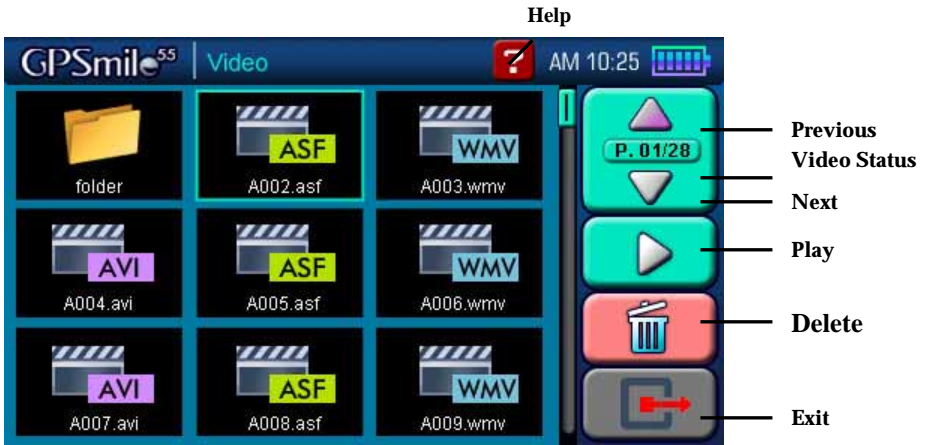

Use the right/left arrow key to move forward/backward in the film.



eBook

eBook can only read files with __.txt format. Please save them on the SD memory card in a folder named "ebook".

1. Insert the SD memory card with ebook files into the SD memory card slot on the unit.
2. Turn the power on, and select the **[eBook]** icon from the Main Menu Screen.



3. Use the up and down arrow key to change between books.

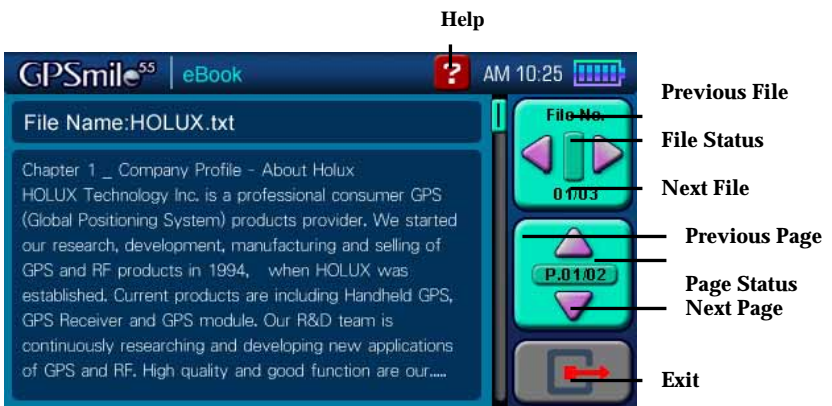

Setting

Power

1. After starting up the system, select the **[SETTING]** icon to enter.



2. Select **[Backlight]** from the main screen to access the Power settings screen.



3. Access  to select time turn off the backlight when running off the battery / external power.



Time

1. Select **[Time]** from the main screen to access the Time settings screen.



2. Access the **Date** pull down menu and choose the correct value.
3. Access the **Time** pull down menu and choose the correct value.
4. Access the **Time Zone** pull down menu and choose the correct value.



5. Select  to return to main menu screen.

Panel Adjustment

Control the unit through the stylus by touching/writing on the screen. If the system cannot correctly identify your stylus' input, please run through the screen calibration procedure.

1. From the settings window, select **[Panel Adjustment]** to start the screen calibration procedure.



2. Use the stylus and touch the cross at the center of the screen once.
3. Touch the cross in the second position once.
4. Touch the cross in the third position once.
5. Continue the calibration by touching the cross.
6. The setting page will return when stylus adjustment is finished.

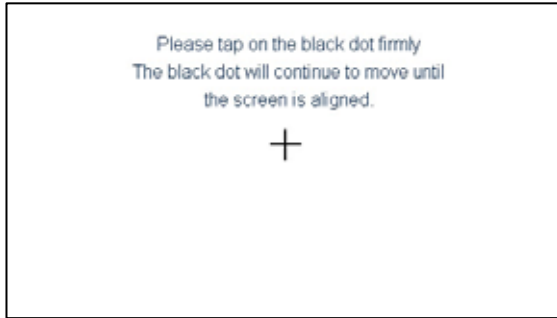

Reset GPS

1. Select **[Reset GPS]** from the main screen to access the **GPS** settings screen.



2. Select the “YES” icon to start the GPS reset procedure.
3. Select the “NO” icon to return to the main “Setting” screen.



4. The following information is for "GPS reset fail!"



5. The following information is for "GPS reset OK!"



Version

1. Select **[Version]** from the main screen to access the **Version** screen.



2. The screen display will show the version information.

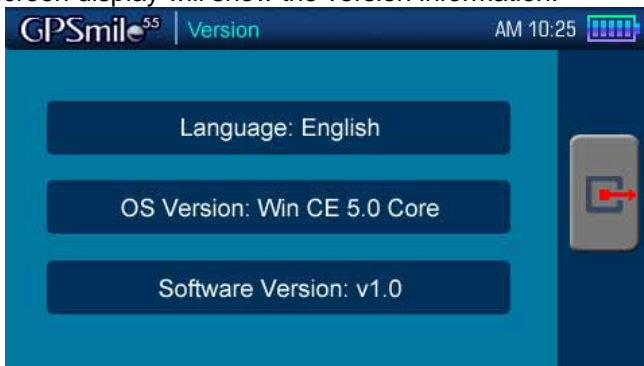

Bluetooth

1. Select **[Bluetooth]** from the main screen to access the **Main Menu** screen.



2. Click the **[Setup]** icon to access the **Bluetooth Setup** screen.



3. Click the **[Search Phone]**, you will see the search screen.
(Before you click on Search Phone, make sure the Bluetooth is enabled on your handset.)

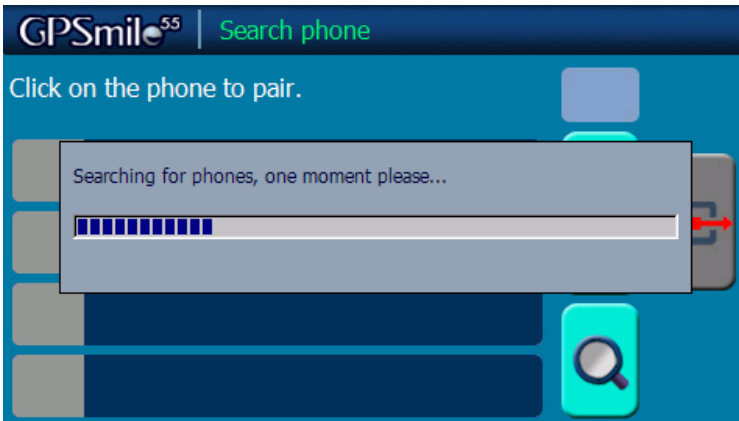

4. After the phone searching is done, you'll see a phone model list.
Click on the one you'd like to use.

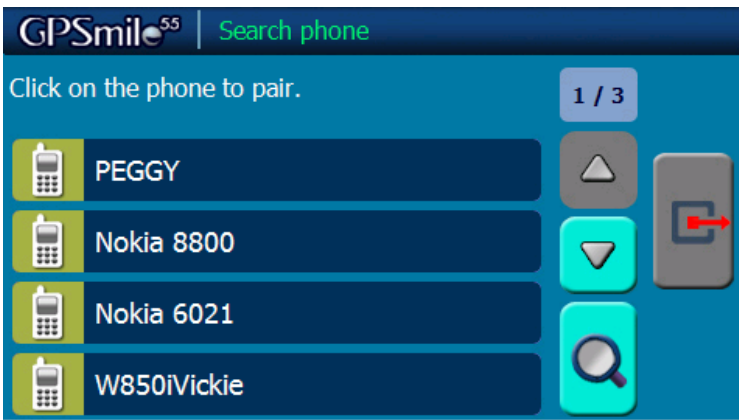

5. Click **[Pair]** to start the pairing process.
(During the pairing process, if your handset requires you to specify a password, please enter "1234".)

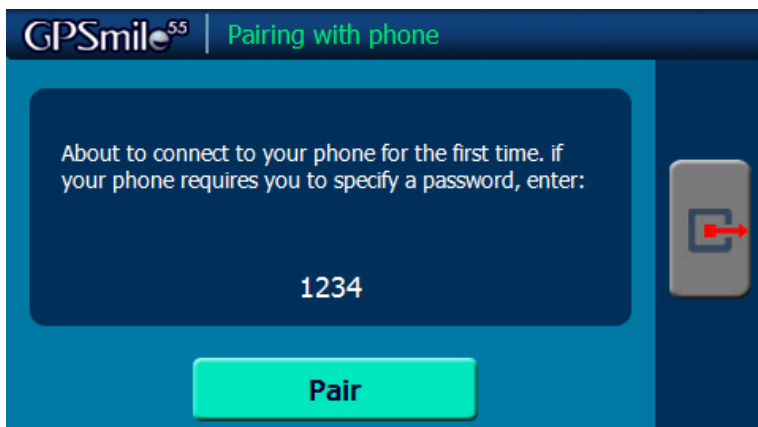

6. When the connection is established, you can click  to return to the **Main Menu** and start using Bluetooth PhoneLink.



Bluetooth PhoneLink

On the **Main Menu**, you can see the following icons: **[Call log]**, **[Message]**, **[File Transfer]**, **[Hands-free]**, **[Setup]**, and **[Exit]**. Click on the icon to enter and operate the function.



Call Log:

1. Click on **[Call log]** icon and wait for the call log transferring.
2. Click the phone number on the list to view the detailed information of that call.
3. Click on the button below to make the call.

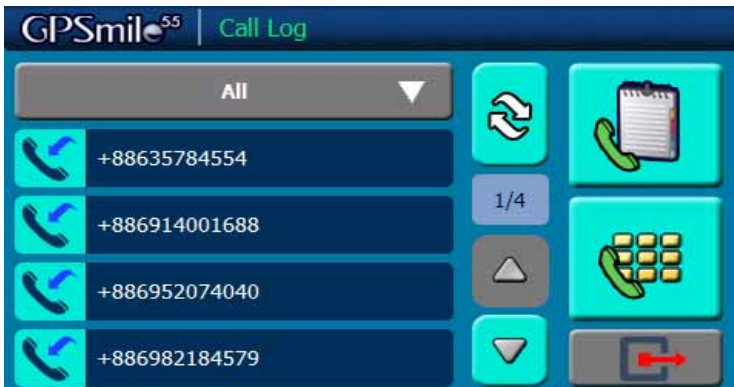

Phonebook:



1. Click **phone book icon** to view the contacts list saved in SIM card/handset.

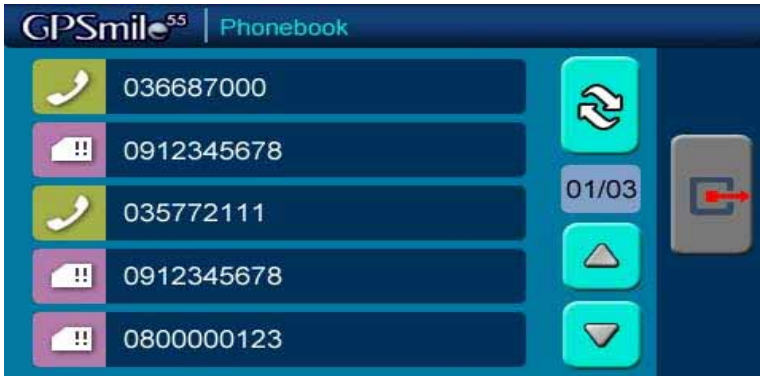

2. Click on the **contact's name** to make a call.
(If the contact you selected has more than one number saved, then click on the number you'd like to reach.)





3. To hang up the call, just click on the hang-up button.
4. **Up/down**: click on **Up/down** button to view the previous/next page.

Dial Pad:

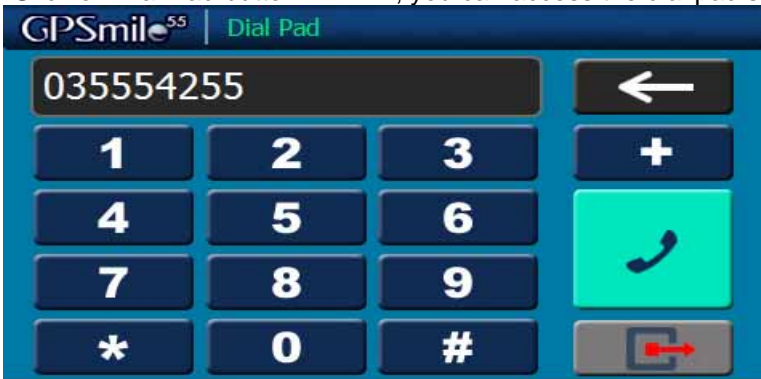

1. Click on Dial Pad button , you can access the dial pad screen.



2. Dial up the phone number and then click on the  button to make a call.
3. Click on **Backspace** button  to delete the number you've entered.

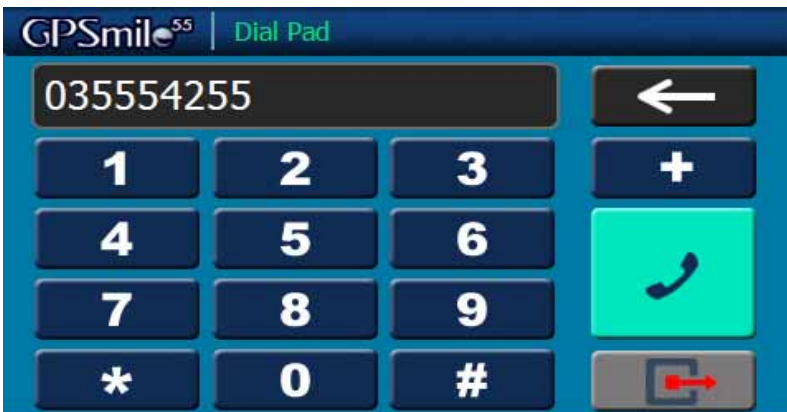

Refresh: click on **Refresh** button to refresh your call log data.



Exit: click  to go back to the previous screen.

Message:

1. Click on **[Message]** to view your SMS list.
2. Click on each message to see the content.

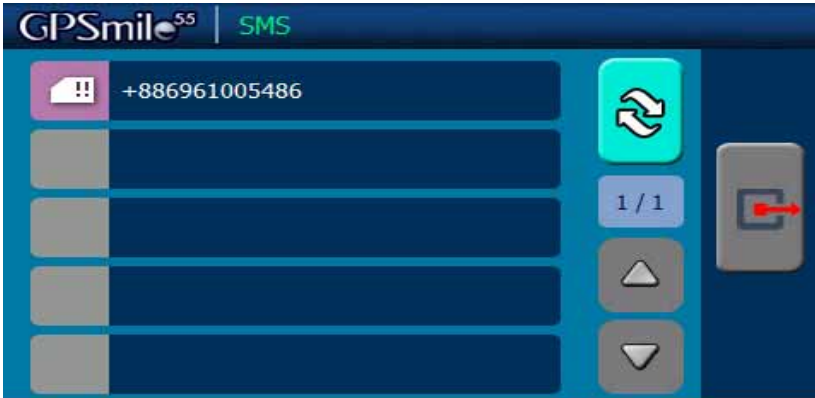

Refresh: click on **Refresh** button to refresh your call log data.

Up/down: click on **Up/down** button to view the previous/next message.

Exit: click **Exit** to go back to the previous level.

File transfer

You can import media files (photos, MP3, etc) from the handset through the Bluetooth function.

1. Click on File Transfer to open the File Manager, you can view the media files you've saved in your handset or transfer them.



Transfer: click on the file you'd like to transfer, and then click the **Transfer**

button  to start transferring.

Up/down: click on **Up/down** button  to view the previous/next page.

Exit: click **Exit button**  to return to the main menu screen.

Hands-free

1. Uncheck the checkbox to turn off the hands-free function.

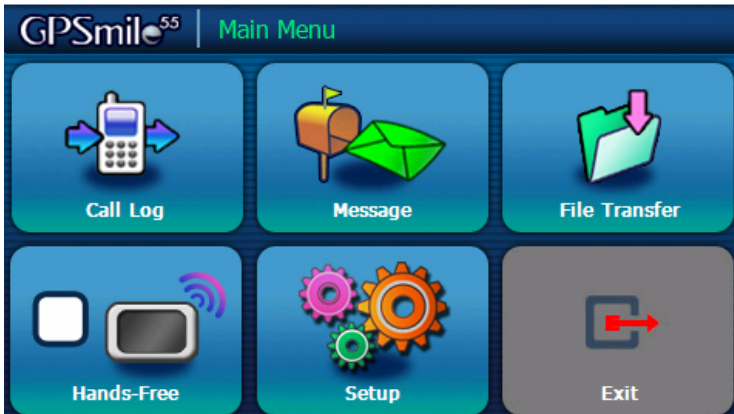

2. Check the checkbox to turn on the hands-free function.



With the hands-free function on, you can make hands-free calls through your mobile phone, accept incoming calls through the Navigator touch screen, or use auto-answer to pick up the calls.

Setup

Click **[Setup]** to open the Bluetooth setup screen.

Phonebook:

Click **Phonebook** to open the phonebook setup. Here you can adjust your phonebook settings by checking/uncheck the checkboxes.

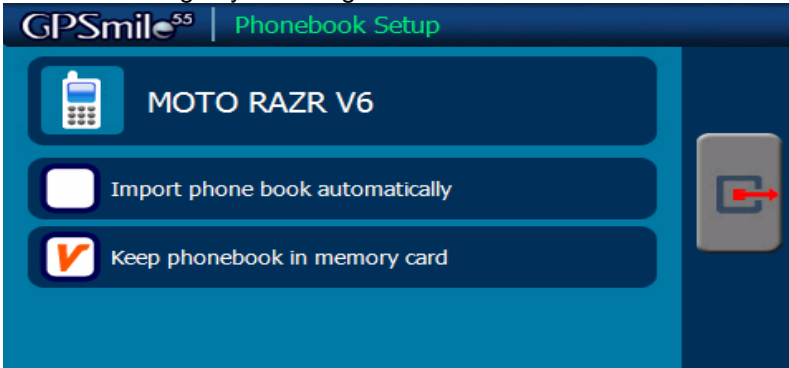

Exit: click **Exit**  to return to the previous level.

Message:

Click **Message** to open the SMS setup. Here you can adjust your SMS settings by checking/uncheck the checkboxes.



Exit: click **Exit**  to go back to the previous level.

Startup Message

Under the settings window, check the **Warning Voice** to / (check / uncheck); if you would like the startup message is to be broadcast.



Click Voice

Under the setting windows, check the click voice to / (check/uncheck) to enable / disable the click voice.

Hot Key

Press the [Hot key] to enter the “Volume” and ”LCD Brightness” screen.



1. Control the volume directly with the “speaker” icon. There are four levels of volume.

Select the “MUTE” icon to mute the Volume.



2. Control the LCD Brightness with “light bulb” icon. There are four levels of brightness.

Select the “AUTO” icon and the LCD Brightness will be kept as a standard value.



Using the CD

Troubleshooting

System reset

It will only be required to reboot the system under extremely few circumstances. Reset your system if the following situations occur:

1. You experience heavy lag while refreshing a screen or operations, which results in an inoperable system.
2. Cannot turn off the system with the power button.
3. No response from a selection made on the screen.
 - Switch the system power off and then switch it back on.



System Power switch

- The system will immediately reset.
- You will now see the main screen and the system is ready for use.



Quick Troubleshooting

Power	Cannot startup	Insufficient battery charge. Please connect to the adapter and restart the system.
Screen	No screen displayed	If the system does not respond after powering up, try the following: 1. Connect adapter, restart system. 2. Reset system.
	Display speed is too slow	1. Check if the battery is low on power. 2. Reset system.
	Screen has no response	Reset system.
Navigation	GPS cannot display my current location	Make sure your current location is not obstructed by buildings or other interferences.

Normal Care and Maintenance

To ensure the unit's normal operation and extended life span, please note the following while using and storing:

Keep dry

This product is not waterproof. If it comes into contact with water or is submerged into water, it will seriously damage the components and result in irreversible damages.

Do not drop the unit

A serious damage may be caused if it is violently impacted or shocked.

Avoid sudden temperature changes

Condensation may occur when entering a warm room on a cold day. To prevent condensation from damaging the unit, please place it into an airtight plastic bag before exposing it to sudden temperature changes.

Keep away from strong magnetic fields

When using or storing, please keep away from strong electromagnetic/radioactive or magnetic field equipment.

Operating temperature

The products operating temperature is between 0°C ~ 40°C. Please do not operate it under extreme temperatures.

Avoid exposure to sunlight

Please avoid long periods of sunlight or exposure to high temperatures.

Using the stylus

The LCD screen is easily scratched. Please only use the stylus for operation. Do not use any other sharp objects on the screen to avoid damaging the LCD screen.

Cleaning the screen

Use a soft clean cloth to wipe the screen. Do not use ordinary tissue to wipe the screen.

Do not disassemble

Please do not disassemble the product. This may void the warranty and damage the unit.

Storage

For storage, keep the unit in a dry box.

Please do not keep the product in the following environments:

1. Unventilated and humid locations.
2. In a car window that is exposed to excessive amounts of sunlight.
3. In an environment where humidity is over 90%.

Appendix

Specifications

Integrated GPS Receiver	20 parallel channels
Acquisition Time	Reacquisition : 0.1 sec. Hot start : 1 sec. Warm start : 38 sec. Cold start : 42 sec.
Accuracy	Position: 10 m. for 90% Velocity: 0.1 m/s
GPS antenna	Built-in patch antenna
Handheld Software (Pre-loaded)	Companion CD: Adobe Acrobat Reader® for Pocket PC - PDF file viewer GPSmile 55 Handheld Manual
Processor	Samsung S3C2440A 400 MHz.
Operating System	Microsoft Windows CE. Net 5.0 Core Version
Memory	64 MB Flash 64 MB SDRAM
Weight	<190 g
Size	121.4 (L)x80.5 (W)x18~25 (H) mm
Car Holder / Charger	Input voltage: 10~30V, 1.3A max. Output voltage: 5.4V/1.2A
Battery	Rechargeable 1150 mAh Li-Ion Battery Battery life: 3 ~ 5 hrs
Extension Slot	SD
Display	4.3" (16:9) TFT LCD with touch screen 95.04(H)*53.86(V) mm 480 x 272 pixels 16 M colors
LED	Orange/Green LED for battery charging status
Audio	Built-in speaker. Software volume control. 3.5mm headphone jack
Temperature	Operation: 0°C ~ 40°C Storage: -20°C ~ 60°C
Humidity	Operation: 0%~90%

	Storage: 0%~90%
USB	USB 1.1 mini USB Connector for USB client & DC power in
Backlight Adjustment	Auto Backlight Adjustment
Software	MP3 Photo Video eBook
Bluetooth (Optional Function)	Hands-Free Calling Headset SMS Receiver File Transfer
TMC (Optional Function)	TMC Traffic Receiver
Flash Memory (Optional Function)	Built-in 2G Flash

Federal regulations

This device complies with Part 15 of the FCC Rules. Operation is subject to the following two conditions: (1) this device may not cause harmful interference, and (2) this device must accept any interference received, including interference that may cause undesired operation.

FEDERAL COMMUNICATIONS COMMISSION INTERFERENCE STATEMENT

This equipment has been tested and found to comply with the limits for a Class B digital device, pursuant to part 15 of the FCC Rules. These limits are designed to provide reasonable protection against harmful interference in a residential installation. This equipment generates, uses and can radiate radio frequency energy and, if not installed and used in accordance with the instructions, may cause harmful interference to radio communications. However, there is no guarantee that interference will not occur in a particular installation. If this equipment does cause harmful interference to radio or television reception, which can be determined by turning the equipment off and on, the user is encouraged to try to correct the interference by one or more of the following measures:

- Reorient or relocate the receiving antenna.
- Increase the separation between the equipment and receiver.
- Connect the equipment into an outlet on a circuit different from that to which the receiver is connected.
- Consult the dealer or an experienced radio/ TV technician for help.

CAUTION:

Any changes or modifications not expressly approved by the grantee of this device could void the user's authority to operate the equipment.

This equipment is in compliance with the essential requirements and other relevant provisions of directive 1999/5/EC.

RF exposure warning

This equipment must be installed and operated in accordance with provided instructions and the antenna(s) used for this transmitter must be installed to provide a separation distance of at least 20 cm from all persons and must not be co-located or operating in conjunction with any other antenna or transmitter. End-users and installers must be provide with antenna installation instructions and transmitter operating conditions for satisfying RF exposure compliance.