

GPSmile 61CS

Navigation System

Product User Manual

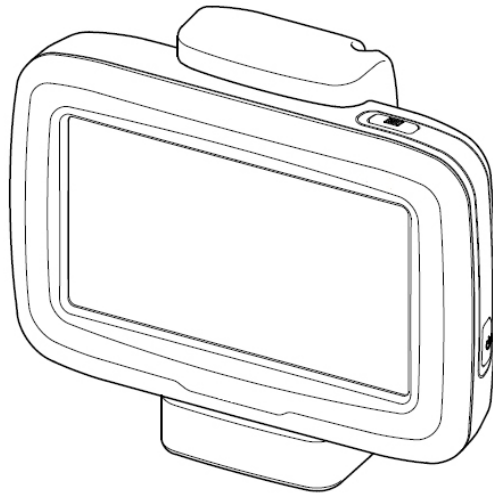

Registered info

HOLUX and GPSmile are trademarks of HOLUX Technology, Inc.
All other trademarks belong to registered companies.

Note

- The contents of this manual will be modified without further notice.
- The operation temperature for the product is between -10°C ~ 50°C .
- Operating or recharging in an environment with a temperature over 50°C might cause the system to malfunction. However, this should be considered a normal phenomenon. Please do not operate under

Safety Precautions

- The device should only be used with the supplied batteries.
- About the battery
 1. A Lithium battery is built into the device. To prevent fire or skin burns, do not disassemble, pierce, impact, or expose the battery to fire. The battery will crack, explode, or release dangerous chemicals if placed in a fire.
- Important instructions
 1. Note: Replacing with an incorrect battery may result in an explosion. When disposing of the battery, follow the instructions. The replacement battery must be a factory approved original.
 2. Regulations must be observed when recycling or disposing of batteries.
 3. The battery should only be used in this device.

Warranty Statement

- This warranty applies to parts and services that are manufactured and sold through Holux Technology Inc. The local area covered is Taiwan; the warranty length is one year from date of purchase (starting from the date on the sales receipt). Under normal user operation, Holux Technology provides free repair services.
 - ❖ After repair, the replaced parts are the properties of Holux Technology Inc.
- Holux Technology is not responsible for providing repairs or replacements of any software; Holux Technology does not provide any warranty service for third party software/hardware.
- Important instructions

Note: This warranty does not cover damage or malfunction from the below causes: unauthorized disassembly/modification of unit, abuse or incorrect usage, accidental and other unpreventable causes, operation under variables mentioned that are different from those in this product user manual, using parts not made or sold by Holux Technology, or repairs done by anyone other than Holux Technology and authorized retail/service providers.

- ❖ Expendable parts are not covered in the warranty.
 - ❖ Holux Technology is not responsible for any program, data, or portable storage media damages or loss. Please contact your local Holux Technology authorized service provider to learn more about geographical limitations, proof of purchase requests, response time agreements, and other specific maintenance service requests.

Technical Support

- If there are any questions regarding the use of this product, please log on to the website www.holux.com and see the FAQ.

Maintenance Service

HOLUX Technology, Inc.

+886-3-6687000

Web Site: www.holux.com

or

Contact your nearest dealer, for further support.

HOLUX Technology, Inc.

www.holux.com

Table of Contents

Safety Precautions	ii
Warranty Statement	iii
Technical Support.....	iv
Maintenance Service.....	iv
Preface	1
Precautions and Notices.....	1
<i>Copyright</i>	2
<i>Important Notice</i>	2
Product Specification.....	3
<i>Tools</i>	5
<i>Bluetooth Profile support</i>	5
<i>CE/FCC</i>	6
First time use	7
<i>Package Contents</i>	7
<i>Motorbike RAM Mount Accessory</i>	8
Basic Operation	9
<i>Introduction</i>	9
Front View	9
Rear View	9
<i>Accessories</i>	10
Cradle.....	10
Getting Started.....	11
<i>Install Cradle</i>	11



<i>Remove Cradle.....</i>	<i>13</i>
<i>Install motorcycle RAM mount.....</i>	<i>14</i>
Install/ Remove Battery.....	19
<i>Device connection Diagram</i>	<i>20</i>



Preface

We appreciate your purchase of the HOLUX car navigation.

Please read all instructions thoroughly for a full understanding of the products' features.

Precautions and Notices

- For your own safety, do not operate the controls of the product while driving.
- Use this product prudently. The product is intended to be used only as a navigation aid. It is not for precise measurement of direction, distance, location or topography.
- The calculated route is for reference only. It is the user's responsibility to follow the traffic signs and local regulations along the roads.
- GPS is operated by the United States government, which is solely responsible for the performance of GPS. Any change to the GPS system can affect the accuracy of all GPS equipments.
- When you are inside a tunnel or building, GPS positioning is not available.
- A minimum of 4 GPS satellite signals is needed to determine current GPS position. Signal reception can be affected by situations such as bad weather or dense overhead obstacles (e.g. trees and tall buildings).
- Other wireless devices in the vehicle might interfere with the reception of satellite signals and cause the reception to be unstable.

Copyright

Without the written consent of HOLUX Technology, Inc, this manual, including the product and the software, may not be duplicated, transmitted, recorded or saved on storage devices. Furthermore, it shall not be translated under any circumstances into any other languages.

Copyright ©2012 HOLUX Technology, Inc. All rights reserved.

Important Notice

Please thoroughly read this manual of operating instructions and explanations. Only use original factory approved batteries and accessories to prevent unexpected damage. If the correct procedures were not followed for operation or incompatible accessories were connected, this is a violation of the warrantee agreement and will automatically void the warrantee. This may also cause personal safety issues.

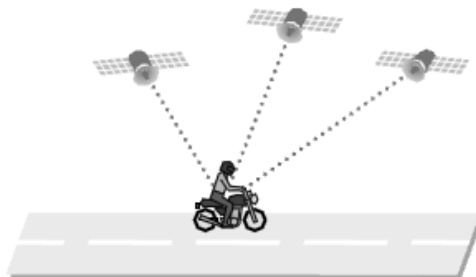

Product Specification

Item	Description
Dimension	Typ. 130(L)x 92.2(W)x29(H) mm
Weight	Typ. 280 g (including battery)
Processor	SiRF Atlas IV 500MHz, ARM11.
Memory	FLASH: 4GB NAND Flash Memory(MLC) RAM: 128MB DDR1(32bit) 32KB EEPROM
Audio	2S CODEC Built-in Speaker (8 Ohm/2W)
Display	480 RGB (W) x 272(H) dots, 4.3" Blanview LCD 0.198 mm dot pitch RGB vertical stripe LCM colors: 65536 colors(16 bits) Brightness, Typ. 350 nits
Touch Panel	Activation force 100gf or less 3H hardness
GPS	SiRF 64 Channels, high sensitivity GPS Chipset Internal Patch Antenna 8 directions Average C/No \geq 40dB, 3 highest satellites
Man Machine Interface	Power on/off (Reset function)button x 1 Menu button x 1
USB Interface	Mini USB 2.0 connector

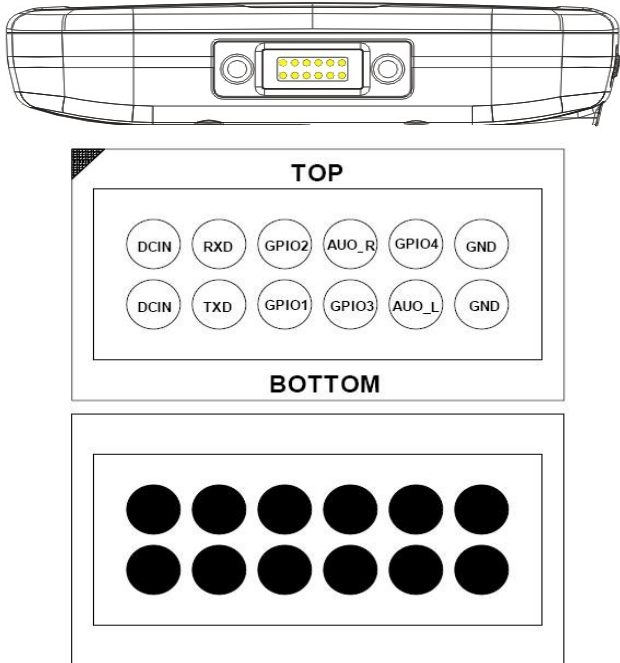
I/O Interface	<p>Support 12pin I/O board for motorcycle cradle</p> 
Card Slot	Micro SD Slot x 1, Micro SD™, Support 8GB(Max.), SD standard host spec (2.0) compatible
Battery	Rechargeable Li-Ion battery 1050mAh Normal voltage: 3.7V Charger voltage: 4.2V
Power management	Suspend current typical 6mA
Power Requirement	5.2V(+)-0.25V
Bluetooth module	NFORE, NF 2303 Bluetooth firmware version: H10620-V118R8(no noise gate) Class 2: 0.25mW ~ 2.5mW
Dustproof/Waterproof	IP-57

B. Software Spec.		
B. 1	Tools	Support upgrade OS&AP via Micro SD Card
		Support Active Sync or Mass Storage via mini USB interface
B. 2	Bluetooth Profile support	HSP (Headset Profile)
		Provide nFore Middleware for development
		A2DP(Advanced Audio Distribution Profile)
		Provide nFore Middleware for development
		Class 2

C. Standard Accessories		
C. 1	Car charger	Input : 10.8V~30V; Output : 5V/2A
C. 2	Motorbike Charger	12V/5.3A
C.3	Cradle with power	Quickly install design (with 12pin probe connector) IP-57
C.4	USB Cable	Transfer data from PC to GPSmile61CS
C.5	Cable quick guide Tool DVD Gift box	
C.6	UART Cable	Don't apply to Taiwan market. Only apply to foreign user, such as European.

D. Optional Accessories		
D. 1	Helmet speaker	φ 3.5phone jack 32 ohm 30mW(MAX_ 50mW)
D. 2	Control SW	Volume control button and up/down button IP-57(Cable connector: water resistance)

E. Certification		
E. 1	CE/FCC	FCC ID: RJI-NAV61CS

PND Product Performance		
F.19	Long-term Receive	Test Place: HOLUX
		Test Environment: Open sky at HOLUX building
		Criteria: Average C/N \geq 40 dB, 3 highest satellites Position drift range \leq 15 m
F. 20	Long-term Cold Start	Test Place: HOLUX
		Test Environment: Open sky at HOLUX building
		Criteria: TTFF \leq 43s

PND Battery Life		
F. 21	Battery charge test	Test Place: HOLUX Reliability Lab
		Test Equipment: Use MV200 mobile corder, TopWard DC Power Supply 3303D and charging test board
		Criteria: Charging for 3.5 hours to full capacity No functional failures allowed after charging.
F. 22	Battery Discharge test	Test Place: HOLUX Reliability Lab
		Test Equipment: Use MV200 mobile corder, 3302C electronic load mainframe and test board
		Criteria: Discharging for best loading time 4 hours to show the low battery alert message Discharging for full loading time 2 hours to show the low battery alert message No functional failures allowed after discharging.

First time use

Package Contents

Your product should include the following accessories:

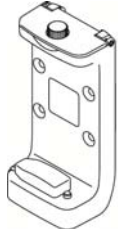
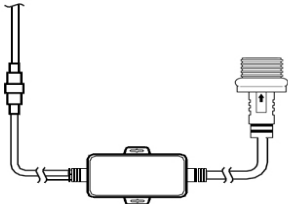
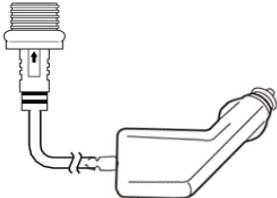
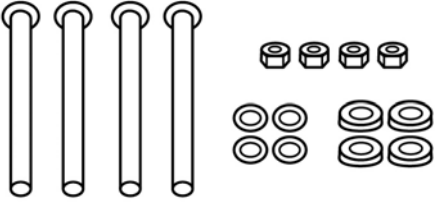
	
GPSmile 61CS	Cradle
	
DC-DC Adapter	Car Charger
	
Screw kit (main accessory)	

Motorbike RAM Mount Accessory

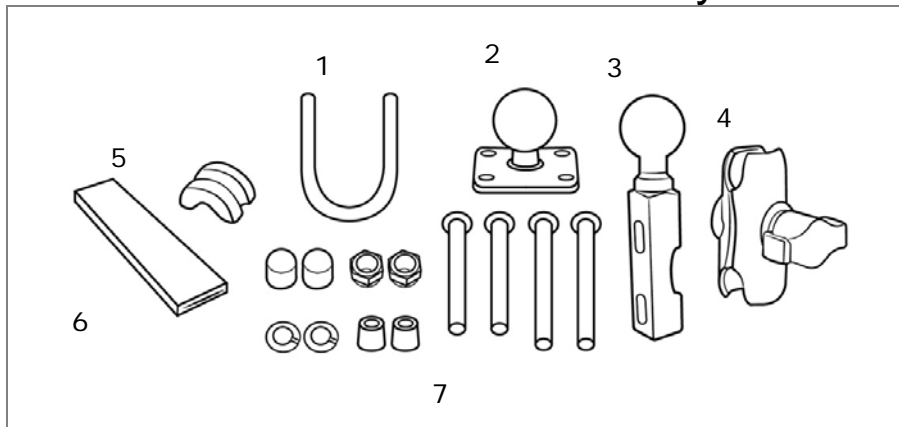

1. U-bolt Rail Mount	2. Device Base Plate
3. Motorcycle Handlebar Base	4. Double Socket Arm
5. Plastic Cushion	6. Square Rubber Neck
7. Screw kit (bolts, washers, spacers, nuts for motorbike RAM mount)	

Basic Operation

Introduction

Front View

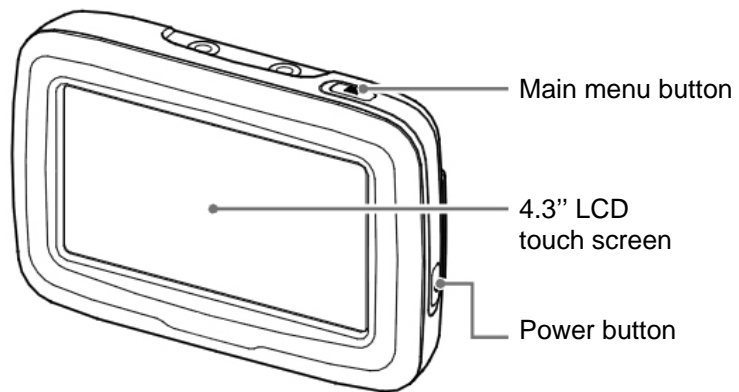

Rear View

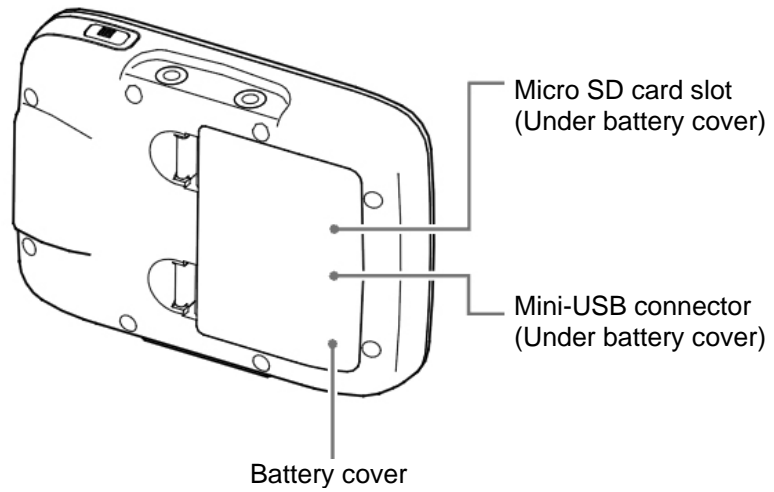

Accessories

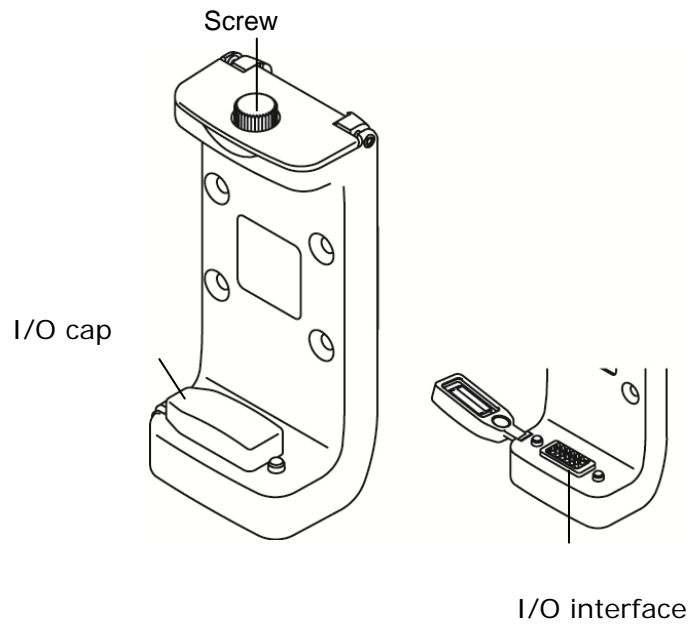

Cradle

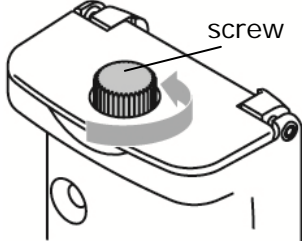
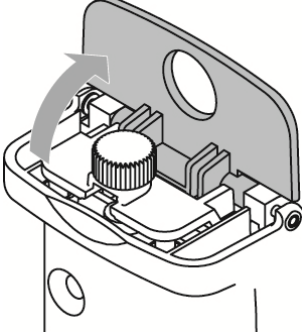
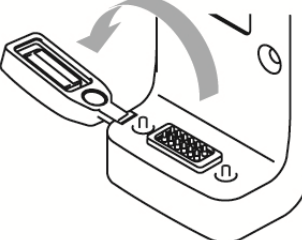
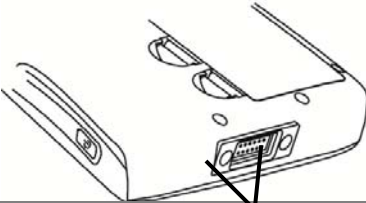

Getting Started

Install Cradle

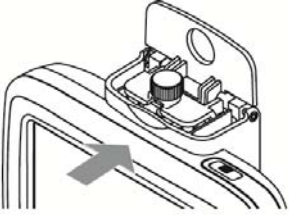
<p>1. Loosen the screw of cradle top.</p>	 <p>screw</p>
<p>2. Open the cap of cradle top.</p>	
<p>3. Open the I/O cap.</p>	
<p>4. Insert the device concave into the cradle tabs.</p> <p>※ Please make sure the I/O pin is not wet or dirty.</p>	 <p>Concave</p>

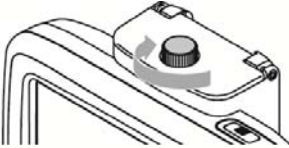
	
<p>5. Slide the GPS into the cradle fitting holes to secure.</p>	
<p>6. Make sure the device is tightly fixed with the bracket, and gently close the cradle cap.</p>	
<p>7. Tighten the screw.</p>	

Remove Cradle

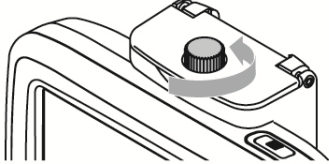
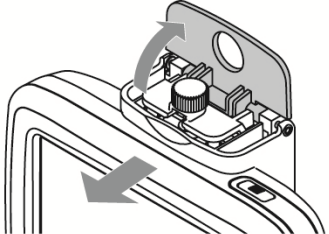
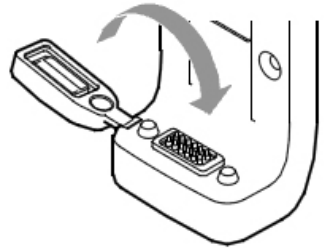
<p>1. Loosen the screw of cradle top.</p>	 A line drawing of the top of a cradle. A circular screw is shown being turned counter-clockwise, as indicated by a curved arrow above it.
<p>2. Open the cradle cap and remove the device.</p>	 A line drawing of the cradle with the top cap lifted. A curved arrow shows the cap being lifted away. A straight arrow points downwards from the cap, indicating the removal of the device.
<p>3. Restore the I/O cap</p>	 A line drawing of the I/O cap being placed back onto the cradle's port. A curved arrow shows the cap being rotated into its closed position.

Install motorcycle RAM mount

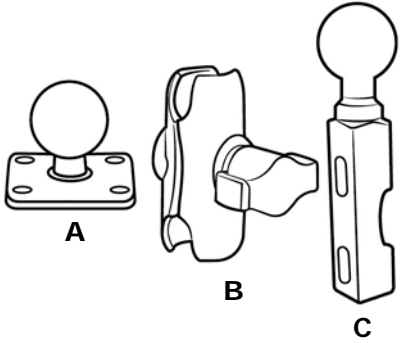
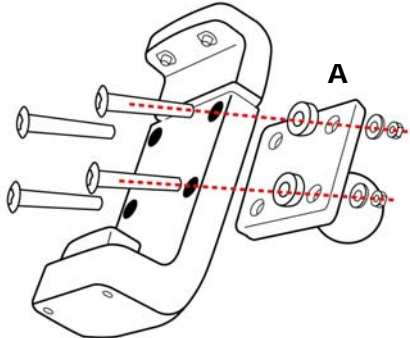
<p>「A」 Device Base Plate</p> <p>「B」 Double Socket Arm</p> <p>「C」 Motorcycle Handlebar Base</p>	 <p>The diagram shows three parts: A is a rectangular plate with a circular hole in the center and two smaller holes on either side. B is a curved arm with two sockets. C is a vertical handlebar base with a spherical top and a rectangular body with two slots.</p>
<p>Thread the bolts and nuts (screw kit of main accessory) to attach the 「A」 to cradle.</p> <p>Tighten the nuts to secure the 「A」.</p>	 <p>The diagram shows the double socket arm (B) being attached to the device base plate (A). Two bolts are shown passing through the holes in A and into the sockets of B. Red dashed lines indicate the alignment of the bolts. The label 'A' is placed near the base plate.</p>

There are two solutions to install Motorcycle RAM mount:
「motorcycle handlebar」 or 「brake/ clutch」 .

**Method 1:
To install at handlebar
with U-bolt**

(1) 「U-bolt」 slip into
「Square rubber
Neck」 to protect the
handlebar from
scratching.

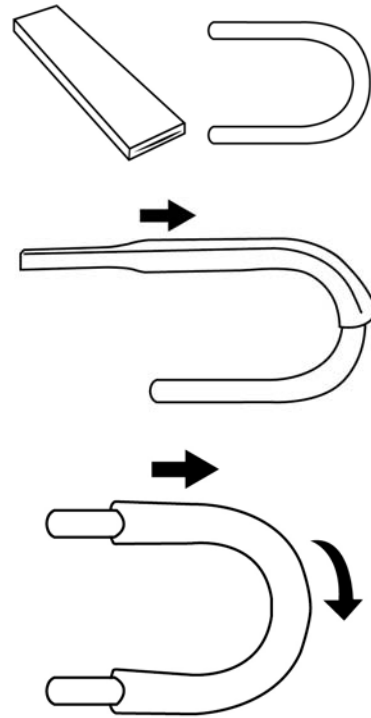

- (2) Place the U-bolt around the handlebar, and thread the ends through the 「C」.
- (3) To avoid slip, place 「plastic cushion」 between 「U-bolt」 and handlebar.
- (4) Tighten the nuts to secure the base. Do not over tighten.

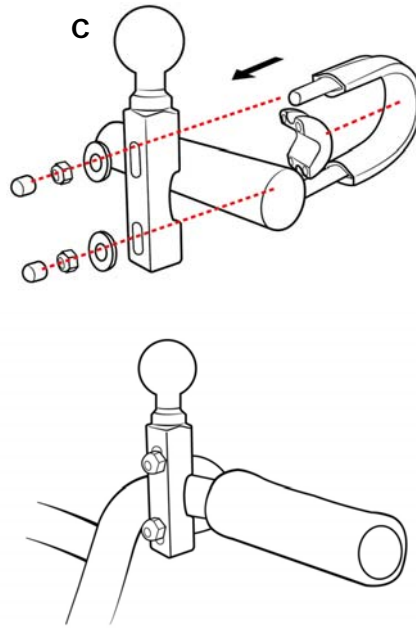

**Method 2:
To install at
clutch/brake clamp
bracket**

- (1) Remove the two factory bolts on your clutch/brake clamp bracket.
 - (2) Thread the new bolts (Screw kit of RAM mount) through the washers, 「C」, spacers, and clamp bracket.
 - (3) Tighten the bolts to secure the base.
- ※ There are long (QTY.2)

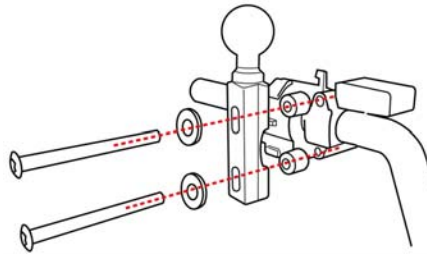

and short (QTY.2) bolts in RAM mount screw kit, please select that you need to install.

After install the 「C」 at proper location, install other components.

Attach the ball of the 「C」 with one side of 「B」.

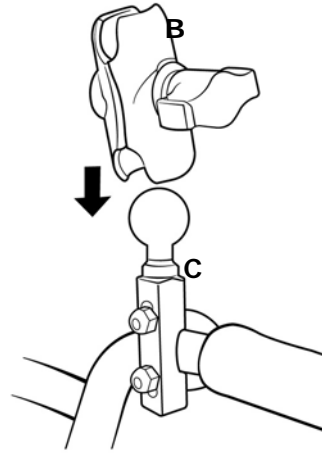

Align the ball of the 「A」 with the other side of 「B」.
Tighten the knob slightly.

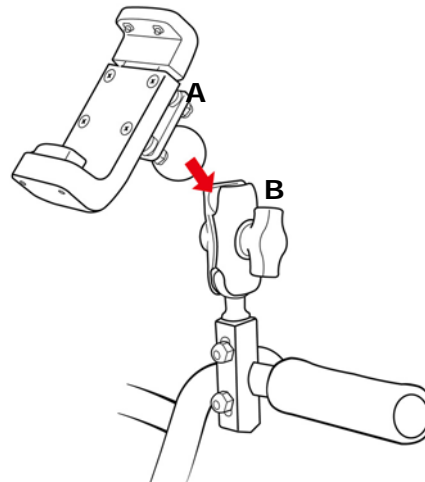

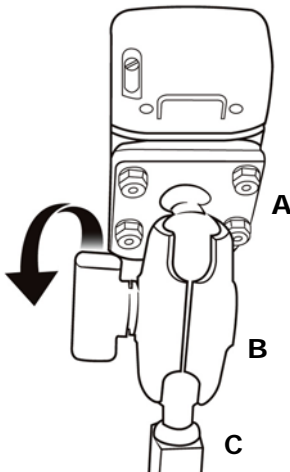
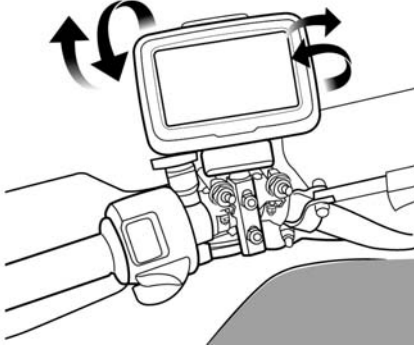

<p>(1) Adjust 「A」 and 「C」 for better viewing and operation.</p> <p>(2) Tighten the knob of 「B」 to secure the mount.</p>	
<p>For your riding safety, please loosen the knob of 「B」 to adjust the screen for better viewing and operation.</p> <p>After confirm the viewing, tighten the knob of 「B」 to secure the mount.</p> <p>Remind you: do not operate the device when you ride.</p>	

※ Note:
 Damage due to modifications, improper installation, road hazards or accident, are not covered. HOLUX does not liable for any injury, loss, or damage, direct or consequential, arising out of improper installation, or inability to use product.

Install/ Remove Battery

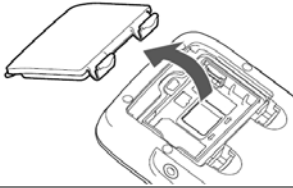
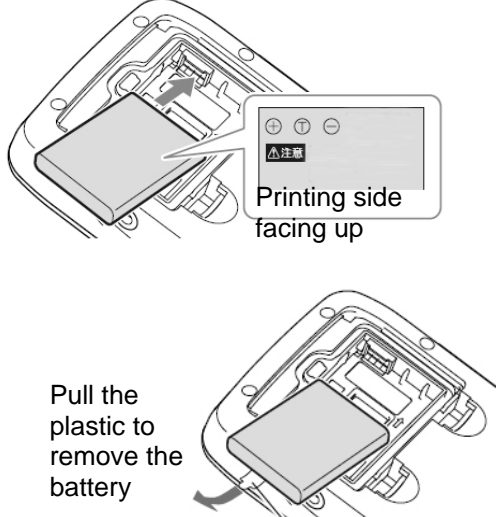
Please make sure the battery is installed before using the device.

1. Open the battery lid	 A line drawing of the battery compartment with the lid being lifted away from the device. A curved arrow indicates the direction of movement.
2. Install or Remove the battery	 Two diagrams illustrating the battery process. The top diagram shows a battery being inserted into the compartment, with a callout box containing a warning symbol and the text "Printing side facing up". The bottom diagram shows the battery being pulled out by a plastic tab, with the text "Pull the plastic to remove the battery".
3. Restore the battery lid.	 A line drawing of the battery compartment with the lid being placed back onto the device. A curved arrow indicates the direction of movement.

Device connection Diagram

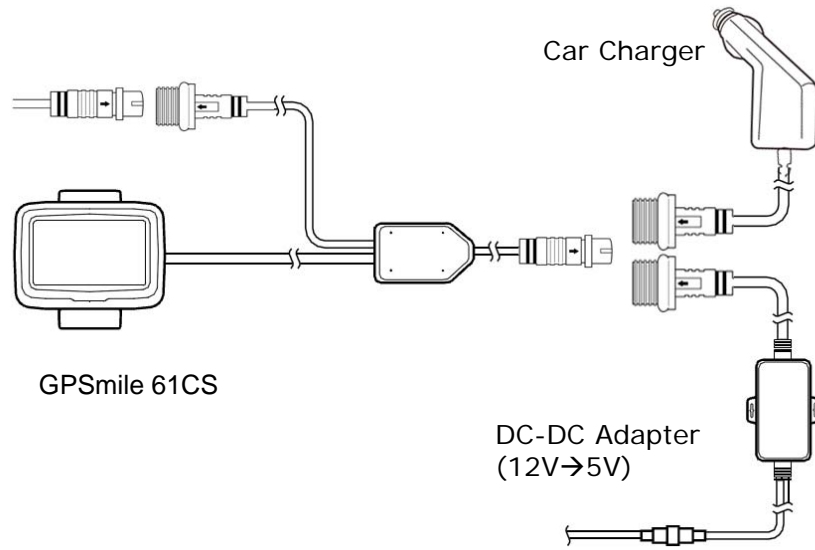

FCC Notices

This device complies with Part 15 of the FCC Rules. Operation is subject to the following two conditions: (1) this device may not cause harmful interference, and (2) this device must accept any interference received, including interference that may cause undesired operation.

CAUTION: Change or modification not expressly approved by the party responsible for compliance could void the user's authority to operate this equipment.

This equipment has been tested and found to comply with the limits for a Class B digital device, pursuant to Part 15 of the FCC Rules. These limits are designed to provide reasonable protection against harmful interference in a residential installation. This equipment generates, uses and can radiate radio frequency energy and, if not installed and used in accordance with the instructions, may cause harmful interference to radio communications. However, there is no guarantee that interference will not occur in a particular installation. If this equipment does cause harmful interference to radio or television reception, which can be determined by turning the equipment off and on, the user is encouraged to try to correct the interference by one or more of the following measures:

- Reorient or relocate the receiving antenna.
- Increase the separation between the equipment and receiver.
- Connect the equipment into an outlet on a circuit different from that to which the receiver is connected.
- Consult the dealer or an experienced radio/TV technician for help.

CAUTION:

Any changes or modifications not expressly approved by the grantee of this device could void the user's authority to operate the equipment.

RF exposure warning

This equipment must be installed and operated in accordance with provided instructions and the antenna(s) used for this transmitter must be installed to provide a separation distance of at least 20 cm from all persons and must not be co-located or operating in conjunction with any other antenna or transmitter. End-users and installers must be provide with antenna installation instructions and transmitter operating conditions for satisfying RF exposure compliance."