

HP iPAQ Product Guide



© Copyright 2007 Hewlett-Packard
Development Company, L.P.

HP iPAQ products are powered by
Microsoft® Windows Mobile® 6.0 Classic
with Messaging and Security Feature Pack.

Microsoft Windows, the Windows logo,
Outlook, and ActiveSync/Windows Mobile
Device Center are trademarks of Microsoft
Corporation in the U.S. and other countries.



SD Logo is a trademark of its
proprietor.

Bluetooth® is a trademark owned by its
proprietor and used by Hewlett-Packard
Development Company, L.P. under license.

All other product names mentioned herein
may be trademarks of their respective
companies.

Hewlett-Packard Company shall not be liable
for technical or editorial errors or omissions
contained herein. The information is
provided "as is" without warranty of any kind
and is subject to change without notice. The
warranties for Hewlett-Packard products are
set forth in the express limited warranty
statements accompanying such products.
Nothing herein should be construed as an
additional warranty.

This document contains proprietary
information that is protected by copyright. No
part of this document may be photocopied,
reproduced, or translated to another
language without the prior written consent of
Hewlett-Packard Development Company,
L.P.

First Edition August 2007

Document Part Number: 456222-001

Table of contents

1 Register your HP iPAQ

2 Box contents

3 Components

Front panel components	3
Top and bottom panel components	4
Left and right side components	5
Back panel components	6

4 Set up your HP iPAQ

Step 1: Remove the battery cover and the battery	7
Step 2: Install the battery and replace the battery cover	8
Step 3: Charge the battery	8
Step 4: Turn on your HP iPAQ	9
Protect your HP iPAQ with a password	9
Find the serial and model number	10
View status icons	10

5 Learn the basics

The Today screen	11
Use TodayPanel Lite	11
Battery saving tips	12
The 5-Way Navigation key	12
Lock and unlock your HP iPAQ	13
Enter text	13
Enter owner information	13
Perform a soft reset	13
View the Operating System (OS) information	14
Change the device name	14
Change the regional settings	14
Adjust the volume	15
Change power management settings	15
Dim or adjust brightness of the backlight	15
Install and remove programs	15
Open and close programs	16
Set alarms and clocks	16
Shortcut menus	16
Display the clock in title bar	17
Create and assign a category	17
Adjust the speed for scrolling through items in a list	17

6 Connections

WLAN	18
WLAN terms	18
Automatically connect to a WLAN network	19
Manually connect to a WLAN network	19
Find an IP Address	20
Delete a wireless network	20
Configure the 802.1x authentication settings	20
Bluetooth	20
Bluetooth terms	20
Bluetooth Manager	21
Bluetooth Phone Manager	21
Connect to a computer via Bluetooth	22
Bluetooth device profiles	22
Create, end, and accept a Bluetooth partnership	23
Rename a Bluetooth partnership	23
Pair and unpair devices	24
Make a device discoverable	25
Connect to a Bluetooth Headset	25
Open Bluetooth settings	25
Authorization to access services	25
Use a passkey or bond	25
Set a Bluetooth shared folder	26
Bluetooth Stack 2.0/EDR	26
Advanced settings	27
Connect to intranet URLs	27
Change an intranet URL	27
Set up proxy server settings	27
Set up a WAP gateway	27
Configure advanced proxy settings	28
Advanced connection settings	28
Set up a VPN server connection	28
Change a connection group name	29
End a connection	29

7 HP Photosmart Mobile

HP Photosmart Mobile	30
Attach a voice note to a picture	30
E-mail a picture	30
View a slideshow	31

8 Messaging

Understand messages	32
Types of folders	32
Synchronize e-mail	33
Set up Messaging accounts	33
Set up e-mail using Exchange server	33
Internet e-mail	34
Receive attachments	35
Send meeting requests	36

Receive meeting requests	36
Create or change a signature	37
Use Messaging	37
Compose and send messages	37
Reply to or forward a message	37
Add an attachment to a message	38
Download messages	38
Download messages from a server	38
Install an online address book	38
Windows Live Messenger	39
Sign in and out of Messenger	39
Send instant messages	40
Change your status	40

9 Calendar

Access calendar	41
Change the display of the work week	41
Set a default reminder for all new appointments	41
Create an appointment	41
Update an appointment	42
Cancel an appointment	42

10 Contacts

Create a contact	43
Delete a contact	43
Change contact information	43
Copy a contact	43
Find a contact	44
Send an e-mail message to a contact	44
Add and remove a picture	44
Use the contact list	45

11 Applications

HP applications	46
HP Help and Support	46
HP iPAQ Setup Assistant	46
HP Asset Viewer	47
Certificate Enroller	47
Manage certificates	48
HP iPAQ Tips	48
HP iPAQ QuickStart Tour	48
HP iPAQ Zip	48
HP Enterprise Mobility Agent	49
Windows Media Player	49
Windows Media Player 10 Mobile	49
Clear the Now Playing list	49
Update a Library	50
MS Office applications	50
Word Mobile	50

Excel Mobile	50
PowerPoint Mobile	51
PDF viewer	51
Games	52
Bubble Breaker	52
Solitaire	52
Internet Explorer	52

12 Notes

Write a note	54
Create a copy of a note	54
Create a voice note	54

13 Storage cards

Storage cards	56
Insert a storage card	56
Remove a storage card	56
View content of a storage card	56

14 Synchronization

Synchronization software	58
Copy files	58
Migrate data from Palm Desktop to Microsoft Windows Mobile 6.0	58
Wireless synchronization cost saving tips	59
Troubleshoot synchronization issues	59

15 Tasks

Set start and due dates for a task	62
Show start and due dates in the task list	62
Set options for displaying tasks on the Today screen	62
Mark a task as completed	62

16 Product specifications

System specifications	63
Physical specifications	63
Operating environment	64

17 Regulatory notices

Federal Communications Commission Notice	65
Modifications	65
Cables	65
Declaration of Conformity for Products Marked with the FCC Logo (United States Only) .	66
Canadian Notice	66
Avis Canadien	66
European Union Notice	66
Products with 2.4–GHz Wireless LAN Devices	68
Battery Warning	68
Battery Recycling	68

Battery Disposal	68
Equipment Warning	69
Acoustics Warning	69
Airline Travel Notice	70
Medical Electronic Equipment	70
Wireless Notices	70
U.S. Regulatory Wireless Notice	70
Canadian Regulatory Wireless Notice	70
Brazilian Notice	70
Japanese Notice	70
Wireless LAN 802.11b Devices	71
Wireless LAN 802.11g Devices	71
Bluetooth Devices	71
Taiwan DGT Notice	71
Korean Notice	71

18 Frequently asked questions

I am having trouble turning on my HP iPAQ. What should I do?	72
I have trouble connecting to the Internet. What should I do?	72
Why does the HP iPAQ operate slowly at times?	72
Why do I see the Today screen layout error message on my HP iPAQ display screen?	72
I have trouble charging my battery. What should I do?	72
I am unable to use the ActiveSync feature. What should I do?	72
My HP iPAQ was not connected during WMDC installation?	73
My HP iPAQ was connected while I was installing but WMDC is not launching after installation?	73
Can I connect for the first time via Bluetooth?	73

19 Guidelines for care and maintenance

Using your HP iPAQ	74
Cleaning your HP iPAQ	74
Carrying or storing your HP iPAQ	74
Using accessories	74

1 Register your HP iPAQ

You need to register your HP iPAQ with Hewlett-Packard to be able to:

- Access support and services, and get the most out of your HP products.
- Manage your profile.
- Sign up for free support alerts, driver notices, and personalized newsletters.

After registering your HP iPAQ, you will receive an e-mail message regarding special offers and promotions. Visit <http://www.register.hp.com> to register your HP iPAQ or update your mail or e-mail address after registration. You are required to enter your user ID and registration password to edit your profile online.

2 Box contents

This illustration depicts the items that come in the box with your HP iPAQ.

 **NOTE:** Box contents might vary by model.

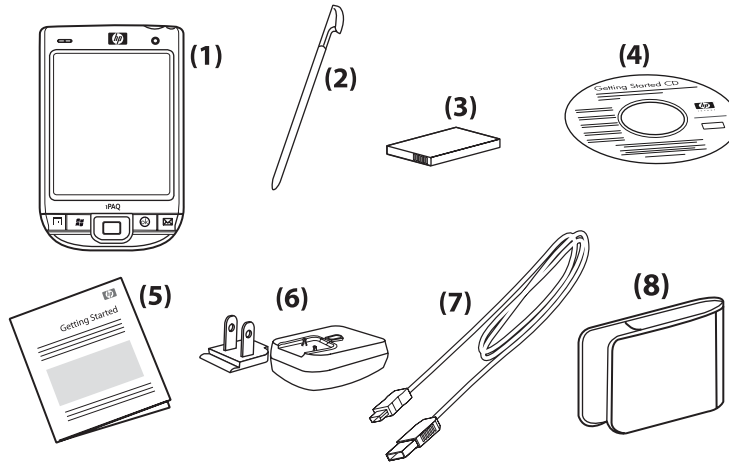

(1)	HP iPAQ
(2)	Stylus
(3)	1200 mAh Li-Ion removable/rechargeable battery
(4)	<i>Getting Started</i> CD with additional software
(5)	HP iPAQ documentation
(6)	AC adapter with interchangeable plug NOTE: The AC adapter might be provided with more than one interchangeable plug, which might not be attached. Attach the correct plug for your country/region.
(7)	Mini-USB synchronization cable
(8)	Slip case

3 Components

 **NOTE:** Not all models or features are available in all countries/regions.

Front panel components

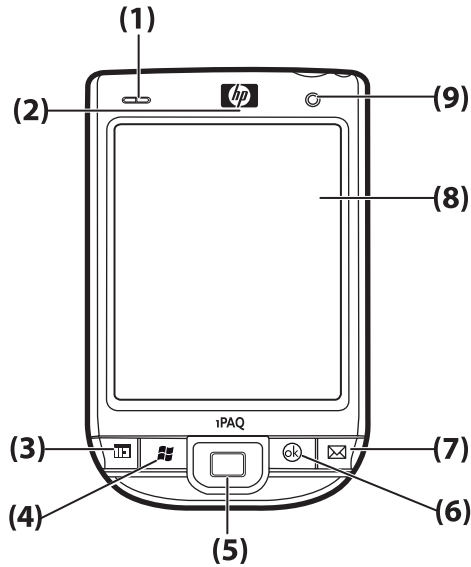

Component		Function
(1)	LEDs	<ul style="list-style-type: none"> • Solid Red – Charging • Solid Green – Full Charged • Off (Red/Green) – No Charging • Flashing Green – One or more notification received • Solid Blue – WLAN or Bluetooth on
(2)	VoIP Receiver	Receives a sequence of voice information, which is converted into digital packets and transmitted over the Internet.
(3)	Application Key 1	Press to launch the Calendar . Press and hold to launch the Contacts list.
(4)	Application Key 2	Press to display the Start menu. Press and hold to access the Today screen.
(5)	5-Way Navigation Key	Use to select items, navigate menus, change feature settings, or play games. Scroll up, down, left, or right by pressing the button in the direction you want to scroll. Release the button to stop the scrolling action. Press the button to select the item highlighted on the screen.

Component		Function
(6)	Application Key 3	Press to select ok or close the running application. Press and hold to switch between the landscape and portrait views.
(7)	Application Key 4	Press to launch the Messaging application. Press and hold to launch the Windows Media Player .
(8)	Touch Screen	Use to view the contents on the screen. Use the stylus to select items, navigate menus, change feature settings, or play games.
(9)	Light Sensor	Use to detect environment light change and adjust backlight setting automatically in a small range by the current backlight setting.

Top and bottom panel components

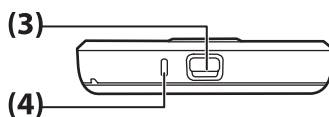
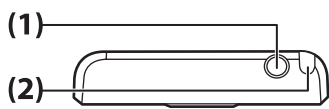

Component		Function
(1)	3.5 Headphone Connector	Plug the headphone into this connector to listen to audio.
(2)	Stylus	Use to select elements on the screen and enter information.
(3)	Charging/Communications Port	Use to connect the mini-USB charging/synchronization cable.
(4)	Microphone	Use to record voice notes.

Left and right side components

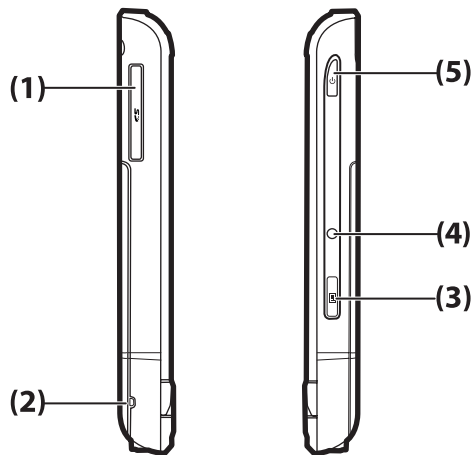

Component		Function
(1)	SD/SDIO Card Slot	Insert a Secure Digital (SD) or Secured Digital Input/Output (SDIO) card with the label side up for data storage or other functions.
(2)	Lanyard Hold	Use to securely fasten accessories to your HP iPAQ or to insert a lanyard to carry your HP iPAQ.
(3)	Voice Recorder Button	Use to launch the Voice Recorder application. NOTE: This function is not available in China.
(4)	Reset	Press to reset your HP iPAQ.
(5)	Power Key	Press and hold to switch your HP iPAQ on or off.

Back panel components

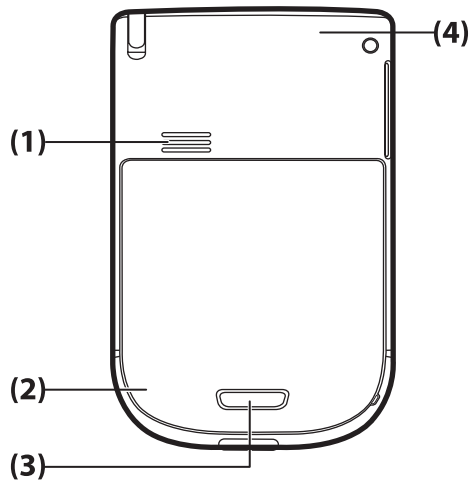

Component		Function
(1)	Back Speaker	Use the speaker to listen to audio.
(2)	Bluetooth Antenna	Detects and radiates Bluetooth signals.
(3)	Battery Latch	Press the battery latch on the battery cover and slide the cover down and away from the HP iPAQ to remove the battery.
(4)	WLAN Antenna	Detects WLAN hotspots.

4 Set up your HP iPAQ

Step 1: Remove the battery cover and the battery

1. Press the battery latch on the battery cover and slide the cover down and away from the HP iPAQ.

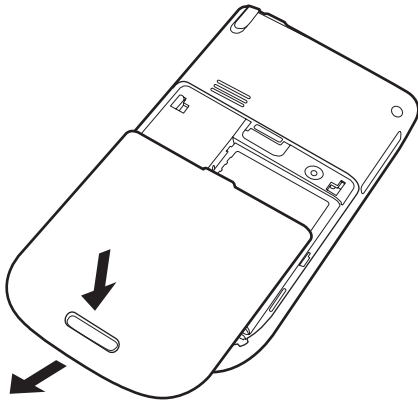

2. Remove the battery.

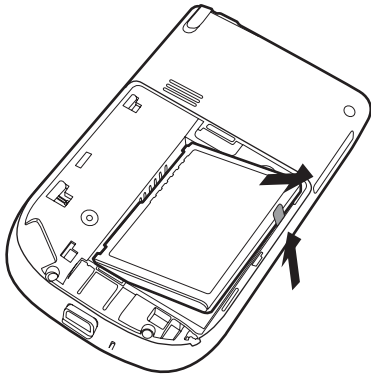

Step 2: Install the battery and replace the battery cover

1. Align the battery connectors on the battery with the housing pins in the battery compartment and insert the battery.

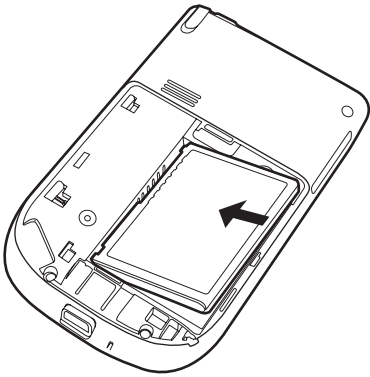

2. Slide the battery cover until it clicks into place.

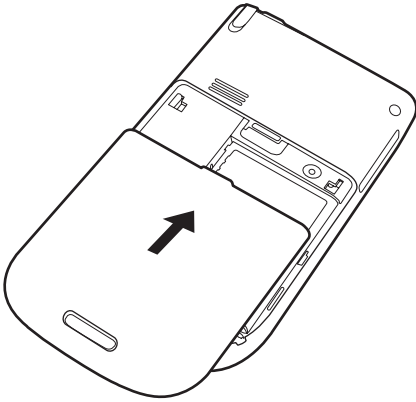

Step 3: Charge the battery

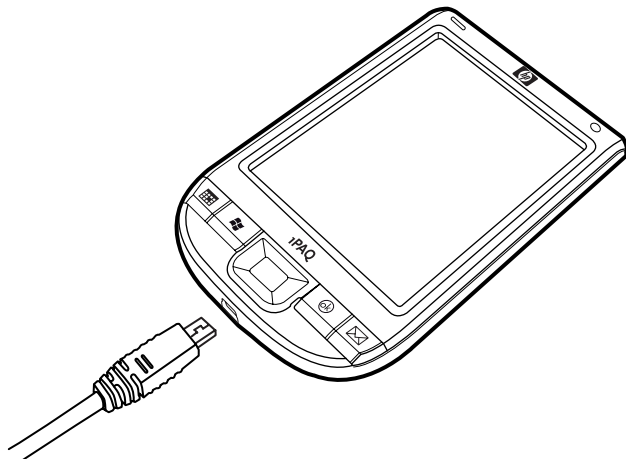



CAUTION: To avoid damaging your HP iPAQ or the AC adapter, make sure all connectors are properly aligned before connecting.

The battery provides power for your HP iPAQ to operate. Your HP iPAQ comes with a mini-USB synchronization cable, which must be used to charge the device.

It takes approximately 2–4 hours to fully charge the battery for the first time. Subsequent charges might take longer.

1. Insert the USB end of the mini-USB synchronization cable into the port on the AC adapter.
2. Connect the AC adapter to an electrical outlet.
3. Connect the mini-USB synchronization cable to the charging/communications port on your HP iPAQ. The cable connector fits only one way. If the connector does not insert easily, turn it over.

 **TIP:** You can also charge the battery by connecting your HP iPAQ to a USB port on your computer using the mini-USB synchronization cable.

 **NOTE:** Whenever a replacement battery is inserted into your HP iPAQ, press the **Power** key for at least two seconds. In case the device does not switch on, attach the AC adapter to switch on your HP iPAQ.

Step 4: Turn on your HP iPAQ

Press the **Power** key to turn on your HP iPAQ. Next, follow the instructions on the screen to complete the setup. Use the on-screen keyboard to enter information.

Protect your HP iPAQ with a password

You can secure the data on your HP iPAQ by setting a password. Each time you turn on your HP iPAQ, you will be prompted to enter the password.

To set a password:

1. Tap **Start > Settings > Lock**.
2. Select the **Prompt if device unused for** check box, and select the time that your HP iPAQ must be unused before you are prompted for a password.
3. In the **Password type** list, select the type of password you would like to use. Enter the password, and then confirm the password.
4. On the **Hint** tab, enter a phrase to help you remember your password. Make sure that your hint does not allow others to guess your password. The hint is displayed after the wrong password is entered five times in a row.
5. When prompted, tap **ok**. The next time your HP iPAQ remains unused for the specified amount of time, you will be prompted to enter your password.

 **TIP:** Follow the steps above to change or reset your password.

Find the serial and model number

Locate the serial and model numbers before contacting HP Customer Support, particularly if you are calling for in-warranty support.











View the serial number and model ID by tapping **Start > Programs > HP Help and Support > Serial and Model Number**.

You can also find this information next to the battery of your HP iPAQ. To locate the serial number:

1. Remove the battery cover.
2. Locate the label containing the serial number next to the battery.

View status icons

The following table lists the common status indicators and their meanings.

Icon	Status	Icon	Status
	Instant message received		New e-mail
	Sync error		Battery level
	Battery level low		Battery charging
	No battery or battery fault		Bluetooth
	Bluetooth off		WLAN off

5 Learn the basics

Get started with your HP iPAQ by learning basic functions such as knowing the **Today** screen, entering text, and synchronizing data.

The Today screen

The **Today** screen displays the date and time and provides a quick status of the remaining battery capacity and upcoming appointments. At the top of the **Today** screen, the connectivity icons, volume indicator, and clock are displayed.





From the **Today** screen, tap the  (iPAQ Wireless) icon to open the **iPAQ Wireless** application. On the **All** tab, you can turn all wireless connections on/off.

To customize the **Today** screen:

1. Tap **Start > Settings > Today**.
2. On the **Appearance** tab, select the required theme for the background of the **Today** screen.
3. On the **Items** tab, select the items to appear on the **Today** screen.

 **TIP:** To move the order in which the items appear, tap **Start > Settings > Today**. On the **Items** tab, tap **Move Up** or **Move Down**.



Use TodayPanel Lite

Icon	Name	Function
	TodayPanel Lite	Use to change the TodayPanel Lite options or the Today screen settings.
	Battery power	Use to view the amount of remaining battery power on your HP iPAQ. Set the standby period, time duration for turning off the HP iPAQ, and USB charging method.
	Main memory	Use to view the amount of available main memory on your HP iPAQ. View, activate, and stop all running programs from this screen.
	Storage memory	Use to view the amount of available storage memory on your HP iPAQ. View, activate, and stop all running programs from this screen.
	Backlight	Use to view and change the backlight options on your HP iPAQ.



To use TodayPanel Lite, tap the required icon, make the necessary changes, and tap **ok**.

You can change the TodayPanel Lite icons to compact mode, which allows more space on the **Today** screen. You can also change the memory and storage settings to display as percentages instead of file sizes.

To change the TodayPanel Lite icons to compact mode:

1.  Tap the  (TodayPanel Lite) icon > **Options** to open the TodayPanel Lite application.
2. Tap the **Display Mode** list and select **Compact**.

To display memory and storage as percentages:

1.  Tap the  (TodayPanel Lite) icon > **Options** to open the TodayPanel Lite application.
2. Tap the **Display Memory as** list or the **Display Storage as** list and select the percentage listed.
3. Tap **ok**.

To remove the TodayPanel Lite application from the **Today** screen:

1. Tap **Start > Settings > Today > Items**.
2. Clear the **TodayPanel** check box and tap **ok**.

For more options, visit <http://www.rhinocode.com> to upgrade to TODAYPANEL.PRO.

Battery saving tips

You can adjust the settings on your HP iPAQ to fit your individual needs and to help your battery last as long as possible between charges. Here are some recommendations to conserve battery life:

- **Sounds** – Every time you are notified of an event, battery power is consumed. Tap **Start > Settings > Personal > Sounds & Notifications** to turn off any unnecessary notifications.
- **Auto Turn Off the Backlight** – Tap **Start > Settings > System > Backlight**. Specify a short amount of wait before turning off the backlight. On the **Battery Power** tab, set **Turn off backlight if device is not used for** to 10 seconds.
- **Turn off Bluetooth and WLAN** – Always turn off **Bluetooth** and **WLAN** when not in use.

HP also offers a variety of accessories to keep your HP iPAQ charged when you are out of the office for extended time periods. These include the mini-USB synchronization cable and travel adapter. Use original HP batteries and chargers to charge your HP iPAQ.

To check the battery power, tap **Start > Settings > System > Power**.

The 5–Way Navigation key

The **5–Way Navigation** key is used to navigate the menu system, change feature settings, or play games. It is also used to scroll up and down a list and select a required function.

-
-  **TIP:** Up and down are your primary movements while navigating within menus or through the **Contacts** list. Move left and right to change the feature settings and edit text. Press the button to select the item highlighted on the screen.
-

Lock and unlock your HP iPAQ

You can lock your HP iPAQ to prevent accidental key presses while you carry your device.

 **NOTE:** When your device is locked, you can still receive e-mail notifications and see appointment reminders.

To lock your HP iPAQ:

▲ On the **Today** screen, tap **Device unlocked**.

To unlock your HP iPAQ:

▲ On the **Today** screen, tap **Unlock**. Now, your iPAQ is unlocked and ready for use.

Enter text

Based on your preference, you can use the on-screen keyboard or a handwriting recognition feature such as **Block Recognizer**, **Keyboard Letter Recognizer**, or **Transcriber** to enter text.

1. Tap **Start > Settings > Personal > Input**.
2. On the **Input Method** tab, select a text input method and change options as appropriate.
3. Tap **ok**.

You can now go to a program (such as Notes) and start entering text.

Text-Input Method	Definition
Block Recognizer	Use a single stroke to write letters, numbers, symbols, and punctuation marks that get converted into typed text.
Keyboard	Tap keys on the keyboard to enter text.
Letter Recognizer	Write individual letters, numbers, and punctuation marks that are converted into typed text.
Transcriber	Write in cursive, print, or mixed handwriting (consisting of both cursive and print), and convert your writing into typed text.

 **TIP:** Change the text input method from within any program by tapping the **Input Selector** arrow and selecting an input method.

Enter owner information

Enter your personal information, such as your name and address, so that the HP iPAQ can be returned to you if it is lost.

1. Tap **Start > Settings > Personal > Owner Information**.
2. On the **Identification** tab, enter your personal information.

 **TIP:** You can edit the owner information directly from the **Today** screen.

Perform a soft reset

A soft reset stops all running applications, but does not erase any programs or saved data.

 **NOTE:** Be sure to close all running applications before performing a soft reset.

To perform a soft reset:

1. Locate the recessed **Reset** button on the HP iPAQ.
2. Use the stylus to lightly press the **Reset** button.

View the Operating System (OS) information

▲ Tap **Start > Settings > System > About**.

The **Version** tab displays important device information, including the type of processor and the amount of available memory.

Change the device name

The device name is used to identify your HP iPAQ in the following situations:

- Synchronizing with a computer
- Connecting to a network

 **NOTE:** If you synchronize multiple devices with the same computer, each device must have a unique name.

To change the device name:

1. Tap **Start > Settings > System > About > Device ID** tab.
2. Enter a name. The device name must begin with a letter, consist of letters from A to Z and numbers from 0 to 9, and should not contain spaces.

Change the regional settings

The style in which numbers, currency, dates, and times are displayed is specified in regional settings.

To change the regional settings:

1. Tap **Start > Settings > System > Regional Settings > Region**.
2. Select a region.

The region you select determines the options available on the other tabs.

3. To customize additional settings, tap the tabs given below to display the required options:
 - **Region**
 - **Number**
 - **Currency**
 - **Time**
 - **Date**

Adjust the volume

You can change the volume for various sounds, such as the sound you hear when you tap program names and menu options.

1. Tap the  (Speaker) icon at the top of the screen.
2. Move the system volume slider on the screen to the required volume level.
3. To mute system sounds, tap **Off**.

You can also set a specific sound for a specific event.

1. Tap **Start > Settings > Personal > Sounds & Notifications**.
2. On the **Sounds** tab, choose how you want to be notified by selecting the appropriate check boxes.
3. On the **Notifications** tab, in the **Event** list, tap an event name and choose how you want to be notified by selecting the appropriate check boxes. You can choose from several options, such as a special sound, a message, or a flashing light.

 **NOTE:** Turning off sounds and the LED notification helps conserve battery power.

Change power management settings

1. Tap **Start > Settings > System > Power**.
2. Tap **Advanced** and select the length of time the HP iPAQ should remain on when using battery power or external power.

Dim or adjust brightness of the backlight

You can set the backlight to dim after a specified amount of time has elapsed.

1. Tap **Start > Settings > System > Backlight**.
2. Tap **Battery power** or **External Power**.
3. Select the backlight options of your choice.

You can also increase or decrease the brightness of the backlight.



Move the slider near the  (Backlight) icon to increase or decrease the brightness. You can also change the brightness by tapping **Start > Settings > System > Backlight > Brightness**.

Install and remove programs

To install programs on your HP iPAQ:

1. Use the mini-USB synchronization cable to connect your HP iPAQ to your computer.
2. Follow the instructions in the Installation Wizard provided with the program you want to install.
3. Check the screen on your HP iPAQ to see if any further steps are necessary to complete the program installation.

To remove programs from your HP iPAQ:

1. Tap **Start > Settings > System > Remove Programs**.
2. Select the check boxes for programs you want to remove, and then tap **Remove**.

 **NOTE:** By removing a program from your HP iPAQ, you can increase available memory on the device.

If programs are lost from your HP iPAQ for any reason, most of them can be re-installed using any synchronization software. See [Synchronization software on page 58](#) for more information.

Open and close programs

You do not need to exit a program to open another or to conserve memory. The system manages memory automatically.

To open a program, tap **Start**, and then select the required program from the list. If you do not see the program you want to launch, tap **Start > Programs**.

In most cases, selecting **x** or **ok** will close an application but will not stop the application from running in memory. However, you can close it manually.

1. Tap **Start > Settings > System > Memory > Running Programs**.
2. From the **Running Programs** list, tap the program you want to close, and then tap **Stop**.

Set alarms and clocks

To set alarm on your HP iPAQ:

1. Tap **Start > Settings > System > Clock & Alarms > Alarms**.
2. Tap **<Description>** to enter a name for the alarm.
3. Tap a week day to set the alarm. You can also set the alarm for multiple days.
4. Tap **Time** and set the time for the alarm.
5. Tap the  (Alarm) icon to specify the type of alarm. You can choose a single sound or a repeating sound.
6. If you choose to play a sound, tap the list next to the **Play sound** check box, and then tap the sound you want to set.

To set time on your HP iPAQ:

1. Tap **Start > Settings > System > Clock & Alarms > Time**.
2. Select **Home** to set the time zone, local time, and date when you are in your home country. Select **Visiting** to set these options while traveling.

Shortcut menus

A shortcut menu is displayed when you tap and hold an item. This menu displays the most common commands for the specific item. For example, you can delete an appointment by using commands on a shortcut menu.

When the shortcut menu displays, tap the action you want to perform.

To close a shortcut menu without performing an action, tap anywhere outside the menu.

Display the clock in title bar

When viewing certain programs, the clock may not be displayed in the title bar. To display the clock in the title bar at all times:

1. Tap **Start > Settings > System > Clock & Alarms**.
2. On the **More** tab, tap to select the **Display the clock on the title bar in all programs** check box.

Create and assign a category

In the **Calendar**, **Contacts**, and **Tasks** programs, you can use categories to organize and group your appointments, contacts, and tasks.

1. From the list, select an existing item or create a new one.
2. Do one of the following:
 - For an existing item in **Calendar**, open the appointment and tap **Menu > Edit > Categories**.
 - For an existing item in **Tasks**, open the task and tap **Edit > Categories**.
 - For an existing item in **Contacts**, open the contact and tap **Edit > Categories**.
 - For a new item in **Calendar**, **Contacts**, and **Tasks**, select **Categories**.
3. Select the required check box (**Business**, **Holiday**, **Personal**, or **Seasonal**) and tap **ok** to assign the category.
4. Tap **ok** to return to the appointment, task, or contact.

 **NOTE:** To create a new category, tap **New** and assign a name to the category for a contact, task, or an appointment. The new category is automatically assigned to the item.

Adjust the speed for scrolling through items in a list

To change the scrolling speed:

1. Tap **Start > Settings > Personal > Buttons > Up/Down Control**.
2. Under **Delay before first repeat**, move the slider to reduce or increase the time that elapses before scrolling begins.
3. Under **Repeat rate**, move the slider to change the time it takes to scroll from one item to the next.

6 Connections

You can use your HP iPAQ to connect to and exchange information with other handheld devices, your computer, various network types, or the Internet. Following are the ways to get connected:

- WLAN
- Bluetooth

You can access all these connection types by tapping **Start > Settings > Connections**.

WLAN

With wireless access, you do not need to use cables to connect your HP iPAQ to the Internet. Instead, access points transmit data to and from your wireless device. Your HP iPAQ can connect to an Institute of Electrical and Electronics Engineers (IEEE) 802.11b/g or connect directly to other WLAN-enabled devices.

With WLAN, you can:

- Access the Internet
- Send and receive e-mail
- Access corporate network information
- Use Virtual Private Networks (VPNs) for secure remote access
- Use hotspots for wireless connectivity

On the **Today** screen, tap the  (iPAQ Wireless) icon to access the WLAN features.

 **NOTE:** Use of dial-up and wireless Internet, e-mail, corporate networks, and other wireless communications, such as Bluetooth devices, might require separately purchased additional hardware and other compatible equipment, in addition to a standard WLAN infrastructure and a separately purchased service contract. Not all Web content might be available. Some Web content might require installation of additional software.

WLAN terms



It is recommended that you become familiar with the following terms as you begin to use WLAN technology.

Term	Definition
802.11 standard	An approved standard specification of radio technology from the IEEE used for wireless local area networks (WLANs).
Device-to-computer or ad-hoc	A mode that does not use access points. It provides independent peer-to-peer connectivity in a wireless LAN.
Domain Name System (DNS)	The way that Internet domain names are located and translated into IP addresses. It is easy to remember name for an Internet address. Every Web site has its own specific IP address on the Internet.

Term	Definition
Encryption	An alphanumeric (letters and/or numbers) conversion process of data primarily used for protection against any unauthorized people.
Hotspots	Public or private areas where you can access WLAN service. These wireless connections can be located, for example, at a library, cyber cafe, hotel, airport lounge, or convention center. This service can be free or sometimes requires a fee.
Infrastructure	This connection mode uses wireless access points to connect to networks.



Automatically connect to a WLAN network

When you turn on the WLAN radio, your HP iPAQ automatically detects WLAN networks that are broadcasting their signals. If your WLAN network is not set to broadcast, then you have to connect to it manually. Before trying to connect to a WLAN network, determine if authentication information is needed by contacting your network administrator.

1. Tap the  (iPAQ Wireless) icon.
2. Tap the  (WLAN) icon to turn on WLAN.
3. Once the HP iPAQ detects a WLAN network, you are asked to choose if you want to connect. Select the network you want to connect to and tap **Connect**.



Manually connect to a WLAN network

A wireless network can be added manually by entering the settings information to add the network. Before trying to connect to a WLAN network, determine if authentication information is needed by contacting your network administrator.

1. Tap the  (iPAQ Wireless) icon.
2. Tap the  (WLAN) icon to turn on WLAN.
3. Tap **Start > Settings > Connections > iPAQ Wireless > WLAN > View WLAN Networks > Wireless > Add New...**
4. Enter the Network name.
5. Choose a connection method. Select **The Internet** to connect to the Internet through an ISP or select **Work** to connect to a company network. You should select **Work** if the network requires a proxy server.
6. Tap **Next**.
 - To use authentication, select the authentication method from the **Authentication** list.
 - To use data encryption, select an encryption method from the **Data Encryption** list.
 - To automatically use a network key, tap **The key is automatically provided**, else enter the **Network key** and **Key index**.

 **NOTE:** To delete a connection, tap **Start > Settings > Connections > iPAQ Wireless > WLAN > View WLAN Networks > Wireless**. Tap and hold the connection you want to remove, and then tap **Remove Settings**.



Find an IP Address

1. Tap the  (iPAQ Wireless) icon.
2. Tap the  (WLAN) icon to turn on WLAN.
3. Connect to a network automatically or manually by tapping **Start > Settings > Connections > iPAQ Wireless > WLAN > View WLAN Networks**.
4. Select a WLAN network. The WLAN IP Address is shown here.

Delete a wireless network

You can delete networks you manually entered. However, if a network was automatically detected, you cannot delete it.

To delete an existing or available wireless network:

1. Tap the  (iPAQ Wireless) icon.
2. Tap the  (WLAN) icon to turn on WLAN.
3. Tap **WLAN > View WLAN Networks > Wireless**.
4. In the **Configure Wireless Networks** box, tap and hold the network you want to delete.
5. Tap **Remove Settings**.

Configure the 802.1x authentication settings

Before performing these steps, determine if authentication information is needed by contacting your network administrator.

1. To manually enter information, tap **Start > Settings > Connections > iPAQ Wireless > WLAN > View WLAN Networks**.
2. In **Wireless networks** list, select the network you want to configure.
3. For increased security, select the **Use IEEE 802.1x network access control** check box. Then, select the appropriate EAP type.

Bluetooth

Bluetooth terms

It is recommended that you become familiar with the following terms as you begin to use Bluetooth technology.

Term	Definition
Authentication	Verification of a numeric passkey before a connection or activity can be completed.
Authorization	Approval of a connection, access, or activity before it can be completed.



Term	Definition
Bonding (Paired devices)	Creating a trusted connection between your device and another. After a bond is created, the two devices become paired. A paired device does not require authentication or authorization.
Device address	Unique electronic address of a Bluetooth device.
Device discovery	Location and recognition of another Bluetooth device.
Device ID	Name that a Bluetooth device provides when discovered by another device.
Encryption	Method of protecting data.
Passkey	Code you enter to authenticate connections or activities requested by other devices.
Personal Information Manager (PIM)	Collection of programs used to manage daily business tasks (for example: Contacts, Calendar, and Tasks).
Profiles	Collection of Bluetooth settings.
Service discovery	Determination of which programs you have in common with other devices.

Bluetooth Manager

Use Bluetooth Manager to:

- Establish connections
- Exchange business cards
- Display shortcuts

To access the Bluetooth manager:

1. Tap the  (Bluetooth) icon to turn Bluetooth on.
2. Tap the  (iPAQ Wireless) icon.
3. Tap **Bluetooth > Bluetooth Connections**. The first screen that displays is **My Shortcuts**.

When you are required to locate a device and connect to it, tap **New**. The Bluetooth browser then searches for other Bluetooth devices.

Bluetooth Phone Manager

Use Bluetooth Phone Manager to connect your HP iPAQ to a Bluetooth-enabled cell phone, which allows use of the phone as a modem to browse the Internet or transfer other information. To do this, create a Bluetooth connection between your HP iPAQ and the cell phone, and then send information to the phone using Bluetooth. The phone relays the information over the phone line and then sends back to your HP iPAQ any information requested over the connection.

 **NOTE:** Ensure both your HP iPAQ and the cell phone are turned on, discoverable, and within close range.

To establish a connection between your HP iPAQ and a cell phone using Bluetooth Phone Manager:

1. Tap **Start > Programs > BT PhoneManager**.
2. If using the application for the first time, tap **Yes** to set up a pairing with a Bluetooth phone.
3. Follow the on-screen instructions to create a pairing between your HP iPAQ and the phone.

For more information, open Bluetooth Phone Manager and tap **Tools > Help**.

Connect to a computer via Bluetooth

For best results, connect the HP iPAQ to the computer using USB to establish a synchronization relationship before connecting via Bluetooth.

1. Follow the instructions in the synchronization software help on the computer for configuring Bluetooth on your computer.
2. On the HP iPAQ, tap **Start > Programs > ActiveSync**.
3. Tap **Menu > Connect via Bluetooth**. Make sure the device and computer are within close range.
4. If this is the first time you have connected to this computer via Bluetooth, complete the Bluetooth wizard on the HP iPAQ and set up a Bluetooth partnership with the computer.
5. Tap **Sync**.
6. Tap **Menu > Disconnect Bluetooth**.

 **TIP:** To preserve battery power, turn off Bluetooth.

Bluetooth device profiles

The functions that Bluetooth supports are called services or profiles. You can communicate only with Bluetooth devices that support at least one of the following profiles:

- ActiveSync — Uses Serial Port Profile (SPP) to connect to ActiveSync on a computer
- Advanced Audio Distribution Profile (A2DP)
- Audio Video Remote Control Profile (AVRCP)
- Basic Imaging Profile (BIP)
- Basic Printer Profile (BPP)
- Dial-up Networking (DUN)
- File Transfer Protocol (FTP)
- Generic Access Profile (GAP)
- Headset Support Profile (HSP)
- Human Interface Device Profile (HID)
- Object Exchange (OBEX) Protocol
- Object Push Protocol (OPP)
- Personal Area Network (PAN)
- Serial Port Profile (SPP)
- Service Discovery Protocol (SDP)

Create, end, and accept a Bluetooth partnership

You can exchange information between your HP iPAQ and another device that has Bluetooth capabilities. For this, you will have to first create a Bluetooth partnership between the two devices.

 **NOTE:** To exchange information between two Bluetooth enabled devices, make sure Bluetooth is turned on both devices. The devices need not be in the discoverable mode.

1. Make sure the two devices are turned on, discoverable, and within close range.
2. Tap **Start > Settings > Connections > Bluetooth**.
3. Tap **Bluetooth Manager > New > Explore a Bluetooth Device**. Your HP iPAQ searches for other devices with Bluetooth capabilities and displays them in the list.
4. Tap the name of the other device, and tap **Next**.
5. In **Security**, if you want to use a secure, encrypted connection (recommended for enhanced security), check this box, and tap **Next**. Otherwise, leave the **Security** field blank and tap **Next**.
6. Enter the same passkey on the other device.
7. Tap **Finish**.
8. To give the partnership a more meaningful name, tap and hold the device name under **My Shortcuts**, then tap **Rename**.

To end a Bluetooth partnership:

1. Tap **Start > Settings > Connections > Bluetooth > Bluetooth Manager**.
2. Tap and hold the partnership you want to end.
3. Tap **Delete**.

To accept a Bluetooth partnership:

1. Make sure your device is turned on, discoverable, and within close range.
2. When prompted to accept a partnership with the device that is requesting the relationship, tap **Yes**.
3. If a passkey is requested, enter an alphanumeric passkey between 1 and 16 characters in **Passkey** box and tap **Next**. Enter the same passkey in the device requesting the partnership. Using a passkey provides greater security.
4. To give the partnership a more meaningful name, change the name of the device in **Name**.
5. Tap **Finish**.

If you cannot discover another device, try the following:

- Make sure Bluetooth is turned on.
- Move closer to the device.
- Make sure the device you are attempting to connect to is switched on and is in the discoverable mode.

Rename a Bluetooth partnership



1. Tap **Start > Settings > Connections > Bluetooth**.
2. Tap the **Browse** icon located next to **Current profile**.
3. Select the partnership you want to rename, and tap **Rename**.

4. In **Enter the name of the new profile** box, enter a new name for the partnership.
5. Tap **ok**.

Pair and unpair devices

You can pair devices such that they exchange a computer generated security key prior to each connection. The security key is generated from a unique Bluetooth device address, a random number, and a user-defined password. After two devices are paired, they have a trusted relationship with each other. You do not need to give any additional input. Without giving constant authorization, your connections and activities can then be performed between the paired devices.

To pair devices:

1. Tap the  (Bluetooth) icon to turn Bluetooth on.
2. Tap the  (iPAQ Wireless) icon.
3. Tap **Bluetooth > Bluetooth Connections > Menu > Paired devices**.
4. Tap **Add**.
5. Tap **Lookup** icon.
6. Tap a **device**.
7. Enter a password in the **Passkey** field.
8. Tap **ok**.
9. Enter the same password into the other device.

If you can see other devices, but you cannot connect or exchange data with them, try the following:

- Make sure the other device has not restricted your access.
- Try initiating pairing from the other device. Some Bluetooth devices can only initiate pairing and cannot respond to pairing requests from other devices.

If other devices cannot find or connect to your HP iPAQ, try the following:

- Make sure Bluetooth is turned on.
- Make sure you have not restricted other devices from finding yours. Refer to **Requiring a Passkey or Bond** for more information.
- Check your Bluetooth settings to make sure you have allowed your device to be discovered by others to connect. Refer to **Making a Device Discoverable** for more information.

To remove a paired relationship between devices:

1. Tap the  (iPAQ Wireless) icon.
2. Make sure that Bluetooth is already on. If not, turn on Bluetooth.
3. Tap **Bluetooth > Bluetooth Connections > Menu > Paired devices**.
4. Tap a device name.
5. Tap **Remove**.
6. Tap **Yes** to remove the pairing.

Make a device discoverable

When your HP iPAQ is discoverable, other devices with Bluetooth capabilities can detect, or discover, your HP iPAQ and attempt to beam information to it, establish a partnership, or use a Bluetooth service.

1. Tap **Start > Settings > Connections**.
2. Tap **Bluetooth > Accessibility**.
3. Select the **Allow other devices to connect** check box, and then select the **Other devices can discover me** check box.



 **NOTE:** If you no longer want your HP iPAQ to be discoverable, clear the **Allow other devices to connect** check box.

Connect to a Bluetooth Headset

You can use a Bluetooth headset (or other Bluetooth hands-free device) with your HP iPAQ when you create a partnership between them.



1. Make sure that the two devices are turned on, discoverable, and within close range.
2. Tap **Bluetooth > Bluetooth Connections > Menu > New Shortcut**.
3. Select **Hands-free/Headset** setup and follow the on-screen instructions.

Open Bluetooth settings

1. Tap the  (Bluetooth) icon to turn Bluetooth on.
2. Tap the  (iPAQ Wireless) icon.
3. Tap **Bluetooth > Bluetooth Settings**.

Authorization to access services



If you choose to require authorization to access services, you have to authorize each connection. Your HP iPAQ always asks you if the connection should be permitted.

1. Tap the  (Bluetooth) icon to turn Bluetooth on.
2. Tap the  (iPAQ Wireless) icon.
3. Tap **Bluetooth > Bluetooth Settings > Services**.
4. Tap the service you want to enable: **File Transfer, Information Exchange, Serial Port, Personal Network Server, Hands Free, or Dial-up Networking Server**.
5. Select **Authorization required**.
6. Tap **ok**.

Use a passkey or bond



To establish a secure connection with another device, you can use the passkey feature or an established bond. You can also add data encryption to this type of security. A passkey is a code you enter to

authenticate connections requested by other devices. The passkey must be known and used by both parties or the connection will not be allowed.

1. Tap the  (Bluetooth) icon to turn Bluetooth on.
2. Tap the  (iPAQ Wireless) icon.
3. Tap **Bluetooth > Bluetooth Settings > Services**.
4. Tap the service you want to enable: **File Transfer, Information Exchange, Serial Port, Personal Network Server, Hands free, or Dial-up Networking Server**.
5. Select **Authorization required** and **Authentication (Passkey) required** if you want more security.
6. Select **Encryption Required** if you want all the data exchanged between the devices to be encrypted.
7. Tap **ok**.

Set a Bluetooth shared folder

You can determine the folder that other devices access when they connect to your HP iPAQ.

1. Tap the  (Bluetooth) icon to turn Bluetooth on.
2. Tap the  (iPAQ Wireless) icon.
3. Tap **Bluetooth > Bluetooth Settings > Services > File Transfer**.
4. Under **Service Settings**, select your preferred settings.
5. Tap **Advanced**.
6. Tap the  (Folder) icon and locate the required file folder.
7. Tap **ok**.

Bluetooth Stack 2.0/EDR

A2DP technology allows users to send CD quality stereo music from one device to another using Bluetooth wireless technology. A2DP is one of the modes available for Bluetooth technology.

 **NOTE:** Even though the Bluetooth Stereo Headphones support A2DP profile, the user's iPAQ model and OS should be compatible with A2DP in order for the user to use this feature. Operating systems from Windows Mobile 5.0 (based on the Windows CE 5.0 kernel) onwards are compatible with and fully support A2DP if an appropriate device (embedded in the PDA or phone) is used.

Advanced settings

Connect to intranet URLs

To connect to intranet sites that have periods in their URLs (for example, intranet.companyname.com), add them to the **Work URL Exceptions** list.

1. Tap **Start > Settings > Connections > Connections > Advanced > Exceptions**.
2. Tap **Add new URL**.
3. In **Work URL**, enter the intranet URL.

 **NOTE:** If you use many URLs that share the same root company name, you can avoid entering them individually by entering ***.companyname.com**.

Change an intranet URL

1. Tap **Start > Settings > Connections > Connections > Advanced > Exceptions**.
2. Tap the intranet URL exception you want to change, then make the required changes.

 **NOTE:** To delete a work URL exception, tap and hold it in the list, then tap **Delete**.

Set up proxy server settings

If you are connected to your Internet Service Provider (ISP) or private network during synchronization, your device should download proper proxy settings during synchronization from your computer. If these settings are not on your computer or need to be changed, you can change them manually.

Before you begin, obtain the following information from your ISP or network administrator:

- User name
- Password
- Proxy Server name
- Port
- Type of Socks protocol used

To set up proxy server settings:

1. Tap **Start > Settings > Connections > Connections**.
2. If a proxy server has not been set up, tap **Set up my proxy server**, else tap **Edit my proxy server**.
3. Select the **This network connects to the Internet** and **This network uses a proxy server to connect to the Internet** check boxes.
4. In the **Proxy server** box, enter the proxy server name.
5. To change such settings as port number or proxy server type, tap **Advanced** and change the required settings.

Set up a WAP gateway

To access Wireless Access Point (WAP) sites through Internet Explorer, configure your device to use a WAP gateway.



Before you begin, obtain the following information from your ISP or network administrator:

- User name
 - Password
 - ISP server phone number
 - WAP gateway server name
 - Port number
1. Tap **Start > Settings > Connections > Connections > Advanced > Select Networks > My Work Network > Edit...** If a proxy server has not been set up, tap **New...**
 2. On the **Proxy Settings** tab, select the **This network connects to the Internet** and **This network uses a proxy server to connect to the Internet** check boxes.
 3. If necessary, in the **Proxy server** box, enter the proxy server name.
 4. Tap **Advanced > WAP**.
 5. In the **Server** box, enter the WAP gateway server name. Under **Port**, enter the port number. The most common WAP port number is 9201.
 6. Enter any logon credentials required by the WAP gateway server.

Configure advanced proxy settings

1. For the appropriate server type, enter the proxy server name and port.
2. If necessary, enter the credentials for connecting with your proxy server.
3. If you are configuring a Socks proxy, select **Socks 4** or **Socks 5**. If using Socks 5, enter the credentials for connecting with your proxy server.

Advanced connection settings

1. Tap the  (iPAQ Wireless) icon.
2. Tap the  (WLAN) icon to turn on WLAN.
3. To connect to a network, tap **Start > Settings > Connections > Connections > Advanced > Select Networks**.
4. Select **My ISP** to connect to the Internet through an ISP or select **My Work Network** to connect to a company network. Select **My Work Network** if the network requires a proxy server. If you need to change or create a new network management name, tap **Edit...** or **New...**, and then tap **ok**.
5. From the **Connections** screen, tap **Advanced** to set up your Dialing Rules and Exceptions and tap **ok**.

Set up a VPN server connection

A VPN connection helps you to securely connect to servers, such as a corporate network, via the Internet.

Before you begin, obtain the following information from your network administrator:

- User name
- Password
- Domain name
- TCP/IP settings
- Host name or IP address of the VPN server

To set up a VPN server connection:

1. Tap **Start > Settings > Connections > Connections**.
2. Under **My Work Network**, tap **Add a new VPN server connection** and follow the instructions in the New Connection wizard.
3. Under most circumstances, you should not change any advanced settings. However, you need to change advanced settings when:
 - The server to which you are connecting does not use dynamically-assigned addresses, and you need to enter your TCP/IP settings.
 - You need to change server DNS or WINS settings.If either of these circumstances applies, from the **My VPN** screen, tap **Advanced** and fill in the appropriate information. Tap **ok** to save the changes and return to the **My VPN** screen.
4. To view additional information for any screen in the wizard or while changing settings, tap **Help**.

Change a connection group name

Your device is already set up with two groups of connection settings: **My ISP** and **My Work Network**. You can also change the name of these groups. For example, if you put all of your corporate settings under **My Work Network Connections**, you can change the name to your company's name.

1. Tap **Start > Settings > Connections > Connections**.
2. After you have created a new connection, under **My ISP** or **My Work Network**, tap **Add a new modem connection** to create a new connection.
3. Under **My ISP**, or **My Work Network**, tap **Manage Existing Connections**.
4. Tap **General**.
5. Enter a name for the settings group and tap **ok**.

End a connection

It can be useful to end a connection when you are done using it. This frees resources on your HP iPAQ and can save connection charges.

- When connected via a modem or VPN, tap **Connections > Disconnect**.
- When connected via cable, detach your HP iPAQ from the cable.
- When connected via Bluetooth, tap **Start > Settings > Connections > Bluetooth > Bluetooth Manager > Active Connection**. Tap and hold the connection name, and then tap **Disconnect**.
- When connected via a network (Ethernet) card, remove the card from your HP iPAQ.

7 HP Photosmart Mobile





HP Photosmart Mobile

You can use HP Photosmart Mobile to:

- View pictures stored on your HP iPAQ or a storage card.
- Add voice or text notes to pictures.
- Print pictures.
- View a slideshow.
- Send pictures as e-mail attachments or via Bluetooth.
- Associate a picture with a contact.
- Assign a picture to the **Today** screen background.

Attach a voice note to a picture

To attach a voice note to a picture:

1. Tap **Start > Programs > Photosmart Mobile**.
2. Tap the thumbnail to which you want to add a voice note.
3. Tap the  (Cassette) icon.
4. Tap the  (Record) button on the Recording toolbar.
5. Speak into the microphone to record the voice note and tap the  (Stop) button when finished.
6. Tap the  (Cassette) icon again to close the Recording toolbar.

E-mail a picture

To e-mail a picture:

1. Tap **Start > Programs > Photosmart Mobile**.
2. Tap the thumbnail to be sent via e-mail.

 **NOTE:** If the media file is protected by Digital Rights Management (DRM), you would not be able to view or hear it. DRM is a software that enables secure distribution and prevents illegal distribution of pictures, videos, music, movies, and ring tones over the Internet. For more information on DRM, refer to the on-screen help by tapping **Start > Help** and search for DRM.

3. Tap **Menu > Send > E-mail Attachment**.
4. Select the **Reduce sent photo size to** check box, and then select the required reduction percentage.
5. Tap **Next**.

6. Enter the appropriate e-mail address or use **Contacts** by tapping **Menu > Add Recipient**.
7. Enter other appropriate information, such as an e-mail title and message.
8. Tap **Send**.

 **NOTE:** To send the e-mail immediately, you need to either enable WLAN on your HP iPAQ or connect the device to a computer for synchronization with the Exchange Server.

View a slideshow

To view a slideshow:

1. Tap **Start > Programs > Photosmart Mobile**.
2. Tap the  (Slideshow) button at the bottom of the screen.
3. Tap the screen to view the  (Forward),  (Backward), and  (Stop) buttons.

8 Messaging

Understand messages

To send and receive e-mail messages from an e-mail account, you need to connect to the Internet or your corporate network, depending on the account.

You can send and receive:

- Outlook e-mail
- Internet e-mail through an ISP

You can also access e-mail from work using a VPN connection.

E-mail in the Outlook e-mail account is sent and received through synchronization with a computer using any synchronization software or through wireless synchronization directly with an Exchange Server. See [Synchronization software on page 58](#) for more information.

Internet e-mail is sent and received by connecting to a Post Office Protocol 3 (POP3) or Internet Message Access Protocol 4 (IMAP4) e-mail server. When connecting to a POP3 or IMAP4 server, you need to use a modem to connect to your ISP. You can use an Ethernet card to connect to the local area network to which your e-mail server is connected.

Types of folders

Each messaging account has its own set of folders with the following default messaging folders:

- Deleted Items
- Drafts
- Inbox
- Outbox
- Sent Items

The messages you send and receive through the account are stored in these folders. You can also create additional folders within each account.

The way folders work vary by type:

- If you use an Outlook e-mail account, e-mail messages in the Inbox folder in Outlook are synchronized automatically with your HP iPAQ. You can choose to synchronize additional folders by designating them for synchronization. The folders you create and the messages you move are mirrored on the e-mail server. You can read the messages while you are away from your computer.
- If you use a POP3 account and you move e-mail messages to a folder you created, the link is broken between the messages on your HP iPAQ and their copies on the e-mail server. When you connect, the e-mail server detects that the messages are missing from the Inbox folder on your HP iPAQ and deletes them from the e-mail server. This prevents having duplicate copies of a message, but it also means that you no longer have access to messages that you move to folders created from anywhere except your HP iPAQ.
- If you use an IMAP4 account, the folders you create and the e-mail messages you move are mirrored on the e-mail server. Therefore, messages are available to you anytime you connect to your e-mail server, whether it is from your HP iPAQ or computer. This synchronization of folders occurs whenever you connect to your e-mail server, create new folders, or rename/delete folders when connected. You can also set different download options for each folder.

Synchronize e-mail

When you synchronize Outlook e-mail on a computer with your device, e-mail messages are synchronized as follows:

- Messages in the Inbox folder on your computer or Exchange Server are copied to the Inbox folder of the Outlook e-mail account on your device.
- Messages in the Outbox folder on your device are transferred to Exchange Server or Outlook, and then sent from those programs.
- When you delete a message on your device, it gets deleted from your computer or Exchange Server the next time you synchronize.
- The default sync settings synchronize messages from the past three days and the first 0.5 KB of each new message is downloaded. It does not download file attachments.

 **NOTE:** For more information on starting Outlook e-mail synchronization or changing synchronization settings, see the synchronization software help on the computer or tap **Contents**.

Set up Messaging accounts

Set up e-mail using Exchange server

1. Tap **Start > Messaging > New E-mail Account**.
2. Enter your e-mail address in the **E-mail address** box and tap **Next**.
3. Scroll and select the **Exchange server** option from the **Your e-mail provider** list.
4. Tap **Next** to synchronize outlook with your organization's Exchange e-mail server.
5. In **Server address**, enter the Outlook Web Access server address and tap **Next**.

 **NOTE:** Select **This server requires an encrypted (SSL) connection** check box to ensure you always send e-mail from this account using an Secure Sockets Layer (SSL) connection.

6. Enter the **User name**, **Password**, and **Domain** on the **Edit Server Settings** screen.
7. Select the check box for the items you want to synchronize, and tap **Finish**.

Internet e-mail

Create a new POP3 or IMAP4 account

You must set up an e-mail account that you have with an ISP or an account that you access using a VPN server connection (typically a work account) before you can send and receive e-mail.

1. Tap **Start > Messaging > New E-mail Account**.
2. Enter the account name and then Tap **Next**.
3. Scroll and select the **Internet e-mail** option from the **Your e-mail provider** list and tap **Next**.
4. Enter your name and required account name and tap **Next**.
5. Enter the incoming server name and select the required account type, **POP3** or **IMAP4**.

You can also perform the following functions:

- Change the time intervals for downloading new messages.
- Download attachments.
- Limit the number of messages that are downloaded.

Setting	Description
User name	Enter the user name assigned to you by your ISP or network administrator. This is often the first part of your e-mail address, which appears before the at sign (@).
Password	Choose a strong password. You have the option to save your password so that you do not need to enter it each time you connect to your e-mail server.
Domain	Not required for an account with an ISP. Might be required for a work account.
Account type	Select POP3 or IMAP4.
Account name	Enter a unique name for the account, such as Work or Home. This name cannot be changed later.
Incoming mail	Enter the name of your e-mail server (POP3 or IMAP4).
Outgoing mail	Enter the name of your outgoing e-mail server (SMTP).
Require SSL connection	Select this to ensure you always send e-mail from this account using an SSL connection. This enables you to send personal information more securely. Note that if you select this and your ISP does not support an SSL connection, you might not be able to send e-mail.
Outgoing mail requires authentication	Select this if your outgoing e-mail server Simple Mail Transfer Protocol (SMTP) requires authentication. Your user name and password from above is used.
Use separate settings	Select this if your outgoing e-mail server requires a different user name and password than the ones you entered before.
Outgoing server settings	Configure these settings to ensure that your outgoing e-mail messages are delivered.
User name	Enter your user name for the outgoing e-mail server.
Password	Enter your password for the outgoing e-mail server.

Setting	Description
Domain	Enter the domain of the outgoing e-mail server.
Require SSL for outgoing mail	Select this to ensure you always send e-mail from this account using an SSL connection. This enables you to send personal information more securely. Note that if you select this and your ISP does not support an SSL connection, you might not be able to send e-mail.

 **TIP:** You can set up several e-mail accounts in addition to your Outlook e-mail account but you cannot add a new account while connected. Tap **Menu > Stop Send/Receive** to disconnect.

Change e-mail download options

You can customize the following download options for each e-mail account that you have with an ISP, or any account that you access using a VPN server connection (typically a work account).

You can choose:

- Whether messages are downloaded automatically.
- How much e-mail is downloaded.
- If and how attachments are downloaded (IMAP4 only).

To change the e-mail download options, do the following:

1. In the message list, tap **Menu > Options**.
2. Select the e-mail account.
3. Tap **Next** until you reach **Server information**.
4. Tap **Next** until you reach **Message download Limit**, and then select **Entire Message Receive attachments** check box.

 **TIP:** To send and receive messages automatically, tap **Connect**, check for messages and enter a time interval. Connecting automatically might result in higher connection charges.

To save memory, limit the number of e-mails downloaded to your device by lowering the number of days to display.

To change options for an Outlook e-mail account, tap **Start > ActiveSync > Menu > Options**.

Delete an account

1. Tap **Start > Messaging**.
2. Tap **Menu > Options**.
3. Tap and hold the account name, and tap **Delete**.

Receive attachments

An attachment sent with an e-mail message or downloaded from the server is displayed below the subject of the message. Tapping the attachment opens the attachment if it has been fully downloaded or marks it for download the next time you send and receive e-mail. You can also download attachments automatically with your messages if you have an Outlook e-mail or IMAP4 e-mail account.

If you have an Outlook e-mail account, do the following:

1. Tap **Start > ActiveSync**.
2. Tap **Menu > Options**.
3. Tap **E-mail > Settings**, and then select **Include File Attachments**.

If you have an IMAP4 e-mail account with an ISP or an account that you access using a VPN server connection (typically a work account), do the following:

1. Tap **Start > Messaging**.
2. Tap **Menu > Options**.
3. Tap the name of the IMAP4 account.
4. Tap **Next** until you reach **Message download Limit**, and then select **Entire Message Receive attachments** check box.

 **TIP:** Embedded images and objects cannot be received as attachments.

An embedded message can be viewed as an attachment when using IMAP4 to receive e-mail. However, this feature does not work if Transport Neutral Encapsulation Format (TNEF) is enabled so that you can receive meeting requests.

To store attachments on a storage card rather than on the device, tap **Menu > Tools > Options > Storage**, and select the **Store attachments on a storage card** check box.

Send meeting requests

To send meeting requests:

1. Tap **Start > Calendar**.
2. Tap the appointment , and then tap **Menu > Edit > Appointment > Attendees**.
3. For required attendees, tap **Add Required Attendees...** and for optional attendees, tap **Add optional Attendees...**
4. Select a contact, and then tap **Done**.
5. Tap **ok**, and then tap **Yes** to send the meeting request.

Receive meeting requests

If you receive your e-mail messages through any synchronization software, you can receive meeting requests. When connecting directly to an e-mail server, the server must be running Microsoft Exchange Server version 5.5 or later for you to receive meeting requests. See [Synchronization software on page 58](#) for more information.

If the server is running Microsoft Exchange Server 2000 or later, your meeting requests are automatically received in your Inbox. However, to receive meeting requests on Microsoft Exchange Server 5.5, do the following:

- Ask your system administrator to activate Rich Text Format (RTF) and TNEF support for your account.

With TNEF enabled, your messages that are included in other messages as attachments are not received, and you cannot know if a message has an attachment until you get the full copy. In addition, download time might be longer.

- Change e-mail download options if your account is not set up to receive attachments.

After you are set up to receive meeting requests, do the following:

1. Open the meeting request.
2. Tap **Accept**, or **Menu > Tentative**, or **Menu > Decline**. If you want, you can also include a message with the response. The response will be sent the next time that you synchronize or connect to your e-mail server, and your device calendar will be updated.

Create or change a signature

1. Tap **Start > Messaging**.
2. Tap **Menu > Options**.
3. Tap **Accounts > Signatures...**
4. Select the account for which you want to create or change a signature.
5. Select the **Use signature with this account** check box if it is not already selected.
6. Select the **Use when replying and forwarding** check box if wanted.
7. Enter a signature in the box.

To stop using a signature, clear the **Use signature with this account** check box.

 **TIP:** You can use a different signature with each messaging account.

Use Messaging

Compose and send messages

1. In the message list, tap and select an account.
2. Tap **Menu > New**.
3. Enter the e-mail address of one or more recipients, separating them with a semicolon. To access addresses and phone numbers from **Contacts**, tap **To**.
4. Enter your message. To quickly add common messages, tap **Menu > My Text** and tap a required message.
5. To check the spelling, tap **Menu > Spell Check**.
6. Tap **Send**.

 **TIP:** To set the priority, tap **Menu > Message Options...**

 **NOTE:** If you are working offline, e-mail messages are moved to the **Outbox** folder and are sent the next time you connect.

Reply to or forward a message

1. Tap on the message to open it, and then tap **Menu > Reply**, **Reply All**, or **Menu > Forward**.
2. Enter your response. To quickly add common messages, tap **Menu > My Text** and tap a required message.
3. To check the spelling, tap **Menu > Spell Check**.
4. Tap **Send**.

 **NOTE:** If you want to keep the original text with the outgoing message, tap **Menu > Tools > Options...** then tap **Message**. You must select the **When replying to e-mail, include body** check box.

Add an attachment to a message

1. In an open message, tap **Menu > Insert** and tap the item you want to attach: **Picture**, **Voice Note**, or **File**.
2. Select the file you want to attach or record a voice note.

 **NOTE:** Embedded objects cannot be attached to messages.

Download messages

The manner in which you download messages depends on the type of account you have:

- To send and receive e-mail for an Outlook e-mail account, begin synchronization through ActiveSync.

 **TIP:** By default, messages you send are not saved on your device to help conserve memory. If you want to keep copies of sent messages in the messaging list, tap **Menu > Tools > Options... > Message**, and select the **Keep copies of sent items in Sent folder** check box. If your account is an Outlook E-mail or IMAP4 account, you must also select the Sent Items folder for synchronization. To do this, tap **Menu > Tools > Manage Folders...** and select the check box next to the **Sent Items** folder.

Download messages from a server

1. Tap **Menu > Go To** and tap the account you want to use.
2. Tap **Menu > Send/Receive**.

The messages on your device and e-mail server are synchronized. New messages are downloaded to the device **Inbox** folder, messages in the device **Outbox** folder are sent, and messages that have been deleted from the server are removed from the device **Inbox** folder.

 **TIP:** To read the entire message, tap **Menu > Download Message** while in the message window. If you are in the message list, tap and hold the message, and then tap **Menu > Download Message**. The message will download the next time you send and receive e-mail. This will also download message attachments if you have selected those options while setting up your e-mail account.

The size column in the message list displays the local size and server size of a message. These numbers might differ because the size of a message can vary between the server and the device.

Install an online address book

Many e-mail servers, including servers running Exchange Server, can verify names with an online address book called a directory service, using a protocol known as Lightweight Directory Access Protocol (LDAP). When you create an e-mail account, the directory service of your e-mail server is added to the **Address**, and you are given the option to enable it. After it is enabled, Messaging checks your contact list and then the directory service to verify names that you enter in the **To**, **Cc**, and **Bcc** fields. To enable a directory service or if you want to use additional services, follow these steps:

1. If you are adding a new account, ask your network administrator for the name of the directory service and the server.
2. In the message list, tap **Menu > Tools > Options... > Address**.
3. In the **In Contacts, get e-mail addresses from** list, select which e-mail address book to check in contacts. Contacts will be checked first unless you select **None**.

4. If your e-mail server is already listed, select the server's directory service check box to enable it and tap **ok**.
5. If your e-mail service is not listed, tap **Add...**
6. In the **Directory name** and **Server** boxes, enter the LDAP directory and server names.
7. Ask your network administrator if authentication is necessary for your server. If so, select the **Authentication is necessary on this server** check box, and enter your user name and password.
8. If you want the **Messaging** application to check this service, select the **Check name against this server** check box.

 **TIP:** To delete a service, tap and hold the service, and then tap **Delete**.

While synchronizing your Outlook E-mail account, disable any directory services you have installed by clearing the **Check name against this server** check box. This helps avoid getting error messages when Messaging tries to verify names against the service that you are not connected to.

Windows Live Messenger

You can use MSN Messenger on your HP iPAQ to send instant messages. MSN Messenger provides the same chat environment as of the MSN Messenger on your computer.

With the MSN Messenger feature, you can:

- Send and receive Instant Messages.
- Change your own status or view the status of others on your list.
- Invite others for a chat conversation.
- Block certain contacts from seeing your status or sending you messages.

To use MSN Messenger, you need a Microsoft.NET Passport account unless you already have a Hotmail account. To set up a Microsoft.NET Passport account, go to <http://www.passport.net>. After you have an account, you can use your HP iPAQ MSN Messenger feature.

Sign in and out of Messenger

Tap **Start > Programs > Messenger** to open MSN Messenger feature.

To sign into the Messenger:

1. Tap **Sign In** after navigating to a required sign-in status.
2. Enter your information in the **Sign-in** and **Password** box. Tap **Sign In**.

To sign out of the Messenger:

- ▲ Tap **Menu > Sign Out** to sign-out of MSN Messenger.

If you do not sign out of MSN Messenger, you remain on a data connection, which might result in additional charges from your service provider. The session will not time out or end unless one of the following occurs:

- User ends instant messenger session
- The device is turned off or moves out of range

Send instant messages

You can send Instant Messages from your MSN Messenger to contacts on your messenger list.

To send Instant Messages:

1. Select the person to whom you want to send an Instant Message and tap **Send**.
2. Enter your message, and tap **Send**.

You can also manage your contacts and control their visibility.

To manage contacts in the MSN Messenger:

- Tap **Menu > Add new contact** to create a new contact.
- Tap **Menu > Contact options > Delete** to delete an existing contact.
- Tap **Menu > Block/Unblock** to block or unblock the selected contact from seeing your status and sending you Instant Messages.

 **NOTE:** Tap **Menu > My Text** to add common messages when composing instant messages. Tap **Menu > Invite** to invite a contact to an ongoing chat. You can also see who is already talking to you or change between chats by tapping **Menu > Chats**.

Change your status

You can change your status on MSN Messenger according to your need. To change your status:

1. Tap and select your name in the contact list.
2. Press **Menu > Change Appearances**, and navigate to select the required status.

9 Calendar

Access calendar

Use Calendar to schedule appointments, including meetings and other events. You can display appointments for the day on the **Today** screen.

- ▲ To access Calendar, tap **Start > Calendar**.

Change the display of the work week

You can customize your calendar for a work week to start on Sunday or Monday. You can schedule your calendar for a five to seven-day week.

To change the display of the work week:

1. Tap **Start > Calendar**.
2. Tap **Menu > Tools > Options... > General**.
 - To specify the first day of the week, tap **Sunday** or **Monday** in the **1st day of week** box.
3. To specify the number of days to appear in a work week, tap **5-day week**, **6-day week**, or **7-day week** in the **Week view** box.
4. Tap **ok**.

Set a default reminder for all new appointments

To automatically turn on a reminder for all new appointments:

1. Tap **Start > Calendar**.
2. Tap **Menu > Tools > Options... > Appointments**.
3. Select the **Set reminders for new items** check box.
4. Set the time for the reminder to alert you.
5. Tap **ok**.

Create an appointment

To create an appointment:

1. Tap **Start > Calendar**.
2. Tap **Menu > New Appointment > Appointment**.
3. Enter the required information, and then tap **ok**.

Update an appointment

To update an appointment on your calendar:

1. Tap **Start > Calendar**.
2. Tap the appointment, and then tap **Menu > Edit** to make your changes.
3. Tap **ok**.

Cancel an appointment

When you delete an appointment in calendar on your HP iPAQ, it is also deleted on your computer the next time you synchronize. If the appointment has not been synchronized with a computer, it will be deleted only from your HP iPAQ.

1. Tap **Start > Calendar**.
2. Tap to select the appointment you want to delete, and then tap **Menu > Delete Appointment**.
3. Tap **Yes** to delete the appointment, or tap **No** to keep it.

 **NOTE:** Calendar items can be deleted only from the **Agenda** view or from an open calendar appointment. To delete from other views, open the appointment, and tap **Menu > Delete**.

10 Contacts

Create a contact

1. Tap **Start > Contacts**.
2. Tap **New** and enter the contact information.
3. Tap **ok**.

 **NOTE:** If your contact list has been filtered by a category when you create a contact, that category is automatically assigned to the new contact.

If most of the contacts you create have phone numbers that begin with the same area code, in **Contacts**, tap **Menu > Options...** and enter that area code in the **Area code** box.

For more information on creating contacts, tap **Start > Help**.

Delete a contact

1. On the **Today** screen, tap **Contacts** or **Start > Contacts**.
2. Tap and hold the contact to delete.
3. Tap **Delete Contact**.
4. Tap **Yes** to confirm the deletion.

Change contact information

1. On the **Today** screen, tap **Contacts** or **Start > Contacts**.
2. Tap the required contact.
3. Tap **Menu > Edit** and enter the changes.
4. Tap **ok**.

Copy a contact

1. On the **Today** screen, tap **Contacts** or **Start > Contacts**.
2. Tap and hold the contact you want to copy.
3. Tap **Copy Contact**.
4. Tap the copy of the contact.
5. Tap **Menu > Edit**.
6. Change the contact information as needed and tap **ok**.

 **NOTE:** The displayed category is automatically assigned to the new contact.

Find a contact

1. On the **Today** screen, tap **Contacts** or **Start > Contacts**.
2. If you are not in the **Name** view, tap **Menu > View By > Name**.
3. Do one of the following:
 - Begin entering a name or phone number in the provided text box until the contact you want is displayed. To show all contacts again, tap the text box and clear the text, or tap the arrow to the right of the text box.
 - Use the alphabetical index displayed at the top of the contact list.
 - Filter the list by categories. In the contact list, tap **Menu > Filter**. Then tap a category you have assigned to a contact. To show all contacts again, tap **All Contacts**.

 **NOTE:** To search for a contact by entering a name or number, or by using the alphabetical index, you need to be in the **Name** view.

Send an e-mail message to a contact

1. On the **Today** screen, tap **Contacts** or **Start > Contacts**.
2. Tap the contact you want to send a message to.
3. Tap the address you want to send a message to.
4. Tap the account you want to send the message from.

 **NOTE:** To quickly add a contact's address to a new message, tap **To**, **Cc**, or **Bcc**, and then tap **Menu > Add Recipient....** Tap the contact you want to send the message to and choose the address, if necessary.

Add and remove a picture

To add a picture to the contact information:

1. On the **Today** screen, tap **Contacts** or **Start > Contacts**.
2. Tap the contact.
3. Tap **Menu > Edit**.
4. Tap **Picture**.
5. Tap the picture you want to add.

To remove a picture from the contact information:

1. On the **Today** screen, tap **Contacts** or **Start > Contacts**.
2. Tap the contact.
3. Tap **Menu > Edit**.
4. Tap **Menu > Remove Picture**.

Use the contact list

There are several ways to use and customize the contact list. Here are a few tips on how to make it work for you.

1. On the **Today** screen, tap **Contacts** or **Start > Contacts**.
2. In the contact list, do any of the following:
 - To search for a contact by entering a name or number, or by using the alphabetical index, enter the name or number into the **Enter a name...** box.
 - To see a list of contacts employed by a specific name or company, tap **Menu > View By > Name** or **Company**.
 - To see a list of available actions for a contact, tap and hold the contact.

 **NOTE:** To display a greater number of contacts on the screen, tap **Menu > Options...**, select the **Show contact names only** check box, and clear the **Show alphabetical index** check box.

11 Applications

HP applications

HP Help and Support

The **HP Help and Support** application increases visibility, accessibility, and usability of the existing help, support.

To access **HP Help and Support**:

1. Tap **Start > Programs > HP Help and Support**.
2. To view additional information, tap the appropriate HTML links.
 - **Serial and Model Numbers** – displays the product's serial number, model ID, product ID, and OS version.
 - **HP iPAQ QuickStart Tour** – launches the **HP iPAQ QuickStart Tour** application.
 - **HP iPAQ Tips** – launches the **HP iPAQ Tips** application.
 - **Help Topics** – launches a table of content that lists help topics for programs installed on your iPAQ.
 - **Customer Support** – launches the **Find More Information** screen, which lists the sources for information on various topics.
 - **System Details** – launches the **HP Asset Viewer** application.



NOTE: Tap **About** to view the application name, version number, and copyright information.

HP iPAQ Setup Assistant

Use HP iPAQ Setup Assistant to simplify configuring settings on your HP iPAQ.

HP iPAQ Setup Assistant lets you save the settings on your computer. This can help you restore configuration settings on your HP iPAQ at any time. HP iPAQ Setup Assistant also allows you to perform a factory reset on your HP iPAQ and view detailed product information.

Using HP iPAQ Setup Assistant, you can manage multiple configurations and apply them quickly to your HP iPAQ. You can create a new configuration, modify existing settings, delete a selected configuration, or apply selected settings to your HP iPAQ.

Select the following tabs to configure your settings:

- **Owner Information** – Enter your identification information and notes to describe you and your HP iPAQ. This is helpful if you lose your HP iPAQ.
- **Wireless Network** – Wireless Network settings describe the configuration needed to connect to your work, home, or other wireless network.
- **Proxy** – Proxy servers are located between two networks and are used to help prevent an attacker from invading a private network. You can enter proxy settings to specify the proxy configuration for your network.

- **E-mail** – E-mail settings describe the configuration required to connect to and check your Internet e-mail accounts.
- **Exchange Server** – Exchange Server is used to access e-mail, calendars, contacts, tasks, and other mailbox contents while on the go. You can set up Outlook on your HP iPAQ to synchronize directly with your organization's Exchange Server.
- **VoIP** – Voice over Internet Protocol (VoIP) routes voice conversations using an IP-based network. VoIP to VoIP phone calls to any provider are typically free. SIP Proxy servers are used to implement call-routing policies and provide features to users.
- **Browser Favorite** – Use your HP iPAQ Setup Assistant to create and manage a list of your favorite URLs. You can access these URLs using the Internet Explorer on your HP iPAQ.
- **Finish** – In case of a new configuration, after you click **Finish**, enter a configuration name and an optional password, and then click **OK** in the save configuration. If this is an existing configuration, the existing name and password will be used.

HP Asset Viewer

Using the HP Asset Viewer application to view information about the system, integrated modules, and attached accessories.

To access Asset Viewer:

1. Tap **Start > Settings > System > HP Asset Viewer**.
2. To view additional system information, tap the appropriate tabs:
 - The **Identity** tab displays the serial number and the user information.
 - The **Memory** tab displays the iPAQ device memory information.
 - The **Version** tab displays the iPAQ device version information.
 - The **Display** tab displays the iPAQ device display panel information.
 - The **System** tab displays the iPAQ device system information.
 - The **Bluetooth** tab displays the iPAQ device Bluetooth information.
 - The **WLAN** tab displays the iPAQ device WLAN information.

Certificate Enroller

Certificate Enroller is an enhanced security feature for retrieving and registering new certificates. This application-initiated enrollment allows you to request a user certificate from a certificate server.

 **NOTE:** Certificate Enroller picks up certificate types from Active Directory as well as from the device data store. You must enter a server name for retrieving the certificate, and if required, a valid username and password.

To access Certificate Enroller:

1. Tap **Start > Programs > Enroller**.
2. Use the on-screen keyboard to enter server name, user name, and password. Tap **ok** to save the settings.

 **NOTE:** Tap **Retrieve** to initiate the transaction of downloading the certificate from the server.

3. Once the certificate is retrieved, tap **Menu > Cancel** to exit.

 **NOTE:** Tap **Menu > About** to view a brief description of the application, application name, version number, and copyright statement.

Manage certificates

1. Tap **Start > Settings > System > Certificates**.
2. Select a certificate tab.
 - The **Personal** tab displays your personal certificates.
 - The **Intermediate** tab displays the intermediate certification authorities.
 - The **Root** tab displays the root certification authorities.

 **NOTE:** To view the certificate details, tap the required certificate on each tab.

HP iPAQ Tips

Use **HP iPAQ Tips** to perform operations on your HP iPAQ in a quick and efficient manner. A tip is displayed on your screen every time you switch on your HP iPAQ. Tap **Next** to display the next tip. To quit the application, tap **Menu > Exit**. You can also access **HP iPAQ Tips** by tapping **Start > Programs > HP Help and Support > HP iPAQ Tips**.

 **TIP:** You can also access the **HP iPAQ Tips** application by tapping **Start > Programs**.

HP iPAQ QuickStart Tour

HP iPAQ QuickStart Tour is a fun way to learn more about your HP iPAQ. It provides basic information about the tasks and activities you can perform using your HP iPAQ. You can try each feature as you go through this tutorial. You can return to the same position in the QuickStart tour by simply tapping **Start > Programs > HP Help and Support > HP QuickStart Tour**.

 **TIP:** You can also access the **HP iPAQ QuickStart** application by tapping **Start > Programs**.

HP iPAQ Zip

Use the **HP iPAQ Zip** application to:

- View and extract contents of a zip file received as an e-mail attachment.
- View and extract contents of a zip file using the file explorer.
- Open a selected item from the zipped file.
- Extract/view encrypted files.

To view the file contents, tap the required zip file. This will display the filename, the date and time when the file was last modified, and the file size.

Tap **Open** to open a file you want to view. This file will open as a Read Only document.

Tap **Menu**, and then tap the following commands to perform the respective functions:

- **Extract all:** Extract all the files at the same time to the user directory.
- **Extract:** Extract the selected files to the user directory.
- **View:** Change the display layout of the file. The contents of the zipped file can be displayed as details, list, icons, or tiles.

- **About:** Display the version of the **HP iPAQ Zip** application.
- **Exit:** Exit from the **HP iPAQ Zip** application.

 **NOTE:** You will not be able to open or extract files that are larger than 20 MB in size.

If the zip file is encrypted using a password, the **HP iPAQ Zip Password** screen is displayed when you try to open any of the zip file contents. Type the appropriate password in the **Enter Password** box using the on-screen keyboard to view the required files.

HP Enterprise Mobility Agent

Use the  **HP Enterprise Mobility Agent** to help you easily configure and manage your HP iPAQ.

Visit <http://redirect.hp.com/svs/rdr> to download and install the  **HP Enterprise Mobility Agent**.

After you install the  **HP Enterprise Mobility Agent**, the application will configure, download, and install different applications from the Internet on your HP iPAQ. This application requires WLAN connection with access to internet.

Windows Media Player

Windows Media Player 10 Mobile

Windows Media Player 10 Mobile has enhanced features that allow you to enjoy your digital media both at home and on the go. The personal computer version of Windows Media Player 10 can be downloaded for free from Microsoft.

With this version of media player, you can:

- Sync your music, photos, videos, and recorded TV to your HP iPAQ for easy enjoyment on the go.
- Automatically convert video and recorded TV during sync to an optimized and size-reduced format for better viewing on your HP iPAQ.
- Manually select digital media to sync to your HP iPAQ, or automatically sync to your HP iPAQ each time you connect, based on your preferences.

For a complete list of features and more, visit <http://www.microsoft.com/windowsmedia>.

 **NOTE:** Protected files are digital media files that are secured with a license to prevent unauthorized use or playback. Licenses are created and managed by using the DRM technology. To learn more about Windows Media DRM 10, protected files, and other features, refer to the on-screen help by tapping **Start > Help > Contents > Search > Using Windows Media Player Mobile**.

Clear the Now Playing list

Under Windows Media Player, the Now Playing playlist displays the currently playing file and any files that are queued up to play next. You can quickly remove all items from the playlist by clearing it.

1. If you are on the Library screen, select the **Now Playing** category to display the **Now Playing** screen. If you are on the **Playback** screen, select **Now Playing** to display the **Now Playing** screen.
2. On the Now Playing screen, tap **Menu > Clear Now Playing**.

For more details, refer to the on-screen help, tap **Start > Help > Contents > Using Windows Media Player Mobile**.

Update a Library

In most cases, Windows Media Player Mobile automatically updates your libraries as necessary. However, you can manually update a library to ensure that it has links to any new files that you might have recently copied to your HP iPAQ or a removable storage card.

1. If you are not already on the Library screen, tap **Menu > Library...**
2. On the **Library** screen, tap **Menu > Update Library...**
3. Wait for the files to be added, and then tap **Done**.

For more details, refer to the on-screen help, tap **Start > Help > Contents > Using Windows Media Player Mobile**.

MS Office applications

Word Mobile

You can create and edit documents and templates in Word Mobile. You can also save the documents and templates as .doc, .rtf, .txt, and .dot files.

With Word Mobile, you can:

- Edit Word documents and templates created on your computer.
- Open and edit Pocket Word (*.psw) documents

 **NOTE:** If you edit a document, you will need to save it in .doc, .rtf, .txt, or .dot format.

To access Word Mobile, tap **Start > Office Mobile > Word Mobile**.

Options available when you tap **Menu** allow you to:

- Create a new document or edit an existing document.
- Format a document.
- Check spellings and count words in a document.
- Save, move, rename, or delete a document.
- Send a document via e-mail or Bluetooth.

Excel Mobile

You can create and edit workbooks and templates on your HP iPAQ with Excel Mobile.

With Excel Mobile, you can:

- View, edit, and create charts and graphics, which can be embedded as objects in a worksheet or placed on a separate worksheet.
- Enter formulas and functions, and then filter data to see the subset of information you want.
- Split panes to view different parts of a worksheet at the same time.
- Freeze the top and left-most panes in a worksheet to keep row and column labels or other data visible as you scroll through a sheet.

To access Word Mobile, tap **Start > Office Mobile > Excel Mobile**.

To access options for organizing and formatting a worksheet, open a worksheet and tap **Menu**. In addition to **Cut**, **Copy**, and **Paste**, there are options in **Menu** that allow you to:

- Paste cells using **Paste Special**.
- Clear cell contents and formats applied to cells.
- Insert new cells, charts, symbols, functions, and define names in a workbook.
- Set dimensions for rows and columns. Align cells, set font and style for the text, and set cell borders.
- Create new worksheets and save, rename, or delete existing worksheets.
- Send a worksheet via e-mail or Bluetooth.

PowerPoint Mobile

Use PowerPoint Mobile to open and view slide show presentations created on your computer.

With PowerPoint Mobile, you can:

- Open a presentation from an e-mail message.
- Download a presentation from a file share or the Internet.
- Copy a presentation to your HP iPAQ via a storage card.

 **NOTE:** Slide shows created in *.ppt or *.pps format with PowerPoint '97 and later can be viewed on your device.

PowerPoint features that are not supported on your HP iPAQ include:

- Notes: Notes written for slides are not visible.
- Rearranging or editing slides: PowerPoint Mobile is a viewer only.

To access Word Mobile, tap **Start > Office Mobile > PowerPoint Mobile**.

Options available when you tap **Menu** allow you to:

- Set up a slide show.
- Rename, move, delete, or create a copy of a presentation.
- Send a presentation via e-mail or Bluetooth.

PDF viewer

The ClearVue PDF application lets you view any PDF document on your HP iPAQ. To access this application:

1. Tap **Start > Programs > ClearVue PDF**.
2. Tap **File > Open... >** to open a PDF.
3. Tap **Zoom** to select the appropriate option for better viewing.
4. Tap **File > Exit** to quit the application.

Games

Bubble Breaker

The objective of Bubble Breaker is to have balls (more than one) of the same color deleted from the screen. The fewer balls you leave behind, the higher your score will be.

To start a new game:

1. Tap **Start > Programs > Games > Bubble Breaker**.
2. Tap **New Game** to start a new game.
3. Tap **Menu > Statistics** to select a style to display relative entries.
4. Tap **Menu > Options...** to edit the settings for the game.

 **NOTE:** To recall the balls you deleted, tap **Menu > Undo Move**.

To play a game:

1. Tap **Start > Programs > Games > Bubble Breaker**.
2. Tap **New Game** to start a new game.
3. Scroll and select a ball which is of the same color as the other balls around.
4. Tap the selected balls twice to delete the balls from the screen.

Solitaire

The objective of Solitaire is to use all the cards in the deck to build up four suit stacks in ascending order, beginning with the aces. You win the game when all cards are on the suit stacks.

To play a game:

1. Tap **Start > Programs > Games > Solitaire**.
2. Tap **Menu > New Game** to start a new game.
3. Tap and hold the card you want to move and drag it to the card stack to which you want to move the card.
4. Move any aces on the seven stacks to the four card spaces at the top of the screen, and then make any other available plays.
5. Tap a card twice to move it to the four card stack on the upright corner of the screen if it belongs there. The card that is faced up on the four card stacks is always available for play.
6. When you have made all the available plays, tap **Draw** to turn over cards.

Internet Explorer

Use Internet Explorer to view and download Web pages as well as browse Web sites through synchronization or when connected to the Internet.

Before connecting to the Internet, setting up a wireless connection or network card, you need to obtain the following:

- ISP or wireless service provider
- ISP server phone number or access point
- User name and password

You can learn more about Internet Explorer by tapping **Start > Help > Contents > Browse the Web**.

To access Internet Explorer, tap **Start > Internet Explorer**.

12 Notes

Write a note

1. Tap **Start > Programs > Notes**.

 **NOTE:** **Writing** must be selected as the default input mode.

2. Tap **New**.
3. Write your text on the screen.
4. Tap **ok** to return to the note list.

To select the handwritten text, tap and hold next to the writing. As soon as dots appear and before they form a complete circle, quickly drag across the writing.

If the writing crosses three ruled lines, it is treated as a drawing rather than text.

Create a copy of a note

To create a copy of a note:

1. Tap **Start > Programs > Notes**.
2. Tap the note you want to copy.
3. Select the text on the screen, and then tap **Menu > Copy**.
4. Open the required note from the note list or a new note to which the selected content is to be copied.
5. Tap **Menu > Paste**.



If you paste the contents in a new note, a copy of the note displays in the note list.

Create a voice note

To create a stand-alone recording (voice note) or add a recording to a note:

1. Tap **Start > Programs > Notes**.
2. Do one of the following:
 - To create a stand-alone recording, record from the note list.
 - To add a recording to a note, create or open a note.

 **NOTE:** If the Recording toolbar does not appear, tap **Menu > View Recording Toolbar**.

3. Tap the  (Record) button.
4. Speak into the microphone located at the bottom of the unit.
5. When finished recording the note, tap the  (Stop) button on the Recording Toolbar.
6. Tap **ok** to return to the note list.

 **NOTE:** If recording in an open note, an icon displays in the note. If creating a stand-alone recording, an icon displays in the note list.

Also, you can create a voice note in Photosmart Mobile and attach the note to a picture.

13 Storage cards

Storage cards

Use optional storage cards for:

- Expanding the memory of your HP iPAQ
- Adding functionality

 **NOTE:** Storage cards must be purchased separately and are not included with your HP iPAQ.

To locate information about storage cards, visit <http://www.hp.com/accessories/ipaq>.

Insert a storage card

To insert a storage card into the storage card slot on your HP iPAQ:

1. Locate the storage card slot on the side of your HP iPAQ.
2. Open the protective cover.
3. Insert the storage card into the storage card slot and push the connection edge of the card firmly into the storage card slot.

 **NOTE:** If your storage card is not recognized, follow the card manufacturer's instructions to install it.

If you have trouble inserting a storage card, try the following:

- Make sure the label is facing down.
- Make sure you are not inserting the card at an angle.
- Make sure you insert the connection area (the metal area) first.

Remove a storage card

To remove a storage card from the storage card slot on your HP iPAQ:

1. Close all programs that are using the storage card.
2. Remove the card from the storage card slot by lightly pushing on the card to unlock it.
3. When the card disengages and pops out, pull it from the storage card slot.

View content of a storage card

Use File Explorer to view the files that are located on your optional storage card.

1. Tap **Start > Programs > File Explorer**.
2. Navigate to select the **Memory Card** folder to see a list of files and folders.

If the HP iPAQ does not recognize your storage card, try the following:

- Make sure you have firmly pushed the storage card into the storage slot.
- Make sure to install any drivers that came with the storage card.

14 Synchronization

Synchronization software

If your computer is running Windows XP or an earlier version, synchronization settings are managed through Microsoft ActiveSync. Microsoft ActiveSync 4.5 is available on the *Getting Started* CD. You can also visit <http://www.microsoft.com/windowsmobile> for more information or to download Microsoft ActiveSync.

If your computer is running Windows Vista, synchronization settings are managed through Windows Mobile Device Center (WMDC). WMDC 6.1 is available on the *Getting Started* CD. You can also visit <http://www.microsoft.com/windowsmobile> to download WMDC.

Copy files

You can copy files to and from the computer using ActiveSync.

To copy files using ActiveSync:

1. Connect your HP iPAQ to the computer using the mini-USB synchronization cable.
2. On the computer, select **Start > Programs > ActiveSync**.
3. In the **ActiveSync** window, select **Explore**.
4. Double-click **Windows Mobile-Based Device**.
5. Open **Windows Explorer** on your computer and locate the files to be copied.

 **NOTE:** You cannot copy preinstalled files or system files.

6. Drag and drop the files between your HP iPAQ and the computer. ActiveSync converts the files so that they can be used by the Office Mobile programs, if necessary.

To copy files using WMDC:

1. Connect your HP iPAQ to the computer and wait for WMDC to launch automatically.
2. Click **File Management** to open the Mobile Device folder for your device.
3. In the **Mobile Device** folder, navigate and select the file that you want to copy on your device or computer.

Move the files directly into My Documents on your HP iPAQ (or into a folder inside My Documents).

Migrate data from Palm Desktop to Microsoft Windows Mobile 6.0

If you used a Palm OS based device before purchasing your HP iPAQ, you need to migrate your data from the Palm Desktop software to Microsoft Windows Mobile 6.0.

To migrate data from Palm Desktop to Windows Mobile 6.0:

1. Ensure that you have Microsoft Outlook 98 or higher installed on your computer.
 2. Insert the Companion CD that came with your Palm unit into your computer's CD-ROM drive. From the **Discover Your Handheld** screen, select **Install Microsoft Conduits**. Alternatively, you may reinstall the Palm Desktop software. During the configuration process, select **Synchronize your handheld with Microsoft Outlook and Palm Desktop software**.
-
-  **NOTE:** Microsoft Outlook must be set as your default e-mail program to properly synchronize with the Palm Desktop software. If you need to change your settings, open Microsoft Outlook, then click **Tools > Options > Other** tab and check the **Make Outlook the default program for E-mail, Contacts**, and **Calendar** check box. Click **Apply > OK**, and then restart your computer.
-
3. Use the HotSync software located on the Companion CD that came with your Palm unit to synchronize your Palm information with Outlook. Refer to the instructions that came with your Palm unit for help installing or using HotSync.
 4. When Outlook is synchronized with your Palm device, uninstall Hotsync from your computer. Click **Start > Control Panel > double-click Add or Remove Programs**. Select **Palm Desktop**, then click **Remove**. Follow the on-screen instructions.
 5. Insert the *Getting Started* CD into your computer's CD-ROM drive and follow the on-screen instructions to install ActiveSync on your computer and create a partnership between your HP iPAQ and your computer.

Wireless synchronization cost saving tips

How you manage the cost of wireless synchronization from your HP iPAQ depends on your priorities.

To	Do this
Reduce network connection or data transfer costs	Increase the time between scheduled synchronizations or synchronize manually. Check the details of your rate plan.
Extend battery life	Schedule synchronization less frequently or synchronize manually.
Keep your information up to date	During periods of high mail volume, schedule synchronization at regular but frequent intervals. During periods of low mail volume, schedule synchronization as items arrive.

 **NOTE:** The device power-down timer is reset each time you synchronize. If you schedule a synchronization interval that is smaller than the time interval set for the device to automatically power down, the device never turns off to save battery power.

Troubleshoot synchronization issues

Following is a list of symptoms that might indicate synchronization issues:

- No ActiveSync tone plays (or a gray icon displays), and there is no activity in the **Microsoft ActiveSync** window on your computer.
- ActiveSync tone plays, and the ActiveSync icon on your computer changes to a swirling green icon. The **Retrieving settings** message displays on your computer, but the ActiveSync connection drops prior to establishing the partnership.

- ActiveSync is searching for a connection but cannot establish one. (The green icon on your computer continues to spin.)
- Synchronization has been established between your HP iPAQ and computer but connection has dropped. (The green icon on your computer stops spinning and grays out.)
- The firewall or other network protection software message box is displayed when ActiveSync tries to access the network or Internet.
- WMDC does not launch even after installation.

Here is a list of tips to help you troubleshoot synchronization issues:

- Check the OS on your computer before you begin synchronizing information between your HP iPAQ and computer. The synchronization method varies depending on the OS running on the computer.



NOTE: HP does not guarantee the accurate functionality of any third party applications with Windows Vista.

- If you are running ActiveSync 4.5 or WMDC 6.1 and personal firewall software on your computer, please add ActiveSync 4.5 or WMDC 6.1 to the firewall program's exception list.

(Firewall software, such as Sygate Personal Firewall, TrendMicro PC-cillin Internet Security 2005, Norton Personal Firewall, McAfee Personal Firewall, or Zone Alarm Security Suite might block synchronization.) Refer to the documentation that came with your firewall program to determine how to add ActiveSync 4.5 or WMDC 6.1 to the program's exception list. To further troubleshoot a firewall application, visit: <http://www.microsoft.com/windowsmobile>.
- During the ActiveSync installation, if you inadvertently selected the **Microsoft Exchange Server** check box and are not planning to connect to an Exchange server, follow these steps:
 - Connect your HP iPAQ to your computer. Make sure an ActiveSync connection is established.
 - On your computer, click **Start > All Programs > Microsoft ActiveSync**.
 - Click **Tools > Options**.
 - Clear the boxes for the sync items listed under the Server group.
 - Select the check boxes under the **Computer group** for those items you want to synchronize.
- Disconnect your HP iPAQ from your computer and wait for the ActiveSync or WMDC message confirming that your device is no longer connected. Reconnect your HP iPAQ to your computer. Wait to see if your HP iPAQ connects to your computer.
- On your computer, in the ActiveSync application, select **File > Connection Settings**. Confirm that USB is selected as a potential connection method.
- Connect your HP iPAQ to a different USB port on your computer.
- Check your mini-USB synchronization cable. Consider using another mini-USB synchronization cable, if available.
- Try synchronizing via a Bluetooth connection.

- Restart your computer and HP iPAQ and reconnect your iPAQ to your computer.
- Uninstall ActiveSync or WMDC from your computer, and then reinstall it.
 - To uninstall ActiveSync from your computer, click **Start > Control Panel > Add or Remove Programs > Microsoft ActiveSync**. Then click **Remove > Yes**.
 - To uninstall WMDC from your computer, click **Start > Control Panel > Uninstall or Change a Program > Windows Mobile Device Center** and **Windows Mobile Device Center Driver Update**. Then click **Uninstall**.

After trying the above solutions without any success in solving your connection problem, perform a factory reset on your HP iPAQ using the HP iPAQ Setup Assistant.

You can reinstall applications on your HP iPAQ after the hard or clean reset is complete by using ActiveSync or WMDC on your computer.

After your HP iPAQ is synchronized properly, do the following:

- For ActiveSync, select **Tools > Add/Remove Programs**, and then select any programs you want to reinstall.
- For WMDC, when the device is not synchronizing, select **Programs and Services > Add/Remove Programs**. Select the programs you want to reinstall and click **OK**.

15 Tasks

Set start and due dates for a task

1. Tap **Start > Programs > Tasks**.
2. Tap the task you want to set start and due dates for.
3. Tap **Edit** and do one or both of the following:
 - Tap **Starts** to enter a start date for the task.
 - Tap **Due** to enter a due date for the task.
4. Tap **ok**.

Show start and due dates in the task list

1. Tap **Start > Programs > Tasks**.
2. Tap **Menu > Options...**
3. Select the **Show start and due dates** check box.
4. Tap **ok**.

Set options for displaying tasks on the Today screen

If you have a large number of tasks, you might want to specify the kind of tasks that are displayed on the **Today** screen.

1. Tap **Start > Settings > Personal > Today**.
2. Tap **Items**, and then select the **Tasks** check box.
3. Tap **Tasks** to access options, then tap **Options...**
4. Under **Display number of**, select the type of tasks to appear on the **Today** screen.
5. In the **Category** list, select whether to display only tasks assigned to a specific category or to display all tasks.

Mark a task as completed

To mark a task as completed:

1. Tap **Start > Programs > Tasks**.
2. In the task list, select the check box next to the task you want to mark as completed.

To mark an open task as completed:

1. Tap **Edit**.
2. In the **Status** box, tap **Completed**.

16 Product specifications

System specifications

 **NOTE:** Not all models described are available in all countries/regions. For more information on specifications for your particular model, on your HP iPAQ, tap **Start > Settings > System > AssetViewer**.

System Feature	Description
Processor	Marvell® PXA 310
Operating System	Microsoft® Windows Mobile 6.0
Memory	256 MB Flash & 64 MB SDRAM
External Power	Power adapter: input 100–200 Vac, 200 mA, 50 to 60 Hz and output +5 Vdc, 1 A USB charger: 5 Vdc, 100/500 mA
Display	3.5 inches QVGA TFT with touch screen
SD Slot	Supports SD memory
Headphone Jack	3.5 mm with 3 and 4 pin support for stereo or VoIP headphone
Antenna	Internal WLAN and Bluetooth antennas
Audio	Speaker, and one 3.5 mm stereo headset jack
Battery	1200 mAh Li-Ion removable/rechargeable battery
Bluetooth	Bluetooth 2.0, Profiles: Handsfree/ OBEX/ PAN/ FTP/ Serial Port/ A2DP, 10 m range (approximately 33 ft)— High-speed, low-power, short-range wireless communication with other Bluetooth devices
WLAN	IEEE 802.11b/g

Physical specifications

	US	Metric
Length	4.59 inches	116.7 mm
Width	2.71 inches	68.9 mm
Depth	0.54 inches	13.6 mm
Weight	<ul style="list-style-type: none">• With battery: 4.08 oz• Without battery: 3.17 oz	<ul style="list-style-type: none">• With battery: 115.8 g• Without battery: 89.9 g

Operating environment

		US	Metric
Temperature	Operating	32° to 113° F	0° to 45° C
	Non-operating	-4° to 140° F	-20° to 60° C
Relative Humidity	Operating	30% to 85%	30% to 85%
	Non-operating	90%	90%
Maximum Altitude	Operating	15000 ft	4572 m
	Non-operating	40000 ft	12,192 m

17 Regulatory notices

Federal Communications Commission Notice

This equipment has been tested and found to comply with the limits for a Class B digital device, pursuant to Part 15 of the FCC Rules. These limits are designed to provide reasonable protection against harmful interference in a residential installation. This equipment generates, uses, and can radiate radio frequency energy and, if not installed and used in accordance with the instructions, may cause harmful interference to radio communications. However, there is no guarantee that interference will not occur in a particular installation.

If this equipment does cause harmful interference to radio or television reception, which can be determined by turning the equipment off and on, the user is encouraged to try to correct the interference by one or more of the following measures:

- Reorient or relocate the receiving antenna.
- Increase the separation between the equipment and receiver.
- Connect the equipment to an outlet on a circuit different from that to which the receiver is connected.
- Consult the dealer or an experienced radio or television technician for help.

Modifications

The FCC requires the user to be notified that any changes or modifications made to this device that are not expressly approved by HP may void the user's authority to operate the equipment.

Cables

To maintain compliance with FCC Rules and Regulations, connections to this device must be made with shielded cables having metallic RFI/EMI connector hoods.

Declaration of Conformity for Products Marked with the FCC Logo (United States Only)

This device complies with Part 15 of the FCC Rules. Operation is subject to the following 2 conditions:

1. This device may not cause harmful interference.
2. This device must accept any interference received, including interference that may cause undesired operation.

If you have questions about the product that are *not* related to this declaration, write to

Hewlett-Packard Company
P. O. Box 692000, Mail Stop 530113
Houston, TX 77269–2000

or call 1–800–HP–INVENT (1–800–474–6836)

For questions regarding this FCC declaration, write to

Hewlett-Packard Company
P. O. Box 692000, Mail Stop 510101
Houston, TX 77269–2000

or call HP at 281–514–3333

To identify your product, refer to the part, series, or model number located on the product.

Canadian Notice

This Class B digital apparatus meets all requirements of the Canadian Interference-Causing Equipment Regulations.

Avis Canadien

Cet appareil numérique de la classe B respecte toutes les exigences du Règlement sur le matériel brouilleur du Canada.

European Union Notice

Products bearing the CE marking comply with the following EU Directives:

- Low Voltage Directive 2006/95/EC
- EMC Directive 2004/108/EC

CE compliance of this product is valid only if powered with the correct CE-marked AC adapter provided by HP.

If this product has telecommunications functionality, it also complies with the essential requirements of the following EU Directive:

- R&TTE Directive 1999/5/EC

Compliance with these directives implies conformity to harmonized European standards (European Norms) that are listed in the EU Declaration of Conformity issued by HP for this product or product family. This compliance is indicated by one of the following conformity markings placed on the product.

- This CE marking is valid for non-telecommunications products and for EU harmonized telecommunications products, such as Bluetooth®.



- This CE marking is valid for EU non-harmonized telecommunications products.



*If applicable, a notified body number is used. Refer to the regulatory label provided on this product.

Hewlett-Packard GmbH, HQ-TRE, Herrenberger Strasse 140, D-71034 Böblingen, Germany

The telecommunications functionality of this product may be used in the following EU and EFTA countries:

Austria, Belgium, Bulgaria, Cyprus, Czech Republic, Denmark, Estonia, Finland, France, Germany, Greece, Hungary, Iceland, Ireland, Italy, Latvia, Liechtenstein, Lithuania, Luxembourg, Malta, Netherlands, Norway, Poland, Portugal, Slovak Republic, Romania, Slovenia, Spain, Sweden, Switzerland, and United Kingdom.

Products with 2.4–GHz Wireless LAN Devices

France

L'utilisation de cet équipement (2.4GHz wireless LAN) est soumise à certaines restrictions: cet équipement peut être utilisé à l'intérieur d'un bâtiment en utilisant toutes les fréquences de 2400 à 2483.5MHz (Chaîne 1–13). Pour une utilisation en environnement extérieur, vous devez utiliser les fréquences comprises entre 2454 à 2483.5–MHz (Chaîne 10–13). Pour les dernières restrictions, voir <http://www.art-telecom.fr>.

For 2.4–GHz wireless LAN operation of this product, certain restrictions apply. This equipment may use the entire–2400–MHz to 2483.5–MHz frequency band (channels 1 through 13) for indoor applications. For outdoor use, the 2454–MHz to 2483.5–MHz frequency band (channels 10 through 13) may not be used. For the latest requirements, see <http://www.art-telecom.fr>.

Italy

E' necessaria una concessione ministeriale anche per l'uso del prodotto. Verifici per favore con il proprio distributore o direttamente presso la Direzione Generale Pianificazione e Gestione Frequenze.

License required for use. Verify with your dealer or directly with the General Direction for Frequency Planning and Management (Direzione Generale Pianificazione e Gestione Frequenze).

Battery Warning

-
- ⚠ **WARNING!** This HP iPAQ contains a lithium ion rechargeable battery. To reduce the risk of fire or burns, do not disassemble, crush, puncture, short external contacts, or dispose of in fire or water. Replace only with the HP spare.
 - ⚠ **CAUTION:** Risk of explosion if battery is replaced by an incorrect type. Dispose of used batteries according to the instructions.
-

Battery Recycling

HP encourages customers to recycle used electronic hardware, HP original print cartridges, and rechargeable batteries. For more information about recycling programs, visit <http://www.hp.com/recycle>.

Battery Disposal

-
- ⚠ **WARNING!** When a battery has reached the end of its useful life, do not dispose of the battery in general household waste. Follow the local laws and regulations in your area for computer battery disposal.
-



Equipment Warning

⚠ WARNING! To reduce the risk of personal injury, electrical shock, fire or damage to the equipment:

Plug the AC adapter into an AC outlet that is easily accessible at all times.

Disconnect power from the equipment by unplugging the AC adapter from the AC outlet or unplugging the synchronization cable from the host computer.

Do not place anything on the power cord or any of the other cables. Arrange them so that no one may accidentally step on or trip over them.

Do not pull on a cord or cable. When unplugging from the electrical outlet, grasp the cord by the plug or, in the case of the AC adapter, grasp the AC adapter and pull out from the electrical outlet.

Do not use converter kits sold for appliances to power your HP iPAQ.

Acoustics Warning

⚠ WARNING! Listening to this device at high volume levels and for extended durations may damage one's hearing. In order to reduce the risk of damage to hearing, one should lower the volume to a safe, comfortable level, and reduce the amount of time listening at high levels.



- For your own safety, before using headsets or earphones, always reset the volume. Some headphones are louder than other headphones, even if the volume control setting is the same.
- Changing the default audio or equalizer settings might lead to higher volume and should only be done with caution.
- Headsets or earphones used with this device should comply with the headphone limits in EN 50332-2.

Airline Travel Notice

Use of electronic equipment aboard commercial aircraft is at the discretion of the airline.

Medical Electronic Equipment

If you have a medical condition that requires you to use a pacemaker, hearing aid, or any type of medical electronic equipment, consult the manufacturer of the equipment to determine if the medical equipment is shielded from RF energy. Turn off your HP iPAQ in health care facilities or hospitals when there are posted restrictions requiring you to do so.

Wireless Notices

In some environments, the use of wireless devices may be restricted. Such restrictions may apply aboard airplanes, in hospitals, near explosives, in hazardous locations, etc. If you are uncertain of the policy that applies to the use of this device, please ask for authorization to use it prior to turning it on.

U.S. Regulatory Wireless Notice

⚠ WARNING! Exposure to Radio Frequency (RF) Radiation The radiated output power of this device is below the FCC radio frequency exposure limits. Nevertheless, the device should be used in such a manner that the potential for human contact during normal operation is minimized.

To avoid the possibility of exceeding the FCC radio frequency exposure limits, human proximity to the antenna should be minimized. No metallic body accessories are allowed and 1.5 cm spacing between PDA and the body must be maintained to satisfy RF Exposure.

This PDA has been tested and demonstrated compliance when Bluetooth and Wi-Fi are transmitting simultaneously. This PDA must not be co-located or operating in conjunction with any other antenna or transmitter.

Canadian Regulatory Wireless Notice

Operation is subject to the following two conditions: (1) this device may not cause interference, and (2) this device must accept any interference, including interference that may cause undesired operation of the device.

Brazilian Notice

Este equipamento opera em caráter secundário, isto é, não tem direito a proteção contra interferência prejudicial, mesmo de estações do mesmo tipo, e não pode causar interferência a sistemas operando em caráter primário.

Japanese Notice

この装置は、情報処理装置等電波障害自主規制協議会（VCCI）の基準に基づくクラスB情報技術装置です。この装置は、家庭環境で使用することを目的としていますが、この装置がラジオやテレビジョン受信機に近接して使用されると、受信障害を引き起こすことがあります。

取扱説明書に従って正しい取り扱いをして下さい。

この機器の使用周波数帯では、電子レンジ等の産業・科学・医療用機器のほか工場・製造ライン等で使用されている移動体無線用の構内無線局（免許を要する無線局）及び特定小電力無線局（免許を要しない無線局）が運用されています。

- この機器を使用する前に、近くで移動体無線用の構内無線局及び特定小電力無線局が運用されていないことを確認して下さい。
- 万一、この機器から移動体無線用の構内無線局に対して電波干渉の事例が発生した場合には、速やかに使用周波数を変更するか又は電波の抑制を停止した上、下記連絡先にご連絡頂き、事故記録のための処置等（例えば、パーティションの設置など）についてご相談して下さい。
- その他、この機器から移動体無線用の特定小電力無線局に対して電波干渉の事例が発生した場合など何かお困りのことが起きたときは、次の連絡先へお問い合わせ下さい。

連絡先：日本ヒューレット・パカード株式会社 TEL.0120-014121

Wireless LAN 802.11b Devices



Wireless LAN 802.11g Devices



Bluetooth Devices



Taiwan DGT Notice

低功率電波輻射性電機管理辦法

第十四條 經型式認證合格之低功率射頻電機，非經許可，公司、商號或使用者均不得擅自變更頻率、加大功率或變更原設計之特性及功能。

第十七條 低功率射頻電機之使用不得影響飛航安全及干擾合法通信；經發現有干擾現象時，應立即停用，並改善至無干擾時方得繼續使用。

前項合法通信，指依電信規定作業之無線電信。低功率射頻電機須忍受合法通信或工業、科學及醫療用電波輻射性電機設備之干擾。

Korean Notice

B급 기기 (가정용 정보통신기기)

이 기기는 가정용으로 전자파적합등록을 한 기기로서 주거지역에서는 물론 모든 지역에서 사용할 수 있습니다.

18 Frequently asked questions

I am having trouble turning on my HP iPAQ. What should I do?

Your HP iPAQ displays problems with the battery. Please perform the following checks:

- Is the battery charged?
- Is the battery properly installed?

I have trouble connecting to the Internet. What should I do?

If you have trouble connecting to the Internet, please perform the following checks:

- Make sure you have subscribed for a data service from your service operator.
- Make sure you entered correct setting parameters, such as APN and IP addresses in data profile setup.

Why does the HP iPAQ operate slowly at times?

You should have at least 1.5 to 2 MB of free memory space on your HP iPAQ so that the device operates efficiently. To check the free memory space, tap **Start > Settings > System > Memory**. Remember to delete or transfer old e-mail messages and pictures on your HP iPAQ to free available memory space.

Why do I see the Today screen layout error message on my HP iPAQ display screen?

You will get a **Today** screen layout error message if you did not select a **Today** screen layout. To correct this, tap **Start > Settings > Personal** and select a layout for the **Today** screen.

I have trouble charging my battery. What should I do?

If you have trouble charging your battery, please perform the following checks:

- Is the battery charger correctly plugged into the battery charger socket on the HP iPAQ?
- Is the power cord of the charger damaged?
- Is the battery very old? If yes, replace with a new battery and try again.

I am unable to use the ActiveSync feature. What should I do?

To be able to use the ActiveSync feature, upgrade your computer to the latest version of ActiveSync. It is recommended to use ActiveSync 4.5 or a higher version. Visit <http://www.microsoft.com/downloads> for the latest versions.

My HP iPAQ was not connected during WMDC installation?

Although you do not need to connect your HP iPAQ during the installation process of WMDC, it is highly recommended to have it connected.

My HP iPAQ was connected while I was installing but WMDC is not launching after installation?

In some cases after an upgrade, you will need to disconnect and reconnect the device for WMDC to launch.

Can I connect for the first time via Bluetooth?

The initial connection between your HP iPAQ and the desktop WMDC application needs to happen with a mini-USB synchronization cable. After this initial connection, you will be able to set up Bluetooth for future connections.

19 Guidelines for care and maintenance

It is recommended that you follow certain guidelines to prevent possible damage to your HP iPAQ and to keep it in a good condition.

Using your HP iPAQ

- Avoid using your HP iPAQ in dusty and extremely high or low temperature environments.
- Do not spill water on your HP iPAQ or expose it to the rain.
- Avoid removing the battery without turning off your HP iPAQ.
- Do not apply strong force or shocks to your HP iPAQ.
- Keep the HP iPAQ and its accessories away from children.
- Do not insert metal objects into the charging/communications port of your HP iPAQ. This can short-circuit the battery and result in danger.
- Turn off your HP iPAQ or switch it to silent mode when you are asked to in public places.

Cleaning your HP iPAQ

- Use a soft, clean, and slightly moistened cloth to clean your HP iPAQ. Do not let water come into contact with the earpiece, microphone, or the metal surface.
- Do not wipe your HP iPAQ with any corrosive liquid or coarse objects. This can damage the outer surface of your HP iPAQ.

Carrying or storing your HP iPAQ

- Do not leave your HP iPAQ in extremely high or low temperature environments.
- Remove the battery from your HP iPAQ if it is not going to be used for a long period of time. Store the HP iPAQ and its battery in a cool, dark, and dry place.

Using accessories

- Use original HP batteries and chargers to charge your HP iPAQ.
- Do not use your HP iPAQ battery and charger for other purposes.
- For information on accessories for your iPAQ, visit <http://www.hp.com/accessories/ipaq>.