

HP OfficeJet Family

Technical Support Solutions Guide



Contents

Subject	Page
Chapter 1: Product Information	
Introduction	1-2
Product Description	1-2
Product Features	1-3
Simultaneous Tasking Features	1-4
Product Specifications	1-7
Print Cartridges	1-10
Software Programs	1-10
Media	1-10
Media Tray Capacities	1-11
Media Print Area	1-12
Ordering Information	1-13
Chapter 2: Installation and Configuration	
Introduction	2-2
Using Printer Driver Software	2-2
Using Microsoft Windows 3.1	2-2
Using OS/2	2-3
Using DOS Software Applications	2-3
Hardware and Software Requirements	2-3
Installing the HP OfficeJet LX Software	2-3
Running the HP OfficeJet LX Manager	2-6
Running the Eclipse FAX SE from the HP OfficeJet LX Manager	2-7
Sending a Fax Directly from the PC	2-8
Receiving a Fax Directly to the PC	2-9
Using Other PC Fax Programs With the HP OfficeJet LX	2-10
Installing a Control Panel Overlay	2-10
Installing a Print Cartridge	2-11
Installing an Interface Cable for Printing	2-12
Installing the Power Cord	2-13
Installing a Document Catch Tray (optional)	2-13
Installing an Access Door Assembly	2-15
Installing an Output Tray	2-15
Installing an Input Tray	2-16
Installing a Tray Cover	2-17
Loading Paper in the Input (Paper) Tray	2-18
Loading Envelopes in the Input (Paper) Tray	2-19
Setting the Paper Size in the Menu	2-20
Setting Up for Printing	2-21
Setting Up for Faxing (U.S., Australia, Canada and Mexico Installations)	2-22
Receive fax calls only - no voice calls, on a dedicated fax line	2-22
Receive voice and fax calls at the same phone number - without an answering machine	2-23
Receive voice and fax calls at the same phone number - with an answering machine	2-24
Receive fax and voice calls on the same line with distinctive ring	2-25
Setting the Reception Mode for Incoming Calls	2-27
Setting the Number of Rings to Answer	2-28
Selecting Tone or Pulse Dialing	2-29
Entering the Date and Time	2-30
Entering the Header Information (company name and fax number)	2-31

Subject	Page
Setting Up for Faxing (U.K. Installation)	2-32
Receive fax calls only - no voice calls, on a dedicated fax line	2-32
Receive voice and fax calls at the same phone number - without an answering machine	2-33
Receive voice and fax calls at the same phone number - with an answering machine	2-33
Setting Up for Faxing (Germany Installation)	2-34
Setting Up for Faxing (France Installation)	2-35
Receive fax calls only - no voice calls, on a dedicated fax line	2-35
Receive voice and fax calls at the same phone number - without an answering machine	2-36
Receive voice and fax calls at the same phone number - with an answering machine	2-37
Setting Up for Faxing (Netherlands Installation)	2-38
Receive fax calls only - no voice calls, on a dedicated fax line	2-38
Receive voice and fax calls at the same phone number - without an answering machine	2-39
Receive voice and fax calls at the same phone number - with an answering machine	2-40

Chapter 3: Routine Maintenance

Introduction	3-2
Changing a Print Cartridge	3-2
Exterior Cleaning	3-3

Chapter 4: Calibration and Adjustment

Introduction	4-2
Print Calib Chart	4-2

Chapter 5: Problem Resolution

Introduction	5-2
Multi-Function Task Chart	5-2
Problem Solving Process	5-2
Typical Questions and Answers	5-3
Error Notification: Beeps, Blinking Lights and Messages	5-6
Display Messages: What they mean and what to do	5-7
Solving Problems While Printing, Faxing or Copying	5-16
Diagnostic Codes: What they are, how to read them and what to do	5-22
Fax Session Protocol: Diagnostic Code appearances in a communication	5-22
Diagnostic Code Descriptions	5-25
Communication Error Codes (level 400 and 500)	5-27
Power-On Initialization Tests	5-34
Special Menus and Functions	5-35
Service and Factory Menu	5-36
Service and Factory Menu Structure	5-36
System Error Codes	5-41
User-Menu Associated Parameter Structure	5-42
Officejet Parameter Descriptions	5-43
LIU Identification	5-43
Ring Detection and Auto Answering	5-44
Eavesdrop Detection and Automatic Answering	5-47
Connection Establishment	5-50
Pause Control	5-53
Dial Tone Detection	5-54
Dialing	5-60
Call Progress	5-62
Modem Configuration	5-65

Subject	Page
Fax Session Configuration	5-67
Redialing	5-68
Miscellaneous	5-70

Chapter 6: Service and Support Information

Introduction	6-2
Product Warranty	6-2
HP Extended Warranties	6-2
HP Express Exchange	6-2
Standard Return (U.S. only)	6-2
Returning the HP OfficeJet for Service	6-2
HP Support Information	6-3
Exchange Unit Ordering Information	6-3
Resources for U.S. Customers	6-4
Resources for Resellers (U.S. only)	6-6
Resources for HP Authorized Dealers (U.S. only)	6-7
Resources for Canadian Product Support	6-8
Resources for European Product Support	6-9
Resources for Australian Product Support	6-12
HP Regional Sales Offices	6-13
Interpreting the Serial Number Format	6-14
Interpreting the PCA Date Code Format	6-14

Index

Figures

HP OfficeJet Printer/Fax/Copier	1-2
Maximum Media Print Area	1-12
Tray Assemblies	1-14
Removing the Protective Cover from the Back of the Control Panel Assembly	2-10
Installing the Print Cartridge	2-11
Installing an Interface Cable for Printing	2-12
Installing the Power Cord	2-13
Installing a Document Catch Tray (optional)	2-13
Installing an Access Door Assembly	2-15
Installing an Output Tray	2-15
Installing an Input Tray	2-16
Installing a Tray Cover	2-17
Loading Paper in the Input (Paper) Tray	2-18
Loading Envelopes in the Input (Paper) Tray	2-19
Connecting the HP OfficeJet to the Telephone Wall Jack (U.S., Australia, Canada, Mexico Installations) ...	2-22
Connecting a Telephone to the HP OfficeJet (U.S., Australia, Canada, Mexico Installations)	2-23
Connecting an Answering Machine to the HP OfficeJet (U.S., Australia, Canada, Mexico Installations)	2-24
Connecting the HP OfficeJet to the Telephone Wall Jack (U.K. Installation)	2-32
Connecting a Telephone for use with the HP OfficeJet (U.K. Installation)	2-33
Connecting an Answering Machine for use with the HP OfficeJet (U.K. Installation)	2-33
Connecting the HP OfficeJet to the Telephone Wall Jack (Germany Installation)	2-34
Connecting a Telephone or Answering Machine for use with the HP OfficeJet (Germany Installation)	2-34
Connecting the HP OfficeJet to the Telephone Wall Jack (France Installation)	2-35
Connecting a Telephone for use with the HP OfficeJet (France Installation)	2-36
Connecting an Answering Machine for use with the HP OfficeJet (France Installation)	2-37
Connecting the HP OfficeJet to the Telephone Wall Jack (Netherlands Installation)	2-38
Connecting a Telephone for use with the HP OfficeJet (Netherlands Installation)	2-39
Connecting an Answering Machine for use with the HP OfficeJet (Netherlands Installation)	2-40
Changing a Print cartridge	3-2
Calibration Chart	4-4
Diagnostic Code (Sample Report Form)	5-22
HP OfficeJet Fax Session Protocol Diagram	5-24
Service and Factory Menu	5-36

Tables

HP OfficeJet (LX) Features	1-3
Simultaneous Tasking Matrix	1-4
HP OfficeJet Specifications	1-7
Ordering Information	1-13
Error Notification: Beeps, Blinking Lights and Messages	5-6
Display Messages: What They Mean and What to do	5-7
Solving Problems While Printing, Faxing or Copying	5-16
Diagnostic Codes: What They Are, How to Read Them and What to do	5-22
Diagnostic Codes	5-25
T30 States – Receive Errors	5-27
T30 States – Transmit Errors	5-28
Communication Error Codes (Level 400)	5-29
Communication Error Codes (Level 500)	5-31
Power-On Initialization Sequence Tests	5-34
Special Menus and Functions	5-35
System Error Codes	5-41
HP OfficeJet User Menu – Associated Parameter Structure	5-42
HP OfficeJet Parameter Descriptions	5-43
Exchange Unit Ordering Information	6-3
Resources for U.S. Customers	6-4
Resources for Resellers	6-6
Resources for HP Authorized Dealers	6-7
Resources for Canadian Product Support	6-8
Resources for European Product Support	6-9
Resources for Australian Product Support	6-12
HP Regional Sales Offices	6-13

Notes

Product Information

Subject	Page
Introduction	1-2
Product Description	1-2
Product Features	1-3
Simultaneous Tasking Features	1-4
Product Specifications	1-7
Print Cartridges	1-10
Software Programs	1-10
Media	1-10
Media Tray Capacities	1-11
Media Print Area	1-12
Ordering Information	1-13

Introduction

This Technical Support Solutions Guide contains information necessary to support the HP OfficeJet Printer/Fax/Copier family of products. Although model and country-specific functionality may differ across the HP OfficeJet product line, the support and service strategy is consistent. The products covered in this guide will be commonly referred to as the HP OfficeJet except where model or country-specific differences are noted. This guide is divided into six chapters as follows:

- Chapter 1 Product Information
- Chapter 2 Installation and Configuration
- Chapter 3 Routine Maintenance
- Chapter 4 Calibration and Adjustment
- Chapter 5 Problem Resolution
- Chapter 6 Service and Support Information

This Technical Support Solutions Guide is designed to be used with the HP OfficeJet LX User's Guide as a complete technical support reference package. This guide and the HP OfficeJet LX User's Guide also support the standard HP OfficeJet. The LX version is the HP OfficeJet with added PC-FAX functionality. Typical user setup tasks are contained in the User's Guide and answers to questions related to such tasks can be found there. Refer to the User's Guide when questions about setup, user settings and printer/fax/copier use are encountered. Refer to this guide for information on troubleshooting and service and support programs.

Product Description

The HP OfficeJet is a plain paper, thermal inkjet printer/facsimile (fax)/convenience copier machine. It is CCITT group 3-ECM compatible. Designed to fit on a desktop, the HP OfficeJet weighs 8.8.5 kg (19.5 lb). The HP OfficeJet has a full-featured printer, which can be used with your PC and either Windows or DOS drivers, and has 16 kB of printer memory. Its built-in fax machine feature provides many advanced fax features including speed dialing capability for 65 stations, with a 10 seconds per page transmission speed and 24 page fax memory. As a convenience copier, the HP OfficeJet can be set to copy up to 99 copies of an original at a speed of 50 seconds per page. The LX version of the HP OfficeJet uses Eclipse FAX® SE which provides the ability to send faxes directly from the Personal Computer (PC), receive faxes to the PC, and scan images into PC-based files. The LX version also uses a management function that allows the HP OfficeJet LX to be set up from the PC using Windows-based menus. The HP OfficeJet uses cut-sheet plain paper (100 sheet paper tray capacity) and a thermal inkjet cartridge.



HP OfficeJet (LX) Printer/Fax/Copier

Product Features

The following table lists the features of the HP OfficeJet (LX) described in this guide.

HP OfficeJet (LX) Features	
Feature	Description
Shares a single line with the telephone and a telephone answering machine (TAM)	Answering machine answers all calls. While your greeting plays, the OfficeJet listens for a fax tone. If fax tone is detected, the OfficeJet takes the call.
Speed dialing	A two-digit number represents a telephone number. Provides quick and easy dialing for up to 60 locations and 5 groups of numbers.
Fax settings	Settings allow the user or service person to customize the fax for specific needs.
Halftone scanning	The ability to interpret shades of gray into dot patterns to produce an appearance of gray in an image. Improves the image quality of photographs.
Error Correction Mode	Detects errors that occur during the transmission of a document and automatically requests resending of the erroneous portion.
Automatic Journals	The HP OfficeJet can be set to print a summary sheet of each transaction or polling operation, to print a journal of the last 30 transactions, print a record of the speed dial numbers stored in memory, print a menu structure diagram with current settings and to print self-test and demo reports.
Print from PC functionality	Allows printing of print jobs from the personal computer, when using appropriate printer driver.
Copy functionality	Allows for up to 99 copies of an original, includes copy reduction.
Polling and being polled	Ability to have a document ready for retrieval by another fax station and to call other fax stations to retrieve information.
Sending faxes at deferred times	The ability to delay fax transmissions to another station until a user-set time is reached.
Automatic and fixed print reduction modes	Print reduction modes which fit an incoming document onto a given paper size.
Automatic and manual redialing	Automatically redials if the line is busy or no answer; retains the last number dialed. Redials up to 5 times at 5 minute intervals.
Backup (Out-of-paper, out-of-ink) reception	Stores incoming faxes and print jobs in memory if out of paper or ink, or paper or ink is not installed.
Remote diagnostics	Allows remote access to all user settings and machine parameters.
(Continued on next page)	

HP OfficeJet Features (Continued)	
Feature	Description
Sending to multiple fax numbers	The ability to send a document to multiple (up to 10) fax numbers.
Memory reception capacity	Depending upon amount of information on pages sent, memory allows for up to 24 page storage.
Fax to/from PC functionality (HP OfficeJet LX only, using the Eclipse FAX SE software program provided)	The ability to send and receive faxes from the PC using Eclipse FAX SE functionality. Faxes can be sent directly from the PC without printing them and faxes can be received either to paper or to the PC where they can be viewed, filed or printed.
HP OfficeJet LX Manager (HP OfficeJet LX only, using the HP OfficeJet LX Manager software program provided)	Allows the user to setup and monitor the status of the HP OfficeJet LX from the PC using Windows-based menus.
Convenience Scanning	The user can use the HP OfficeJet LX as a convenience scanner to scan images into PC-based files.
Software Programs	Windows and DOS printer drivers, a scanner driver and printer fonts are provided.

Simultaneous Tasking Features

The HP OfficeJet (LX) is capable of performing several tasks at the same time. Use the following chart as a reference of which tasks can be performed simultaneously. Attempting to perform concurrent tasks not supported may result in a display message or error condition.

Simultaneous Tasking Matrix					
If the HP OfficeJet (LX) is:	Note: PC fax capability is only present in the LX version				
	Can I?				
	Send a print job or print a PC fax	Receive a paper fax	Receive a PC fax (LX only)	Send a fax from the ADF	Send a PC fax (LX only)
Printing a PC file or printing a PC fax	YES automatically prints when the first PC job ends	YES automatically prints when PC print job ends	YES	YES	YES
Receiving a paper fax	YES automatically prints when fax printing ends	YES automatically prints when the first fax is finished printing	YES	YES	YES
(Continued on next page)					

Simultaneous Tasking Matrix (Continued)

If the HP OfficeJet (LX) is:	Note: PC fax capability is only present in the LX version				
	Can I?				
	Send a print job or print a PC fax	Receive a paper fax	Receive a PC fax (LX only)	Send a fax from the ADF	Send a PC fax (LX only)
Receiving a PC fax (LX only)	YES (with delay) print manager automatically sends print job as soon as received fax is complete	NO two faxes cannot be transmitted over the same phone line at the same time	NO two faxes cannot be transmitted over the same phone line at the same time	NO two faxes cannot be transmitted over the same phone line at the same time	YES (with delay) print manager will send PC fax as soon as fax is complete
Sending a fax from the ADF	YES	NO two faxes cannot be transmitted over the same phone line at the same time	NO two faxes cannot be transmitted over the same phone line at the same time	NO two faxes cannot be transmitted over the same phone line at the same time	YES (with delay) print manager will send PC fax as soon as fax is complete
Sending a PC fax (LX only)	YES (with delay) print manager sends one job as soon as one is complete	NO two faxes cannot be transmitted over the same phone line at the same time	NO two faxes cannot be transmitted over the same phone line at the same time	NO two faxes cannot be transmitted over the same phone line at the same time	YES (with delay) print manager sends one fax as soon as first is complete
Making a Copy	YES automatically prints when copying ends	YES automatically prints when copying ends	YES	NO two documents cannot be scanned from the ADF at the same time	YES
Scanning	NO scanning ties up PC resources	YES	NO PC fax will be routed to paper fax	NO two documents cannot be scanned from the ADF at the same time	NO scanning ties up PC resources

The following task combinations can be performed simultaneously.

1. An incoming fax will be stored in memory while:
 - faxes in memory are printing
 - a local copy is printing
 - a print job is printing
 - a report is printing
2. A fax can be sent from the automatic document feeder while:
 - faxes in memory are printing
 - a print job is printing
 - a report is printing
3. Print jobs can be printed while:
 - a fax is being sent from the automatic document feeder
 - a delayed send fax from memory is being sent
 - a delayed send fax from the automatic document feeder is being sent
 - a broadcast fax from memory is being sent
 - a document is polled from the automatic document feeder
4. A delayed send fax from memory can be sent while:
 - a print job is printing
5. A broadcast fax from memory can be sent while:
 - a print job is printing
6. A delayed send fax from the automatic document feeder can be sent while:
 - a print job is printing
7. Remote fax machines can poll the HP OfficeJet while:
 - faxes in memory are printing
 - a print job is printing
 - a report is printing
8. Faxes in memory can be printed while:
 - an incoming fax is stored in memory (and takes over the display)

Product Specifications

Review the following table for product specifications of the HP OfficeJet.

HP OfficeJet Specifications		
Function	Specification	Description
Overall Specifications	Dimensions	17.25 w x 15.5 d x 11.125 h (inches) 438 w x 394 d x 283 h (mm)
	Weight	19.5 lb (8.85 kg)
	Power Source (autoranging)	100-240 Vac, 1.0 A, 50-60 Hz
	Power Consumption	10 watts at idle, 45 watts maximum
	Operating Environment	Temperature range for best print quality: 15°C (59°F) to 35°C (95°F) Allowable temperature/humidity range: 5°C (41°F) to 40°C (104°F), 15-80% RH non-condensing Maximum noise level generated: Sound Power, LwAd = 6.4 B(A) Sound Pressure, LpAm = 50 dB(A)
Printer Specifications	Print Method	Plain paper drop-on-demand thermal inkjet
	Printer Memory	16 kB
	Printer Command Language	HP PCL Level 3
	Printer Interface	Parallel (Centronics)
	Resolution (dots per inch = dpi)	Windows: Presentation mode = 600 x 300 dpi with REt Normal mode = 600 x 300 dpi with REt Fast mode = 300 dpi DOS (text): Letter quality = 600 x 300 dpi with REt Draft quality = 300 dpi with ink reduction
	Print Speed (page(s) per minute = ppm) (characters per second = cps) (characters per inch = cpi)	Windows print speed: Presentation mode = 1 ppm Normal mode = 2.5 ppm Fast mode = 3 ppm DOS print speed: Letter quality = 167 cps at 10 cpi Draft quality = 240 cps at 10 cpi
Paper sizes	U.S. letter = 8.5 x 11 in. U.S. legal = 8.5 x 14 in. European A4 = 210 x 297 mm Executive = 7.25 x 10.5 in U.S. No. 10 envelope = 4.12 x 9.5 in European DL envelope = 220 x 110 mm U.S. transparency = 8.5 x 11 in. European A4 transparency = 210x297 mm	

HP OfficeJet Specifications (continued)

Function	Specification	Description
Printer Specifications (continued)	Internal Fonts	<i>Courier (Portrait Orientation):</i> Pitch: 5, 10, 16.67, 20 cpi Point size: 6, 12 pt. <i>CG Times (Portrait Orientation):</i> Pitch: Proportional Point size: 5, 6, 7, 8, 10, 12, 14 pt. <i>Letter Gothic (Portrait Orientation):</i> Pitch: 6, 12, 24 cpi Point size: 6, 12 pt. <i>Univers (Portrait Orientation):</i> Pitch: Proportional Point size: 5, 6, 7, 8, 10, 12, 14 pt. <i>Courier (Landscape Orientation):</i> Pitch: 10, 16.67, 20 cpi Point size: 6, 12, 24 pt. <i>Letter Gothic (Landscape Orientation)</i> Point and Pitch: 6, 12, 24 pt for 12, 24 cpi; 4.75, 9.5, 19 pt for 16.67 cpi
	Character Set Support	PC-8, HP Roman 8, PC-8 Danish/Nor, UK ISO 4, German ISO 21, French ISO 69, Italian ISO 15, Nor v.1 ISO 60, Swed Names ISO 11, Spanish ISO 17, ASCII, Portug ISO 16, PC-850, ECMA-94 Latin 1, HP Legal
	Printing Margins (These numbers represent the maximum printable area for this device. However, your printer driver may create a smaller printable area.)	<i>U.S. letter-size paper:</i> Top margin = 1.0 mm (± 1.0 mm) Bottom margin = 10.9 mm (± 0.6 mm) Left margin = 6.4 mm (± 1.0 mm) Right margin = 6.4 mm (± 1.0 mm) <i>European A4-size paper:</i> Top margin = 1.0 mm (± 1.0 mm) Bottom margin = 10.9 mm (± 0.6 mm) Left margin = 3.4 mm (± 1.0 mm) Right margin = 3.4 mm (± 1.0 mm)
	Vertical Alignment	± 0.002 in.
	Scalable TrueType™ Fonts for Microsoft© Windows	Arial® Black, CG Goudy Old Style, Phyllis, Graphite Light, CG Poster Bodoni, Lucida® Casual, Gill Sans Shadow, Milestone Font, Signet Roundhand, and PL Benguiat Frisky
	Software Compatibility	Microsoft Windows 3.1 WordPerfect Lotus 1-2-3 for DOS Also compatible with a range of DOS applications (HP DeskJet), OS/2 versions 1.3, 2.0, 2.1 (HP DeskJet), and Microsoft Windows 3.0 (HP DeskJet)

HP OfficeJet Specifications (continued)

Function	Specification	Description
Fax Specifications	Coding Schemes	MH, MR, MMR
	Compatibility	CCITT Group 3
	Distinctive Ring Detect	Yes
	Image Memory	24 pages (CCITT chart #1, about 400 kB)
	Modem Speed	9600, 7200, 4800 and 2400 bits per second
	Paper Sizes	U.S. letter = 8.5 x 11 in. U.S. legal = 8.5 x 14 in. European A4 = 210 x 297 mm
	Paper Weight (faxes sent)	16 to 24 lb (60 to 90 g/m ²)
	Scan Margins (faxes sent)	Top margin = 3.0 mm ± 3.0 mm Bottom margin = 0.0 mm ± 4.0 mm Center line = 0.0 mm ± 2.5 mm Width = 216.2 mm ± 2.6 mm
	Scan Resolution	Standard = 100 x 200 dpi Fine = 200 x 200 dpi Photo = 200 x 200 dpi, 32 level grayscale
	Scan Width	Maximum = 8.5 inches (216 mm)
	Speed Dialing	65 locations, including 5 groups
Transmission Speed	10 seconds per page (CCITT chart #1 using ECM)	
Copier Specifications	Copy Speed	50 seconds per page
	Scan Resolution	Fine = 200 x 200 dpi Photo = 200 x 200 dpi, 32 level grayscale
	Paper Sizes	U.S. letter = 8.5 x 11 in. U.S. legal = 8.5 x 14 in. European A4 = 210 x 297 mm
	Multiple Copies	Up to 99 (per full paper tray)
	Copy Reduction	100%, 95%, 90%, 85%, 80%, 75% (Legal-to-Letter), 70%
	Scan Margins	Top margin = 3.0 mm ± 3.0 mm Bottom margin = 2.0 mm ± 3.0 mm Center line = 0.0 mm ± 2.5 mm Width = 216.2 mm ± 2.6 mm
	Scan Width	Maximum = 8.5 inches (216 mm)

Print Cartridges

The HP OfficeJet uses one high-capacity black print cartridge, HP part number 51626A.

When printing *text only* on letter-size media, ink lasts, on average, about 1000 pages. Text used was CCITT test image number 1, the Slerexe Company letter. If text of greater density is printed or quality mode is used, results may vary considerably. Ink cartridge longevity is also affected by larger paper sizes containing more printed matter or photos or illustrations. If the ink lasts much less than 1000 pages, ensure that you have removed **both** pieces of tape from the print cartridge before beginning to use it, and that the conductive part of the cartridge surface is clean.

Software Programs

Several software programs and drivers are provided. The Eclipse FAX SE and HP OfficeJet LX Manager programs are only provided and used with the LX version. The Windows and DOS drivers are provided with all models.

- Eclipse FAX SE allows the user to send high-quality faxes directly from the PC, receive faxes to the PC, and scan images into PC-based files.
- HP OfficeJet LX Manager lets the user setup the HP OfficeJet LX from the PC, using Windows-based menus, rather than the device's front panel. The Manager also serves as a status monitor, displaying information and error messages and also tells the user whether or not the HP OfficeJet LX is properly connected.
- Windows and DOS printer drivers, printer fonts and a scanner driver are provided.

Media

An HP OfficeJet works with ordinary bond and photocopy papers. Paper properties are subject to change by paper manufacturers, and Hewlett-Packard has no control over such changes. For optimum print quality, test paper (printing on both sides) for suitability, before you purchase large quantities.

Use plain bond or white photocopy paper of high quality. It should be free of:

- Carbon
- Cuts or tears
- Grease spots
- Loose particles
- Dust
- Wrinkles
- Curled, bent or frayed edges

Colored bond and photocopy paper (such as pink, yellow, or blue) can be used, as long as it meets these specifications:

- **Paper Size**
 - U.S. letter (8 1/2 in x 11 in), (216 x 279 mm)
 - U.S. legal (8 1/2 in x 14 in), (215 x 356 mm)
 - Executive (7.25 x 10.5 in), (184 mm x 267 mm)
 - A4 metric (8.27 x 11.7 in), (210 mm x 297 mm)
- **Envelope Size**
 - U.S. No. 10 (4.12 x 9.5 in), (105 x 241 mm)
 - European DL (8.66 x 4.33 in), (220 x 110 mm)
- **Paper Type**
 - Cut sheet

- **Cut Edge Conditions** Sharp blade cut, with no visible fray.
- **Finishing Dimensions** ± 0.0313 inch of nominal, corners $90^\circ \pm 0.20^\circ$
- **Paper Grain** Long grain
- **Moisture Content** 4% to 6% by weight
- **Opacity** 84% minimum
- **Packaging** Polylaminated moisture-proof ream wrap
- **Paper weight** 60 to 135 g/m² (16 lb to 36 lb), 75 g/m² (20 lb) recommended
- **Wax Pick** 2 inch minimum (Dennison)

Paper can be loaded automatically or manually. When loading paper, observe the following precautions:

- Handle all paper by the edges only
- Load all paper types the same way
- Use only one paper type in the printer's paper tray at a time
- Always load paper print side up in the media tray

Plain paper has a print side which is not visible to the naked eye, so before removing paper from its package for use in the printer, check the outside package label. Always load the paper into the machine with the print side facing down. The print side will be indicated by an arrow or other symbol on the label.

Avoid the following types of media:

- Paper greater than 135 g/m² (36 lb) or less than 60 g/m² (16 lb)
- Paper with cutouts or perforations
- Multiple part forms
- Carbon copy forms
- Paper sizes other than those listed in this document

Media Tray Capacities

Sheet capacity for the various paper tray is as follows:

- Access door assembly (automatic document feed tray for faxes to be sent)
= 20 pages (paper weight ≤ 20 lb or 75 g/m²)
Minimum paper width = 6 in. (152 mm)
Maximum paper width = 8.5 in. (216 mm)
Maximum paper length = 17 in. (432 mm)
- Input Tray = 100 sheets at a paper weight ≤ 20 lb (75 g/m²) or 20 envelopes (U.S. No. 10 or European DL)
- Output tray = 100 sheets at a paper weight ≤ 20 lb (75 g/m²)

Media Print Area

Maximum printable area for the HP OfficeJet is dependent upon the media size being used. The printable area for the media sizes are shown in the following diagram.

Paper Size	Left Margin	Right Margin	Top Margin	Bottom Margin
U.S. Letter 8.5 x 11 in. (215 x 279 mm)	6.4 mm ± 1.0 mm (0.25 x 0.04 in.)	6.4 mm ± 1.0 mm (0.25 x 0.04 in.)	1.0 mm ± 1.0 mm (0.04 x 0.04 in.)	10.9 mm ± 0.06 mm (0.42 x 0.02 in.)
European A4 210 x 297 mm (8.27 x 11.7 in.)	3.4 mm ± 1.0 mm (0.13 x 0.04 in.)	3.4 mm ± 1.0 mm (0.13 x 0.04 in.)	1.0 mm ± 1.0 mm (0.04 x 0.04 in.)	10.9 mm ± 0.06 mm (0.42 x 0.02 in.)

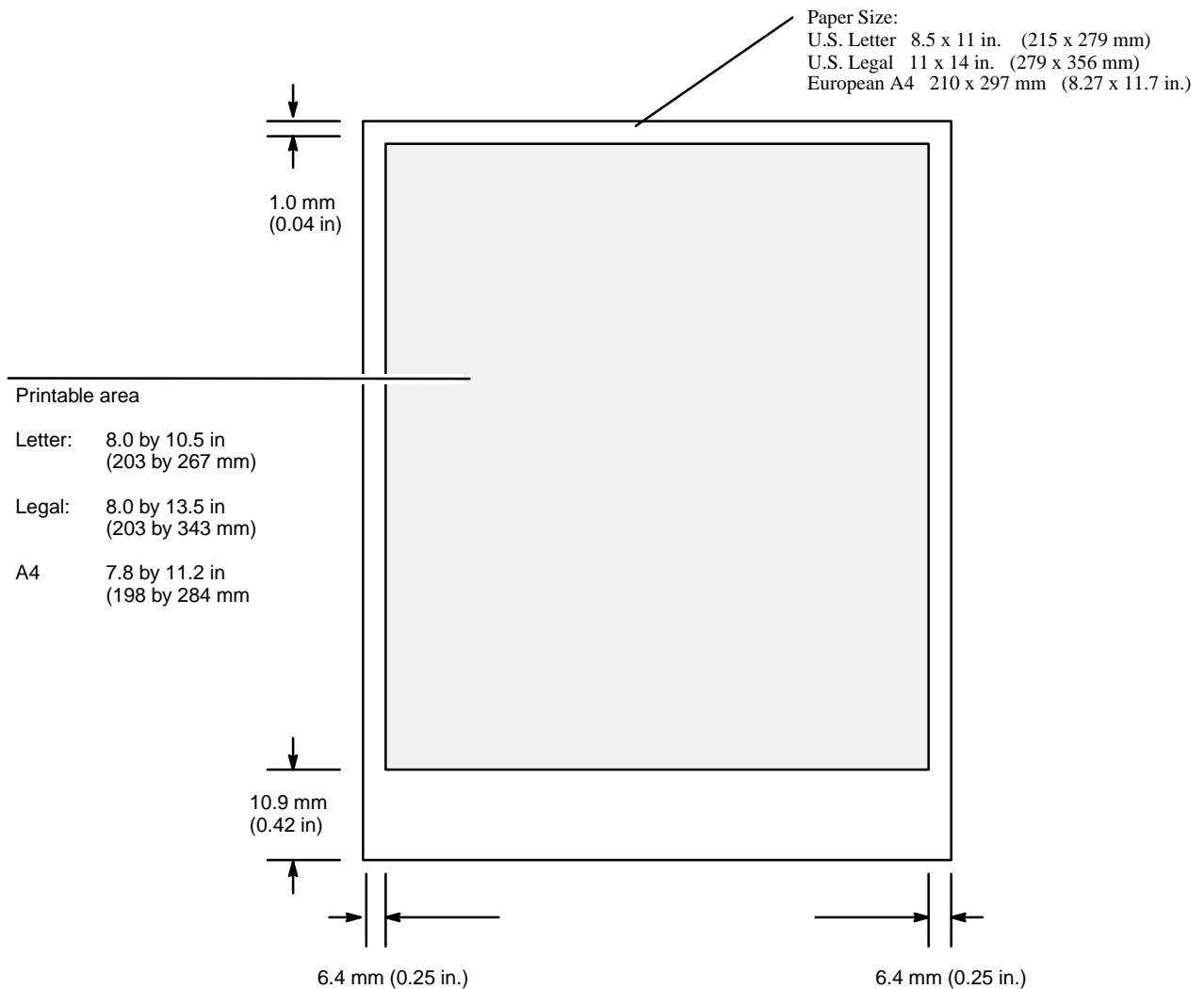

Maximum Media Print Area

Ordering Information

Information on ordering exchange units under the HP Exchange program is provided with the program information in Chapter 6 of this manual.

To order the supplies and accessories listed in the table below, contact your HP dealer. If your dealer is out of stock, you can order directly from HP for fast shipping service:

Within the U.S.: Call 1-800-538-8787 for all supplies/accessories *except* documents.
Call 1-800-227-8164 to order user's guides and technical reference guides.

In Canada: In Toronto, call 905-206-4727.
In the rest of Canada, call 1-800-387-3154.

In Europe: Refer to the European Product Support table in Chapter 6. The various countries have different organizations to contact for support.

Availability, technical information and items shipped with the HP OfficeJet are subject to change without notice.

Ordering Information		
Supply/Accessory	HP Reorder Part Number	
Centronics Parallel Interface Cable (shielded)	HP C950A (2 meter), or HP C2951A (3 meter)	
High Capacity InkJet Print Cartridge	51626A	
Media		
LX JetSeries Transparency Film (U.S. Letter)	51636F	
LX JetSeries Transparency Film (European A4)	51636G	
LX JetSeries Glossy Paper (U.S. Letter)	51636H	
LX JetSeries Glossy Paper (European A4)	51636J	
HP OfficeJet and HP OfficeJet LX User's Guides	HP OfficeJet	HP OfficeJet LX
North America (English)	C2890-90001	C2891-90001
Canadian French	C2890-90003	C2891-90003
European French		C2891-90004
German		C2891-90005
Netherlands (Dutch)		C2891-90011
United Kingdom (English)		C2891-90000
Spanish (Mexico)		C2891-90006
Australia (English)		C2891-90007
HP DeskJet 500 Series Technical Reference Guide	C2170-90099	
Access Door (see diagram on next page)	C2890-60064	
Tray Cover (see diagram on next page)	C2890-40054	
Output Tray Assembly (see diagram on next page)	C2890-60006	
Document Catch Tray (see diagram on next page)	C2890-60160	
Input Tray Assembly (see diagram on next page)	C2890-60005	

Access Door Assembly

part number C2890-60064

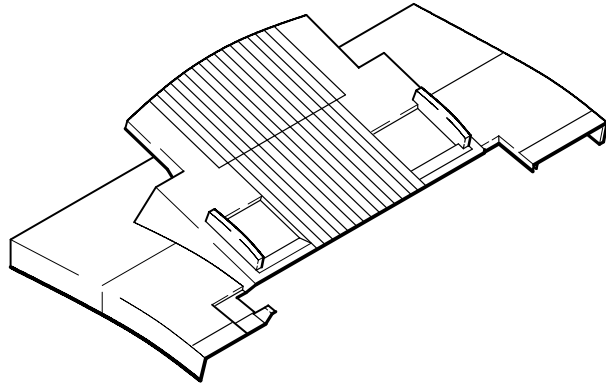

Document Catch Tray Assembly

part number C2890-60160

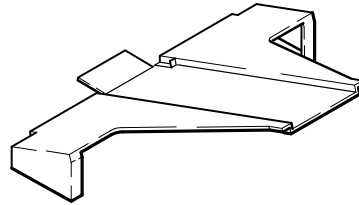

Tray Cover

part number C2890-40054

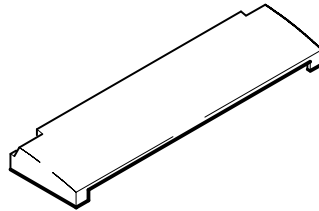

Output Tray Assembly

part number C2890-60006

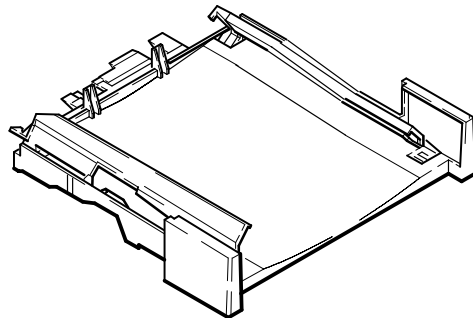

Input Tray Assembly

part number C2890-60005

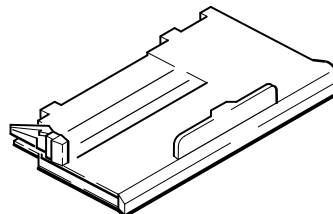

Tray Assemblies

Installation and Configuration

Subject	Page
Introduction	2-2
Using Printer Driver Software	2-2
Using Microsoft Windows 3.1	2-2
Using OS/2	2-3
Using DOS Software Applications	2-3
Hardware and Software Requirements	2-3
Installing the HP OfficeJet LX Software	2-3
Running the HP OfficeJet LX Manager	2-6
Running the Eclipse FAX SE from the HP OfficeJet LX Manager	2-7
Sending a Fax Directly from the PC	2-8
Receiving a Fax Directly to the PC	2-9
Using Other PC Fax Programs With the HP OfficeJet LX	2-10
Installing a Control Panel Overlay	2-10
Installing a Print Cartridge	2-11
Installing an Interface Cable for Printing	2-12
Installing the Power Cord	2-13
Installing a Document Catch Tray (optional)	2-13
Installing an Access Door Assembly	2-15
Installing an Output Tray	2-15
Installing an Input Tray	2-16
Installing a Tray Cover	2-17
Loading Paper in the Input (Paper) Tray	2-18
Loading Envelopes in the Input (Paper) Tray	2-19
Setting the Paper Size in the Menu	2-20
Setting Up for Printing	2-21
Setting Up for Faxing (U.S., Australia, Canada and Mexico Installations)	2-22
Receive fax calls only - no voice calls, on a dedicated fax line	2-22
Receive voice and fax calls at the same phone number - without an answering machine	2-23
Receive voice and fax calls at the same phone number - with an answering machine	2-24
Receive fax and voice calls on the same line with distinctive ring	2-25
Setting the Reception Mode for Incoming Calls	2-27
Setting the Number of Rings to Answer	2-28
Selecting Tone or Pulse Dialing	2-29
Entering the Date and Time	2-30
Entering the Header Information (company name and fax number)	2-31
Setting Up for Faxing (U.K. Installation)	2-32
Receive fax calls only - no voice calls, on a dedicated fax line	2-32
Receive voice and fax calls at the same phone number - without an answering machine	2-33
Receive voice and fax calls at the same phone number - with an answering machine	2-33
Setting Up for Faxing (Germany Installation)	2-34
Setting Up for Faxing (France Installation)	2-35
Receive fax calls only - no voice calls, on a dedicated fax line	2-35
Receive voice and fax calls at the same phone number - without an answering machine	2-36
Receive voice and fax calls at the same phone number - with an answering machine	2-37
Setting Up for Faxing (Netherlands Installation)	2-38
Receive fax calls only - no voice calls, on a dedicated fax line	2-38
Receive voice and fax calls at the same phone number - without an answering machine	2-39
Receive voice and fax calls at the same phone number - with an answering machine	2-40

Introduction

In this chapter you will find information about installing the software applications provided, including the:

- Printer Drivers
(including Windows and DOS driver software)
- HP OfficeJet LX Software
(including the HP OfficeJet LX Manager and Eclipse FAX SE (PC fax applications))

You will find information about installing the:

- control panel overlay (if a new one is being installed)
- print cartridge
- interface cable for printing
- power cord
- document catch tray (installation is optional)

Instructions for installing the following customer orderable and installable parts are also provided:

- access door assembly
- output tray assembly
- input tray assembly
- tray cover

You will also be provided information on how to:

- load paper
- load envelopes
- set the paper size in the menu
- set up for printing
- set up for faxing

Using Printer Driver Software

Detailed information on each of the software installations and their usage is provided in the HP OfficeJet (LX) User's Guide. Also, the applications guides provided with each driver will provide specific information for the installation and use of the software package.

Refer to the options listed below to determine which printer driver you need to install to make your computer and software work with the HP OfficeJet. Printer drivers (also called printer software) are software files that control your printer and allow your software application to access the printer's features.

Using Microsoft® Windows 3.1

Install the HP OfficeJet Printer Software for Microsoft Windows 3.1 provided with your HP OfficeJet. See the documentation that came with the printer software for installation instructions.

Using OS/2

The HP OfficeJet is compatible with the HP DeskJet printers. Therefore, look for the HP DeskJet 520 or DeskJet 510 printer model selection in OS/2. If it is not available, contact your IBM representative for information. If the HP DeskJet 520 or DeskJet 510 printer is listed, install it with the instructions provided by IBM.

Using DOS software applications

For each DOS software application you use, you must install a specific printer driver. Your DOS software application supplies printer drivers for many printer models. A printer driver that supports your printer features may already be in your software application. Additional information is provided in this section, see *Setting Up for Printing*.

Hardware and Software Requirements

The following are the minimum computer system requirements:

- Parallel port must support bidirectional communication.
- 4 Megabytes (MB) of Random Access Memory (RAM). 8 MB RAM recommended.
- 5 MB hard disk space.
- Windows 3.1 operating system.

Note: To add the HP OfficeJet LX Manager to your Windows StartUp group, so that the HP OfficeJet LX Manager will run automatically whenever you start Windows, make sure that your PC has enough memory to run the HP OfficeJet LX Manager simultaneously with all the other applications you plan to run. Then, open the HP OfficeJet LX Manager and StartUp groups, press the Ctrl key, and click and drag the HP OfficeJet LX Manager icon into the StartUp group.

Installing the HP OfficeJet LX Software

The information provided here will help you with the installation of the HP OfficeJet LX Software including the HP OfficeJet LX Manager and Eclipse FAX SE software applications. Additionally, other PC Fax programs usable with the HP OfficeJet LX are described. Detailed information on custom installation and usage is provided in the HP OfficeJet LX User's Guide.

Use the following instructions when installing the software for the first time in the HP OfficeJet LX.

1. Check that you have properly set up the HP OfficeJet LX device, and that it is connected to your computer, turned on, and has paper loaded.
2. Close any open applications, saving files if necessary.
3. Insert Disk 1 of the HP OfficeJet LX software into your flexible disk drive.
4. From the Windows Program Manager menu bar, choose **File/Run**. The Run dialog box appears.

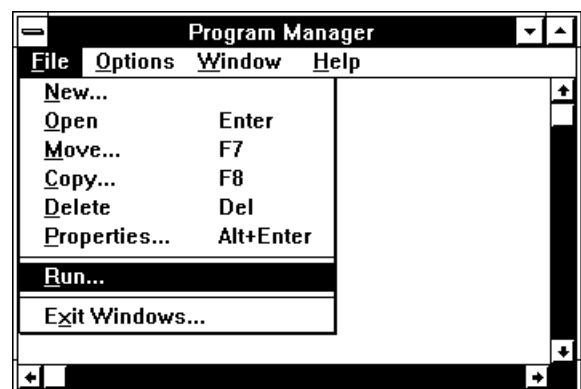

5. In the **Command Line** box, type one of the following commands, depending on which flexible disk drive you're using: *A:SETUP.EXE* or *B:SETUP.EXE*.

6. An "initializing" screen appears, followed by a screen that asks the user to select **Standard Installation**, **Custom Installation**, or **Uninstall**.

We recommend that first-time users choose **Standard Installation**, which copies all the HP OfficeJet LX software to their hard disk and sets up the device for printing, scanning, and PC faxing. For information about Custom Installation, see "Performing a Custom Installation" in the HP OfficeJet LX User's Guide. For information about the uninstall option, see "Using the Uninstall Option" in the HP OfficeJet LX User's Guide.

Click the **Standard Installation** button and then the **OK** button.

7. A screen appears, allowing you to specify the directory in which your HP OfficeJet LX software will be installed. The default directory is *C:\HPOJET*.

If this is acceptable, click the **OK** button. If it is not acceptable, follow the instructions on the screen to select a different directory. Then click the **OK** button.

8. As installation takes place, screens are displayed that provide "must know" information about the HP OfficeJet LX. Reading these screens will give you a head start on understanding how your new product works. Be sure to read these screens completely before inserting a new installation disk.

9. After all the files have been copied to the hard disk, the setup program tries to communicate with your HP OfficeJet LX.

If the device is properly connected and turned on, a screen appears, giving you the name of the port to which your HP OfficeJet LX is connected. Click the **OK** button.

10. If the setup program cannot find your HP OfficeJet LX, follow the troubleshooting instructions on the screen to correct the problem. Then click the **Retry** button. The setup program tries again to communicate with the HP OfficeJet LX. If it succeeds, a screen appears, giving you the name of the port to which your HP OfficeJet LX is connected. Click the **OK** button.

11. The PC Fax Cover Sheet Information dialog box appears. Complete it as directed, pointing and clicking in each field to fill it in. When you are finished, click the **OK** button.

12. The Fax Header dialog box appears. Complete it as directed and click the **OK** button.

13. The Fax Receive Mode dialog box appears. Complete it as directed and click the **OK** button.

If This Is the User's Situation ...	Choose This Setting
You have a separate telephone number dedicated to receiving fax calls only (no voice calls).	Auto.
You have one telephone number for both voice and fax calls, and you <i>don't</i> have a telephone answering machine.	Manual.
You have one telephone number for both voice and fax calls, and you <i>do</i> have a telephone answering machine.	Fax/TAM.
You have one telephone number for both voice and fax calls, and you subscribe to a <i>distinctive ringing service</i> from your telephone company.	Auto, and click the Distinctive Ring button in the Settings box.

14. The Dialing Mode dialog box appears. Complete it as directed and click the **OK** button.

15. Next, the setup program creates the HP OfficeJet LX program group and places it on the Windows desktop. It should look similar to this:

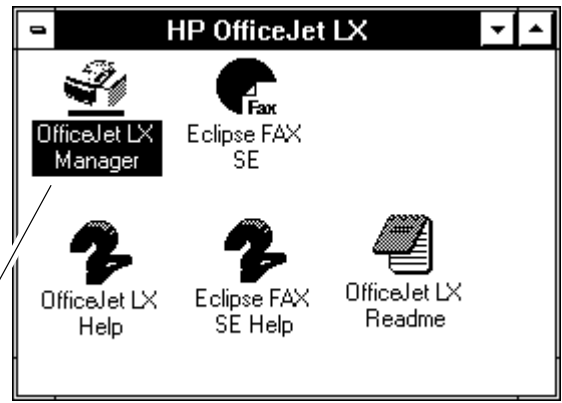

The HP OfficeJet LX Manager icon

16. As a last step, the setup program gives you the option of reading tips that will help you understand the basic functions of your new product.

As the first “tips” screen appears, your HP OfficeJet LX prints a Self Test report. This report shows samples of your new internal fonts, reviews the factory device settings, notifies you about any print cartridge problems, and provides product revision information.

Click the **Exit** button when you are ready to leave the setup program.

If difficulties arise with the installation, review the following recommendations:

Problem	Recommended Action
I am reinstalling the software, and the setup program says I don't have enough disk space.	Use the setup program to uninstall the HP OfficeJet LX software. Then try installing again.
My C: drive is full, so I tried to install the software on my D: drive, but the setup program still says I don't have enough disk space.	The HP OfficeJet LX software requires several files to reside in the drive that contains your Windows application. If that drive is full, the setup program cannot install the HP OfficeJet LX software. Free as much space on the drive as you can by either deleting unneeded files or moving files to a different drive or onto diskettes. Then try installing again.
The setup program cannot locate my HP OfficeJet LX.	If you have followed the troubleshooting directions on the screen, the most likely problem is that you need a different centronics cable. (About 10% of centronics cables cannot support bidirectional communications.) There is also a chance that your PC's centronics port is either not set up for or cannot support bidirectional communications.
I am reinstalling the software. It used to run correctly, but now the setup program cannot locate the device.	Make sure that the HP OfficeJet LX Manager is not running. Exit from Windows and then try again. Make sure that (1) the device is properly cabled to your PC, (2) the device is turned on, and (3) the front panel says "Ready."
I'm trying to uninstall the software, but the setup program says it cannot delete the directory.	Either the directory contains files that do not belong to the HP OfficeJet LX, or one or more files are open. Correct the problem and try again.

Running the HP OfficeJet LX Manager

The HP OfficeJet LX Manager is one of two software applications that are included with the HP OfficeJet LX. The other software application is Eclipse FAX SE, which lets you do PC faxing and scanning.

The HP OfficeJet LX Manager allows the user to *manage the way that their HP OfficeJet LX works*. It can be used to do the following:

- Monitor the status of the HP OfficeJet LX.
- Print logs and reports.
- Change the device settings that were made during installation, and make additional settings that control faxing, printing, and copying.

Note: The HP OfficeJet LX Manager has one other important function: *it must be running in order for you to use Eclipse FAX SE*. It can be either open as a window or minimized.

To run the HP OfficeJet LX Manager, double-click the HP OfficeJet LX Manager icon, which is placed in the HP OfficeJet LX group during installation. The HP OfficeJet LX Manager window appears.

You can minimize or close the HP OfficeJet LX Manager as you would any other Windows application. Remember that when this application is closed, you can make copies, print, and send and receive paper faxes, but you cannot use Eclipse FAX SE to send and receive PC faxes or do PC scanning.

Additional detailed information on use of the Manager is provided in the HP OfficeJet LX User's Guide.

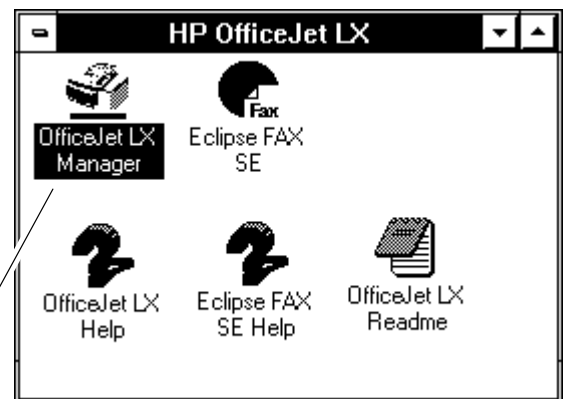

The HP OfficeJet LX Manager icon

Running Eclipse FAX SE from the HP OfficeJet LX Manager

The HP OfficeJet LX includes a software application, Eclipse FAX SE, that allows you to send and receive faxes directly to your PC, rather than to the device itself, and to do PC scanning.

Note: Eclipse FAX SE is a separate application from the HP OfficeJet LX Manager. Some of the settings that you can make with the HP OfficeJet LX Manager affect PC faxing. In addition, *the HP OfficeJet LX Manager must be running in order for you to use Eclipse FAX SE*. It can be either open as a window or minimized.

There may be times when you want to run Eclipse FAX SE directly from the HP OfficeJet LX Manager. To do so, from the HP OfficeJet LX Manager menu bar, choose **File/Run Eclipse FAX SE**.

Eclipse FAX SE makes it possible for you to do the following:

- Set up to six phonebooks (lists of names and fax numbers) for use with PC faxes. (Phonebooks are similar to the Speed Dial entries that you use for paper faxing.)
- Create a document in any Windows application and then fax it directly from your PC.
- Receive faxes directly to your PC. Once an incoming fax has been received, you can use Eclipse FAX SE to view, print, and delete it.
- Forward a fax you've received to another recipient.
- Fax a document to a file in order to use it later as a fax document.
- Scan a document into your PC to be sent as a fax, saved as a file, or printed.

There are two ways to run Eclipse FAX SE.

1. In the HP OfficeJet LX Manager menu bar, choose **File/Run Eclipse FAX SE**.
2. Double-click the Eclipse FAX SE icon in the HP OfficeJet LX program group, which is created during installation.

The Eclipse FAX SE window appears.
Note the menu bar across the top of the window.
For additional information on using the Eclipse FAX SE application, refer to the HP OfficeJet LX User's Guide.

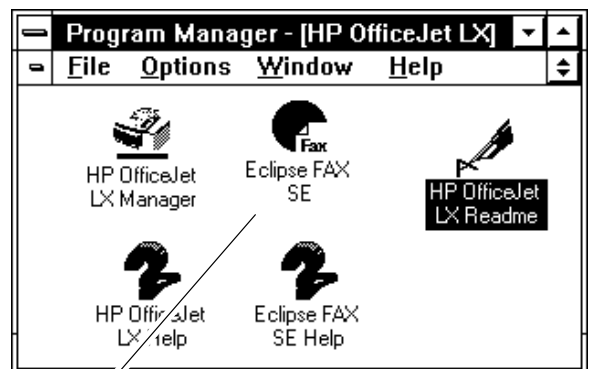

The Eclipse FAX SE icon

Sending a Fax Directly from the PC

To send a fax directly from the PC using Eclipse FAX SE, do the following:

1. Make sure of the following:

- The HP OfficeJet LX Manager is running (either in an open or minimized window). (If it isn't running, double-click the icon in the HP OfficeJet LX group window.)
- **OfficeJet Setup/Route Received Faxes** is set to **To PC**.



2. Using your Windows application, such as Write (in the Accessories group on your Windows desktop), either create your fax or open an existing document.

3. Choose **File/Print Setup** in your Windows application and select *E-FAX on CAS* as the printer.

4. Use the application's Print command to "print" the document. The Eclipse FAX SE Send Fax dialog box appears.

5. In the Send Fax dialog box,

- enter name and fax number of the intended recipients
- then click the **Send Fax** button to send it.

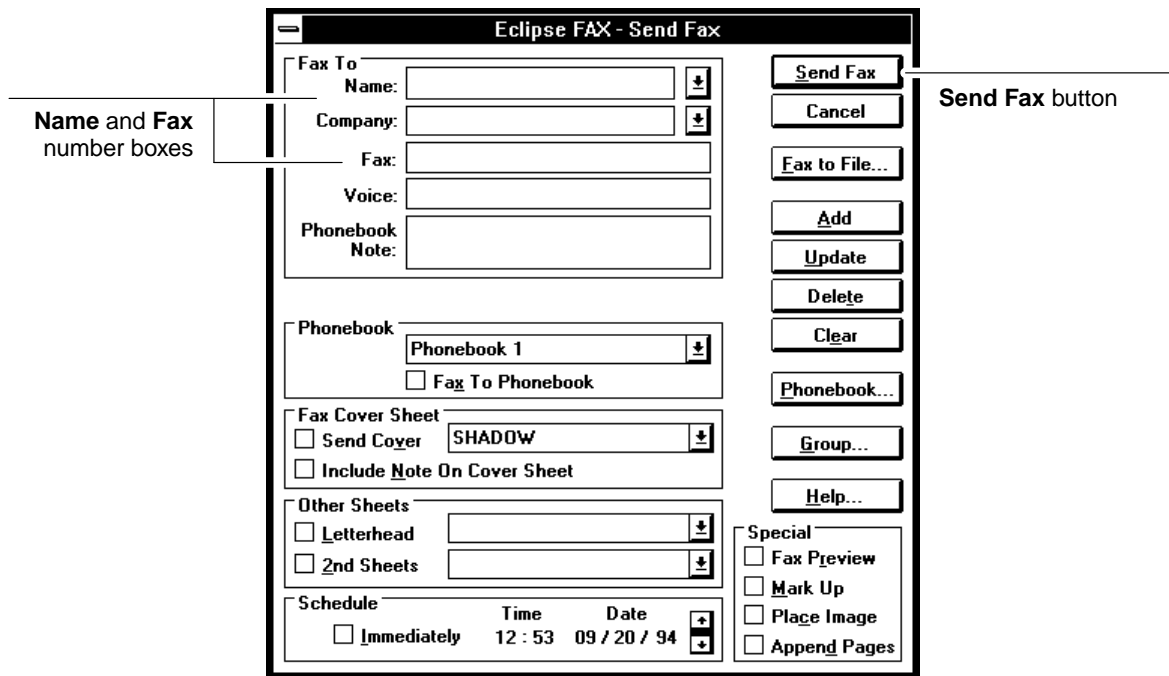

6. When the fax is sent, you can either save your PC file or close without saving it.

For detailed information on using the Eclipse FAX SE application, refer to the HP OfficeJet LX User's Guide.

To send paper faxes using the HP OfficeJet (LX) and not use the PC, refer to the HP OfficeJet (LX) User's Guide.

Receiving a Fax Directly to the PC

To receive a fax directly to the PC using Eclipse FAX SE, do the following:

1. Open the HP OfficeJet LX Manager and make sure the **OfficeJet Setup/Route Received Faxes** option is set to **To Printer**.
2. Make sure that the HP OfficeJet LX Manager is running (it can be open or minimized).
3. Make sure the **OfficeJet Setup/ Route Received Faxes** option is set to **To PC**.

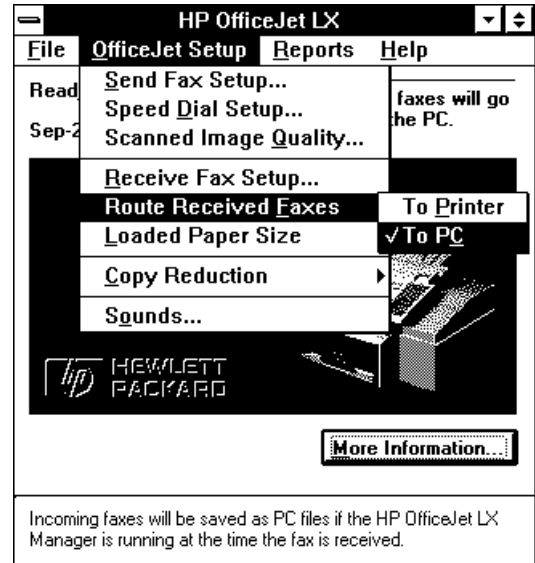

4. Open the Eclipse FAX Manager and make sure the **Notify on Receipt** box is checked in the **Receive/Setup** dialog box.

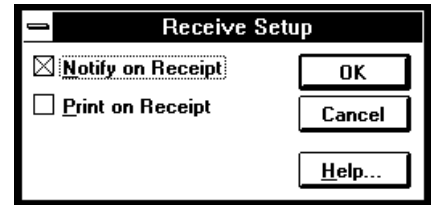

5. Someone sends you a fax.
A message from Eclipse FAX SE appears, noting that a fax has been received and asking if you want to view the Receive Log. (**Notify on Receipt**, which you selected in Step 4, controls whether or not this message appears.)

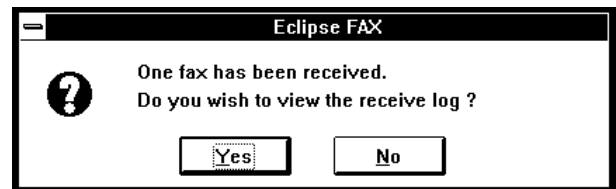

6. Click the **Yes** button.
The Receive Log appears. If necessary, click the **Unread Faxes** button to display the entry for the fax you just received.

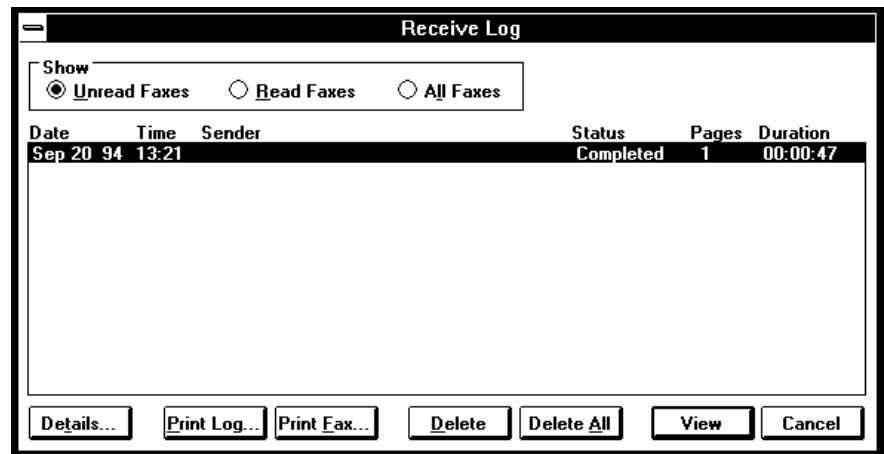

7. Highlight the entry and choose whether to print, delete, or view it.

For detailed information on using the Eclipse FAX SE application, refer to the HP OfficeJet LX User's Guide.

To receive paper faxes using the HP OfficeJet (LX) and not use the PC, refer to the HP OfficeJet (LX) User's Guide.

Using Other PC Fax Programs With the HP OfficeJet LX

The user can use most Windows–based PC fax software that supports standard CAS modems with the HP OfficeJet LX. Please note that *the HP OfficeJet LX Manager must be installed and running* in order to use PC fax software with the HP OfficeJet LX.

Hewlett-Packard has tested the following packages for compatibility with the HP OfficeJet LX:

- WinFax Pro 4.0 and 3.0, from Delrina
- DataFax 3.1, from Trio
- Eclipse FAX Professional 1.21 and 6.0, from Phoenix
- Faxworks Pro 3.0, from Sofnet
- Ultrafax 3.1, from SoftKey
- Faxit 1.0 and 2.0, from DCA/Alien

If your installation fails for any reason, refer to the application’s installation instructions or see the “Troubleshooting” section in the HP OfficeJet LX User’s Guide.

Note: In order to run the HP OfficeJet LX Manager and Eclipse FAX SE for PC faxing and scanning, you must be running Windows in 386 Enhanced Mode. (To see which mode you’re running, choose Help/About Program Manager from your Windows Program Manager menu bar.) If you have an 80386 processor with at least 2 MB of RAM, your PC should run Windows in 386 Enhanced Mode by default. If you have a 386 PC with at least 1 MB of RAM but your PC does not run Windows 386 mode by default, you can cause it to run in this mode by typing *WIN/3* to run Windows, rather than *WIN*.

Installing a Control Panel Overlay

Each HP OfficeJet is shipped with a control panel overlay installed, appropriate for the country of destination for the product. The overlay has the HP logo and OfficeJet name as well as the control panel button names printed on it. If an overlay needs to be installed, remove the protective cover from the back of the overlay and carefully position the overlay on the control panel. Then press the overlay into place.

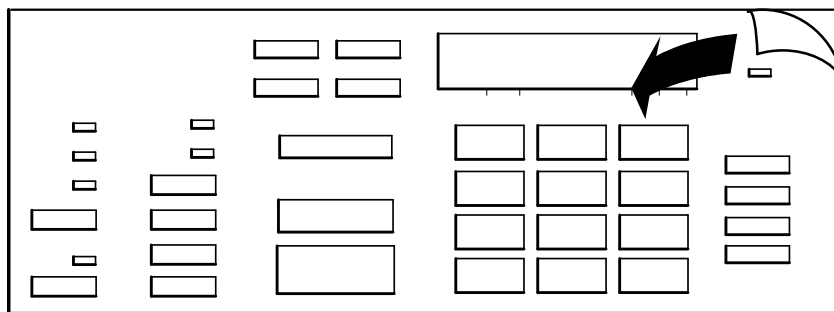

Removing the Protective Cover from the Back of the Control Panel Overlay

Installing a Print Cartridge

- 1 With the control panel and top cover open, locate the print cartridge cradle inside the HP OfficeJet, near on the right side.

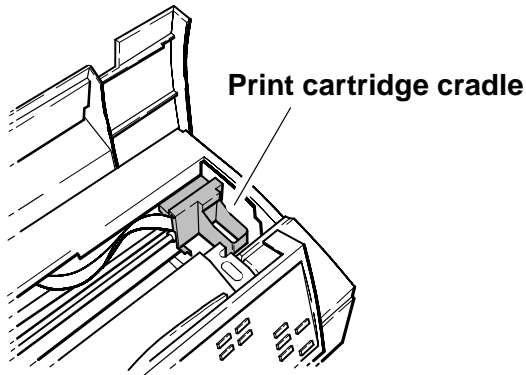

- 2 Open the print cartridge box and container, then grasp the print cartridge by the green top and remove the cartridge from the container. Gently remove *both pieces of tape – blue and white – covering the ink nozzles and vent hole.*

CAUTIONS: 1) If you don't remove the white tape, the cartridge will prematurely fail.

2) Be careful not to touch the ink nozzles or the copper contacts. Fingerprints may damage them.

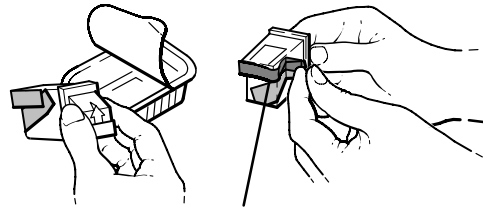

Remove **both** pieces of tape!

- 3 Place the print cartridge down into the cradle as shown. Align the green arrow on the cartridge top with the green dot on top of the cradle.

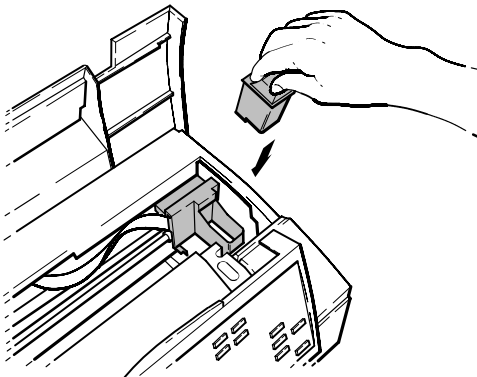

- 4 Push the green arrow toward the green dot until the cartridge **snaps** into place.

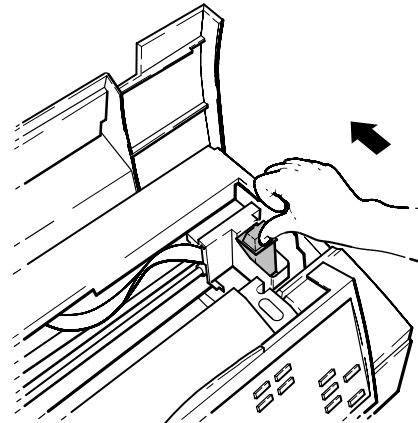

- 5 Close the top cover, then close the control panel.

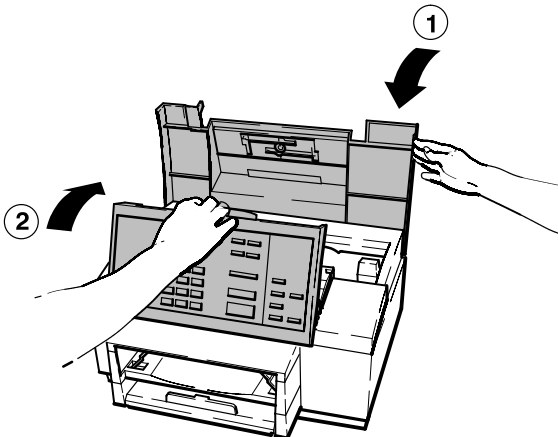

Helpful Hint:

Be sure to close the control panel firmly, until it snaps into place.

Installing an Interface Cable for Printing

You must purchase separately a shielded Centronics parallel interface cable to connect the HP OfficeJet to your computer for printing. You can use the HP C2950A (2 meter) or the HP C2951A (3 meter) Centronics parallel cable. See Chapter 1 for ordering information.

- 1 Make sure your computer is turned off by pressing “O” on the On/Off switch (located on the left side of the machine’s base). Then remove the output tray from the HP OfficeJet and set it aside.

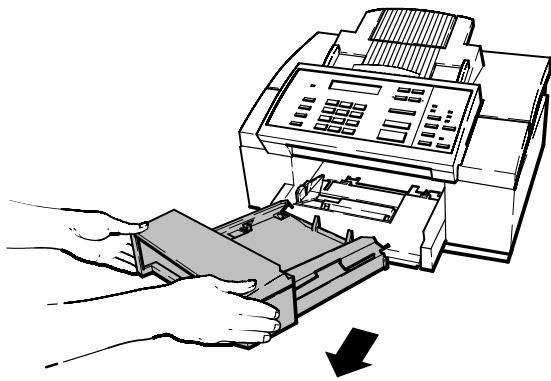

- 2 Place the HP OfficeJet on a stable surface at a safe distance from the edge. Then tilt and rotate the HP OfficeJet on its side so that the bottom of the unit faces you as shown below. Connect the *printer end** of the interface cable **firmly** to the interface port on the HP OfficeJet.

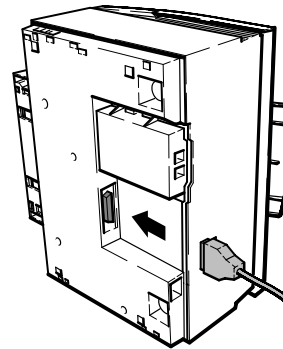

* The *printer end* of the interface cable has notches, and the *computer end* has screws.

- 3 Snap both clips into the notches on the connector as shown.

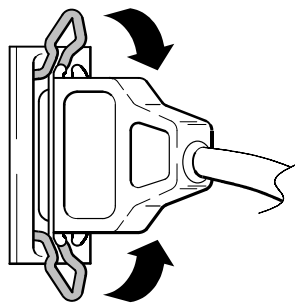

Now connect the *computer end* of the interface cable to the parallel (LPT 1) port on your computer and tighten the screws on the connector (not shown).

- 4 Return the HP OfficeJet to its upright position, making sure it does not rest on the interface cable. Insert the output tray.

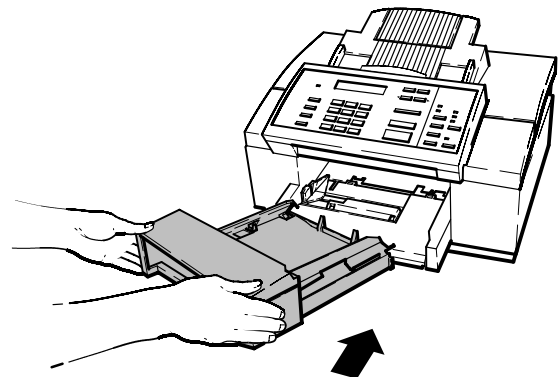

Installing the Power Cord

- 1 Make sure the printer is turned off by pressing “O” on the On/Off switch (located on the left side of the machine’s base).

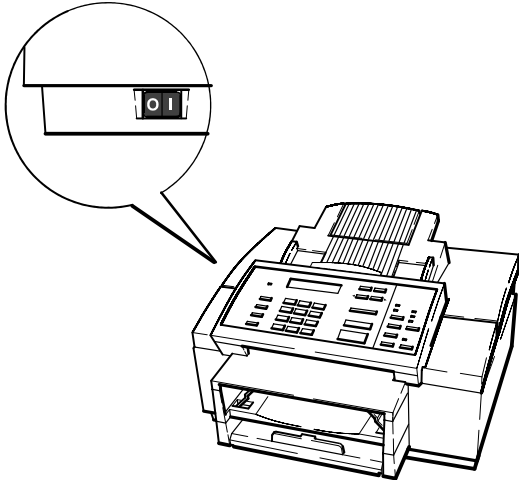

- 2 Look on the back of the HP OfficeJet and locate the power socket. Then plug the power cord connector *firmly* into the power socket.

WARNING: To avoid the possibility of electric shock, plug the other end of the cord into a grounded electrical outlet only.

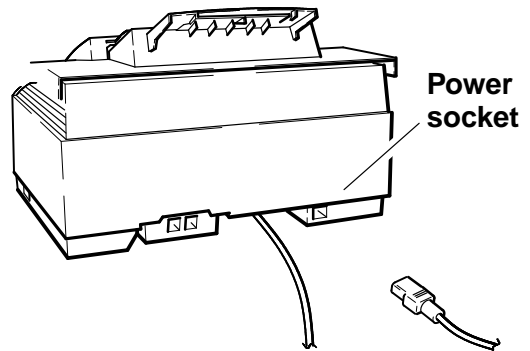

Installing a Document Catch Tray (optional)

The document catch tray will hold your original documents after they have been scanned for faxing or copying.

- 1 Remove the output tray from the HP OfficeJet.

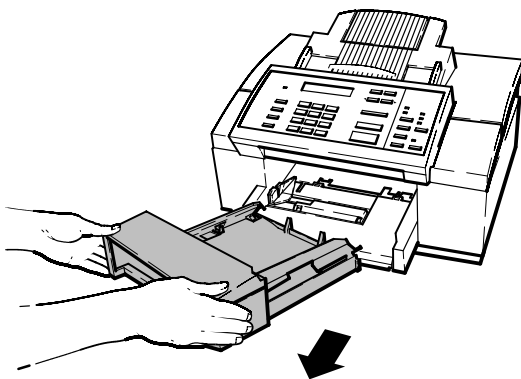

- 2 Turn over the output tray so that the bottom faces you. Using a small Phillips-head screwdriver, remove the two screws from the bottom of the tray.

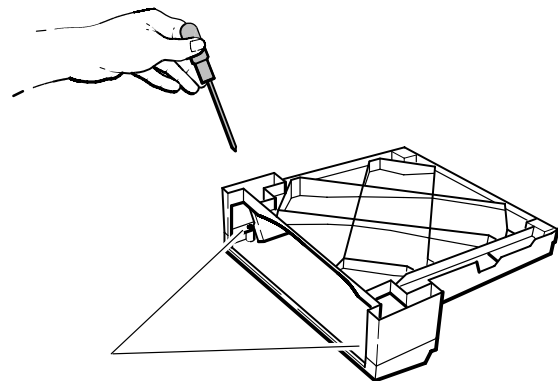

Remove both screws!

(Instructions are continued on next page)

- 3** Remove the cover of the output tray by pushing in on one side of the cover until it releases, then pulling the cover in the opposite direction to free the other side.

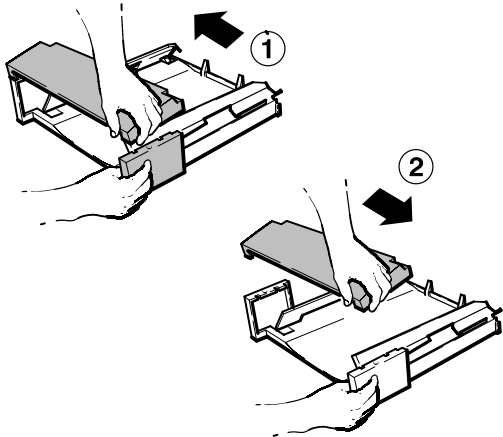

- 4** Replace the output tray. Store the cover and screws together in case you want to reinstall the cover later.

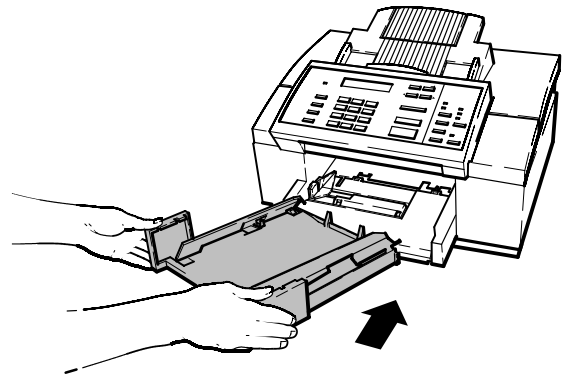

- 5** Install the catch tray by tucking the tab underneath the control panel area (shown below), then placing it to rest on the outer edges of the output tray.

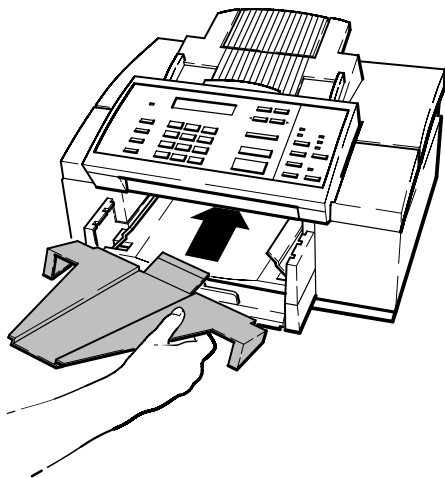

- 6** Be sure to align the catch tray so that the notches are *inside* the edges of the output tray and the front of the catch tray is flush with the front of the output tray. When the catch tray is installed correctly, here's how the HP OfficeJet should look:

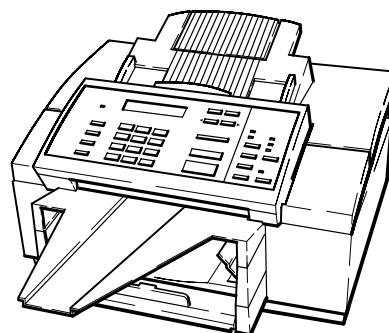

For safety purposes, the catch tray is designed to be removed easily by lifting up on the narrow end.

Installing an Access Door Assembly

The access door assembly contains the document feed tray and extender and adjustable paper size guides. Originals of faxes to be sent or documents to be copied are placed on the feed tray for processing. The tray extender can be raised to support legal size documents being faxed or copied. The paper size guides are adjusted to fit the size of the original document being sent or copied.

- 1 To remove the old access door assembly, lift open the control panel assembly and raise the access door assembly to the fully open position. Flex out the sides of the access door near the lower corners and lift the access door assembly straight up to remove it.

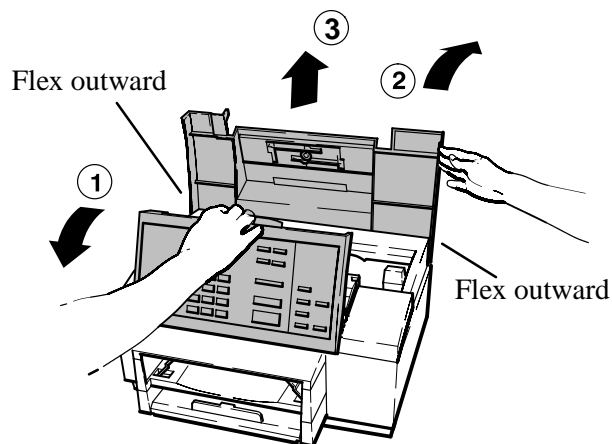

- 2 Flex out the sides of the access door near the lower corners and lower the new access door assembly into place. Close the access door and control panel assemblies. Be sure to close the control panel firmly, until it snaps into place.

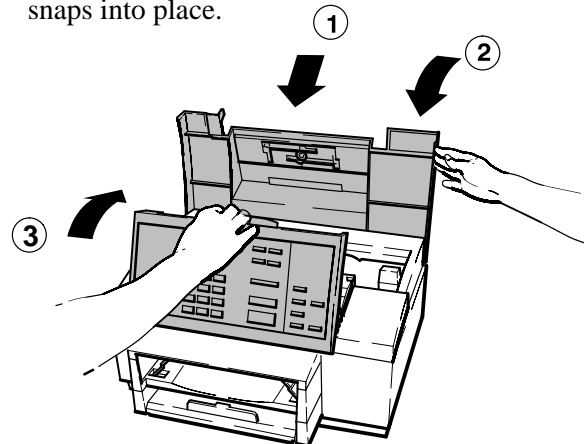

Installing an Output Tray

The output tray collects faxes, print jobs, reports and copies after they are received and printed.

- 1 Remove the old output tray from the HP OfficeJet.
- 2 Install the new output tray into the HP OfficeJet.

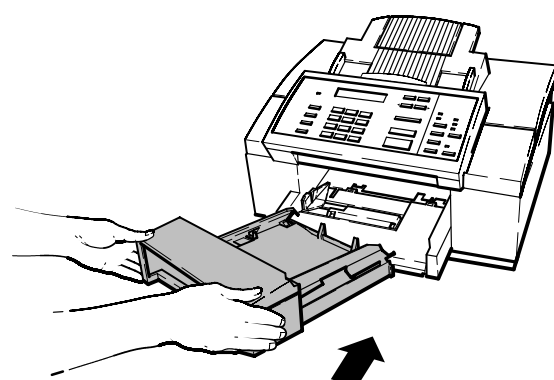
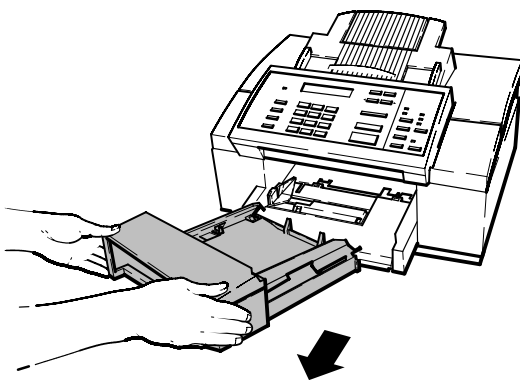

Installing an Input Tray

The input tray is also known as the paper supply tray. This tray is where paper is loaded for the printing of received faxes, print jobs, reports and copies. The tray holds 100 sheets of paper.

- 1 Remove the output tray from the HP OfficeJet.

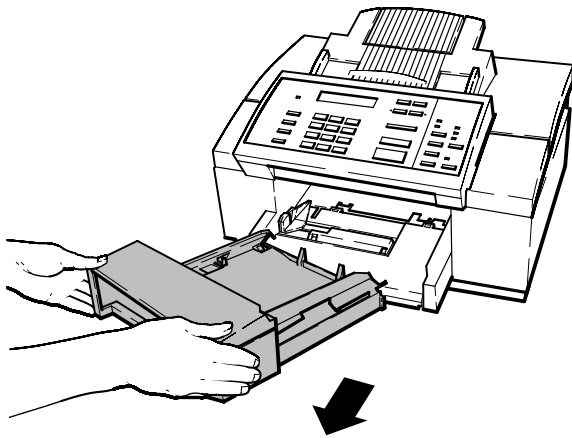

- 2 While pulling the input tray forward, flex the two tabs shown, one at a time, to release each side of the tray. If the tray does not easily release, you may need to slide the tray in slightly, flex the tab and then pull the tray forward again.

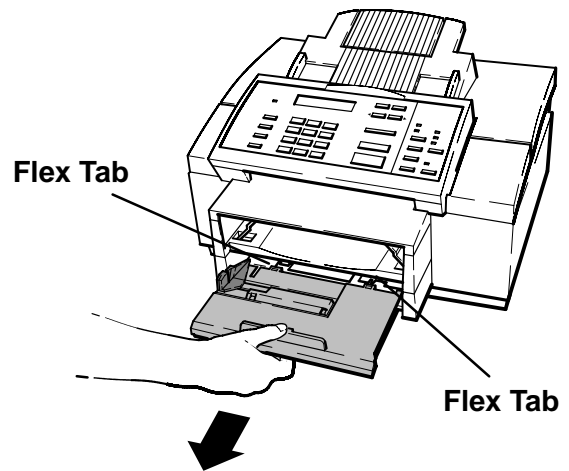

- 3 Check the position of the paper size setting and adjust if necessary. Slide the green paper guide until it snaps into place at the appropriate paper size setting.
Note: Only letter-, legal-, and A4-size paper can be loaded for fax reception and copying. Be sure to set the paper size in the menu.

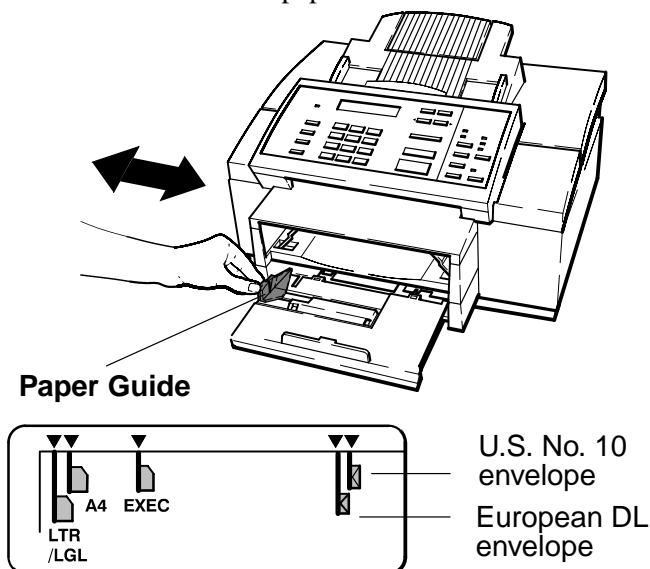

- 4 When installing the output tray, slide the tray all the way into the machine.

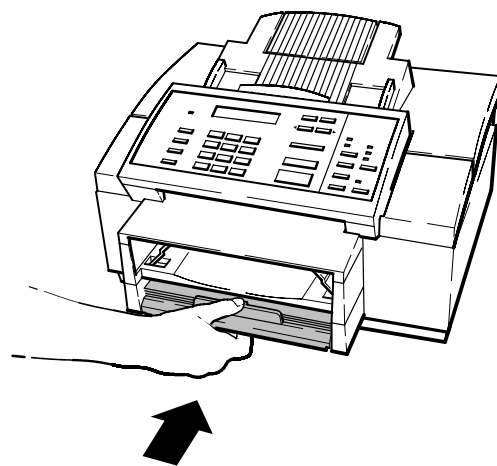

Installing a Tray Cover

- 1 Remove the output tray from the HP OfficeJet.

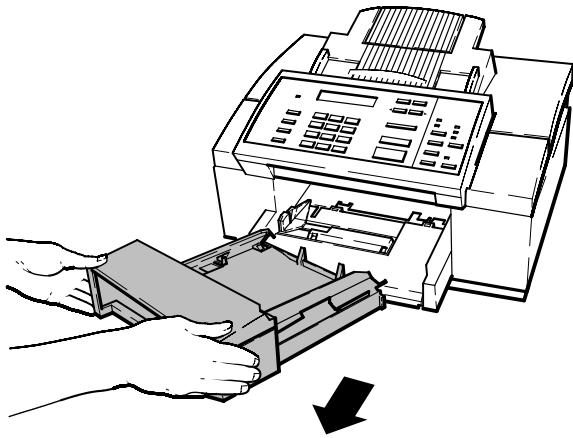

- 2 Turn over the output tray so that the bottom faces you. Using a small Phillips-head screwdriver, remove the two screws from the bottom of the tray.

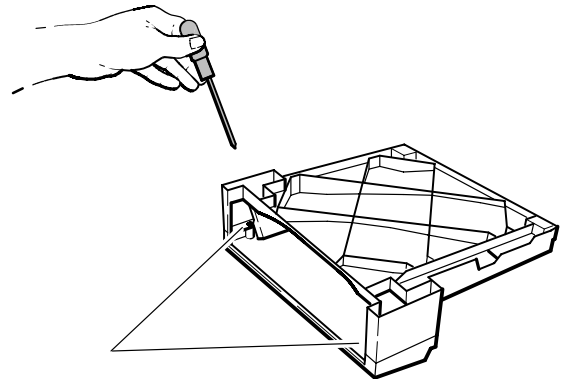

Remove **both** screws!

- 3 Remove the cover of the output tray by pushing in on one side of the cover until it releases, then pulling the cover in the opposite direction to free the other side.

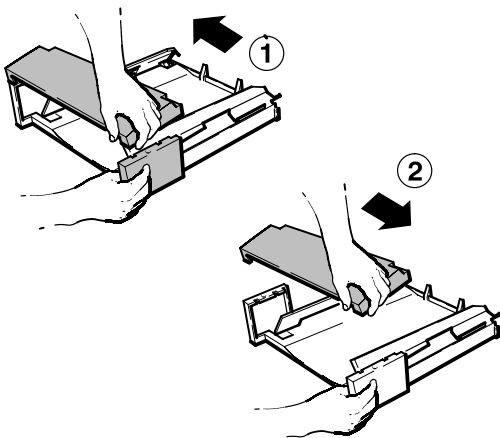

- 4 Install the new tray cover to the output tray. Do not over-tighten the two screws or you could damage the screw hole threads. When properly installed, the tray assembly should look like the one shown here.

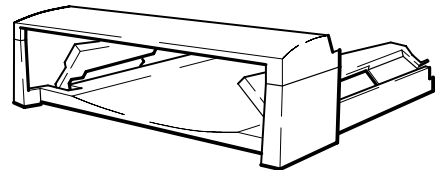

Loading Paper in the Input (Paper) Tray

- 1 Pull the input tray out until it is fully extended.

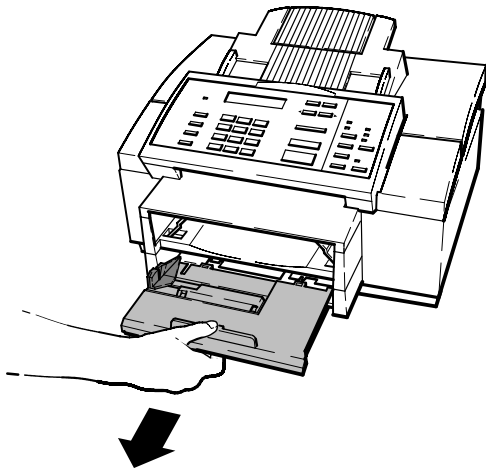

- 2 Check the position of the paper size setting and adjust if necessary.

Slide the green paper guide until it snaps into place at the appropriate paper size setting.

Note: Only letter-, legal-, and A4-size paper can be loaded for fax reception and copying. Be sure to set the paper size in the menu.

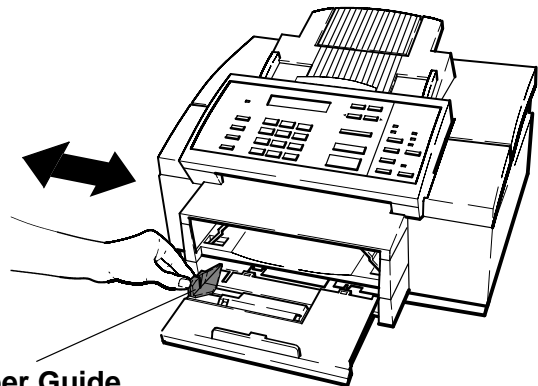

Paper Guide

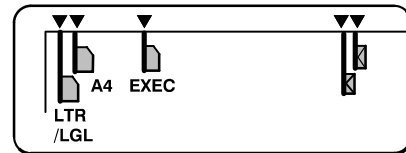

- 3 You can load up to 100 sheets (about 1 cm. or 1/2-inch thick stack) into the tray.

Load the paper (print side down), aligning the right edge of the paper to the right side of the tray. The paper stack should fit underneath the grip on the input tray handle.

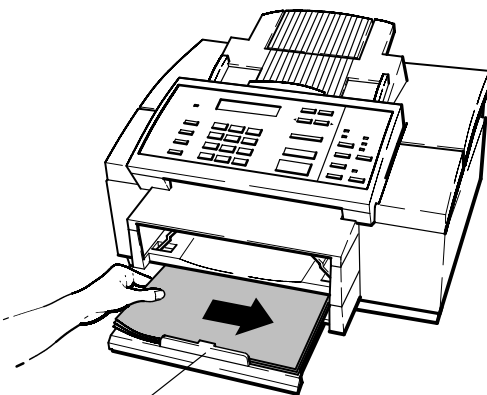

Input Tray Handle Grip

4 Helpful Hints:

Do not force the input tray all the way in when closing it. The paper must not buckle or a paper jam could occur.

This table lists the allowable paper sizes.

Description	Size
Letter	8.5 x 11 inches (216 x 279 mm)
A4 ¹	8.27 x 11.7 inches (210 x 297 mm)
Legal	8.5 x 14 inches (216 x 356 mm)
Executive ²	7.25 x 10.5 inches (184 x 267 mm)

¹ A4 is the standard size for letters in European countries.

² You cannot make copies or receive faxes on this paper size.

Loading Envelopes in the Input (Paper) Tray

- 1** Pull the input tray out until it is fully extended. You can remove the output tray to facilitate envelope loading as shown in this procedure. Be sure to install the output tray before printing.

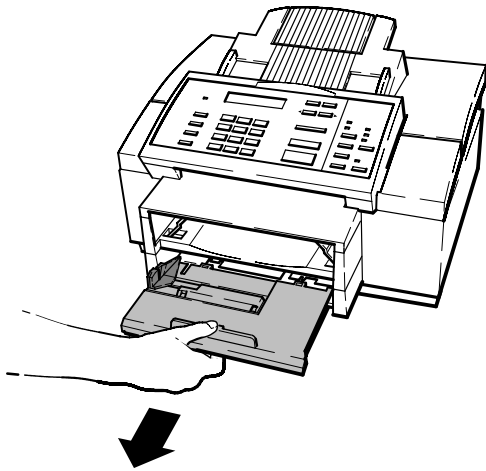

- 2** Load up to 20 envelopes flap up, with the top edge aligned to the right side of the HP OfficeJet, as shown.

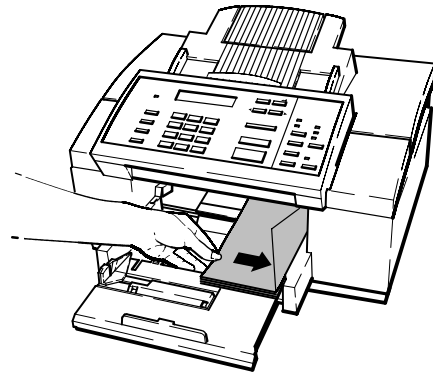

- 3** Slide the green paper guide until it snaps into place at the appropriate envelope size setting. The envelope guide will pop up to keep the envelopes vertically aligned. Install the output tray if not already installed.

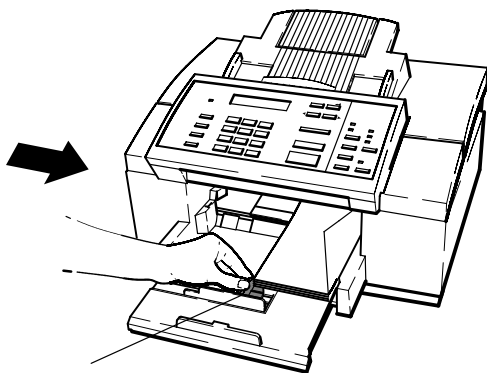

Paper Guide

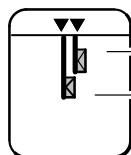

U.S. No. 10 envelope
European DL envelope

4 Helpful Hints:

Do not force the input tray all the way in when closing it. The envelopes must not buckle or a paper jam could occur.











The following table lists the two allowable envelope sizes. Note that copies cannot be made and faxes cannot be received on any envelopes. Be sure to set the paper size in the menu to envelopes before printing.

Description	Size
U.S. No. 10 envelopes	9.5 x4.12 inches (241x105 mm)
European DL envelopes	8.66x4.33 inches (220x110mm)

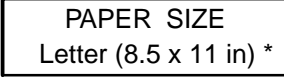
Setting the Paper Size in the Menu

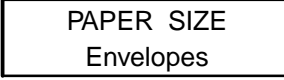
Set the paper size in the menu to match the paper size loaded in the input tray. Setting the paper size allows the HP OfficeJet to scale incoming faxes to fit the paper size loaded. The factory setting is Letter (8 1/2 x 11 inches). If Letter size paper is loaded, no changes is required unless the menu setting was previously changed and not reset to Letter size. If Legal or Envelope sizes are loaded, set the menu to the appropriate size.

The paper size in an HP OfficeJet LX is setup during installation of the software but can be changed using the HP OfficeJet LX Manager software by selecting the Loaded Paper Size in the OfficeJet Setup dialog box as described in the HP OfficeJet LX User's Guide.

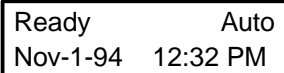
<u>Do this:</u>	<u>Using these buttons:</u>	<u>For this display:</u>
1. Press the Menu button to display the menu.	Menu 	
2. Press Right Arrow multiple times to move to "Paper Size."		
3. Press Enter/Save to select "Paper Size." The selected paper size is marked with an asterisk (*).	Enter/Save 	
4. Press Right Arrow multiple times to move to the setting you want. (The example is "Envelopes.")		
5. Press Enter/Save to select the displayed setting. An asterisk (*) denotes your new selection.	Enter/Save 	
6. Press Enter/Save to return to the Ready display.	Enter/Save 	

Setting Up for Printing

Using an HP OfficeJet LX with the HP OfficeJet LX Manager to control printing is briefly described earlier in this section. Detailed and custom setup information is provided in the HP OfficeJet LX User's Guide.

In order to use the HP OfficeJet printer function with a personal computer, the interface cable and a printer driver (also called printer software) must be installed to make the computer and computer software work with the HP OfficeJet. Printer drivers are software files that control the printer and allow the computer software applications to access the printer's features.

The HP OfficeJet will work with Microsoft® Windows 3.1, OS/2 and DOS software applications. Windows and DOS drivers are supplied with the HP OfficeJet. Install the drivers according to the instructions supplied with the drivers. Since the HP OfficeJet is compatible with HP DeskJet 520 and 510 printers, OS/2 users can select either from the printer model selection menu.

Note: If using both Windows and DOS applications, be sure to exit Windows before running the DOS applications. Do not run DOS applications from the MS-DOS prompt.

Each DOS software application requires a specific printer driver. Access to some printer features such as font selection depends on the application and driver installed.

Determine if your software application provides a printer driver that you can use.

Check the printer selection or printer setup menu in your software application for a list of printer models. The list below identifies recommended printer driver selections you can use and the type of support that each offers:

Use this printer driver selection: For this type of printer support:

HP DeskJet 520 printer	All printer features
HP DeskJet 510 printer	All printer features
HP DeskJet 550C printer	All printer features (except color)
HP DeskJet Portable printer	All printer features except envelope printing
HP DeskJet 500 printer	All printer features except for some fonts and envelope printing

Note: Unlike the HP DeskJet 520 printer, the HP OfficeJet cannot be used with external font cartridges nor accept downloadable character fonts from the PC.

Select the printer driver using the instructions provided by your software application manual.

If the HP DeskJet 520 printer is not listed, use one of the alternate printer drivers listed and contact your software company to determine if an HP DeskJet 520 printer driver is available. You could also try the HP DeskJet, HP DeskJet+ or other HP printer driver.

Note: You may need to add or change the MODE statement in your computer's AUTOEXEC.BAT file. The MODE statement tells your computer where to send printing information. This statement is not always required. If the HP OfficeJet won't print, check your AUTOEXEC.BAT file to make sure the MODE statement for a Centronics parallel connection to the LPT 1 port is: **MODE LPT 1:,,P** If you are not familiar with your AUTOEXEC.BAT file, see your DOS manual for information.

If the HP OfficeJet won't print, reconnect the interface cable and try again before referring to the troubleshooting chapter in this manual.

Setting Up for Faxing (U.S., Australia, Canada and Mexico Installations)

Using an HP OfficeJet LX with the HP OfficeJet LX Manager and Eclipse FAX SE to control faxing is briefly described earlier in this section. Detailed information is provided in the HP OfficeJet LX User's Guide. Reception mode in an HP OfficeJet LX is set during installation of the software, but can be changed using the HP OfficeJet LX Manager software as described in the HP OfficeJet LX User's Guide.

The following four types of installations are the ones recommended for use with the HP OfficeJet to achieve the best call-handling results. While other situations are possible, it is recommended that one of these be used. Determine which installation most closely meets the user's needs and follow the instructions given.

- Receive fax calls only – no voice calls, on a dedicated fax line.
- Receive fax and voice calls at the same phone number – without an answering machine.
- Receive fax and voice calls at the same phone number – with an answering machine.
- Receive fax and voice calls on the same line with distinctive ring.

After selecting the best installation to meet the user needs, the correct reception mode and certain station specific information will need to be set up. The procedures to accomplish this are in the following topics:

- Setting the Reception Mode for incoming calls.
- Setting the number of rings to answer.
- Selecting Tone or Pulse dialing
- Entering the Date and Time
- Entering the header information (company name and fax number).

Note: The HP OfficeJet is not supported with roll-over phone systems (such as the automatic answering systems often used in large companies), voicemail, call waiting, and some other advanced features provided by your phone company. If you have call waiting or other features that can be temporarily turned off by pressing a series of buttons on your phone, we recommend that you turn them off while sending and receiving faxes with the HP OfficeJet. Check with your phone company if you need help.

Receive fax calls only – no voice calls, on a dedicated fax line

This installation is recommended when using a separate telephone line and number dedicated to receiving faxes only (no voice calls). Installation consists of connecting the HP OfficeJet to the telephone wall jack with the telephone cord provided with the machine and setting the Receive Mode to Auto. Auto receive mode is the factory default set at shipment. If the setting was changed and you want to use Auto mode reception, you will need to set the mode to Auto. Instructions for setting the Receive Modes are provided later in this chapter.

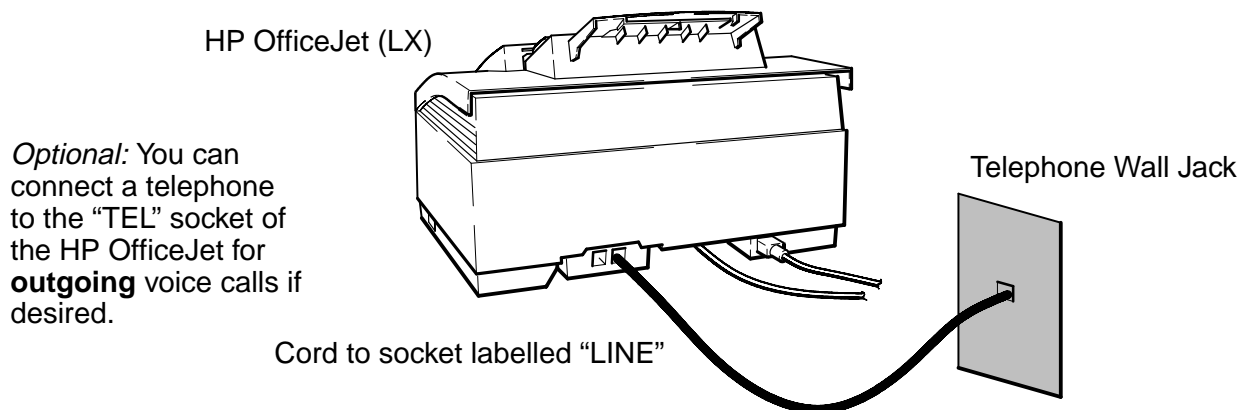

Note: In **Auto** receive mode, the HP OfficeJet will pick up the line after detecting the number of rings specified in the Rings to Answer setting and then send a fax tone signal to the calling fax machine to start communication. The fax is then sent and the HP OfficeJet will start to receive it. The Rings to Answer setting is user defined through the front panel menu. You can choose from 2 to 5 rings. The factory default is 2 rings.

Receive fax and voice calls at the same phone number – without an answering machine

This installation is recommended when using one telephone number for both fax and voice calls and not using a telephone answering machine. Installation consists of connecting the HP OfficeJet to the telephone wall jack, connecting a telephone directly to the HP OfficeJet and setting the Receive Mode to Manual. Instructions for setting the Receive Modes are provided later in this chapter.

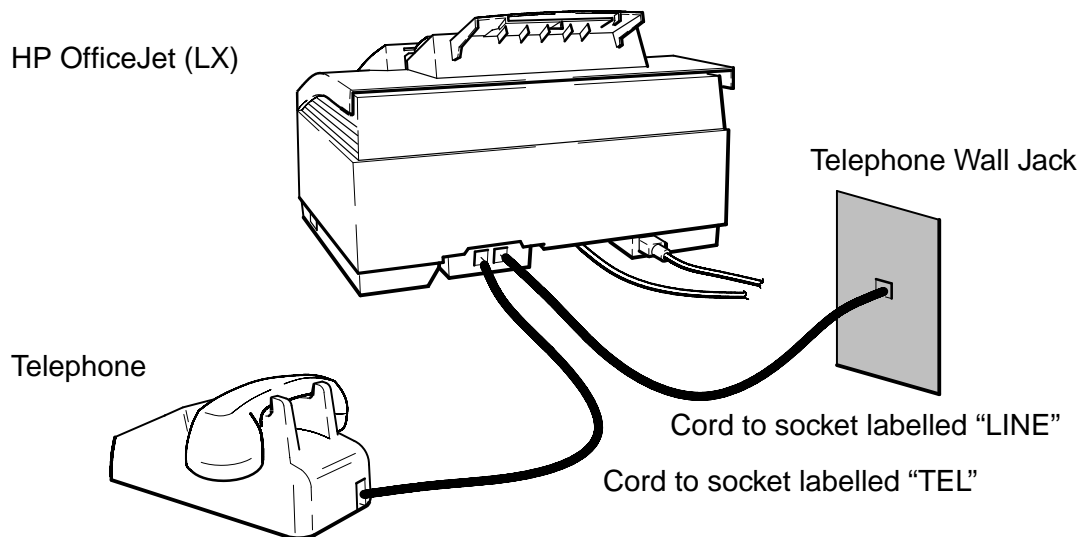

Note: In **Manual** receive mode the HP OfficeJet will never pick up the line to answer a call. All calls must be answered manually. Voice calls are treated as normal voice calls by answering the phone. To receive a fax, you must first answer the phone, listen for the fax tone and then press the **Start/Copy** button on the front panel. For fax calls, you must use the telephone that is directly connected to the TEL jack on the back of the HP OfficeJet. After answering the phone and the caller notifies you that a fax is about to be sent to you, or you hear a fax tone, press the **Start/Copy** button and then hang up the telephone. The fax is then sent and the HP OfficeJet will start to receive it.

If you have a shared fax/voice line and you want to be able to receive faxes automatically, you cannot use Manual receive mode. To receive faxes automatically, you need to either connect an answering machine to the HP OfficeJet and use Fax/TAM receive mode or, if your phone company has a distinctive ringing service available, you could connect your HP OfficeJet to receive fax and voice calls on the same line with distinctive ring in Auto receive mode. Information on using an answering machine or distinctive ring are provided later in this chapter.

Receive fax and voice calls at the same phone number – with an answering machine

This installation is recommended when using one telephone number for both fax and voice calls and using a telephone answering machine. Installation consists of connecting the HP OfficeJet to the telephone wall jack, connecting a telephone answering machine directly to the HP OfficeJet and setting the Receive Mode to Fax/TAM. Instructions for setting the Receive Mode are provided later in this chapter. Two scenarios are possible when using an answering machine – one where the telephone handset is an attached part of the answering machine and one where the telephone is a separate item that must be connected to the answering machine that is directly connected to the HP OfficeJet. Both scenarios are depicted in the following diagram.

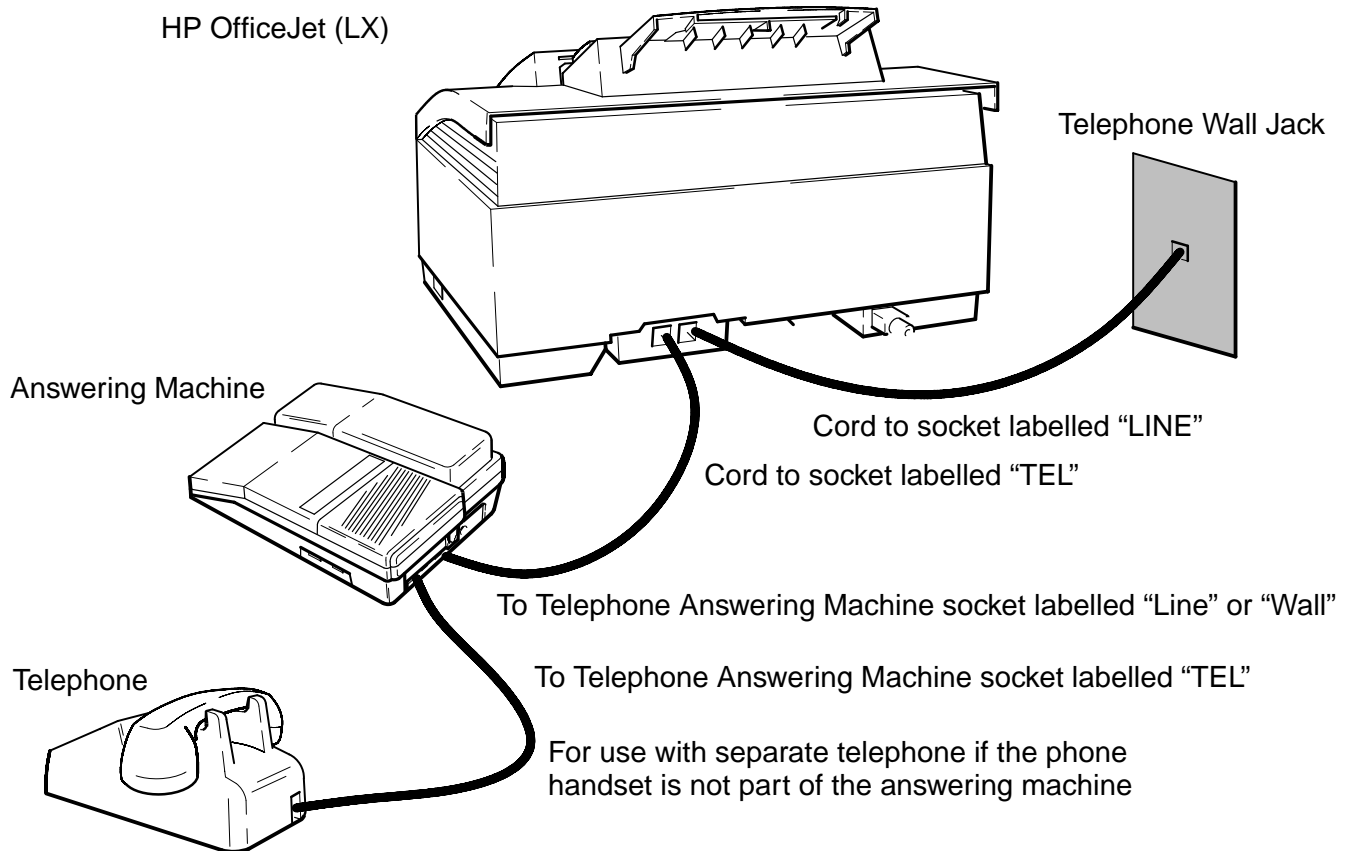

Note: In **Fax/TAM** receive mode the answering machine attached to the HP OfficeJet will answer all incoming calls and begin the outgoing message recorded on the answering machine tape. The HP OfficeJet will not pick up the line. During the outgoing message, the HP OfficeJet will monitor the incoming line for a fax tone signal. If the HP OfficeJet detects a fax tone signal, it will automatically take over the call and start to communicate with the calling fax machine to receive the fax. If a fax tone signal is not detected, the answering machine accepts the voice call and records the message.

Some older fax machines may not emit a fax calling tone. In this case the silent detect feature in the HP OfficeJet must be used in order to take the fax call. This feature is accessed through the front panel menu as described in the HP OfficeJet User's Guide, and should only be used when receiving a fax from an old model fax machine.

Receive fax and voice calls on the same line with distinctive ring

This installation is recommended when using one telephone number for both fax and voice calls and using a distinctive ringing service through the local telephone company. The telephone company's distinctive ring service allows the use of 2 or 3 phone numbers on the same phone line. The HP OfficeJet, however, will only accept up to 2 numbers on a single line. Each of the phone numbers will have a distinctive ringing pattern: The first phone number will have a single ring (ring) and the second will have a double ring (ring-ring) pattern. When activated, the HP OfficeJet distinctive ring feature can use the ring patterns to distinguish between fax and voice calls received on the same line. The feature will need to be set to ON in the OfficeJet if distinctive ring is to be used. If not used, the feature must be deactivated. Factory default for the feature is OFF.

Note: The distinctive ring feature is not available in all local telephone system networks. Currently, only certain U.S. regions and some Asian countries offer the service. The local telephone company should be contacted for availability of the service.

This application can be used either with or without an answering machine attached to the HP OfficeJet. Installation and setup for use of distinctive ring is as follows:



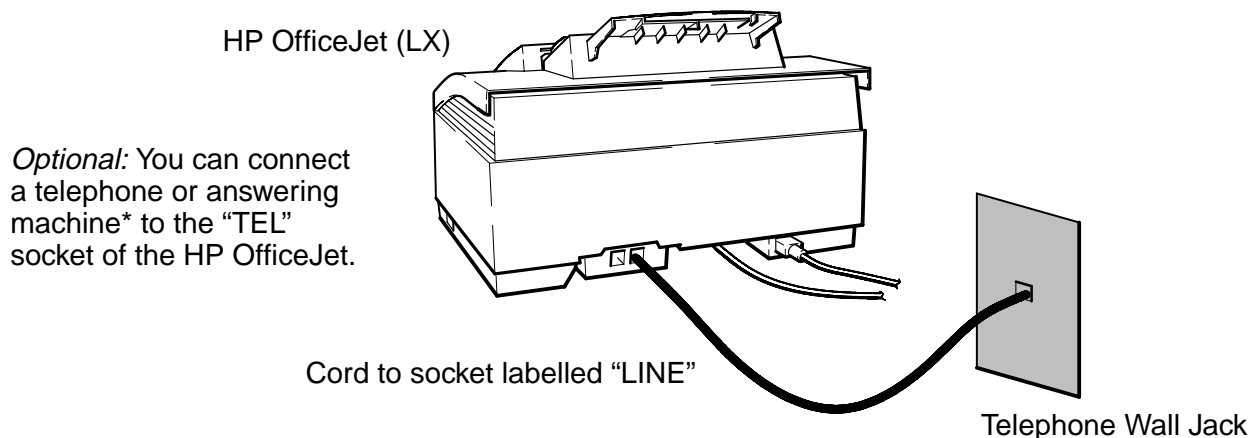







1. Connect the HP OfficeJet to the telephone wall jack.
2. If an answering machine is to be used, connected it to the HP OfficeJet, or to a separate wall jack.
3. Set the HP OfficeJet Receive Mode to **Auto**, or fax calls will not be received.
4. Also, if connecting an answering machine for voice calls on this line, make sure the setting on the answering machine that controls the number of rings before answering is set to a number *greater than* the Rings to Answer setting on the HP OfficeJet. For example, if the HP OfficeJet is set to 2 rings to answer, set the answering machine to 3 or more rings to answer. **CAUTION:** If you don't do this, you may not receive your fax calls properly. Instructions on setting the Receive Mode and HP OfficeJet Rings to Answer number are given later in this chapter.



Note: If using the telephone company's distinctive ring service, have the single-ring assigned to the phone number at which voice calls are to be received and the multiple-rings assigned to the phone number(s) at which the fax calls are to be received. When the HP OfficeJet's Distinctive Ring feature is set to **On**, it will only answer the phone and receive faxes when it detects any multiple ring pattern.





The factory default setting for the HP OfficeJet distinctive ring feature is OFF. The feature should not be set to ON unless the user has already subscribed to the telephone company's distinctive ring service. If set to ON before service is established, the HP OfficeJet will not receive faxes automatically.

Distinctive Ring in an HP OfficeJet LX is set OFF, but can be set ON using the HP OfficeJet LX Manager software by selecting the Distinctive Ring in the Receive Fax Setup dialog box as described in the HP OfficeJet LX User's Guide. To set the HP OfficeJet distinctive ring feature to ON, use the following instructions:

<u>Do this:</u>	<u>Using these buttons:</u>	<u>For this display:</u>
a. Press the Menu button to display the menu.	Menu 	MENU Time/Date, Header
b. Press Right Arrow multiple times to move to "Fax Settings."		MENU Fax Settings
c. Press Enter/Save to select "Fax Settings."	Enter/Save 	FAX SETTINGS Speed Dial Setup
d. Press Right Arrow multiple times to move to "Phone Setup."		FAX SETTINGS Phone Setup
e. Press Enter/Save to select "Phone Setup."	Enter/Save 	PHONE SETUP Rings to Answer
f. Press Right Arrow multiple times to move to "Distinctive Ring."		PHONE SETUP Distinctive Ring
g. Press Enter/Save to select "Distinctive Ring." Note that an asterisk (*) denotes the current selection.	Enter/Save 	DISTINCTIVE RING Off *
h. Press Right Arrow to move to the setting you want.		DISTINCTIVE RING On
i. Press Enter/Save to select the displayed setting. An asterisk (*) denotes your new selection.	Enter/Save 	DISTINCTIVE RING On *
j. Press Enter/Save again to return to the Ready display.	Enter/Save 	Ready Auto Sep-21-94 12:45 PM

Setting the Reception Mode for Incoming Calls











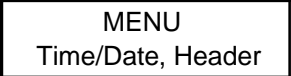

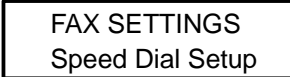

The Reception Mode affects how the HP OfficeJet answers incoming fax and voice calls. Use the following instructions to change the Reception Mode setting. Reception mode in an HP OfficeJet LX is set during installation of the software, but can be changed using the HP OfficeJet LX Manager software by selecting the Receive Mode in the Receive Fax Setup dialog box as described in the HP OfficeJet LX User's Guide. The table describes the three Receive Mode settings (**Auto**, **Manual**, and **Fax/TAM**) and when to use them.

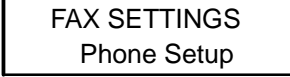
<u>Do this:</u>	<u>Using these buttons:</u>	<u>For this display:</u>				
1. Make sure the HP OfficeJet is turned on.		<table border="1"> <tr> <td>Ready</td> <td>Auto</td> </tr> <tr> <td>Jan-31-94</td> <td>12:30 PM</td> </tr> </table>	Ready	Auto	Jan-31-94	12:30 PM
Ready	Auto					
Jan-31-94	12:30 PM					
2. Press the Receive Mode button to display the current Receive Mode setting, which is marked with an asterisk (*). (The example shown is Auto, the factory setting.)	Receive Mode 	<table border="1"> <tr> <td colspan="2">RECEIVE MODE</td> </tr> <tr> <td>Auto</td> <td>*</td> </tr> </table>	RECEIVE MODE		Auto	*
RECEIVE MODE						
Auto	*					
3. Press Receive Mode multiple times to get to the appropriate setting (see <i>the following table</i>). ("Fax/TAM," shown at right, is only an example.)	Receive Mode 	<table border="1"> <tr> <td colspan="2">RECEIVE MODE</td> </tr> <tr> <td>Fax/TAM</td> <td></td> </tr> </table>	RECEIVE MODE		Fax/TAM	
RECEIVE MODE						
Fax/TAM						
4. Press Enter/Save to select the displayed setting. Note that an asterisk (*) denotes the new selection.	Enter/Save 	<table border="1"> <tr> <td colspan="2">RECEIVE MODE</td> </tr> <tr> <td>Fax/TAM</td> <td>*</td> </tr> </table>	RECEIVE MODE		Fax/TAM	*
RECEIVE MODE						
Fax/TAM	*					
5. Press Enter/Save again to return to the Ready display. Note that the Receive Mode selected is displayed on the top line next to "Ready."	Enter/Save 	<table border="1"> <tr> <td>Ready</td> <td>Fax/TAM</td> </tr> <tr> <td>Jan-31-94</td> <td>12:32 PM</td> </tr> </table>	Ready	Fax/TAM	Jan-31-94	12:32 PM
Ready	Fax/TAM					
Jan-31-94	12:32 PM					

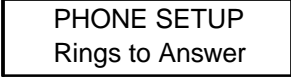
<u>If you have this type of setup:</u>	<u>Set the Receive Mode to:</u>	<u>And read this note:</u>
Dedicated fax line (receives only fax calls)	Auto	When Auto is selected with a dedicated fax line, the HP OfficeJet answers all incoming calls after the number of rings specified in the Rings to Answer setting and sends out fax reception tones to receive a fax.
Shared fax/voice line, no answering machine, telephone connected to HP OfficeJet	Manual	When Manual is selected, the HP OfficeJet never answers incoming calls. To receive a fax, pick up the handset of the phone connected to the HP OfficeJet, press the Start/Copy button, then hang up the phone.
Shared fax/voice line, with answering machine	Fax/TAM (TAM means telephone answering machine)	When Fax/TAM is selected, the answering machine answers all calls (after the number of rings specified on that device), and the HP OfficeJet automatically takes over the line when a fax tone is detected. Notes: 1) This setting will not work unless you have connected an answering machine <i>directly</i> to the HP OfficeJet. 2) For best results, limit the greeting message on the answering machine to 10 seconds.
Shared fax/voice line, with Distinctive Ring feature (with or without an answering machine)	Auto	When Auto is selected and you have subscribed to a distinctive ring feature through your phone company, the HP OfficeJet will only answer incoming calls with any multiple-ringing pattern.

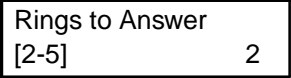

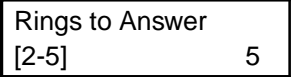

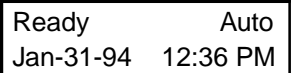





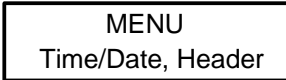



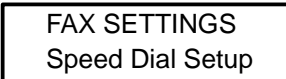

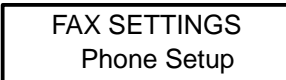

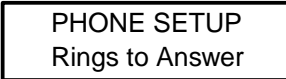
Setting the Number of Rings to Answer

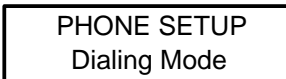
The number of rings setting is **ONLY** used when the HP OfficeJet is used in the Auto Receive Mode. This setting is used to determine the number of rings sensed before the HP OfficeJet answers a call. Although the range of rings may vary for different countries, in the U.S.A., up to 5 rings can be set. The factory default setting is 2 rings. The number of rings to answer in an HP OfficeJet LX is set during installation of the software, but can be changed using the HP OfficeJet LX Manager software by setting the Rings to Answer in the Receive Fax Setup dialog box as described in the HP OfficeJet LX User's Guide.

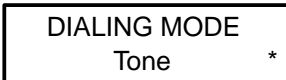
<u>Do this:</u>	<u>Using these buttons:</u>	<u>For this display:</u>
1. Press the Menu button to display the Menu.		
2. Press Right Arrow multiple times to move to "Fax Settings."		
3. Press Enter/Save to select "Fax Settings."		
4. Press Right Arrow multiple times to move to "Phone Setup."		
5. Press Enter/Save to select "Phone Setup." ("Rings to Answer" is displayed.)		
6. Press Enter/Save to select "Rings to Answer." The allowable range (in brackets) and the factory setting (far right) are displayed.		
7. Enter a number up to 5, inclusive. (The example shows that 5 has been entered.)		
8. Press Enter/Save to save the new value and return to the Ready display.		

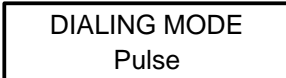
Selecting Tone or Pulse Dialing

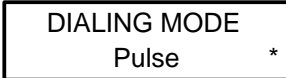
The HP OfficeJet is factory set for touchtone (Tone) dialing telephone systems. If used with a rotary (Pulse) dialing telephone system, the HP OfficeJet will need to be set for Pulse dialing. This procedure can be used to set for either dialing system as required. The dialing mode in an HP OfficeJet LX is set during installation of the software, but can be changed using the HP OfficeJet LX Manager software by selecting Tone or Pulse in the Dialing Mode menu of the Send Fax Setup dialog box as described in the HP OfficeJet LX User's Guide.

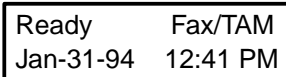









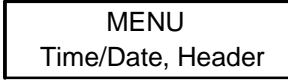

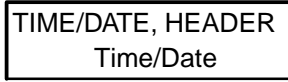

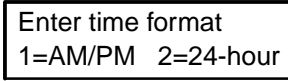
<u>Do this:</u>	<u>Using these buttons:</u>	<u>For this display:</u>
1. Press the Menu button to display the menu.		
2. Press Right Arrow multiple times to move to "Fax Settings."		
3. Press Enter/Save to select "Fax Settings."		
4. Press Right Arrow multiple times to move to "Phone Setup."		
5. Press Enter/Save to select "Phone Setup."		
6. Press Right Arrow multiple times to move to "Dialing Mode."		
7. Press Enter/Save to select "Dialing Mode." The factory setting, Tone , is displayed.		
8. Press Right Arrow to move to "Pulse."		
9. Press Enter/Save to select "Pulse." An asterisk (*) denotes your new selection.		
10. Press Enter/Save again to return to the Ready display.		

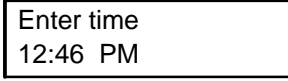
Entering the Date and Time

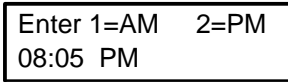
Date and Time entries are required on all outgoing faxes. The fax log report will also reflect the date and time of transactions for reference. When entering the information, the current date and time should be entered for accurate reports and tracking of transactions. The date and time information in an HP OfficeJet LX is set during installation of the software, but can be changed using the HP OfficeJet LX Manager software by selecting the Send Fax Setup dialog box and entering the information as described in the HP OfficeJet LX User's Guide.

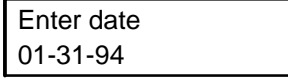
Note: The Telephone Protection Act of 1991 requires that all faxes transmitted in the U.S.A. display the date and time they are sent in a header, footer or cover page. Most applications contain the information in the document header.

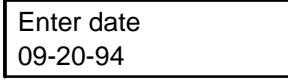
The date and time can be entered using this procedure.

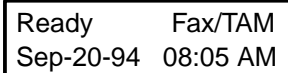







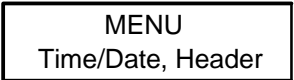

Do this:	Using these buttons:	For this display:
1. Press the Menu button to display the menu. ("Time/Date, Header" is displayed.)	Menu 	
2. Press Enter/Save to select "Time/Date, Header." ("Time/Date" is displayed.)	Enter/Save 	
3. Press Enter/Save to select "Time/Date."	Enter/Save 	
4. Press "1" if you want to enter the time in AM/PM format, or press "2" to enter the time in 24-hour format. (The example shows the AM/PM format.)	 or 	
5. Enter the current time in the format you selected. (Example shows AM/PM format.) Press the Backspace button to correct any mistakes.	 through 	
6. If you chose AM/PM format, you will be prompted to select AM or PM after entering the time. Press "1" to select AM or "2" to select PM.	 or 	
7. Enter the current date in month-day-year format.	 through 	
8. Press Enter/Save to save the date you entered.	Enter/Save 	

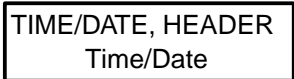
Entering the Header Information (company name and fax number)

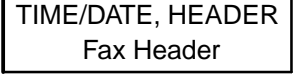
Sender Identification and fax number entries are required on all outgoing faxes. This information will appear in the header of transactions for reference. The header information in an HP OfficeJet LX is set during installation of the software, but can be changed using the HP OfficeJet LX Manager software by selecting the Send Fax Setup dialog box and entering the information as described in the HP OfficeJet LX User's Guide.

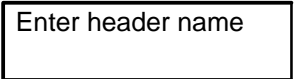
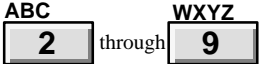
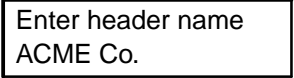
Note: The Telephone Protection Act of 1991 requires that all faxes transmitted in the U.S.A. display the sender's identifying name and fax number in a header, footer or cover page. Most applications contain the information in the document header.

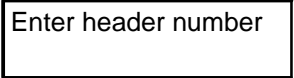
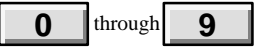
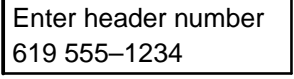
Use this procedure to enter the information.

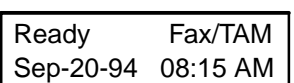
- | <u>Do this:</u> | <u>Using these buttons:</u> | <u>For this display:</u> |
|--------------------------------------------------------------------------------------------------------------------------------------------------------------------------------------------------------------------------------------------------------------------------------------------------------------------------------------------------------------------------------------------------------------------------------------------------------------------------------------------------------------------------------------------------------------------------------------------------------------------------|--------------------------------------------------------------------------------------|---------------------------------------------------------------------------------------|
| 1. Press the Menu button to display the menu. "Time/Date, Header" is displayed. |  |  |
| 2. Press Enter/Save to select "Time/Date, Header." |  |  |
| 3. Press Right Arrow to move to "Fax Header." |  |  |
| 4. Press Enter/Save to select "Fax Header." |  |  |
| 5. Type the name you want displayed in the header of your outgoing faxes, using these guidelines: |  |  |
| <ul style="list-style-type: none"> • Enter up to 25 characters, including letters, symbols, and spaces. • Use the number buttons 2 through 9 to enter the lowercase and uppercase letters shown above the buttons. • After entering a character, use Right Arrow to move the cursor to the right before entering the next character. • Use the Space button to enter a space. • Use the Symbols button to enter punctuation and symbols, such as a period (.), an asterisk (*), or an at sign (@). | | |
| 6. Press Enter/Save to save the name you typed. |  |  |
| 7. Enter the telephone number of the fax line you've connected to your HP OfficeJet using these guidelines: |  |  |
| <ul style="list-style-type: none"> • Up to 20 characters are allowed, including numbers, spaces, dashes (-), and the plus sign (+). • Use the Space button to enter a space. • Use the Redial/Pause button to enter a 2-second pause, indicated by a dash (-). • Use the Symbols button to enter a plus sign (+) before the country code when dialing your fax number from another country. (For example, +1 619 555-1234.) The country code for the U.S. and Canada is 1. For more information about international calls, contact the telephone company. | | |
| 8. Press Enter/Save to save the fax number you entered and return to the Ready display. |  |  |

Setting Up for Faxing (U.K. Installation)

The following types of installations are the ones recommended for use with the HP OfficeJet LX to achieve the best call-handling results. While other situations are possible, it is recommended that one of these be used. Determine which installation most closely meets the user's needs and follow the instructions given.

- Receive fax calls only – no voice calls, on a dedicated fax line.
- Receive fax and voice calls at the same phone number – without an answering machine.
- Receive fax and voice calls at the same phone number – with an answering machine.

After selecting the best installation to meet the user needs, the correct reception mode and certain station specific information will need to be set up. The procedures to accomplish this are in the following topics which are presented in the HP OfficeJet LX User's Guide:

- Setting the Reception Mode for incoming calls.
- Setting the number of rings to answer.
- Selecting Tone or Pulse dialing
- Entering the Date and Time
- Entering the header information (company name and fax number).

Refer to the HP OfficeJet LX User's Guide for use with the Mercury Telephone Network System.

Using an HP OfficeJet LX with the HP OfficeJet LX Manager and Eclipse FAX SE to control faxing is briefly described earlier in this section. Detailed information is provided in the HP OfficeJet LX User's Guide. Reception mode in an HP OfficeJet LX is set during installation of the software, but can be changed using the HP OfficeJet LX Manager software by selecting the Receive Mode in the Receive Fax Setup dialog box as described in the HP OfficeJet LX User's Guide.

Receive fax calls only – no voice calls, on a dedicated fax line

This installation is recommended when using a separate telephone line and number dedicated to receiving faxes only (no voice calls). Installation consists of connecting the HP OfficeJet to the telephone wall jack using the telephone cord provided, and setting the Receive Mode to Auto. Refer to the HP OfficeJet LX User's Guide.

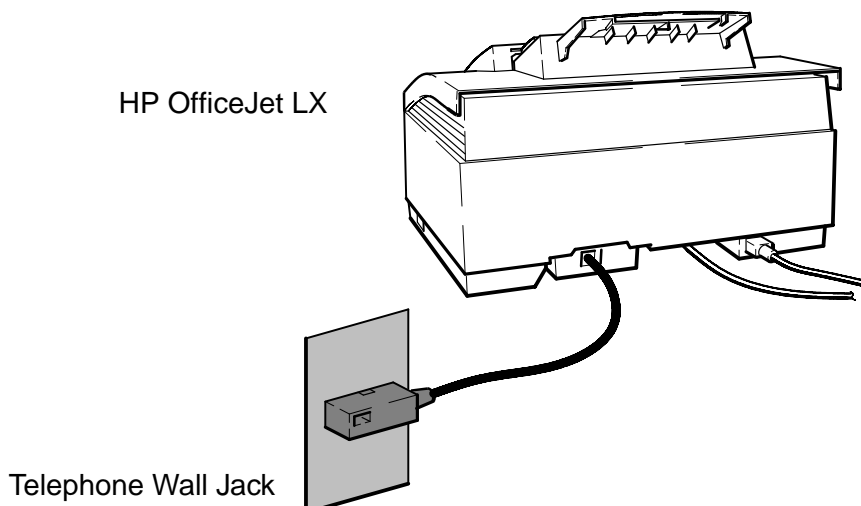

Receive fax and voice calls at the same phone number – without an answering machine

This installation is recommended when using one telephone number for both fax and voice calls and not using a telephone answering machine. Installation consists of connecting the HP OfficeJet LX to the telephone wall jack, connecting the telephone directly to the HP OfficeJet LX wall jack connector as shown, and setting the Receive Mode to Manual. Refer to the HP OfficeJet LX User's Guide.

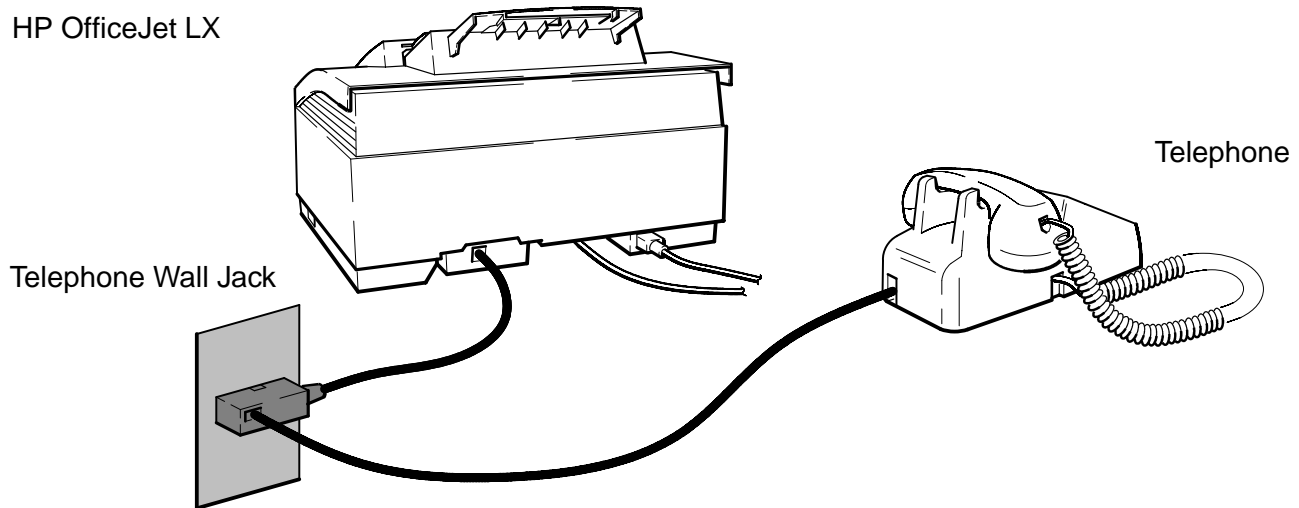

Receive fax and voice calls at the same phone number – with an answering machine

This installation is recommended when using one telephone number for both fax and voice calls and using a telephone answering machine. Installation consists of connecting the HP OfficeJet LX to the telephone wall jack, connecting the telephone answering machine directly to the HP OfficeJet LX wall jack connector as shown, and setting the Receive Mode to Fax/TAM. Refer to the HP OfficeJet LX User's Guide. Two scenarios are possible when using an answering machine – one where the telephone handset is an attached part of the answering machine and one where the telephone is a separate item that must be connected following the answering machine. Both scenarios are depicted in the following diagram.

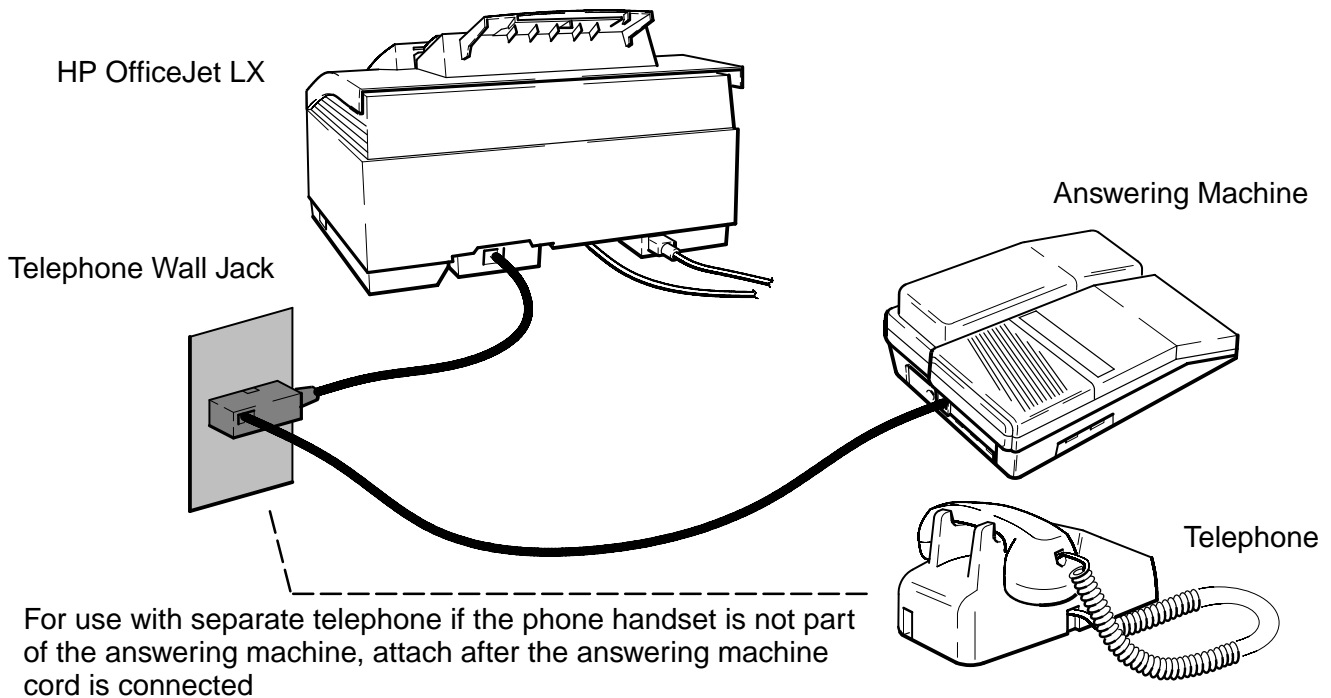

Setting Up for Faxing (Germany Installation)

The following types of installations are the ones recommended for use with the HP OfficeJet LX to achieve the best call-handling results. While other situations are possible, it is recommended that one of these be used. Determine which installation most closely meets the user's needs and follow the instructions given.

- Receive fax calls only – no voice calls, on a dedicated fax line.
- Receive fax and voice calls at the same phone number – without an answering machine.
- Receive fax and voice calls at the same phone number – with an answering machine.

After selecting the best installation to meet the user needs, the correct reception mode and certain station specific information will need to be set up. The procedures to accomplish this are in the following topics which are presented in the HP OfficeJet LX User's Guide:

- Setting the Reception Mode for incoming calls.
- Setting the number of rings to answer.
- Selecting Tone or Pulse dialing
- Entering the Date and Time
- Entering the header information (company name and fax number).

Refer to the HP OfficeJet LX User's Guide for use in a PBX system.

Using an HP OfficeJet LX with the HP OfficeJet LX Manager and Eclipse FAX SE to control faxing is briefly described earlier in this section. Detailed information is provided in the HP OfficeJet LX User's Guide. Reception mode in an HP OfficeJet LX is set during installation of the software, but can be changed using the HP OfficeJet LX Manager software by selecting the Receive Mode in the Receive Fax Setup dialog box as described in the HP OfficeJet LX User's Guide.

The three types of installation recommended can be depicted in the same diagram as shown below. Each device is attached directly to the wall jack and specific N-F-N slot as shown. Installation consists of connecting the HP OfficeJet, answering machine and telephone directly to the telephone wall jack as shown. Set the Receive Mode as specified in the HP OfficeJet LX User's Guide.

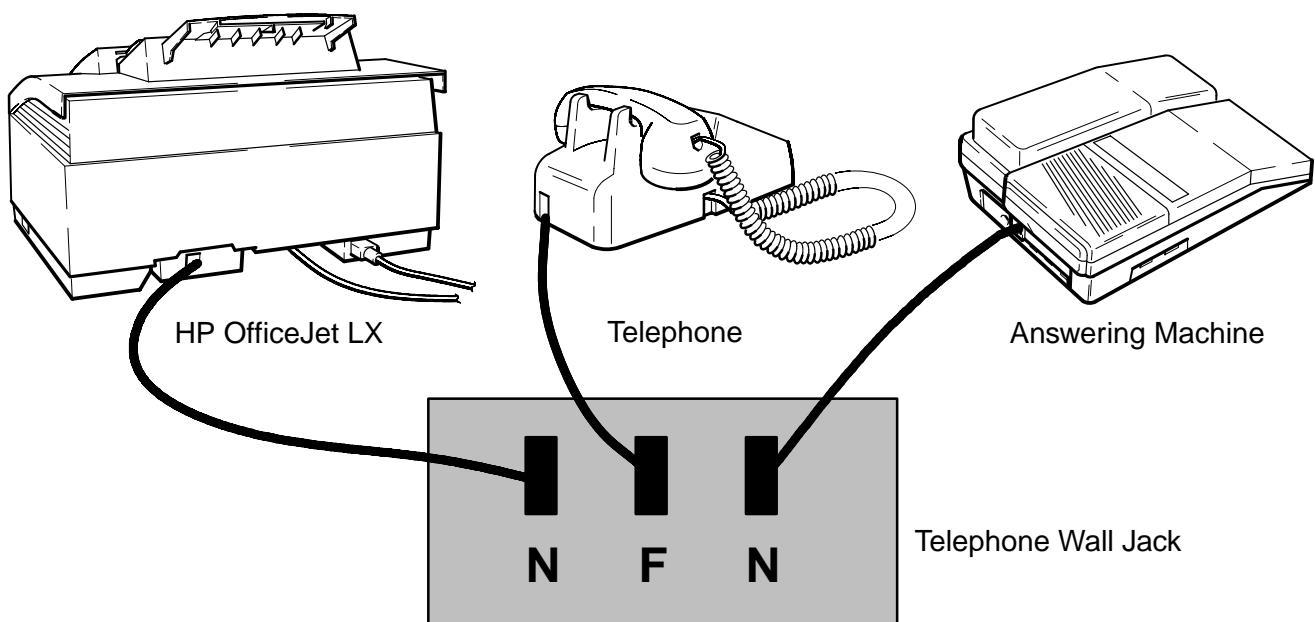

Setting Up for Faxing (France Installation)

The following types of installations are the ones recommended for use with the HP OfficeJet LX to achieve the best call-handling results. While other situations are possible, it is recommended that one of these be used. Determine which installation most closely meets the user's needs and follow the instructions given.

- Receive fax calls only – no voice calls, on a dedicated fax line.
- Receive fax and voice calls at the same phone number – without an answering machine.
- Receive fax and voice calls at the same phone number – with an answering machine.

After selecting the best installation to meet the user needs, the correct reception mode and certain station specific information will need to be set up. The procedures to accomplish this are in the following topics which are presented in the HP OfficeJet LX User's Guide:

- Setting the Reception Mode for incoming calls.
- Setting the number of rings to answer.
- Selecting Tone or Pulse dialing
- Entering the Date and Time
- Entering the header information (company name and fax number).

Using an HP OfficeJet LX with the HP OfficeJet LX Manager and Eclipse FAX SE to control faxing is briefly described earlier in this section. Detailed information is provided in the HP OfficeJet LX User's Guide. Reception mode in an HP OfficeJet LX is set during installation of the software, but can be changed using the HP OfficeJet LX Manager software by selecting the Receive Mode in the Receive Fax Setup dialog box as described in the HP OfficeJet LX User's Guide.

Receive fax calls only – no voice calls, on a dedicated fax line

This installation is recommended when using a separate telephone line and number dedicated to receiving faxes only (no voice calls). Installation consists of connecting the HP OfficeJet to the telephone wall jack using the telephone cord provided, and setting the Receive Mode to Auto. Refer to the HP OfficeJet LX User's Guide.

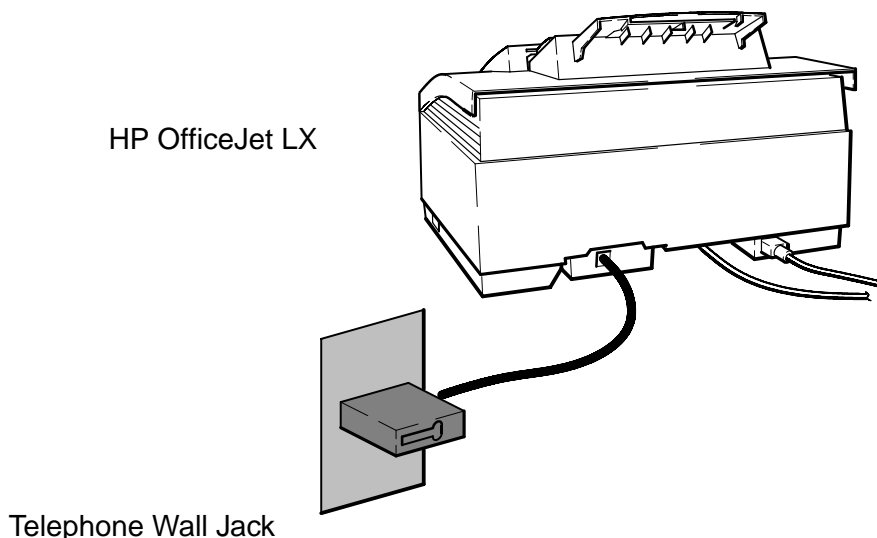

Receive fax and voice calls at the same phone number – without an answering machine

This installation is recommended when using one telephone number for both fax and voice calls and not using a telephone answering machine. Installation consists of connecting the HP OfficeJet LX to the telephone wall jack, connecting the telephone directly to the HP OfficeJet LX wall jack connector as shown, and setting the Receive Mode to Manual. Refer to the HP OfficeJet LX User's Guide.

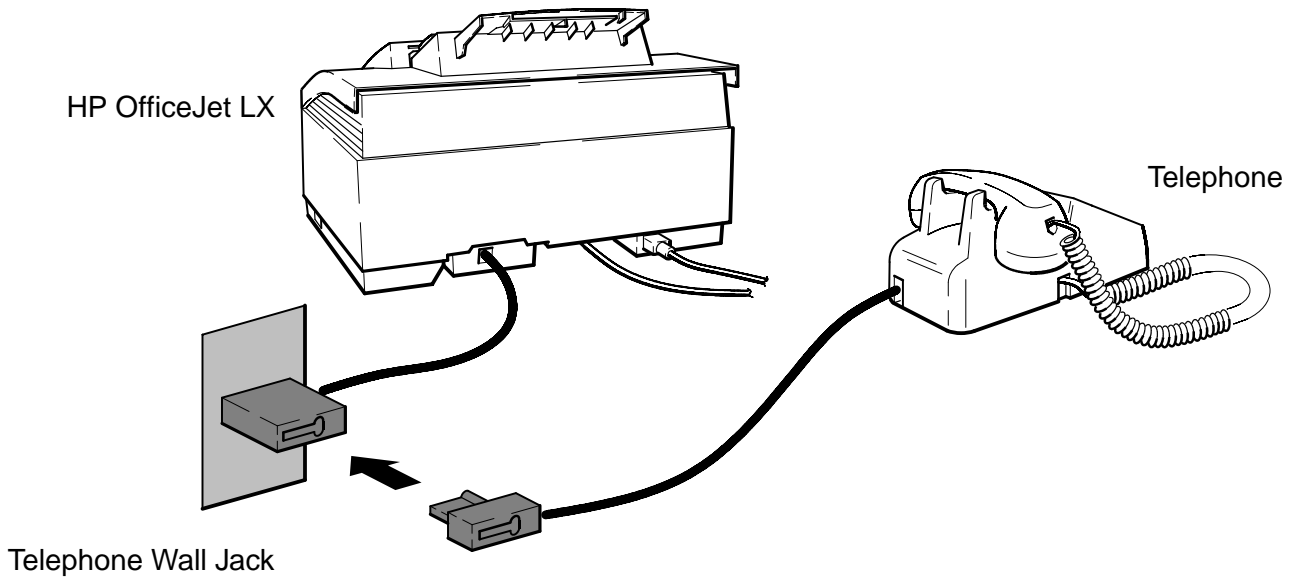

Receive fax and voice calls at the same phone number – with an answering machine

This installation is recommended when using one telephone number for both fax and voice calls and using a telephone answering machine. Installation consists of connecting the HP OfficeJet LX to the telephone wall jack, connecting the telephone answering machine directly to the HP OfficeJet LX wall jack connector as shown, and setting the Receive Mode to Fax/TAM. Refer to the HP OfficeJet LX User's Guide. Two scenarios are possible when using an answering machine – one where the telephone handset is an attached part of the answering machine and one where the telephone is a separate item that must be connected following the answering machine. Both scenarios are depicted in the following diagram.

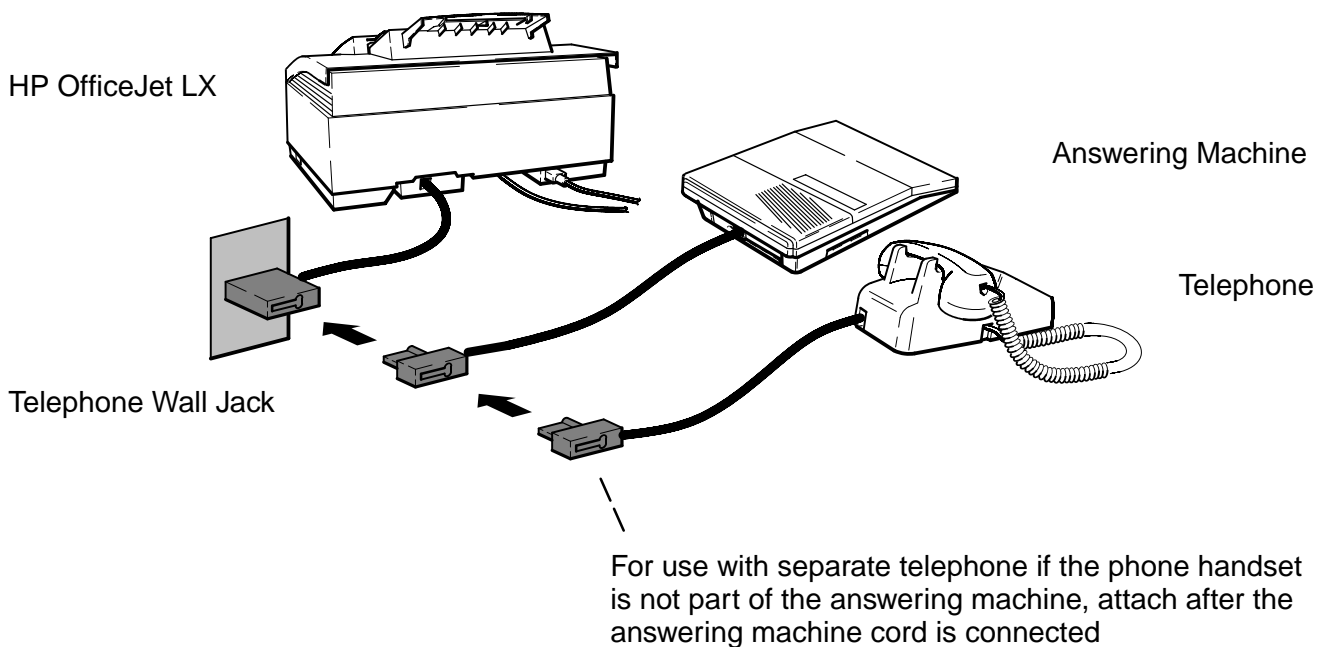
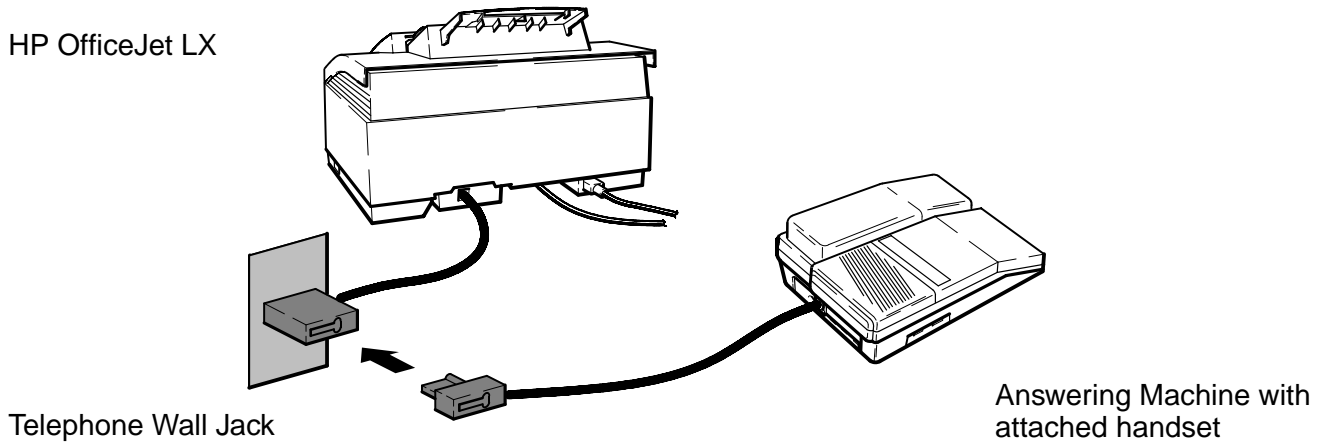

Setting Up for Faxing (Netherlands Installation)

The following types of installations are the ones recommended for use with the HP OfficeJet LX to achieve the best call-handling results. While other situations are possible, it is recommended that one of these be used. Determine which installation most closely meets the user's needs and follow the instructions given.

- Receive fax calls only – no voice calls, on a dedicated fax line.
- Receive fax and voice calls at the same phone number – without an answering machine.
- Receive fax and voice calls at the same phone number – with an answering machine.

After selecting the best installation to meet the user needs, the correct reception mode and certain station specific information will need to be set up. The procedures to accomplish this are in the following topics which are presented in the HP OfficeJet LX User's Guide:

- Setting the Reception Mode for incoming calls.
- Setting the number of rings to answer.
- Selecting Tone or Pulse dialing
- Entering the Date and Time
- Entering the header information (company name and fax number).

Using an HP OfficeJet LX with the HP OfficeJet LX Manager and Eclipse FAX SE to control faxing is briefly described earlier in this section. Detailed information is provided in the HP OfficeJet LX User's Guide. Reception mode in an HP OfficeJet LX is set during installation of the software, but can be changed using the HP OfficeJet LX Manager software by selecting the Receive Mode in the Receive Fax Setup dialog box as described in the HP OfficeJet LX User's Guide.

Receive fax calls only – no voice calls, on a dedicated fax line

This installation is recommended when using a separate telephone line and number dedicated to receiving faxes only (no voice calls). Installation consists of connecting the HP OfficeJet to the telephone wall jack using the telephone cord provided, and setting the Receive Mode to Auto. Refer to the HP OfficeJet LX User's Guide.

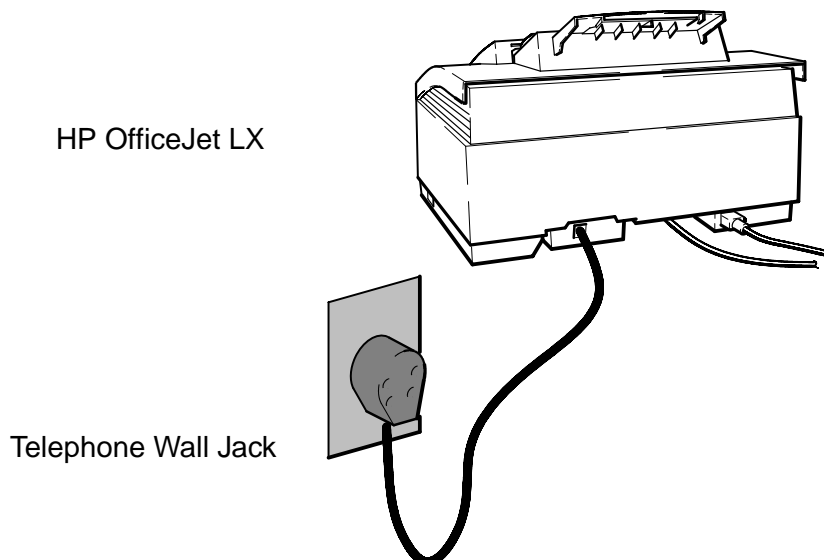

Receive fax and voice calls at the same phone number – without an answering machine

This installation is recommended when using one telephone number for both fax and voice calls and not using a telephone answering machine. Installation consists of connecting the HP OfficeJet LX to the telephone wall jack, connecting the telephone directly to the HP OfficeJet LX wall jack connector as shown, and setting the Receive Mode to Manual. Refer to the HP OfficeJet LX User's Guide.

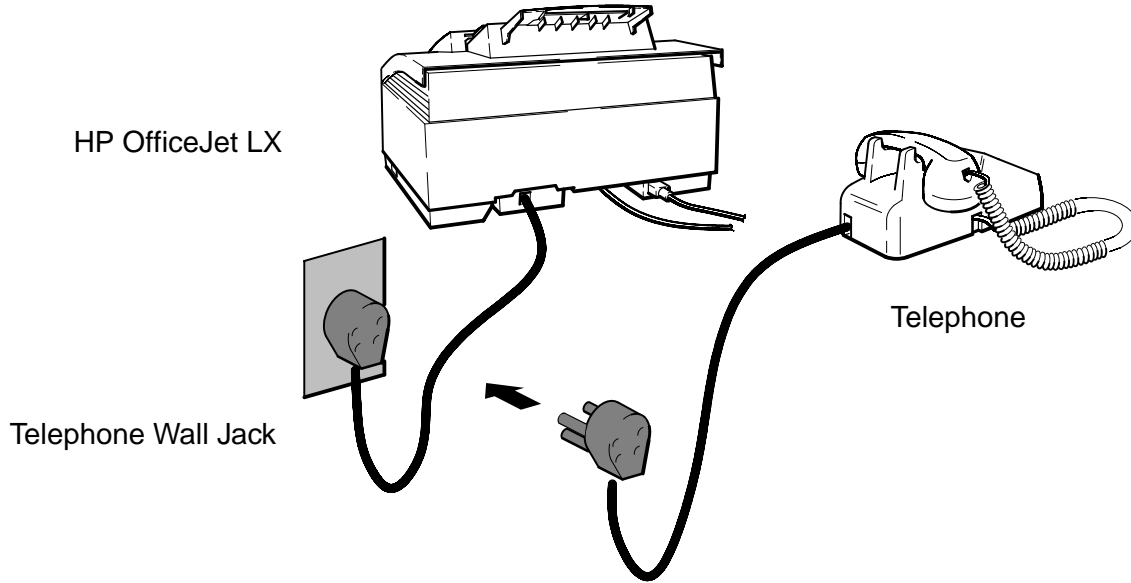

Receive fax and voice calls at the same phone number – with an answering machine

This installation is recommended when using one telephone number for both fax and voice calls and using a telephone answering machine. Installation consists of connecting the HP OfficeJet LX to the telephone wall jack, connecting the telephone answering machine directly to the HP OfficeJet LX wall jack connector as shown, and setting the Receive Mode to Fax/TAM. Refer to the HP OfficeJet LX User's Guide. Two scenarios are possible when using an answering machine – one where the telephone handset is an attached part of the answering machine and one where the telephone is a separate item that must be connected following the answering machine. Both scenarios are depicted in the following diagram.

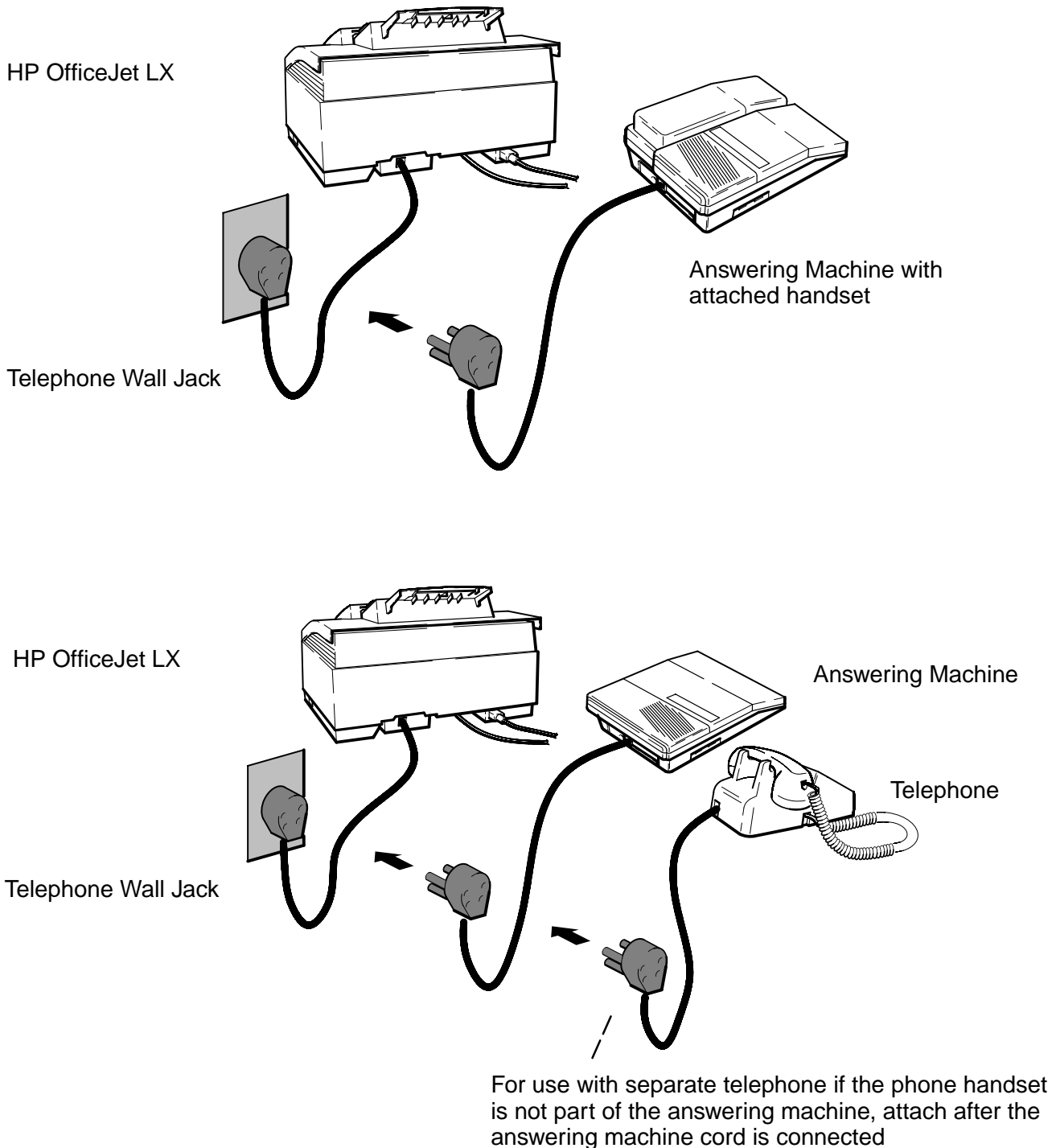

Routine Maintenance

Subject	Page
Introduction	3-2
Changing a Print Cartridge	3-2
Exterior Cleaning	3-3

Introduction

Use the guidelines in this chapter to keep the HP OfficeJet in the best operating condition.

Changing a Print Cartridge

When installing or replacing a print cartridge, following these recommendations will optimize the performance and extend the lifetime of the ink cartridge.

- Keep print cartridges in the print cradle in the machine to reduce exposure to air
- Keep new unused cartridges in their sealed packaging until ready to use
- Do not turn the machine OFF before printing is complete

1 Open the control panel, then the top cover.

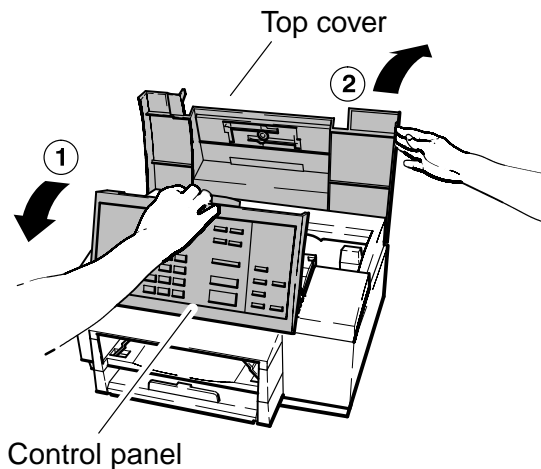

2 Pull the print cartridge toward you until it releases and snaps forward.

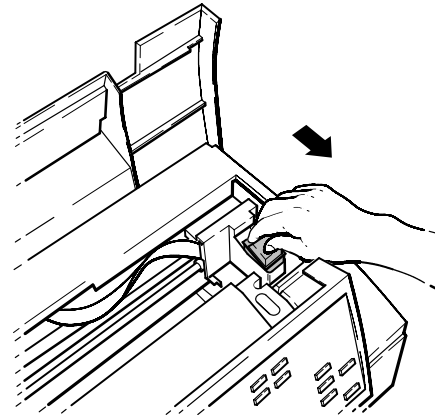

3 Lift the print cartridge out of its cradle.

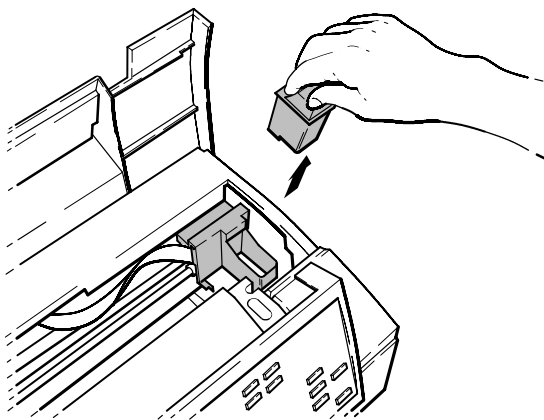

4 Open the new print cartridge box and container, then grasp the print cartridge by the green top and remove the cartridge from the container. Gently remove *both pieces of tape – blue and white – covering the ink nozzles and vent hole.*

CAUTIONS: 1) If you don't remove the white tape, the ink in the cartridge will be depleted prematurely.
2) Do not touch the ink nozzles or the copper contacts. Fingerprints may damage them.

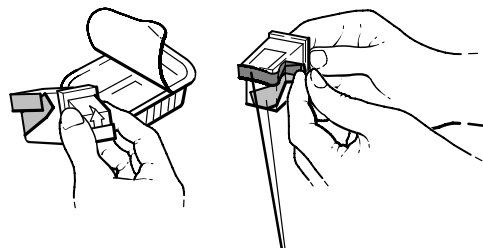

Remove both pieces of tape!

- 5** Place the print cartridge down into the cradle as shown. Align the green arrow on the cartridge top with the green dot on top of the cradle.

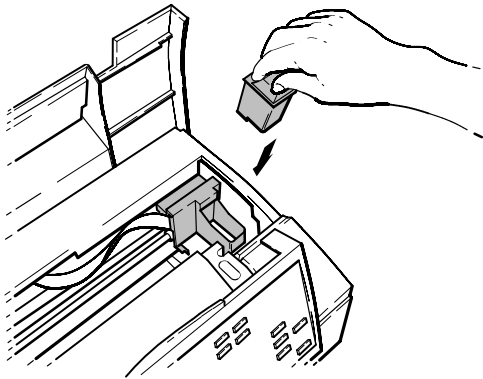

- 6** Push the green arrow toward the green dot until the cartridge **snaps** into place.

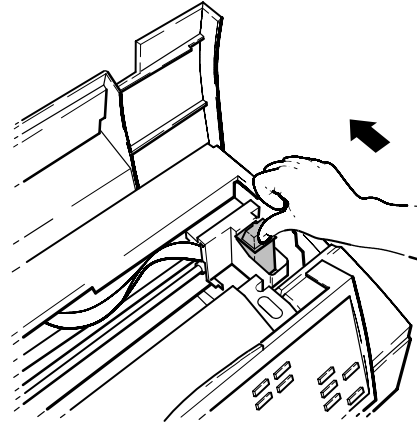

- 7** Close the top cover, then close the control panel.

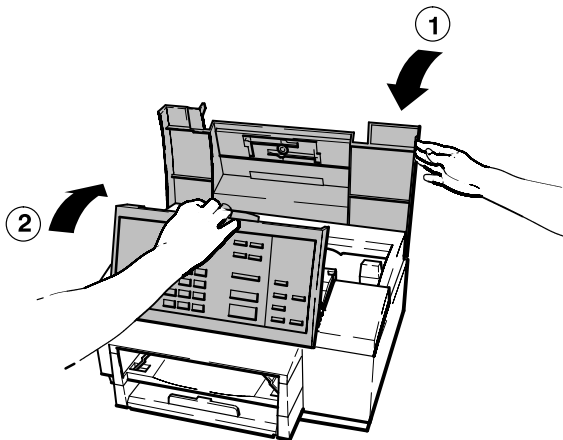

Helpful Hint:

Be sure to close the control panel firmly, until both corners snaps into place.

Exterior Cleaning

Follow these recommendations when cleaning the exterior surfaces of the HP OfficeJet:

- Use a soft cloth moistened with water to wipe dust off the exterior
- Do not clean the interior of the machine
- Keep liquids out of the interior of the unit

Notes:

Calibration and Adjustment

Subject	Page
Introduction	4-2
Print Calib Chart	4-2

Introduction

The only procedure available outside of the factory environment is the calibration chart, which can be printed out and used to determine if the top margin must be adjusted. This procedure is used to adjust the top margin when performing a copy function. It is performed at the factory before shipment and should never need readjusting.

Print Calib Chart

WARNING: This procedure should only be accomplished under the direction of a trained HP support agent. Do NOT perform this procedure unless directed to do so by the agent.

The distance between the page detect sensor and the location of the scanner will vary between machines due to parts tolerances. This variation affects the top scanning margin. The scanner position calibration will adjust the top margin. A Calibration Chart is used for this procedure and contains the following features:

- A check to see if the calibration is successful or needed
- Instructions on how to perform the calibration
- Calibration scale used to select the correct parameter value

To check if a calibration is needed, first print the Calibration Chart. Then cut the top of the chart along the dotted line. Set the HP OfficeJet copy reduction setting to 100%. Make one copy of the chart by feeding the top end first into the document feeder. If the hour-glass printed on the chart is either completely visible or not visible at all, a calibration is needed. Ideally, exactly one-half of the hour-glass will be visible. Detailed instructions are provided in the following paragraphs. A sample chart is provided following this procedure.

To print a calibration chart, you must enter the Service and Factory Menu. There are two methods that can be used to access the Service and Factory Menu:

1. Press the “*” and “7” buttons simultaneously while powering on the HP OfficeJet.
2. From the “**Enter Header Number**” display, first use the “Backspace” button to erase the currently displayed header number (if present), then press the “Redial/Pause”, “*”, “Redial/Pause”, “2”, “3”, “2” and “Enter/Save” buttons in sequence. Press the menu button and scroll to the Service and Factory Menu.

Once the Service and Factory Menu has been accessed, it will remain part of the main menu structure until the HP OfficeJet is powered OFF. Cycling the power OFF and then ON will remove the Service and Factory Menu from the display and return to the regular user menu.

The same method used to navigate and select user menu functions is also used for the Service and Factory Menu. A full description of the Service and Factory Menu is provided in chapter 5 of this manual.

After accessing the Service and Factory Menu, scroll to the Print Calib Chart submenu and start printing the chart.

The chart contains a complete description of the following procedure:

1. Remove the top portion of the chart by cutting along the dotted line.
2. Enter the Change Stored Parameter submenu and select parameter 200.
3. Write down the existing value at parameter 200, then enter a new value of 1500.
4. Press the front panel Resolution button until FINE is displayed on the front panel display.
5. Using the front panel menu, set the Copy Reduction to 100%.
6. Load the chart (with the top portion removed at the dotted line) into the automatic document feed tray and make one copy. Make sure the chart is loaded top end first with the print side facing down.
7. Look at the copy and find the top most visible tick mark of the Calibration Value Scale where the scale is cut off.
8. Determine the Calibration Value corresponding to this tick mark by reading the “How to Read Scale” portion of the sample chart following this procedure. The normal range is 550 to 650 on the scale.
9. Reenter the Service and Factory Menu.
10. Scroll to the Change Stored Parameter submenu and access parameter 200.
11. Enter the Calibration Value determined from the “How to Read Scale” into parameter location 200.
12. The calibration test is complete. Check that the calibration is correct by making another copy of the chart previously used (with the top portion removed). Ideally, one-half of the hour-glass will be visible.

A sample calibration chart is provided on the next page. Refer to it facilitate performing the procedure and to obtain the calibration value.

SCAN POSITION CALIBRATION CHART

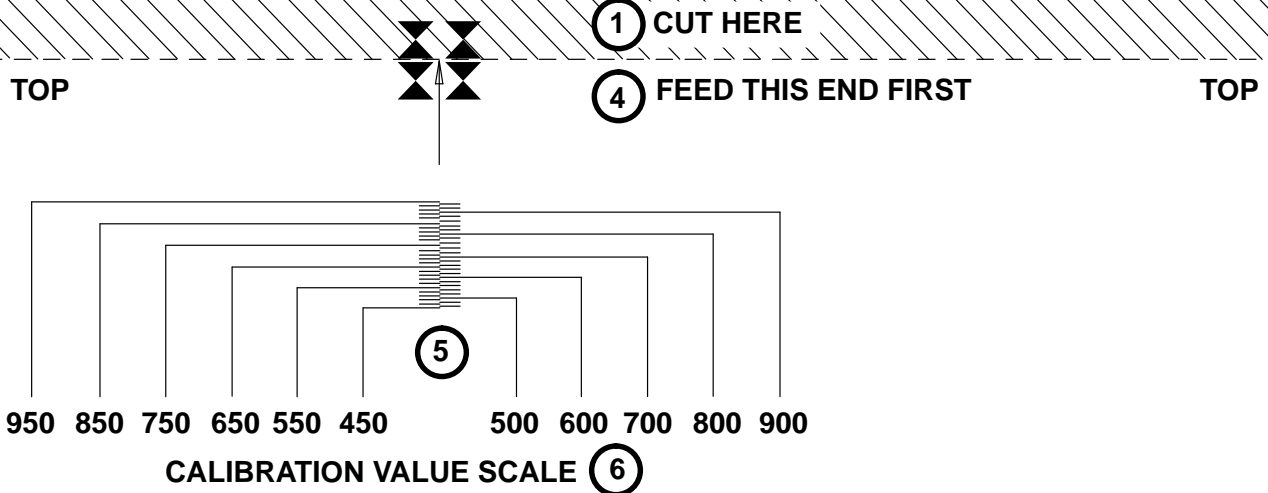

SET-UP

- 1 Cut the top of this chart along the dashed line.
- 2 Enter the "Change Parameter" menu and select parameter 200.
 - a) note existing value: _____
 - b) enter new value: **1500**

MEASUREMENT

- 3 Exit the Service Menu and
 - a) set Copy Reduction to: 100%
 - b) set Resolution to: FINE
- 4 Load this sheet (after the top portion is removed) into the FAX document feed tray (print side down, top end first). Make one copy.

How to Read the Scale

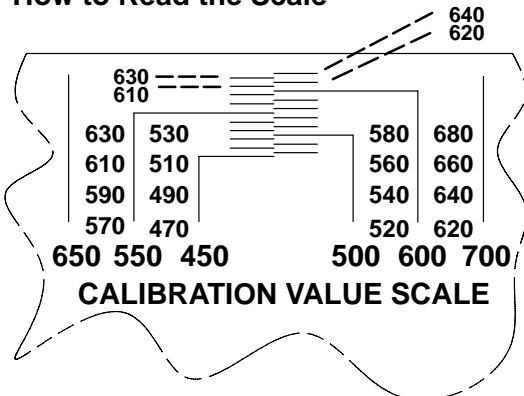

Moving from the left side to the right side, the scale increments by 10 for each scale tick mark (20 between tick marks on the same side). The highest readable value in this example is 640.

CALIBRATION

- 5 Look at the copy and find the top most tick mark of the Calibration Value Scale which is visible.
- 6 Determine the Calibration Value corresponding to this tick mark. See "How to Read the Scale".
- 7 Enter this value at parameter 200 location using the "Change Parameter" menu. Calibration is complete.

Problem Resolution

Subject	Page
Introduction	5-2
Multi-Function Task Chart	5-2
Problem Solving Process	5-2
Typical Questions and Answers	5-3
Error Notification: Beeps, Blinking Lights and Messages	5-6
Display Messages: What they mean and what to do	5-7
Solving Problems While Printing, Faxing or Copying	5-16
Diagnostic Codes: What they are, how to read them and what to do	5-22
Fax Session Protocol: Diagnostic Code appearances in a communication	5-22
Diagnostic Code Descriptions	5-25
Communication Error Codes (level 400 and 500)	5-27
Power-On Initialization Tests	5-34
Special Menus and Functions	5-35
Service and Factory Menu	5-36
Service and Factory Menu Structure	5-36
System Error Codes	5-41
User-Menu Associated Parameter Structure	5-42
Officejet Parameter Descriptions	5-43
LIU Identification	5-43
Ring Detection and Auto Answering	5-44
Eavesdrop Detection and Automatic Answering	5-47
Connection Establishment	5-50
Pause Control	5-53
Dial Tone Detection	5-54
Dialing	5-60
Call Progress	5-62
Modem Configuration	5-65
Fax Session Configuration	5-67
Redialing	5-68
Miscellaneous	5-70

Introduction

This chapter contains information which can be used to resolve problems encountered while using the HP OfficeJet. Problems that require removing the top cover in order to troubleshoot or repair the machine must be referred to qualified service personnel. Follow the instructions in this chapter to make certain the problem is in the machine and not the result of an interface connection problem or a malfunction in the computer or software.

Multi-Function Task Chart

Use the Simultaneous Task Capability chart in Chapter 1 of this guide as a reference for which tasks can be performed simultaneously. Attempting to perform concurrent tasks not supported may result in a display message or error condition.

Problem Solving Process

1. Review the Troubleshooting chapter in the HP OfficeJet (LX) User's Guide. Most problems are fairly simple to resolve. The recommended way to solve them is to identify the problem and take the corrective steps provided.
2. **A list of user available support resources is provided in Chapter 6. Use the resources list before calling the Customer Support Center.** The resources available can expedite problem resolution and get many users back in operation without a service call. Some of the resources offer instant fax return of the support information requested.
3. Gather some basic information before calling for help. To facilitate prompt service, be sure to have the following information readily available before contacting the HP Customer Support Center (CSC):
 - Product name and serial number
 - Description of the problem
 - Purchase date and proof of purchase
 - A valid credit card or purchase order number (required for HP's Express Exchange option)

Call HP CSC: (208) 323-2551 Monday, Tuesday, Thursday, and Friday from 7:00 am to 6:00 pm (MST); Wednesday from 7:00 am to 4:00 pm (MST).

An HP CSC agent will guide you through the following process to quickly determine and solve any problems you may have:

- **Setup and Operation Problems:** First, the HP CSC agent will help solve any problems or answer any questions relating to setup or operation.
- **Remote Diagnostics:** If setup or operation is not the problem, the HP CSC agent can attempt to identify the problem using the remote diagnostics feature of your HP OfficeJet. This powerful capability provides access to all user setup and machine operating parameters, and allows some problems to be detected and corrected over the telephone line.
- **Arranging Repair:** If the problem can not be resolved over the phone, the HP CSC agent will arrange to replace or repair the unit using the HP Express Exchange or Standard Return program through the Corvallis Service Center.

Typical Questions and Answers

The following series of questions are those typically asked by customers who need to know something about a particular function or capability and which operations can be performed simultaneously.

Q: How fast does the HP OfficeJet print?

A: The HP OfficeJet can print up to 3 pages a minute. Draft and Letter print quality can be set using the front panel. Also, various quality levels can be set through the printer drivers supplied with the unit. Draft quality print speed is 3 pages per minute and Letter quality print speed is 2 pages per minute.

Q: How fast does the HP OfficeJet send faxes?

A: The HP OfficeJet can send fax transmissions at up to 10 seconds per page. This speed is based on the standard resolution with Error Correction Mode of the CCITT test chart #1. The speed of fax transmission through the wires is dependent on the phone line, the receiving fax machine, the print density on the page(s) and the resolution setting.

Q: What is the page capacity of the fax document feed tray?

A: Using 20 lb. paper, the fax document feed tray will handle up to 20 pages. This tray assembly is commonly known as the automatic document feed (ADF) assembly. Heavier weight paper restricts the number of sheets that the ADF can handle and feed. If more than 20 sheets need to be sent, the additional sheets can be put on the ADF as the others are processed through.

Q: What is the sheet capacity of the paper supply tray?

A: The front loading paper supply tray holds up to 100 sheets of plain paper. Letter, legal and A4 sizes can be used.

Q: Can I print a file from the PC and send a fax at the same time?

A: Yes. Load the fax document into the ADF and send. The PC print job will continue.

Q: Can I print a file from the PC and make copies at the same time?

A: No. The printer is busy with the print job and can't simultaneously process copies through the print mechanism.

Q: What happens when the machine runs out of ink while printing an incoming fax?

A: The HP Officejet detects when the ink cartridge is empty. The incoming fax will be stored in memory until the cartridge is replaced and then printed out. Based upon CCITT test chart #1, up to 24 pages can be stored in memory.

Q: What happens if I'm printing and someone tries to send me a fax?

A: The HP OfficeJet comes with 400kB of memory for fax/copy. When a fax is received during a print job, the fax is stored in memory and printed after the print job is completed. Up to 24 pages can be stored in the memory. If a fax exceeding the memory space is received, the fax will take precedence over the print job.

Q: What happens if the memory is filled with incoming faxes and someone tries to send me a fax?

A: Once the memory is filled, the HP OfficeJet will no longer answer and the sending party will get a busy or no answer signal. The fax will not be sent and thus not lost. A front panel display will notify the user that fax reception is disabled. As the faxes stored in memory are printed out, freeing up memory space, the HP OfficeJet will automatically begin to answer fax calls again.

Q: Does the HP OfficeJet offer remote diagnostics?

A: Yes. This feature allows the HP OfficeJet support line to identify some problems over the phone lines and access user setup settings and machine parameters.

Q: I have only one shared line for fax and voice calls. If I pick up an extension phone and realize that the call is a fax call and not a voice call, can I still receive the fax?

A: The HP OfficeJet can share a phone line with voice calls in the Fax/TAM receive mode. TAM is an acronym for telephone answering machine. When the HP OfficeJet is set in the Fax/TAM receive mode, and an answering machine is used, the HP OfficeJet monitors the calls and responds to incoming fax tones on the line. So, if the phone is picked up and you realize the call is a fax call, wait until you hear the fax tone, then hang up and the fax will be received.

Q: Which printer drivers can I use and which are supplied with the HP OfficeJet?

A: The HP OfficeJet is designed for the PC environment. Microsoft® Windows and top-tier DOS software drivers are supplied. The HP Officejet is supported on a wide range of DOS applications using the HP DeskJet 500 series printer drivers. Six internal fonts for DOS applications reside in the HP Officejet. No font cartridge capability is provided.

Q: Are separate ink cartridges needed for the printer and fax?

A: No. One print cartridge is used to print, fax and copy.

Q: What is broadcasting and does the HP OfficeJet offer it?

A: Broadcasting is the ability to send a fax document to more than one station at the same time. This feature is also referred to as group dialing. The HP OfficeJet offers group dialing and can be set to speed dial groups of numbers previously stored in memory. You can also send to several fax numbers (up to 10) by pressing the Enter/Save button instead of the Start/Copy button after entering a phone number. The display will prompt you for additional numbers.

Q: What is polling and does the HP OfficeJet offer it?

A: Polling is the ability to allow fax machines to communicate requests for faxes from each other. The calling machine requests, via fax tones, that a document stored in the other machine's ADF or memory be transmitted to it. Both machines must be set up to use this feature or no polling can occur. The HP OfficeJet can be set up to poll or be polled. Polling is restricted to one station at a time, no group polling is offered.

Q: Does the HP OfficeJet offer delayed sending of faxes to take advantage of lower phone rates or different time zones?

A: Yes. The HP OfficeJet can be set to send a fax up to 24 hours later. The fax can be either stored in memory or placed on the ADF until the requested sending time.

Q: How much memory is included for printing and faxing?

A: A total of 1 MB of memory resides in the HP Officejet. Approximately 400 kB of memory is used for the fax/copy features, providing for about 24 pages of fax data storage. Approximately 584 kB of memory is needed for system operation while about 16 kB is used for PC print job storage. If using memory storage functions such as broadcasting and delayed sending, 32kB of memory is reserved for incoming faxes.

Q: Can I send a fax from memory to another fax machine's memory?

A: Yes, providing the other fax machine has the capability and capacity to store the incoming message in memory.

Q: Can I receive a fax into memory from another fax machine's memory?

A: Yes, providing the HP OfficeJet is set for backup reception (factory default) and sufficient memory is available. Based upon CCITT test chart #1, up to 24 pages can be stored in memory.

Q: Does Eclipse FAX SE have to be running to receive PC faxes?

A: No, but the HP OfficeJet LX Manager does. You need to run the PC fax software package to view the fax.

Q: What is the print resolution offered in the fax, printing and copy modes?

A; Refer to the following table.

Mode	Resolution
Printing from PC with Windows 3.1 driver	600 dpi x 300 dpi with REt
Printing from PC with DOS (text)	600 dpi x 300 dpi
Printing from PC with DOS (graphics)	300 dpi x 300 dpi
Fax printing	200 dpi receive scaled to 300 dpi
Fax sending (Standard)	100 dpi x 200 dpi (approximate)
Fax sending (Fine)	200 dpi x 200 dpi (approximate)
Fax sending (Photo)	200 dpi x 200 dpi (approximate) with 32 levels of greyscale
Copy	200 dpi x 200 dpi (approximate) with Fine resolution as default, can also use Photo mode

dpi = dots per inch; dots per 25,4 cm. REt = resolution enhancement technology

Q: What level of greyscale is provided for photo images?

A: The HP OfficeJet provides 256 levels of greyscale for printed documents through the printer drivers on Windows and other applications for printing photographic images from the PC. 32 levels of grayscale are provided for faxing and copying photographic images.

Q: Is the print quality similar for printing and faxing?

A: Print quality of documents sent from the PC applications with the Windows driver are the highest quality at 600 dpi x 300 dpi with resolution enhancement to smooth the edges. In fax mode, the print quality is dependent on the scanning resolution of the sending fax machine as well as the HP OfficeJet. The sending fax machine most likely sends the fax at 100 dpi x 200 dpi or 200 dpi x 200 dpi. The HP OfficeJet receives faxes and then scales them to 300 dpi for printing. In copy mode, the internal 200 dpi scanner scans the document and the data is scaled to 300 dpi for printing.

Q: What fonts are supported?

A: There are six internal fonts in the HP OfficeJet to support DOS applications. When using the Windows driver, all of the TrueType fonts are supported. An additional 14 TrueType fonts are shipped with the Windows 3.1 driver. Although the HP OfficeJet is fully compatible with the HP DeskJet 520, it does not support font cartridges nor downloadable soft fonts.

Q: What happens when a fax document larger than Letter size is received by the HP OfficeJet?

A: With automatic reduction set to ON, the HP OfficeJet automatically reduces the image to fit the paper size loaded in the supply tray. The fax and copy functions support Letter, Legal and A4 paper sizes. Also, the paper size should match the size set in the front panel menu.

Q: How long does it take to copy a document?

A: Copy speed is approximately 50 seconds per page for a typically dense letter-sized page of text. Dense text and graphics will take longer. Copying in Photo mode resolution also takes longer.

Q: Can the copier reduce the copies made?

A: Yes. The copy feature includes the ability to reduce images from 100% down to 70% in 5% increments.

Error Notification: Beeps, Blinking Lights and Messages

Certain error conditions can be incurred when a wrong button is pressed, a process is cancelled or an internal machine problem is detected. The HP OfficeJet will notify the user when one of these conditions occurs. The error notification can be in the form of beeps, blinking lights or messages in the display. Refer to the following table for conditions and typical methods of notification.

Type of notification:

Three short beeps.

Nine short beeps. **See Display** light blinks on and off. An error message is displayed that describes the problem and tells you how to solve it, if applicable.

Nine short beeps. **See Display** light blinks on and off. A "SYSTEM ERROR" message is displayed along with a three-digit code. (Refer to the "Displayed Messages" section later in this chapter.) Record this code before calling for service.

Error condition:

An unavailable function was requested.

A button for a function that wasn't available at that time was pressed.

(Example: You can't use the **Menu** button while sending a fax.)

An error interrupted an activity in progress.

An error occurred which has interrupted or cancelled the current activity.

(Example: lifting the top of the control panel while sending a fax causes the fax to be cancelled.)

You may need to take some action to clear the error before continuing to use the HP OfficeJet. Look up the displayed message in the next section of this chapter for more information.

An internal problem was detected.

A problem with the internal mechanical or electronic components has been detected.

Service is required.

Display Messages: What they mean and what to do

Different error or operating conditions will cause the HP OfficeJet to notify the user when such conditions occur. The messages will appear in the display. Refer to the following table for conditions, typical messages and recommended corrective action.

The control panel display messages in the following table are presented in alphabetical order for easy reference.

Display Messages

This message:	Has this meaning:	And requires this action:
<i>nn pages sent Poor Quality</i>	The fax you just sent may contain poor print quality resulting from problems with the phone line.	Contact the receiver and verify quality or resend the fax.
<i>Add paper then press START</i>	You are printing and the paper tray is empty.	Load paper for your print job, then press the Start/Copy button. If paper is already loaded in the paper tray when you get this message, remove it. (Also check for any partially-loaded sheets and remove them, too.) Discard any damaged or curled sheets from the stack, then reload the stack and press Start/Copy .
<i>Cancel pending fax? 1=Yes 2=No</i>	You pressed Stop while the HP OfficeJet was waiting to redial and send a memory-stored fax.	Press 1 to cancel the memory-stored fax. Press 2 to continue redialing the memory-stored fax.
<i>Clear print jam then press START</i>	A piece of paper has jammed inside the printer mechanism.	Remove the output tray and pull out all wrinkled or torn pieces of paper from the paper path. Also remove wrinkled or torn pieces of paper from the paper tray. When finished, replace the output tray and press the Start/Copy button.

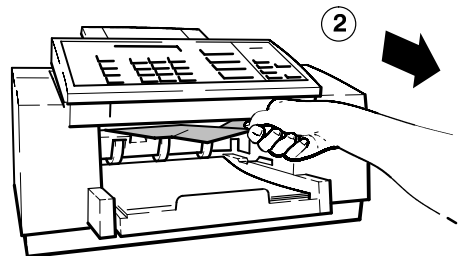
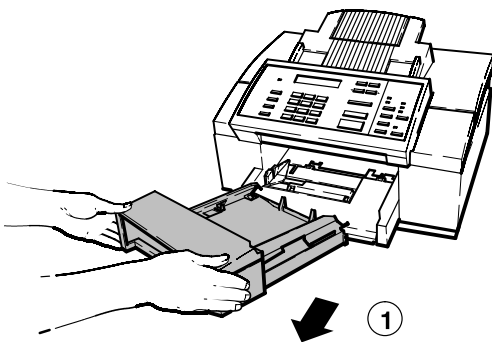

(Continued on next page)

Display Messages (Continued)

This message:	Has this meaning:	And requires this action:
Close cover	The control panel is open, the top cover is open, or both the control panel and the top cover are open.	First close the top cover, then press down on the control panel until it snaps into place. When both are closed properly, the "Close cover" message will go away.
<p>The diagram shows a top-down view of a fax machine. A hand is shown pressing down on the control panel, which is labeled with a circled '2' and an arrow. Another hand is shown closing the top cover, which is labeled with a circled '1' and an arrow. The control panel is a rectangular unit with various buttons and a small display. The top cover is a large, flat rectangular lid that covers the top of the machine.</p>		
Copy cancelled	You pressed the Stop button while copying was in progress.	No action is required.
Delayed fax pending	You have already scheduled a delayed fax. Only one delayed fax can be scheduled at a time.	Wait until after the delayed fax has been sent, then set up the next one. If you want to cancel the first delayed fax instead, select Send Fax Later , then select Cancel Send .
Delete this fax? 1=Yes 2=No	You pressed the Stop button while a fax was being received or printed.	Press 1 to stop receiving and delete the fax, or press 2 to continue receiving and printing the fax.
Fax cancelled (fax number)	<p>The bottom line displays the fax number you were sending to or receiving from when the fax was cancelled. The fax could have been cancelled because of one of the following:</p> <ol style="list-style-type: none"> 1) You pressed the Stop button. 2) You lifted the control panel. 3) You removed the document while it was being scanned. 4) The document jammed while it was being scanned. 	<p>If you intentionally cancelled the fax, no action is required. If not, you should resend the entire document. Note: It's possible that part of your document was successfully transmitted, but if you are not able to check with the person you were sending to, we recommend resending the entire document.</p>

(Continued on next page)

Display Messages (Continued)

This message:	Has this meaning:	And requires this action:
<i>Fax failed from (fax number)</i>	A communication error between your HP OfficeJet and the sending fax machine resulted in a failed transmission. The fax number of the sending fax machine is displayed on the bottom line.	Check for dial tone. You may want to contact the person who tried to send the document and ask them to resend it. Failed transmissions are most often caused by noise on the telephone line.
<i>Fax failed from (unknown)</i>	A communication error between your HP OfficeJet and the sending fax machine resulted in a failed transmission. The fax number of the sending fax machine is unknown.	Check for dial tone. You may want to contact the person who tried to send the document and ask them to resend it. Failed transmissions are most often caused by noise on the telephone line.
<i>Fax in memory</i>	One or more incoming faxes were stored in memory while the HP OfficeJet was either out of paper, out of ink, or the wrong size paper for fax reception was loaded. This message is displayed alternately with the error message telling you what needs to be corrected.	Read the message that alternates with this one (e.g., "Out of paper for fax/copy"). Correct the indicated problem.
<i>Fax in memory Memory full</i>	One or more incoming faxes were stored in memory and filled the memory to capacity while the HP OfficeJet was either out of paper, out of ink, or the wrong size paper for fax reception was loaded. This message is displayed alternately with the error message telling you what needs to be corrected.	Read the message that alternates with this one (e.g., "Out of ink, Replace pen"). Correct the indicated problem. The HP OfficeJet cannot receive any more faxes until you correct the problem and the memory-stored faxes are printed.
<i>Fax in memory press START</i>	A fax was stored in memory while the HP OfficeJet was not ready to print (out of paper, out of ink, wrong size paper loaded, or printer busy), but the problem has now been corrected.	Press the Start/Copy button to print the fax stored in memory.
<i>Fax poll failed</i>	The HP OfficeJet tried to poll another fax machine. The poll failed because either there was no answer, the line was busy, or the other fax machine was not ready to be polled.	Check with the sender to make sure their machine is ready to be polled and to verify the fax number. Then set up to poll again.
<i>Fax printing disabled</i>	The HP OfficeJet is out of ink. Incoming faxes will be received to memory until the print cartridge is replaced.	Replace the print cartridge.

(Continued on next page)

Display Messages (Continued)

This message:	Has this meaning:	And requires this action:
<i>Fax reception disabled</i>	The HP OfficeJet is unable to receive faxes due to one of the following error conditions: the print cartridge is out of ink or not installed, paper has jammed during printing, you're out of paper, the wrong size paper is loaded for fax reception, or the memory is full.	Read the message that alternates with this one, then correct the error it describes.
<i>Fax send failed No dial tone</i>	You tried to send a fax, but your telephone line is not operational.	Check your telephone line connections to the wall jack and to the HP OfficeJet. Try again.
<i>Fax send failed No document</i>	This message is displayed when there's an error with a fax you scheduled using the Send Fax Later feature. It indicates that there was no document in the fax loading tray at the time you scheduled a fax to be sent.	Send your fax as desired: either reschedule the fax using the Send Fax Later feature, or send the fax manually.
<i>Fax send failed Try again</i>	You tried to send a fax, but some kind of communication error occurred before the fax data could be transmitted.	Try sending your fax again. The fax machine you're sending to may not be ready to receive faxes. Try contacting someone at the receiving location.
<i>Fax to each number separately</i>	The HP OfficeJet tried to store a document in memory before sending it to a group of fax numbers. There was not enough memory to store the document.	You must send the fax to each fax number separately.
<i>Load document before Start Time</i>	You scheduled a fax using the Send Fax Later feature and chose to send it directly from the fax loading tray.	Load the document in the fax loading tray before the scheduled start time. In the mean time, you can send faxes as you normally would.
<i>Memory full Press START</i>	You are in the middle of making multiple copies of a document and the memory is full.	Press the Start/Copy button . The HP OfficeJet will make a single copy of your document.
<i>Memory full Press STOP</i>	The HP OfficeJet tried to store a document into memory before faxing it to multiple locations or at a future fax time. Either there is a received fax in memory waiting for an error condition to be corrected before it can be printed, or this document is too large to fit into the memory of the HP OfficeJet.	Press the Stop button. If there is an error condition to correct, it will be displayed. If no error message is displayed, you can assume that this document is too large to fit into memory and you will need to send it to one location at a time.

(Continued on next page)

Display Messages (Continued)

This message:	Has this meaning:	And requires this action:
<i>Open cover</i> <i>Clear copy jam</i>	The document you loaded for copying was either loaded improperly or jammed while being scanned.	If the document is <i>not</i> jammed, remove it and reload it. If the document is jammed, open the top of the control panel (pull the top ledge toward you) and remove the document. Close the control panel by pressing it down firmly until it snaps into place. Reload the document.
<i>Open cover</i> <i>Clear fax jam</i>	The document you loaded for faxing was either loaded improperly or jammed while being scanned.	If the document is <i>not</i> jammed, remove it and reload it. If the document is jammed, open the top of the control panel (pull the top ledge toward you) and remove the document. (See the illustration for the previous message.) Close the control panel by pressing it down firmly until it snaps into place. Reload the document.
<i>Open cover</i> <i>Load pen</i>	No print cartridge is loaded in the HP OfficeJet.	Load a print cartridge. Note: If you get this message after recently installing a print cartridge, try removing it and reloading it. Make sure you have removed both pieces of tape from the print cartridge.

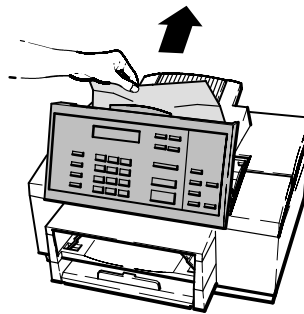

(Continued on next page)

Display Messages (Continued)

This message:	Has this meaning:	And requires this action:
<i>Out of ink</i> <i>Replace pen</i>	<p>The print cartridge in the HP OfficeJet is out of ink.</p> <p>If you have the Backup Reception feature turned on in the menu (On is the factory setting) your incoming faxes will be stored in memory until you replace the print cartridge. You can continue to print from your PC for awhile, but your print quality may be reduced and you will get blank pages eventually.</p>	<p>Replace the print cartridge as soon as possible.</p> <p>If the memory fills to capacity before you replace the print cartridge, the HP OfficeJet won't be able to receive faxes and the "Fax reception disabled" message will be displayed alternately with this message.</p> <p>Note: If you get this message after recently installing a print cartridge, try removing it and reloading it. Make sure that you have removed both pieces of tape from the print cartridge.</p>
<i>Out of paper for fax/copy</i>	<p>The HP OfficeJet has attempted to print a received fax or make a copy and one of these conditions exists:</p> <ol style="list-style-type: none"> 1) The paper tray is empty. 2) The wrong paper size is loaded for receiving faxes, making copies, and printing reports from the menu. 3) The paper loaded in the paper tray is buckled (not flat), so the HP OfficeJet can't pick it correctly. 	<p>If paper or envelopes are loaded, remove them. Then load either Letter-, A4-, or Legal-size paper into the paper tray. Make sure the paper lays flat in the paper tray.</p>
<i>Paper load failed</i> <i>Press START</i>	<p>The HP OfficeJet has failed to pick a piece of paper from the paper tray.</p>	<p>Press the Start/Copy button. If paper is picked correctly, the message will not be displayed again, and you can continue to use the HP OfficeJet normally.</p> <p>If the message reappears, try removing the stack of paper from the paper tray, straightening it, and reloading.</p>
<i>Poll cancelled</i>	<p>You pressed Stop after setting up a document to be polled. Your to-be-polled setup has been cancelled.</p>	<p>No action is required.</p>
<i>Press START to send Group full</i>	<p>You have entered the limit, 10 fax numbers, while sending to a group of fax numbers (broadcasting).</p>	<p>Press the Start/Copy to begin sending the fax to your group.</p>
<i>Printer busy</i>	<p>The printer is in the middle of printing a file from your PC, so it is temporarily unavailable for other types of printing.</p>	<p>Wait for the print job to finish before starting another operation that requires printing (such as copying or printing reports).</p>

(Continued on next page)

Display Messages (Continued)

This message:	Has this meaning:	And requires this action:
Printing. . . (Date and Time)	The HP OfficeJet is printing a file from your PC.	No action is required. You may send a fax while printing, if desired. Received faxes will be stored in memory, then printed when your print job is complete.
Printing. . . Waiting for data	The printer has paused to wait for further print data.	Usually, no action is required. However, if you are waiting for the <i>last page</i> of your print job at the time you see this message, press Load/Eject to eject the last page.
Ready Out of fax paper	Either there is no paper loaded in the paper tray, or the wrong size paper is loaded for printing received faxes, making copies, or printing reports from the menu.	If you want to be able to print received faxes, make copies, or print reports from the menu: Load Letter-, A4-, or Legal-size paper into the paper tray.
Redial pending Try again later	You tried to send a fax from the fax loading tray while a memory-stored fax was waiting to redial (sending to a group or sending a delayed fax).	Wait until the memory-stored fax has been sent before sending a fax from the fax loading tray.
Remove document and reload	The HP OfficeJet was unable to load the document you placed into the fax loading tray.	Remove the document from the fax loading tray, straighten the stack, and reload it.
Removing document	A document is being ejected from the fax loading tray after you cancelled a fax or a copy, or after the power was lost during scanning.	No action is required. If you don't want to wait while each page is ejected, open the control panel and remove the document yourself. Then close the control panel.
Report cancelled	You pressed the Stop button while a report was being printed.	No action is required.
Report in memory press START	The HP OfficeJet stored an automatic report in memory while the paper tray was empty.	Press Start/Copy to begin printing the report.
Self test (Please wait)	Each time the power is turned on, the HP OfficeJet tests itself to make sure it's in good working order. If it finds a problem, an error message will be displayed.	Wait for a few seconds for this message to clear before using the HP OfficeJet. If a "SYSTEM ERROR" message is displayed that advises you to call for service, record the 3-digit error number before calling.

(Continued on next page)

Display Messages (Continued)

This message:	Has this meaning:	And requires this action:
Store fax now? 1=Yes 2=No	While scheduling a fax, you are prompted to decide whether to 1) store the document in memory for sending later, or 2) place the document in the fax loading tray until the designated start time.	If you want to store the fax in memory until the start time, press 1 . If you don't want to use up the memory, or if you don't think your document will fit into memory, press 2 and place your document in the fax loading tray before the start time.
Stored data lost Call for service	Settings that were stored are lost. All settings are returned to the factory defaults.	You can continue to use the HP OfficeJet (LX) but the battery may be discharged. You should call for service at your convenience. Refer to Chapter 6 of this guide.
Stored data lost Check Settings	Settings that were stored are lost. All settings are returned to the factory defaults.	You can continue to use the HP OfficeJet (LX) but the battery may be discharged. You should call for service at your convenience. Refer to Chapter 6 of this guide.
Storing . . . Memory used: xx%	You are storing a document in memory to be faxed later, or to be sent to a group of fax numbers. The bottom line shows you how much of the memory is being used to store the document. There's a total of about 24 pages (400 KB) of memory available for faxing and copying.	Wait until the storing is complete to make sure your document will fit into the available memory. If your document won't fit in memory, a message will tell you what to do next.
SYSTEM ERROR nnn Call for service	An error has occurred that requires servicing.	Please record the error number, then do one of the following: If the error number begins with "1": Turn off the power, then turn it on again. If the error message is gone, you may be able to continue using the HP OfficeJet. But if the error message remains, contact HP's Customer Support Center to service your HP OfficeJet.* It cannot be used until it is serviced. If the error number begins with "2": Contact HP's Customer Support Center to service your HP OfficeJet.* There's a problem with the scanning device, so you won't be able to send faxes or make copies reliably. However, you will be able to receive faxes, print files from your PC, and print reports until your HP OfficeJet is serviced. Press Stop to clear the error message.

(Continued on next page)

Display Messages (Continued)

This message:	Has this meaning:	And requires this action:
SYSTEM ERROR nnn Turn power off/on	An error has occurred that may require servicing. In some cases the error can be cleared by turning off the power, then turning it on again.	If the error number begins with "3": Contact HP's Customer Support Center to service your HP OfficeJet.* There's a problem with the internal part that controls fax transmissions, so you won't be able to send or receive faxes. However, you will be able to make copies, print files from your PC, and print reports until your HP OfficeJet is serviced. Press Stop to clear the error message. Turn the power off, then on again. If the message is no longer displayed, the problem has been solved and you can continue using your HP OfficeJet normally. If the message is still displayed after powering off and on, there's an internal problem that requires servicing. Record the 3-digit error number in the message, then contact HP's Customer Support Center to service your HP OfficeJet.
Turn power off Clear print jam	A print jam has occurred.	Turn off the power to the HP OfficeJet. Remove the output tray and pull out all wrinkled or torn pieces of paper from the paper path. Also remove wrinkled or torn pieces of paper from the paper tray. When finished, replace the output tray and turn on the power. If this message is displayed frequently, contact HP's Customer Support Center for help. CAUTION: Any faxes stored in memory will be deleted when you turn off the power.
Waiting for poll	You have set up a document to be polled from the fax loading tray.	No action is required. If you need to send a fax or make a copy, you can remove the document temporarily, then replace it when you are done.
Waiting to dial (fax number)	The HP OfficeJet has tried to dial the displayed fax number, but the phone line is already in use. It could be in use by a received fax, because the phone is ringing, or because your phone is off-hook.	No action is required. The HP OfficeJet will wait until the phone line is free, then dial the fax number.

Solving Problems While Printing, Faxing or Copying

Use the following table of symptoms, causes and solutions to help resolve problems that may be experienced while printing, faxing or copying.

Solving Printing/Faxing/Copying Problems

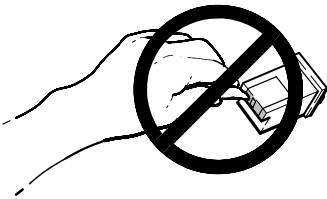
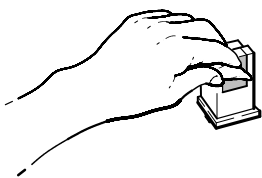
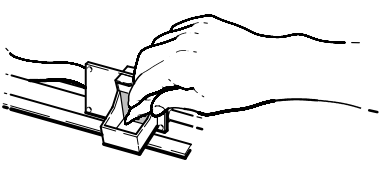
Symptom:	Cause:	Solution:
<p><i>Lines or dots are missing from the characters in the printout.</i></p>	<p>The connection between the print cartridge and cradle is intermittent.</p>	<p>Remove the print cartridge and reinstall it. Try printing again. You may need to repeat this before the ink resumes a continuous flow.</p>
	<p style="text-align: center;">OR</p> <p>The copper contacts of the print cartridge are dirty.</p>	<p style="text-align: center;">OR</p> <p>1. Remove the print cartridge. Use a lint-free damp cloth to gently clean the copper contacts on the print cartridge and the print cartridge cradle.</p>
		
		<p>2. Reinstall the print cartridge and try printing again. If the print quality remains poor after cleaning the contacts, clean the ink nozzles as described for the next symptom in this table.</p>
<p><i>The print cartridge has dried ink on the nozzles.</i></p>	<p>The ink nozzles of the print cartridge are clogged.</p>	<p>1. Press the Clean Pen button and wait about 15 seconds while the ink nozzles are cleaned automatically. Then print the Self Test report. Check the two print cartridge test patterns in the Self Test report. If the diagonal line has white gaps in it, or if the area fill has horizontal white lines in it, continue with step 2; otherwise, stop here and continue printing normally.</p>

(Continued on next page)

Solving Printing/Faxing/Copying Problems (Continued)

Symptom:

Cause:

Solution:

2. Remove the print cartridge. Hold the print cartridge by the green top. Use a stiff card or other rigid paper to scrape the dried ink from the nozzles. Then use a lint-free damp cloth to gently clean the ink nozzles. Reinstall the print cartridge and print the Self Test report again. Check for white gaps and white lines. If you find some, continue with step 3; otherwise, stop here and continue printing normally.

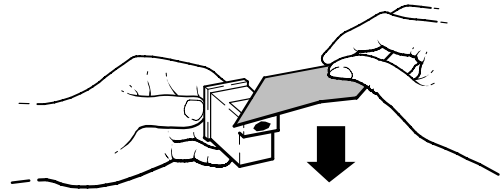

3. Remove the print cartridge. Hold the print cartridge by the green top. Place two drops of clean water on the gold rectangle of the print cartridge for about 60 seconds, then gently remove the water from the print cartridge with a lint-free damp cloth. Reinstall the print cartridge and try printing again. You may need to print a few pages before the ink resumes a continuous flow.

CAUTION: Do not clean the print cartridge unnecessarily, because it may shorten the life of the print cartridge.

4. If the print quality remains poor after trying steps 1 through 3, install a new print cartridge.

The last page of the file wasn't printed.

The HP OfficeJet is waiting to see if there is more data coming before releasing the last page.

Press the **Load/Eject** button or wait for a few minutes and your last page will be released. If after five minutes has passed and the HP OfficeJet has not received any more data, the last page of your file will be printed.

(Continued on next page)

Solving Printing/Faxing/Copying Problems (Continued)

Symptom:	Cause:	Solution:
<i>Parts of my documents are being clipped when I print from my Windows application.</i>	The Windows driver for the HP OfficeJet has a minimum top margin of 0.33 in. (8.4 mm) and a minimum bottom margin of 0.67 in. (17 mm).	Before you print your document, make sure the entire document is visible in the "Print Preview" of your Windows application.
<i>I can't get the font size I want when printing from my DOS application.</i>	The HP OfficeJet does not support the use of font cartridges.	Some DOS application printer drivers require that certain font styles are resident on the printer. The HP OfficeJet has various internal fonts available but cannot use additional fonts provided by HP DeskJet font cartridges. You must reformat your document using one of the internal fonts in the HP OfficeJet.
<i>My phone call is cut off when I try to make a copy.</i>	If you are talking on a phone attached directly to the HP OfficeJet and you press the Start/Copy button, the HP OfficeJet assumes that you are sending a fax.	To resume your telephone conversation, press the Stop button. Note: You cannot make copies while talking on a phone attached directly to the HP OfficeJet.
<i>There are dark streaks or lines on copies or on faxes sent from the HP OfficeJet.</i>	The scanner glass or reflective tape may be dirty.	Apply some glass cleaner to a soft, lint-free cloth, then gently wipe the scanner glass and tape clean. To locate the scanner glass and tape: Open the control panel by pulling the top ledge toward you, then open the top cover. Look inside the control panel for a glass strip that's about 3/4-inch (1.9 cm) wide and 9 inches (23 cm) long. The tape is opposite the glass.

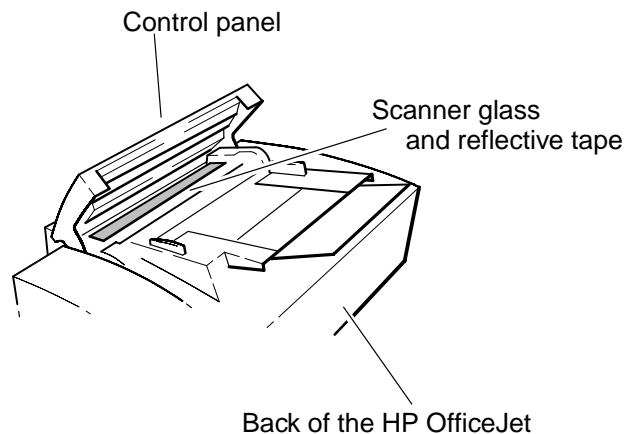
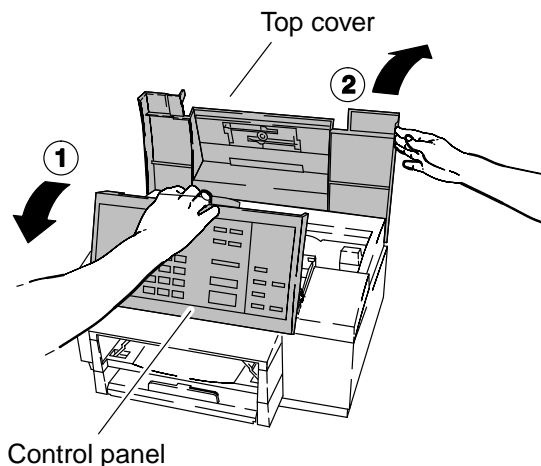

(Continued on next page)

Solving Printing/Faxing/Copying Problems (Continued)

Symptom:	Cause:	Solution:
<i>I can print, scan and change device settings with the HP OfficeJet LX manager, but PC Fax doesn't work properly.</i>	You may have a different CAS installed. Only one CAS modem can be used on a PC.	Remove (delete) the software for the other CAS modem.
<i>The HP OfficeJet LX never answers a call.</i>	Distinctive Ring is set to ON, but you don't have Distinctive Ring service.	Refer to the user's guide for instructions on how to turn OFF the Distinctive Ring feature.
<i>Eclipse FAX SE doesn't work on the PC.</i>	You may have previously installed a CAS fax modem that was removed before Eclipse FAX SE was installed. Only one CAS modem can be used on a PC.	Remove (delete) the software for the other CAS modem.
<i>Nothing happens when I try to print.</i>	If the HP OfficeJet LX printer doesn't respond when you try to print, it may be set to the wrong port.	Run the Windows control panel, select Printers , select the HP OfficeJet LX, then click the Connect button. Select the port that is connected to your device. Do not select HP OfficeJet LX. Click OK , close Printers and the control panel, and try printing again. If you still cannot connect, close the HP OfficeJet LX manager, exit Windows and turn the machine OFF. Check the cable connections, port selection and setup. Turn the machine back ON. Restart Windows and the HP OfficeJet LX manager.
<i>You get the message, "LPT1 is in use."</i>	The HP OfficeJet LX cannot access LPT1.	If you are using a switch to run two printers from a single LPT port, be sure that all HP OfficeJet LX activities are complete, and the HP OfficeJet LX manager and Eclipse FAX SE are closed before switching to another printer.
<i>You get the message, "Printer not responding."</i>	Your HP OfficeJet LX is turned OFF or disconnected.	Turn your HP OfficeJet ON. Make sure the interface cable is connected. Click Reconnect if your HP OfficeJet LX was previously able to connect to the device, check that the cable is securely attached at both ends,, the device is turned ON and "Ready" is displayed on the front panel. Check that any data switch is set to connect to the HP OfficeJet LX. Then click Reconnect .

(Continued on next page)

Solving Printing/Faxing/Copying Problems (Continued)

Symptom:	Cause:	Solution:
<i>The date on the control panel display is incorrect. The header information and speed dial numbers are missing.</i>	<p>The battery inside the HP OfficeJet has failed, causing all of the menu features to revert to their factory settings.</p> <p>Settings that contained alphabetic and numeric characters you entered (such as header name and number, speed dial names and numbers, etc.) have been erased.</p>	<p>You can continue to operate your HP OfficeJet without the battery. However, if you re-enter the menu settings and then turn off the power, the settings will be erased again.</p> <p>Contact HP's Customer Support Center regarding battery replacement.</p>
<i>Some of my menu settings seem to have reverted to their factory values without my changing them.</i>	<p>An internal error has caused some or all of the menu features to revert to their factory settings.</p>	<p>Print the Self Test report and check the Current Settings column to find out which menu settings have reverted to the factory settings. Change the settings and re-enter data as appropriate.</p> <p>For instructions on how to print the Self Test report, see "Self Test Report" in Chapter 3.</p>
<i>I can't receive a fax from my extension phones.</i>	<p>You don't have the Fax/TAM receive mode setup.</p>	<p>If you need to be able to receive faxes from extension phones, change the setup to Fax/TAM.</p>
<i>Incoming calls are not being answered.</i>	<p>The Distinctive Ring feature may be turned ON when the service is not available in your area or you have not yet subscribed to the service.</p>	<p>Turn OFF the Distinctive Ring feature and request the fax be sent again.</p>
<i>Items on the HP OfficeJet LX manager menu bar are grayed and the "Device Not Connected" error is displayed.</i>	<p>The HP OfficeJet LX is not properly connected.</p>	<p>If this happens after a first-time installation:</p> <p>Verify that the device is turned ON and the cable is properly connected.</p> <p>Verify that the cable is good.</p> <p>Verify that your LPT port allows bi-directional communication.</p> <p>If you have been using the HP OfficeJet LX manager and this happens:</p> <p>Verify that the device is turned ON with the message "Ready" displayed.</p> <p>Verify that the cable is properly connected at both ends.</p> <p>If a data switch is used, verify that it is set to HP OfficeJet LX.</p> <p>Restart Windows and try again.</p>

(Continued on next page)

Solving Printing/Faxing/Copying Problems (Continued)

Symptom:	Cause:	Solution:
<i>The printer prints part of a cancelled print job.</i>	Once you start a print job, the document is sent to the printer. If you cancel the print job, while the printer is out of paper or otherwise disabled, the portion of the document that was sent prints when the printer is available.	To prevent portions of cancelled print jobs from printing, press Load/Eject on the front panel while the message "Printing/Waiting for data..." is displayed.
<i>PC faxes quit during sending.</i>	It is possible that your PC is overloaded with activity like sending more than one fax at a time, or starting applications that take a long time.	Try to reduce the activity on your PC while faxes are being sent or received.
<i>Faxes routed to the PC are printed instead.</i>	If the HP OfficeJet LX manager is not running, faxes are printed upon receipt. If your PC is too busy, faxes are printed on receipt.	The HP OfficeJet LX manager may have lost the connection to the device. Open the front cover and make sure that the HP OfficeJet LX manager says "Close Cover." If it does not, check the cable connection to the device. If it appears OK, close and restart the HP OfficeJet LX manager.

Diagnostic Codes: What they are, how to read them and what to do

Diagnostic codes are 12- or 15- digit codes that can be used by a customer support representative to diagnose fax transmission (send and receive) problems. The diagnostic codes appear on the Fax Log Report which the user can have the HP OfficeJet print on demand or automatically after each fax transaction. Instructions for printing reports are provided in Chapter 3 of the HP OfficeJet User's Guide and in Chapter 3 of this document.

Use the sample Fax Log Report shown below to identify the diagnostic code. The paragraphs following the sample will help to analyze the code and what problem may have affected the machine's operation.

HP OfficeJet Personal Printer/Fax/Copier		Fax Log Report for ACME Co. 619 555-1234 Oct-27-94 2:30PM					
<u>Last 30 faxes</u>							
<u>Identification</u>	<u>Result</u>	<u>Pages</u>	<u>Type</u>	<u>Date</u>	<u>Time</u>	<u>Duration</u>	<u>Diagnostic</u>
5553756	OK	03	Sent	Oct-19	10:14A	00:02:05	001000000000
999 555 4783	Stop	02	Received	Oct-19	01:21P	00:01:38	001000000000
5551900	No Answer	00	Poll-in	Oct-20	09:57A	00:00:09	00100000000403
Public Images Inc.	Busy	00	Sent	Oct-20	11:48A	00:00:08	001000000000
5557990	Error	01	Poll-out	Oct-20	04:38P	00:01:18	00100000000411
5557990	Jammed	03	Sent	Oct-20	05:10P	00:02:40	001000000000
Henry No Document	00	Sent	Oct-21	01:00A	00:00:21	001000000000	
999 555 8012	Power Fail	01	Received	Oct-21	08:43A	00:01:27	001000000000
5554382	Power Fail	00	Sent	Oct-21	08:43A	00:00:05	001000000000
The Corner Deli	Cover Open	00	Sent	Oct-21	11:15A	00:00:14	001000000000
5554164	No Dial Tone	00	Sent	Oct-21	11:51A	00:00:12	001000000000

The diagnostic codes appear in the right-most column of the Fax Log Report as shown. Note that most diagnostic codes are 12 digits in length while some are 15 digits long. The 13th, 14th and 15th digits are *only* present when a communication error condition has occurred. Communication errors can occur in transmit or receive operations. Descriptions of each digit in the diagnostic code field are provided later in this section. To interpret the field, the digits will be referenced according to their place in the field. Moving from left to right, the digit positions will be reference-numbered 1 through 15.

Before describing the diagnostic codes in detail, it is beneficial to know when the types of codes (transmit or receive) may appear in a communication.

Fax Session Protocol: Diagnostic Code appearances in a communication

The HP OfficeJet is designed as a group 3 facsimile machine. Group 3 facsimile protocol has a set of rules that govern communication between a fax transmitter and receiver. The document to be sent is placed in the automatic document feed mechanism of the sending machine. Pressing a button will call the fax number of the receiving fax machine and start the electronic protocol (handshaking). The two fax machines then communicate to ensure a good connection and that the transmitter selects only those options that the receiver can properly handle.

Communications are conducted in phases with different signal exchanges occurring during the phases. The phases are described in the following paragraphs. The protocol exchange given in the following diagram shows the different phases and which diagnostic codes could typically appear in each of those phases. Diagnostic codes can be used by a customer support representative to diagnose fax transmission (send and receive) problems.

Phase A - Call Setup: The calling fax machine dials the number of the receiving fax machine. The ring signal and the CNG calling tone (0.5 sec duration, 1100 Hz frequency, sent at 3 sec intervals) are received at the called fax machine. The CNG tone beeps indicate the call is from a fax machine instead of a voice call. The called fax machine answers the ring signal by going off-hook and preparing for the incoming call. The receiving fax machine can be designated to have the ac power OFF until the ring signal appears. Also, some fax machines answer an call immediately, so the ring may not necessarily be heard by a person. After answering the ring, the called fax machine waits 1 second, sends a 3 second long 2100 Hz CED tone followed by 75 milliseconds of silence.

Phase B - Premessage Procedure: The called fax machine sends its digital identification signal (DIS) at 300 bits/sec identifying its capabilities, including option features. Upon hearing this distinctive signal, the caller presses the SEND button to connect the fax to the telephone line (all HP OfficeJets do this automatically, so the user doesn't need to). The calling fax machine automatically sends a digital command signal (DCS), locking the called unit into the capabilities selected. The calling fax machine sends a high-speed training signal (TCF) for the data modem. The called fax machine then sends a confirmation to receive (CFR) signal to confirm that the receiving modem is trained (adjusted for low-error operation) and that the fax machine is ready to receive.

Phase C - Message Transmission: The calling fax sends a training signal and then a picture signals for the entire page being sent.

Phase D - Postmessage Procedure: The calling fax machine sends an end of message (EOM) command which switches the fax modem back to 300 bits/sec and signals that the message has been sent and there are no pages to follow. If there are more pages to follow, the calling fax machine sends a multiple page (MPS) command. The called fax machine sends a message confirmation (MCF) indicating the page was received successfully.

Phase E - Call Release: The calling fax machine sends a disconnect (DCN) signal and both fax machines disconnect from the telephone line.

Use the following mnemonic descriptions when referring to the protocol diagram on the next page.

- CNG calling tone 1100 Hz, ON 0.5 sec, OFF 3 sec
- CED called station identification 2100 Hz
- DIS digital identification signal
- DCS digital command signal
- TCF training check zeroes for 1.5 sec
- CFR confirmation to receive 1850 or 1650 Hz for 3 sec
- MPS multipage signal
- EOM end of message 1100 Hz
- MCF message confirmation 1850 or 1650 Hz
- DCN disconnect
- EOP end of procedure
- RR receive ready
- CTC continue to correct
- PRI procedure interrupt
- PPS partial page signal
- EOR end of retransmission
- RTN retrain negative

HP OfficeJet Fax Session Protocol Diagram

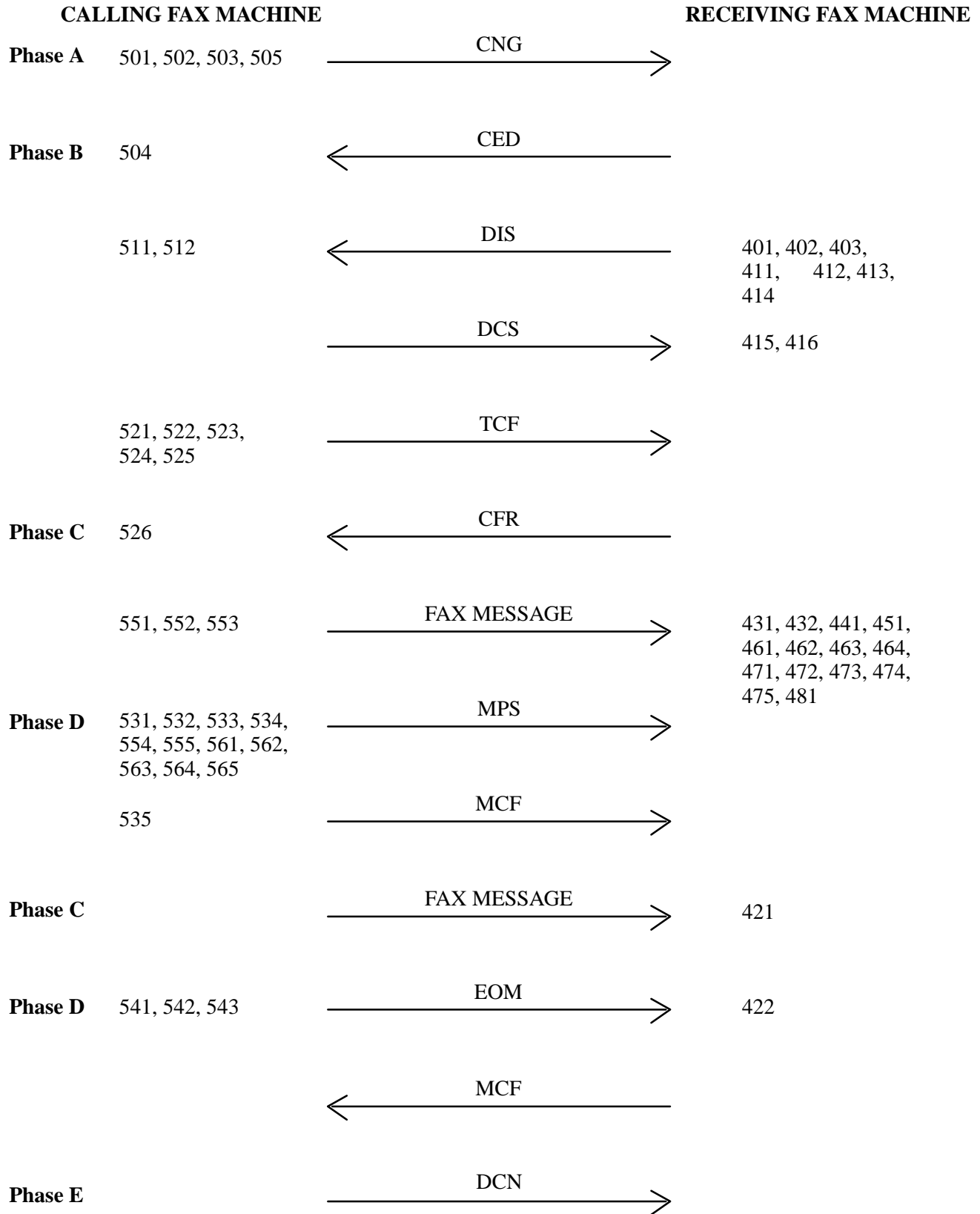

Diagnostic Code Descriptions

In the Diagnostic Code table are descriptions of each digit in the diagnostic code field. To interpret the field, the digits will be referenced according to their place in the field. Moving from left to right, the digit positions will be reference-numbered 1 through 15. Digits 1 through 5 in the codes are binary weighted.

DIAGNOSTIC CODES

sample code: 012420700102411

digit positions: 123456789(10)(11)(12)(13)(14)(15)

1st digit	Always set to "0".
2nd digit	Session End. Different ways a fax session may have completed. [1] = STOP was pressed. [2] = DCN was received from the remote site (DCN = disconnect) [4] = MEMORY filled during session [8] = OPERATOR ALERT requested
3rd digit	Operation. The type of fax session that occurred. [1] = RECEIVE from a remote transmitter [2] = TRANSMIT to a remote receiver [4] = POLLED receive, system became a transmitter [8] = POLLING transmit, system became a receiver
4th digit	Training. Different options that have been requested or were set during training. [1] = ID was received successfully (TSI or CSI) [2] = RETRAIN/FALLBACK was requested [4] = ECM was selected
5th digit	Send Operations. Different types of send operations that were selected by the user. [1] = DELAYED operation [2] = BROADCAST operation [4] = SPEED DIAL was used to select the dialing number [8] = ADF was in use, document was not sent from memory
6th digit	Protocol. Denotes the various resolution and coding methods used. [0] = Standard resolution/MH coding (MH = modified Huffman) [1] = Standard resolution/MR coding (MR = modified Read) [2] = Standard resolution/MMR coding (MMR = modified modified Read) [4] = Fine resolution/MH coding (MH = modified Huffman) [5] = Fine resolution/MR coding (MR = modified Read) [6] = Fine resolution/MMR coding (MMR = modified modified Read) [8] = 300 DPI/MH coding (MH = modified Huffman) [9] = 300 DPI/MR coding (MR = modified Read) [A] = 300 DPI/MMR coding (MMR = modified modified Read)
7th digit	Session Methodology. Session speed/type of data used for transmission and reception [0] = 0 ms/line [1] = 5 ms/line [2] = 10 ma/line [4] = 20 ms/line [7] = 40 ms/line [8] = 0 ms/line (Halftone) [9] = 5 ms/line (Halftone) [A] = 10 ms/line (Halftone) [C] = 20 ms/line (Halftone) [F] = 40 ms/line (Halftone)

DIAGNOSTIC CODES (Continued)

8th digit	Modem baud rate speed used. [0] = 2400 bps [1] = 4800 bps [2] = 7200 bps [3] = 9600 bps [4] = 12000 bps [5] = 14400 bps
9th digit	Always set to "0".
10th digit	Miscellaneous. [1] = This journal entry needs to be printed [2] = This was a Remote Diagnostic session [4] = This was a PC send session [8] = not used
11th digit	(send only) Used to identify errors in the transmission of a fax to a remote receiver. [0] = NULL XMT (XMT = transmit) [1] = MPS XMT [2] = EOP XMT [3] = EOM XMT (EOM = end of message) [4] = NULL XMT/RR REC [5] = MPS XMT/RR REC [6] = EOP XMT/RR REC [7] = EOM XMT/RR REC [8] = NULL XMT/CTC REC [9] = MPS XMT/CTC REC [A] = EOP XMT/CTC REC [B] = EOM XMT/CTC REC
12th digit	(send only) Used to identify errors in the transmission of a fax to a remote receiver. [1] = PRI [2] = PPS [3] = PPS-PRI [4] = EOR [5] = EOR-PRI [8] = RTN received (RTN = indicated line noise, subsequent [9] = PRI/RTN received pages should be sent at a lower baud rate)
13th digit	Communication error code. Only displayed if there is an error condition. Refer to the Communication Error Code table in this section on the following pages.
14th digit	Communication error code. Only displayed if there is an error condition. Refer to the Communication Error Code table in this section on the following pages.
15th digit	Communication error code. Only displayed if there is an error condition. Refer to the Communication Error Code table in this section on the following pages.

Communication Error Codes (level 400 and 500)

An error in communication detected during a fax transmission or reception will cause a three-digit error code to appear in positions 13 through 15 of the diagnostic code. Each fax transaction will have a corresponding diagnostic code, but the error code positions will only be added if an error occurs. All communication error codes will be either 400 level (receive errors) or 500 level (transmit errors).

A knowledge of T30 protocol is recommended to fully understand the diagnostic codes. This table briefly describes the T30 states and corresponding numeric value for Receive (RCV) and Transmit (XMT).

NUMERIC										
STATE	0	1	2	3	4	5	6	7	8	9
RCV	R	F	III	VII	VIII VIIa	IX VIIb	VIIIa	IXa	X	B
XMT	T	A	D	I II	E	IV V	VI	*	*	C

A summary of T30 states relative to error codes dealing specifically with reception of a fax to the unit, or the transmission of a fax from the unit, are provided in the next two tables. A detailed description of the 400 level receive and 500 level transmit communication error codes is provided later in this section.

T30 States – Receive Errors		
State	Error	Response Code (T30R)
R	1	DCN RECEIVED
	2	LINE DISCONNECT
	3	TIMEOUT T1
	4	T30R NO DOCUMENTS TO BE POLLED
F	1	NO POST MSG OR LOCAL INTERRUPT AT STATE F
	2	LINE DISCONNECT WAIT ON HDLC TIMER
	3	DCN RECEIVED
	4	T30R NO DOCUMENTS TO BE POLLED
	5	INVALID DCS
	6	SPEED MISMATCH
III NON-ECM	1	PHONE DISCONNECTED OPERATOR ALERT
	2	IRRELEVANT RESPONSE
VII	1	ABSOLUTELY NO LOCAL RESPONSE FOR REMOTE INTERRUPT
	2	PHONE DISCONNECTED OPERATOR ALERT
VIII VIIa	1	PHONE DISCONNECTED OPERATOR ALERT
IX VIIb	1	PHONE DISCONNECTED OPERATOR ALERT
VIIIa	1	TIMEOUT T2
	2	DCN RECEIVED
	3	LINE DISCONNECT
	4	IRRELEVANT RESPONSE
IXa	1	TIMEOUT T2
	2	ERR TRANSMITTED
	3	DCN RECEIVED
	4	LINE DISCONNECT
	5	IRRELEVANT RESPONSE
X	1	IRRELEVANT RESPONSE
B	ANYTIME	STATE B DISCONNECT (CHECK DIAG BIT DCN RCVD)

T30 States – Transmit Errors		
State	Error	Response Code (T30R)
T	1 2 3 4 5	LINE BUSY DCN RECEIVED LINE DISCONNECT IRRELEVANT RESPONSE TIMEOUT
A	1 2 3	INCOMPATIBLE REMOTE RECEIVER INCOMPATIBLE REMOTE TRANSMITTER T30R POLLING PASSWORD INCORRECT
D	1 2 3 4 5 6	DCN RECEIVED LINE DISCONNECT NO RESPONSE ON ALL RETRIES 3 IDENTIFICATIONS RECEIVED WHILE WAITING FOR CFR FALLBACK IMPOSSIBLE IRRELEVANT RESPONSE
I & II NON ECM	1 2 3 4 5 6	IRRELEVANT RESPONSE (CHECK DIAG BIT MPS EOP EOM) DCN RECEIVED LINE DISCONNECT NO RESPONSE ON ALL RETRIES FALLBACK IMPOSSIBLE (CHECK DIAG BIT MPS EOP EOM IN FTZ ONLY) T30R AT LEAST ONE PAGE NOT CONFIRMED
E	1 2	TIMEOUT FTZ ONLY PHONE DISCONNECTED OPERATOR ALERT
IV & V A B C D	1 2 3 4 5	PPS NULL SET, FOLLOW PATH A MPS SET, FOLLOW PATH B EOP SET, FOLLOW PATH C EOM SET, FOLLOW PATH D DCN RECEIVED (CHECK DIAG BIT RR CTC) LINE DISCONNECT (CHECK DIAG BIT RR CTC) NO RESPONSE ON ALL RETRIES (CHECK DIAG BIT RR CTC) IRRELEVANT RESPONSE (CHECK DIAG BIT CTC) FALLBACK IMPOSSIBLE
VI A B C D	1 2 3 4 5 6	EOR NULL SET, FOLLOW PATH A MPS SET, FOLLOW PATH B EOP SET, FOLLOW PATH C EOM SET, FOLLOW PATH D DCN RECEIVED (CHECK DIAG BIT RR) LINE DISCONNECT (CHECK DIAG BIT RR) NO RESPONSE ON ALL RETRIES (CHECK DIAG BIT RR) IRRELEVANT RESPONSE FALLBACK IMPOSSIBLE T30R AT LEAST ONE PAGE NOT CONFIRMED
C	ANYTIME	STATE C XMT DCN (CHECK DIAG BIT DCN SENT)

Refer to the following table for detailed descriptions of level 400 and 500 communication error codes:

COMMUNICATION ERROR CODES

RECEIVE ERRORS (400 level codes) – Code numbers not listed are not used

CODE	DESCRIPTION	COMMENTS
401	DCN received	You are called by a fax that is polling and from the DIS you send, it is noted that there is no document to send. The calling fax then sends you a DCN (Sharp brand fax machines).
402	Line disconnect	You transmitted a DCN and dropped the line after waiting 3 seconds for a received frame from the transmitter or the line signal was gone more than 0.2 seconds.
403	Time-out	Typically occurs if you are called by a person instead of a fax. No fax commands are detected and you time-out.
404	No document to be polled	You have polled another fax that does not have a document to be polled. Ricoh FAX800 or an HP OfficeJet will cause this error to be reported on the polling machine. Also may be caused if a Canon B200 polled the HP OfficeJet but the Canon user did not press the <START> key soon enough to force the Canon to poll rather than manual receive.
411	No post MSG or local interrupt	This error occurs if the line drops or the calling fax aborts during the training phase of the receive. For the first page at least, the message is “Connecting...”
412	Line disconnect	Time-out on the HDLC buffer. If the HDLC buffer finishes due to a line drop and loss of data, the system will wait for the message to finish to resynch and retransmit data to the receiver. Receiver sent DCN and dropped line after waiting 3 seconds for a receive frame from the transmitter or the line signal was gone for more than 0.2 seconds.
413	DCN received	You have polled a fax and it disconnects instead of sending a page. The sender fails to pick the next page in the scanner. The sender presses STOP as the sender starts to transmit.
414	No documents to be polled	There were no documents to be polled.
415	Invalid DCS	DCS was received in the command frame but was invalid. A valid DCS must correspond to the products request for ECM mode ON or OFF.
416	Speed mismatch	Set if the DCS frame received from a remote transmitter contains a minimum scan speed non-compatible with the receiver’s capabilities.
417	T30R (at least one page not confirmed)	In the non- error correction mode, the unit sent an RTN signal indicating that the page received had many bad lines and may not be readable (noisy line). In the error correction mode, the unit fails to receive a complete correct page after all attempts at resending.
419	System exception	The fax receive was aborted. The most common cause is lack of memory.
421	Phone disconnected	The user has disconnected the line after the voice session without continuing the fax session.

(Continued on next page)

COMMUNICATION ERROR CODES (Continued)		
RECEIVE ERRORS (400 level codes continued) – Code numbers not listed are not used		
CODE	DESCRIPTION	COMMENTS
422	Irrelevant response	In non-ECM mode the command received was none of the expected responses.
431	No local response for remote interrupt	Set by a receiver when working in ECM mode. The post-message voice request command was received and there was no local line request during T3 time-out.
432	Phone disconnected	The user has disconnected the line after the voice session without continuing the fax session while in ECM mode.
441	Phone disconnected	The user has disconnected the line after the voice session without continuing the fax session while in ECM mode.
451	Phone disconnected	The user has disconnected the line after the voice session without continuing the fax session while in ECM mode.
461	Time-out	T2 timer time-out waiting for a command following an RNR.
462	DCN received	A DCN was received in a command frame that was received in response to RNR. The local unit ran out of memory while receiving. When the sender asked RR (receive ready?), your unit sent RNR (receiver not ready). The sender will ask RR for 1–4 minutes and when it gives up waiting, will send a DCN (disconnect) back to you.
463	Line disconnect	Receiver sent DCN and dropped the line after waiting 3 seconds for a received frame from the transmitter or the line signal was gone more than 0.2 seconds.
464	Irrelevant response	In ECM mode the command received was not expected.
471	Time-out	T2 timer time-out waiting for a command following an RNR.
472	ERR transmitted	Set by a receiver in ECM if a transmitter decides to abort re-transmissions of current block/page/document after 4 unsuccessful retries and possible fallbacks in modem speed.
473	DCN received	A DCN was received in a command frame that was received in response to RNR.
474	Line disconnect	Receiver sent DCN and dropped the line after waiting 3 seconds for a received frame from the transmitter or the line signal was gone more than 0.2 seconds.
475	Irrelevant response	In ECM mode the command received was not expected.
481	Irrelevant response	In ECM mode, the command received was not RR.
(Continued on next page)		

COMMUNICATION ERROR CODES (Continued)		
TRANSMIT ERRORS (500 level codes) – Code numbers not listed are not used		
CODE	DESCRIPTION	COMMENTS
501	Line busy	Busy tone detected during initial handshake. “BUSY” displayed on journal.
502	DCN received	A DCN was received in a command frame that was received in response to CNG. The remote side ended the session by sending DCN (disconnect) very early in the session setup. Between 2 HP OfficeJets, you can cause this condition by pressing STOP on the receiving unit immediately upon seeing the “Answering...” display.
503	Line disconnect	Receiver sent DCN and dropped the line after waiting 3 seconds for a received frame or the line signal was gone more than 0.2 seconds.
504	Irrelevant response	Command following CNG was not valid.
505	Time-out	T1 timer elapsed and no response received. “No answer” displayed on journal report.
511	Incompatible remote receiver	Receiver is non-compatible for customizable functions.
512	Incompatible remote receiver	Receiver is non-compatible or polling was requested and denied.
513	Polling password incorrect	You were polled and there was no document to send.
514	No documents to be polled	The polling unit does not look at the DIS which says we do not have a document to poll and requests us to send one anyway.
515	Time-out	Timer has elapsed.
521	DCN received	DCN was received in a response frame following the training phase. The remote side ended the session by sending DCN (disconnect) during the session setup. Between 2 HP Office-Jets, you can cause this condition by pressing STOP on the receiving unit immediately upon seeing the “Connecting...” display.
522	Line disconnect	Receiver sent DCN and dropped the line after waiting 3 seconds for a received frame or the line signal was gone more than 0.2 seconds.
523	No response on all retries	No response was received on all 3 attempts to establish connection with DCS. We lost connection with the receiver, either because the line dropped or because the receiver hung up.
524	Identification received	Failure to sync with the remote unit. The line may be defective which keeps the remote unit from seeing the DCS command.
525	Fallback impossible	Fallback in modem speed is needed but impossible (for example: receiver supports V.29 but V.27 is needed). All attempts to train with the remote unit have failed. The HP OfficeJet attempts to train at 9600, 7200, 4800 and 2400 baud.

(Continued on next page)

COMMUNICATION ERROR CODES (Continued)		
TRANSMIT ERRORS (500 level codes continued) – Code numbers not listed are not used		
CODE	DESCRIPTION	COMMENTS
526	Irrelevant response	The response received following the DCS + training was not valid (expected CFR).
531	Irrelevant response	The response received following the transmission of MPS, EOP, EOM was incorrect. Check diagnostic bits 11 and 12.
532	DCN received	DCN was received in a response to the transmittal signal. Check diagnostic bits 11 and 12.
533	Line disconnect	Receiver sent DCN and dropped the line after waiting 3 seconds for a received frame or the line signal was gone more than 0.2 seconds.
534	No response on all retries	The connection was lost either because the line was dropped or the receiver hung up.
535	Fallback impossible	Fallback in the transmission of post messages is not possible. Remote receiver does not respond with a RTP or RTN or the transmitter can't retransmit. If the session is non-ECM and the receiver responded RTN after the sending unit sent a page, the sending unit will train down to a slower speed for the next page. After 2400 baud fails, the unit cannot train down any slower and reports error code 535. In ECM mode, the error might be possible, but the sequence would be different (not using RTN).
536	At least one page not confirmed	Occurs in non-ECM mode when there are many errors on a page. The page received was not readable.
541	Phone disconnected	The user has disconnected the line after the voice session without continuing the fax session.
542	Time-out	The T3 operator intervention timer has expired.
543	Irrelevant response	The response received after the transmission of a voice request to the remote sender was not a DIS.
551	DCN received	DCN was received in a response to the transmitted signal. Check diagnostic bits 11 and 12.
552	Line disconnect	Receiver sent DCN and dropped the line after waiting 3 seconds for a received frame or the line signal was gone more than 0.2 seconds.
553	No response on all retries	The connection was lost with the receiver either because the line was lost or the receiver hung up.
554	Irrelevant response	The response received following the transmission of PPS-NULL, PPS-MPS, PPS-EOM was incorrect. Check diagnostic bits 11 and 12.
555	Fallback impossible	System is unable to receive a valid ECM transmission at any baud rate.

(Continued on next page)

COMMUNICATION ERROR CODES (Continued)		
TRANSMIT ERRORS (500 level codes continued) – Code numbers not listed are not used		
CODE	DESCRIPTION	COMMENTS
561	DCN received	DCN was received in a response to the transmitted signal. Check diagnostic bits 11 and 12.
562	Line disconnect	Receiver sent DCN and dropped the line after waiting 3 seconds for a received frame or the line signal was gone more than 0.2 seconds.
563	No response on all retries	The connection was lost with the receiver either because the line was lost or the receiver hung up.
564	Irrelevant response	The response received following the transmission of PPS-NULL, PPS-MPS, PPS-EOM was incorrect. Check diagnostic bits 11 and 12.
565	No cont. with next message	Set by a transmitter (ECM) when it aborted retransmissions of current block/page/document after 4 unsuccessful retries and possible fallbacks in modem speed.
566	At least one page not confirmed	ERR was received from the receiver in response to EOR-MPS, -EOP, -EOM, or -NULL.

These examples will help understand how the communication error coding works.

What the user sees on the display: NOISY LINE
 What is in the error code: 463
 Code description: 4 = Receive
 6 = State VIIIa
 3 = T30R LINE DISCONNECTED
 What it means: The user was receiving a document from a remote transmitter when the line disconnected.

What the user sees on the display: LINE BUSY
 What is in the error code: 501
 Code description: 5 = Transmit
 0 = State T
 1 = T30R LINE BUSY
 What it means: The user was attempting to transmit a document and was in the first state (T) of transmit. The line on the other end was already off-hook.

Power-On Initialization Tests

When first powered-on, the HP OfficeJet performs a series of tests during the initialization sequence. The control panel will briefly display “**Servo Processor Revision x.x.**”, even if no firmware is installed. If the initialization cannot proceed past this display, the firmware should be checked (or installed if missing). The next display shown will be “**Self Test Please Wait**”.

Refer to the following table for a description of the power-on self tests performed.

Power-On Initialization Sequence Tests		
Test #	Test	Description
1	Test RAM Memory	Checks RAM not used for system.
2	Test ROM	Firmware checksum.
3	Scanner Check	Calibrates scanner. Calibrated sensitivity level checked against a minimum reference level.
4	Printer Mechanism Check	Paper drive motor is briefly driven, carriage driven to service station position, presence of encoder feedback checked, extreme left carriage position located, paper pick mechanism exercised, pen presence and ink level detected, carriage returned to service station.
5	SRAM Checksum	Catches SRAM corruption or SRAM lost due to a low or defective battery.
6	LIU Code #	Matches the LIU code read from the LIU to that which is already stored in SRAM.
7	SRAM Version #	Compares the SRAM version number read from firmware to that which is already stored in SRAM.
8	LIU Check	Checks if the LIU is present. A system error code will be displayed if there is no LIU.

When the display reads “**Ready (receive mode) (date) (time)**”, the test is complete.

If an error is detected, an error message or diagnostic code will be displayed. If necessary, refer to the display messages and diagnostic codes presented earlier in this chapter.

Special Menu and Functions

Special menus and various functions can be accessed through multiple (simultaneous) button presses while powering on the HP OfficeJet. These button combinations should be held prior to and during powering on until the display reads “**Self Test Please Wait**”. Most of these functions can also be accessed through the Service and Factory menus described later in this section. Using these functions should be limited to only accessing the Service and Factory menus, for transferring the settings of one HP OfficeJet to another, and for resetting parameter values.

Refer to the following table for accessing the special menus and functions.

Special Menu and Functions		
Buttons to be pressed	Menu/Function accessed	Use
* and 7	Menus access	Accesses 3 menus: Service and Factory, Regulatory Settings and Underware. Only the Service and Factory menus should be accessed by persons other than HP authorized repair center personnel.
4 and 7	Local Receive	Used when copying or transferring the user settings from one HP OfficeJet to another HP OfficeJet locally. The two HP OfficeJets are connected by a common phone cord between each LINE telephone connection. This HP OfficeJet will be cloned to the other since this one is set to receive the data. The data transfer is automatic. It does not matter which HP OfficeJet is powered on first.
4 and 1	Local Send	Used when copying or transferring the user settings from one HP OfficeJet to another HP OfficeJet locally. The two HP OfficeJets are connected by a common phone cord between each LINE telephone connection. The other HP OfficeJet will be cloned to this one since this one is set to send the data. The data transfer is automatic. It does not matter which HP OfficeJet is powered on first.
* and 1	Full Reset	Will reset all settings and user menu setup items to factory default settings except for parameter 200 (scanner calibration) unless this value is out of range. Header, speed dial numbers, etc. will be erased.
* and 4	Partial Reset	Will reset most user menu setup items except for header name and number, speed dial numbers, journal entries, broadcast header and numbers, and the Mercury number (U.K. only). Parameters 1 through 127, 155, 175 through 179, 200, 201, and 226 through 229 are not reset.

Also, after the HP OfficeJet is powered on and in the “**Ready**” state, pressing the “5” and “2” buttons simultaneously will produce a one-page demo printout which includes a listing of many of the product’s features and capabilities.

Service and Factory Menu

Located in the Service and Factory Menu structure are several unique tests and procedures which can be used to help isolate problems, perform remote diagnostics and change internal parameters.

Service and Factory Menu Structure

This menu tree shows the structure of the Service and Factory Menu presented on the following pages.

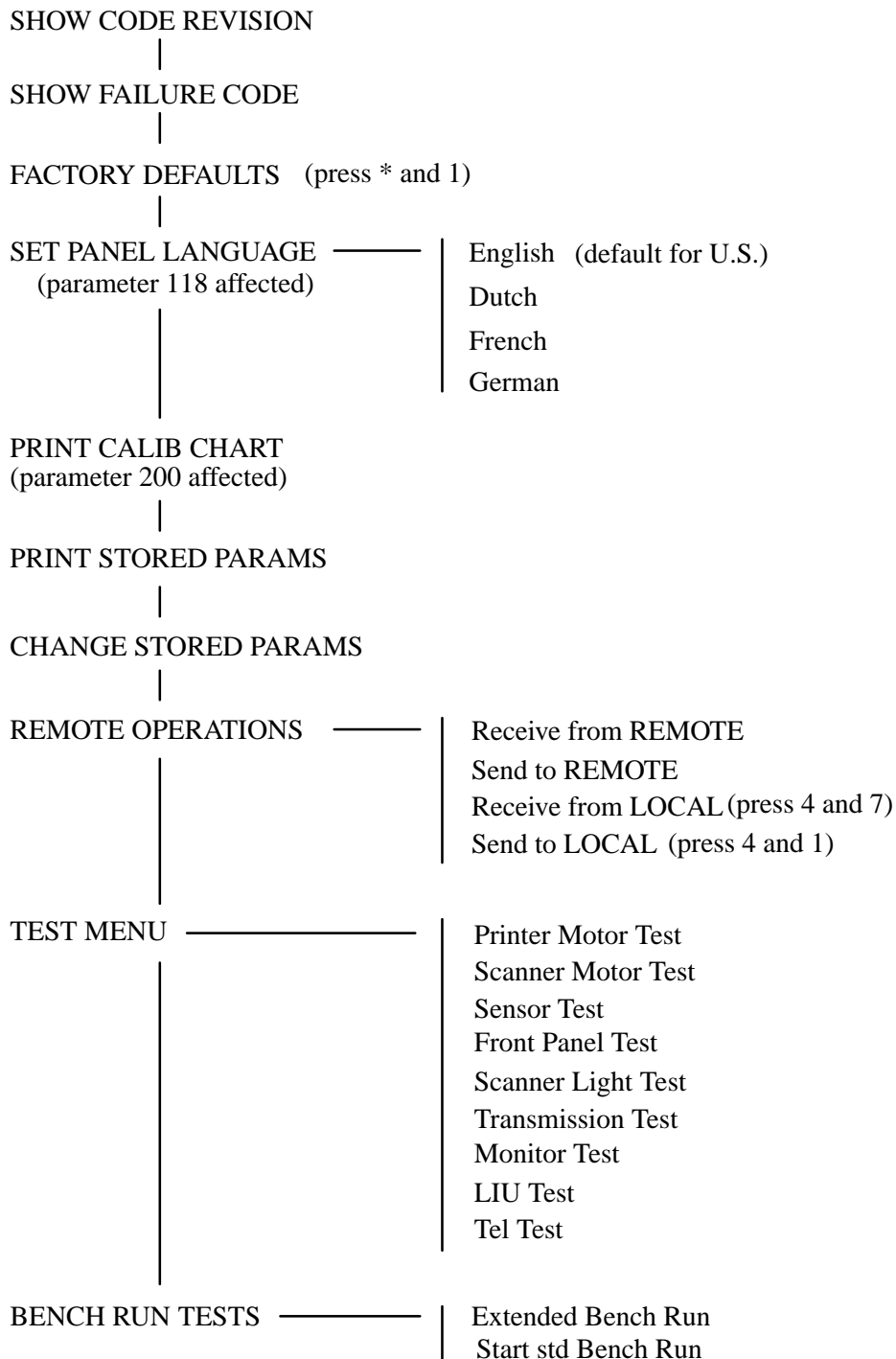

There are two methods that can be used to access the Service and Factory Menu as follows:

- Press the “*” and “7” buttons simultaneously while powering on the HP OfficeJet.
- From the “**Enter Header Number**” display, first use the “Backspace” button to erase the currently displayed header number (if present), then press the “Redial/Pause”, “*”, “Redial/Pause”, “2”, “3”, “2” and “Enter/Save” buttons in sequence.

Two other menu headings will also appear. The Regulatory Settings and the Underware menu headings will be seen as well as the Service and Factory Menu headings. **Do NOT attempt to access or use the Regulatory Settings or Underware menus.** These should only be accessed by HP factory personnel.

Once the Service and Factory Menu has been accessed, it will remain part of the main menu structure until the HP OfficeJet is powered OFF. Cycling the power OFF and then ON will return the main menus back to normal (the Service and Factory Menu will no longer be accessible). To reaccess the Service and Factory Menu, this procedure will need to be restarted.

When the Service and Factory Menu is made accessible, the following features will change:

- The menu settings report will print out all available menu structures.
- The Self Test report will also print out a complete parameter listing (firmware revision dependent).
- An error report will include a more detailed listing of the diagnostic code.

The same method used to navigate and select user menu functions is also used for the Service and Factory Menu. All the various functions and tests available in the Service and Factory Menu are listed in the following paragraphs.

Show Code Revision: The current firmware revision level is displayed for 5 seconds.

Show Failure Code: The last system error failure code is displayed for 5 seconds.

Factory Defaults: Sets all user and parameter settings to default. Once selected, pressing the “Start/Copy” button will continue the default procedure. Pressing any other button will exit the selection. The HP OfficeJet must be powered OFF and then ON to begin using the default values. This menu item may also be selected by pressing the “*” and “1” buttons simultaneously while powering the unit ON.

Set Panel Language: Will set the front panel display to the selected language option. Available options are English, Dutch, French, and German. The default language setting is determined by the Line Interface Unit installed as prescribed by the unit’s country of destination for shipment.

Print Calib Chart: The distance between the page detect sensor and the location of the scanner will vary between machines due to parts tolerances. This variation affects the top scanning margin. The scanner position calibration will adjust the top margin. The Print Calib Chart is used for this procedure and contains the following features:

1. A check to see if a calibration is successful or needed.
2. Instructions on how to perform the calibration.
3. Calibration scale used to select the correct parameter value.

To check if a calibration is needed, first print the Calibration Chart. Then cut the top of the chart along the dotted line. Set the HP OfficeJet copy reduction setting to 100%. Make one copy of the chart by feeding the top end first into the document feeder. If the hour-glass figure printed on the chart is either completely visible or not visible at all, a calibration is needed. Ideally, one-half of the hour-glass figure should be visible. A detailed description of this procedure is provided in chapter 4 of this manual.

Print Stored Params: A four-page hard copy printout of all parameter values. The report provides the following:

1. Parameter number.
2. Brief parameter description.
3. Current parameter values.
4. Default parameter values if different from the current value.

Change Stored Params: Provides the ability to change the value of any parameter. After selecting this item, the procedure to change a parameter value is as follows:

1. Type in the parameter number to be changed, then press “Enter/Save”.
2. Type in the desired parameter value, then press “Enter/Save”.

The new value is now stored and will be retained even if the unit is powered OFF.

Remote Operations: Allows parameter values to be sent to, or received from, a remote or local device. There are four menu selections available from this menu item as follows:

Receive from REMOTE: The remote device must have “**Remote Service**” selected to **ON** from the “Phone Setup” User Menu. After selecting this item, the display will request the remote fax machine’s number. The remote HP OfficeJet will be called and all parameter values will be copied into the calling unit, including all the user menu setup items. The calling HP OfficeJet will be effectively cloned to the remote HP OfficeJet.

Send to REMOTE: The remote device must have “**Remote Service**” selected to **ON** from the “Phone Setup” User Menu. After selecting this item, the display will ask if you want to send the remote device all parameter values or only non-user menu items:

- 1 = All (all parameter values)
- 2 = Params only (non-user menu parameters only)

Selecting *ALL* will effectively clone the remote device to the calling device including header information and speed dial numbers. Selecting *Params only* will not affect the remote device’s header or speed dial number information or any other settings from the normal user menu.

Receive from LOCAL: This feature is used between two HP OfficeJets that are connected by a common phone cord plugged into the LINE connector on each device. An outside phone service or telephone line simulator is not required. Selecting this menu item will clone this device to the other HP OfficeJet. The other HP OfficeJet must be set to *Send to LOCAL* before data will actually be received. This feature may also be selected by pressing the “7” and “4” buttons simultaneously while powering the unit ON.

Send to LOCAL: This feature is used between two HP OfficeJets that are connected by a common phone cord plugged into the LINE connector on each device. An outside phone service or telephone line simulator is not required. Selecting this menu item will clone the other HP OfficeJet to this device. The other HP OfficeJet must be set to *Receive from LOCAL* before data will actually be received. This feature may also be selected by pressing the “4” and “1” buttons simultaneously while powering the unit ON.

Note: The order in which you select *Receive from LOCAL* and *Send to LOCAL* devices is not important.

Test Menu: This menu allows access to the following separately selectable tests:

- Printer Motor Test:* Remove any paper from the input tray before selecting this test. The paper pick mechanics are tested continuously until the “Stop” button is pressed. The front cover and access door may be opened after the test has started, to allow the test components to be viewed during the test. Components tested include:
1. Printer stepper motor
 2. Carriage Actuated lever
 3. Engagement clutch
- Scanner Motor Test:* The automatic document feed mechanism of the scanner is tested continuously until the “Stop” button is pressed. The front cover may be opened after the test has started to allow viewing of the following tested components:
1. Scanner stepper motor
 2. Transmission gears/clutch
 3. Pick roller
 4. Drive roller
 5. Kickout roller
- Sensor Test:* Allows manual testing of the five optical and mechanical sensors. A five-digit binary word is displayed on the front panel. Each digit is assigned to a specific sensor and will toggle from “0” to “1” when the sensor is activated. A “0” is displayed when the sensor is inactive and a “1” displayed when the sensor is activated. The front cover may be opened after the test has started to allow access to some sensors. Pressing the “Stop” button will exit the test.
- In order, from left to right, the digits are assigned to the sensors indicated below:
1. Front panel cover open sensor (micro switch)
 2. Print mechanism paper sensor
 3. Input tray paper sensor
 4. Scanner document present sensor
 5. Scanner end of document sensor
- Front Panel Test:* A 2- by 14- digit binary array is displayed on the front panel display. Each binary digit is assigned to a particular front panel button. As each button is pressed, the assigned digit will toggle from “0” to “1” and from “1” to “0” when pressed again. Pressing the “Stop” button will exit the test.
- Scanner Light Test:* Lights all segments of the scanner bar LED. The front cover may be opened after the test has started to allow viewing of the LED bar during testing. Pressing the “Stop” button will exit the test.
- Transmission Test:* Pressing the left arrow (◀) button will invoke the following transmission sequence (ensure the volume is loud enough to hear the signals):
- Off hook (should hear dial tone)
- | | | | |
|-------------------|----------|----------------|----------|
| V.29 | 9600 bps | V.29 | 7200 bps |
| V.27 | 4800 bps | V.27 | 2400 bps |
| V.21 | 300 bps | 2100 Hz (CED) | |
| 1100 Hz (CNG) | | 1000 Hz (Test) | |
| Digit 1 | | Digit 2 | |
| Digit 3 | | Digit 3 | |
| Digit 5 | | Digit 6 | |
| Digit 7 | | Digit 8 | |
| Digit 9 | | Digit 0 | |
| Digit * | | Digit # | |
| On hook (no tone) | | | |

System Error Codes

System error codes may be displayed on the front panel display. They are recorded at parameter locations 176 through 179. Printing the Stored Parameter Report from the Service and Factory Menu will provide a printed copy of all the parameter values. Individual parameter values may be viewed using the Changes Stored Parameters feature also in the Service and Factory Menu.

The error codes are recorded sequentially starting at parameter location 176. If more than four system errors have occurred, the previously recorded error codes will be overwritten in a wrap-around manner. In this case, the last four error codes will be known but the last error that occurred cannot be determined.

Refer to the following table for a description of the system error codes and recommended actions. Replacement of the Main PCA, LIU, scanner parts, and print mechanism should be referred to the HP Customer Support Center for repair arrangements. Do not attempt to repair the unit.

System Error Codes		
Error Code Number	Description	Recommended Action
105, 107	ROM test failed	Cycle power. If error persists, replace/reseat ROMs.
106, 108, 110	RAM/SRAM failed	Cycle power. If error persists, replace Main PCA / battery.
111	Character ROM failed	Replace Main PCA.
205, 208, 209, 210, 211, 212, 213	Scanner failure	Cycle power. If error persists, check the scanner cable connections, clean the scanner glass, replace scanner. For codes 208 - 213, note the code number and call for service.
301	LIU failure	Cycle power. If error persists, replace/reseat LIU. Replace Main PCA.
all 400s and 500s	Fax firmware failure	Cycle power. If error persists, note the code number and call for service.
all 600s and 700s	Firmware error	Cycle power. If error persists, note the code number and call for service.
801	Servo shutdown	Power OFF the unit. Check for obstruction of pen carriage. If error persists, replace print mechanism.
all 800s except 801	Firmware error	Cycle power. If error persists, note the code number and call for service.
901	Battery failure	Cycle power. If error persists, replace battery on Main PCA.
902	SRAM corrupted	Cycle power. If error persists, replace the Main PCA.

User Menu - Associated Parameter Structure

Certain user menu selections either affect, or are affected by, various internal parameters. The following diagram shows the various user menu functions and the associated parameter numbers whose values are affected by the user menu item.

HP OfficeJet User Menu - Associated Parameter Structure

<u>Menu Hierarchy – Left to right, top to bottom</u>		(Default settings are in bold typeface)	<u>Parameter Number(s) Affected</u>
Time/Date, Header	Time/Date		(116 / 117)
	Fax Header		
Reports	Fax log	Print Now	(130)
		Automatic Log	
		Last fax/Last 30 faxes	
		Error only /Send or error/ Send only/Off	
	Speed Dial		
	Menu Settings		
	Self Test		
	Print Demo		
	Print All		
Fax/Copy Contrast	Normal /Lighten/Darken		(143)
Paper Size	Letter = 8.5 x 11 in./A4 = 210 x 297 mm/ Legal = 8.5 x 14 in./Exec = 7.25 x 10.5 in./Envelopes		(115)
Fax Settings	Speed Dial Setup		(005)
	Group Dial Setup		
	Phone Setup	Rings to Answer 2, 3, 4, 5	
		Ringer On/Off	
		Ring/Beep Volume Soft/Loud	
		Button Beeps On/Off	
		Dialing Mode Tone/Pulse	
		Auto Redial On/Off	
		Distinctive Ring On/Off	
		Remote Service On/Off	
	Send Fax Later	Setup/Cancel Send	
	Polling Setup	Receive/Send	
	Backup Reception	On/Off	
	Silent Detect	On/Off	
	Auto Reduction	On/Off	
Printer Settings	Character Set	PC-8/HP Roman 8/PC-8 Danish/Nor/Uk ISO 4/ German ISO 21/French ISO 69/Italian ISO 15/ Nor V.1 ISO 60/Swed Names ISO 11/ASCII/ Spanish ISO 17/Portug ISO 16/PC-850/ ECMS-94/HP Legal	(132)
	Carriage Return	CR only /CR and LF	(133)
	Perf Skip Mode	On/Off	(134)
	Text Scale Mode	On/Off	(135)
Copier Settings	Copy Reduction	100% to 75% in 5% steps (Legal-to-Letter) /70%	(142)
Also, the following immediate action front panel buttons affect parameter values:			
	Resolution		(144, 145)
	Receive Mode		(003, 017)

OFFICEJET PARAMETER DESCRIPTIONS

The parameter database is initialized from internal tables based on the LIU country code and revision. Many of these parameters are modifiable by the user or support person and are not initialized whenever the unit is powered ON. Changes made will normally be retained. Parameter values will initialize to default values under the following circumstances:

- First startup at factory
- Startup after battery failure
- Factory (or full) reset
- LIU replacement

Refer to the following parameter listing for a description and value(s) for each parameter number. The units describe the range of selection (in parenthesis) and incremental units for that range. Default values for various countries are specified in the listing. Parameters shown with an "*" are affected by the User menu.

LIU (Line Interface Unit) Identification

Parameter #	Description	Units																		
1	LIU ID interface code. Code displayed depends on the country LIU installed. <table border="0"> <tr> <td><u>Code</u></td> <td><u>Country</u></td> </tr> <tr> <td>13</td> <td>Mexico</td> </tr> <tr> <td>14</td> <td>Canada (French)</td> </tr> <tr> <td>15</td> <td>United States</td> </tr> <tr> <td>23</td> <td>Australia</td> </tr> <tr> <td>31</td> <td>United Kingdom</td> </tr> <tr> <td>35</td> <td>Netherlands</td> </tr> <tr> <td>39</td> <td>Germany</td> </tr> <tr> <td>47</td> <td>France</td> </tr> </table>	<u>Code</u>	<u>Country</u>	13	Mexico	14	Canada (French)	15	United States	23	Australia	31	United Kingdom	35	Netherlands	39	Germany	47	France	N/A
<u>Code</u>	<u>Country</u>																			
13	Mexico																			
14	Canada (French)																			
15	United States																			
23	Australia																			
31	United Kingdom																			
35	Netherlands																			
39	Germany																			
47	France																			
2	LIU Revision code. Also depends on the LIU installed. Values of 0 through 3 are supported. For example: Default = 0 (=rev. 0). <table border="0"> <tr> <td><u>Country</u></td> <td><u>Default</u></td> </tr> <tr> <td>United States</td> <td>0</td> </tr> <tr> <td>Canada (French)</td> <td>0</td> </tr> <tr> <td>Mexico</td> <td>0</td> </tr> <tr> <td>Australia</td> <td>0</td> </tr> <tr> <td>France</td> <td>0</td> </tr> <tr> <td>Germany</td> <td>0</td> </tr> <tr> <td>Netherlands</td> <td>0</td> </tr> <tr> <td>United Kingdom</td> <td>0</td> </tr> </table>	<u>Country</u>	<u>Default</u>	United States	0	Canada (French)	0	Mexico	0	Australia	0	France	0	Germany	0	Netherlands	0	United Kingdom	0	0-3
<u>Country</u>	<u>Default</u>																			
United States	0																			
Canada (French)	0																			
Mexico	0																			
Australia	0																			
France	0																			
Germany	0																			
Netherlands	0																			
United Kingdom	0																			
3*	Auto answer enabled. Modified by the user using the <Receive Mode> key. If TRUE then OfficeJet will automatically answer and attempt to receive a fax after the set rings to answer. <table border="0"> <tr> <td><u>Country</u></td> <td><u>Default</u></td> </tr> <tr> <td>United States</td> <td>1</td> </tr> <tr> <td>Canada (French)</td> <td>1</td> </tr> <tr> <td>Mexico</td> <td>1</td> </tr> <tr> <td>Australia</td> <td>1</td> </tr> <tr> <td>France</td> <td>1</td> </tr> <tr> <td>Germany</td> <td>1</td> </tr> <tr> <td>Netherlands</td> <td>1</td> </tr> <tr> <td>United Kingdom</td> <td>1</td> </tr> </table>	<u>Country</u>	<u>Default</u>	United States	1	Canada (French)	1	Mexico	1	Australia	1	France	1	Germany	1	Netherlands	1	United Kingdom	1	0 = FALSE 1 = TRUE
<u>Country</u>	<u>Default</u>																			
United States	1																			
Canada (French)	1																			
Mexico	1																			
Australia	1																			
France	1																			
Germany	1																			
Netherlands	1																			
United Kingdom	1																			

Ring Detection and Auto Answering

Parameter #	Description	Units																		
4*	<p>Distinctive ring detection mode. Determines the types of rings that are counted. OfficeJet can only be set to detect any non-single ring. This parameter is selected by the customer from the Phone Setup menu.</p> <table border="1"> <thead> <tr> <th><u>Country</u></th> <th><u>Default</u></th> </tr> </thead> <tbody> <tr> <td>United States</td> <td>0</td> </tr> <tr> <td>Canada (French)</td> <td>0</td> </tr> <tr> <td>Mexico</td> <td>0</td> </tr> <tr> <td>Australia</td> <td>0</td> </tr> <tr> <td>France</td> <td>0</td> </tr> <tr> <td>Germany</td> <td>0</td> </tr> <tr> <td>Netherlands</td> <td>0</td> </tr> <tr> <td>United Kingdom</td> <td>0</td> </tr> </tbody> </table>	<u>Country</u>	<u>Default</u>	United States	0	Canada (French)	0	Mexico	0	Australia	0	France	0	Germany	0	Netherlands	0	United Kingdom	0	0 = OFF 4 = ON
<u>Country</u>	<u>Default</u>																			
United States	0																			
Canada (French)	0																			
Mexico	0																			
Australia	0																			
France	0																			
Germany	0																			
Netherlands	0																			
United Kingdom	0																			
5*	<p>Rings to answer. Minimum number of rings that must be detected before OfficeJet will automatically answer if the receive mode is set to AUTO. Users may select from 2 thru 5 rings from the Phone Setup menu.</p> <table border="1"> <thead> <tr> <th><u>Country</u></th> <th><u>Default</u></th> </tr> </thead> <tbody> <tr> <td>United States</td> <td>2</td> </tr> <tr> <td>Canada (French)</td> <td>2</td> </tr> <tr> <td>Mexico</td> <td>2</td> </tr> <tr> <td>Australia</td> <td>2</td> </tr> <tr> <td>France</td> <td>2</td> </tr> <tr> <td>Germany</td> <td>2</td> </tr> <tr> <td>Netherlands</td> <td>2</td> </tr> <tr> <td>United Kingdom</td> <td>2</td> </tr> </tbody> </table>	<u>Country</u>	<u>Default</u>	United States	2	Canada (French)	2	Mexico	2	Australia	2	France	2	Germany	2	Netherlands	2	United Kingdom	2	1 ring (1 ring to 15 rings)
<u>Country</u>	<u>Default</u>																			
United States	2																			
Canada (French)	2																			
Mexico	2																			
Australia	2																			
France	2																			
Germany	2																			
Netherlands	2																			
United Kingdom	2																			
6	<p>Ring detect low frequency. Minimum valid frequency for the incoming ring signal.</p> <table border="1"> <thead> <tr> <th><u>Country</u></th> <th><u>Default</u></th> </tr> </thead> <tbody> <tr> <td>United States</td> <td>15</td> </tr> <tr> <td>Canada (French)</td> <td>15</td> </tr> <tr> <td>Mexico</td> <td>15</td> </tr> <tr> <td>Australia</td> <td>13</td> </tr> <tr> <td>France</td> <td>25</td> </tr> <tr> <td>Germany</td> <td>21</td> </tr> <tr> <td>Netherlands</td> <td>20</td> </tr> <tr> <td>United Kingdom</td> <td>15</td> </tr> </tbody> </table>	<u>Country</u>	<u>Default</u>	United States	15	Canada (French)	15	Mexico	15	Australia	13	France	25	Germany	21	Netherlands	20	United Kingdom	15	1 Hz (10 Hz to 99 Hz)
<u>Country</u>	<u>Default</u>																			
United States	15																			
Canada (French)	15																			
Mexico	15																			
Australia	13																			
France	25																			
Germany	21																			
Netherlands	20																			
United Kingdom	15																			
7	<p>Ring detect high frequency. Maximum valid frequency for the incoming ring signal.</p> <table border="1"> <thead> <tr> <th><u>Country</u></th> <th><u>Default</u></th> </tr> </thead> <tbody> <tr> <td>United States</td> <td>68</td> </tr> <tr> <td>Canada (French)</td> <td>68</td> </tr> <tr> <td>Mexico</td> <td>68</td> </tr> <tr> <td>Australia</td> <td>58</td> </tr> <tr> <td>France</td> <td>60</td> </tr> <tr> <td>Germany</td> <td>60</td> </tr> <tr> <td>Netherlands</td> <td>55</td> </tr> <tr> <td>United Kingdom</td> <td>40</td> </tr> </tbody> </table>	<u>Country</u>	<u>Default</u>	United States	68	Canada (French)	68	Mexico	68	Australia	58	France	60	Germany	60	Netherlands	55	United Kingdom	40	1 Hz (10 Hz to 99 Hz)
<u>Country</u>	<u>Default</u>																			
United States	68																			
Canada (French)	68																			
Mexico	68																			
Australia	58																			
France	60																			
Germany	60																			
Netherlands	55																			
United Kingdom	40																			

Parameter #	Description	Units																		
8	<p>Ring envelope minimum ON time. Minimum time an entire ring signal must be present to be counted as 1 ring. The entire ring signal may consist of several ring bursts separated by periods of silence.</p> <table border="0"> <thead> <tr> <th><u>Country</u></th> <th><u>Default</u></th> </tr> </thead> <tbody> <tr> <td>United States</td> <td>150</td> </tr> <tr> <td>Canada (French)</td> <td>150</td> </tr> <tr> <td>Mexico</td> <td>150</td> </tr> <tr> <td>Australia</td> <td>180</td> </tr> <tr> <td>France</td> <td>500</td> </tr> <tr> <td>Germany</td> <td>250</td> </tr> <tr> <td>Netherlands</td> <td>300</td> </tr> <tr> <td>United Kingdom</td> <td>300</td> </tr> </tbody> </table>	<u>Country</u>	<u>Default</u>	United States	150	Canada (French)	150	Mexico	150	Australia	180	France	500	Germany	250	Netherlands	300	United Kingdom	300	1 ms (50 ms to 10000 ms)
<u>Country</u>	<u>Default</u>																			
United States	150																			
Canada (French)	150																			
Mexico	150																			
Australia	180																			
France	500																			
Germany	250																			
Netherlands	300																			
United Kingdom	300																			
9	<p>Ring envelope maximum ON time. Maximum time an entire ring signal can be present to be counted as 1 ring. The entire ring signal may consist of several ring bursts separated by periods of silence.</p> <table border="0"> <thead> <tr> <th><u>Country</u></th> <th><u>Default</u></th> </tr> </thead> <tbody> <tr> <td>United States</td> <td>8000</td> </tr> <tr> <td>Canada (French)</td> <td>8000</td> </tr> <tr> <td>Mexico</td> <td>8000</td> </tr> <tr> <td>Australia</td> <td>8000</td> </tr> <tr> <td>France</td> <td>8000</td> </tr> <tr> <td>Germany</td> <td>8000</td> </tr> <tr> <td>Netherlands</td> <td>8000</td> </tr> <tr> <td>United Kingdom</td> <td>8000</td> </tr> </tbody> </table>	<u>Country</u>	<u>Default</u>	United States	8000	Canada (French)	8000	Mexico	8000	Australia	8000	France	8000	Germany	8000	Netherlands	8000	United Kingdom	8000	1 ms (50 ms to 10000 ms)
<u>Country</u>	<u>Default</u>																			
United States	8000																			
Canada (French)	8000																			
Mexico	8000																			
Australia	8000																			
France	8000																			
Germany	8000																			
Netherlands	8000																			
United Kingdom	8000																			
10	<p>Ring envelope minimum OFF time. Minimum time between ring envelopes, where each ring envelope may consist of a single or multiple rings. Once this time has expired the ring count is incremented.</p> <table border="0"> <thead> <tr> <th><u>Country</u></th> <th><u>Default</u></th> </tr> </thead> <tbody> <tr> <td>United States</td> <td>1000</td> </tr> <tr> <td>Canada (French)</td> <td>1000</td> </tr> <tr> <td>Mexico</td> <td>1000</td> </tr> <tr> <td>Australia</td> <td>1000</td> </tr> <tr> <td>France</td> <td>1000</td> </tr> <tr> <td>Germany</td> <td>1000</td> </tr> <tr> <td>Netherlands</td> <td>2000</td> </tr> <tr> <td>United Kingdom</td> <td>1000</td> </tr> </tbody> </table>	<u>Country</u>	<u>Default</u>	United States	1000	Canada (French)	1000	Mexico	1000	Australia	1000	France	1000	Germany	1000	Netherlands	2000	United Kingdom	1000	1 ms (200 ms to 20000 ms)
<u>Country</u>	<u>Default</u>																			
United States	1000																			
Canada (French)	1000																			
Mexico	1000																			
Australia	1000																			
France	1000																			
Germany	1000																			
Netherlands	2000																			
United Kingdom	1000																			
11	<p>Ring envelope maximum OFF time. Maximum time between ring envelopes after which the ring count is reset to zero. When this period of silence has expired all ringing is considered complete.</p> <table border="0"> <thead> <tr> <th><u>Country</u></th> <th><u>Default</u></th> </tr> </thead> <tbody> <tr> <td>United States</td> <td>8000</td> </tr> <tr> <td>Canada (French)</td> <td>8000</td> </tr> <tr> <td>Mexico</td> <td>8000</td> </tr> <tr> <td>Australia</td> <td>8000</td> </tr> <tr> <td>France</td> <td>7000</td> </tr> <tr> <td>Germany</td> <td>8000</td> </tr> <tr> <td>Netherlands</td> <td>8000</td> </tr> <tr> <td>United Kingdom</td> <td>8000</td> </tr> </tbody> </table>	<u>Country</u>	<u>Default</u>	United States	8000	Canada (French)	8000	Mexico	8000	Australia	8000	France	7000	Germany	8000	Netherlands	8000	United Kingdom	8000	1 ms (200 ms to 20000 ms)
<u>Country</u>	<u>Default</u>																			
United States	8000																			
Canada (French)	8000																			
Mexico	8000																			
Australia	8000																			
France	7000																			
Germany	8000																			
Netherlands	8000																			
United Kingdom	8000																			

Parameter #	Description	Units																		
12	<p>Ring burst minimum ON time. Minimum time a single ring signal must be active before it is counted. If this time is not exceeded the ring burst is ignored.</p> <table border="1"> <thead> <tr> <th><u>Country</u></th> <th><u>Default</u></th> </tr> </thead> <tbody> <tr><td>United States</td><td>100</td></tr> <tr><td>Canada (French)</td><td>100</td></tr> <tr><td>Mexico</td><td>100</td></tr> <tr><td>Australia</td><td>100</td></tr> <tr><td>France</td><td>100</td></tr> <tr><td>Germany</td><td>250</td></tr> <tr><td>Netherlands</td><td>100</td></tr> <tr><td>United Kingdom</td><td>100</td></tr> </tbody> </table>	<u>Country</u>	<u>Default</u>	United States	100	Canada (French)	100	Mexico	100	Australia	100	France	100	Germany	250	Netherlands	100	United Kingdom	100	1 ms (50 ms to 1000 ms)
<u>Country</u>	<u>Default</u>																			
United States	100																			
Canada (French)	100																			
Mexico	100																			
Australia	100																			
France	100																			
Germany	250																			
Netherlands	100																			
United Kingdom	100																			
14	<p>Ring burst minimum OFF time. Minimum time that must occur between two ring bursts if they are to be counted as two individual bursts.</p> <table border="1"> <thead> <tr> <th><u>Country</u></th> <th><u>Default</u></th> </tr> </thead> <tbody> <tr><td>United States</td><td>100</td></tr> <tr><td>Canada (French)</td><td>100</td></tr> <tr><td>Mexico</td><td>100</td></tr> <tr><td>Australia</td><td>100</td></tr> <tr><td>France</td><td>100</td></tr> <tr><td>Germany</td><td>250</td></tr> <tr><td>Netherlands</td><td>100</td></tr> <tr><td>United Kingdom</td><td>100</td></tr> </tbody> </table>	<u>Country</u>	<u>Default</u>	United States	100	Canada (French)	100	Mexico	100	Australia	100	France	100	Germany	250	Netherlands	100	United Kingdom	100	1 ms (50 ms to 1000 ms)
<u>Country</u>	<u>Default</u>																			
United States	100																			
Canada (French)	100																			
Mexico	100																			
Australia	100																			
France	100																			
Germany	250																			
Netherlands	100																			
United Kingdom	100																			
15	<p>Minimum number of rings. This is the minimum ring count the user can enter. This is used for data entry validation only.</p> <table border="1"> <thead> <tr> <th><u>Country</u></th> <th><u>Default</u></th> </tr> </thead> <tbody> <tr><td>United States</td><td>2</td></tr> <tr><td>Canada (French)</td><td>2</td></tr> <tr><td>Mexico</td><td>2</td></tr> <tr><td>Australia</td><td>1</td></tr> <tr><td>France</td><td>2</td></tr> <tr><td>Germany</td><td>2</td></tr> <tr><td>Netherlands</td><td>2</td></tr> <tr><td>United Kingdom</td><td>2</td></tr> </tbody> </table>	<u>Country</u>	<u>Default</u>	United States	2	Canada (French)	2	Mexico	2	Australia	1	France	2	Germany	2	Netherlands	2	United Kingdom	2	1 ring (1 ring to 15 rings)
<u>Country</u>	<u>Default</u>																			
United States	2																			
Canada (French)	2																			
Mexico	2																			
Australia	1																			
France	2																			
Germany	2																			
Netherlands	2																			
United Kingdom	2																			
16	<p>Maximum number of rings. This is the maximum ring count that the user can enter. This is used for data entry validation only.</p> <table border="1"> <thead> <tr> <th><u>Country</u></th> <th><u>Default</u></th> </tr> </thead> <tbody> <tr><td>United States</td><td>5</td></tr> <tr><td>Canada (French)</td><td>5</td></tr> <tr><td>Mexico</td><td>5</td></tr> <tr><td>Australia</td><td>5</td></tr> <tr><td>France</td><td>2</td></tr> <tr><td>Germany</td><td>5</td></tr> <tr><td>Netherlands</td><td>7</td></tr> <tr><td>United Kingdom</td><td>5</td></tr> </tbody> </table>	<u>Country</u>	<u>Default</u>	United States	5	Canada (French)	5	Mexico	5	Australia	5	France	2	Germany	5	Netherlands	7	United Kingdom	5	1 ring (1 ring to 15 rings)
<u>Country</u>	<u>Default</u>																			
United States	5																			
Canada (French)	5																			
Mexico	5																			
Australia	5																			
France	2																			
Germany	5																			
Netherlands	7																			
United Kingdom	5																			

Eavesdrop Detection and Automatic Answering

Parameter #	Description	Units																		
17*	<p>Eavesdrop enable. If TRUE then OfficeJet will attempt to detect an incoming fax when a downstream or parallel telephone (or TAM) answers. Selected by the user using the <Receive Mode> key..</p> <table border="0"> <thead> <tr> <th><u>Country</u></th> <th><u>Default</u></th> </tr> </thead> <tbody> <tr><td>United States</td><td>1</td></tr> <tr><td>Canada (French)</td><td>1</td></tr> <tr><td>Mexico</td><td>1</td></tr> <tr><td>Australia</td><td>1</td></tr> <tr><td>France</td><td>1</td></tr> <tr><td>Germany</td><td>1</td></tr> <tr><td>Netherlands</td><td>1</td></tr> <tr><td>United Kingdom</td><td>1</td></tr> </tbody> </table>	<u>Country</u>	<u>Default</u>	United States	1	Canada (French)	1	Mexico	1	Australia	1	France	1	Germany	1	Netherlands	1	United Kingdom	1	<p>0 = FALSE 1 = TRUE</p>
<u>Country</u>	<u>Default</u>																			
United States	1																			
Canada (French)	1																			
Mexico	1																			
Australia	1																			
France	1																			
Germany	1																			
Netherlands	1																			
United Kingdom	1																			
18*	<p>Silent detect enable. Incoming faxes are detected though the presence of CNG tone or a sufficient period of silence. If TRUE then silent detection is attempted. Selected by the user using the Fax Settings menu...</p> <table border="0"> <thead> <tr> <th><u>Country</u></th> <th><u>Default</u></th> </tr> </thead> <tbody> <tr><td>United States</td><td>0</td></tr> <tr><td>Canada (French)</td><td>0</td></tr> <tr><td>Mexico</td><td>0</td></tr> <tr><td>Australia</td><td>0</td></tr> <tr><td>France</td><td>0</td></tr> <tr><td>Germany</td><td>0</td></tr> <tr><td>Netherlands</td><td>0</td></tr> <tr><td>United Kingdom</td><td>0</td></tr> </tbody> </table>	<u>Country</u>	<u>Default</u>	United States	0	Canada (French)	0	Mexico	0	Australia	0	France	0	Germany	0	Netherlands	0	United Kingdom	0	<p>0 = FALSE 1 = TRUE</p>
<u>Country</u>	<u>Default</u>																			
United States	0																			
Canada (French)	0																			
Mexico	0																			
Australia	0																			
France	0																			
Germany	0																			
Netherlands	0																			
United Kingdom	0																			
19	<p>Parallel detect enable. If TRUE, then eavesdrop detection is attempted when either a parallel or downstream telephone (or TAM) answers. If FALSE then detection is attempted only with a downstream device.</p> <table border="0"> <thead> <tr> <th><u>Country</u></th> <th><u>Default</u></th> </tr> </thead> <tbody> <tr><td>United States</td><td>1</td></tr> <tr><td>Canada (French)</td><td>1</td></tr> <tr><td>Mexico</td><td>1</td></tr> <tr><td>Australia</td><td>1</td></tr> <tr><td>France</td><td>1</td></tr> <tr><td>Germany</td><td>1</td></tr> <tr><td>Netherlands</td><td>1</td></tr> <tr><td>United Kingdom</td><td>1</td></tr> </tbody> </table>	<u>Country</u>	<u>Default</u>	United States	1	Canada (French)	1	Mexico	1	Australia	1	France	1	Germany	1	Netherlands	1	United Kingdom	1	<p>0 = FALSE 1 = TRUE</p>
<u>Country</u>	<u>Default</u>																			
United States	1																			
Canada (French)	1																			
Mexico	1																			
Australia	1																			
France	1																			
Germany	1																			
Netherlands	1																			
United Kingdom	1																			
20	<p>Eavesdrop evaluation time. Eavesdrop is automatically started (and restarted) when each ring ends. It is automatically deactivated after this time.</p> <table border="0"> <thead> <tr> <th><u>Country</u></th> <th><u>Default</u></th> </tr> </thead> <tbody> <tr><td>United States</td><td>60</td></tr> <tr><td>Canada (French)</td><td>60</td></tr> <tr><td>Mexico</td><td>60</td></tr> <tr><td>Australia</td><td>60</td></tr> <tr><td>France</td><td>30</td></tr> <tr><td>Germany</td><td>60</td></tr> <tr><td>Netherlands</td><td>60</td></tr> <tr><td>United Kingdom</td><td>60</td></tr> </tbody> </table>	<u>Country</u>	<u>Default</u>	United States	60	Canada (French)	60	Mexico	60	Australia	60	France	30	Germany	60	Netherlands	60	United Kingdom	60	<p>1 sec (10 sec to 120 sec)</p>
<u>Country</u>	<u>Default</u>																			
United States	60																			
Canada (French)	60																			
Mexico	60																			
Australia	60																			
France	30																			
Germany	60																			
Netherlands	60																			
United Kingdom	60																			

Parameter #	Description	Units																		
21	<p>Calling tone minimum ON time. Minimum time a CNG tone must be present for the tone sequence to be valid.</p> <table border="1"> <thead> <tr> <th><u>Country</u></th> <th><u>Default</u></th> </tr> </thead> <tbody> <tr> <td>United States</td> <td>350</td> </tr> <tr> <td>Canada (French)</td> <td>350</td> </tr> <tr> <td>Mexico</td> <td>350</td> </tr> <tr> <td>Australia</td> <td>350</td> </tr> <tr> <td>France</td> <td>350</td> </tr> <tr> <td>Germany</td> <td>350</td> </tr> <tr> <td>Netherlands</td> <td>350</td> </tr> <tr> <td>United Kingdom</td> <td>350</td> </tr> </tbody> </table>	<u>Country</u>	<u>Default</u>	United States	350	Canada (French)	350	Mexico	350	Australia	350	France	350	Germany	350	Netherlands	350	United Kingdom	350	1 ms (100 ms to 1000 ms)
<u>Country</u>	<u>Default</u>																			
United States	350																			
Canada (French)	350																			
Mexico	350																			
Australia	350																			
France	350																			
Germany	350																			
Netherlands	350																			
United Kingdom	350																			
22	<p>Calling tone maximum ON time. Maximum time a CNG tone can be present for the tone sequence to be valid.</p> <table border="1"> <thead> <tr> <th><u>Country</u></th> <th><u>Default</u></th> </tr> </thead> <tbody> <tr> <td>United States</td> <td>800</td> </tr> <tr> <td>Canada (French)</td> <td>800</td> </tr> <tr> <td>Mexico</td> <td>800</td> </tr> <tr> <td>Australia</td> <td>800</td> </tr> <tr> <td>France</td> <td>800</td> </tr> <tr> <td>Germany</td> <td>800</td> </tr> <tr> <td>Netherlands</td> <td>800</td> </tr> <tr> <td>United Kingdom</td> <td>800</td> </tr> </tbody> </table>	<u>Country</u>	<u>Default</u>	United States	800	Canada (French)	800	Mexico	800	Australia	800	France	800	Germany	800	Netherlands	800	United Kingdom	800	1 ms (100 ms to 1000 ms)
<u>Country</u>	<u>Default</u>																			
United States	800																			
Canada (French)	800																			
Mexico	800																			
Australia	800																			
France	800																			
Germany	800																			
Netherlands	800																			
United Kingdom	800																			
23	<p>Calling tone minimum OFF time. Minimum period of silence that must exist between CNG tones for the tone sequence to be valid.</p> <table border="1"> <thead> <tr> <th><u>Country</u></th> <th><u>Default</u></th> </tr> </thead> <tbody> <tr> <td>United States</td> <td>2000</td> </tr> <tr> <td>Canada (French)</td> <td>2000</td> </tr> <tr> <td>Mexico</td> <td>2000</td> </tr> <tr> <td>Australia</td> <td>2000</td> </tr> <tr> <td>France</td> <td>2000</td> </tr> <tr> <td>Germany</td> <td>2000</td> </tr> <tr> <td>Netherlands</td> <td>2000</td> </tr> <tr> <td>United Kingdom</td> <td>2000</td> </tr> </tbody> </table>	<u>Country</u>	<u>Default</u>	United States	2000	Canada (French)	2000	Mexico	2000	Australia	2000	France	2000	Germany	2000	Netherlands	2000	United Kingdom	2000	1 ms (1000 ms to 15000 ms)
<u>Country</u>	<u>Default</u>																			
United States	2000																			
Canada (French)	2000																			
Mexico	2000																			
Australia	2000																			
France	2000																			
Germany	2000																			
Netherlands	2000																			
United Kingdom	2000																			
24	<p>Calling tone maximum OFF time. Maximum period of silence that can exist between CNG tones for the tone sequence to be valid.</p> <table border="1"> <thead> <tr> <th><u>Country</u></th> <th><u>Default</u></th> </tr> </thead> <tbody> <tr> <td>United States</td> <td>8000</td> </tr> <tr> <td>Canada (French)</td> <td>8000</td> </tr> <tr> <td>Mexico</td> <td>8000</td> </tr> <tr> <td>Australia</td> <td>8000</td> </tr> <tr> <td>France</td> <td>8000</td> </tr> <tr> <td>Germany</td> <td>8000</td> </tr> <tr> <td>Netherlands</td> <td>8000</td> </tr> <tr> <td>United Kingdom</td> <td>8000</td> </tr> </tbody> </table>	<u>Country</u>	<u>Default</u>	United States	8000	Canada (French)	8000	Mexico	8000	Australia	8000	France	8000	Germany	8000	Netherlands	8000	United Kingdom	8000	1 ms (1000 ms to 15000 ms)
<u>Country</u>	<u>Default</u>																			
United States	8000																			
Canada (French)	8000																			
Mexico	8000																			
Australia	8000																			
France	8000																			
Germany	8000																			
Netherlands	8000																			
United Kingdom	8000																			

Parameter #	Description	Units																		
25	<p>Calling tone maximum dropout time. Maximum duration of dropout which can interrupt a CNG tone. If the dropout is less than this time, then the CNG tone will be processed as a single continuous tone.</p> <table border="0"> <thead> <tr> <th><u>Country</u></th> <th><u>Default</u></th> </tr> </thead> <tbody> <tr> <td>United States</td> <td>100</td> </tr> <tr> <td>Canada (French)</td> <td>100</td> </tr> <tr> <td>Mexico</td> <td>100</td> </tr> <tr> <td>Australia</td> <td>100</td> </tr> <tr> <td>France</td> <td>100</td> </tr> <tr> <td>Germany</td> <td>100</td> </tr> <tr> <td>Netherlands</td> <td>100</td> </tr> <tr> <td>United Kingdom</td> <td>100</td> </tr> </tbody> </table>	<u>Country</u>	<u>Default</u>	United States	100	Canada (French)	100	Mexico	100	Australia	100	France	100	Germany	100	Netherlands	100	United Kingdom	100	1 ms (0 ms to 500 ms)
<u>Country</u>	<u>Default</u>																			
United States	100																			
Canada (French)	100																			
Mexico	100																			
Australia	100																			
France	100																			
Germany	100																			
Netherlands	100																			
United Kingdom	100																			
26	<p>Calling tone minimum count. Minimum number of CNG tones that must be detected for an incoming fax to be detected.</p> <table border="0"> <thead> <tr> <th><u>Country</u></th> <th><u>Default</u></th> </tr> </thead> <tbody> <tr> <td>United States</td> <td>2</td> </tr> <tr> <td>Canada (French)</td> <td>2</td> </tr> <tr> <td>Mexico</td> <td>2</td> </tr> <tr> <td>Australia</td> <td>2</td> </tr> <tr> <td>France</td> <td>1</td> </tr> <tr> <td>Germany</td> <td>2</td> </tr> <tr> <td>Netherlands</td> <td>2</td> </tr> <tr> <td>United Kingdom</td> <td>2</td> </tr> </tbody> </table>	<u>Country</u>	<u>Default</u>	United States	2	Canada (French)	2	Mexico	2	Australia	2	France	1	Germany	2	Netherlands	2	United Kingdom	2	1 tone (1 tone to 15 tones)
<u>Country</u>	<u>Default</u>																			
United States	2																			
Canada (French)	2																			
Mexico	2																			
Australia	2																			
France	1																			
Germany	2																			
Netherlands	2																			
United Kingdom	2																			
27	<p>Calling tone detect threshold. Sets the detection threshold for any received CNG tone. If the CNG tone is below this level it will not be detected.</p> <table border="0"> <thead> <tr> <th><u>Country</u></th> <th><u>Default</u></th> </tr> </thead> <tbody> <tr> <td>United States</td> <td>350 (-0.1 dBm)</td> </tr> <tr> <td>Canada (French)</td> <td>350 (-0.1 dBm)</td> </tr> <tr> <td>Mexico</td> <td>350 (-0.1 dBm)</td> </tr> <tr> <td>Australia</td> <td>350 (-0.1 dBm)</td> </tr> <tr> <td>France</td> <td>450 (-0.1 dBm)</td> </tr> <tr> <td>Germany</td> <td>350 (-0.1 dBm)</td> </tr> <tr> <td>Netherlands</td> <td>350 (-0.1 dBm)</td> </tr> <tr> <td>United Kingdom</td> <td>350 (-0.1 dBm)</td> </tr> </tbody> </table>	<u>Country</u>	<u>Default</u>	United States	350 (-0.1 dBm)	Canada (French)	350 (-0.1 dBm)	Mexico	350 (-0.1 dBm)	Australia	350 (-0.1 dBm)	France	450 (-0.1 dBm)	Germany	350 (-0.1 dBm)	Netherlands	350 (-0.1 dBm)	United Kingdom	350 (-0.1 dBm)	10 (260 to 510)
<u>Country</u>	<u>Default</u>																			
United States	350 (-0.1 dBm)																			
Canada (French)	350 (-0.1 dBm)																			
Mexico	350 (-0.1 dBm)																			
Australia	350 (-0.1 dBm)																			
France	450 (-0.1 dBm)																			
Germany	350 (-0.1 dBm)																			
Netherlands	350 (-0.1 dBm)																			
United Kingdom	350 (-0.1 dBm)																			
28	<p>Silence minimum time. An incoming fax will be detected if this period of silence is detected. Silent detection is only intended to apply to downstream TADs. Silent detection will only start after an OGM has been detected and if downstream activity is detected.</p> <table border="0"> <thead> <tr> <th><u>Country</u></th> <th><u>Default</u></th> </tr> </thead> <tbody> <tr> <td>United States</td> <td>3000</td> </tr> <tr> <td>Canada (French)</td> <td>3000</td> </tr> <tr> <td>Mexico</td> <td>3000</td> </tr> <tr> <td>Australia</td> <td>3000</td> </tr> <tr> <td>France</td> <td>3000</td> </tr> <tr> <td>Germany</td> <td>3000</td> </tr> <tr> <td>Netherlands</td> <td>3000</td> </tr> <tr> <td>United Kingdom</td> <td>3000</td> </tr> </tbody> </table>	<u>Country</u>	<u>Default</u>	United States	3000	Canada (French)	3000	Mexico	3000	Australia	3000	France	3000	Germany	3000	Netherlands	3000	United Kingdom	3000	1 ms (1000 ms to 15000 ms)
<u>Country</u>	<u>Default</u>																			
United States	3000																			
Canada (French)	3000																			
Mexico	3000																			
Australia	3000																			
France	3000																			
Germany	3000																			
Netherlands	3000																			
United Kingdom	3000																			

Parameter #	Description	Units																		
29	<p>FAX TAM interface enable. If TRUE then the user will be able to select FAX/TAM as a receive configuration. If FALSE the FAX/TAM selections will not be seen by the user when selecting a receive mode. Intended for countries which do not allow FAX/TAM support.</p> <table border="1"> <thead> <tr> <th><u>Country</u></th> <th><u>Default</u></th> </tr> </thead> <tbody> <tr><td>United States</td><td>1</td></tr> <tr><td>Canada (French)</td><td>1</td></tr> <tr><td>Mexico</td><td>1</td></tr> <tr><td>Australia</td><td>1</td></tr> <tr><td>France</td><td>1</td></tr> <tr><td>Germany</td><td>1</td></tr> <tr><td>Netherlands</td><td>1</td></tr> <tr><td>United Kingdom</td><td>1</td></tr> </tbody> </table>	<u>Country</u>	<u>Default</u>	United States	1	Canada (French)	1	Mexico	1	Australia	1	France	1	Germany	1	Netherlands	1	United Kingdom	1	0 = FALSE 1 = TRUE
<u>Country</u>	<u>Default</u>																			
United States	1																			
Canada (French)	1																			
Mexico	1																			
Australia	1																			
France	1																			
Germany	1																			
Netherlands	1																			
United Kingdom	1																			
30	<p>Calling tone auto stop enable. If TRUE, OfficeJet will stop transmitting the CNG signal as soon as 750 ms of an incoming CED signal has been detected. If this value is FALSE, it will transmit the CNG signal until T30 frames are detected.</p> <table border="1"> <thead> <tr> <th><u>Country</u></th> <th><u>Default</u></th> </tr> </thead> <tbody> <tr><td>United States</td><td>0</td></tr> <tr><td>Canada (French)</td><td>0</td></tr> <tr><td>Mexico</td><td>0</td></tr> <tr><td>Australia</td><td>0</td></tr> <tr><td>France</td><td>1</td></tr> <tr><td>Germany</td><td>0</td></tr> <tr><td>Netherlands</td><td>0</td></tr> <tr><td>United Kingdom</td><td>0</td></tr> </tbody> </table>	<u>Country</u>	<u>Default</u>	United States	0	Canada (French)	0	Mexico	0	Australia	0	France	1	Germany	0	Netherlands	0	United Kingdom	0	0 = FALSE 1 = TRUE
<u>Country</u>	<u>Default</u>																			
United States	0																			
Canada (French)	0																			
Mexico	0																			
Australia	0																			
France	1																			
Germany	0																			
Netherlands	0																			
United Kingdom	0																			

Connection Establishment

Parameter #	Description	Units																		
31	<p>Line seizure delay timer. Specifies the minimum time between the completion of an outgoing or incoming call and the automatic dialing of the next outgoing call.</p> <table border="1"> <thead> <tr> <th><u>Country</u></th> <th><u>Default</u></th> </tr> </thead> <tbody> <tr><td>United States</td><td>5000</td></tr> <tr><td>Canada (French)</td><td>5000</td></tr> <tr><td>Mexico</td><td>5000</td></tr> <tr><td>Australia</td><td>5000</td></tr> <tr><td>France</td><td>6500</td></tr> <tr><td>Germany</td><td>7000</td></tr> <tr><td>Netherlands</td><td>7000</td></tr> <tr><td>United Kingdom</td><td>3500</td></tr> </tbody> </table>	<u>Country</u>	<u>Default</u>	United States	5000	Canada (French)	5000	Mexico	5000	Australia	5000	France	6500	Germany	7000	Netherlands	7000	United Kingdom	3500	1 ms (0 ms to 15000 ms)
<u>Country</u>	<u>Default</u>																			
United States	5000																			
Canada (French)	5000																			
Mexico	5000																			
Australia	5000																			
France	6500																			
Germany	7000																			
Netherlands	7000																			
United Kingdom	3500																			
32	<p>Pre OFF hook shunt. Defines the time the LIU shunt will be active. The shunt is activated just prior to when OfficeJet goes OFF hook. Not supported by all LIUs.</p> <table border="1"> <thead> <tr> <th><u>Country</u></th> <th><u>Default</u></th> </tr> </thead> <tbody> <tr><td>United States</td><td>0</td></tr> <tr><td>Canada (French)</td><td>0</td></tr> <tr><td>Mexico</td><td>0</td></tr> <tr><td>Australia</td><td>325</td></tr> <tr><td>France</td><td>0</td></tr> <tr><td>Germany</td><td>0</td></tr> <tr><td>Netherlands</td><td>0</td></tr> <tr><td>United Kingdom</td><td>0</td></tr> </tbody> </table>	<u>Country</u>	<u>Default</u>	United States	0	Canada (French)	0	Mexico	0	Australia	325	France	0	Germany	0	Netherlands	0	United Kingdom	0	1 ms (0 ms to 1000 ms)
<u>Country</u>	<u>Default</u>																			
United States	0																			
Canada (French)	0																			
Mexico	0																			
Australia	325																			
France	0																			
Germany	0																			
Netherlands	0																			
United Kingdom	0																			

Parameter #	Description	Units																		
34	<p>Modem loop current failure test enable. Controls is a modem loop current test is performed after OfficeJet has dialed a number or after it has answered an incoming call. If TRUE it will continuously test for the absence of loop current. If no loop current is detected the fax session will be aborted.</p> <table border="0"> <thead> <tr> <th><u>Country</u></th> <th><u>Default</u></th> </tr> </thead> <tbody> <tr><td>United States</td><td>0</td></tr> <tr><td>Canada (French)</td><td>0</td></tr> <tr><td>Mexico</td><td>0</td></tr> <tr><td>Australia</td><td>0</td></tr> <tr><td>France</td><td>0</td></tr> <tr><td>Germany</td><td>0</td></tr> <tr><td>Netherlands</td><td>0</td></tr> <tr><td>United Kingdom</td><td>0</td></tr> </tbody> </table>	<u>Country</u>	<u>Default</u>	United States	0	Canada (French)	0	Mexico	0	Australia	0	France	0	Germany	0	Netherlands	0	United Kingdom	0	0 = FALSE 1 = TRUE
<u>Country</u>	<u>Default</u>																			
United States	0																			
Canada (French)	0																			
Mexico	0																			
Australia	0																			
France	0																			
Germany	0																			
Netherlands	0																			
United Kingdom	0																			
35	<p>Modem loop current test enable. Controls if a modem loop current test is performed after OfficeJet has connected to the external line and before dialing is started.. If TRUE, OfficeJet will test for the presence of loop current after going OFF hook prior to dialing. If loop current is not detected, the fax session is aborted.</p> <table border="0"> <thead> <tr> <th><u>Country</u></th> <th><u>Default</u></th> </tr> </thead> <tbody> <tr><td>United States</td><td>0</td></tr> <tr><td>Canada (French)</td><td>0</td></tr> <tr><td>Mexico</td><td>0</td></tr> <tr><td>Australia</td><td>1</td></tr> <tr><td>France</td><td>1</td></tr> <tr><td>Germany</td><td>1</td></tr> <tr><td>Netherlands</td><td>1</td></tr> <tr><td>United Kingdom</td><td>1</td></tr> </tbody> </table>	<u>Country</u>	<u>Default</u>	United States	0	Canada (French)	0	Mexico	0	Australia	1	France	1	Germany	1	Netherlands	1	United Kingdom	1	0 = FALSE 1 = TRUE
<u>Country</u>	<u>Default</u>																			
United States	0																			
Canada (French)	0																			
Mexico	0																			
Australia	1																			
France	1																			
Germany	1																			
Netherlands	1																			
United Kingdom	1																			
36	<p>Modem loop current detection time minimum. Minimum time that continuous modem loop current must be present when the machine fist connects and a loop current test is performed. Also, this is the minimum time that loop current must be absent once dialing has completed, when performing the loop current failure test.</p> <table border="0"> <thead> <tr> <th><u>Country</u></th> <th><u>Default</u></th> </tr> </thead> <tbody> <tr><td>United States</td><td>0</td></tr> <tr><td>Canada (French)</td><td>0</td></tr> <tr><td>Mexico</td><td>0</td></tr> <tr><td>Australia</td><td>200</td></tr> <tr><td>France</td><td>250</td></tr> <tr><td>Germany</td><td>200</td></tr> <tr><td>Netherlands</td><td>200</td></tr> <tr><td>United Kingdom</td><td>200</td></tr> </tbody> </table>	<u>Country</u>	<u>Default</u>	United States	0	Canada (French)	0	Mexico	0	Australia	200	France	250	Germany	200	Netherlands	200	United Kingdom	200	1 ms (0 ms to 15000 ms)
<u>Country</u>	<u>Default</u>																			
United States	0																			
Canada (French)	0																			
Mexico	0																			
Australia	200																			
France	250																			
Germany	200																			
Netherlands	200																			
United Kingdom	200																			

Parameter #	Description	Units																		
37	<p>Modem loop current detection delay. The delay that occurs before starting the loop current failure test. Allows time for the network to settle after dialing and prevents "open switch interrupts" from falsely being interpreted as problems with the connection.</p> <table border="0"> <thead> <tr> <th><u>Country</u></th> <th><u>Default</u></th> </tr> </thead> <tbody> <tr> <td>United States</td> <td>0</td> </tr> <tr> <td>Canada (French)</td> <td>0</td> </tr> <tr> <td>Mexico</td> <td>0</td> </tr> <tr> <td>Australia</td> <td>10000</td> </tr> <tr> <td>France</td> <td>10000</td> </tr> <tr> <td>Germany</td> <td>10000</td> </tr> <tr> <td>Netherlands</td> <td>10000</td> </tr> <tr> <td>United Kingdom</td> <td>10000</td> </tr> </tbody> </table>	<u>Country</u>	<u>Default</u>	United States	0	Canada (French)	0	Mexico	0	Australia	10000	France	10000	Germany	10000	Netherlands	10000	United Kingdom	10000	1 ms (0 ms to 15000 ms)
<u>Country</u>	<u>Default</u>																			
United States	0																			
Canada (French)	0																			
Mexico	0																			
Australia	10000																			
France	10000																			
Germany	10000																			
Netherlands	10000																			
United Kingdom	10000																			
38	<p>Modem loop current evaluation time. Maximum time the machine will wait for loop current before dialing when performing a loop current test.</p> <table border="0"> <thead> <tr> <th><u>Country</u></th> <th><u>Default</u></th> </tr> </thead> <tbody> <tr> <td>United States</td> <td>0</td> </tr> <tr> <td>Canada (French)</td> <td>0</td> </tr> <tr> <td>Mexico</td> <td>0</td> </tr> <tr> <td>Australia</td> <td>4000</td> </tr> <tr> <td>France</td> <td>4000</td> </tr> <tr> <td>Germany</td> <td>4000</td> </tr> <tr> <td>Netherlands</td> <td>4000</td> </tr> <tr> <td>United Kingdom</td> <td>4000</td> </tr> </tbody> </table>	<u>Country</u>	<u>Default</u>	United States	0	Canada (French)	0	Mexico	0	Australia	4000	France	4000	Germany	4000	Netherlands	4000	United Kingdom	4000	1 ms (0 ms to 15000 ms)
<u>Country</u>	<u>Default</u>																			
United States	0																			
Canada (French)	0																			
Mexico	0																			
Australia	4000																			
France	4000																			
Germany	4000																			
Netherlands	4000																			
United Kingdom	4000																			
39	<p>Telset loop current test enable. Controls whether a telset loop current test is performed before OfficeJet is connected to the external line. The presence of loop current would indicate that a downstream telephone is active. If TRUE, the machine will check for telset loop current.</p> <table border="0"> <thead> <tr> <th><u>Country</u></th> <th><u>Default</u></th> </tr> </thead> <tbody> <tr> <td>United States</td> <td>1</td> </tr> <tr> <td>Canada (French)</td> <td>1</td> </tr> <tr> <td>Mexico</td> <td>1</td> </tr> <tr> <td>Australia</td> <td>1</td> </tr> <tr> <td>France</td> <td>1</td> </tr> <tr> <td>Germany</td> <td>1</td> </tr> <tr> <td>Netherlands</td> <td>1</td> </tr> <tr> <td>United Kingdom</td> <td>1</td> </tr> </tbody> </table>	<u>Country</u>	<u>Default</u>	United States	1	Canada (French)	1	Mexico	1	Australia	1	France	1	Germany	1	Netherlands	1	United Kingdom	1	0 = FALSE 1 = TRUE
<u>Country</u>	<u>Default</u>																			
United States	1																			
Canada (French)	1																			
Mexico	1																			
Australia	1																			
France	1																			
Germany	1																			
Netherlands	1																			
United Kingdom	1																			
40	<p>Telset loop current detection time minimum. Minimum time that continuous telset loop current must be absent to be evaluated as absent. Once absent the line is considered available.</p> <table border="0"> <thead> <tr> <th><u>Country</u></th> <th><u>Default</u></th> </tr> </thead> <tbody> <tr> <td>United States</td> <td>1000</td> </tr> <tr> <td>Canada (French)</td> <td>1000</td> </tr> <tr> <td>Mexico</td> <td>1000</td> </tr> <tr> <td>Australia</td> <td>1000</td> </tr> <tr> <td>France</td> <td>5000</td> </tr> <tr> <td>Germany</td> <td>1000</td> </tr> <tr> <td>Netherlands</td> <td>1000</td> </tr> <tr> <td>United Kingdom</td> <td>1000</td> </tr> </tbody> </table>	<u>Country</u>	<u>Default</u>	United States	1000	Canada (French)	1000	Mexico	1000	Australia	1000	France	5000	Germany	1000	Netherlands	1000	United Kingdom	1000	1 ms (50 ms to 15000 ms)
<u>Country</u>	<u>Default</u>																			
United States	1000																			
Canada (French)	1000																			
Mexico	1000																			
Australia	1000																			
France	5000																			
Germany	1000																			
Netherlands	1000																			
United Kingdom	1000																			

Pause Control

Parameter #	Description	Units																		
41	<p>Pre dial pause mode. Specifies what type of pause OfficeJet will perform before dialing. If BLIND WAIT, the WAIT BEFORE BLIND DIALING delay will be used before dialing. If CHECK FOR TONE, a PSTN dial tone must be detected before dialing. If CHECK FOR SPECIAL TONE, a special dial tone must be present. If CHECK FOR TONE OR BUSY, either a PSTN dial tone or busy tone must be detected. If a busy tone is found, the call will be aborted.</p> <table border="1"> <thead> <tr> <th><u>Country</u></th> <th><u>Default</u></th> </tr> </thead> <tbody> <tr> <td>United States</td> <td>0</td> </tr> <tr> <td>Canada (French)</td> <td>0</td> </tr> <tr> <td>Mexico</td> <td>0</td> </tr> <tr> <td>Australia</td> <td>0</td> </tr> <tr> <td>France</td> <td>1</td> </tr> <tr> <td>Germany</td> <td>1</td> </tr> <tr> <td>Netherlands</td> <td>1</td> </tr> <tr> <td>United Kingdom</td> <td>0</td> </tr> </tbody> </table>	<u>Country</u>	<u>Default</u>	United States	0	Canada (French)	0	Mexico	0	Australia	0	France	1	Germany	1	Netherlands	1	United Kingdom	0	0 = BLIND WAIT 1 = CHECK FOR TONE 2 = CHECK FOR SPCL TONE 3 = CHECK FOR TONE OR BUSY
<u>Country</u>	<u>Default</u>																			
United States	0																			
Canada (French)	0																			
Mexico	0																			
Australia	0																			
France	1																			
Germany	1																			
Netherlands	1																			
United Kingdom	0																			
42	<p>Inter dial pause mode. Determines how a pause character in a dial string is processed. If BLIND WAIT, then the character is processed as a simple delay of duration TIME OF EACH PAUSE. If CHECK FOR TONE, then the character is processed as a wait for PSTN dial tone. If CHECK FOR SPECIAL TONE, then the character is processed as a wait for special dial tone.</p> <table border="1"> <thead> <tr> <th><u>Country</u></th> <th><u>Default</u></th> </tr> </thead> <tbody> <tr> <td>United States</td> <td>0</td> </tr> <tr> <td>Canada (French)</td> <td>0</td> </tr> <tr> <td>Mexico</td> <td>0</td> </tr> <tr> <td>Australia</td> <td>0</td> </tr> <tr> <td>France</td> <td>2</td> </tr> <tr> <td>Germany</td> <td>0</td> </tr> <tr> <td>Netherlands</td> <td>0</td> </tr> <tr> <td>United Kingdom</td> <td>0</td> </tr> </tbody> </table>	<u>Country</u>	<u>Default</u>	United States	0	Canada (French)	0	Mexico	0	Australia	0	France	2	Germany	0	Netherlands	0	United Kingdom	0	0 = BLIND WAIT 1 = CHECK FOR TONE 2 = CHECK FOR SPCL TONE
<u>Country</u>	<u>Default</u>																			
United States	0																			
Canada (French)	0																			
Mexico	0																			
Australia	0																			
France	2																			
Germany	0																			
Netherlands	0																			
United Kingdom	0																			
43	<p>Wait before blind dialing. Delay from OFF hook to the start of dialing when blind dialing.</p> <table border="1"> <thead> <tr> <th><u>Country</u></th> <th><u>Default</u></th> </tr> </thead> <tbody> <tr> <td>United States</td> <td>2000</td> </tr> <tr> <td>Canada (French)</td> <td>2000</td> </tr> <tr> <td>Mexico</td> <td>2000</td> </tr> <tr> <td>Australia</td> <td>2200</td> </tr> <tr> <td>France</td> <td>2000</td> </tr> <tr> <td>Germany</td> <td>2500</td> </tr> <tr> <td>Netherlands</td> <td>5000</td> </tr> <tr> <td>United Kingdom</td> <td>4000</td> </tr> </tbody> </table>	<u>Country</u>	<u>Default</u>	United States	2000	Canada (French)	2000	Mexico	2000	Australia	2200	France	2000	Germany	2500	Netherlands	5000	United Kingdom	4000	1 ms (500 ms to 15000 ms)
<u>Country</u>	<u>Default</u>																			
United States	2000																			
Canada (French)	2000																			
Mexico	2000																			
Australia	2200																			
France	2000																			
Germany	2500																			
Netherlands	5000																			
United Kingdom	4000																			

Parameter #	Description	Units																		
44	<p>Time of each pause. Duration of the delay when pause characters in a dial string are interpreted as delays.</p> <table border="1"> <thead> <tr> <th><u>Country</u></th> <th><u>Default</u></th> </tr> </thead> <tbody> <tr><td>United States</td><td>2000</td></tr> <tr><td>Canada (French)</td><td>2000</td></tr> <tr><td>Mexico</td><td>2000</td></tr> <tr><td>Australia</td><td>2000</td></tr> <tr><td>France</td><td>2000</td></tr> <tr><td>Germany</td><td>2000</td></tr> <tr><td>Netherlands</td><td>2000</td></tr> <tr><td>United Kingdom</td><td>2000</td></tr> </tbody> </table>	<u>Country</u>	<u>Default</u>	United States	2000	Canada (French)	2000	Mexico	2000	Australia	2000	France	2000	Germany	2000	Netherlands	2000	United Kingdom	2000	1 ms (500 ms to 8000 ms)
<u>Country</u>	<u>Default</u>																			
United States	2000																			
Canada (French)	2000																			
Mexico	2000																			
Australia	2000																			
France	2000																			
Germany	2000																			
Netherlands	2000																			
United Kingdom	2000																			
45	<p>Number of user entered pauses allowed. Maximum number of pauses that a user can enter in a dial string.</p> <table border="1"> <thead> <tr> <th><u>Country</u></th> <th><u>Default</u></th> </tr> </thead> <tbody> <tr><td>United States</td><td>6</td></tr> <tr><td>Canada (French)</td><td>6</td></tr> <tr><td>Mexico</td><td>6</td></tr> <tr><td>Australia</td><td>6</td></tr> <tr><td>France</td><td>1</td></tr> <tr><td>Germany</td><td>6</td></tr> <tr><td>Netherlands</td><td>6</td></tr> <tr><td>United Kingdom</td><td>6</td></tr> </tbody> </table>	<u>Country</u>	<u>Default</u>	United States	6	Canada (French)	6	Mexico	6	Australia	6	France	1	Germany	6	Netherlands	6	United Kingdom	6	1 pause (1 pause to 15 pauses)
<u>Country</u>	<u>Default</u>																			
United States	6																			
Canada (French)	6																			
Mexico	6																			
Australia	6																			
France	1																			
Germany	6																			
Netherlands	6																			
United Kingdom	6																			

Dial Tone Detection

Parameter #	Description	Units																		
46	<p>Maximum wait for all dial tone detection. Maximum total time that OfficeJet will wait for any dial tone.</p> <table border="1"> <thead> <tr> <th><u>Country</u></th> <th><u>Default</u></th> </tr> </thead> <tbody> <tr><td>United States</td><td>10000</td></tr> <tr><td>Canada (French)</td><td>10000</td></tr> <tr><td>Mexico</td><td>10000</td></tr> <tr><td>Australia</td><td>5000</td></tr> <tr><td>France</td><td>10000</td></tr> <tr><td>Germany</td><td>15000</td></tr> <tr><td>Netherlands</td><td>18000</td></tr> <tr><td>United Kingdom</td><td>8000</td></tr> </tbody> </table>	<u>Country</u>	<u>Default</u>	United States	10000	Canada (French)	10000	Mexico	10000	Australia	5000	France	10000	Germany	15000	Netherlands	18000	United Kingdom	8000	1 ms (1000 ms to 30000 ms)
<u>Country</u>	<u>Default</u>																			
United States	10000																			
Canada (French)	10000																			
Mexico	10000																			
Australia	5000																			
France	10000																			
Germany	15000																			
Netherlands	18000																			
United Kingdom	8000																			
47	<p>PSTN dial tone detect. Indicates the frequency combination that is used to identify a PSTN dial tone.</p> <table border="1"> <thead> <tr> <th><u>Country</u></th> <th><u>Default</u></th> </tr> </thead> <tbody> <tr><td>United States</td><td>5</td></tr> <tr><td>Canada (French)</td><td>5</td></tr> <tr><td>Mexico</td><td>5</td></tr> <tr><td>Australia</td><td>1</td></tr> <tr><td>France</td><td>9</td></tr> <tr><td>Germany</td><td>14</td></tr> <tr><td>Netherlands</td><td>9</td></tr> <tr><td>United Kingdom</td><td>5</td></tr> </tbody> </table>	<u>Country</u>	<u>Default</u>	United States	5	Canada (French)	5	Mexico	5	Australia	1	France	9	Germany	14	Netherlands	9	United Kingdom	5	1=1 2=2 3=1&2 5=1or2 6=1&2or3&4 7=1or2or3or4 8=1&2or3or4 9=1or2or3or4 10=1&2&3&4 11=1or2&3&4 12=1&2&3or4 13=1or2&3or4 14=1or2or3
<u>Country</u>	<u>Default</u>																			
United States	5																			
Canada (French)	5																			
Mexico	5																			
Australia	1																			
France	9																			
Germany	14																			
Netherlands	9																			
United Kingdom	5																			

Parameter #	Description	Units																		
48	<p>PSTN dial tone detection time minimum. Indicates the total time a PSTN dial tone sequence must be present for a PSTN dial tone to be detected.</p> <table border="0"> <thead> <tr> <th><u>Country</u></th> <th><u>Default</u></th> </tr> </thead> <tbody> <tr><td>United States</td><td>500</td></tr> <tr><td>Canada (French)</td><td>500</td></tr> <tr><td>Mexico</td><td>500</td></tr> <tr><td>Australia</td><td>1000</td></tr> <tr><td>France</td><td>1900</td></tr> <tr><td>Germany</td><td>2500</td></tr> <tr><td>Netherlands</td><td>1500</td></tr> <tr><td>United Kingdom</td><td>1000</td></tr> </tbody> </table>	<u>Country</u>	<u>Default</u>	United States	500	Canada (French)	500	Mexico	500	Australia	1000	France	1900	Germany	2500	Netherlands	1500	United Kingdom	1000	1 ms (100 ms to 15000 ms)
<u>Country</u>	<u>Default</u>																			
United States	500																			
Canada (French)	500																			
Mexico	500																			
Australia	1000																			
France	1900																			
Germany	2500																			
Netherlands	1500																			
United Kingdom	1000																			
49	<p>PSTN dial tone minimum on time. This is the minimum duration of a cadenced PSTN dial tone must be present for a cadenced sequence to be valid.</p> <table border="0"> <thead> <tr> <th><u>Country</u></th> <th><u>Default</u></th> </tr> </thead> <tbody> <tr><td>United States</td><td>500</td></tr> <tr><td>Canada (French)</td><td>500</td></tr> <tr><td>Mexico</td><td>500</td></tr> <tr><td>Australia</td><td>1000</td></tr> <tr><td>France</td><td>1900</td></tr> <tr><td>Germany</td><td>2500</td></tr> <tr><td>Netherlands</td><td>1500</td></tr> <tr><td>United Kingdom</td><td>1000</td></tr> </tbody> </table>	<u>Country</u>	<u>Default</u>	United States	500	Canada (French)	500	Mexico	500	Australia	1000	France	1900	Germany	2500	Netherlands	1500	United Kingdom	1000	1 ms (50 ms to 20000 ms)
<u>Country</u>	<u>Default</u>																			
United States	500																			
Canada (French)	500																			
Mexico	500																			
Australia	1000																			
France	1900																			
Germany	2500																			
Netherlands	1500																			
United Kingdom	1000																			
50	<p>PSTN dial tone minimum off time. The minimum period of silence that must exist between cadenced PSTN dial tones if the tone sequence is to be valid.</p> <table border="0"> <thead> <tr> <th><u>Country</u></th> <th><u>Default</u></th> </tr> </thead> <tbody> <tr><td>United States</td><td>0</td></tr> <tr><td>Canada (French)</td><td>0</td></tr> <tr><td>Mexico</td><td>0</td></tr> <tr><td>Australia</td><td>0</td></tr> <tr><td>France</td><td>0</td></tr> <tr><td>Germany</td><td>0</td></tr> <tr><td>Netherlands</td><td>0</td></tr> <tr><td>United Kingdom</td><td>0</td></tr> </tbody> </table>	<u>Country</u>	<u>Default</u>	United States	0	Canada (French)	0	Mexico	0	Australia	0	France	0	Germany	0	Netherlands	0	United Kingdom	0	1 ms (0 ms to 2000 ms)
<u>Country</u>	<u>Default</u>																			
United States	0																			
Canada (French)	0																			
Mexico	0																			
Australia	0																			
France	0																			
Germany	0																			
Netherlands	0																			
United Kingdom	0																			
51	<p>PSTN dial tone maximum off time. Maximum period of silence that can exist between cadenced PSTN dial tones if the tone sequence is to be valid.</p> <table border="0"> <thead> <tr> <th><u>Country</u></th> <th><u>Default</u></th> </tr> </thead> <tbody> <tr><td>United States</td><td>0</td></tr> <tr><td>Canada (French)</td><td>0</td></tr> <tr><td>Mexico</td><td>0</td></tr> <tr><td>Australia</td><td>0</td></tr> <tr><td>France</td><td>0</td></tr> <tr><td>Germany</td><td>0</td></tr> <tr><td>Netherlands</td><td>0</td></tr> <tr><td>United Kingdom</td><td>0</td></tr> </tbody> </table>	<u>Country</u>	<u>Default</u>	United States	0	Canada (French)	0	Mexico	0	Australia	0	France	0	Germany	0	Netherlands	0	United Kingdom	0	1 ms (0 ms to 2000 ms)
<u>Country</u>	<u>Default</u>																			
United States	0																			
Canada (French)	0																			
Mexico	0																			
Australia	0																			
France	0																			
Germany	0																			
Netherlands	0																			
United Kingdom	0																			

Parameter #	Description	Units																		
52	<p>PSTN dial tone detect threshold. Sets the detection threshold for a PSTN dial tone. If below this level, the PSTN tone will not be detected.</p> <table border="1"> <thead> <tr> <th><u>Country</u></th> <th><u>Default</u></th> </tr> </thead> <tbody> <tr> <td>United States</td> <td>320 (-0.1 dBm)</td> </tr> <tr> <td>Canada (French)</td> <td>320 (-0.1 dBm)</td> </tr> <tr> <td>Mexico</td> <td>320 (-0.1 dBm)</td> </tr> <tr> <td>Australia</td> <td>350 (-0.1 dBm)</td> </tr> <tr> <td>France</td> <td>400 (-0.1 dBm)</td> </tr> <tr> <td>Germany</td> <td>350 (-0.1 dBm)</td> </tr> <tr> <td>Netherlands</td> <td>380 (-0.1 dBm)</td> </tr> <tr> <td>United Kingdom</td> <td>320 (-0.1 dBm)</td> </tr> </tbody> </table>	<u>Country</u>	<u>Default</u>	United States	320 (-0.1 dBm)	Canada (French)	320 (-0.1 dBm)	Mexico	320 (-0.1 dBm)	Australia	350 (-0.1 dBm)	France	400 (-0.1 dBm)	Germany	350 (-0.1 dBm)	Netherlands	380 (-0.1 dBm)	United Kingdom	320 (-0.1 dBm)	1 (260 to 510)
<u>Country</u>	<u>Default</u>																			
United States	320 (-0.1 dBm)																			
Canada (French)	320 (-0.1 dBm)																			
Mexico	320 (-0.1 dBm)																			
Australia	350 (-0.1 dBm)																			
France	400 (-0.1 dBm)																			
Germany	350 (-0.1 dBm)																			
Netherlands	380 (-0.1 dBm)																			
United Kingdom	320 (-0.1 dBm)																			
53	<p>PSTN dial tone frequency 1. The center frequency for the first component of the PSTN dial tone.</p> <table border="1"> <thead> <tr> <th><u>Country</u></th> <th><u>Default</u></th> </tr> </thead> <tbody> <tr> <td>United States</td> <td>350</td> </tr> <tr> <td>Canada (French)</td> <td>350</td> </tr> <tr> <td>Mexico</td> <td>350</td> </tr> <tr> <td>Australia</td> <td>425</td> </tr> <tr> <td>France</td> <td>440</td> </tr> <tr> <td>Germany</td> <td>410</td> </tr> <tr> <td>Netherlands</td> <td>355</td> </tr> <tr> <td>United Kingdom</td> <td>350</td> </tr> </tbody> </table>	<u>Country</u>	<u>Default</u>	United States	350	Canada (French)	350	Mexico	350	Australia	425	France	440	Germany	410	Netherlands	355	United Kingdom	350	1 Hz (100 Hz to 1200 Hz)
<u>Country</u>	<u>Default</u>																			
United States	350																			
Canada (French)	350																			
Mexico	350																			
Australia	425																			
France	440																			
Germany	410																			
Netherlands	355																			
United Kingdom	350																			
54	<p>PSTN dial tone frequency 2. Center frequency for the second component of the PSTN dial tone.</p> <table border="1"> <thead> <tr> <th><u>Country</u></th> <th><u>Default</u></th> </tr> </thead> <tbody> <tr> <td>United States</td> <td>440</td> </tr> <tr> <td>Canada (French)</td> <td>440</td> </tr> <tr> <td>Mexico</td> <td>440</td> </tr> <tr> <td>Australia</td> <td>0</td> </tr> <tr> <td>France</td> <td>510</td> </tr> <tr> <td>Germany</td> <td>435</td> </tr> <tr> <td>Netherlands</td> <td>415</td> </tr> <tr> <td>United Kingdom</td> <td>440</td> </tr> </tbody> </table>	<u>Country</u>	<u>Default</u>	United States	440	Canada (French)	440	Mexico	440	Australia	0	France	510	Germany	435	Netherlands	415	United Kingdom	440	1 Hz (0 Hz to 1200 Hz)
<u>Country</u>	<u>Default</u>																			
United States	440																			
Canada (French)	440																			
Mexico	440																			
Australia	0																			
France	510																			
Germany	435																			
Netherlands	415																			
United Kingdom	440																			
55	<p>PSTN dial tone frequency 3. Center frequency for the third component of the PSTN dial tone.</p> <table border="1"> <thead> <tr> <th><u>Country</u></th> <th><u>Default</u></th> </tr> </thead> <tbody> <tr> <td>United States</td> <td>0</td> </tr> <tr> <td>Canada (French)</td> <td>0</td> </tr> <tr> <td>Mexico</td> <td>0</td> </tr> <tr> <td>Australia</td> <td>0</td> </tr> <tr> <td>France</td> <td>370</td> </tr> <tr> <td>Germany</td> <td>460</td> </tr> <tr> <td>Netherlands</td> <td>475</td> </tr> <tr> <td>United Kingdom</td> <td>0</td> </tr> </tbody> </table>	<u>Country</u>	<u>Default</u>	United States	0	Canada (French)	0	Mexico	0	Australia	0	France	370	Germany	460	Netherlands	475	United Kingdom	0	1 Hz (0 Hz to 1200 Hz)
<u>Country</u>	<u>Default</u>																			
United States	0																			
Canada (French)	0																			
Mexico	0																			
Australia	0																			
France	370																			
Germany	460																			
Netherlands	475																			
United Kingdom	0																			

Parameter #	Description	Units																		
56	<p>PSTN dial tone frequency 4. Center frequency for the fourth component of the PSTN dial tone.</p> <table> <thead> <tr> <th><u>Country</u></th> <th><u>Default</u></th> </tr> </thead> <tbody> <tr><td>United States</td><td>0</td></tr> <tr><td>Canada (French)</td><td>0</td></tr> <tr><td>Mexico</td><td>0</td></tr> <tr><td>Australia</td><td>0</td></tr> <tr><td>France</td><td>300</td></tr> <tr><td>Germany</td><td>0</td></tr> <tr><td>Netherlands</td><td>535</td></tr> <tr><td>United Kingdom</td><td>0</td></tr> </tbody> </table>	<u>Country</u>	<u>Default</u>	United States	0	Canada (French)	0	Mexico	0	Australia	0	France	300	Germany	0	Netherlands	535	United Kingdom	0	1 Hz (0 Hz to 1200 Hz)
<u>Country</u>	<u>Default</u>																			
United States	0																			
Canada (French)	0																			
Mexico	0																			
Australia	0																			
France	300																			
Germany	0																			
Netherlands	535																			
United Kingdom	0																			
57	<p>Special dial tone detect. Indicates the frequency combination that is used to identify a special dial tone.</p> <table> <thead> <tr> <th><u>Country</u></th> <th><u>Default</u></th> </tr> </thead> <tbody> <tr><td>United States</td><td>0</td></tr> <tr><td>Canada (French)</td><td>0</td></tr> <tr><td>Mexico</td><td>0</td></tr> <tr><td>Australia</td><td>0</td></tr> <tr><td>France</td><td>13</td></tr> <tr><td>Germany</td><td>0</td></tr> <tr><td>Netherlands</td><td>0</td></tr> <tr><td>United Kingdom</td><td>1</td></tr> </tbody> </table>	<u>Country</u>	<u>Default</u>	United States	0	Canada (French)	0	Mexico	0	Australia	0	France	13	Germany	0	Netherlands	0	United Kingdom	1	0=no freq. 1=1 2=2 3=1&2 5=1or2 6=1&2or3&4 7=1or2or3or4 8=1&2or3or4 9=1or2or3or4 10=1&2&3&4 11=1or2&3&4 12=1&2&3or4 13=1or2&3or4 14=1or2or3
<u>Country</u>	<u>Default</u>																			
United States	0																			
Canada (French)	0																			
Mexico	0																			
Australia	0																			
France	13																			
Germany	0																			
Netherlands	0																			
United Kingdom	1																			
58	<p>Special dial tone detection time minimum. The total time a special dial tone sequence must be present for a special dial tone to be detected.</p> <table> <thead> <tr> <th><u>Country</u></th> <th><u>Default</u></th> </tr> </thead> <tbody> <tr><td>United States</td><td>0</td></tr> <tr><td>Canada (French)</td><td>0</td></tr> <tr><td>Mexico</td><td>0</td></tr> <tr><td>Australia</td><td>0</td></tr> <tr><td>France</td><td>1300</td></tr> <tr><td>Germany</td><td>0</td></tr> <tr><td>Netherlands</td><td>0</td></tr> <tr><td>United Kingdom</td><td>1000</td></tr> </tbody> </table>	<u>Country</u>	<u>Default</u>	United States	0	Canada (French)	0	Mexico	0	Australia	0	France	1300	Germany	0	Netherlands	0	United Kingdom	1000	1 ms (0 ms to 15000 ms)
<u>Country</u>	<u>Default</u>																			
United States	0																			
Canada (French)	0																			
Mexico	0																			
Australia	0																			
France	1300																			
Germany	0																			
Netherlands	0																			
United Kingdom	1000																			
59	<p>Special dial tone minimum on time. Minimum duration a cadenced special dial tone must be present for the cadenced sequence to be valid.</p> <table> <thead> <tr> <th><u>Country</u></th> <th><u>Default</u></th> </tr> </thead> <tbody> <tr><td>United States</td><td>0</td></tr> <tr><td>Canada (French)</td><td>0</td></tr> <tr><td>Mexico</td><td>0</td></tr> <tr><td>Australia</td><td>0</td></tr> <tr><td>France</td><td>0</td></tr> <tr><td>Germany</td><td>0</td></tr> <tr><td>Netherlands</td><td>0</td></tr> <tr><td>United Kingdom</td><td>0</td></tr> </tbody> </table>	<u>Country</u>	<u>Default</u>	United States	0	Canada (French)	0	Mexico	0	Australia	0	France	0	Germany	0	Netherlands	0	United Kingdom	0	1 ms (0 ms to 2000 ms)
<u>Country</u>	<u>Default</u>																			
United States	0																			
Canada (French)	0																			
Mexico	0																			
Australia	0																			
France	0																			
Germany	0																			
Netherlands	0																			
United Kingdom	0																			

Parameter #	Description	Units																		
60	<p>Special dial tone minimum on time. Minimum period of silence that must exist between cadenced special tones if the tone sequence is to be valid.</p> <table border="0"> <thead> <tr> <th><u>Country</u></th> <th><u>Default</u></th> </tr> </thead> <tbody> <tr><td>United States</td><td>0</td></tr> <tr><td>Canada (French)</td><td>0</td></tr> <tr><td>Mexico</td><td>0</td></tr> <tr><td>Australia</td><td>0</td></tr> <tr><td>France</td><td>0</td></tr> <tr><td>Germany</td><td>0</td></tr> <tr><td>Netherlands</td><td>0</td></tr> <tr><td>United Kingdom</td><td>0</td></tr> </tbody> </table>	<u>Country</u>	<u>Default</u>	United States	0	Canada (French)	0	Mexico	0	Australia	0	France	0	Germany	0	Netherlands	0	United Kingdom	0	1 ms (0 ms to 2000 ms)
<u>Country</u>	<u>Default</u>																			
United States	0																			
Canada (French)	0																			
Mexico	0																			
Australia	0																			
France	0																			
Germany	0																			
Netherlands	0																			
United Kingdom	0																			
61	<p>Special dial tone maximum on time. Maximum period of silence that can exist between cadenced special tones if the tone sequence is to be valid.</p> <table border="0"> <thead> <tr> <th><u>Country</u></th> <th><u>Default</u></th> </tr> </thead> <tbody> <tr><td>United States</td><td>0</td></tr> <tr><td>Canada (French)</td><td>0</td></tr> <tr><td>Mexico</td><td>0</td></tr> <tr><td>Australia</td><td>0</td></tr> <tr><td>France</td><td>0</td></tr> <tr><td>Germany</td><td>0</td></tr> <tr><td>Netherlands</td><td>0</td></tr> <tr><td>United Kingdom</td><td>0</td></tr> </tbody> </table>	<u>Country</u>	<u>Default</u>	United States	0	Canada (French)	0	Mexico	0	Australia	0	France	0	Germany	0	Netherlands	0	United Kingdom	0	1 ms (0 ms to 2000 ms)
<u>Country</u>	<u>Default</u>																			
United States	0																			
Canada (French)	0																			
Mexico	0																			
Australia	0																			
France	0																			
Germany	0																			
Netherlands	0																			
United Kingdom	0																			
62	<p>Special dial tone detect threshold. Sets the detection threshold for special dial tones. If the special dial tone is below this level it will not be detected.</p> <table border="0"> <thead> <tr> <th><u>Country</u></th> <th><u>Default</u></th> </tr> </thead> <tbody> <tr><td>United States</td><td>0 (-0.1 dBm)</td></tr> <tr><td>Canada (French)</td><td>0 (-0.1 dBm)</td></tr> <tr><td>Mexico</td><td>0 (-0.1 dBm)</td></tr> <tr><td>Australia</td><td>0 (-0.1 dBm)</td></tr> <tr><td>France</td><td>450 (-0.1 dBm)</td></tr> <tr><td>Germany</td><td>0 (-0.1 dBm)</td></tr> <tr><td>Netherlands</td><td>0 (-0.1 dBm)</td></tr> <tr><td>United Kingdom</td><td>350 (-0.1 dBm)</td></tr> </tbody> </table>	<u>Country</u>	<u>Default</u>	United States	0 (-0.1 dBm)	Canada (French)	0 (-0.1 dBm)	Mexico	0 (-0.1 dBm)	Australia	0 (-0.1 dBm)	France	450 (-0.1 dBm)	Germany	0 (-0.1 dBm)	Netherlands	0 (-0.1 dBm)	United Kingdom	350 (-0.1 dBm)	1 (0 to 510)
<u>Country</u>	<u>Default</u>																			
United States	0 (-0.1 dBm)																			
Canada (French)	0 (-0.1 dBm)																			
Mexico	0 (-0.1 dBm)																			
Australia	0 (-0.1 dBm)																			
France	450 (-0.1 dBm)																			
Germany	0 (-0.1 dBm)																			
Netherlands	0 (-0.1 dBm)																			
United Kingdom	350 (-0.1 dBm)																			
63	<p>Special dial tone frequency 1. Center frequency for the first component of the special dial tone.</p> <table border="0"> <thead> <tr> <th><u>Country</u></th> <th><u>Default</u></th> </tr> </thead> <tbody> <tr><td>United States</td><td>0</td></tr> <tr><td>Canada (French)</td><td>0</td></tr> <tr><td>Mexico</td><td>0</td></tr> <tr><td>Australia</td><td>0</td></tr> <tr><td>France</td><td>420</td></tr> <tr><td>Germany</td><td>0</td></tr> <tr><td>Netherlands</td><td>0</td></tr> <tr><td>United Kingdom</td><td>1111</td></tr> </tbody> </table>	<u>Country</u>	<u>Default</u>	United States	0	Canada (French)	0	Mexico	0	Australia	0	France	420	Germany	0	Netherlands	0	United Kingdom	1111	1 Hz (0 Hz to 1200 Hz)
<u>Country</u>	<u>Default</u>																			
United States	0																			
Canada (French)	0																			
Mexico	0																			
Australia	0																			
France	420																			
Germany	0																			
Netherlands	0																			
United Kingdom	1111																			

Parameter #	Description	Units																		
64	<p>Special dial tone frequency 2. Center frequency for the second component of the special dial tone.</p> <table border="0"> <thead> <tr> <th><u>Country</u></th> <th><u>Default</u></th> </tr> </thead> <tbody> <tr> <td>United States</td> <td>0</td> </tr> <tr> <td>Canada (French)</td> <td>0</td> </tr> <tr> <td>Mexico</td> <td>0</td> </tr> <tr> <td>Australia</td> <td>0</td> </tr> <tr> <td>France</td> <td>460</td> </tr> <tr> <td>Germany</td> <td>0</td> </tr> <tr> <td>Netherlands</td> <td>0</td> </tr> <tr> <td>United Kingdom</td> <td>0</td> </tr> </tbody> </table>	<u>Country</u>	<u>Default</u>	United States	0	Canada (French)	0	Mexico	0	Australia	0	France	460	Germany	0	Netherlands	0	United Kingdom	0	1 Hz (0 Hz to 1200 Hz)
<u>Country</u>	<u>Default</u>																			
United States	0																			
Canada (French)	0																			
Mexico	0																			
Australia	0																			
France	460																			
Germany	0																			
Netherlands	0																			
United Kingdom	0																			
65	<p>Special dial tone frequency 3. Center frequency for the third component of the special dial tone.</p> <table border="0"> <thead> <tr> <th><u>Country</u></th> <th><u>Default</u></th> </tr> </thead> <tbody> <tr> <td>United States</td> <td>0</td> </tr> <tr> <td>Canada (French)</td> <td>0</td> </tr> <tr> <td>Mexico</td> <td>0</td> </tr> <tr> <td>Australia</td> <td>0</td> </tr> <tr> <td>France</td> <td>310</td> </tr> <tr> <td>Germany</td> <td>0</td> </tr> <tr> <td>Netherlands</td> <td>0</td> </tr> <tr> <td>United Kingdom</td> <td>0</td> </tr> </tbody> </table>	<u>Country</u>	<u>Default</u>	United States	0	Canada (French)	0	Mexico	0	Australia	0	France	310	Germany	0	Netherlands	0	United Kingdom	0	1 Hz (0 Hz to 1200 Hz)
<u>Country</u>	<u>Default</u>																			
United States	0																			
Canada (French)	0																			
Mexico	0																			
Australia	0																			
France	310																			
Germany	0																			
Netherlands	0																			
United Kingdom	0																			
66	<p>Special dial tone frequency 4. Center frequency for the fourth component of the special dial tone.</p> <table border="0"> <thead> <tr> <th><u>Country</u></th> <th><u>Default</u></th> </tr> </thead> <tbody> <tr> <td>United States</td> <td>0</td> </tr> <tr> <td>Canada (French)</td> <td>0</td> </tr> <tr> <td>Mexico</td> <td>0</td> </tr> <tr> <td>Australia</td> <td>0</td> </tr> <tr> <td>France</td> <td>350</td> </tr> <tr> <td>Germany</td> <td>0</td> </tr> <tr> <td>Netherlands</td> <td>0</td> </tr> <tr> <td>United Kingdom</td> <td>0</td> </tr> </tbody> </table>	<u>Country</u>	<u>Default</u>	United States	0	Canada (French)	0	Mexico	0	Australia	0	France	350	Germany	0	Netherlands	0	United Kingdom	0	1 Hz (0 Hz to 1200 Hz)
<u>Country</u>	<u>Default</u>																			
United States	0																			
Canada (French)	0																			
Mexico	0																			
Australia	0																			
France	350																			
Germany	0																			
Netherlands	0																			
United Kingdom	0																			

Dialing

Parameter #	Description	Units																		
67*	<p>PSTN signaling. Indicates which type of signaling is used for dialing. This parameter is set by the user from the Phone Setup menu.</p> <table border="1"> <thead> <tr> <th><u>Country</u></th> <th><u>Default</u></th> </tr> </thead> <tbody> <tr><td>United States</td><td>0</td></tr> <tr><td>Canada (French)</td><td>0</td></tr> <tr><td>Mexico</td><td>0</td></tr> <tr><td>Australia</td><td>1</td></tr> <tr><td>France</td><td>0</td></tr> <tr><td>Germany</td><td>1</td></tr> <tr><td>Netherlands</td><td>1</td></tr> <tr><td>United Kingdom</td><td>1</td></tr> </tbody> </table>	<u>Country</u>	<u>Default</u>	United States	0	Canada (French)	0	Mexico	0	Australia	1	France	0	Germany	1	Netherlands	1	United Kingdom	1	0 = DTMF 1 = PULSE
<u>Country</u>	<u>Default</u>																			
United States	0																			
Canada (French)	0																			
Mexico	0																			
Australia	1																			
France	0																			
Germany	1																			
Netherlands	1																			
United Kingdom	1																			
68	<p>Dial pulse code. Determines the number of pulses that are issued for each digit. This parameter is set by the LIU.</p> <p>NORMAL : 1=1 pulse...9=9 pulses...0=10 pulses REVERSE : 1=9 pulses...9=1 pulse...0= 10 pulses 2START: 1=2pulses...9=10 pulses...0=1 pulse</p> <table border="1"> <thead> <tr> <th><u>Country</u></th> <th><u>Default</u></th> </tr> </thead> <tbody> <tr><td>United States</td><td>0</td></tr> <tr><td>Canada (French)</td><td>0</td></tr> <tr><td>Mexico</td><td>0</td></tr> <tr><td>Australia</td><td>0</td></tr> <tr><td>France</td><td>0</td></tr> <tr><td>Germany</td><td>0</td></tr> <tr><td>Netherlands</td><td>0</td></tr> <tr><td>United Kingdom</td><td>0</td></tr> </tbody> </table>	<u>Country</u>	<u>Default</u>	United States	0	Canada (French)	0	Mexico	0	Australia	0	France	0	Germany	0	Netherlands	0	United Kingdom	0	0 = NORMAL 1 = REVERSE 2 = 2START
<u>Country</u>	<u>Default</u>																			
United States	0																			
Canada (French)	0																			
Mexico	0																			
Australia	0																			
France	0																			
Germany	0																			
Netherlands	0																			
United Kingdom	0																			
69	<p>Pre dial shunt. The duration that the dial shunt relay is activated prior to pulse dialing the first digit in a dial string. Not present on all LIU. This parameter is set by the LIU.</p> <table border="1"> <thead> <tr> <th><u>Country</u></th> <th><u>Default</u></th> </tr> </thead> <tbody> <tr><td>United States</td><td>0</td></tr> <tr><td>Canada (French)</td><td>0</td></tr> <tr><td>Mexico</td><td>0</td></tr> <tr><td>Australia</td><td>250</td></tr> <tr><td>France</td><td>250</td></tr> <tr><td>Germany</td><td>90</td></tr> <tr><td>Netherlands</td><td>250</td></tr> <tr><td>United Kingdom</td><td>250</td></tr> </tbody> </table>	<u>Country</u>	<u>Default</u>	United States	0	Canada (French)	0	Mexico	0	Australia	250	France	250	Germany	90	Netherlands	250	United Kingdom	250	1 ms (0 ms to 1000 ms)
<u>Country</u>	<u>Default</u>																			
United States	0																			
Canada (French)	0																			
Mexico	0																			
Australia	250																			
France	250																			
Germany	90																			
Netherlands	250																			
United Kingdom	250																			
70	<p>Post dial shunt. The duration that the dial shunt relay remains active after the pulse dialing the last digit in a dial string. Not present on all LIUs. This parameter is set by the LIU.</p> <table border="1"> <thead> <tr> <th><u>Country</u></th> <th><u>Default</u></th> </tr> </thead> <tbody> <tr><td>United States</td><td>0</td></tr> <tr><td>Canada (French)</td><td>0</td></tr> <tr><td>Mexico</td><td>0</td></tr> <tr><td>Australia</td><td>250</td></tr> <tr><td>France</td><td>250</td></tr> <tr><td>Germany</td><td>90</td></tr> <tr><td>Netherlands</td><td>250</td></tr> <tr><td>United Kingdom</td><td>250</td></tr> </tbody> </table>	<u>Country</u>	<u>Default</u>	United States	0	Canada (French)	0	Mexico	0	Australia	250	France	250	Germany	90	Netherlands	250	United Kingdom	250	1 ms (0 ms to 1000 ms)
<u>Country</u>	<u>Default</u>																			
United States	0																			
Canada (French)	0																			
Mexico	0																			
Australia	250																			
France	250																			
Germany	90																			
Netherlands	250																			
United Kingdom	250																			

Parameter #	Description	Units																		
71	<p>Dial pulse break time. The duration that the dial pulse relay will be opened to cause a break of loop current during pulse dialing. This parameter is set by the LIU.</p> <table> <thead> <tr> <th><u>Country</u></th> <th><u>Default</u></th> </tr> </thead> <tbody> <tr> <td>United States</td> <td>60</td> </tr> <tr> <td>Canada (French)</td> <td>60</td> </tr> <tr> <td>Mexico</td> <td>67</td> </tr> <tr> <td>Australia</td> <td>67</td> </tr> <tr> <td>France</td> <td>66</td> </tr> <tr> <td>Germany</td> <td>60</td> </tr> <tr> <td>Netherlands</td> <td>61</td> </tr> <tr> <td>United Kingdom</td> <td>67</td> </tr> </tbody> </table>	<u>Country</u>	<u>Default</u>	United States	60	Canada (French)	60	Mexico	67	Australia	67	France	66	Germany	60	Netherlands	61	United Kingdom	67	1 ms (10 ms to 100 ms)
<u>Country</u>	<u>Default</u>																			
United States	60																			
Canada (French)	60																			
Mexico	67																			
Australia	67																			
France	66																			
Germany	60																			
Netherlands	61																			
United Kingdom	67																			
72	<p>Dial pulse make time. The duration that the dial pulse relay will be closed to cause a make of loop current during pulse dialing. This parameter is set by the LIU.</p> <table> <thead> <tr> <th><u>Country</u></th> <th><u>Default</u></th> </tr> </thead> <tbody> <tr> <td>United States</td> <td>40</td> </tr> <tr> <td>Canada (French)</td> <td>40</td> </tr> <tr> <td>Mexico</td> <td>33</td> </tr> <tr> <td>Australia</td> <td>33</td> </tr> <tr> <td>France</td> <td>34</td> </tr> <tr> <td>Germany</td> <td>40</td> </tr> <tr> <td>Netherlands</td> <td>39</td> </tr> <tr> <td>United Kingdom</td> <td>33</td> </tr> </tbody> </table>	<u>Country</u>	<u>Default</u>	United States	40	Canada (French)	40	Mexico	33	Australia	33	France	34	Germany	40	Netherlands	39	United Kingdom	33	1 ms (10 ms to 100 ms)
<u>Country</u>	<u>Default</u>																			
United States	40																			
Canada (French)	40																			
Mexico	33																			
Australia	33																			
France	34																			
Germany	40																			
Netherlands	39																			
United Kingdom	33																			
73	<p>Dial pulse interdigit time. The duration between digits when pulse dialing, measured from the end of the last make to the start of the first break of the next digit.</p> <table> <thead> <tr> <th><u>Country</u></th> <th><u>Default</u></th> </tr> </thead> <tbody> <tr> <td>United States</td> <td>80</td> </tr> <tr> <td>Canada (French)</td> <td>80</td> </tr> <tr> <td>Mexico</td> <td>800</td> </tr> <tr> <td>Australia</td> <td>800</td> </tr> <tr> <td>France</td> <td>900</td> </tr> <tr> <td>Germany</td> <td>800</td> </tr> <tr> <td>Netherlands</td> <td>800</td> </tr> <tr> <td>United Kingdom</td> <td>800</td> </tr> </tbody> </table>	<u>Country</u>	<u>Default</u>	United States	80	Canada (French)	80	Mexico	800	Australia	800	France	900	Germany	800	Netherlands	800	United Kingdom	800	1 ms (400 ms to 1500 ms)
<u>Country</u>	<u>Default</u>																			
United States	80																			
Canada (French)	80																			
Mexico	800																			
Australia	800																			
France	900																			
Germany	800																			
Netherlands	800																			
United Kingdom	800																			
74	<p>DTMF transmit level high group. The DTMF transmit level for the high group of frequencies in the DTMF tone pair.</p> <table> <thead> <tr> <th><u>Country</u></th> <th><u>Default</u></th> </tr> </thead> <tbody> <tr> <td>United States</td> <td>50 (-0.1 dBm)</td> </tr> <tr> <td>Canada (French)</td> <td>50 (-0.1 dBm)</td> </tr> <tr> <td>Mexico</td> <td>60 (-0.1 dBm)</td> </tr> <tr> <td>Australia</td> <td>90 (-0.1 dBm)</td> </tr> <tr> <td>France</td> <td>60 (-0.1 dBm)</td> </tr> <tr> <td>Germany</td> <td>70 (-0.1 dBm)</td> </tr> <tr> <td>Netherlands</td> <td>90 (-0.1 dBm)</td> </tr> <tr> <td>United Kingdom</td> <td>90 (-0.1 dBm)</td> </tr> </tbody> </table>	<u>Country</u>	<u>Default</u>	United States	50 (-0.1 dBm)	Canada (French)	50 (-0.1 dBm)	Mexico	60 (-0.1 dBm)	Australia	90 (-0.1 dBm)	France	60 (-0.1 dBm)	Germany	70 (-0.1 dBm)	Netherlands	90 (-0.1 dBm)	United Kingdom	90 (-0.1 dBm)	1 (0 to 150)
<u>Country</u>	<u>Default</u>																			
United States	50 (-0.1 dBm)																			
Canada (French)	50 (-0.1 dBm)																			
Mexico	60 (-0.1 dBm)																			
Australia	90 (-0.1 dBm)																			
France	60 (-0.1 dBm)																			
Germany	70 (-0.1 dBm)																			
Netherlands	90 (-0.1 dBm)																			
United Kingdom	90 (-0.1 dBm)																			

Parameter #	Description	Units																		
75	<p>DTMF transmit delta low group. The relative transmit level for the low group of frequencies in the DTMF tone pair.</p> <table border="1"> <thead> <tr> <th>Country</th> <th>Default</th> </tr> </thead> <tbody> <tr> <td>United States</td> <td>20 (-0.1 dBm)</td> </tr> <tr> <td>Canada (French)</td> <td>20 (-0.1 dBm)</td> </tr> <tr> <td>Mexico</td> <td>20 (-0.1 dBm)</td> </tr> <tr> <td>Australia</td> <td>20 (-0.1 dBm)</td> </tr> <tr> <td>France</td> <td>20 (-0.1 dBm)</td> </tr> <tr> <td>Germany</td> <td>20 (-0.1 dBm)</td> </tr> <tr> <td>Netherlands</td> <td>20 (-0.1 dBm)</td> </tr> <tr> <td>United Kingdom</td> <td>20 (-0.1 dBm)</td> </tr> </tbody> </table>	Country	Default	United States	20 (-0.1 dBm)	Canada (French)	20 (-0.1 dBm)	Mexico	20 (-0.1 dBm)	Australia	20 (-0.1 dBm)	France	20 (-0.1 dBm)	Germany	20 (-0.1 dBm)	Netherlands	20 (-0.1 dBm)	United Kingdom	20 (-0.1 dBm)	1 (0 to 40)
Country	Default																			
United States	20 (-0.1 dBm)																			
Canada (French)	20 (-0.1 dBm)																			
Mexico	20 (-0.1 dBm)																			
Australia	20 (-0.1 dBm)																			
France	20 (-0.1 dBm)																			
Germany	20 (-0.1 dBm)																			
Netherlands	20 (-0.1 dBm)																			
United Kingdom	20 (-0.1 dBm)																			
76	<p>DTMF duration and interdigit time. Duration of each DTMF signal and the duration of the interdigit silence.</p> <table border="1"> <thead> <tr> <th>Country</th> <th>Default</th> </tr> </thead> <tbody> <tr> <td>United States</td> <td>70</td> </tr> <tr> <td>Canada (French)</td> <td>70</td> </tr> <tr> <td>Mexico</td> <td>70</td> </tr> <tr> <td>Australia</td> <td>85</td> </tr> <tr> <td>France</td> <td>80</td> </tr> <tr> <td>Germany</td> <td>90</td> </tr> <tr> <td>Netherlands</td> <td>80</td> </tr> <tr> <td>United Kingdom</td> <td>85</td> </tr> </tbody> </table>	Country	Default	United States	70	Canada (French)	70	Mexico	70	Australia	85	France	80	Germany	90	Netherlands	80	United Kingdom	85	1 ms (40 ms to 200 ms)
Country	Default																			
United States	70																			
Canada (French)	70																			
Mexico	70																			
Australia	85																			
France	80																			
Germany	90																			
Netherlands	80																			
United Kingdom	85																			

Call Progress

Parameter #	Description	Units																		
78	<p>Call progress detect. Indicates the frequency combination that is used to identify the call progress tone.</p> <table border="1"> <thead> <tr> <th>Country</th> <th>Default</th> </tr> </thead> <tbody> <tr> <td>United States</td> <td>3</td> </tr> <tr> <td>Canada (French)</td> <td>3</td> </tr> <tr> <td>Mexico</td> <td>3</td> </tr> <tr> <td>Australia</td> <td>1</td> </tr> <tr> <td>France</td> <td>5</td> </tr> <tr> <td>Germany</td> <td>9</td> </tr> <tr> <td>Netherlands</td> <td>9</td> </tr> <tr> <td>United Kingdom</td> <td>1</td> </tr> </tbody> </table>	Country	Default	United States	3	Canada (French)	3	Mexico	3	Australia	1	France	5	Germany	9	Netherlands	9	United Kingdom	1	0=no freq. 1=1 2=2 3=1&2 5=1or2 6=1&2or3&4 7=1or2or3or4 8=1&2or3or4 9=1or2or3or4 10=1&2&3&4 11=1or2&3&4 12=1&2&3or4 13=1or2&3or4 14=1or2or3
Country	Default																			
United States	3																			
Canada (French)	3																			
Mexico	3																			
Australia	1																			
France	5																			
Germany	9																			
Netherlands	9																			
United Kingdom	1																			
79	<p>Call progress tone minimum on time. Minimum duration a call progress tone must be present for a cadenced sequence to be valid.</p> <table border="1"> <thead> <tr> <th>Country</th> <th>Default</th> </tr> </thead> <tbody> <tr> <td>United States</td> <td>150</td> </tr> <tr> <td>Canada (French)</td> <td>150</td> </tr> <tr> <td>Mexico</td> <td>150</td> </tr> <tr> <td>Australia</td> <td>200</td> </tr> <tr> <td>France</td> <td>350</td> </tr> <tr> <td>Germany</td> <td>100</td> </tr> <tr> <td>Netherlands</td> <td>150</td> </tr> <tr> <td>United Kingdom</td> <td>200</td> </tr> </tbody> </table>	Country	Default	United States	150	Canada (French)	150	Mexico	150	Australia	200	France	350	Germany	100	Netherlands	150	United Kingdom	200	1 ms (50 ms to 2000 ms)
Country	Default																			
United States	150																			
Canada (French)	150																			
Mexico	150																			
Australia	200																			
France	350																			
Germany	100																			
Netherlands	150																			
United Kingdom	200																			

Parameter #	Description	Units																		
80	<p>Call progress tone maximum on time. Maximum duration a call progress tone can be present for a cadenced sequence to be valid.</p> <table border="1"> <thead> <tr> <th><u>Country</u></th> <th><u>Default</u></th> </tr> </thead> <tbody> <tr> <td>United States</td> <td>750</td> </tr> <tr> <td>Canada (French)</td> <td>750</td> </tr> <tr> <td>Mexico</td> <td>750</td> </tr> <tr> <td>Australia</td> <td>750</td> </tr> <tr> <td>France</td> <td>750</td> </tr> <tr> <td>Germany</td> <td>750</td> </tr> <tr> <td>Netherlands</td> <td>750</td> </tr> <tr> <td>United Kingdom</td> <td>600</td> </tr> </tbody> </table>	<u>Country</u>	<u>Default</u>	United States	750	Canada (French)	750	Mexico	750	Australia	750	France	750	Germany	750	Netherlands	750	United Kingdom	600	1 ms (50 ms to 4000 ms)
<u>Country</u>	<u>Default</u>																			
United States	750																			
Canada (French)	750																			
Mexico	750																			
Australia	750																			
France	750																			
Germany	750																			
Netherlands	750																			
United Kingdom	600																			
81	<p>Call progress tone minimum off time. Minimum period of silence that must exist between cadenced call progress tones if the tone sequence is to be valid.</p> <table border="1"> <thead> <tr> <th><u>Country</u></th> <th><u>Default</u></th> </tr> </thead> <tbody> <tr> <td>United States</td> <td>150</td> </tr> <tr> <td>Canada (French)</td> <td>150</td> </tr> <tr> <td>Mexico</td> <td>150</td> </tr> <tr> <td>Australia</td> <td>275</td> </tr> <tr> <td>France</td> <td>350</td> </tr> <tr> <td>Germany</td> <td>200</td> </tr> <tr> <td>Netherlands</td> <td>150</td> </tr> <tr> <td>United Kingdom</td> <td>290</td> </tr> </tbody> </table>	<u>Country</u>	<u>Default</u>	United States	150	Canada (French)	150	Mexico	150	Australia	275	France	350	Germany	200	Netherlands	150	United Kingdom	290	1 ms (0 ms to 2000 ms)
<u>Country</u>	<u>Default</u>																			
United States	150																			
Canada (French)	150																			
Mexico	150																			
Australia	275																			
France	350																			
Germany	200																			
Netherlands	150																			
United Kingdom	290																			
82	<p>Call progress tone maximum off time. Maximum period of silence that can exist between cadenced call progress tones if the tone sequence is to be valid.</p> <table border="1"> <thead> <tr> <th><u>Country</u></th> <th><u>Default</u></th> </tr> </thead> <tbody> <tr> <td>United States</td> <td>750</td> </tr> <tr> <td>Canada (French)</td> <td>750</td> </tr> <tr> <td>Mexico</td> <td>750</td> </tr> <tr> <td>Australia</td> <td>750</td> </tr> <tr> <td>France</td> <td>750</td> </tr> <tr> <td>Germany</td> <td>750</td> </tr> <tr> <td>Netherlands</td> <td>750</td> </tr> <tr> <td>United Kingdom</td> <td>600</td> </tr> </tbody> </table>	<u>Country</u>	<u>Default</u>	United States	750	Canada (French)	750	Mexico	750	Australia	750	France	750	Germany	750	Netherlands	750	United Kingdom	600	1 ms (50 ms to 4000 ms)
<u>Country</u>	<u>Default</u>																			
United States	750																			
Canada (French)	750																			
Mexico	750																			
Australia	750																			
France	750																			
Germany	750																			
Netherlands	750																			
United Kingdom	600																			
83	<p>Call progress detect threshold. Sets the detection threshold for the call progress tones. If the progress tones are below this level they will not be detected.</p> <table border="1"> <thead> <tr> <th><u>Country</u></th> <th><u>Default</u></th> </tr> </thead> <tbody> <tr> <td>United States</td> <td>470 (-0.1 dBm)</td> </tr> <tr> <td>Canada (French)</td> <td>470 (-0.1 dBm)</td> </tr> <tr> <td>Mexico</td> <td>470 (-0.1 dBm)</td> </tr> <tr> <td>Australia</td> <td>370 (-0.1 dBm)</td> </tr> <tr> <td>France</td> <td>450 (-0.1 dBm)</td> </tr> <tr> <td>Germany</td> <td>430 (-0.1 dBm)</td> </tr> <tr> <td>Netherlands</td> <td>430 (-0.1 dBm)</td> </tr> <tr> <td>United Kingdom</td> <td>370 (-0.1 dBm)</td> </tr> </tbody> </table>	<u>Country</u>	<u>Default</u>	United States	470 (-0.1 dBm)	Canada (French)	470 (-0.1 dBm)	Mexico	470 (-0.1 dBm)	Australia	370 (-0.1 dBm)	France	450 (-0.1 dBm)	Germany	430 (-0.1 dBm)	Netherlands	430 (-0.1 dBm)	United Kingdom	370 (-0.1 dBm)	1 (260 to 510)
<u>Country</u>	<u>Default</u>																			
United States	470 (-0.1 dBm)																			
Canada (French)	470 (-0.1 dBm)																			
Mexico	470 (-0.1 dBm)																			
Australia	370 (-0.1 dBm)																			
France	450 (-0.1 dBm)																			
Germany	430 (-0.1 dBm)																			
Netherlands	430 (-0.1 dBm)																			
United Kingdom	370 (-0.1 dBm)																			

Parameter #	Description	Units																		
84	<p>Call progress tone frequency 1. The center frequency for the first component of the call progress tone.</p> <table border="1"> <thead> <tr> <th><u>Country</u></th> <th><u>Default</u></th> </tr> </thead> <tbody> <tr> <td>United States</td> <td>620</td> </tr> <tr> <td>Canada (French)</td> <td>620</td> </tr> <tr> <td>Mexico</td> <td>620</td> </tr> <tr> <td>Australia</td> <td>425</td> </tr> <tr> <td>France</td> <td>420</td> </tr> <tr> <td>Germany</td> <td>425</td> </tr> <tr> <td>Netherlands</td> <td>355</td> </tr> <tr> <td>United Kingdom</td> <td>400</td> </tr> </tbody> </table>	<u>Country</u>	<u>Default</u>	United States	620	Canada (French)	620	Mexico	620	Australia	425	France	420	Germany	425	Netherlands	355	United Kingdom	400	1 Hz (100 Hz to 1200 Hz)
<u>Country</u>	<u>Default</u>																			
United States	620																			
Canada (French)	620																			
Mexico	620																			
Australia	425																			
France	420																			
Germany	425																			
Netherlands	355																			
United Kingdom	400																			
85	<p>Call progress tone frequency 2. The center frequency for the second component of the call progress tone.</p> <table border="1"> <thead> <tr> <th><u>Country</u></th> <th><u>Default</u></th> </tr> </thead> <tbody> <tr> <td>United States</td> <td>480</td> </tr> <tr> <td>Canada (French)</td> <td>480</td> </tr> <tr> <td>Mexico</td> <td>480</td> </tr> <tr> <td>Australia</td> <td>0</td> </tr> <tr> <td>France</td> <td>460</td> </tr> <tr> <td>Germany</td> <td>450</td> </tr> <tr> <td>Netherlands</td> <td>415</td> </tr> <tr> <td>United Kingdom</td> <td>450</td> </tr> </tbody> </table>	<u>Country</u>	<u>Default</u>	United States	480	Canada (French)	480	Mexico	480	Australia	0	France	460	Germany	450	Netherlands	415	United Kingdom	450	1 Hz (0 Hz to 1200 Hz)
<u>Country</u>	<u>Default</u>																			
United States	480																			
Canada (French)	480																			
Mexico	480																			
Australia	0																			
France	460																			
Germany	450																			
Netherlands	415																			
United Kingdom	450																			
86	<p>Call progress tone frequency 3. The center frequency for the third component of the call progress tone.</p> <table border="1"> <thead> <tr> <th><u>Country</u></th> <th><u>Default</u></th> </tr> </thead> <tbody> <tr> <td>United States</td> <td>0</td> </tr> <tr> <td>Canada (French)</td> <td>0</td> </tr> <tr> <td>Mexico</td> <td>0</td> </tr> <tr> <td>Australia</td> <td>0</td> </tr> <tr> <td>France</td> <td>0</td> </tr> <tr> <td>Germany</td> <td>395</td> </tr> <tr> <td>Netherlands</td> <td>475</td> </tr> <tr> <td>United Kingdom</td> <td>0</td> </tr> </tbody> </table>	<u>Country</u>	<u>Default</u>	United States	0	Canada (French)	0	Mexico	0	Australia	0	France	0	Germany	395	Netherlands	475	United Kingdom	0	1 Hz (0 Hz to 1200 Hz)
<u>Country</u>	<u>Default</u>																			
United States	0																			
Canada (French)	0																			
Mexico	0																			
Australia	0																			
France	0																			
Germany	395																			
Netherlands	475																			
United Kingdom	0																			
87	<p>Call progress tone frequency 4. The center frequency for the fourth component of the call progress tone.</p> <table border="1"> <thead> <tr> <th><u>Country</u></th> <th><u>Default</u></th> </tr> </thead> <tbody> <tr> <td>United States</td> <td>0</td> </tr> <tr> <td>Canada (French)</td> <td>0</td> </tr> <tr> <td>Mexico</td> <td>0</td> </tr> <tr> <td>Australia</td> <td>0</td> </tr> <tr> <td>France</td> <td>0</td> </tr> <tr> <td>Germany</td> <td>475</td> </tr> <tr> <td>Netherlands</td> <td>535</td> </tr> <tr> <td>United Kingdom</td> <td>0</td> </tr> </tbody> </table>	<u>Country</u>	<u>Default</u>	United States	0	Canada (French)	0	Mexico	0	Australia	0	France	0	Germany	475	Netherlands	535	United Kingdom	0	1 Hz (0 Hz to 1200 Hz)
<u>Country</u>	<u>Default</u>																			
United States	0																			
Canada (French)	0																			
Mexico	0																			
Australia	0																			
France	0																			
Germany	475																			
Netherlands	535																			
United Kingdom	0																			

Parameter #	Description	Units																		
88	<p>Disconnect if busy detected. Specifies the duration a busy sequence must be detected. If a valid busy sequence is detected the call is aborted.</p> <table border="1"> <thead> <tr> <th><u>Country</u></th> <th><u>Default</u></th> </tr> </thead> <tbody> <tr> <td>United States</td> <td>5000</td> </tr> <tr> <td>Canada (French)</td> <td>5000</td> </tr> <tr> <td>Mexico</td> <td>5000</td> </tr> <tr> <td>Australia</td> <td>5000</td> </tr> <tr> <td>France</td> <td>5000</td> </tr> <tr> <td>Germany</td> <td>5000</td> </tr> <tr> <td>Netherlands</td> <td>5000</td> </tr> <tr> <td>United Kingdom</td> <td>10000</td> </tr> </tbody> </table>	<u>Country</u>	<u>Default</u>	United States	5000	Canada (French)	5000	Mexico	5000	Australia	5000	France	5000	Germany	5000	Netherlands	5000	United Kingdom	10000	1 ms (1000 ms to 30000 ms)
<u>Country</u>	<u>Default</u>																			
United States	5000																			
Canada (French)	5000																			
Mexico	5000																			
Australia	5000																			
France	5000																			
Germany	5000																			
Netherlands	5000																			
United Kingdom	10000																			

Modem Configuration

Parameter #	Description	Units																		
89	<p>Equalizer. Used to select the transmission compromise equalizer. equalizers 1,2 and 3 are designed for lines 1.8, 3.6 and 7.2 kilometers respectively.</p> <table border="1"> <thead> <tr> <th><u>Country</u></th> <th><u>Default</u></th> </tr> </thead> <tbody> <tr> <td>United States</td> <td>0</td> </tr> <tr> <td>Canada (French)</td> <td>0</td> </tr> <tr> <td>Mexico</td> <td>0</td> </tr> <tr> <td>Australia</td> <td>0</td> </tr> <tr> <td>France</td> <td>0</td> </tr> <tr> <td>Germany</td> <td>0</td> </tr> <tr> <td>Netherlands</td> <td>0</td> </tr> <tr> <td>United Kingdom</td> <td>0</td> </tr> </tbody> </table>	<u>Country</u>	<u>Default</u>	United States	0	Canada (French)	0	Mexico	0	Australia	0	France	0	Germany	0	Netherlands	0	United Kingdom	0	0 = NONE 1 = EQL1 2 = EQL2 3 = EQL3
<u>Country</u>	<u>Default</u>																			
United States	0																			
Canada (French)	0																			
Mexico	0																			
Australia	0																			
France	0																			
Germany	0																			
Netherlands	0																			
United Kingdom	0																			
90	<p>LIU receive loss. Specifies the LIU receive loss. The receive loss is introduced between the modem and the external telephone line interface jack. It is used to correctly adjust the internal modem receive level so that the receive level at the telephone line interface jack is as specified by MODEM MINIMUM CARRIER DETECTION LEVEL. This parameter is set by the LIU.</p> <table border="1"> <thead> <tr> <th><u>Country</u></th> <th><u>Default</u></th> </tr> </thead> <tbody> <tr> <td>United States</td> <td>18 (-0.1 dBm)</td> </tr> <tr> <td>Canada (French)</td> <td>18 (-0.1 dBm)</td> </tr> <tr> <td>Mexico</td> <td>18 (-0.1 dBm)</td> </tr> <tr> <td>Australia</td> <td>15 (-0.1 dBm)</td> </tr> <tr> <td>France</td> <td>26 (-0.1 dBm)</td> </tr> <tr> <td>Germany</td> <td>15 (-0.1 dBm)</td> </tr> <tr> <td>Netherlands</td> <td>22 (-0.1 dBm)</td> </tr> <tr> <td>United Kingdom</td> <td>22 (-0.1 dBm)</td> </tr> </tbody> </table>	<u>Country</u>	<u>Default</u>	United States	18 (-0.1 dBm)	Canada (French)	18 (-0.1 dBm)	Mexico	18 (-0.1 dBm)	Australia	15 (-0.1 dBm)	France	26 (-0.1 dBm)	Germany	15 (-0.1 dBm)	Netherlands	22 (-0.1 dBm)	United Kingdom	22 (-0.1 dBm)	1 (0 to 100)
<u>Country</u>	<u>Default</u>																			
United States	18 (-0.1 dBm)																			
Canada (French)	18 (-0.1 dBm)																			
Mexico	18 (-0.1 dBm)																			
Australia	15 (-0.1 dBm)																			
France	26 (-0.1 dBm)																			
Germany	15 (-0.1 dBm)																			
Netherlands	22 (-0.1 dBm)																			
United Kingdom	22 (-0.1 dBm)																			

Parameter #	Description	Units																											
91	<p>LIU transmit loss. Specifies the LIU transmit loss. This transmission loss is introduced between the modem and the telephone line interface jack. It is used to correctly adjust the modem and DTMF transmit levels so that the level at the telephone line interface jack is as specified by the MODEM TRANSMIT LEVEL.</p> <table border="0"> <thead> <tr> <th><u>Country</u></th> <th><u>Default</u></th> <th></th> </tr> </thead> <tbody> <tr> <td>United States</td> <td>70</td> <td>(-0.1 dBm)</td> </tr> <tr> <td>Canada (French)</td> <td>70</td> <td>(-0.1 dBm)</td> </tr> <tr> <td>Mexico</td> <td>70</td> <td>(-0.1 dBm)</td> </tr> <tr> <td>Australia</td> <td>94</td> <td>(-0.1 dBm)</td> </tr> <tr> <td>France</td> <td>74</td> <td>(-0.1 dBm)</td> </tr> <tr> <td>Germany</td> <td>75</td> <td>(-0.1 dBm)</td> </tr> <tr> <td>Netherlands</td> <td>70</td> <td>(-0.1 dBm)</td> </tr> <tr> <td>United Kingdom</td> <td>70</td> <td>(-0.1 dBm)</td> </tr> </tbody> </table>	<u>Country</u>	<u>Default</u>		United States	70	(-0.1 dBm)	Canada (French)	70	(-0.1 dBm)	Mexico	70	(-0.1 dBm)	Australia	94	(-0.1 dBm)	France	74	(-0.1 dBm)	Germany	75	(-0.1 dBm)	Netherlands	70	(-0.1 dBm)	United Kingdom	70	(-0.1 dBm)	1 (0 to 100)
<u>Country</u>	<u>Default</u>																												
United States	70	(-0.1 dBm)																											
Canada (French)	70	(-0.1 dBm)																											
Mexico	70	(-0.1 dBm)																											
Australia	94	(-0.1 dBm)																											
France	74	(-0.1 dBm)																											
Germany	75	(-0.1 dBm)																											
Netherlands	70	(-0.1 dBm)																											
United Kingdom	70	(-0.1 dBm)																											
92	<p>Modem minimum carrier detection level. Specifies the minimum modem receive level that is presented from the PSTN at the external telephone interface jack. This parameter is set by the LIU.</p> <table border="0"> <thead> <tr> <th><u>Country</u></th> <th><u>Default</u></th> <th></th> </tr> </thead> <tbody> <tr> <td>United States</td> <td>430</td> <td>(-0.1 dBm)</td> </tr> <tr> <td>Canada (French)</td> <td>430</td> <td>(-0.1 dBm)</td> </tr> <tr> <td>Mexico</td> <td>430</td> <td>(-0.1 dBm)</td> </tr> <tr> <td>Australia</td> <td>430</td> <td>(-0.1 dBm)</td> </tr> <tr> <td>France</td> <td>430</td> <td>(-0.1 dBm)</td> </tr> <tr> <td>Germany</td> <td>470</td> <td>(-0.1 dBm)</td> </tr> <tr> <td>Netherlands</td> <td>430</td> <td>(-0.1 dBm)</td> </tr> <tr> <td>United Kingdom</td> <td>430</td> <td>(-0.1 dBm)</td> </tr> </tbody> </table>	<u>Country</u>	<u>Default</u>		United States	430	(-0.1 dBm)	Canada (French)	430	(-0.1 dBm)	Mexico	430	(-0.1 dBm)	Australia	430	(-0.1 dBm)	France	430	(-0.1 dBm)	Germany	470	(-0.1 dBm)	Netherlands	430	(-0.1 dBm)	United Kingdom	430	(-0.1 dBm)	1 (350 to 510)
<u>Country</u>	<u>Default</u>																												
United States	430	(-0.1 dBm)																											
Canada (French)	430	(-0.1 dBm)																											
Mexico	430	(-0.1 dBm)																											
Australia	430	(-0.1 dBm)																											
France	430	(-0.1 dBm)																											
Germany	470	(-0.1 dBm)																											
Netherlands	430	(-0.1 dBm)																											
United Kingdom	430	(-0.1 dBm)																											
93	<p>Modem transmit level. Specifies the transmit level that is presented to the PSTN at the external telephone line interface jack.</p> <table border="0"> <thead> <tr> <th><u>Country</u></th> <th><u>Default</u></th> <th></th> </tr> </thead> <tbody> <tr> <td>United States</td> <td>100</td> <td>(-0.1 dBm)</td> </tr> <tr> <td>Canada (French)</td> <td>100</td> <td>(-0.1 dBm)</td> </tr> <tr> <td>Mexico</td> <td>100</td> <td>(-0.1 dBm)</td> </tr> <tr> <td>Australia</td> <td>105</td> <td>(-0.1 dBm)</td> </tr> <tr> <td>France</td> <td>100</td> <td>(-0.1 dBm)</td> </tr> <tr> <td>Germany</td> <td>115</td> <td>(-0.1 dBm)</td> </tr> <tr> <td>Netherlands</td> <td>70</td> <td>(-0.1 dBm)</td> </tr> <tr> <td>United Kingdom</td> <td>100</td> <td>(-0.1 dBm)</td> </tr> </tbody> </table>	<u>Country</u>	<u>Default</u>		United States	100	(-0.1 dBm)	Canada (French)	100	(-0.1 dBm)	Mexico	100	(-0.1 dBm)	Australia	105	(-0.1 dBm)	France	100	(-0.1 dBm)	Germany	115	(-0.1 dBm)	Netherlands	70	(-0.1 dBm)	United Kingdom	100	(-0.1 dBm)	1 (0 to 255)
<u>Country</u>	<u>Default</u>																												
United States	100	(-0.1 dBm)																											
Canada (French)	100	(-0.1 dBm)																											
Mexico	100	(-0.1 dBm)																											
Australia	105	(-0.1 dBm)																											
France	100	(-0.1 dBm)																											
Germany	115	(-0.1 dBm)																											
Netherlands	70	(-0.1 dBm)																											
United Kingdom	100	(-0.1 dBm)																											

Fax Session Configuration

Parameter #	Description	Units																		
94	<p>Answer inactivity abort timer. Specifies the time from going OFF hook and waiting for an incoming fax handshake, until OfficeJet disconnects because no incoming fax activity is detected.</p> <table border="0"> <thead> <tr> <th><u>Country</u></th> <th><u>Default</u></th> </tr> </thead> <tbody> <tr> <td>United States</td> <td>30</td> </tr> <tr> <td>Canada (French)</td> <td>30</td> </tr> <tr> <td>Mexico</td> <td>30</td> </tr> <tr> <td>Australia</td> <td>40</td> </tr> <tr> <td>France</td> <td>46</td> </tr> <tr> <td>Germany</td> <td>40</td> </tr> <tr> <td>Netherlands</td> <td>40</td> </tr> <tr> <td>United Kingdom</td> <td>40</td> </tr> </tbody> </table>	<u>Country</u>	<u>Default</u>	United States	30	Canada (French)	30	Mexico	30	Australia	40	France	46	Germany	40	Netherlands	40	United Kingdom	40	1 sec (0 sec to 255 secs)
<u>Country</u>	<u>Default</u>																			
United States	30																			
Canada (French)	30																			
Mexico	30																			
Australia	40																			
France	46																			
Germany	40																			
Netherlands	40																			
United Kingdom	40																			
95	<p>Originate inactivity abort timer. Specifies the time from starting the outgoing fax handshake until OfficeJet disconnects again if no response is detected from the answering machine.</p> <table border="0"> <thead> <tr> <th><u>Country</u></th> <th><u>Default</u></th> </tr> </thead> <tbody> <tr> <td>United States</td> <td>59</td> </tr> <tr> <td>Canada (French)</td> <td>59</td> </tr> <tr> <td>Mexico</td> <td>59</td> </tr> <tr> <td>Australia</td> <td>60</td> </tr> <tr> <td>France</td> <td>50</td> </tr> <tr> <td>Germany</td> <td>80</td> </tr> <tr> <td>Netherlands</td> <td>110</td> </tr> <tr> <td>United Kingdom</td> <td>55</td> </tr> </tbody> </table>	<u>Country</u>	<u>Default</u>	United States	59	Canada (French)	59	Mexico	59	Australia	60	France	50	Germany	80	Netherlands	110	United Kingdom	55	1 sec (0 sec to 255 secs)
<u>Country</u>	<u>Default</u>																			
United States	59																			
Canada (French)	59																			
Mexico	59																			
Australia	60																			
France	50																			
Germany	80																			
Netherlands	110																			
United Kingdom	55																			
96	<p>Modem transmit level minimum. Specifies the minimum modem transmit signal level that can be entered by the user, when user adjustment is allowed.</p> <table border="0"> <thead> <tr> <th><u>Country</u></th> <th><u>Default</u></th> </tr> </thead> <tbody> <tr> <td>United States</td> <td>0 (-0.1 dBm)</td> </tr> <tr> <td>Canada (French)</td> <td>0 (-0.1 dBm)</td> </tr> <tr> <td>Mexico</td> <td>0 (-0.1 dBm)</td> </tr> <tr> <td>Australia</td> <td>0 (-0.1 dBm)</td> </tr> <tr> <td>France</td> <td>0 (-0.1 dBm)</td> </tr> <tr> <td>Germany</td> <td>0 (-0.1 dBm)</td> </tr> <tr> <td>Netherlands</td> <td>0 (-0.1 dBm)</td> </tr> <tr> <td>United Kingdom</td> <td>0 (-0.1 dBm)</td> </tr> </tbody> </table>	<u>Country</u>	<u>Default</u>	United States	0 (-0.1 dBm)	Canada (French)	0 (-0.1 dBm)	Mexico	0 (-0.1 dBm)	Australia	0 (-0.1 dBm)	France	0 (-0.1 dBm)	Germany	0 (-0.1 dBm)	Netherlands	0 (-0.1 dBm)	United Kingdom	0 (-0.1 dBm)	1 (0 to 255)
<u>Country</u>	<u>Default</u>																			
United States	0 (-0.1 dBm)																			
Canada (French)	0 (-0.1 dBm)																			
Mexico	0 (-0.1 dBm)																			
Australia	0 (-0.1 dBm)																			
France	0 (-0.1 dBm)																			
Germany	0 (-0.1 dBm)																			
Netherlands	0 (-0.1 dBm)																			
United Kingdom	0 (-0.1 dBm)																			
97	<p>Modem transmit level maximum. Specifies the maximum modem transmit signal level that can be entered by the user, when user adjustment is allowed.</p> <table border="0"> <thead> <tr> <th><u>Country</u></th> <th><u>Default</u></th> </tr> </thead> <tbody> <tr> <td>United States</td> <td>0 (-0.1 dBm)</td> </tr> <tr> <td>Canada (French)</td> <td>0 (-0.1 dBm)</td> </tr> <tr> <td>Mexico</td> <td>0 (-0.1 dBm)</td> </tr> <tr> <td>Australia</td> <td>0 (-0.1 dBm)</td> </tr> <tr> <td>France</td> <td>0 (-0.1 dBm)</td> </tr> <tr> <td>Germany</td> <td>0 (-0.1 dBm)</td> </tr> <tr> <td>Netherlands</td> <td>0 (-0.1 dBm)</td> </tr> <tr> <td>United Kingdom</td> <td>0 (-0.1 dBm)</td> </tr> </tbody> </table>	<u>Country</u>	<u>Default</u>	United States	0 (-0.1 dBm)	Canada (French)	0 (-0.1 dBm)	Mexico	0 (-0.1 dBm)	Australia	0 (-0.1 dBm)	France	0 (-0.1 dBm)	Germany	0 (-0.1 dBm)	Netherlands	0 (-0.1 dBm)	United Kingdom	0 (-0.1 dBm)	1 (0 to 255)
<u>Country</u>	<u>Default</u>																			
United States	0 (-0.1 dBm)																			
Canada (French)	0 (-0.1 dBm)																			
Mexico	0 (-0.1 dBm)																			
Australia	0 (-0.1 dBm)																			
France	0 (-0.1 dBm)																			
Germany	0 (-0.1 dBm)																			
Netherlands	0 (-0.1 dBm)																			
United Kingdom	0 (-0.1 dBm)																			

Redialing

Parameter #	Description	Units																		
98*	<p>Repeat call attempts enable. If FALSE, then no automatic redialing is attempted. This parameter is set by the user using the Phone Setup menu.</p> <table border="0"> <thead> <tr> <th><u>Country</u></th> <th><u>Default</u></th> </tr> </thead> <tbody> <tr><td>United States</td><td>1</td></tr> <tr><td>Canada (French)</td><td>1</td></tr> <tr><td>Mexico</td><td>1</td></tr> <tr><td>Australia</td><td>1</td></tr> <tr><td>France</td><td>1</td></tr> <tr><td>Germany</td><td>1</td></tr> <tr><td>Netherlands</td><td>1</td></tr> <tr><td>United Kingdom</td><td>1</td></tr> </tbody> </table>	<u>Country</u>	<u>Default</u>	United States	1	Canada (French)	1	Mexico	1	Australia	1	France	1	Germany	1	Netherlands	1	United Kingdom	1	0 = FALSE 1 = TRUE
<u>Country</u>	<u>Default</u>																			
United States	1																			
Canada (French)	1																			
Mexico	1																			
Australia	1																			
France	1																			
Germany	1																			
Netherlands	1																			
United Kingdom	1																			
99	<p>Redial on busy enable. Determines the condition when redialing may occur. If TRUE then automatic redialing occurs when a call fails due to detection of a valid busy tone sequence.</p> <table border="0"> <thead> <tr> <th><u>Country</u></th> <th><u>Default</u></th> </tr> </thead> <tbody> <tr><td>United States</td><td>1</td></tr> <tr><td>Canada (French)</td><td>1</td></tr> <tr><td>Mexico</td><td>1</td></tr> <tr><td>Australia</td><td>1</td></tr> <tr><td>France</td><td>1</td></tr> <tr><td>Germany</td><td>1</td></tr> <tr><td>Netherlands</td><td>1</td></tr> <tr><td>United Kingdom</td><td>1</td></tr> </tbody> </table>	<u>Country</u>	<u>Default</u>	United States	1	Canada (French)	1	Mexico	1	Australia	1	France	1	Germany	1	Netherlands	1	United Kingdom	1	0 = FALSE 1 = TRUE
<u>Country</u>	<u>Default</u>																			
United States	1																			
Canada (French)	1																			
Mexico	1																			
Australia	1																			
France	1																			
Germany	1																			
Netherlands	1																			
United Kingdom	1																			
100	<p>Redial on no answer enable. Determines the condition when redialing can occur. If TRUE then automatic redialing occurs when a call fails due to no answer from the remote machine.</p> <table border="0"> <thead> <tr> <th><u>Country</u></th> <th><u>Default</u></th> </tr> </thead> <tbody> <tr><td>United States</td><td>0</td></tr> <tr><td>Canada (French)</td><td>0</td></tr> <tr><td>Mexico</td><td>0</td></tr> <tr><td>Australia</td><td>0</td></tr> <tr><td>France</td><td>0</td></tr> <tr><td>Germany</td><td>0</td></tr> <tr><td>Netherlands</td><td>0</td></tr> <tr><td>United Kingdom</td><td>0</td></tr> </tbody> </table>	<u>Country</u>	<u>Default</u>	United States	0	Canada (French)	0	Mexico	0	Australia	0	France	0	Germany	0	Netherlands	0	United Kingdom	0	0 = FALSE 1 = TRUE
<u>Country</u>	<u>Default</u>																			
United States	0																			
Canada (French)	0																			
Mexico	0																			
Australia	0																			
France	0																			
Germany	0																			
Netherlands	0																			
United Kingdom	0																			
101	<p>Repeat call attempt timer 1 same number. Specifies the amount of time between repeat call attempts to the same number when the number of repeat call attempts is less than or equal to NUMBER OF CALL ATTEMPTS TIMER !.</p> <table border="0"> <thead> <tr> <th><u>Country</u></th> <th><u>Default</u></th> </tr> </thead> <tbody> <tr><td>United States</td><td>60</td></tr> <tr><td>Canada (French)</td><td>60</td></tr> <tr><td>Mexico</td><td>60</td></tr> <tr><td>Australia</td><td>60</td></tr> <tr><td>France</td><td>60</td></tr> <tr><td>Germany</td><td>60</td></tr> <tr><td>Netherlands</td><td>60</td></tr> <tr><td>United Kingdom</td><td>60</td></tr> </tbody> </table>	<u>Country</u>	<u>Default</u>	United States	60	Canada (French)	60	Mexico	60	Australia	60	France	60	Germany	60	Netherlands	60	United Kingdom	60	1 sec (0 sec to 1000 secs)
<u>Country</u>	<u>Default</u>																			
United States	60																			
Canada (French)	60																			
Mexico	60																			
Australia	60																			
France	60																			
Germany	60																			
Netherlands	60																			
United Kingdom	60																			

Parameter #	Description	Units																		
102	<p>Repeat call attempt timer 2 same number. Specifies the amount of time between repeat call attempts to the same number when the number of repeat call attempts is greater than NUMBER OF CALL ATTEMPTS ! and less than or equal to NUMBER OF CALL ATTEMPTS TIMER 2.</p> <table border="0"> <thead> <tr> <th><u>Country</u></th> <th><u>Default</u></th> </tr> </thead> <tbody> <tr><td>United States</td><td>300</td></tr> <tr><td>Canada (French)</td><td>300</td></tr> <tr><td>Mexico</td><td>300</td></tr> <tr><td>Australia</td><td>300</td></tr> <tr><td>France</td><td>300</td></tr> <tr><td>Germany</td><td>300</td></tr> <tr><td>Netherlands</td><td>300</td></tr> <tr><td>United Kingdom</td><td>300</td></tr> </tbody> </table>	<u>Country</u>	<u>Default</u>	United States	300	Canada (French)	300	Mexico	300	Australia	300	France	300	Germany	300	Netherlands	300	United Kingdom	300	1 sec (0 sec to 1000 secs)
<u>Country</u>	<u>Default</u>																			
United States	300																			
Canada (French)	300																			
Mexico	300																			
Australia	300																			
France	300																			
Germany	300																			
Netherlands	300																			
United Kingdom	300																			
103	<p>Repeat call attempt timer 3 same number. Specifies amount of time between real call attempts to the same number when the number of repeat call attempts is greater than NUMBER OF CALL ATTEMPTS TIMER 2.</p> <table border="0"> <thead> <tr> <th><u>Country</u></th> <th><u>Default</u></th> </tr> </thead> <tbody> <tr><td>United States</td><td>0</td></tr> <tr><td>Canada (French)</td><td>0</td></tr> <tr><td>Mexico</td><td>0</td></tr> <tr><td>Australia</td><td>0</td></tr> <tr><td>France</td><td>0</td></tr> <tr><td>Germany</td><td>0</td></tr> <tr><td>Netherlands</td><td>0</td></tr> <tr><td>United Kingdom</td><td>0</td></tr> </tbody> </table>	<u>Country</u>	<u>Default</u>	United States	0	Canada (French)	0	Mexico	0	Australia	0	France	0	Germany	0	Netherlands	0	United Kingdom	0	1 sec (0 sec to 1000 secs)
<u>Country</u>	<u>Default</u>																			
United States	0																			
Canada (French)	0																			
Mexico	0																			
Australia	0																			
France	0																			
Germany	0																			
Netherlands	0																			
United Kingdom	0																			
104	<p>Number of call attempts timer 1. Specifies the number of repeat calls that are attempted using REPEAT CALL ATTEMPT TIMER 1 as the interval between call attempts. When this number of repeat calls has been attempted, redialing will continue using NUMBER OF CALL ATTEMPTS TIMER 2.</p> <table border="0"> <thead> <tr> <th><u>Country</u></th> <th><u>Default</u></th> </tr> </thead> <tbody> <tr><td>United States</td><td>1</td></tr> <tr><td>Canada (French)</td><td>1</td></tr> <tr><td>Mexico</td><td>1</td></tr> <tr><td>Australia</td><td>1</td></tr> <tr><td>France</td><td>1</td></tr> <tr><td>Germany</td><td>1</td></tr> <tr><td>Netherlands</td><td>1</td></tr> <tr><td>United Kingdom</td><td>1</td></tr> </tbody> </table>	<u>Country</u>	<u>Default</u>	United States	1	Canada (French)	1	Mexico	1	Australia	1	France	1	Germany	1	Netherlands	1	United Kingdom	1	1 retry (0 retries to 15 retries)
<u>Country</u>	<u>Default</u>																			
United States	1																			
Canada (French)	1																			
Mexico	1																			
Australia	1																			
France	1																			
Germany	1																			
Netherlands	1																			
United Kingdom	1																			
105	<p>Number of call attempts timer 2. Specifies the number if repeat calls that are attempted using REPEAT CALL ATTEMPT TIMER 2 as the interval between call attempts. When this number of repeat calls has been attempted, redialing will continue using NUMBER OF CALL ATTEMPTS TIMER 3.</p> <table border="0"> <thead> <tr> <th><u>Country</u></th> <th><u>Default</u></th> </tr> </thead> <tbody> <tr><td>United States</td><td>4</td></tr> <tr><td>Canada (French)</td><td>4</td></tr> <tr><td>Mexico</td><td>4</td></tr> <tr><td>Australia</td><td>4</td></tr> <tr><td>France</td><td>4</td></tr> <tr><td>Germany</td><td>4</td></tr> <tr><td>Netherlands</td><td>4</td></tr> <tr><td>United Kingdom</td><td>4</td></tr> </tbody> </table>	<u>Country</u>	<u>Default</u>	United States	4	Canada (French)	4	Mexico	4	Australia	4	France	4	Germany	4	Netherlands	4	United Kingdom	4	1 retry (0 retries to 15 retries)
<u>Country</u>	<u>Default</u>																			
United States	4																			
Canada (French)	4																			
Mexico	4																			
Australia	4																			
France	4																			
Germany	4																			
Netherlands	4																			
United Kingdom	4																			

Parameter #	Description	Units																		
106	<p>Number of call attempts timer 3. Specifies the number of repeat calls that are attempted using REPEAT CALL ATTEMPT TIMER 3 as the interval between call attempts. When this number of repeat calls has been attempted, all redialing to the number will be terminated.</p> <table border="1"> <thead> <tr> <th>Country</th> <th>Default</th> </tr> </thead> <tbody> <tr><td>United States</td><td>0</td></tr> <tr><td>Canada (French)</td><td>0</td></tr> <tr><td>Mexico</td><td>0</td></tr> <tr><td>Australia</td><td>0</td></tr> <tr><td>France</td><td>0</td></tr> <tr><td>Germany</td><td>0</td></tr> <tr><td>Netherlands</td><td>0</td></tr> <tr><td>United Kingdom</td><td>0</td></tr> </tbody> </table>	Country	Default	United States	0	Canada (French)	0	Mexico	0	Australia	0	France	0	Germany	0	Netherlands	0	United Kingdom	0	1 retry (0 retries to 15 retries)
Country	Default																			
United States	0																			
Canada (French)	0																			
Mexico	0																			
Australia	0																			
France	0																			
Germany	0																			
Netherlands	0																			
United Kingdom	0																			
107	<p>Blacklist enable. If TRUE, creates a list of numbers which have a history of no answer. Set by the LIU and used only in France.</p> <table border="1"> <thead> <tr> <th>Country</th> <th>Default</th> </tr> </thead> <tbody> <tr><td>United States</td><td>0</td></tr> <tr><td>Canada (French)</td><td>0</td></tr> <tr><td>Mexico</td><td>0</td></tr> <tr><td>Australia</td><td>0</td></tr> <tr><td>France</td><td>1</td></tr> <tr><td>Germany</td><td>0</td></tr> <tr><td>Netherlands</td><td>0</td></tr> <tr><td>United Kingdom</td><td>0</td></tr> </tbody> </table>	Country	Default	United States	0	Canada (French)	0	Mexico	0	Australia	0	France	1	Germany	0	Netherlands	0	United Kingdom	0	0 = FALSE 1 = TRUE
Country	Default																			
United States	0																			
Canada (French)	0																			
Mexico	0																			
Australia	0																			
France	1																			
Germany	0																			
Netherlands	0																			
United Kingdom	0																			

Miscellaneous

Parameter #	Description	Units																		
108	<p>T5 timer. Determines the maximum time that a transmitting machine will wait for a receiving machine to stop sending RNR.</p> <table border="1"> <thead> <tr> <th>Country</th> <th>Default</th> </tr> </thead> <tbody> <tr><td>United States</td><td>240</td></tr> <tr><td>Canada (French)</td><td>240</td></tr> <tr><td>Mexico</td><td>240</td></tr> <tr><td>Australia</td><td>60</td></tr> <tr><td>France</td><td>60</td></tr> <tr><td>Germany</td><td>60</td></tr> <tr><td>Netherlands</td><td>60</td></tr> <tr><td>United Kingdom</td><td>60</td></tr> </tbody> </table>	Country	Default	United States	240	Canada (French)	240	Mexico	240	Australia	60	France	60	Germany	60	Netherlands	60	United Kingdom	60	1 sec (0 sec to 1000 secs)
Country	Default																			
United States	240																			
Canada (French)	240																			
Mexico	240																			
Australia	60																			
France	60																			
Germany	60																			
Netherlands	60																			
United Kingdom	60																			
109	<p>T30 V21 delay. Controls the delay between the end of high speed modem data transmission or tone transmission and the start of transmission of T30 frames.</p> <table border="1"> <thead> <tr> <th>Country</th> <th>Default</th> </tr> </thead> <tbody> <tr><td>United States</td><td>220</td></tr> <tr><td>Canada (French)</td><td>220</td></tr> <tr><td>Mexico</td><td>220</td></tr> <tr><td>Australia</td><td>220</td></tr> <tr><td>France</td><td>80</td></tr> <tr><td>Germany</td><td>80</td></tr> <tr><td>Netherlands</td><td>220</td></tr> <tr><td>United Kingdom</td><td>220</td></tr> </tbody> </table>	Country	Default	United States	220	Canada (French)	220	Mexico	220	Australia	220	France	80	Germany	80	Netherlands	220	United Kingdom	220	1 ms (10 ms to 1000 ms)
Country	Default																			
United States	220																			
Canada (French)	220																			
Mexico	220																			
Australia	220																			
France	80																			
Germany	80																			
Netherlands	220																			
United Kingdom	220																			

Parameter #	Description	Units																		
110	<p>T30 inter frame flags. Controls the number of SDLC flag bytes which are transmitted between successive T30 frames.</p> <table border="0"> <thead> <tr> <th><u>Country</u></th> <th><u>Default</u></th> </tr> </thead> <tbody> <tr> <td>United States</td> <td>4</td> </tr> <tr> <td>Canada (French)</td> <td>4</td> </tr> <tr> <td>Mexico</td> <td>4</td> </tr> <tr> <td>Australia</td> <td>4</td> </tr> <tr> <td>France</td> <td>4</td> </tr> <tr> <td>Germany</td> <td>1</td> </tr> <tr> <td>Netherlands</td> <td>4</td> </tr> <tr> <td>United Kingdom</td> <td>4</td> </tr> </tbody> </table>	<u>Country</u>	<u>Default</u>	United States	4	Canada (French)	4	Mexico	4	Australia	4	France	4	Germany	1	Netherlands	4	United Kingdom	4	1 (1 to 32)
<u>Country</u>	<u>Default</u>																			
United States	4																			
Canada (French)	4																			
Mexico	4																			
Australia	4																			
France	4																			
Germany	1																			
Netherlands	4																			
United Kingdom	4																			
111	<p>Modem dropout abort timer. Specifies the maximum disconnection time from which high speed data reception can recover. Once this time has been exceeded, data reception will be aborted.</p> <table border="0"> <thead> <tr> <th><u>Country</u></th> <th><u>Default</u></th> </tr> </thead> <tbody> <tr> <td>United States</td> <td>5000</td> </tr> <tr> <td>Canada (French)</td> <td>5000</td> </tr> <tr> <td>Mexico</td> <td>5000</td> </tr> <tr> <td>Australia</td> <td>5000</td> </tr> <tr> <td>France</td> <td>5000</td> </tr> <tr> <td>Germany</td> <td>5000</td> </tr> <tr> <td>Netherlands</td> <td>5000</td> </tr> <tr> <td>United Kingdom</td> <td>5000</td> </tr> </tbody> </table>	<u>Country</u>	<u>Default</u>	United States	5000	Canada (French)	5000	Mexico	5000	Australia	5000	France	5000	Germany	5000	Netherlands	5000	United Kingdom	5000	1 ms (1000 ms to 60000 ms)
<u>Country</u>	<u>Default</u>																			
United States	5000																			
Canada (French)	5000																			
Mexico	5000																			
Australia	5000																			
France	5000																			
Germany	5000																			
Netherlands	5000																			
United Kingdom	5000																			
112	<p>Modem post dropout abort timer. Specifies the maximum time the fax session will wait to detect a T30 frame following a data reception abort due to a dropout.</p> <table border="0"> <thead> <tr> <th><u>Country</u></th> <th><u>Default</u></th> </tr> </thead> <tbody> <tr> <td>United States</td> <td>6000</td> </tr> <tr> <td>Canada (French)</td> <td>6000</td> </tr> <tr> <td>Mexico</td> <td>6000</td> </tr> <tr> <td>Australia</td> <td>6000</td> </tr> <tr> <td>France</td> <td>0</td> </tr> <tr> <td>Germany</td> <td>0</td> </tr> <tr> <td>Netherlands</td> <td>6000</td> </tr> <tr> <td>United Kingdom</td> <td>6000</td> </tr> </tbody> </table>	<u>Country</u>	<u>Default</u>	United States	6000	Canada (French)	6000	Mexico	6000	Australia	6000	France	0	Germany	0	Netherlands	6000	United Kingdom	6000	1 ms (0 ms to 60000 ms)
<u>Country</u>	<u>Default</u>																			
United States	6000																			
Canada (French)	6000																			
Mexico	6000																			
Australia	6000																			
France	0																			
Germany	0																			
Netherlands	6000																			
United Kingdom	6000																			
113	<p>Memory Minimum for Receive. Specifies the minimum amount of memory that must be available for a reception prior to automatically starting a reception and receiving a document.</p> <table border="0"> <thead> <tr> <th><u>Country</u></th> <th><u>Default</u></th> </tr> </thead> <tbody> <tr> <td>United States</td> <td>32</td> </tr> <tr> <td>Canada (French)</td> <td>32</td> </tr> <tr> <td>Mexico</td> <td>32</td> </tr> <tr> <td>Australia</td> <td>32</td> </tr> <tr> <td>France</td> <td>32</td> </tr> <tr> <td>Germany</td> <td>32</td> </tr> <tr> <td>Netherlands</td> <td>32</td> </tr> <tr> <td>United Kingdom</td> <td>32</td> </tr> </tbody> </table>	<u>Country</u>	<u>Default</u>	United States	32	Canada (French)	32	Mexico	32	Australia	32	France	32	Germany	32	Netherlands	32	United Kingdom	32	1 kB (1 kB to 60000 kB)
<u>Country</u>	<u>Default</u>																			
United States	32																			
Canada (French)	32																			
Mexico	32																			
Australia	32																			
France	32																			
Germany	32																			
Netherlands	32																			
United Kingdom	32																			

Parameter #	Description	Units																		
114	<p>BZT Compliance Enable. German BZT compliance requires a slightly different T30 implementation. The differences are primarily concerned with handling voice interrupts. If the value = 1 (True), the T30 operation will comply with BZT requirements. If 0 (False), the T30 operation is not in compliance with the CCITT requirement.</p> <table> <thead> <tr> <th><u>Country</u></th> <th><u>Default</u></th> </tr> </thead> <tbody> <tr><td>United States</td><td>0</td></tr> <tr><td>Canada (French)</td><td>0</td></tr> <tr><td>Mexico</td><td>0</td></tr> <tr><td>Australia</td><td>0</td></tr> <tr><td>France</td><td>0</td></tr> <tr><td>Germany</td><td>1</td></tr> <tr><td>Netherlands</td><td>0</td></tr> <tr><td>United Kingdom</td><td>0</td></tr> </tbody> </table>	<u>Country</u>	<u>Default</u>	United States	0	Canada (French)	0	Mexico	0	Australia	0	France	0	Germany	1	Netherlands	0	United Kingdom	0	<p>0 = FALSE 1 = TRUE</p>
<u>Country</u>	<u>Default</u>																			
United States	0																			
Canada (French)	0																			
Mexico	0																			
Australia	0																			
France	0																			
Germany	1																			
Netherlands	0																			
United Kingdom	0																			
115*	<p>Paper size. Determines default paper size. Selected by the user using the Paper Size menu.</p> <table> <thead> <tr> <th><u>Country</u></th> <th><u>Default</u></th> </tr> </thead> <tbody> <tr><td>United States</td><td>2</td></tr> <tr><td>Canada (French)</td><td>2</td></tr> <tr><td>Mexico</td><td>2</td></tr> <tr><td>Australia</td><td>26</td></tr> <tr><td>France</td><td>26</td></tr> <tr><td>Germany</td><td>26</td></tr> <tr><td>Netherlands</td><td>26</td></tr> <tr><td>United Kingdom</td><td>26</td></tr> </tbody> </table>	<u>Country</u>	<u>Default</u>	United States	2	Canada (French)	2	Mexico	2	Australia	26	France	26	Germany	26	Netherlands	26	United Kingdom	26	<p>1 = Exec 2 = Letter 3 = Legal 26 = A4 81 =Envelope</p>
<u>Country</u>	<u>Default</u>																			
United States	2																			
Canada (French)	2																			
Mexico	2																			
Australia	26																			
France	26																			
Germany	26																			
Netherlands	26																			
United Kingdom	26																			
116*	<p>Time format. Determines the default time format. Selected by the user in the Time/Date menu.</p> <table> <thead> <tr> <th><u>Country</u></th> <th><u>Default</u></th> </tr> </thead> <tbody> <tr><td>United States</td><td>0</td></tr> <tr><td>Canada (French)</td><td>0</td></tr> <tr><td>Mexico</td><td>0</td></tr> <tr><td>Australia</td><td>1</td></tr> <tr><td>France</td><td>1</td></tr> <tr><td>Germany</td><td>1</td></tr> <tr><td>Netherlands</td><td>1</td></tr> <tr><td>United Kingdom</td><td>1</td></tr> </tbody> </table>	<u>Country</u>	<u>Default</u>	United States	0	Canada (French)	0	Mexico	0	Australia	1	France	1	Germany	1	Netherlands	1	United Kingdom	1	<p>0 = AM/PM 1 = 24 hr</p>
<u>Country</u>	<u>Default</u>																			
United States	0																			
Canada (French)	0																			
Mexico	0																			
Australia	1																			
France	1																			
Germany	1																			
Netherlands	1																			
United Kingdom	1																			
117*	<p>Date format. Determines the default date format. Selected by the user in the Time/Date menu.</p> <table> <thead> <tr> <th><u>Country</u></th> <th><u>Default</u></th> </tr> </thead> <tbody> <tr><td>United States</td><td>1</td></tr> <tr><td>Canada (French)</td><td>1</td></tr> <tr><td>Mexico</td><td>1</td></tr> <tr><td>Australia</td><td>0</td></tr> <tr><td>France</td><td>0</td></tr> <tr><td>Germany</td><td>0</td></tr> <tr><td>Netherlands</td><td>0</td></tr> <tr><td>United Kingdom</td><td>0</td></tr> </tbody> </table>	<u>Country</u>	<u>Default</u>	United States	1	Canada (French)	1	Mexico	1	Australia	0	France	0	Germany	0	Netherlands	0	United Kingdom	0	<p>0=ddmmyy 1=mmddy</p>
<u>Country</u>	<u>Default</u>																			
United States	1																			
Canada (French)	1																			
Mexico	1																			
Australia	0																			
France	0																			
Germany	0																			
Netherlands	0																			
United Kingdom	0																			

Parameter #	Description	Units																		
118	<p>Language index. Determines the language used by OfficeJet in the front panel display and on reports. Selected by the LIU. Also selected from the Service and Factory menu.</p> <table> <thead> <tr> <th><u>Country</u></th> <th><u>Default</u></th> </tr> </thead> <tbody> <tr> <td>United States</td> <td>0</td> </tr> <tr> <td>Canada (French)</td> <td>2</td> </tr> <tr> <td>Mexico</td> <td>0</td> </tr> <tr> <td>Australia</td> <td>0</td> </tr> <tr> <td>France</td> <td>2</td> </tr> <tr> <td>Germany</td> <td>1</td> </tr> <tr> <td>Netherlands</td> <td>5</td> </tr> <tr> <td>United Kingdom</td> <td>0</td> </tr> </tbody> </table>	<u>Country</u>	<u>Default</u>	United States	0	Canada (French)	2	Mexico	0	Australia	0	France	2	Germany	1	Netherlands	5	United Kingdom	0	0=English 1=German 2=French 5=Dutch
<u>Country</u>	<u>Default</u>																			
United States	0																			
Canada (French)	2																			
Mexico	0																			
Australia	0																			
France	2																			
Germany	1																			
Netherlands	5																			
United Kingdom	0																			
119	<p>PSTN dial tone maximum on time. Maximum duration a cadenced PSTN dial tone can be present for a cadenced sequence to be valid.</p> <table> <thead> <tr> <th><u>Country</u></th> <th><u>Default</u></th> </tr> </thead> <tbody> <tr> <td>United States</td> <td>0</td> </tr> <tr> <td>Canada (French)</td> <td>0</td> </tr> <tr> <td>Mexico</td> <td>0</td> </tr> <tr> <td>Australia</td> <td>0</td> </tr> <tr> <td>France</td> <td>0</td> </tr> <tr> <td>Germany</td> <td>0</td> </tr> <tr> <td>Netherlands</td> <td>0</td> </tr> <tr> <td>United Kingdom</td> <td>0</td> </tr> </tbody> </table>	<u>Country</u>	<u>Default</u>	United States	0	Canada (French)	0	Mexico	0	Australia	0	France	0	Germany	0	Netherlands	0	United Kingdom	0	1 ms (0 ms to 4000 ms)
<u>Country</u>	<u>Default</u>																			
United States	0																			
Canada (French)	0																			
Mexico	0																			
Australia	0																			
France	0																			
Germany	0																			
Netherlands	0																			
United Kingdom	0																			
120	<p>Special dial tone maximum on time. Maximum duration a cadenced special dial tone can be present for a cadenced sequence to be valid.</p> <table> <thead> <tr> <th><u>Country</u></th> <th><u>Default</u></th> </tr> </thead> <tbody> <tr> <td>United States</td> <td>0</td> </tr> <tr> <td>Canada (French)</td> <td>0</td> </tr> <tr> <td>Mexico</td> <td>0</td> </tr> <tr> <td>Australia</td> <td>0</td> </tr> <tr> <td>France</td> <td>0</td> </tr> <tr> <td>Germany</td> <td>0</td> </tr> <tr> <td>Netherlands</td> <td>0</td> </tr> <tr> <td>United Kingdom</td> <td>0</td> </tr> </tbody> </table>	<u>Country</u>	<u>Default</u>	United States	0	Canada (French)	0	Mexico	0	Australia	0	France	0	Germany	0	Netherlands	0	United Kingdom	0	1 ms (0 ms to 4000 ms)
<u>Country</u>	<u>Default</u>																			
United States	0																			
Canada (French)	0																			
Mexico	0																			
Australia	0																			
France	0																			
Germany	0																			
Netherlands	0																			
United Kingdom	0																			
121	<p>CED detect threshold. Sets the detection threshold for the CED tone. If the CED tone is below this level it will not be detected.</p> <table> <thead> <tr> <th><u>Country</u></th> <th><u>Default</u></th> </tr> </thead> <tbody> <tr> <td>United States</td> <td>470 (-47 dBm)</td> </tr> <tr> <td>Canada (French)</td> <td>470 (-47 dBm)</td> </tr> <tr> <td>Mexico</td> <td>470 (-47 dBm)</td> </tr> <tr> <td>Australia</td> <td>470 (-0.1 dBm)</td> </tr> <tr> <td>France</td> <td>470 (-0.1 dBm)</td> </tr> <tr> <td>Germany</td> <td>470 (-0.1 dBm)</td> </tr> <tr> <td>Netherlands</td> <td>470 (-0.1 dBm)</td> </tr> <tr> <td>United Kingdom</td> <td>470 (-0.1 dBm)</td> </tr> </tbody> </table>	<u>Country</u>	<u>Default</u>	United States	470 (-47 dBm)	Canada (French)	470 (-47 dBm)	Mexico	470 (-47 dBm)	Australia	470 (-0.1 dBm)	France	470 (-0.1 dBm)	Germany	470 (-0.1 dBm)	Netherlands	470 (-0.1 dBm)	United Kingdom	470 (-0.1 dBm)	1 (260 to 510)
<u>Country</u>	<u>Default</u>																			
United States	470 (-47 dBm)																			
Canada (French)	470 (-47 dBm)																			
Mexico	470 (-47 dBm)																			
Australia	470 (-0.1 dBm)																			
France	470 (-0.1 dBm)																			
Germany	470 (-0.1 dBm)																			
Netherlands	470 (-0.1 dBm)																			
United Kingdom	470 (-0.1 dBm)																			

Parameter #	Description	Units																		
122	<p>Line type. Determines the type of telephone line that the OfficeJet is connected to. This can either be the public switched telephone network (PSTN) or a private branch exchange (PBX). The different selections cause OfficeJet to make different checks for dial tone and use different length delays depending upon how the other relevant parameters are set.</p> <table> <thead> <tr> <th><u>Country</u></th> <th><u>Default</u></th> </tr> </thead> <tbody> <tr><td>United States</td><td>0</td></tr> <tr><td>Canada (French)</td><td>0</td></tr> <tr><td>Mexico</td><td>0</td></tr> <tr><td>Australia</td><td>0</td></tr> <tr><td>France</td><td>0</td></tr> <tr><td>Germany</td><td>0</td></tr> <tr><td>Netherlands</td><td>0</td></tr> <tr><td>United Kingdom</td><td>0</td></tr> </tbody> </table>	<u>Country</u>	<u>Default</u>	United States	0	Canada (French)	0	Mexico	0	Australia	0	France	0	Germany	0	Netherlands	0	United Kingdom	0	0 = PSTN 1 = PBX
<u>Country</u>	<u>Default</u>																			
United States	0																			
Canada (French)	0																			
Mexico	0																			
Australia	0																			
France	0																			
Germany	0																			
Netherlands	0																			
United Kingdom	0																			
123	<p>Flash type. Determines the type of flash that the machine will produce for countries supporting the flash key. Flash keys are used for accessing outside lines or other features of PBX telephone systems where a flash signal is required.</p> <table> <thead> <tr> <th><u>Country</u></th> <th><u>Default</u></th> </tr> </thead> <tbody> <tr><td>United States</td><td>1</td></tr> <tr><td>Canada (French)</td><td>1</td></tr> <tr><td>Mexico</td><td>1</td></tr> <tr><td>Australia</td><td>1</td></tr> <tr><td>France</td><td>1</td></tr> <tr><td>Germany</td><td>1</td></tr> <tr><td>Netherlands</td><td>1</td></tr> <tr><td>United Kingdom</td><td>1</td></tr> </tbody> </table>	<u>Country</u>	<u>Default</u>	United States	1	Canada (French)	1	Mexico	1	Australia	1	France	1	Germany	1	Netherlands	1	United Kingdom	1	0=No flash 1=Open 2=Earth
<u>Country</u>	<u>Default</u>																			
United States	1																			
Canada (French)	1																			
Mexico	1																			
Australia	1																			
France	1																			
Germany	1																			
Netherlands	1																			
United Kingdom	1																			
124	<p>Open flash time. Controls the duration of the open flash when OfficeJet is configured to produce this flash type.</p> <table> <thead> <tr> <th><u>Country</u></th> <th><u>Default</u></th> </tr> </thead> <tbody> <tr><td>United States</td><td>800</td></tr> <tr><td>Canada (French)</td><td>800</td></tr> <tr><td>Mexico</td><td>800</td></tr> <tr><td>Australia</td><td>800</td></tr> <tr><td>France</td><td>270</td></tr> <tr><td>Germany</td><td>110</td></tr> <tr><td>Netherlands</td><td>110</td></tr> <tr><td>United Kingdom</td><td>110</td></tr> </tbody> </table>	<u>Country</u>	<u>Default</u>	United States	800	Canada (French)	800	Mexico	800	Australia	800	France	270	Germany	110	Netherlands	110	United Kingdom	110	1 ms (50 ms to 2000 ms)
<u>Country</u>	<u>Default</u>																			
United States	800																			
Canada (French)	800																			
Mexico	800																			
Australia	800																			
France	270																			
Germany	110																			
Netherlands	110																			
United Kingdom	110																			
125	<p>Earth flash time. Controls the duration of the earth flash when OfficeJet is configured to product this flash type.</p> <table> <thead> <tr> <th><u>Country</u></th> <th><u>Default</u></th> </tr> </thead> <tbody> <tr><td>United States</td><td>300</td></tr> <tr><td>Canada (French)</td><td>300</td></tr> <tr><td>Mexico</td><td>300</td></tr> <tr><td>Australia</td><td>300</td></tr> <tr><td>France</td><td>300</td></tr> <tr><td>Germany</td><td>300</td></tr> <tr><td>Netherlands</td><td>300</td></tr> <tr><td>United Kingdom</td><td>300</td></tr> </tbody> </table>	<u>Country</u>	<u>Default</u>	United States	300	Canada (French)	300	Mexico	300	Australia	300	France	300	Germany	300	Netherlands	300	United Kingdom	300	1 ms (50 ms to 2000 ms)
<u>Country</u>	<u>Default</u>																			
United States	300																			
Canada (French)	300																			
Mexico	300																			
Australia	300																			
France	300																			
Germany	300																			
Netherlands	300																			
United Kingdom	300																			

Parameter #	Description	Units																		
126	<p>PBX pre dial pause mode. Specifies what type of pause OfficeJet will perform before dialing when configured for PBX operation. If BLIND WAIT, OfficeJet will delay PBX WAIT BEFORE BLIND DIALING before dialing. If CHECK FOR TONE, OfficeJet will attempt to detect a PSTN dial tone. If CHECK FOR SPECIAL TONE, OfficeJet will attempt to detect a special tone.</p> <table border="1"> <thead> <tr> <th><u>Country</u></th> <th><u>Default</u></th> </tr> </thead> <tbody> <tr><td>United States</td><td>0</td></tr> <tr><td>Canada (French)</td><td>0</td></tr> <tr><td>Mexico</td><td>0</td></tr> <tr><td>Australia</td><td>0</td></tr> <tr><td>France</td><td>0</td></tr> <tr><td>Germany</td><td>0</td></tr> <tr><td>Netherlands</td><td>0</td></tr> <tr><td>United Kingdom</td><td>0</td></tr> </tbody> </table>	<u>Country</u>	<u>Default</u>	United States	0	Canada (French)	0	Mexico	0	Australia	0	France	0	Germany	0	Netherlands	0	United Kingdom	0	0=BLIND WAIT 1=CHECK FOR TONE 2=CHECK FOR SPCL TONE
<u>Country</u>	<u>Default</u>																			
United States	0																			
Canada (French)	0																			
Mexico	0																			
Australia	0																			
France	0																			
Germany	0																			
Netherlands	0																			
United Kingdom	0																			
127	<p>PBX wait before blind dialing. The delay from OFF hook to the start of dialing when blind dialing and OfficeJet is configured for PBX operation.</p> <table border="1"> <thead> <tr> <th><u>Country</u></th> <th><u>Default</u></th> </tr> </thead> <tbody> <tr><td>United States</td><td>2000</td></tr> <tr><td>Canada (French)</td><td>2000</td></tr> <tr><td>Mexico</td><td>2000</td></tr> <tr><td>Australia</td><td>2000</td></tr> <tr><td>France</td><td>2000</td></tr> <tr><td>Germany</td><td>3000</td></tr> <tr><td>Netherlands</td><td>5000</td></tr> <tr><td>United Kingdom</td><td>2000</td></tr> </tbody> </table>	<u>Country</u>	<u>Default</u>	United States	2000	Canada (French)	2000	Mexico	2000	Australia	2000	France	2000	Germany	3000	Netherlands	5000	United Kingdom	2000	1 ms (0 ms to 15000 ms)
<u>Country</u>	<u>Default</u>																			
United States	2000																			
Canada (French)	2000																			
Mexico	2000																			
Australia	2000																			
France	2000																			
Germany	3000																			
Netherlands	5000																			
United Kingdom	2000																			
128	<p>Auto Pause Insert Enable. Specifies if s pause is automatically inserted into a dial string when a “special” string is encountered. For example: In France, the string 16 is used for international access. If this parameter was 1 (True) and the string 1614071234567 was entered, the machine would dial 16, pause, then dial the rest of the string.</p> <table border="1"> <thead> <tr> <th><u>Country</u></th> <th><u>Default</u></th> </tr> </thead> <tbody> <tr><td>United States</td><td>0</td></tr> <tr><td>Canada (French)</td><td>0</td></tr> <tr><td>Mexico</td><td>0</td></tr> <tr><td>Australia</td><td>0</td></tr> <tr><td>France</td><td>1</td></tr> <tr><td>Germany</td><td>0</td></tr> <tr><td>Netherlands</td><td>0</td></tr> <tr><td>United Kingdom</td><td>0</td></tr> </tbody> </table>	<u>Country</u>	<u>Default</u>	United States	0	Canada (French)	0	Mexico	0	Australia	0	France	1	Germany	0	Netherlands	0	United Kingdom	0	0 = FALSE 1 = TRUE
<u>Country</u>	<u>Default</u>																			
United States	0																			
Canada (French)	0																			
Mexico	0																			
Australia	0																			
France	1																			
Germany	0																			
Netherlands	0																			
United Kingdom	0																			
130*	<p>Automatic reports. Determines when a journal report will be printed automatically. Selected by the user with the Reports/FAX Log menu. Default value = 3.</p> <table border="1"> <thead> <tr> <th><u>Country</u></th> <th><u>Default</u></th> </tr> </thead> <tbody> <tr><td>United States</td><td>3</td></tr> <tr><td>Canada (French)</td><td>3</td></tr> <tr><td>Mexico</td><td>3</td></tr> <tr><td>Australia</td><td>3</td></tr> <tr><td>France</td><td>3</td></tr> <tr><td>Germany</td><td>3</td></tr> <tr><td>Netherlands</td><td>3</td></tr> <tr><td>United Kingdom</td><td>3</td></tr> </tbody> </table>	<u>Country</u>	<u>Default</u>	United States	3	Canada (French)	3	Mexico	3	Australia	3	France	3	Germany	3	Netherlands	3	United Kingdom	3	0= OFF 1=Send or Error 2=Send only 3=Error only
<u>Country</u>	<u>Default</u>																			
United States	3																			
Canada (French)	3																			
Mexico	3																			
Australia	3																			
France	3																			
Germany	3																			
Netherlands	3																			
United Kingdom	3																			

Parameter #	Description	Units																		
132*	<p>Character set. Selected by the user with the Printer menu. Default value = 1.</p> <table border="1"> <thead> <tr> <th><u>Country</u></th> <th><u>Default</u></th> </tr> </thead> <tbody> <tr><td>United States</td><td>1</td></tr> <tr><td>Canada (French)</td><td>1</td></tr> <tr><td>Mexico</td><td>1</td></tr> <tr><td>Australia</td><td>1</td></tr> <tr><td>France</td><td>1</td></tr> <tr><td>Germany</td><td>1</td></tr> <tr><td>Netherlands</td><td>1</td></tr> <tr><td>United Kingdom</td><td>1</td></tr> </tbody> </table>	<u>Country</u>	<u>Default</u>	United States	1	Canada (French)	1	Mexico	1	Australia	1	France	1	Germany	1	Netherlands	1	United Kingdom	1	1=PC-8 2=HP Roman-8 3=PC-8 Danish Nor 4=UK ISO 4 5=German ISO 21 6=French ISO 69 7=Italian ISO 15 8=Nor V.1 ISO 60 9=SWED Names ISO 11 10=Spanish ISO 17 11=ASCII 12=Portug ISO 16 13=PC 850 14=ECMA 94 Latin 1 15=HP Legal
<u>Country</u>	<u>Default</u>																			
United States	1																			
Canada (French)	1																			
Mexico	1																			
Australia	1																			
France	1																			
Germany	1																			
Netherlands	1																			
United Kingdom	1																			
133*	<p>Carriage return mode. Defines which character are recognized to produce a carriage return. Selected by the user with the Printer Settings menu. Default value = 0.</p> <table border="1"> <thead> <tr> <th><u>Country</u></th> <th><u>Default</u></th> </tr> </thead> <tbody> <tr><td>United States</td><td>0</td></tr> <tr><td>Canada (French)</td><td>0</td></tr> <tr><td>Mexico</td><td>0</td></tr> <tr><td>Australia</td><td>0</td></tr> <tr><td>France</td><td>0</td></tr> <tr><td>Germany</td><td>0</td></tr> <tr><td>Netherlands</td><td>0</td></tr> <tr><td>United Kingdom</td><td>0</td></tr> </tbody> </table>	<u>Country</u>	<u>Default</u>	United States	0	Canada (French)	0	Mexico	0	Australia	0	France	0	Germany	0	Netherlands	0	United Kingdom	0	0=CR only 1=CR & LF
<u>Country</u>	<u>Default</u>																			
United States	0																			
Canada (French)	0																			
Mexico	0																			
Australia	0																			
France	0																			
Germany	0																			
Netherlands	0																			
United Kingdom	0																			
134*	<p>Perforation skip mode. For Dos applications. When TRUE in portrait orientation, the top and bottom margins are both .5 in. (13mm) with 60 lines per page. Selected by the user from the Printer Settings Menu. Default value = 1.</p> <table border="1"> <thead> <tr> <th><u>Country</u></th> <th><u>Default</u></th> </tr> </thead> <tbody> <tr><td>United States</td><td>1</td></tr> <tr><td>Canada (French)</td><td>1</td></tr> <tr><td>Mexico</td><td>1</td></tr> <tr><td>Australia</td><td>1</td></tr> <tr><td>France</td><td>1</td></tr> <tr><td>Germany</td><td>1</td></tr> <tr><td>Netherlands</td><td>1</td></tr> <tr><td>United Kingdom</td><td>1</td></tr> </tbody> </table>	<u>Country</u>	<u>Default</u>	United States	1	Canada (French)	1	Mexico	1	Australia	1	France	1	Germany	1	Netherlands	1	United Kingdom	1	0 = FALSE 1 = TRUE
<u>Country</u>	<u>Default</u>																			
United States	1																			
Canada (French)	1																			
Mexico	1																			
Australia	1																			
France	1																			
Germany	1																			
Netherlands	1																			
United Kingdom	1																			

Parameter #	Description	Units																		
135*	<p>Text scale mode. Used to print either 63 or 66 lines of text on a portrait-oriented page. Does not affect printing in landscape mode. Default value = 63.</p> <table border="1"> <thead> <tr> <th><u>Country</u></th> <th><u>Default</u></th> </tr> </thead> <tbody> <tr><td>United States</td><td>63</td></tr> <tr><td>Canada (French)</td><td>63</td></tr> <tr><td>Mexico</td><td>63</td></tr> <tr><td>Australia</td><td>63</td></tr> <tr><td>France</td><td>63</td></tr> <tr><td>Germany</td><td>63</td></tr> <tr><td>Netherlands</td><td>63</td></tr> <tr><td>United Kingdom</td><td>63</td></tr> </tbody> </table>	<u>Country</u>	<u>Default</u>	United States	63	Canada (French)	63	Mexico	63	Australia	63	France	63	Germany	63	Netherlands	63	United Kingdom	63	63 or 66
<u>Country</u>	<u>Default</u>																			
United States	63																			
Canada (French)	63																			
Mexico	63																			
Australia	63																			
France	63																			
Germany	63																			
Netherlands	63																			
United Kingdom	63																			
136*	<p>Ringer Noise. If TRUE, ringer is enabled. Selected by the user from the Phone Setup menu. Default value = 1.</p> <table border="1"> <thead> <tr> <th><u>Country</u></th> <th><u>Default</u></th> </tr> </thead> <tbody> <tr><td>United States</td><td>1</td></tr> <tr><td>Canada (French)</td><td>1</td></tr> <tr><td>Mexico</td><td>1</td></tr> <tr><td>Australia</td><td>1</td></tr> <tr><td>France</td><td>1</td></tr> <tr><td>Germany</td><td>1</td></tr> <tr><td>Netherlands</td><td>1</td></tr> <tr><td>United Kingdom</td><td>1</td></tr> </tbody> </table>	<u>Country</u>	<u>Default</u>	United States	1	Canada (French)	1	Mexico	1	Australia	1	France	1	Germany	1	Netherlands	1	United Kingdom	1	0 = FALSE 1 = TRUE
<u>Country</u>	<u>Default</u>																			
United States	1																			
Canada (French)	1																			
Mexico	1																			
Australia	1																			
France	1																			
Germany	1																			
Netherlands	1																			
United Kingdom	1																			
138	<p>Print TTI header. If TRUE, the header identification will be included on each fax page sent by OfficeJet. Default value = 1.</p> <table border="1"> <thead> <tr> <th><u>Country</u></th> <th><u>Default</u></th> </tr> </thead> <tbody> <tr><td>United States</td><td>1</td></tr> <tr><td>Canada (French)</td><td>1</td></tr> <tr><td>Mexico</td><td>1</td></tr> <tr><td>Australia</td><td>1</td></tr> <tr><td>France</td><td>1</td></tr> <tr><td>Germany</td><td>1</td></tr> <tr><td>Netherlands</td><td>1</td></tr> <tr><td>United Kingdom</td><td>1</td></tr> </tbody> </table>	<u>Country</u>	<u>Default</u>	United States	1	Canada (French)	1	Mexico	1	Australia	1	France	1	Germany	1	Netherlands	1	United Kingdom	1	0 = FALSE 1 = TRUE
<u>Country</u>	<u>Default</u>																			
United States	1																			
Canada (French)	1																			
Mexico	1																			
Australia	1																			
France	1																			
Germany	1																			
Netherlands	1																			
United Kingdom	1																			
139*	<p>Backup receive mode. If TRUE, received faxes will be received and stored into memory if the not able to be printed out. 400K bytes of memory is available for backup reception. This parameter is selected by the user from the Fax Settings menu. Default value = 1.</p> <table border="1"> <thead> <tr> <th><u>Country</u></th> <th><u>Default</u></th> </tr> </thead> <tbody> <tr><td>United States</td><td>1</td></tr> <tr><td>Canada (French)</td><td>1</td></tr> <tr><td>Mexico</td><td>1</td></tr> <tr><td>Australia</td><td>1</td></tr> <tr><td>France</td><td>1</td></tr> <tr><td>Germany</td><td>1</td></tr> <tr><td>Netherlands</td><td>1</td></tr> <tr><td>United Kingdom</td><td>1</td></tr> </tbody> </table>	<u>Country</u>	<u>Default</u>	United States	1	Canada (French)	1	Mexico	1	Australia	1	France	1	Germany	1	Netherlands	1	United Kingdom	1	0 = FALSE 1 = TRUE
<u>Country</u>	<u>Default</u>																			
United States	1																			
Canada (French)	1																			
Mexico	1																			
Australia	1																			
France	1																			
Germany	1																			
Netherlands	1																			
United Kingdom	1																			

Parameter #	Description	Units																		
140*	<p>Fax reduction. Sets the amount of reduction applied to received faxes. User may choose either OFF or ON where the amount of reduction is applied automatically based on the size of the incoming fax and media available for printing. Default value = 0%.</p> <table border="0"> <thead> <tr> <th><u>Country</u></th> <th><u>Default</u></th> </tr> </thead> <tbody> <tr><td>United States</td><td>0</td></tr> <tr><td>Canada (French)</td><td>0</td></tr> <tr><td>Mexico</td><td>0</td></tr> <tr><td>Australia</td><td>0</td></tr> <tr><td>France</td><td>0</td></tr> <tr><td>Germany</td><td>0</td></tr> <tr><td>Netherlands</td><td>0</td></tr> <tr><td>United Kingdom</td><td>0</td></tr> </tbody> </table>	<u>Country</u>	<u>Default</u>	United States	0	Canada (French)	0	Mexico	0	Australia	0	France	0	Germany	0	Netherlands	0	United Kingdom	0	0 = OFF 100 = ON 1 (70 to 100)
<u>Country</u>	<u>Default</u>																			
United States	0																			
Canada (French)	0																			
Mexico	0																			
Australia	0																			
France	0																			
Germany	0																			
Netherlands	0																			
United Kingdom	0																			
141*	<p>Beep volume. Users may select SOFT or LOUD from the Phone Setup menu. Default value = 1.</p> <table border="0"> <thead> <tr> <th><u>Country</u></th> <th><u>Default</u></th> </tr> </thead> <tbody> <tr><td>United States</td><td>1</td></tr> <tr><td>Canada (French)</td><td>1</td></tr> <tr><td>Mexico</td><td>1</td></tr> <tr><td>Australia</td><td>1</td></tr> <tr><td>France</td><td>1</td></tr> <tr><td>Germany</td><td>1</td></tr> <tr><td>Netherlands</td><td>1</td></tr> <tr><td>United Kingdom</td><td>1</td></tr> </tbody> </table>	<u>Country</u>	<u>Default</u>	United States	1	Canada (French)	1	Mexico	1	Australia	1	France	1	Germany	1	Netherlands	1	United Kingdom	1	0 = OFF 1 = SOFT 2 = LOUD
<u>Country</u>	<u>Default</u>																			
United States	1																			
Canada (French)	1																			
Mexico	1																			
Australia	1																			
France	1																			
Germany	1																			
Netherlands	1																			
United Kingdom	1																			
142*	<p>Fixed copy reduction. Users may select 100%, 95%, 90%, 85%, 80%, 75% legal-to-letter, and 70% from the Copier Settings menu. Default value = 100%.</p> <table border="0"> <thead> <tr> <th><u>Country</u></th> <th><u>Default</u></th> </tr> </thead> <tbody> <tr><td>United States</td><td>100</td></tr> <tr><td>Canada (French)</td><td>100</td></tr> <tr><td>Mexico</td><td>100</td></tr> <tr><td>Australia</td><td>100</td></tr> <tr><td>France</td><td>100</td></tr> <tr><td>Germany</td><td>100</td></tr> <tr><td>Netherlands</td><td>100</td></tr> <tr><td>United Kingdom</td><td>100</td></tr> </tbody> </table>	<u>Country</u>	<u>Default</u>	United States	100	Canada (French)	100	Mexico	100	Australia	100	France	100	Germany	100	Netherlands	100	United Kingdom	100	1 (70 to 100)
<u>Country</u>	<u>Default</u>																			
United States	100																			
Canada (French)	100																			
Mexico	100																			
Australia	100																			
France	100																			
Germany	100																			
Netherlands	100																			
United Kingdom	100																			
143*	<p>Scanner contrast. User selects from the FAX/Copy Contrast menu. Default value = 1.</p> <table border="0"> <thead> <tr> <th><u>Country</u></th> <th><u>Default</u></th> </tr> </thead> <tbody> <tr><td>United States</td><td>1</td></tr> <tr><td>Canada (French)</td><td>1</td></tr> <tr><td>Mexico</td><td>1</td></tr> <tr><td>Australia</td><td>1</td></tr> <tr><td>France</td><td>1</td></tr> <tr><td>Germany</td><td>1</td></tr> <tr><td>Netherlands</td><td>1</td></tr> <tr><td>United Kingdom</td><td>1</td></tr> </tbody> </table>	<u>Country</u>	<u>Default</u>	United States	1	Canada (French)	1	Mexico	1	Australia	1	France	1	Germany	1	Netherlands	1	United Kingdom	1	0 = Light 1 = Normal 2 = Dark
<u>Country</u>	<u>Default</u>																			
United States	1																			
Canada (French)	1																			
Mexico	1																			
Australia	1																			
France	1																			
Germany	1																			
Netherlands	1																			
United Kingdom	1																			

Parameter #	Description	Units																		
144*	<p>FAX resolution. Controls the STANDARD and FINE resolution settings. Used in conjunction with parameter 145 to define PHOTO resolution. User selects from the <Resolution> key. Default value = 0.</p> <table border="0"> <thead> <tr> <th><u>Country</u></th> <th><u>Default</u></th> </tr> </thead> <tbody> <tr><td>United States</td><td>0</td></tr> <tr><td>Canada (French)</td><td>0</td></tr> <tr><td>Mexico</td><td>0</td></tr> <tr><td>Australia</td><td>0</td></tr> <tr><td>France</td><td>0</td></tr> <tr><td>Germany</td><td>0</td></tr> <tr><td>Netherlands</td><td>0</td></tr> <tr><td>United Kingdom</td><td>0</td></tr> </tbody> </table>	<u>Country</u>	<u>Default</u>	United States	0	Canada (French)	0	Mexico	0	Australia	0	France	0	Germany	0	Netherlands	0	United Kingdom	0	0=Standard 1=Fine
<u>Country</u>	<u>Default</u>																			
United States	0																			
Canada (French)	0																			
Mexico	0																			
Australia	0																			
France	0																			
Germany	0																			
Netherlands	0																			
United Kingdom	0																			
145*	<p>FAX halftone. Will select PHOTO resolution if parameter 144 is set to FINE. User selects from the <Resolution> key. Default value = 0.</p> <table border="0"> <thead> <tr> <th><u>Country</u></th> <th><u>Default</u></th> </tr> </thead> <tbody> <tr><td>United States</td><td>0</td></tr> <tr><td>Canada (French)</td><td>0</td></tr> <tr><td>Mexico</td><td>0</td></tr> <tr><td>Australia</td><td>0</td></tr> <tr><td>France</td><td>0</td></tr> <tr><td>Germany</td><td>0</td></tr> <tr><td>Netherlands</td><td>0</td></tr> <tr><td>United Kingdom</td><td>0</td></tr> </tbody> </table>	<u>Country</u>	<u>Default</u>	United States	0	Canada (French)	0	Mexico	0	Australia	0	France	0	Germany	0	Netherlands	0	United Kingdom	0	0 = FALSE 1 = TRUE
<u>Country</u>	<u>Default</u>																			
United States	0																			
Canada (French)	0																			
Mexico	0																			
Australia	0																			
France	0																			
Germany	0																			
Netherlands	0																			
United Kingdom	0																			
148	<p>Speaker mode. Default value = 1.</p> <table border="0"> <thead> <tr> <th><u>Country</u></th> <th><u>Default</u></th> </tr> </thead> <tbody> <tr><td>United States</td><td>1</td></tr> <tr><td>Canada (French)</td><td>1</td></tr> <tr><td>Mexico</td><td>1</td></tr> <tr><td>Australia</td><td>1</td></tr> <tr><td>France</td><td>1</td></tr> <tr><td>Germany</td><td>1</td></tr> <tr><td>Netherlands</td><td>1</td></tr> <tr><td>United Kingdom</td><td>1</td></tr> </tbody> </table>	<u>Country</u>	<u>Default</u>	United States	1	Canada (French)	1	Mexico	1	Australia	1	France	1	Germany	1	Netherlands	1	United Kingdom	1	0 = Disable speaker 1 = Enable speaker 2 = Enable speaker always
<u>Country</u>	<u>Default</u>																			
United States	1																			
Canada (French)	1																			
Mexico	1																			
Australia	1																			
France	1																			
Germany	1																			
Netherlands	1																			
United Kingdom	1																			
149*	<p>Button beeps. User may select from the Phone Setup menu. Default value = 1</p> <table border="0"> <thead> <tr> <th><u>Country</u></th> <th><u>Default</u></th> </tr> </thead> <tbody> <tr><td>United States</td><td>1</td></tr> <tr><td>Canada (French)</td><td>1</td></tr> <tr><td>Mexico</td><td>1</td></tr> <tr><td>Australia</td><td>1</td></tr> <tr><td>France</td><td>1</td></tr> <tr><td>Germany</td><td>1</td></tr> <tr><td>Netherlands</td><td>1</td></tr> <tr><td>United Kingdom</td><td>1</td></tr> </tbody> </table>	<u>Country</u>	<u>Default</u>	United States	1	Canada (French)	1	Mexico	1	Australia	1	France	1	Germany	1	Netherlands	1	United Kingdom	1	0 = OFF 1 = On
<u>Country</u>	<u>Default</u>																			
United States	1																			
Canada (French)	1																			
Mexico	1																			
Australia	1																			
France	1																			
Germany	1																			
Netherlands	1																			
United Kingdom	1																			

Parameter #	Description	Units																		
150	<p>Menu flags. Not currently used. Default value = 0.</p> <table border="1"> <thead> <tr> <th><u>Country</u></th> <th><u>Default</u></th> </tr> </thead> <tbody> <tr><td>United States</td><td>0</td></tr> <tr><td>Canada (French)</td><td>0</td></tr> <tr><td>Mexico</td><td>0</td></tr> <tr><td>Australia</td><td>0</td></tr> <tr><td>France</td><td>0</td></tr> <tr><td>Germany</td><td>0</td></tr> <tr><td>Netherlands</td><td>0</td></tr> <tr><td>United Kingdom</td><td>0</td></tr> </tbody> </table>	<u>Country</u>	<u>Default</u>	United States	0	Canada (French)	0	Mexico	0	Australia	0	France	0	Germany	0	Netherlands	0	United Kingdom	0	N/A
<u>Country</u>	<u>Default</u>																			
United States	0																			
Canada (French)	0																			
Mexico	0																			
Australia	0																			
France	0																			
Germany	0																			
Netherlands	0																			
United Kingdom	0																			
151*	<p>Remote diagnostics. Allows access to internal parameters using the remote operations from the Service and Factory menu. If TRUE, access is allowed. User may select from the Phone Setup menu. Default value = 0.</p> <table border="1"> <thead> <tr> <th><u>Country</u></th> <th><u>Default</u></th> </tr> </thead> <tbody> <tr><td>United States</td><td>0</td></tr> <tr><td>Canada (French)</td><td>0</td></tr> <tr><td>Mexico</td><td>0</td></tr> <tr><td>Australia</td><td>0</td></tr> <tr><td>France</td><td>0</td></tr> <tr><td>Germany</td><td>0</td></tr> <tr><td>Netherlands</td><td>0</td></tr> <tr><td>United Kingdom</td><td>0</td></tr> </tbody> </table>	<u>Country</u>	<u>Default</u>	United States	0	Canada (French)	0	Mexico	0	Australia	0	France	0	Germany	0	Netherlands	0	United Kingdom	0	0 = FALSE 1 = TRUE
<u>Country</u>	<u>Default</u>																			
United States	0																			
Canada (French)	0																			
Mexico	0																			
Australia	0																			
France	0																			
Germany	0																			
Netherlands	0																			
United Kingdom	0																			
152	<p>Ink out enable. If TRUE, ink detection of the pen cartridge is in effect. If FALSE, no ink detection will occur. Default value = 1.</p> <table border="1"> <thead> <tr> <th><u>Country</u></th> <th><u>Default</u></th> </tr> </thead> <tbody> <tr><td>United States</td><td>1</td></tr> <tr><td>Canada (French)</td><td>1</td></tr> <tr><td>Mexico</td><td>1</td></tr> <tr><td>Australia</td><td>1</td></tr> <tr><td>France</td><td>1</td></tr> <tr><td>Germany</td><td>1</td></tr> <tr><td>Netherlands</td><td>1</td></tr> <tr><td>United Kingdom</td><td>1</td></tr> </tbody> </table>	<u>Country</u>	<u>Default</u>	United States	1	Canada (French)	1	Mexico	1	Australia	1	France	1	Germany	1	Netherlands	1	United Kingdom	1	0 = FALSE 1 = TRUE
<u>Country</u>	<u>Default</u>																			
United States	1																			
Canada (French)	1																			
Mexico	1																			
Australia	1																			
France	1																			
Germany	1																			
Netherlands	1																			
United Kingdom	1																			
153	<p>Send polling enable. If TRUE, OfficeJet has been setup to be polled by another fax. User selects from the Fax Setting menu. Default value = 0.</p> <table border="1"> <thead> <tr> <th><u>Country</u></th> <th><u>Default</u></th> </tr> </thead> <tbody> <tr><td>United States</td><td>0</td></tr> <tr><td>Canada (French)</td><td>0</td></tr> <tr><td>Mexico</td><td>0</td></tr> <tr><td>Australia</td><td>0</td></tr> <tr><td>France</td><td>0</td></tr> <tr><td>Germany</td><td>0</td></tr> <tr><td>Netherlands</td><td>0</td></tr> <tr><td>United Kingdom</td><td>0</td></tr> </tbody> </table>	<u>Country</u>	<u>Default</u>	United States	0	Canada (French)	0	Mexico	0	Australia	0	France	0	Germany	0	Netherlands	0	United Kingdom	0	0 = FALSE 1 = TRUE
<u>Country</u>	<u>Default</u>																			
United States	0																			
Canada (French)	0																			
Mexico	0																			
Australia	0																			
France	0																			
Germany	0																			
Netherlands	0																			
United Kingdom	0																			

Parameter #	Description	Units																		
154	<p>Ink print enable. If TRUE, OfficeJet will attempt to print even if the print cartridge is out of ink. Default value = 0.</p> <table border="0"> <thead> <tr> <th><u>Country</u></th> <th><u>Default</u></th> </tr> </thead> <tbody> <tr><td>United States</td><td>0</td></tr> <tr><td>Canada (French)</td><td>0</td></tr> <tr><td>Mexico</td><td>0</td></tr> <tr><td>Australia</td><td>0</td></tr> <tr><td>France</td><td>0</td></tr> <tr><td>Germany</td><td>0</td></tr> <tr><td>Netherlands</td><td>0</td></tr> <tr><td>United Kingdom</td><td>0</td></tr> </tbody> </table>	<u>Country</u>	<u>Default</u>	United States	0	Canada (French)	0	Mexico	0	Australia	0	France	0	Germany	0	Netherlands	0	United Kingdom	0	0 = FALSE 1 = TRUE
<u>Country</u>	<u>Default</u>																			
United States	0																			
Canada (French)	0																			
Mexico	0																			
Australia	0																			
France	0																			
Germany	0																			
Netherlands	0																			
United Kingdom	0																			
155	<p>Old system error code. Not currently used. Default value = 0.</p> <table border="0"> <thead> <tr> <th><u>Country</u></th> <th><u>Default</u></th> </tr> </thead> <tbody> <tr><td>United States</td><td>0</td></tr> <tr><td>Canada (French)</td><td>0</td></tr> <tr><td>Mexico</td><td>0</td></tr> <tr><td>Australia</td><td>0</td></tr> <tr><td>France</td><td>0</td></tr> <tr><td>Germany</td><td>0</td></tr> <tr><td>Netherlands</td><td>0</td></tr> <tr><td>United Kingdom</td><td>0</td></tr> </tbody> </table>	<u>Country</u>	<u>Default</u>	United States	0	Canada (French)	0	Mexico	0	Australia	0	France	0	Germany	0	Netherlands	0	United Kingdom	0	N/A
<u>Country</u>	<u>Default</u>																			
United States	0																			
Canada (French)	0																			
Mexico	0																			
Australia	0																			
France	0																			
Germany	0																			
Netherlands	0																			
United Kingdom	0																			
156	<p>ECM enabled. If TRUE, error correction mode is enabled. Default value = 1.</p> <table border="0"> <thead> <tr> <th><u>Country</u></th> <th><u>Default</u></th> </tr> </thead> <tbody> <tr><td>United States</td><td>1</td></tr> <tr><td>Canada (French)</td><td>1</td></tr> <tr><td>Mexico</td><td>1</td></tr> <tr><td>Australia</td><td>1</td></tr> <tr><td>France</td><td>1</td></tr> <tr><td>Germany</td><td>1</td></tr> <tr><td>Netherlands</td><td>1</td></tr> <tr><td>United Kingdom</td><td>1</td></tr> </tbody> </table>	<u>Country</u>	<u>Default</u>	United States	1	Canada (French)	1	Mexico	1	Australia	1	France	1	Germany	1	Netherlands	1	United Kingdom	1	0 = FALSE 1 = TRUE
<u>Country</u>	<u>Default</u>																			
United States	1																			
Canada (French)	1																			
Mexico	1																			
Australia	1																			
France	1																			
Germany	1																			
Netherlands	1																			
United Kingdom	1																			
157	<p>Coding mode. Three encoding schemes are possible: MH (modified Huffman), MR (modified read) and MMR (modified modified read). This parameter specifies which coding scheme will be default. Default value = 3.</p> <table border="0"> <thead> <tr> <th><u>Country</u></th> <th><u>Default</u></th> </tr> </thead> <tbody> <tr><td>United States</td><td>3</td></tr> <tr><td>Canada (French)</td><td>3</td></tr> <tr><td>Mexico</td><td>3</td></tr> <tr><td>Australia</td><td>3</td></tr> <tr><td>France</td><td>3</td></tr> <tr><td>Germany</td><td>3</td></tr> <tr><td>Netherlands</td><td>3</td></tr> <tr><td>United Kingdom</td><td>3</td></tr> </tbody> </table>	<u>Country</u>	<u>Default</u>	United States	3	Canada (French)	3	Mexico	3	Australia	3	France	3	Germany	3	Netherlands	3	United Kingdom	3	1 = MH 2 = MR 3 = MRR
<u>Country</u>	<u>Default</u>																			
United States	3																			
Canada (French)	3																			
Mexico	3																			
Australia	3																			
France	3																			
Germany	3																			
Netherlands	3																			
United Kingdom	3																			

Parameter #	Description	Units																		
158	<p>Transmit start speed. Default bits per second (BPS) rate. The speed may be adjusted down as training occurs. Default value = 4.</p> <table border="0"> <thead> <tr> <th><u>Country</u></th> <th><u>Default</u></th> </tr> </thead> <tbody> <tr><td>United States</td><td>4</td></tr> <tr><td>Canada (French)</td><td>4</td></tr> <tr><td>Mexico</td><td>4</td></tr> <tr><td>Australia</td><td>4</td></tr> <tr><td>France</td><td>4</td></tr> <tr><td>Germany</td><td>4</td></tr> <tr><td>Netherlands</td><td>4</td></tr> <tr><td>United Kingdom</td><td>4</td></tr> </tbody> </table>	<u>Country</u>	<u>Default</u>	United States	4	Canada (French)	4	Mexico	4	Australia	4	France	4	Germany	4	Netherlands	4	United Kingdom	4	1 = 2400 2 = 4800 3 = 7200 4 = 9600
<u>Country</u>	<u>Default</u>																			
United States	4																			
Canada (French)	4																			
Mexico	4																			
Australia	4																			
France	4																			
Germany	4																			
Netherlands	4																			
United Kingdom	4																			
159	<p>Maximum erred lines. When in non-error correction mode, the number of page lines indicating an error which will be accepted before the page is rejected. Default value = 60.</p> <table border="0"> <thead> <tr> <th><u>Country</u></th> <th><u>Default</u></th> </tr> </thead> <tbody> <tr><td>United States</td><td>60</td></tr> <tr><td>Canada (French)</td><td>60</td></tr> <tr><td>Mexico</td><td>60</td></tr> <tr><td>Australia</td><td>60</td></tr> <tr><td>France</td><td>60</td></tr> <tr><td>Germany</td><td>60</td></tr> <tr><td>Netherlands</td><td>60</td></tr> <tr><td>United Kingdom</td><td>60</td></tr> </tbody> </table>	<u>Country</u>	<u>Default</u>	United States	60	Canada (French)	60	Mexico	60	Australia	60	France	60	Germany	60	Netherlands	60	United Kingdom	60	Depends on page size
<u>Country</u>	<u>Default</u>																			
United States	60																			
Canada (French)	60																			
Mexico	60																			
Australia	60																			
France	60																			
Germany	60																			
Netherlands	60																			
United Kingdom	60																			
160	<p>Benchrun execution time. Factory use only. Default value = 0.</p> <table border="0"> <thead> <tr> <th><u>Country</u></th> <th><u>Default</u></th> </tr> </thead> <tbody> <tr><td>United States</td><td>0</td></tr> <tr><td>Canada (French)</td><td>0</td></tr> <tr><td>Mexico</td><td>0</td></tr> <tr><td>Australia</td><td>0</td></tr> <tr><td>France</td><td>0</td></tr> <tr><td>Germany</td><td>0</td></tr> <tr><td>Netherlands</td><td>0</td></tr> <tr><td>United Kingdom</td><td>0</td></tr> </tbody> </table>	<u>Country</u>	<u>Default</u>	United States	0	Canada (French)	0	Mexico	0	Australia	0	France	0	Germany	0	Netherlands	0	United Kingdom	0	N/A
<u>Country</u>	<u>Default</u>																			
United States	0																			
Canada (French)	0																			
Mexico	0																			
Australia	0																			
France	0																			
Germany	0																			
Netherlands	0																			
United Kingdom	0																			
161	<p>Maximum scanner doc length. Maximum length the scanner will scan for before indicating a "Scanner Jam" on the front panel display if the end of page was not sensed. Default value = 17.</p> <table border="0"> <thead> <tr> <th><u>Country</u></th> <th><u>Default</u></th> </tr> </thead> <tbody> <tr><td>United States</td><td>17</td></tr> <tr><td>Canada (French)</td><td>17</td></tr> <tr><td>Mexico</td><td>17</td></tr> <tr><td>Australia</td><td>17</td></tr> <tr><td>France</td><td>17</td></tr> <tr><td>Germany</td><td>17</td></tr> <tr><td>Netherlands</td><td>17</td></tr> <tr><td>United Kingdom</td><td>17</td></tr> </tbody> </table>	<u>Country</u>	<u>Default</u>	United States	17	Canada (French)	17	Mexico	17	Australia	17	France	17	Germany	17	Netherlands	17	United Kingdom	17	1 inch (0 to 9999)
<u>Country</u>	<u>Default</u>																			
United States	17																			
Canada (French)	17																			
Mexico	17																			
Australia	17																			
France	17																			
Germany	17																			
Netherlands	17																			
United Kingdom	17																			

Parameter #	Description	Units																		
162	<p>Auto reduction when out of memory. Amount of automatic reduction that will occur if the entire document does not fit into OfficeJet and a value must be guessed. Default value = 91.</p> <table border="0"> <thead> <tr> <th><u>Country</u></th> <th><u>Default</u></th> </tr> </thead> <tbody> <tr><td>United States</td><td>91</td></tr> <tr><td>Canada (French)</td><td>91</td></tr> <tr><td>Mexico</td><td>91</td></tr> <tr><td>Australia</td><td>91</td></tr> <tr><td>France</td><td>91</td></tr> <tr><td>Germany</td><td>91</td></tr> <tr><td>Netherlands</td><td>91</td></tr> <tr><td>United Kingdom</td><td>91</td></tr> </tbody> </table>	<u>Country</u>	<u>Default</u>	United States	91	Canada (French)	91	Mexico	91	Australia	91	France	91	Germany	91	Netherlands	91	United Kingdom	91	1% (70 to 100)
<u>Country</u>	<u>Default</u>																			
United States	91																			
Canada (French)	91																			
Mexico	91																			
Australia	91																			
France	91																			
Germany	91																			
Netherlands	91																			
United Kingdom	91																			
163	<p>FAX/Copy print scale method. Selects whether a hardware or software scaling algorithm will be used to scale either faxes or copies. Default value = 2.</p> <table border="0"> <thead> <tr> <th><u>Country</u></th> <th><u>Default</u></th> </tr> </thead> <tbody> <tr><td>United States</td><td>2</td></tr> <tr><td>Canada (French)</td><td>2</td></tr> <tr><td>Mexico</td><td>2</td></tr> <tr><td>Australia</td><td>2</td></tr> <tr><td>France</td><td>2</td></tr> <tr><td>Germany</td><td>2</td></tr> <tr><td>Netherlands</td><td>2</td></tr> <tr><td>United Kingdom</td><td>2</td></tr> </tbody> </table>	<u>Country</u>	<u>Default</u>	United States	2	Canada (French)	2	Mexico	2	Australia	2	France	2	Germany	2	Netherlands	2	United Kingdom	2	1 = HW 2 = SW
<u>Country</u>	<u>Default</u>																			
United States	2																			
Canada (French)	2																			
Mexico	2																			
Australia	2																			
France	2																			
Germany	2																			
Netherlands	2																			
United Kingdom	2																			
164	<p>Photo mode copy print scale method. Determines which algorithm will be used when copying a document using PHOTO resolution. Suggested value is 2. Default value = 2.</p> <table border="0"> <thead> <tr> <th><u>Country</u></th> <th><u>Default</u></th> </tr> </thead> <tbody> <tr><td>United States</td><td>2</td></tr> <tr><td>Canada (French)</td><td>2</td></tr> <tr><td>Mexico</td><td>2</td></tr> <tr><td>Australia</td><td>2</td></tr> <tr><td>France</td><td>2</td></tr> <tr><td>Germany</td><td>2</td></tr> <tr><td>Netherlands</td><td>2</td></tr> <tr><td>United Kingdom</td><td>2</td></tr> </tbody> </table>	<u>Country</u>	<u>Default</u>	United States	2	Canada (French)	2	Mexico	2	Australia	2	France	2	Germany	2	Netherlands	2	United Kingdom	2	1 or 2
<u>Country</u>	<u>Default</u>																			
United States	2																			
Canada (French)	2																			
Mexico	2																			
Australia	2																			
France	2																			
Germany	2																			
Netherlands	2																			
United Kingdom	2																			

Parameter #	Description	Units
165	SW scaling switching threshold. For factory use only. Default value = 999 for all.	N/A
166	Maximum mech speed. Maximum speed at which the print mechanism will operate in inches/sec. For factory use only. Default value = 24 ips. for all.	N/A
167	SW scaling switching threshold in photo. For factory use only. Default value = 0 for all.	N/A
175	System failure code location. Parameter address location where the system error codes are stored. Always 176 for all.	176
176, 177, 178, 179	System failure code 1,2,3,4. Storage locations of the last four system error code failures.	N/A
200	Scanner jam to window steps. Value used to adjust for the tolerance between the scanner location and the top of page sensor. This value will adjust the top margin when faxing or copying and is set as part of the Scanner Calibration procedure.	N/A
201	Scanner gain. Calculated automatically each time the OfficeJet is power ON.	N/A
226	Total pages received. Counter which keeps track of how many fax pages were received by OfficeJet. Each fax page received increments the counter by one.	N/A
227	Total pages sent. Counter which keeps track of how many fax pages were sent by OfficeJet. Each fax page sent increments the counter by one.	N/A
228	Total pages copied. Counter which keeps track of how many pages were copied and how many copies of each page were made. Each printed copy increments the counter by one.	N/A
229	Total pages printed. Counter which keeps track of number of all pages printed from all OfficeJet functions including printed faxes, printed copies and printing (as a printer).	N/A

Service and Support Information

Subject	Page
Introduction	6-2
Product Warranty	6-2
HP Extended Warranties	6-2
HP Express Exchange	6-2
Standard Return (U.S. only)	6-2
Returning the HP OfficeJet for Service	6-2
HP Support Information	6-3
Exchange Unit Ordering Information	6-3
Resources for U.S. Customers	6-4
Resources for Resellers (U.S. only)	6-6
Resources for HP Authorized Dealers (U.S. only)	6-7
Resources for Canadian Product Support	6-8
Resources for European Product Support	6-9
Resources for Australian Product Support	6-12
HP Regional Sales Offices	6-13
Interpreting the Serial Number Format	6-14
Interpreting the PCA Date Code Format	6-14

Introduction

In this chapter you will find information pertinent to the HP OfficeJet express exchange and warranty programs as well as resource information for contacting technical support. The main topics covered are:

- Product Warranty
- HP Extended Warranty
- HP Express Exchange Program
- Standard Return (U.S.A. only)
- Return for Service
- HP Support Information
- Exchange Unit Ordering Information
- Resources for U.S. Customers
- Resources for Resellers
- Resources for HP Authorized Dealers
- Resources for Canadian Customers
- Resources for European Customers
- Resources for Australian Customers

Product Warranty

The HP OfficeJet product(s) described in this guide are warranted against defects in materials and workmanship for a period of one year. During the warranty period, HP will, at its option, either replace or repair products which prove to be defective. In the U.S., defective units are replaced via the Express Exchange program, or as a Standard Return.

HP Extended Warranties

HP OfficeJet dealers and resellers may market HP SupportPack, and enable end-users to obtain a full three years of support. HP SupportPack must be purchased by the end-users within the first 30 days of the product purchase from a reseller. For more information about HP SupportPack contact your HP sales representative if you are an HP authorized dealer, or an HP authorized distributor if you are an HP reseller.

HP Express Exchange

In the U. S., HP will deliver a remanufactured replacement unit to the user the next business day when notified before 4:00 pm (PST) and arrange for return to HP of the non-working unit. Outside the U.S. the remanufactured replacement units will be shipped on the day ordered via premium carrier, but may not arrive next day depending upon user location.

Standard Return (U.S. only)

If the user wants to keep the HP OfficeJet product they purchased, HP will repair the original unit and return it to the owner within two business days (plus shipping time).

Returning the HP OfficeJet For Service (U.S. only)

If it is determined that the unit must be sent to Hewlett-Packard for service, it must be packed in a protective carton. If the original shipping carton cannot be used, a new carton can be ordered from HP Corvallis Service Center, 1030 N.W. Circle Blvd., Corvallis, OR 97330, Telephone (503) 715-2035.

HP Support Information

Hewlett-Packard stands behind its OfficeJet products with a number of service and support resources ready to answer your product related questions. These services include:

- HP FIRST
- HP Customer Information Center
- HP Customer Support Center
- Service Parts ID bulletin board
- HP Dealer Support Center
- HP Corvallis Service Center
- Parts Identification
- HP Forum on CompuServe

HP authorized dealers who have signed a current U.S. Dealer Channel Agreement are eligible to participate in the HP Dealer Premier Support Program. Contact your HP sales representative if you are interested in obtaining information about qualification requirements to market HP products. The Dealer Premier Support Program Guide may be obtained by ordering part number 5091-1927EUS from the Customer Information Center (800) 752-0900.

Resellers of HP fax products who have purchased products through an HP authorized distributor are eligible to participate in the HP Fax Service Provider Program. The HP Fax Service Provider Program Guide may be obtained by ordering part number 5091-8662EUS from the Customer Information Center (800) 752-0900, or from HP FIRST (800) 333-1917.

Exchange Unit Ordering Information

When ordering replacement (exchange) units, refer to the following table. Be sure to order the correct unit, using the appropriate Exchange Part Number, for the country where it is to be used. Do NOT order a unit for use out of the designated country. The line interface units are designed, and internal parameters set, for country-specific usage. If used outside of the designated country, the unit may be damaged and/or not function properly. The warranty does not cover improper usage. Also, the user may be subject to local laws and regulations pertaining to such use.

Exchange Unit Ordering Information	
Country/Language	Exchange Part Number
U.S.A.	C2890-69001
Canada (French)	C2890-69002
Canada (English)	C2890-69003
Germany	C2890-69004
France	C2890-69005
Australia	C2890-69006
Netherlands (Dutch)	C2890-69007
United Kingdom	C2890-69008

Resources for U.S. Customers

The following Customer Resource table provides the Hewlett-Packard organizations for customers to call for various types of product support, the telephone number of each organization, the information or resource provided, and the hours of operation of the organization. This table is only for U.S. resources. Canadian and European resources are provided later in this chapter.

The customer resources should be used before calling the Customer Support Center. Only call the Customer Support Center if the other customer resources listed do not provide the information needed or resolve the problem.

U.S. Customer Resources			
Organization	Telephone Number	Support Provided	Hours of Operation
Local Support	1 (800) 243-9812	Help in locating nearest HP authorized dealer	24 hours per day 7 days per week
HP Fax Products Information	1 (800) HP HOME 8 474-6638	Presales information on HP FAX products	24 hours per day 7 days per week
HP FIRST Faxback (24-hour automated fax-back support service)	1 (800) 333-1917 Press 1 for faxed tips or 1 (208) 344-4809	Detailed product support information on common software applications and troubleshooting tips (all sent by facsimile)	24 hours per day 7 days per week
HP Audio Tips (24-hour automated support service)	1(800) 333-1917 Press 2 for audio tips	Recorded help messages for common questions and information on other HP customer resources	24 hours per day 7 days per week
HP Download Service (real time access over modem, setting = N,8,1)	1 (208) 344-1691	Electronic download of HP product information, troubleshooting hints and updated HP printer driver information	24 hours per day 7 days per week
CompuServe To become a subscriber, call 1 (800) 524-3388 and ask for agent #51	Log on and at the prompt, type: GO HPPER (CompuServe connect charges apply to caller)	Interactive dialog with worldwide HP customer community for the exchange of information	24 hours per day 7 days per week
Internet (anonymous ftp site) WW WEB (World-wide web)	ftp address: 192.6.71.2 or ftp-boi.external.hp.com or url: http://www.hp.com/home.html	Information on products, printer drivers and support for anyone with ftp access to the Internet	24 hours per day 7 days per week
(Continued on next page)			

U.S. Customer Resources (continued)

Organization	Telephone Number	Support Provided	Hours of Operation
Printer drivers by mail	1 (303) 339-7009	Printer drivers may be obtained by contacting the software application manufacturer, however, HP distributes some of the most popular software applications	24 hours per day 6 days per week, closed Sundays
HP FAX Demo Line	1 (800) 44 FAXHP 443-2947	To receive a faxed print sample	24 hours per day 7 days per week
HP Customer Information Center	1 (800) 752-0900	Ordering of User's guides, technical reference guides and other literature	6:00 am - 5:00 pm PST weekdays
HP Direct	1 (800) 538-8787	Customer-orderable supplies and accessories, except documentation	6:00 am - 5:00 pm PST weekdays
HP North American Response Center	1 (800) 633-3600	HP service contract information	7:00 am - 6:00 pm PST weekdays
Post Warranty Support (fee-based support)	1 (900) 555-1500 (\$2.50 per minute U.S., charges start only when you connect with a support technician) or 1 (800) 999-1148 (\$25.00 fee per call U.S., Visa or MasterCard) *prices subject to change without notice	Post warranty assistance on product questions and the most common software applications	7:00 am - 6:00 pm MST Mon, Tu, Th, Fri 7:00 am - 4:00 pm MST Wed
HP Customer Support Center	1 (208) 323-2551	Technical Assistance with setup, operation, repair information and exchange program information	7:00 am - 6:00 pm MST Mon, Tu, Th, Fri 7:00 am - 4:00 pm MST Wed

Resources for Resellers (U.S. only)

The following table provides the Hewlett-Packard organizations for HP fax service providers to call, the telephone number of each organization, the information or resource provided, and the hours of operation of the organization.

Reseller Resources			
Organization	Telephone Number	Support Provided	Hours of Operation
HP Customer Support Center 11311 Chinden Blvd. Boise, ID 83714	1 (208) 323-2551	Technical Assistance on HP InkJet printer and fax products Questions about HP Fax Service Provider final exam program	7:00 am - 6:00 pm PST Mon, Tu, Th, Fri 7:00 am - 4:00 pm PST Wed
HP Customer Information Center	1 (800) 752-0900	Product literature	6:00 am - 5:00 pm PST
HP Corvallis Service Center 1030 N.W. Circle Blvd. Corvallis, OR 97330	1 (503) 715-2035	Order shipment or return of exchange unit	7:00 am - 4:30 pm PST
Parts Direct Ordering	1 (800) 227-8164	Order stocking of exchange units and accessory parts	6:00 am - 5:00 pm PST
Hewlett-Packard Co 5301 Stevens Creek Blvd. Santa Clara, CA 95052-8059 Attn: HP Dealer Premier Support Service Authorization	1 (800) 835-4747	Final exam mailing address for HP Fax Service Provider program Must have HP Dealer Service contract and dealer ID number HP extended warranty information	7:30 am - 4:00 pm PST
Parts Identification	1 (916) 783-0804	HP parts identification	6:00 am - 3:00 pm PST
Service Parts ID bulletin board	1 (916) 785-5945	On Line Parts data base (all sent by facsimile)	24 hours per day 7 days per week
HP FIRST Faxback (24-hour automated fax-back support service)	1 (800) 333-1917 Press 1 for faxed tips or 1 (208) 344-4809	Detailed product support information on common software applications and troubleshooting tips (all sent by facsimile)	24 hours per day 7 days per week
HP Audio Tips (24-hour automated support service)	1 (800) 333-1917 Press 2 for audio tips	Recorded help messages for common questions and information on other HP customer resources	24 hours per day 7 days per week

Resources for HP Authorized Dealers (U.S. only)

The table below provides the Hewlett-Packard organizations for HP authorized dealers to call, the telephone number of each organization, the information or resource provided, and the hours of operation of the organization.

HP Authorized Dealers Resources			
Organization	Telephone Number	Support Provided	Hours of Operation
HP Customer Information Center	1 (800) 752-0900	Product literature	6:00 am - 5:00 pm PST
HP Corvallis Service Center 1030 N.W. Circle Blvd. Corvallis, OR 97330	1 (503) 715-2035	Order shipment or return remanufactured exchange unit	7:00 am - 4:30 pm PST
HP Dealer Support Center	1 (800) 544-9976	HP Authorized Dealer/HPSR Only , Pre- & Post-Sales Support	24 hours per day 7 days per week
Parts Direct Ordering	1 (800) 227-8164	Order stocking of remanufactured exchange units and accessory parts	6:00 am - 5:00 pm PST
Parts Identification	1 (916) 783-0804	HP parts identification	6:00 am - 3:00 pm PST
Service Parts ID bulletin board	1 (916) 785-5945	On Line Parts data base (all sent by facsimile)	24 hours per day 7 days per week
HP FIRST Faxback (24-hour automated fax-back support service)	1 (800) 333-1917 Press 1 for faxed tips or 1 (208) 344-4809	Detailed product support information on common software applications and troubleshooting tips (all sent by facsimile)	24 hours per day 7 days per week
HP Audio Tips (24-hour automated support service)	1 (800) 333-1917 Press 2 for audio tips	Recorded help messages for common questions and information on other HP customer resources	24 hours per day 7 days per week

Resources for Canadian Product Support

The following Resource table lists the Hewlett-Packard organizations for Canadian product support. This table is only for Canadian resources.

Canadian Product Support Resources			
Organization	Contact	Support Provided	Hours of Operation
Local Support	1 (800) 387-3867	Help in locating nearest HP authorized dealer	8:30 am - 5:00 pm EST weekdays
	From Toronto: 1 (905) 206-4745 From rest of Canada: 1 (800) 387-3154	Ordering of supplies and accessories	
HP FIRST Faxback (24-hour automated fax-back support service)	1 (800) 333-1917 Press 1 for faxed tips or 1 (208) 344-4809	Detailed product support information on common software applications and troubleshooting tips	24 hours per day 7 days per week
HP Audio Tips (24-hour automated support service)	1 (800) 333-1917 Press 2 for audio tips	Recorded help messages for common questions and information on other HP customer resources	24 hours per day 7 days per week
HP Download Service (real time access over modem, setting = N,8,1)	1 (208) 344-1691	Electronic download of HP product information, troubleshooting hints and updated HP printer driver information	24 hours per day 7 days per week
CompuServe To become a subscriber, call 1 (800) 524-3388 and ask for agent #51	Log on and at the prompt, type: GO HPPER (CompuServe connect charges apply to caller)	Interactive dialog with worldwide HP customer community for the exchange of information	24 hours per day 7 days per week
Internet (HP ftp site)	ftp address: 192.6.71.2 or ftp-boi.external.hp.com	Information on products, printer drivers and support for anyone with ftp access to the Internet	24 hours per day 7 days per week
HP Canada Customer Support Center	Eastern Canada 1 (800) 361-9791 Western Canada 1 (800) 268-1221	Assistance with repair and exchange program information	8:00 am - 8:00 pm EST weekdays
HP Canada Customer Information Center	5150 Spectrum Way Mississauga, Ontario L4W 5G1	Mailing address for correspondence	
Post-Warranty Support (fee-based support, prices subject to change without notice)	1 (800) 999-1148 (\$25.00 fee per call,, Visa or MasterCard)	Post-warranty assistance on product questions and the most common software applications	7:00 am - 6:00 pm MST Mon, Tu, Th, Fri 7:00 am - 4:00 pm MST Wed

Resources for European Product Support

The following Resource table lists the Hewlett-Packard organizations for European product support. This table is only for European resources.

European Product Support Resources		
Organization	Contact	Support Provided
HP Bulletin Board Service <u>Country:</u> France (Minitel) Germany (Datex\J-BTX) Netherlands United Kingdom	<u>Number:</u> 3616 HP MICRO *HP# +31 (20) 647-5433 +44 (1344) 361891	Electronic download of HP product information, troubleshooting hints and updated HP printer driver information (real time access over modem, setting = N,8,1) max speed = 14.4kBaud) 24 hours per day 7 days per week
HP Internet (anonymous ftp site) WW WEB (World-wide web)	ftp address: 192.6.71.2 or ftp-boi.external.hp.com Name: anonymous Password: (your E-mail address) or url: http://www.hp.com/home.html	Information on products, printer drivers and support for anyone with ftp access to the Internet or World-Wide Web access through a hyper-media viewer 24 hours per day 7 days per week
CompuServe To become a subscriber, call the number for your country and ask for agent #51 <u>Country:</u> France Germany Netherlands United Kingdom	Log on and at the prompt, type: GO HPPER (CompuServe connect charges apply to caller) <u>Number:</u> 3663.81.22 (0130) 3732 (0044) 1272.760.680 (0800) 289378	Interactive dialog with worldwide HP customer community for the exchange of information 24 hours per day 7 days per week
(Continued on next page)		
Note: When calling, replace the + with your International telephone access code.		

European Product Support Resources (continued)

Organization	Contact	Support Provided
Printer Drivers by Mail P.O. Box 63 HARTLEPOOL Cleveland TS25 2YP United Kingdom	Fax:+44 (429) 866 000 Tel: (English) +44 (429) 865 511 Tel: (French) +44 (429) 863 343 Tel: (German) +44 (429) 863 353	Ordering of Software Printer Drivers
HP FIRST Faxback (24-hour automated faxback support service) <u>Country:</u> France Germany Netherlands United Kingdom Anywhere in Europe Anywhere in the World	<u>Toll-free Number:</u> 05-905900 0130-810061 06-0222420 0800-960721 +(31) 20 681 5792 +1 (208) 344-4809	To obtain by fax, detailed product support information, application notes and driver lists 24 hours per day 7 days per week
Customer Information Centers <u>Country:</u> France Germany Netherlands United Kingdom	<u>Number:</u> Tel: (3668) 38.48 or 3616.HP MICRO Tel: (7031) 14-0 Tel: (20) 547.66.66 Tel: (1344) 369 369	Help in locating nearest HP authorized dealer or product sales information and data sheets Monday through Friday 8:30 am – 5:00 pm Central European Time
(Continued on next page)		
Note: When calling, replace the + with your International telephone access code.		

European Product Support Resources (continued)

Organization	Contact	Support Provided
<p>Parts Direct <u>Country:</u> France Hewlett-Packard France S. A. Pieces Direct 5, avenue R. Chanas-Eybens 38053 Grenoble Cedex 9</p> <p>Germany Hewlett-Packard GmbH HP Direkt Herrenberger Strasse 130 71034 Böblingen</p> <p>Netherlands Hewlett-Packard Nederland B.V. Parts Direct Service Basicweg 10 3821 BR Amersfoort</p> <p>United Kingdom Hewlett-Packard Ltd. Parts Service Cain Road Bracknell Berkshire RG 12 1HN</p>	<p><u>Number:</u> Tel: (16) 76 62 16 50 Fax: (16) 76 62 52 07</p> <p>Tel: 07031-145444 Fax: 07031-141395</p> <p>Tel: 033-501808 Fax: 033-560891</p> <p>Tel: 0344 366 322 Fax: 0344 361859</p>	<p>Ordering of parts and manuals Monday through Friday 8:30 am – 5:00 pm Central European Time</p>
<p>European Customer Support Centers <u>Country:</u> France</p> <p>Germany</p> <p>Netherlands</p> <p>United Kingdom</p>	<p>International calling charges apply <u>Number:</u> Tel: 19 (31) 20 681.8260</p> <p>Tel: 00 (31) 20 681.7174</p> <p>Tel: 0 (20) 681.6473</p> <p>Tel: 0891 391 000 or 00 (31) 20 682.8291</p>	<p>Technical Assistance over the telephone, in local language, with setup, operation, and troubleshooting. Available for free during the warranty period</p> <p>Monday through Friday 8:30 am – 6:00 pm, except Wednesdays 8:30 am - 4:00 pm. Central European Time</p>

Resources for Australian Product Support

The following Resource table lists the Hewlett-Packard organizations for Australian product support. This table is only for Australian resources.

Australian Product Support Resources			
Organization	Contact	Support Provided	Hours of Operation
Your HP Dealer	Call from a phone near the HP OfficeJet.	Technical Assistance with setup, operation, and repair information	See your HP dealer
HP FIRST Faxback (24-hour automated fax-back support service)	(61-3) 272 2627 or +1 (208) 344-4809	Product data sheets and accessory information (all by facsimile)	24 hours per day 7 days per week
HP Audio Tips (24-hour automated support service)	(800) 333-1917 Press 2 for audio tips	Pre-recorded help messages for information on other HP customer resources	24 hours per day 7 days per week
HP Download Service (real time access over modem, setting = N,8,1)	(208) 344-1691	Electronic download of HP product information, troubleshooting hints and updated HP printer driver information	24 hours per day 7 days per week
CompuServe To become a subscriber, call 1 (800) 524-3388 and ask for agent #51	Log on and at the prompt, type: GO HPPER (CompuServe connect charges apply to caller)	Interactive dialog with worldwide HP customer community for the exchange of information	24 hours per day 7 days per week
Internet (HP ftp site)	ftp address: 192.6.71.2 or ftp-boi.external.hp.com	Information on products, printer drivers and support for anyone with ftp access to the Internet	24 hours per day 7 days per week
HP Australia Customer Information, Support and Response Center (located in Melbourne)	131347	Non-technical, presales information on many HP products Technical Assistance with setup and operation Assistance with repair and exchange program information	8:30 pm - 5:00 pm weekdays
HP Australia Dealer Support Center (located in Melbourne)	272-2586	Only for HP Authorized Dealers: Technical Assistance with setup, operation, repair, and exchange program	7:00 pm - 5:30 pm weekdays
HP Australia Country Repair Center (located in Melbourne)	008 339865	Only for HP Authorized Dealers: Repair information	8:30 pm - 5:00 pm weekdays

Interpreting the Serial Number Format

Each character in the product serial number has special meaning. The serial number can identify when the unit was manufactured and contains the unit's specific sequential number. Also, the revision level of the unit can be identified.

To interpret the product serial number, refer to the following serial number format example:

CCYMDVLXXX

where;	CC =	country
	Y =	year of current decade when manufactured
	M =	month (base 36)
	D =	day (base 36)
	V =	version (indicates revision level)
	L =	line number
	XXX =	sequential serial number (base 30)

Interpreting the PCA Date Code Format

The printed circuit board assemblies (PCAs) used in the HP OfficeJet have three identification features which can be used for tracking revisions (such as EPROM changes):

- Part Number. PCAs having the same part number are directly interchangeable. If a PCA is revised in any way that makes it non-interchangeable with previously issued PCAs of a particular part number, a new part number is assigned to the revised PCA.
- Revision Letter. This letter identifies the most recent revision to the etched circuit pattern. The original issue is identified with the letter A. If the master art work for a printed circuit board is revised in order to alter performance or manufacture, the revision letter is changed to the next letter in the alphabetic sequence.
- Assembly Date Code. The date code on the PCA is a four-digit number which identifies the assembly level by date code. The PCA date code is changed when a component or component part number is changed which alters the performance of the PCA. The first two digits represent the last two digits of the current year and are derived by subtracting 60 from the current year; the last two digits represent the week in that year, for example: 3426 = the 26th week in 1994, 3510 = the tenth week in 1995. Any digits following a hyphen (-) in the date code represent the division that manufactured the PCA.

For example: A PCA can be identified with the following information on it.

C2891-12345 = the part number of the PCA.

Rev. A = revision A of the etched pattern.

3512 = date code for 12th week of 1995.

Index

A

- Access Door Assembly, to install, 2-15
- Accessories, Ordering, 1-13
- Answering Machine, to connect and use, 2-24
- Area, maximum print, 1-12
- Auto Answering, parameters and values, 5-44
- Auto Receive Mode
 - how it works, 2-23
 - to set up , 2-27

B

- Beeping Noises, typical causes, 5-6
- Bench Run, testing, 5-40
- Blinking Lights, typical causes, 5-6

C

- Calibration, printing a calibration chart, 4-2
- Calibration Chart, to print and use, 5-36
- Call Progress, parameters and values, 5-62
- Call waiting, use of, 2-22
- Catch Tray, to install, 2-13
- Character Set, Printer supported, 1-8
- Cleaning, exterior surfaces, 3-3
- Code Revision, to show, 5-36
- Codes, diagnostic, 5-22
- Company Name, to enter, 2-31
- Connection Establishment, parameters and values, 5-50
- Control Panel Overlay, to install, 2-10
- Copier, Specifications, 1-9
- Copy, Reduction percentages, 1-9
- Copying
 - problem solving, 5-16
 - Speed, 1-9

D

- Date, to enter, 2-30
- Dedicated fax line, to use, 2-22
- Description, HP OfficeJet, 1-2
- Diagnostic Codes
 - descriptions of, 5-25
 - phases where they appear , 5-22
 - to understand, 5-22
- Diagnostics, to access remote, 5-36
- Dial Tone Detection, parameters and values, 5-54
- Dialing
 - parameters and values, 5-60
 - to select Tone or Pulse, 2-29
- Dimensions, 1-7
- Display, to set language shown, 5-36
- Display Messages
 - what they mean, 5-7
 - what to do, 5-7
- Distinctive Ring, to use, 2-25
- Distinctive Ring Feature, to set to ON, 2-26
- DOS
 - Print speed, 1-7
 - Resolution, 1-7
- DOS driver, 2-3
- Drivers, 2-2

E

- Eavesdrop Detection, parameters and values, 5-47
- Eclipse FAX SE, 1-10
 - functions of, 2-7
 - icon, 2-7
 - running, 2-7
 - to receive a fax to the PC, 2-9
 - to send a fax from the PC, 2-8
- Envelopes
 - to load the input tray, 2-19
 - usable sizes, 1-10
- Error Codes
 - 400 level, 5-27
 - 500 level, 5-27
 - system, 5-41

Error, types of notification, 5-6
European DL envelope, loading for printing from your PC, 2-19
Exchange, HP Express, 6-2
Exchange Unit, ordering information, 6-3

F

Factory Default Settings, to set to, 5-36
Factory Menu, to access, 5-36
Failure Code, to show, 5-36
Fax
 Coding schemes, 1-9
 Compatibility group, 1-9
 Specifications, 1-9
Fax Log Report, the diagnostic codes, 5-22
Fax Number, to enter, 2-31
Fax Session, protocol and phases, 5-22
Fax Session Configuration, parameters and values, 5-67
Fax/TAM Receive Mode
 how it works, 2-24
 to set up, 2-27
Faxing
 problem solving, 5-16
 to set up for, 2-22
Features, HP OfficeJet (LX), 1-3
Fonts, Printer internal, 1-8
Front panel, testing, 5-39

H

Hardware, requirements, 2-3
Header Information, to enter, 2-31
HP Express Exchange, 6-2
HP OfficeJet LX Manager, 1-10
 and Eclipse FAX SE, 2-7
 functions of, 2-6
 icon, 2-6
 running, 2-6
 running Eclipse FAX SE from, 2-7
HP OfficeJet LX program group, 2-6, 2-7

I

Icon, HP OfficeJet LX Manager, 2-6
Icons, Eclipse FAX SE, 2-7
Incoming Calls, to set reception mode, 2-27

Information
 customer resources, 6-4
 HP authorized dealers resources, 6-7
 reseller resources, 6-6
 support resources, 6-3

Input Tray
 to install, 2-16
 to load envelopes, 2-19
 to load paper, 2-18

Installation, fax setup, 2-22

Installing
 the access door assembly, 2-15
 the catch tray, 2-13
 the control panel overlay, 2-10
 the input tray, 2-16
 the interface cable, 2-12
 the output tray, 2-15
 the power cord, 2-13
 the print cartridge, 2-11
 the tray cover, 2-17

Interface Cable, to install, 2-12

Interface cable, to order, 1-13

L

Languages, to set display for, 5-36
Line Interface Unit (LIU), testing, 5-40
Line Monitor, testing, 5-40
LIU, parameters and values, 5-43
Loading Envelopes, in the input tray, 2-19
Loading Paper, in the input tray, 2-18

M

Maintenance
 changing a print cartridge, 3-2
 exterior cleaning, 3-3
 routine, 3-2

Manual Receive Mode
 how it works, 2-23
 to set up, 2-27

Margins
 Printing, 1-8
 Scan (copier), 1-9
 Scan (fax), 1-9

Media
 See also Paper
 loading precautions, 1-11
 maximum print area, 1-12
 specifications, 1-10
 to order, 1-13
 Tray capacities, 1-11

- what to avoid, 1-11
- Memory
 - Fax image, 1-9
 - Printer, 1-7
- Menu Settings, setting paper size, 2-20
- Messages
 - typical causes, 5-6
 - what they mean, 5-7
 - what to do, 5-7
- Modem Configuration, parameters and values, 5-65

N

- Number of Rings to Answer, to set up, 2-28

O

- Ordering Information
 - Accessories and Supplies, 1-13
 - exchange units, 6-3
 - where to call, 1-13
- OS/2 driver, 2-3
- Output Tray, to install, 2-15

P

- Paper
 - See also* Media
 - loading precautions, 1-11
 - to determine print side, 1-11
 - to load the input tray, 2-18
 - usable sizes, 1-10
- paper jam, while scanning a document to copy, 5-11
- Paper Size, menu setting, 2-20
- Parameter(s), descriptions and values, 5-43
- Parameters, associated user menu structure, 5-42
- Pause Control, parameters and values, 5-53
- PC Faxing
 - receiving, 2-9
 - sending, 2-8
 - using other programs, 2-10
- PCA Date Code, interpreting format, 6-14
- Phone System, features not supported, 2-22
- Power
 - Consumption, 1-7
 - Source voltage, 1-7
- Power Cord, to install, 2-13

- Power—On
 - initialization tests, 5-34
 - special menus and functions, 5-35

- Print Area, maximum, 1-12

- Print Cartridge
 - life expectancy, 1-10
 - to change a, 3-2
 - to install, 2-11
 - to order, 1-13

- Printer
 - Character set , 1-8
 - Command language, 1-7
 - Interface, type of, 1-7
 - Internal fonts, 1-8
 - Memory capacity, 1-7
 - Resolution, 1-7
 - Software compatibility, 1-8
 - Specifications, 1-7
 - TrueType fonts, 1-8

- Printer Cable, to install, 2-12

- Printer Drivers, 2-2
 - to install, 2-21

- Printer Motor, testing, 5-39

- Printer Software, 2-2

- Printing
 - Margins, 1-8
 - Paper sizes usable, 1-7
 - problem solving, 5-16
 - Speed, 1-7
 - to set up for, 2-21

- Problem Solving, the process, 5-2

- Problem Solving, while printing, faxing or copying, 5-16

- Pulse Dialing, to select, 2-29

R

- Reception Modes, to set for incoming calls, 2-27

- Redialing, parameters and values, 5-68

- Remote Diagnostics
 - how to use them, 5-38
 - to access, 5-36
 - what they are, 5-38

- Resolution
 - Printer, 1-7
 - Scan, 1-9

- Resources
 - for Australian product support, 6-12
 - for Canadian product support, 6-8
 - for customers, 6-4
 - for European product support, 6-9
 - for HP authorized dealers, 6-7

- for Resellers, 6-6
- Return
 - for service, 6-2
 - standard (U.S. only), 6-2
- Ring Detection, parameters and values, 5-44
- Rings, to set number of before answering, 2-28
- Roll-over phone systems, use of, 2-22

S

- Sales Offices , worldwide listing, 6-13
- Scan
 - Margins, 1-9
 - Resolution, 1-9
 - Width, 1-9
- Scanner, testing, 5-39
- Scanner Motor, testing, 5-39
- Sender Identification, to enter, 2-31
- Sensors, testing optical and mechanical, 5-39
- Serial Number, interpreting format, 6-14
- Service, to return a unit for, 6-2
- Service and Factory Menu, structure, 5-36
- Service Menu, to access, 5-36
- Setting Up
 - for faxing, 2-22
 - to print, 2-21
- Setup for Faxing
 - Australian Installation, 2-22
 - Canada Installation, 2-22
 - France Installation, 2-35
 - Germany Installation, 2-34
 - Mexico Installation, 2-22
 - Netherlands Installation, 2-38
 - U.K. Installation, 2-32
 - U.S. Installation, 2-22
- Size, Product dimensions, 1-7
- Software
 - Compatibility, 1-8
 - installation, 2-3
 - using, 2-2
- Software Programs, Eclipse FAX SE, HP Officejet LX Manager, 1-10
- Specifications
 - Copier, 1-7, 1-9
 - Fax, 1-7, 1-9
 - HP OfficeJet, 1-7
 - Media, 1-10
 - Overall product, 1-7
 - Printer, 1-7

- Speed
 - Copying, 1-9
 - Fax transmission, 1-9
 - Modem, 1-9
 - Print, 1-7
- Stored Parameters
 - to change values of, 5-38
 - to print listing of, 5-38
 - to show, 5-36

- Supplies, Ordering, 1-13
- System Error Codes, description of, 5-41

T

- T30 Protocol, state table, 5-27
- Telephone, to connect and use, 2-23
- Temperature range, Operating environment, 1-7
- Test Menu
 - to access, 5-35
 - use of the, 5-39
- Time, to enter, 2-30
- Tone Dialing, to select, 2-29
- Transmission, testing, 5-39
- Tray Assemblies, ordering information, 1-13
- Tray Cover, to install, 2-17
- Trays, capacity of, 1-11

U

- U.S. No. 10 envelope, loading for printing from your PC, 2-19
- User Menu, associated parameter structure , 5-42
- User's Guide, to order, 1-13

V

- Voicemail, use of, 2-22

W

- Warranty
 - extended , 6-2
 - standard, 6-2
- Weight, 1-7
- Windows
 - Print speed, 1-7
 - Resolution, 1-7
- Windows driver, 2-2

HP OfficeJet Family Final Exam

Final Exam Number 504

When completing the Final Exam, your cooperation in following these directions is needed to ensure the prompt and accurate processing of your final exam answers.

Side 1 of the Final Exam Answer Sheet

Side 1 of the Final Exam Answer Sheet contains areas that will ensure accurate reporting of your final exam results. It is essential that you carefully enter the following information on side 1. Use a #2 common lead pencil to completely fill in the circles.

- **ARE YOU A HEWLETT-PACKARD EMPLOYEE?** Fill in the appropriate circle.
- **FINAL EXAM NUMBER** and **FORM** code. Fill in the information as shown in Figure 1 (including any leading zeros) by filling in completely the appropriate circle beneath each entry. (Note: Figure 1 shows the correct FINAL EXAM NUMBER and FORM code for this final exam.)

FINAL EXAM NUMBER					FORM	
0	0	0	5	0	4	
<input checked="" type="radio"/>	<input checked="" type="radio"/>	<input checked="" type="radio"/>	<input type="radio"/>	<input type="radio"/>	<input type="radio"/>	A
<input type="radio"/>	<input type="radio"/>	<input type="radio"/>	<input type="radio"/>	<input type="radio"/>	<input type="radio"/>	B
<input type="radio"/>	<input type="radio"/>	<input type="radio"/>	<input type="radio"/>	<input type="radio"/>	<input type="radio"/>	C
<input type="radio"/>	<input type="radio"/>	<input type="radio"/>	<input type="radio"/>	<input type="radio"/>	<input type="radio"/>	D
<input type="radio"/>	<input type="radio"/>	<input type="radio"/>	<input type="radio"/>	<input type="radio"/>	<input checked="" type="radio"/>	E
<input type="radio"/>	<input type="radio"/>	<input type="radio"/>	<input checked="" type="radio"/>	<input type="radio"/>	<input type="radio"/>	F
<input type="radio"/>	<input type="radio"/>	<input type="radio"/>	<input type="radio"/>	<input type="radio"/>	<input type="radio"/>	G
<input type="radio"/>	<input type="radio"/>	<input type="radio"/>	<input type="radio"/>	<input type="radio"/>	<input type="radio"/>	H
<input type="radio"/>	<input type="radio"/>	<input type="radio"/>	<input type="radio"/>	<input type="radio"/>	<input type="radio"/>	I
<input type="radio"/>	<input type="radio"/>	<input type="radio"/>	<input type="radio"/>	<input type="radio"/>	<input type="radio"/>	J

Figure 1. Final Exam Number and Form Code

- **PERSONAL ID NUMBER, COMPANY ID NUMBER, LAST NAME, and FIRST NAME.** Print all the information requested in the boxes and then fill in completely the appropriate circle beneath each entry. For PERSONAL ID NUMBER and COMPANY ID NUMBER, enter the number HP has assigned to you and start your entry in the left-most (first) column.
- **COURSE NAME, COMPANY NAME, STREET ADDRESS, CITY, STATE OR PROVINCE, COUNTRY, ZIP OR POSTAL CODE, and TELEPHONE NUMBER.** Print all of the information requested in the spaces provided.

Side 2 of the Final Exam Answer Sheet

Side 2 of the Final Exam Answer Sheet provides important information about completing the Final Exam. Read the instructions on side 2 of the Final Exam Answer Sheet, then answer the questions in this Final Exam. After completing the Final Exam, return the answer sheet to:

Hewlett-Packard Company
Premier Support Administration MS54L-BI
5301 Stevens Creek Blvd.
Santa Clara, CA 95052

HP OfficeJet Family TSSG Final Exam Questions

Answer the following questions by filling in the correct circle on side 2 of the Final Exam Answer Sheet.

1. HP OfficeJet machines use one print cartridge (P/N _____).
 - A. 51626A
 - B. PC289X

2. The HP OfficeJet can be used with the following printer driver(s).
 - A. Windows
 - B. DOS
 - C. neither of the above
 - D. both DOS and Windows

3. How much printer memory is available in the HP OfficeJet?
 - A. 512 KB
 - B. 1 MB
 - C. 16 kB

4. Which HP OfficeJet feature allows your unit to request a fax transmission from a compatible remote unit?
 - A. Deferred transmission
 - B. Polling
 - C. Print from PC
 - D. A and C

5. HP OfficeJets can be set to simultaneously print a print job and receive faxes?
 - A. True
 - B. False

6. Instructions for performing the scan position calibration procedure are found in:
 - A. Chapter 1 of the TSSG
 - B. Chapter 2 of the TSSG
 - C. Chapter 4 of the TSSG
 - D. Chapter 6 of the TSSG

7. The HP OfficeJet can make copies and receive faxes at the same time?
 - A. True
 - B. False

8. If a customer asks how to connect an answering machine to use with the HP OfficeJet, you would find the procedure in:
- A. Chapter 5 of the TSSG
 - B. Chapter 3 of the TSSG
 - C. Chapter 2 of the TSSG
 - D. Chapter 1 of the TSSG
9. When a print cartridge runs out of ink in the HP OfficeJet, the following occurs:
- A. A 500 level information code appears in the display.
 - B. The message, "Out of Ink, Replace Pen" appears in the display.
 - C. A message is sent to a computer requesting a print cartridge replacement.
 - D. All of the above.
10. A diagnostic code containing a 400 level communication error code extension indicates a _____ problem.
- A. transmit
 - B. copy
 - C. print
 - D. receive
11. The recommended reception mode on the HP OfficeJet for a customer with no answering machine who normally receives voice and fax calls is:
- A. Auto mode
 - B. Manual mode
 - C. Fax/TAM mode
 - D. Distinctive Ring mode
12. The list of customer available resources for technical assistance is found in chapter _____ of the TSSG.
- A. 6
 - B. 1
 - C. 5
 - D. 2
13. Part numbers of orderable supplies and accessories are found in:
- A. Chapter 6 of the TSSG
 - B. Chapter 5 of the TSSG
 - C. Chapter 1 of the TSSG
 - D. Chapter 3 of the TSSG

14. A delayed send fax from the automatic document feeder can be sent while a print job is printing?
- A. True
 - B. False
15. HP OfficeJet printer control and printer feature access is through the:
- A. HP OfficeJet menu
 - B. Printer drivers
 - C. Remote diagnostic feature
16. When using the HP OfficeJet with an answering machine to receive fax and voice calls, the recommended reception mode is:
- A. Distinctive ring
 - B. Manual
 - C. Auto
 - D. Fax/TAM
17. HP authorized dealers who have a current U.S. Dealer Channel Agreement are eligible to participate in the HP Dealer Premier Support Program.
- A. True
 - B. False
18. The meanings of the digits in the diagnostic code that is printed on a fax log report can be found in:
- A. Chapter 6 of the TSSG
 - B. Chapter 5 of the TSSG
 - C. Chapter 4 of the TSSG
 - D. Chapter 3 of the TSSG
19. The HP Express Exchange program will deliver a _____ unit to the user.
- A. customer's own purchased and repaired
 - B. remanufactured
 - C. new
20. Hewlett-Packard Company service and support resources available to the customer include:
- A. HP Customer Information Center
 - B. HP Customer Support Center
 - C. HP FIRST
 - D. All of the above

21. Paper size, Reception modes and Speed Dial numbers can be set through the HP OfficeJet display menu?
- A. True
 - B. False
22. In the Technical Support Solutions Guide, problem solving information is provided in chapter ____ .
- A. 2
 - B. 7
 - C. 5
 - D. 3
23. The number of rings to answer setting is ONLY used in the _____ reception mode.
- A. Manual
 - B. Auto
 - C. Fax/TAM
24. To access the Service and Factory menu, press the _____ and _____ buttons simultaneously while powering the unit ON.
- A. 4 , 7
 - B. Start , Menu
 - C. Load Eject , Reset
 - D. * , 7
25. To transfer user settings from one HP OfficeJet to another locally, you must connect the two units with a phone cord and press the _____ and _____ buttons on each while powering them ON.
- A. 4 , 7
 - B. * , 4
 - C. * , 7
 - D. * , *



Technical information in
this document is subject to
change without notice.

Copyright© 1996
Hewlett-Packard Company
Printed in USA 2/96

Part Number
5963-6862EUS

