



HP Scanjet Enterprise N9120/Flow N9120

User Guide

Copyright and license

© 2013 Copyright HP Development Company, L.P.

Reproduction, adaptation or translation without prior written permission is prohibited, except as allowed under the copyright laws.

The information contained herein is subject to change without notice.

The only warranties for HP products and services are set forth in the express warranty statements accompanying such products and services.

Nothing herein should be construed as constituting an additional warranty. HP shall not be liable for technical or editorial errors or omissions contained herein.

Edition 3, 1/2017

Trademark credits

ENERGY STAR is a U.S. registered service mark of the United States Environmental Protection Agency.

Microsoft and Windows are registered trademarks of Microsoft Corporation.

Contents

1	Use the scanner	
	Scanner overview.....	3
	Scanner front panel buttons.....	3
	Scanner lamp setting.....	4
	Load original documents.....	5
	Use the automatic document feeder.....	5
	Document loading tips.....	5
	How to load documents.....	6
	Load an original on the scanner glass.....	8
	How to scan.....	9
	Associate a quick start button with scanning software.....	9
	Scan from scanning software.....	9
	Scan from HP Smart Document Scan Software.....	10
	Scan from ISIS- or TWAIN-compliant scanning software.....	10
	How to copy.....	10
2	Useful scanner features	
	Work with HP Smart Document Scan Software profiles.....	11
	Automatically rotate scanned pages.....	12
	Scan extra long documents.....	12
	Filter out color from a document (color dropout).....	12
	Set the background color for scans from the automatic document feeder.....	13
	Use scanner hardware compression for faster scans.....	13
	Disable Misfeed (Multipick) Detection.....	13
	Scan without reviewing.....	14
	Set up and use the imprinter.....	14
	Install or replace a print cartridge in the imprinter.....	14
	Position the imprinter.....	16
	Test the imprinter.....	16
	Clean the imprinter.....	17
	Use the imprinter.....	17
3	Care and maintenance	
	Order maintenance and scanning supplies.....	18
	Clean the automatic document feeder.....	18
	Clean the scanner glass.....	21
	Clean the scanner fan filters.....	21
	Replace the feed roller and separation pad.....	22
	HP Scanner Tools Utility scanner maintenance information.....	22
4	Troubleshooting	
	Scanner LEDs.....	24
	Installation troubleshooting.....	25
	Check that the scanner has power.....	25
	Check the USB connection.....	25
	Uninstall and then reinstall the HP Scanjet utilities.....	26
	Scanner operation problems.....	26
	Scanner will not turn on.....	26
	Scanner lamp stays on.....	26
	Scanner does not scan right away.....	27
	Scanner scans only one side of a double-sided page.....	27
	Scanned image is fuzzy.....	27
	Scanned pages are out of order at the scan destination.....	27
	Scanned pages are missing at the scan destination.....	27
	Optimizing scanning and task speeds.....	28

The image is completely black or completely white.....	28
Scanned images are not straight.....	28
Scanned images contain streaks or scratches.....	28
Vertical white stripes appear on the printed page.....	29
Scan files are too large.....	29
The imprinter is not printing or the print quality is poor.....	29
Scanner buttons are not working correctly.....	30
Buttons do not work.....	30
An unexpected program opens when a button is pressed.....	30
Wrong profile is used when the Scan button is pressed.....	30
Automatic document feeder problems.....	31
Clear a jam from the automatic document feeder.....	31
Automatic document feeder does not feed paper.....	33
The bottom of the scanned image is cut off.....	33
Additional troubleshooting information.....	34
5 Product care and support	
Maintenance, troubleshooting, and support.....	35
Getting assistance.....	35
6 Regulatory information and product specifications	36
7 Accessibility	39

1 Use the scanner

- [Scanner overview](#)
- [Load original documents](#)
- [How to scan](#)
- [Associate a quick start button with scanning software](#)
- [Scan from scanning software](#)
- [How to copy](#)

Scanner overview

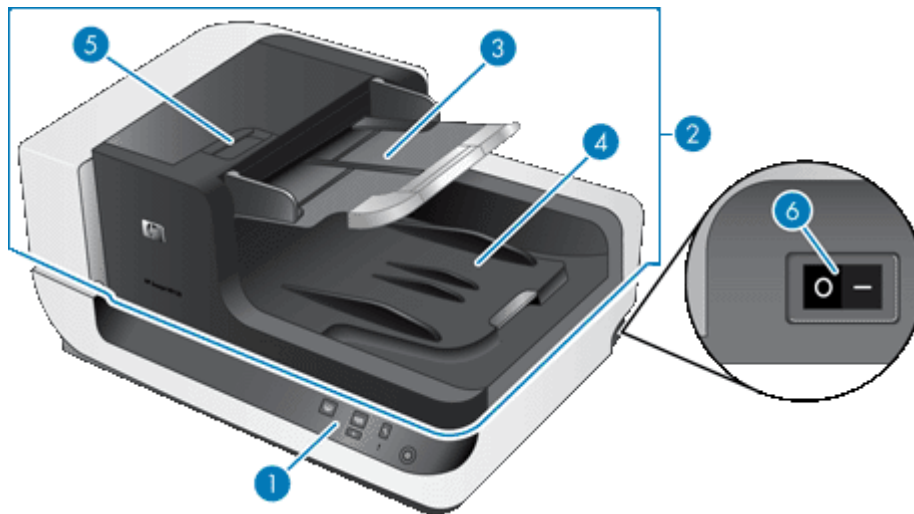

1	Front panel
2	Automatic document feeder (ADF)
3	ADF input tray
4	ADF output tray
5	Latch for opening the ADF
6	Power switch





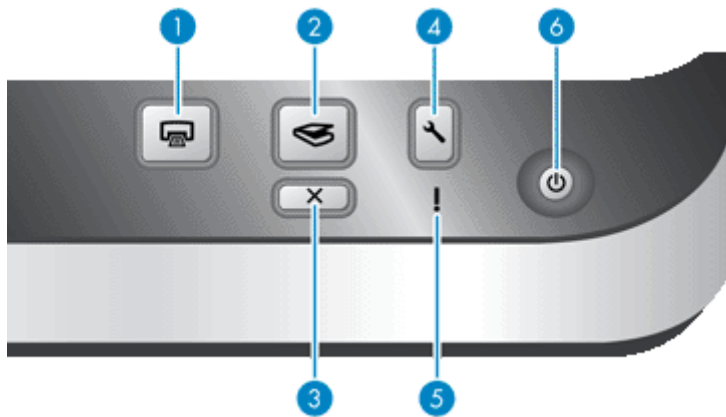

See also

- [Scanner front panel buttons](#)
- [Scanner lamp setting](#)

Scanner front panel buttons

Use the buttons on the scanner front panel to start a scan and to configure some scanner settings.



Icon	Button name	Description
1 	Copy	By default, print the number of copies currently configured in HP Document Copy. Alternatively, start the scanning software that is assigned to this button.
2 	Scan	By default, start a scan that uses the HP Smart Document Scan Software profile that is assigned to this button. Alternatively, start the scanning software that is assigned to this button.
3 	Cancel	Cancel a scan or copy in progress.
4 	Tools	Open the HP Scanner Tools Utility where you can do the following tasks: <ul style="list-style-type: none"> • Associate the scanner quick start buttons with scanning software • Configure the buttons on the scanner front panel • Manage the imprinter • View information about scanner settings, status, and maintenance
5 	Attention LED	The Attention LED provides status information about the scanner.
6 	Power Save	Press the Power Save button to put the scanner in Power Save mode when you are <i>not</i> using the scanner. When you are ready to begin scanning again, press the Power Save button to wake up the scanner.

See also

- [Scanner LEDs](#)

Scanner lamp setting

The scanner supports two modes of lamp operation:

- In Power Save mode, the scanner lamp times out and turns off automatically after about 15 minutes of inactivity. When you are ready to begin scanning again, press the **Power Save** button to wake up the scanner.
- In Instant Lamp On mode, the scanner lamp times out and turns off automatically after about 15 minutes of inactivity, but it remains warm and ready to scan.

To switch from Power Save mode to Instant Lamp On mode, select the **Enable Instant Lamp On** check box on the **Buttons** tab of the HP Scanner Tools Utility. To switch back to Power Save mode, clear the **Enable Instant Lamp On** check box.

Load original documents

You can scan up to 200 single- and double-sided document pages from the automatic document feeder (ADF), and you can scan one side of a document directly from the scanner glass.

The section contains the following topics:

- [Use the automatic document feeder](#)
- [Load an original on the scanner glass](#)

Use the automatic document feeder

For helpful information on loading your documents properly, refer to the following topics.

- [Document loading tips](#)
- [How to load documents](#)













Document loading tips

- The automatic document feeder (ADF) supports the following paper types.

Width:	70–300 mm (2.75–11.8 in)
Length:	148–864 mm (5.8–34 in)
Weight:	49–120 g/m ² (13–32 lb)

 **NOTE:** In the scanning software, set the page size to match the width and length of the paper that you are scanning.

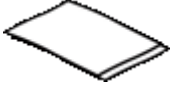
- Scanning the following types of documents might result in paper jams or damage to the documents. To scan these documents, make a photocopy, and then scan the copy instead.

	Wrinkled or creased documents		Curled documents
	Torn documents		Documents with paper clips or staples
	Carbon paper		Coated paper
	Extremely thin, translucent paper		Paper with adhesive notes or flags attached
	Photos		Overhead transparencies
	Papers that are stuck together		Paper with wet substances such as glue or correction fluid

- Before loading documents, make sure that the ADF access doors are securely latched.
- When loading a stack of documents, make sure that all of the documents are the same size.
- The maximum capacity of the ADF is 200 sheets of 75 g/m² (20 lb) paper. When using heavier paper, the maximum capacity is decreased. Use the fill line, shown below, as a guide for the maximum height of the document stack.

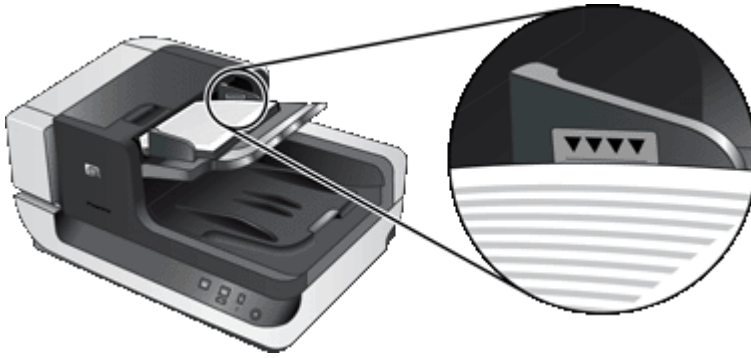

- For small or narrow documents, load the edge that is less than 148 mm (5.8 in) pointing into the feeder so that the longer edge can be pulled into the feeder and passed along by the feed rollers.

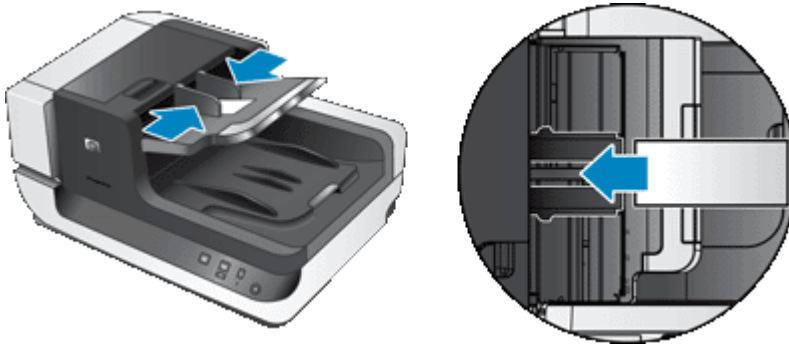

- When loading small or lightweight documents, such as A6 cards (index cards) or U.S. check carbons, load a stack of at least five documents to ensure that the ADF properly detects and feeds the stack. When scanning fewer than five small or lightweight documents, scan the documents by placing them on the scanner glass.
- When loading long documents that hang over the end of the input tray, pull out the input tray extender (1), and then load the documents (2).



How to load documents

1. Flip up the paper stop in the output tray that best matches the size of the documents that you are scanning. Select the stop position that is closest to (and beyond) the edge of your documents as they come out of the automatic document feeder (ADF).

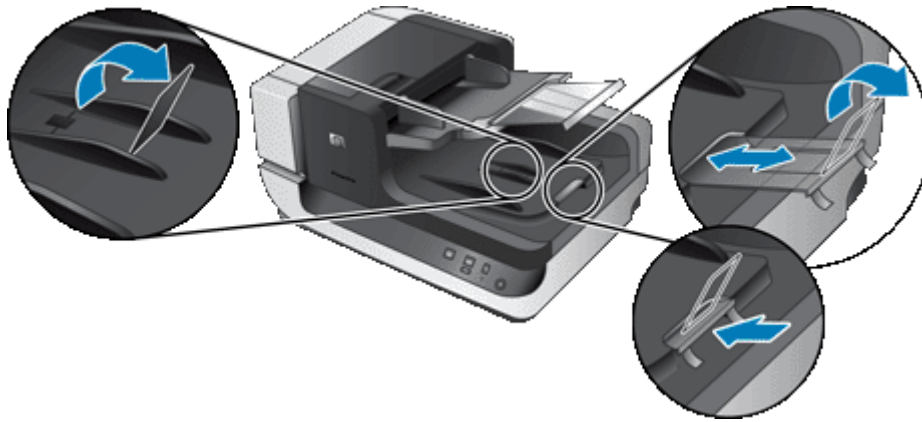

2. Fan the stack of document pages to ensure that the pages do not stick together. Fan the edge that will be pointing into the ADF in one direction, and then fan that same edge in the opposite direction.



3. Align the edges of the documents by tapping the bottom of the stack against the table top. Rotate the stack 90 degrees and repeat.

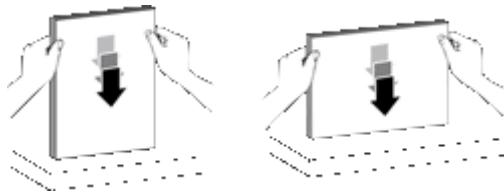

4. Place the stack in the middle of the input tray. Load the stack face up. For fastest scanning, load the stack with the left edge leading into the ADF.

 **NOTE:** In the scanning software, choose the layout setting that matches the orientation of the originals in the ADF.



5. Adjust the paper guides to the width of the documents. Take care not to overtighten the guides, which can restrict paper feeding, but make sure that the paper guides touch the edges of the documents.

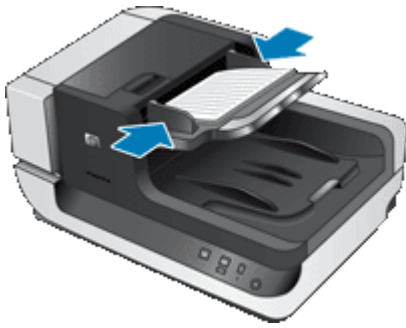

6. Gently push the stack forward to trip the tray sensor.

Load an original on the scanner glass

Place items that do not meet the specifications for the automatic document feeder (ADF) directly onto the scanner glass.

Minimum size:	Any size
Maximum size:	300 x 432 mm (11.8 x 17 in)

Place the original face down on the scanner glass, as indicated by the reference mark.



 **NOTE:** In the scanning software, choose the layout setting that matches the orientation of the original on the scanner glass.

How to scan

The basic steps for scanning are:

1. Load the originals.
2. Do one of the following:
 - Press the **Scan** (📄) button on the scanner front panel to start scanning with the assigned software (and profile, if appropriate).
 - On the computer, open the scanning software, and then select the ISIS or TWAIN data source. Select the appropriate settings, and then initiate a scan.

💡 **TIP: 1** To reduce paper jams, use scan settings that specify the actual dimensions of the pages that you are scanning.

TIP: 2 If you select duplex scanning or copying and you load the originals into the automatic document feeder (ADF), the scanner processes both sides of a two-sided original at the same time.

See also

- [Load original documents](#)
- [Associate a quick start button with scanning software](#)
- [Scan from scanning software](#)
- [Work with HP Smart Document Scan Software profiles](#)

Associate a quick start button with scanning software

The scanner includes two quick start buttons, **Scan** (📄) and **Copy** (📄). You can associate any button-aware scanning software with each of these buttons.

To associate a quick start button with scanning software, follow these steps:

1. Press the **Tools** (🔧) button on the scanner front panel to open the HP Scanner Tools Utility. Click the **Buttons** tab.
2. In the **Program to Start** drop-down list for a button, select the scanning software that you want this button to start.
3. Optionally, if you selected the HP Smart Document Scan Software, in the **Profile** drop-down list, select a profile.

If you do not select a profile, pressing the button starts the HP Smart Document Scan Software so that you can choose the scan settings each time that you start a new scan.

📄 **NOTE:** If you change the name of a profile that is assigned to a quick start button, update the button information in the HP Scanner Tools Utility.

See also

- [Work with HP Smart Document Scan Software profiles](#)

Scan from scanning software

You can scan an image or document directly into a software program if the program is ISIS or TWAIN compliant. Generally, the program is compliant if it has a menu option such as **Acquire**, **Scan**, **Import New Object**, or **Insert**. If you are unsure whether the program is compliant or what the option is, see the documentation for that program.

See also

- [Scan from HP Smart Document Scan Software](#)
- [Scan from ISIS- or TWAIN-compliant scanning software](#)

Scan from HP Smart Document Scan Software

1. Click **Start**, point to **Programs** or **All Programs**, point to **HP**, point to **HP Smart Document Scan**, and then click **HP Smart Document Scan Software**.
2. Select a profile, and then click **Scan**.

 **TIP:** A description of the selected profile is displayed below the list.

3. Follow the onscreen instructions to complete the scan.

For more information, see the HP Smart Document Scan Software Help.

Scan from ISIS- or TWAIN-compliant scanning software

1. Start the scanning software, and then select the ISIS or TWAIN data source.
2. Select the settings that are appropriate for the documents that you are scanning.
3. Carry out the appropriate actions to complete the scan.

For more information, see the online help for the scanning software.

How to copy

The basic steps for copying are:

1. Load the originals.
2. Do one of the following:
 - Press the **Copy** () button on the scanner front panel to print the copies with the current copy settings.
 - Click **Start**, point to **Programs** or **All Programs**, point to **HP**, point to **Scanjet**, point to **N9120**, and then click **Document Copy**.
Select print settings in the **HP Document Copy** dialog box.

 **NOTE:** If you want to change the copy settings, start the copy from the HP Document Copy software.

 **TIP: 1** You can configure HP Document Copy to always prompt for copy settings before starting to print. For information, see the HP Scanner Tools Utility help.

TIP: 2 If you select duplex scanning or copying and you load the originals into the automatic document feeder (ADF), the scanner processes both sides of a two-sided original at the same time.

See also

- [Load original documents](#)
- [Associate a quick start button with scanning software](#)
- [Scan from scanning software](#)

2 Useful scanner features

Experienced document management professionals might be interested in the following scan features that are available in the HP Smart Document Scan Software. Many of these features are also available from any ISIS- or TWAIN-compliant document scanning software that allows you to modify the scan settings.

- [Work with HP Smart Document Scan Software profiles](#)
- [Automatically rotate scanned pages](#)
- [Scan extra long documents](#)
- [Filter out color from a document \(color dropout\)](#)
- [Set the background color for scans from the automatic document feeder](#)
- [Use scanner hardware compression for faster scans](#)
- [Disable Misfeed \(Multipick\) Detection](#)
- [Scan without reviewing](#)
- [Set up and use the imprinter](#)

Work with HP Smart Document Scan Software profiles

An HP Smart Document Scan Software profile provides a fast, efficient way to select the settings for scanning and processing document pages. You can set up profiles for use with the quick start buttons on the scanner front panel.

Use the HP Smart Document Scan Software to set up and modify profiles. Use the HP Scanner Tools Utility to assign a profile to a quick start button on the scanner front panel.

You can configure each profile to perform specific scanning functions that you use often. For example, if you frequently need to scan originals at 200 dpi color to a searchable PDF file and e-mail that file to a co-worker, you can create a profile with the necessary settings to accomplish this task.

View profiles

The HP Smart Document Scan Software includes several default profiles.

To view the existing HP Smart Document Scan Software profiles, follow these steps:

1. Click **Start**, point to **Programs** or **All Programs**, point to **HP**, point to **HP Smart Document Scan**, and then click **HP Smart Document Scan Software**.
2. View the list of profiles.

Create profiles

To create an HP Smart Document Scan Software profile, follow these steps:

1. Click **Start**, point to **Programs** or **All Programs**, point to **HP**, point to **HP Smart Document Scan**, and then click **HP Smart Document Scan Software**.
2. Click **New**.
The Create New Profile dialog box is displayed.
3. In the **Profile name** box, type the name you want or accept the default name.

 **TIP:** You might want to set up the new profile based on an existing one. To do so, select the **Copy settings from profile** check box, and then select an existing profile from the list.

4. Click **Continue**.
The Profile Settings dialog box is displayed.
5. Select the settings for the profile.

For more information, see the HP Smart Document Scan Software Help.

Automatically rotate scanned pages

By default, pages fed through the automatic document feeder (ADF) appear in the scan output in the same orientation as the pages in the ADF input tray. The scanner can rotate the scan data to produce a different orientation in the scan output. For example, this feature is useful when you want fast scanning of pages that have a portrait orientation. You can load the longer edge of these pages into the ADF input tray and obtain scan output with the shorter edge of the pages at the top of the image.

To enable scanned page rotation in an HP Smart Document Scan Software profile, follow these steps:

1. Open the HP Smart Document Scan Software.
2. Select a scan profile, and then click **Edit**.
3. On the **Layout** tab of the **Profile Settings** dialog box, select the appropriate options for **Original Layout** and **ADF Feed Direction**.

 **NOTE:** In other scanning software, the options for rotating pages are on the **Layout** tab of the ISIS or TWAIN **Advanced Settings** dialog box.

Scan extra long documents

By default, the automatic document feeder (ADF) accepts a stack of originals up to 300 x 432 mm (11.8 x 17 in). You can choose to scan pages up to 300 x 864 mm (11.8 x 34 in) through the ADF.

To enable long-page scans in an HP Smart Document Scan Software profile, follow these steps:

1. Open the HP Smart Document Scan Software.
2. Select a scan profile, and then click **Edit**.
3. On the **Layout** tab of the **Profile Settings** dialog box, select **Custom** in the **Size** drop-down list, and then type the actual page dimensions, up to 300 x 864 mm (11.8 x 34 in), in the **Width** and **Height** boxes.

 **NOTE: 1** In other scanning software, the page size settings are on the **Layout** tab of the ISIS or TWAIN **Advanced Settings** dialog box.

NOTE: 2 Some scanning and destination software (including the Kofax VirtualReScan driver) might not support all of the page sizes that the scanner accepts.

NOTE: 3 HP recommends scanning long pages individually at a resolution of 300 dpi or lower.

Filter out color from a document (color dropout)

You can filter out a dark background from the image content, for example black text on green paper or red instructions on a form. Removing colors from the scan might reduce the scan file size and improve optical character recognition (OCR) results. You can select to filter out a color channel (red, green, or blue) or up to three specific colors. For specific colors, the sensitivity setting controls how closely a scanned color must approximate the specified color.

To select colors to eliminate from a scan in an HP Smart Document Scan Software profile, follow these steps:

1. Open the HP Smart Document Scan Software.
2. Select a scan profile, and then click **Edit**.
3. On the **Scan** tab of the **Profile Settings** dialog box, click **Advanced Settings**.
4. On the **Color Dropout** tab of the **Properties** dialog box, specify the color dropout settings.

For information about the color dropout settings, see the online help for the scanning software that you are using.

 **NOTE: 1** The color channel filter only applies to grayscale scans and to black and white scans. Specific color filters apply to all color modes.

NOTE: 2 To filter out color in another scanning software, navigate to the ISIS or TWAIN **Advanced Settings** dialog box. On the **Color Dropout** tab, specify the color dropout settings.

Set the background color for scans from the automatic document feeder

When you scan from the automatic document feeder (ADF), you can choose a white or black background for the scan. When the scan background contrasts with the color at the outside edges of the document, the scanning software is better able to distinguish the edges of the scanned document. For example, use the black background to scan a document that is printed on white paper.

To select the scan background color in an HP Smart Document Scan Software profile, follow these steps:

1. Open the HP Smart Document Scan Software.
2. Select a scan profile, and then click **Edit**.
3. On the **Scan** tab of the **Profile Settings** dialog box, click **Advanced Settings**.
4. On the **More** tab of the **Properties** dialog box, select a color from the **ADF Background** drop-down list.

 **NOTE:** To set the scan background color in another scanning software, navigate to the ISIS or TWAIN **Advanced Settings** dialog box. On the **More** tab, select a color from the **ADF Background** drop-down list.

Use scanner hardware compression for faster scans

The scanner supports multiple levels of JPEG compression to increase the rate of data transfer from the scanner to the scanning software on the computer. The scanner compresses the data during the scanning process. The scanning software can uncompress the data in order to create scanned images. JPEG compression works on grayscale and color scans.

To enable JPEG compression in an HP Smart Document Scan Software profile, follow these steps:

1. Open the HP Smart Document Scan Software.
2. Select a scan profile, and then click **Edit**.
3. Turn on compression:
 - ▲ On the **Scan** tab of the **Profile Settings** dialog box, select the **Use scanner compression (for optimal speed)** check box.
4. Set how much compression should be performed:
 - a. On the **Scan** tab of the **Profile Settings** dialog box, click **Advanced Settings**.
 - b. On the **More** tab of the **Properties** dialog box, move the **Scanner JPEG Compression** slider to the position that you want.

 **NOTE:** To specify the level of JPEG compression in another application, navigate to the TWAIN or ISIS **Advanced Settings** dialog box, and then move the **Scanner JPEG Compression** slider to the position that you want.

Disable Misfeed (Multipick) Detection

The Misfeed (Multipick) Detection feature stops the scan or copy process if it senses that multiple pages are fed into the scanner at one time. This feature is enabled by default.

To disable the Misfeed (Multipick) Detection feature in an HP Smart Document Scan Software profile, follow these steps:

1. Open the HP Smart Document Scan Software.
2. Select a scan profile, and then click **Edit**.
3. On the **Scan** tab of the **Profile Settings** dialog box, click **Advanced Settings**.
4. On the **More** tab of the **Properties** dialog box, clear the **Enable** check box.

 **NOTE:** To disable the Misfeed (Multipick) Detection feature in another scanning software, navigate to the ISIS or TWAIN **Advanced Settings** dialog box. On the **More** tab, clear the **Enable** check box.

Scan without reviewing

The standard process for using the HP Smart Document Scan Software to complete your scans is as follows:

1. Scan document pages.
2. Review the scanned document pages in the HP Smart Document Scan Software **Scan Progress Window**. Reorder, delete, and rescan pages as necessary.
3. Finish the scan by clicking **Done Scanning** in the **Scan Progress Window**.
4. Wait for the scanning software to process the scanned document pages according to the profile settings.

You can set up a profile that skips steps 2 and 3 of the standard process. After you select this profile, press the **Scan** button on the scanner front panel or click **Scan** in the HP Smart Document Scan Software **Main Window**. The pages will be scanned and processed without further intervention.

In order for a scan to complete automatically, the selected HP Smart Document Scan Software profile must include the following settings:

- On the **Profile** tab, the **Display thumbnails when scanning** check box must be cleared.
- Additional settings on the **Destination** tab, such as disabling the **Show Save As** dialog box, might be required depending on the profile.

Set up and use the imprinter

The scanner includes an imprinter that can print a text message and index number on the back of documents that are fed through the automatic document feeder (ADF). An imprinter mark verifies that the document has been scanned, and the mark can indicate when the scan occurred.

 **NOTE:** If you are scanning two-sided pages, the imprinter mark might print over existing content on the pages.

- [Install or replace a print cartridge in the imprinter](#)
- [Position the imprinter](#)
- [Test the imprinter](#)
- [Clean the imprinter](#)
- [Use the imprinter](#)

Install or replace a print cartridge in the imprinter

The scanner uses an HP 51604A print cartridge. You must purchase the print cartridge separately.

1. Raise the ADF input tray until it clicks into place.



2. Lift the green lever slightly, and slide the imprinter completely to the left.

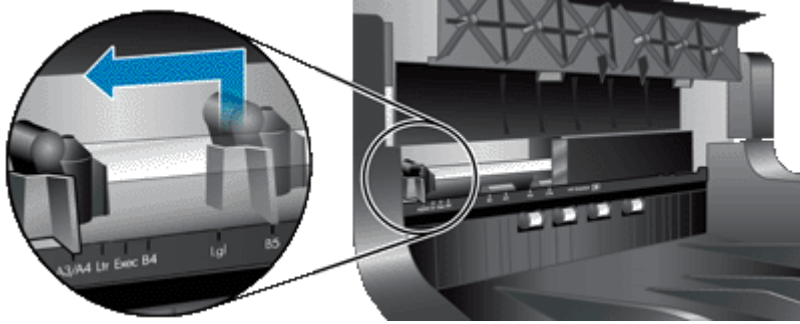

3. Raise the cartridge stall latch.



4. If you are replacing an empty print cartridge, slide it to the right to remove it from the cartridge stall.
5. Remove the print cartridge from its packaging. Pull the tab to remove the protective tape from the nozzles.

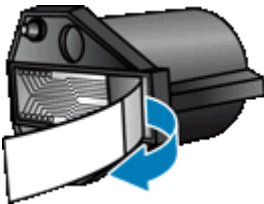

6. Hold the new print cartridge with the nozzles down and slide it into the cartridge stall.

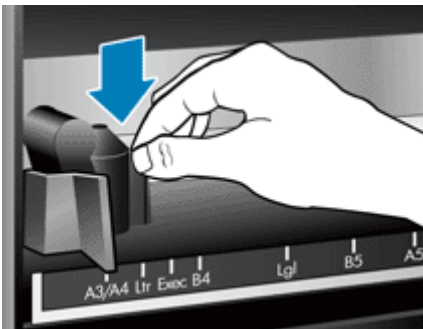

7. Lower the cartridge stall latch to lock the print cartridge in place.

8. Grasp the center of the ADF input tray, and then lower the ADF input tray into position for scanning.
9. Update the imprinter history:
 - a. Press the **Tools** (🔧) button on the scanner front panel to open the HP Scanner Tools Utility. Click the **Imprinter** tab.
 - b. In the **Cartridge Status** section, click **Record Replacement**.

Position the imprinter

The position of the imprinter determines the left-right location of the imprinter mark on the scanned page.

 **NOTE:** For narrow pages, if the imprinter is positioned outside of the width of the paper in the ADF input tray, the imprinter is not able to print on the scanned pages. In this case, the scan does not complete and an error message is displayed on the computer screen.

1. Raise the ADF input tray until it clicks into place.



2. Lift the green lever slightly, and then slide the imprinter to the position that you want.

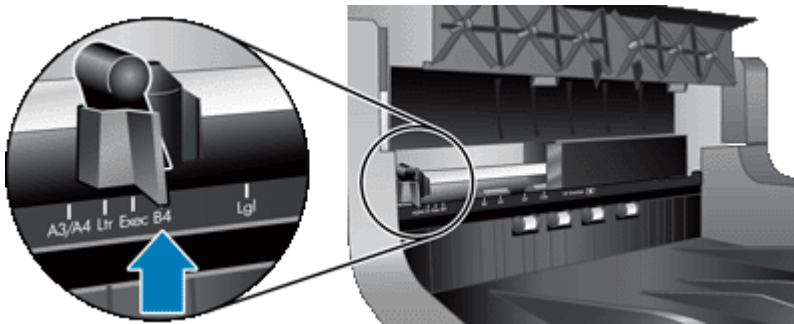

 **NOTE:** Several paper sizes are indicated in the imprinter carriage. If you set the imprinter at the position for the paper size that you are using, the imprinter mark is printed about 5 mm (.2 in) from the side of the page. You can select any position that prints on the size of the paper that you are using. If you leave the imprinter between the marked positions, the imprinter might shift during scanning, and the imprinter mark will be of poor quality.

3. Grasp the center of the ADF input tray, and then lower the ADF input tray into position for scanning.

Test the imprinter

Test the imprinter to verify that the print cartridge is loaded properly and to check the placement of the imprinter mark on the page.

 **NOTE:** To prevent the counter value from changing during the test, the imprinter test prints a preset mark in the configured location.

1. Place a single page in the automatic document feeder input tray.
2. Press the **Tools** (🔧) button on the scanner front panel to open the HP Scanner Tools Utility. Click the **Imprinter** tab.
3. In the **Cartridge Status** section, click **Test Imprinter**.

Clean the imprinter

Clean the imprinter whenever the imprinter mark does not print completely.

1. Press the **Tools** (🔧) button on the scanner front panel to open the HP Scanner Tools Utility. Click the **Imprinter** tab.
2. In the **Cartridge Status** section, click **Clean Imprinter**.

Use the imprinter

1. Open the HP Smart Document Scan Software.
2. Select a scan profile, and then click **Edit**.
3. On the **Scan** tab of the **Profile Settings** dialog box, click **Advanced Settings**.
4. On the **Imprinter** tab of the **Properties** dialog box, select **Enable Imprinting**.
5. In the **Text** box, enter the text to be printed on the back of each scanned document.

You can also do the following:

- Set a counter for number of pages imprinted.
- Include the date and time in the imprinter mark.
- Specify the distance between the leading edge of the document and the beginning of the imprinter mark.
- Rotate the imprinter mark.
- Make the imprinter mark bold.
- Disable scanning when the print cartridge is running low on ink.

3 Care and maintenance

This section presents information about how to care for and maintain the scanner.

- [Order maintenance and scanning supplies](#)
- [Clean the automatic document feeder](#)
- [Clean the scanner glass](#)
- [Clean the scanner fan filters](#)
- [Replace the feed roller and separation pad](#)
- [HP Scanner Tools Utility scanner maintenance information](#)

Occasional cleaning of the scanner helps ensure high-quality scans. The amount of care necessary depends upon several factors, including the amount of use and the environment. You should perform routine cleaning as necessary.

Routine cleaning and maintenance should include cleaning the automatic document feeder (ADF), the scanner glass, and the fan filters.

⚠ CAUTION: Avoid placing items that have sharp edges, paper clips, staples, wet glue, correction fluid, or other substances in the scanner. Document pages should not be curled, wrinkled, or stuck together.

Order maintenance and scanning supplies

You can purchase maintenance parts online. Items such as the feed roller replacement kit are available for worldwide delivery.

1. Visit the HP scanner support Web site at www.hp.com/support.
2. Select your country/region, and then select your language.
3. Enter the scanner model number, and then press **Enter**.

Clean the automatic document feeder

The automatic document feeder (ADF) requires periodic maintenance depending on the amount of use and the type of paper that is fed through it. Clean the ADF under the following conditions:

- The ADF rollers are visibly dirty.
- The ADF has trouble feeding documents.
- Vertical streaks appear in images scanned by the ADF.
- After scanning a document that is dusty, dirty, or has pencil writing on it through the ADF.
- The environment is dusty.

If you use the ADF several times per week, monthly cleaning is recommended. Set up a cleaning routine that is appropriate for the scanner.

1. Press the **Power** switch to the off position, and then disconnect the USB cable and power cable from the scanner.
2. Open the scanner lid.

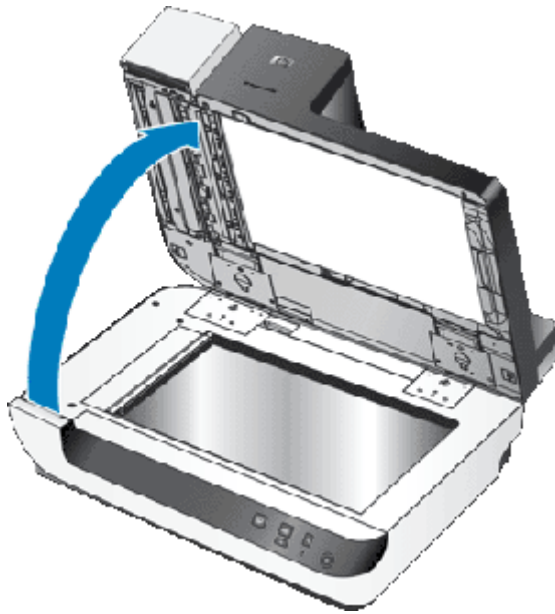

3. Clean the clear scanning strip on the scanner bed. Wipe the clear area with a clean, damp, lint-free cloth.



4. Close the scanner lid.
5. Lift the latch on top of the ADF to open the top and side ADF access doors.



6. Locate the white strip on the side ADF access door and the clear scan window inside the ADF. Wipe both of these areas clean with a clean, damp, lint-free cloth.

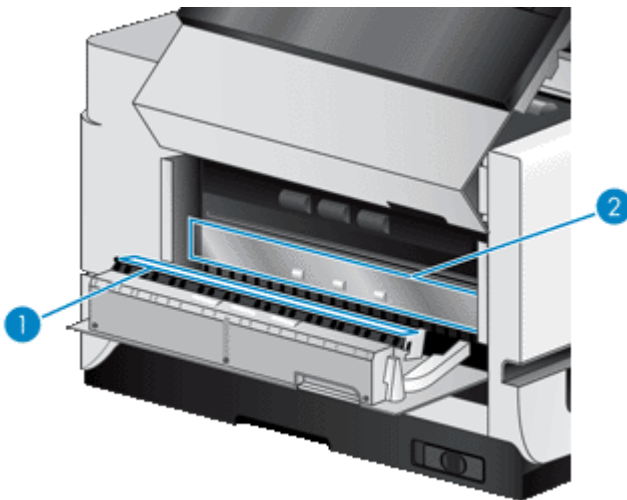

7. Wipe the ADF rollers with a clean, damp, lint-free cloth.

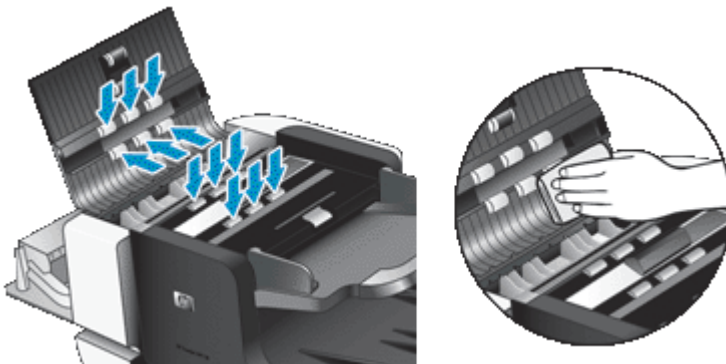

8. Wait several minutes for the rollers to dry, and then close the ADF access doors.
9. Reconnect the USB cable and power cable to the scanner, and then press the **Power** switch to the on position.

Clean the scanner glass

Clean the scanner glass under the following conditions:

- Streaks, scratches, or spots appear in images scanned from the scanner glass.
- After scanning a document that is dusty or dirty from the scanner glass.
- The environment is dusty.

To clean the scanner glass, follow these steps:

1. Press the **Power** switch to the off position, and then disconnect the USB cable and power cable from the scanner.
2. Open the scanner lid.
3. Clean the glass by using a soft, lint-free cloth that has been sprayed with a mild glass cleaner.

⚠ CAUTION: Use only glass cleaner to clean the scanner glass. Avoid cleaners that contain abrasives, acetone, benzene, and carbon tetrachloride, all of which can damage the scanner glass. Avoid isopropyl alcohol because it can leave streaks on the glass.

Do not spray the glass cleaner directly on the glass. If too much glass cleaner is applied, the cleaner could leak under the glass and damage the scanner.

4. Dry the glass with a dry, soft, lint-free cloth.
5. Reconnect the USB cable and power cable to the scanner, and then press the **Power** switch to the on position.

📝 NOTE: If cleaning the top surface of the glass does not remove all dirt and smudges from the glass, you can also clean the underside of the glass. Cleaning the underside of the glass requires that you disassemble the scanner. For instructions on how to clean the underside of the scanner glass, go to www.hp.com/support.

Clean the scanner fan filters

The scanner includes two customer-accessible fan filters. These filters prevent dust and debris from entering the fans. If the scanner is in a dirty or dusty environment, clean the filters monthly.

For each fan filter, follow these steps:

1. Press the **Power** switch to the off position, and then disconnect the USB cable and power cable from the scanner.
2. Remove the filter cover.

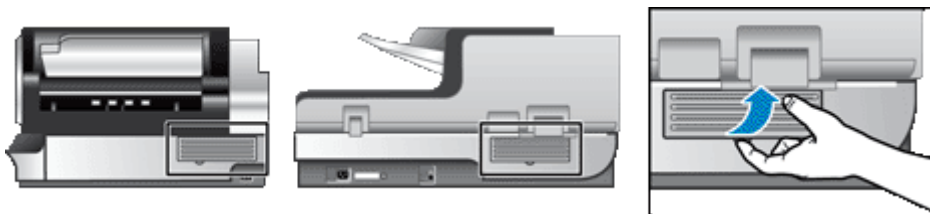

3. Clean the filter in one of the following ways:
 - Use compressed air to blow the debris off of the filter.
 - Use a vacuum to remove the debris from the filter.
 - Rinse the filter with water.

 **NOTE:** If the filter is damaged, replace it with a new filter. To order a replacement part, go to www.hp.com/support

4. Inspect the filter cover. If it is dirty, use a clean, damp, lint-free cloth to remove the dirt.
5. Ensure that the filter and the filter cover are completely dry.

 **CAUTION:** A wet filter can damage the scanner.

6. Place the clean, dry filter in the filter cover, and then replace the cover on the scanner.

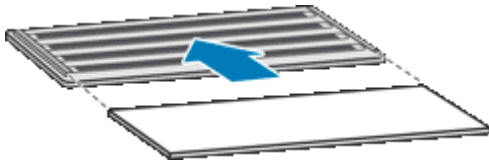

7. Reconnect the USB cable and power cable to the scanner, and then press the **Power** switch to the on position.

Replace the feed roller and separation pad

Replace the feed roller and separation pad under either of the following conditions:

- Streaks on scans or paper jams occur repeatedly and cleaning the automatic document feeder does not help.
- The HP Scanner Tools Utility **Maintenance** tab indicates that maintenance is due.

The feed roller replacement kit contains a feed roller and installation instructions. The separation pad replacement kit contains a separation pad and installation instructions. To order replacement kits, go to www.hp.com/support.

1. Press the **Power** switch to the off position, and then disconnect the USB cable and power cable from the scanner.
2. Inspect and clean the two customer-accessible fan filters.
3. Open the top ADF access door, and then replace the feed roller and separation pad as described in the installation instructions that were included with the replacement kits.
4. Close all ADF access doors, and then reconnect the USB cable and power cable to the scanner.
5. Press the **Power** switch to the on position, and then update the scanner maintenance history:
 - a. Press the **Tools**  button on the scanner front panel to open the HP Scanner Tools Utility. Click the **Maintenance** tab.
 - b. In the **Feed Roller Maintenance** and **Separation Pad Maintenance** sections, click **Record Replacement**.

For more information, see the HP Scanner Tools Utility help.

See also

- [Clean the scanner fan filters](#)

HP Scanner Tools Utility scanner maintenance information

The **Maintenance** tab of the HP Scanner Tools Utility displays the scanner usage and maintenance history. You can use this tab to record scanner maintenance.

The **Imprinter** tab of the HP Scanner Tools Utility displays information about the scanner imprinter and the imprinter print cartridge. You can use this tab to record that the print cartridge has been replaced.

To open the HP Scanner Tools Utility, press the **Tools** button on the scanner front panel.

For detailed information on using the HP Scanner Tools Utility, see the HP Scanner Tools Utility help.

4 Troubleshooting

This section contains solutions for common problems with the scanner.











- [Scanner LEDs](#)
- [Installation troubleshooting](#)
- [Scanner operation problems](#)
- [Scanner buttons are not working correctly](#)
- [Automatic document feeder problems](#)
- [Additional troubleshooting information](#)

For additional troubleshooting, see the online help for the scanning software that you are using or visit www.hp.com/support for updated information about the scanner.

Scanner LEDs

The scanner has two LED lights on the front panel that indicate scanner functions and error conditions. The LED in the shape of an exclamation point (!) is the Attention LED, and the LED in the **Power Save** button is the Power LED. The table below explains how to interpret the indicator LEDs.



LED indications		Scanner action or condition
 The Attention LED quickly blinks amber.	 The Power LED is lit with a steady green light.	Error condition. Check your computer screen for an error message.
 The Attention LED is lit with a steady amber light.	 The Power LED is lit with a steady green light.	Attention condition. Check your computer screen for a Maintenance Recommended message.
 The Attention LED slowly blinks green.	 The Power LED is lit with a steady green light.	The scanner is warming up.
	 The Power LED is lit with a steady, dim amber light.	The scanner is in Power Save mode.
	 The Power LED is lit with a steady green light.	The scanner is on and ready to scan.
 The Attention LED blinks green at a medium speed.	 The Power LED is lit with a steady green light.	The scanner is scanning an original.
Both LEDs are off.		There is no power to the scanner.

Installation troubleshooting

If the scanner does not work after installation or if the scanner has stopped working correctly, you might see a message on the computer screen that is similar to one of the following:

- The scanner could not be initialized.
- The scanner could not be found.
- An internal error has occurred.
- The computer cannot communicate with the scanner.

To fix the problem, check the scanner cables and software as described in the following sections:

- [Check that the scanner has power](#)
- [Check the USB connection](#)
- [Uninstall and then reinstall the HP Scanjet utilities](#)

Check that the scanner has power

The power cable is connected between the scanner and a power outlet.

- Ensure that the power cable is securely connected between the scanner and a live electrical outlet.
- If the power cable is connected to a surge protector, ensure that the surge protector is plugged into an outlet and turned on.
- Ensure that the **Power** switch on the right side of the scanner is in the on position.



If the problem persists after verifying the above items, try the following:

1. Press the **Power** switch to the off position, and then disconnect the power cable from the scanner.
2. Wait 30 seconds.
3. Reconnect the power cable to the scanner, and then press the **Power** switch to the on position.
After 30 seconds, the **Power LED** is lit with a steady green light and the **Attention LED** is off.

Check the USB connection

Check the physical connection to the scanner.

- Use the cable that was included with the scanner. Another USB cable might not be compatible with the scanner.
- Ensure that the USB cable is securely connected between the scanner and the computer or USB hub. The trident icon on the USB cable faces up when the cable is properly connected to the scanner.

If the problem persists after verifying the above items, try the following:

1. Do one of the following tasks depending on how the scanner is connected to the computer:
 - If the USB cable is connected to a USB hub or a docking station for a laptop, disconnect the USB cable from the USB hub or the docking station, and then connect the USB cable directly to the computer.
 - If the USB cable is directly connected to the computer, plug it into another USB port on the computer.
 - Remove all other USB devices from the computer except for the keyboard and the mouse.
2. Press the **Power** switch to the off position, wait 30 seconds, and then press the **Power** switch to the on position.

3. Restart the computer.
4. After the computer has restarted, try using the scanner.
If the scanner works and you changed the way it was connected to the computer in step 1, the communication problem might involve the USB hub, the docking station, a USB port, or another USB device. Leave the scanner directly connected to the computer. Try using the scanner after reconnecting each additional USB device, and disconnect any USB devices that prevent the scanner from working correctly.
If the scanner does not work, uninstall and then reinstall the HP Scanjet drivers and utilities.

Uninstall and then reinstall the HP Scanjet utilities

If checking the scanner cable connections did not solve the problem, the problem might have occurred because of an incomplete installation. Try uninstalling and then reinstalling the HP scanning utilities.

1. Press the **Power** switch to the off position, and then disconnect the USB cable and power cable from the scanner.
2. Use the **Add/Remove** tool (in Windows Vista, the **Programs and Features** tool) from the **Control Panel** to uninstall the following items:
 - HP Scanjet N9120 Document ISIS/TWAIN
 - HP Scanjet N9120 Utilities
3. Restart the computer.
4. Use the HP Scanning Software CD that came with the scanner to reinstall the HP Scanjet Drivers and Tools.
5. Reconnect the USB cable and power cable to the scanner, and then press the **Power** switch to the on position.
After 30 seconds, the **Power LED** is lit with a steady green light and the **Attention LED** is off.

Scanner operation problems

- [Scanner will not turn on](#)
- [Scanner lamp stays on](#)
- [Scanner does not scan right away](#)
- [Scanner scans only one side of a double-sided page](#)
- [Scanned image is fuzzy](#)
- [Scanned pages are out of order at the scan destination](#)
- [Scanned pages are missing at the scan destination](#)
- [Optimizing scanning and task speeds](#)
- [The image is completely black or completely white](#)
- [Scanned images are not straight](#)
- [Scanned images contain streaks or scratches](#)
- [Vertical white stripes appear on the printed page](#)
- [Scan files are too large](#)
- [The imprinter is not printing or the print quality is poor](#)

Scanner will not turn on

If the scanner will not turn on when you press the front panel scanner buttons, verify the following:

- Verify that power is being supplied to the scanner.
- Ensure that the **Power** switch on the right side of the scanner is in the on position.
- The scanner may have been unplugged. Check to see that the power cable has not become disconnected from the scanner or unplugged from the power source.

Scanner lamp stays on

The scanner lamp should time out and turn off automatically after a period of inactivity (about 15 minutes).

If the scanner lamp remains on after a long period of inactivity, turn off the scanner, wait 30 seconds, and then turn the scanner back on.

 **NOTE:** The scanner lamp does not turn off when paper is in the automatic document feeder input tray.

Scanner does not scan right away

Make sure the power switch on the right side of the scanner is turned on.

If the scanner has not been used for a while, the scanner lamp might need to go through a warm-up period before scanning can begin. If the scanner lamp needs to warm up, it takes a moment after starting the software or pressing a scanner button for scanning to begin.

You can enable Instant Lamp On mode in the HP Scanner Tools Utility.

Scanner scans only one side of a double-sided page

Verify the following:

- For single pass duplex scanning, scan pages through the ADF.
- Select the **Duplex** setting in the scanning or copy software.

Scanned image is fuzzy

When scanning with the automatic document feeder (ADF), follow these steps:

1. Verify that the document original is not fuzzy.
2. Check for any obstructions in the scanner paper path and make sure that the paper guides are positioned appropriately. Try another scan.
3. If the scanned image is still of poor quality, clean the ADF.

When scanning from the scanner glass, it is important that the item you scan comes in close contact with the scanner glass. Follow these steps:

1. Verify that the document original is not fuzzy.
2. Check to see that the item is in full contact with the scanner glass.
3. If the scanned image is still of poor quality, clean the scanner glass.

See also

- [Clean the automatic document feeder](#)
- [Clean the scanner glass](#)

Scanned pages are out of order at the scan destination

Insert a multiple-page document with the printed first page of the document facing up and with the top or left edge of the document pointing into the feeder.

See also

- [Load original documents](#)

Scanned pages are missing at the scan destination

When scanning with the ADF, pages that stick together are scanned as one item. The hidden pages are not scanned. Enable Misfeed (Multipick) Detection to stop the scan or copy process if multiple pages are fed into the scanner at one time.

To enable the Misfeed (Multipick) Detection feature in an HP Smart Document Scan Software profile, follow these steps:

1. Open the HP Smart Document Scan Software.
2. Select a scan profile, and then click **Edit**.

3. On the **Scan** tab of the **Profile Settings** dialog box, click **Advanced Settings**.
4. On the **More** tab of the **Properties** dialog box, select the **Enable** check box.

Optimizing scanning and task speeds

Several settings influence the total time for a scanning job. When you want to optimize scanning performance, consider the following information.

- To optimize scanning speed for pages that are A4 (or Letter) size or smaller, load the pages with the long edge feeding into the automatic document feeder (ADF). Scanning pages by loading the long edge first minimizes the length of the media passing the scan heads, which results in faster scans.

 **NOTE:** In the scanning software, choose the layout setting that matches the orientation of the originals in the ADF.

- To optimize data transfer from the scanner to the scanning software on the computer, enable scanner hardware (JPEG) compression. Typically, the use of scanner compression reduces the time to complete all color scans and grayscale scans with resolution above 300 dpi. Scanner compression affects the rate of data transfer only and can be used with all output formats.
- If you are scanning to edit text, the optical character recognition (OCR) software requires more processing time than for non-OCR scans, which is normal. Wait for the item to scan.

 **NOTE:** For the best OCR results, scanner compression should be set to the minimum compression level or disabled.

- Scanning at a higher resolution than necessary increases scanning time and creates a larger file with no additional benefit. If you are scanning at a high resolution, set the resolution to a lower level to increase scanning speed.

See also

- [Automatically rotate scanned pages](#)
- [Use scanner hardware compression for faster scans](#)
- [Scan files are too large](#)

The image is completely black or completely white

When scanning with the ADF, check the paper orientation.

When scanning from the scanner glass, the item might not be placed correctly on the scanner glass. Make sure that the item you are trying to scan is placed face down on the glass and the lid is closed.

See also

- [Load original documents](#)

Scanned images are not straight

When scanning with the automatic document feeder, make sure that the paper guides touch the edges of the original. Make sure that all documents are of the same size.

When scanning from the scanner glass, the item might have shifted when you closed the lid. Straighten the original on the scanner glass, and then scan again.

Scanned images contain streaks or scratches

When scanning with the automatic document feeder (ADF), follow the steps below. After each step, try another scan to see if the streaks or scratches are still apparent. If so, try the next step.

1. Check that the originals are clean and unwrinkled.
2. Clean the ADF or the scanner glass.
3. Replace the separation pad and the feed roller.

See also

- [Clean the automatic document feeder](#)
- [Clean the scanner glass](#)
- [Replace the feed roller and separation pad](#)

Vertical white stripes appear on the printed page

The destination printer might be out of toner or ink. Scan a different original to the same printer to see if the issue lies with the printer.

If the second original has the same problem, clean the automatic document feeder or the scanner glass.

See also

- [Clean the automatic document feeder](#)
- [Clean the scanner glass](#)

Scan files are too large

If the saved scans have very large file sizes, try the following:

- Verify the scan resolution setting:
 - 200 dpi is sufficient for storing documents as images.
 - For most fonts, 300 dpi is sufficient for using optical character recognition (OCR) to create editable text.
 - For Asian fonts and small fonts, 400 dpi is the recommended resolution.Scanning at a higher resolution than necessary creates a larger file with no additional benefit.
- Color scans create larger files than do black and white scans.
- If you are scanning a large number of pages at one time, consider scanning fewer pages at a time to create more, smaller files.
- Use the Kofax VirtualReScan software to process the scanned data. Kofax VirtualReScan compresses the data, which can result in a smaller file.

The imprinter is not printing or the print quality is poor

If you reset the ink level in the HP Scanner Tools Utility the last time that you replaced the print cartridge, you will receive imprinter status alerts when the ink level is running low. If you did not reset the ink level at the time that you replaced the print cartridge, you might receive erroneous imprinter status alerts or the imprinter might run out of ink before the HP Scanner Tools Utility reports that the ink level is low.

 **NOTE:** To use the imprinter, load originals in the automatic document feeder (ADF). The imprinter cannot print on pages placed on the scanner glass.

To remedy other imprinter problems, try the following:

1. Verify that the **Enable Imprinting** check box is selected in the scanning software.
2. If the imprinter ink is smearing or leaving blobs of ink on the paper, remove the print cartridge, and then gently wipe the copper contacts of the print cartridge with a clean, damp, lint-free cloth. Reinstall the print cartridge, but do *not* reset the ink level in the HP Scanner Tools Utility.
3. Verify that the cartridge stall latch holds the print cartridge firmly in place.
4. Verify that the imprinter is positioned at one of the predefined locations that is inside the width of the paper as it is fed through the ADF.
5. Clean and test the imprinter:
 - a. Press the **Tools** () button on the scanner front panel to open the HP Scanner Tools Utility. Click the **Imprinter** tab, and then click **Clean Imprinter**.
 - b. Ensure that the ADF has at least one piece of paper in the input tray.
 - c. In the HP Scanner Tools Utility, click **Test Imprinter**.
 - d. If the imprinter print quality is good, continue scanning. Otherwise, replace the print cartridge.

See also

- [Set up and use the imprinter](#)

Scanner buttons are not working correctly

- [Buttons do not work](#)
- [An unexpected program opens when a button is pressed](#)
- [Wrong profile is used when the Scan button is pressed](#)

Buttons do not work

After each step, press a button to see if it is working correctly. If the problem persists, proceed with the next step.

1. The buttons might be disabled in the HP scanning software. Ensure that the **Disable front panel buttons** setting in the HP Scanner Tools Utility is cleared.
2. A cable might be loose. Ensure that the USB cable and the power supply are securely connected.
3. Turn off the scanner, wait 30 seconds, and then turn the scanner back on.
4. Restart your computer.
5. If the problem persists, the buttons might be disabled outside of the HP scanning software. Try the following procedure:
 - a. Open **Control Panel**, select **Scanners and Cameras**, and then select your scanner model from the list.
 - b. Display the scanner properties:
 - Windows 2000: Click **Properties**.
 - Windows XP and Vista: Right-click your scanner model, and then click **Properties**.
 - c. Examine the buttons setting for your scanner:
 - Windows 2000: Ensure that the **Disable Device Events** option is not selected.
 - Windows XP and Vista: Ensure the **Take No Action** option is not selected.

An unexpected program opens when a button is pressed

 **NOTE:** The **Scan** and **Copy** button settings can be changed in the HP Scanner Tools Utility. You cannot change the settings for the **Cancel**, **Tools**, or **Power Save** buttons.

After each step, press a button to see if it is working correctly. If the problem persists, proceed with the next step.

1. On the **Buttons** tab of the HP Scanner Tools Utility, determine the associations for the **Scanner Front Panel Buttons**. If necessary, change the software that is assigned to a button.
2. Verify that the expected program is installed on the computer by looking at the **Start** menu. If necessary, install the program.
3. If the problem persists, the buttons might be assigned outside of the HP Scanner Tools Utility. Try the following procedure:
 - a. Open **Control Panel**, select **Scanners and Cameras**, and then select your scanner model from the list.
 - b. Display the scanner properties:
 - Windows 2000: Click **Properties**.
 - Windows XP and Vista: Right-click your scanner model, and then click **Properties**.
 - c. Ensure that the **Start this program** option is selected and that the correct application is selected in the drop-down list.

Wrong profile is used when the Scan button is pressed

If you are using the HP Smart Document Scan Software, use the HP Scanner Tools Utility to determine which HP Smart Document Scan Software profile is assigned to the **Scan** button. If necessary, reset the profile assigned to the button.

 **NOTE:** You can also assign an HP Smart Document Scan Software profile to the **Copy** button.

If you are using other scanning software, see the online help for that program.

See also

- [Associate a quick start button with scanning software](#)

Automatic document feeder problems

Use this section to help resolve issues that might occur when scanning from the automatic document feeder (ADF).

Paper jams usually result from inappropriate paper being fed into the ADF. Review the tips for using the ADF. If misfeeds occur frequently, perform ADF maintenance.

This section contains the following topics:

- [Clear a jam from the automatic document feeder](#)
- [Automatic document feeder does not feed paper](#)
- [The bottom of the scanned image is cut off](#)

See also

- [Use the automatic document feeder](#)
- [Disable Misfeed \(Multipick\) Detection](#)
- [Care and maintenance](#)

Clear a jam from the automatic document feeder

1. Remove any loose pages from the automatic document feeder (ADF) input tray.
2. Lift the latch on top of the ADF to open the top and side ADF access doors.



3. Remove any jammed pages from the ADF input tray.

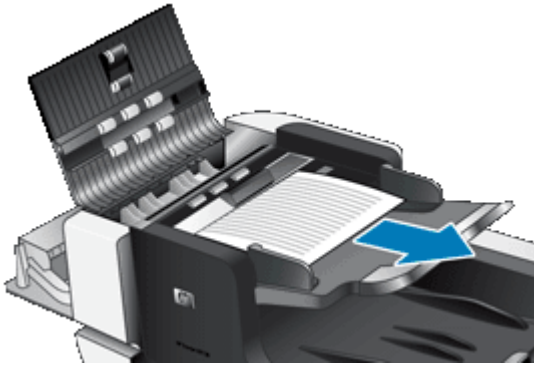

4. Remove any jammed pages from inside the ADF.

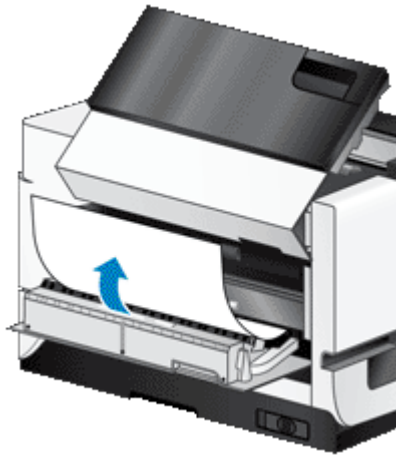

5. Remove any jammed pages from the ADF output tray.



6. If the jammed page still cannot be removed, follow these steps:
 - a. Open the scanner lid.
 - b. Push the green tab toward the scanner lid to open the inner ADF access door. If the door does not open automatically, gently pry it open.
 - c. Gently pull the page out of the ADF.

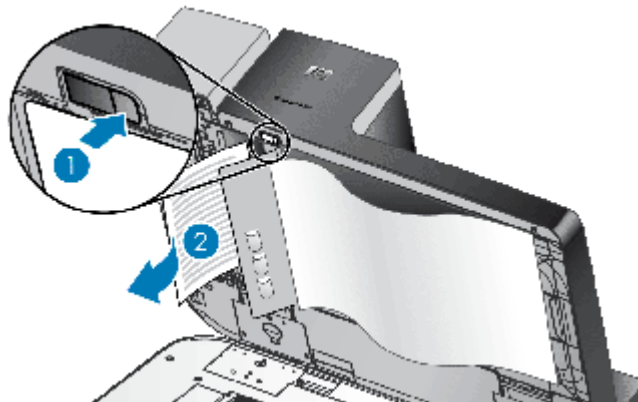

7. Close the inner ADF access door, and then close the scanner lid.
8. At the scan destination, examine the scan output to determine which page was the last to be completely scanned.
9. Reload the unscanned pages in the ADF input tray. If any pages are damaged, do one of the following:
 - Photocopy the damaged page, and then add the photocopy to the input stack.
 - Scan the damaged page from the scanner glass.
 - Reprint the original document.

Prepare the stack as follows:

- a. Fan the stack of document pages to ensure that the pages do not stick together. Fan the edge that will be pointing into the feeder in one direction, and then fan that same edge in the opposite direction.



- b. Align the edges of the documents by tapping the bottom of the stack against the table top. Rotate the stack 90 degrees and repeat.

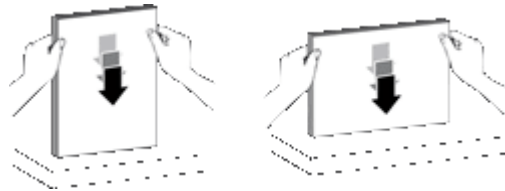

10. Resume scanning.

Automatic document feeder does not feed paper

- The automatic document feeder (ADF) access doors might not be securely latched. Open the ADF access doors, and then close the doors by pressing firmly.
- A problem with the ADF hardware might exist. Use the following procedure to test the ADF:
 - Disconnect the USB cable and the power cable from the scanner. Check that the power cable is still connected to the power source.
 - Ensure that the ADF has at least one piece of paper in the input tray.
 - Reconnect the power cable to the scanner, and then turn the scanner on.
 - Try to scan another page through the ADF.

The bottom of the scanned image is cut off

By default, the scanner can scan paper that is up to 432 mm (17 in) long. For longer pages, the end of the document is not included in the scanned image.

Verify that you have specified an appropriate page size in the scanning software.

See also

- [Scan extra long documents](#)

Additional troubleshooting information

For additional troubleshooting information, see the following resources:

- For information about the scanning software that you are using, see the online help for that program.
- To look for updated information about the scanner, visit the HP scanner support Web site at www.hp.com/support.
 - Select your country/region, and then select your language.
 - Enter the scanner model number, and then press **Enter**.
- If you do not have Internet access, for support contact information, see the information about getting assistance in the scanner getting started guide.

5 Product care and support

This section describes the options for product support.

- [Maintenance, troubleshooting, and support](#)
- [Getting assistance](#)

Maintenance, troubleshooting, and support

Occasional cleaning of the scanner helps ensure higher-quality scans. The amount of care necessary depends upon several factors, including the amount of use and the environment. You should perform routine cleaning as necessary.

Routine cleaning and maintenance should include cleaning the scanner glass and the automatic document feeder (ADF).

⚠ **CAUTION:** Avoid placing items that have sharp edges, paper clips, staples, wet glue, correction fluid, or other substances in the scanner. Document pages should not be curled, wrinkled, or stuck together.

Getting assistance

In order to get the best from your HP product, please consult the following standard HP support offerings:

1. Please consult the product documentation that came with the product.
Review the troubleshooting section in this manual.
2. Visit the **HP online support** at www.hp.com/support or contact your point of purchase.
HP online support is available to all HP customers. It is the fastest source for up-to-date product information and expert assistance, including the following features:
 - Online chat and E-mail access to qualified support specialists
 - Software and driver updates for your product
 - Valuable product and troubleshooting information for technical issues
 - Proactive product updates, support alerts, and HP newsletters (available when you register your product)
3. **HP support by phone**
 - Support options and fees vary by product, country/region and language.
 - Fees and policies are subject to change without notice. Please check the web site www.hp.com/support for the latest information.
4. **Post-warranty period**
After the limited warranty period, help is available online at www.hp.com/support.
5. **Extending or upgrading your warranty**
If you would like to extend or upgrade the product's warranty, please contact your point of purchase or check the HP Care Pack offers at www.hp.com/support.
6. If you already purchased an **HP Care Pack Service**, please check the support conditions in your contract.

6 Regulatory information and product specifications

Scanner specifications

Name	Description
Scanner type	Flatbed with automatic document feeder (ADF)
Size	692 x 558 x 343 mm (27.3 x 22.0 x 13.5 in)
Weight	38.5 kg (85 lb)
Scanning element	Charge-coupled device (CCD)
Interface	USB 2.0 high speed (compatible with USB 1.1)
Optical resolution	600 x 600 dpi hardware
AC power	100–240V~, 50/60Hz, 1.8A
Power consumption	For power consumption information, see the regulatory_supplement.htm file on the HP Scanning Software CD.
Energy information	To learn if your HP scanner is ENERGY STAR® qualified, go to www.hp.com , select your country/region, and then search on <i>Energy Star</i> .

Automatic document feeder (ADF) specifications

Name	Description
Paper tray capacity	200 sheets of 75 g/m ² (20 lb)
Minimum paper size	70 x 148 mm (2.75 x 5.8 in)
Maximum paper size	300 x 864 mm (11.8 x 34 in)
Minimum paper weight	49 g/m ² (13 lb)
Maximum paper weight	120 g/m ² (32 lb)

Imprinter specifications

Name	Description
Print cartridge	HP 51604A

Environmental specifications

Name	Description
Temperature	Operating the scanner: 10° to 35° C (50° to 95° F)
	Storage: -40° to 65° C (-40° to 149° F)
Relative humidity	Operating the scanner: 10% to 80% noncondensing 10° to 35° C (50° to 95° F)
	Storage: up to 90% at 0° to 65° C (32° to 149° F)

Regulatory information

Regulatory Model Identification Number: For regulatory identification purposes your product is assigned a Regulatory Model Number. The Regulatory Model Number for your product is FCLSD-0705. This regulatory number should not be confused with the marketing name (HP Scanjet N9120/Flow N9120) or

product number (L2683A/L2683B). Additional regulatory information about your scanner can be found on the regulatory_supplement.htm file on the HP Scanning Software CD.

Materials disposal

This HP product contains the following materials that might require special handling at end-of-life:

- Mercury in the fluorescent lamp in the scanner and/or transparent materials adapter.

Disposal of this material can be regulated because of environmental considerations. For disposal or recycling information, please contact your local authorities or the Electronic Industries Alliance (EIA) www.eiae.org.

Disposal of Waste Equipment by Users in Private Households in the European Union



This symbol on the product or on its packaging indicates that this product must not be disposed of with your other household waste. Instead, it is your responsibility to dispose of your waste equipment by handing it over to a designated collection point for the recycling of waste electrical and electronic equipment. The separate collection and recycling of your waste equipment at the time of disposal will help to conserve natural resources and ensure that it is recycled in a manner that protects human health and the environment. For more information about where you can drop off your waste equipment for recycling, please contact your local city office, your household waste disposal service or the shop where you purchased the product.

HP limited warranty statement

HP Scanjet Enterprise N9120/Flow N9120

Model	Asia/Pacific	Americas	Europe/Middle East/Africa
N9120/Flow N9120	1 year	1 year	1 year

1. HP warrants to you, the end-user customer, that HP hardware, accessories, and supplies will be free from defects in materials and workmanship after the date of purchase, for the period specified above. If HP receives notice of such defects during the warranty period, HP will, at its option, either replace or repair products which prove to be defective. Replacement products may be either new or equivalent in performance to new.
2. HP warrants to you that HP software will not fail to execute its programming instructions after the date of purchase, for the period specified above, due to defects in material and workmanship when properly installed and used. If HP receives notice of such defects during the warranty period, HP will replace software which does not execute its programming instructions due to such defects.
3. HP does not warrant that the operation of HP products will be uninterrupted or error free. If HP is unable, within a reasonable time, to repair or replace any product to a condition as warranted, you will be entitled to a refund of the purchase price upon prompt return of the product.
4. HP products may contain remanufactured parts equivalent to new in performance or may have been subject to incidental use.
5. This warranty does not apply to defects resulting from (a) improper or inadequate maintenance or calibration, (b) software, interfacing, parts, or supplies not supplied by HP, (c) unauthorized modification or misuse, (d) operation outside of the published environmental specifications for the product, or (e) improper site preparation or maintenance.
6. TO THE EXTENT ALLOWED BY LOCAL LAW, THE ABOVE WARRANTIES ARE EXCLUSIVE AND NO OTHER WARRANTY OR CONDITION, WHETHER WRITTEN OR ORAL, IS EXPRESSED OR IMPLIED, AND HP SPECIFICALLY DISCLAIMS ANY IMPLIED WARRANTIES OR CONDITIONS OF MERCHANTABILITY, SATISFACTORY QUALITY, AND FITNESS FOR A PARTICULAR PURPOSE. Some countries/regions, states, or provinces do not allow limitations on the duration of an implied warranty, so the above limitation or exclusion

might not apply to you. This warranty gives you specific legal rights, and you might also have other rights that vary from country/region to country/region, state to state, or province to province.

7. HP's limited warranty is valid in any country/region or locality where HP has a support presence for this product and where HP has marketed this product. The level of warranty service you receive may vary according to local standards. HP will not alter the form, fit, or function of the product to make it operate in a country/region in which it was never intended to function for legal or regulatory reasons.

8. TO THE EXTENT ALLOWED BY LOCAL LAW, THE REMEDIES IN THIS WARRANTY STATEMENT ARE YOUR SOLE AND EXCLUSIVE REMEDIES. EXCEPT AS INDICATED ABOVE, IN NO EVENT WILL HP OR ITS SUPPLIERS BE LIABLE FOR LOSS OF DATA OR FOR DIRECT, SPECIAL, INCIDENTAL, CONSEQUENTIAL (INCLUDING LOST PROFIT OR DATA), OR OTHER DAMAGE, WHETHER BASED IN CONTRACT, TORT, OR OTHERWISE. Some countries/regions, states, or provinces do not allow the exclusion or limitation of incidental or consequential damages, so the above limitation or exclusion may not apply to you.

9. THE WARRANTY TERMS CONTAINED IN THIS STATEMENT, EXCEPT TO THE EXTENT LAWFULLY PERMITTED, DO NOT EXCLUDE, RESTRICT, OR MODIFY AND ARE IN ADDITION TO THE MANDATORY STATUTORY RIGHTS APPLICABLE TO THE SALE OF THIS PRODUCT TO YOU.

HP Scanjet Enterprise N9120/Flow N9120

7 Accessibility

Accessibility features

- [LED Reader](#)
- [Control of the scanner buttons](#)

LED Reader

The LED Reader is software that outputs the status of the indicator LEDs on the scanner front panel to the computer monitor as the LEDs change. The LED Reader enables accessibility software tools to express what is being shown on the scanner front panel.

To use the LED Reader, follow these steps:

1. On your hard drive, navigate to the C:\Program Files\Common Files\HP\Scanjet\9120\ directory.
2. To start the program, double-click **hpled.exe**.

 **NOTE:** The LED Reader is not able to display the LED indications when there is a USB connection error or the scanner is off.

See also

- [Scanner LEDs](#)

Control of the scanner buttons

To prevent buttons from being pushed accidentally, you can disable the buttons on the scanner front panel.

When the buttons are disabled, you always start scans and copies from the computer using scanning software. You can still press the **Cancel** button on the scanner front panel to stop a scan or copy and the **Power Save** button to put the scanner into Power Save mode.

To turn off the scanner buttons, follow these steps:

1. Open the HP Scanner Tools Utility.
2. On the **Buttons** tab, select the **Disable front panel buttons** check box.
To turn on the scanner buttons, clear the **Disable front panel buttons** check box.

 **NOTE:** You must have administrative privileges on the computer to change the setting of this check box.
