

# Your HTC Desire

## User guide

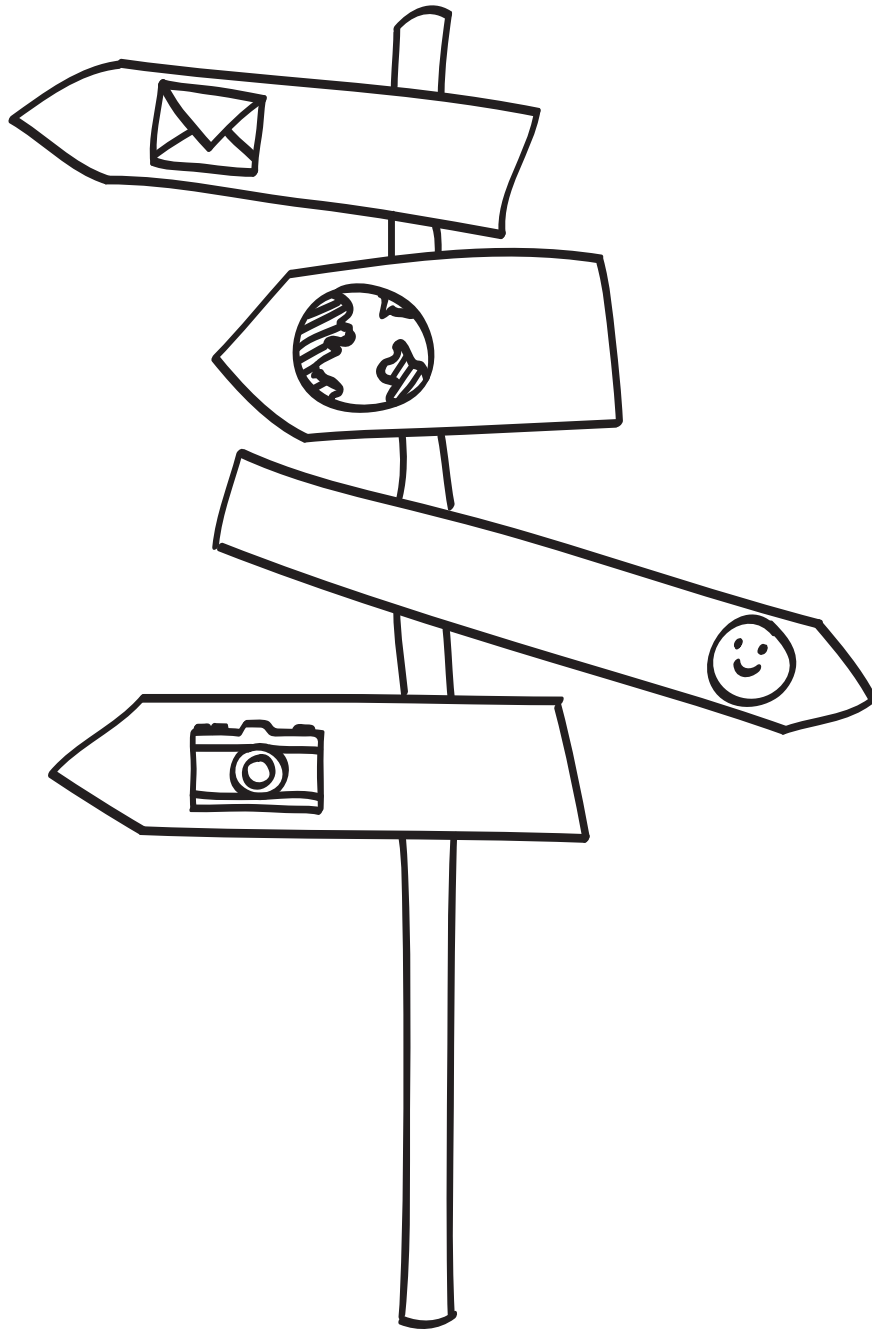

**htc**  
*quietly brilliant*

# Before you do anything else, please read this

---

## Charge the battery

The battery in your phone hasn't been charged yet. While your phone is charging, it's important that you do not remove the battery pack. Doing so can damage your phone. Also, please don't try to take your phone apart. (If you do, it may invalidate your warranty.)

## Choose a rate plan wisely

Your phone can use up a lot of Internet bandwidth really quickly. Before you use your phone, we strongly recommend that you talk to your mobile operator about data rates. If you're on a standard data plan, the costs could really add up. Switching to a flat-rate plan could be a lot cheaper.

## Know about privacy laws

Some countries have strict laws about how and when you can record phone conversations. For example, you may need to tell the person you're speaking to before you start recording. It's a good idea to find out what the laws are where you live before you use your phone's recording feature.

## And finally, a few important words from our legal team (LIMITATION OF DAMAGES)

To the maximum extent permitted by applicable law, in no event shall HTC or its affiliates be liable to you, any user, or third party for any indirect, special, consequential, incidental or punitive damages of any kind, arising in contract, tort, or otherwise, including, but not limited to, injury, loss of revenue, loss of goodwill, loss of business opportunity, loss of data, and/or loss of profits, regardless of the foreseeability thereof or whether HTC or its affiliates have been advised of the possibility of such damages. And in no event shall the total liability of HTC or its affiliates exceed the amount received from you, regardless of the legal theory under which the cause of action is brought. The foregoing does not affect any statutory rights which may not be disclaimed.

Please also read the Safety and regulatory guide that is included in the box for information on the proper usage of your phone to prevent injuries and to avoid damaging your phone. You can also refer to this guide for regulatory information about your phone.

You can also visit our support website at [www.htc.com/support](http://www.htc.com/support) to download the Safety and regulatory guide and to access other helpful resources for your phone.

# Trademarks and copyrights

---

Copyright © 2010 HTC Corporation. All Rights Reserved.

The HTC logo, the HTC quietly brilliant logo, HTC Desire, HTC Sense, Footprints, HTC Sync, and HTC Care are trademarks and/or service marks of HTC Corporation.

Copyright © 2010 Google Inc. Used with permission.

Google, the Google logo, Android, Google Search, Google Maps, Gmail, Google Mail, YouTube, Android Market, and Google Talk are trademarks of Google Inc.

Google, the Google logo and Google Maps are trademarks of Google, Inc. TeleAtlas® Map Data ©2010. Street View Images ©2010 Google.

Microsoft, Windows, Windows XP, Windows Vista, Active Sync, and Outlook are either registered trademarks or trademarks of Microsoft Corporation in the United States and/or other countries.

Bluetooth and the Bluetooth logo are trademarks owned by Bluetooth SIG, Inc.

Wi-Fi is a registered trademark of the Wireless Fidelity Alliance, Inc.

microSD is a trademark of SD Card Association.

Java, J2ME and all other Java-based marks are trademarks or registered trademarks of Sun Microsystems, Inc. in the United States and other countries.

Facebook is a trademark of Facebook, Inc.

Twitter is a trademark of Twitter, Inc., and is used under license.

Flickr is a trademark of Yahoo! Inc.

Licensed by QUALCOMM Incorporated under one or more of the following patents:

4,901,307 5,490,165 5,056,109 5,504,773 5,101,501 5,778,338 5,506,865 5,109,390 5,511,073  
5,228,054 5,535,239 5,710,784 5,267,261 5,544,196 5,267,262 5,568,483 5,337,338 5,659,569  
5,600,754 5,414,796 5,657,420 5,416,797

All other company, product and service names mentioned herein are trademarks, registered trademarks or service marks of their respective owners.

HTC shall not be liable for technical or editorial errors or omissions contained herein, nor for incidental or consequential damages resulting from furnishing this material. The information is provided "as is" without warranty of any kind and is subject to change without notice.

HTC also reserves the right to revise the content of this document at any time without prior notice.

No part of this document may be reproduced or transmitted in any form or by any means, electronic or mechanical, including photocopying, recording or storing in a retrieval system, or translated into any language in any form without prior written permission of HTC.

## Conventions used in this guide

---

In this user guide, we use the following symbols to indicate useful and important information:



This is a note. A note often gives additional information, such as what happens on your phone when you choose to do or not to do a certain action. A note also provides information that may only be applicable to some situations.



This is a tip. A tip gives you an alternative way to do a particular step or procedure, or lets you know of an option that you may find helpful.



This indicates that something is very important. Important information is something that you need to do in order to accomplish a certain task or to get a phone feature to work properly.



This provides safety precaution information, that is, information that you need to be careful about to prevent potential problems when using your phone.

# Contents

## Basics

Inside the box .....	14
Your Phone.....	14
Front panel .....	14
Back panel .....	15
Top panel.....	16
Left panel.....	16
Before turning on your phone .....	17
Back cover .....	17
Storage card .....	17
Battery .....	18
Finger gestures.....	20
Getting started .....	21
Turning on your phone .....	21
Turning off your phone.....	21
Setting up your phone for the first time .....	21
Sleep mode.....	22
Home screen .....	24
Extended Home screen .....	24
Navigating the Home screen .....	24
Phone status and notifications.....	25
Phone status icons.....	25
Notification icons.....	26
Checking notifications .....	27
Adjusting the volume.....	28
Adjusting the ringer volume .....	28
Adjusting the media volume.....	28
Connecting your phone to a computer .....	29
Copying files to and from the storage card .....	30
Searching your phone and the Web .....	31
Setting Web and Quick Search Box options .....	31
Searching the Web and your phone using the Quick Search Box.....	31

## Personalizing

Making your phone truly yours .....	32
Changing the ringtone .....	32
Personalizing your phone with scenes.....	33
Using a preset scene.....	33
Customizing and saving a scene .....	33
Renaming or deleting a scene .....	34
Changing your wallpaper .....	35
Personalizing your Home screen with widgets.....	36
Adding a widget to your Home screen .....	36
Downloading HTC widgets.....	36
Adding application icons and other shortcuts on your Home screen .....	37

<b>Adding folders on your Home screen .....</b>	<b>38</b>
Creating a new folder and adding items to it.....	38
Renaming a folder.....	38
<b>Rearranging or removing widgets and icons on your Home screen.....</b>	<b>39</b>
Moving a widget or icon .....	39
Removing a widget or icon .....	39

## Phone calls

<b>Making calls .....</b>	<b>40</b>
Calling somebody using your phone .....	40
Calling a speed dial number.....	40
Calling using Voice Dialer.....	41
Calling a phone number in a text message .....	41
Calling a phone number in an email.....	41
Making an emergency call .....	42
Using Assisted Dialing.....	42
<b>Receiving calls.....</b>	<b>43</b>
Answering an incoming call .....	43
Rejecting an incoming call.....	44
Rejecting a call and sending a text message.....	44
<b>Using in-call options.....</b>	<b>45</b>
Handling multiple calls.....	45
Setting up a conference call .....	45
Muting the microphone during a call.....	46
Turning the speakerphone on or off during a call.....	46
Ending a call .....	46
<b>Using call history .....</b>	<b>47</b>
Adding a new phone number to your contacts from call history .....	47
Checking a missed call.....	48
Clearing the call history list .....	48
<b>Call services.....</b>	<b>49</b>
Turning Airplane mode on or off .....	50

## People

<b>About People .....</b>	<b>51</b>
<b>Ways of getting contacts into your phone.....</b>	<b>51</b>
<b>People screen .....</b>	<b>52</b>
Setting up My contact card.....	52
Your contacts list.....	52
Adding a new contact.....	53
Importing contacts from an Exchange ActiveSync account .....	54
Merging contact information.....	54
Editing a contact's information .....	54
Searching for a contact.....	55
Backing up your contacts to the storage card.....	55
Importing contacts from the storage card.....	55
Deleting contacts .....	55
Sending contact information as a vCard via MMS .....	55
Sending your contact information as a vCard via MMS.....	56

<b>Contact groups</b> .....	<b>57</b>
Creating a group and adding contacts.....	57
Deleting a group.....	57
Adding or removing contacts from a group.....	57
Sending an SMS/MMS message or email to a group.....	58
<b>Contact information and conversations</b> .....	<b>59</b>
<b>People widget</b> .....	<b>60</b>
Adding the People widget.....	60
Setting the default communication method.....	60
Changing the default communication method.....	60
Getting in touch with a contact .....	60

## Keyboard

<b>Using the onscreen keyboard</b> .....	<b>61</b>
Using the landscape onscreen keyboard.....	61
Changing the onscreen keyboard layout.....	61
Entering text.....	62
Entering words with predictive text.....	62
Entering text with voice input.....	63
<b>Adjusting touch input settings</b> .....	<b>64</b>
Touch Input settings .....	64
Text input.....	64

## Messages

<b>About Messages</b> .....	<b>66</b>
Sending text and multimedia messages .....	66
<b>New message notifications</b> .....	<b>69</b>
<b>WAP push messages</b> .....	<b>70</b>
<b>Managing message conversations</b> .....	<b>71</b>
Protecting a message from deletion.....	72
Deleting a message thread.....	72
Deleting several message threads .....	72
Deleting a single message .....	72
Viewing contact details and communicating with a contact .....	72
<b>Setting text and multimedia message options</b> .....	<b>73</b>
<b>Adding the Messages widget</b> .....	<b>74</b>

## Accounts and sync

<b>Synchronizing with online accounts</b> .....	<b>75</b>
Adding a social network account.....	75
Synchronizing with a Google Account .....	75
Synchronizing with a Microsoft Exchange ActiveSync account.....	76
Managing your accounts .....	76
<b>Using HTC Sync</b> .....	<b>77</b>
Installing HTC Sync.....	77
Setting up HTC Sync to recognize your phone.....	78
Setting up synchronization.....	78
Setting up more sync options.....	79
Synchronizing your phone.....	79
Downloading the latest HTC Sync upgrade .....	80
Installing apps from your computer to your phone .....	80

## Social

<b>Facebook for HTC Sense and Facebook for Android application.....</b>	<b>81</b>
Facebook for HTC Sense .....	81
Facebook for Android application.....	81
Differences between Facebook for HTC Sense and Facebook for Android application ...	82
<b>Twittering on your phone.....</b>	<b>83</b>
Peep screen.....	83
Sending a tweet .....	83
Searching for Twitter users to follow.....	84
Sending a direct message.....	84
Setting Peep options .....	84
Adding the Twitter widget.....	85
<b>Using Friend Stream.....</b>	<b>86</b>
Friend Stream screen .....	86
Updating your status.....	87
Adding the Friend Stream widget.....	87
<b>Chatting in Google Talk.....</b>	<b>88</b>
Signing in to Google Talk.....	88
Chatting with friends.....	88
Changing your online status and picture.....	89
Managing your Friends list.....	90
Changing Google Talk settings.....	91

## Email

<b>Using Gmail/Google Mail .....</b>	<b>93</b>
Viewing your Gmail/Google Mail inbox .....	93
Reading your messages.....	94
Sending a message.....	96
Managing conversations and messages.....	97
Changing Gmail/Google Mail settings .....	99
<b>Mail.....</b>	<b>100</b>
Adding a POP3/IMAP email account .....	100
Viewing your email inbox .....	100
Exchange ActiveSync email.....	102
Composing and sending an email message.....	103
Viewing and replying to an email message.....	104
Editing email account settings .....	104
Deleting an email account .....	104
Adding the Mail widget.....	104

## Calendar

<b>About Calendar.....</b>	<b>105</b>
<b>Creating a calendar event.....</b>	<b>105</b>
Inviting guests to your event (Google Account only).....	106
Sending a meeting request using Calendar (Exchange ActiveSync only).....	106
<b>Changing calendar views .....</b>	<b>107</b>
Month view .....	107
Day and Agenda views.....	108
Week view.....	109
<b>Viewing, editing or deleting an event.....</b>	<b>110</b>
Viewing and editing an event.....	110
Deleting an event.....	110



Calendar event reminders .....	111
Viewing, dismissing, or snoozing event reminders .....	111
Displaying and synchronizing calendars .....	112
Showing or hiding calendars .....	112
Choosing which Google Calendars are synchronized on your phone .....	112
Changing Calendar settings .....	113
Reminder settings .....	113
Calendar view settings .....	113
Sending a vCalendar .....	114
About the Calendar widget .....	114

## Clock and Weather

About the HTC Clock widget .....	115
About the Clock application .....	116
Using Desk Clock .....	117
Using World Clock .....	118
Setting your home city .....	118
Setting the time zone, date, and time .....	118
Adding a city to the World Clock screen .....	119
Setting the alarm clock .....	120
Setting an alarm .....	120
Deleting an alarm .....	120
Changing alarm sound settings .....	121
Checking weather .....	122
Adding a city to the Weather screen .....	122
Changing the order of cities on the Weather screen .....	123
Deleting cities from the Weather screen .....	123
Changing weather options .....	123
About the Weather widget .....	123

## Internet

Data connection .....	124
Turning the data connection on or off .....	124
Enabling data roaming .....	124
Wi-Fi .....	125
Turning Wi-Fi on and connecting to a wireless network .....	125
Connecting to a Wi-Fi network with EAP-TLS security .....	125
Checking the wireless network status .....	126
Connecting to another Wi-Fi network .....	126
Adding the Data connection and Wi-Fi widgets .....	127
Connecting to a virtual private network (VPN) .....	128
Preparing your phone for VPN connection .....	128
Adding a VPN connection .....	128
Connecting to a VPN .....	128
Disconnecting from a VPN .....	129
Using your phone's web browser .....	130
Opening the browser .....	130
Going to a web page .....	130
Setting your home page .....	130
Changing the screen orientation .....	130

Browsing full versions of all web sites.....	130
Navigating on a web page.....	131
Zooming in or out on a web page .....	131
Selecting a link in a web page.....	131
Opening a new browser window .....	132
Switching between browser windows .....	133
Finding text within a web page.....	133
Downloading applications from the web.....	133
Copying text, looking up information, and sharing .....	134
Viewing bookmarks and previously visited pages.....	135
Setting browser options.....	136
<b>Using your phone as a modem (tethering).....</b>	<b>137</b>

## Bluetooth

<b>Using Bluetooth .....</b>	<b>138</b>
Turning Bluetooth on or off.....	138
Changing the phone name .....	138
<b>Connecting a Bluetooth headset or car kit .....</b>	<b>139</b>
Reconnecting a headset or car kit.....	139
<b>Disconnecting or unpairing from a Bluetooth device .....</b>	<b>140</b>
Disconnecting a Bluetooth device.....	140
Unpairing from a Bluetooth device .....	140
<b>Sending and receiving information using Bluetooth .....</b>	<b>141</b>
Sending information from your phone to another device .....	141
Receiving information from another device.....	142

## Camera

<b>Camera basics.....</b>	<b>144</b>
Viewfinder screen.....	144
Using the optical joystick as the shutter release .....	145
Review screen .....	145
<b>Zooming.....</b>	<b>146</b>
<b>Taking a photo.....</b>	<b>147</b>
Capturing a video.....	148
<b>Camera settings.....</b>	<b>149</b>
Changing basic settings.....	149
Changing advanced settings .....	149

## Photos

<b>About the Photos application .....</b>	<b>151</b>
<b>Selecting an album .....</b>	<b>151</b>
<b>Viewing photos and videos .....</b>	<b>152</b>
Browsing in filmstrip or grid view.....	152
Viewing a photo in landscape orientation .....	153
Zooming in or out on a photo.....	153
Watching video .....	153
<b>Viewing photos in your social networks.....</b>	<b>154</b>
Viewing photos on Facebook.....	154
Viewing photos on Flickr .....	154

<b>Working with photos</b> .....	<b>155</b>
Rotating and saving a photo .....	155
Cropping a photo .....	155
<b>Sharing</b> .....	<b>156</b>
Sending photos or videos by email .....	156
Sending a photo or video by MMS .....	156
Sending photos or videos using Bluetooth .....	156
Sharing photos on Facebook .....	157
Sharing photos on Flickr .....	157
Sharing photos on Picasa .....	157
Sharing videos on YouTube .....	157

## Music

<b>About the Music application</b> .....	<b>158</b>
<b>Playing music</b> .....	<b>158</b>
<b>Browsing music in the Library</b> .....	<b>159</b>
<b>Creating a playlist</b> .....	<b>160</b>
Playing the songs in a playlist .....	160
Managing playlists .....	160
<b>Setting a song as ringtone</b> .....	<b>162</b>
Checking if the song was added as a ringtone .....	162
<b>Sending music using Bluetooth</b> .....	<b>162</b>
<b>About the Music widget</b> .....	<b>162</b>

## Maps and location

<b>Using Google Maps</b> .....	<b>163</b>
Viewing locations .....	163
Viewing map layers .....	165
Searching for a location .....	166
Getting directions .....	167
Finding your friends with Google Latitude (available by country) .....	168
<b>Using HTC Footprints</b> .....	<b>171</b>
Creating a footprint .....	171
Revisiting a footprint .....	171
Editing or deleting a footprint .....	172
Exporting your footprints .....	172
Importing footprints .....	173
Adding the Footprints widget .....	173

## More apps

<b>Watching videos on YouTube</b> .....	<b>174</b>
Watching videos .....	174
Searching for videos .....	174
Sharing a video link .....	175
Capturing a video and sharing it on YouTube .....	175
<b>Viewing a PDF</b> .....	<b>176</b>
<b>Viewing documents, presentations, and spreadsheets</b> .....	<b>177</b>
<b>Keeping track of your stocks</b> .....	<b>178</b>
Adding a stock quote or stock market index .....	178
Changing the stock list order .....	178

Deleting stock quotes and indices.....	178
Setting stock information update frequency.....	179
Manually updating stock information.....	179
Adding the Stocks widget.....	179
<b>Listening to the radio.....</b>	<b>180</b>
Listening to an FM station.....	180
Adding station names.....	181
Minimizing or turning off FM Radio.....	181
<b>Recording your voice.....</b>	<b>182</b>
Recording your voice.....	182
Sharing a voice clip.....	182
Setting a voice clip as a ringtone.....	182
Renaming a voice clip.....	182
<b>Using Voice Search.....</b>	<b>183</b>
Opening Voice Search.....	183
<b>Navigator.....</b>	<b>184</b>
Opening Navigator.....	184
<b>Finding and installing apps from Android Market.....</b>	<b>185</b>
Finding and installing an application.....	185
Creating a Google Checkout account.....	186
Requesting a refund for an application.....	186
Opening an installed application.....	187
Uninstalling an application.....	187
Getting help.....	187

## Security

Protecting your phone with a screen lock.....	188
---	-----

## Settings

Settings on your phone.....	189
Changing display settings.....	191
Adjusting the screen brightness manually.....	191
Adjusting the time before the screen turns off.....	191
Preventing automatic screen rotation.....	191
Recalibrating the G-sensor.....	191
Switching animation effects on or off.....	192
Keeping the screen on while charging the phone.....	192
Changing sound settings.....	193
Changing the phone language.....	194
Optimizing your phone's battery life.....	195
Checking the power usage of applications.....	195
Managing memory.....	196
Checking how much phone memory is available for use.....	196
Checking the available storage card space.....	196
Clearing application cache and data.....	196
Uninstalling third-party applications.....	196
Freeing up more phone memory or storage card space.....	196
Checking information about your phone.....	197

## Backup, update and reset

Backing up your contacts .....	198
Setting up Backup Assistant.....	198
Changing the backup schedule.....	198
Manually backing up your contacts .....	198
Updating your phone's system software.....	199
Checking for phone system software updates manually.....	199
Performing a hard/factory reset.....	200

## Specifications

## Index

# Basics

## Inside the box

---

You will find the following inside the box:

- Phone
- USB cable
- Battery
- AC adapter
- Quick start guide
- Product safety and warranty brochure

## Your Phone

---

### Front panel

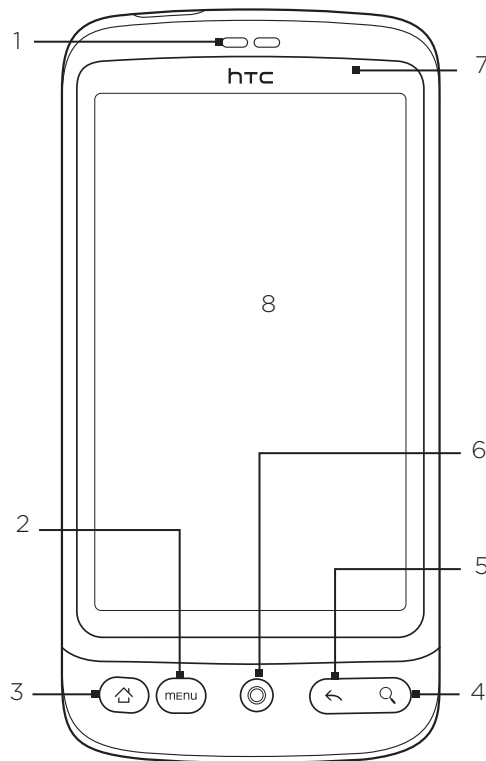

---

#### 1 Earpiece

Listen to a phone call from here.

---

#### 2 MENU

Press to open a list of actions that you can do on the current screen.

---

---

### 3 HOME

- While on any application or screen, press to return to the Home screen.
- While on the main Home screen, press to show a snapshot of the Home screen.
- Press and hold to open the recently-used applications window.

---

### 4 SEARCH

Press to open the Quick Search box.

See “Searching your phone and the Web” in this chapter for more details.

---

### 5 BACK

Press to go back to the previous screen, or to close a dialog box, options menu, the Notifications panel, or onscreen keyboard.

---

### 6 Optical trackball

Swipe your finger over or press to highlight or select items onscreen.

---

### 7 Notification LED

This LED shows a:

- Solid green light when the phone is connected to the power adapter or a computer and the battery is fully charged.
- Flashing green light when you have a pending notification.
- Solid red light when the battery is being charged.
- Flashing red light when the battery level reaches very low.

---

### 8 Touch screen

---

## Back panel

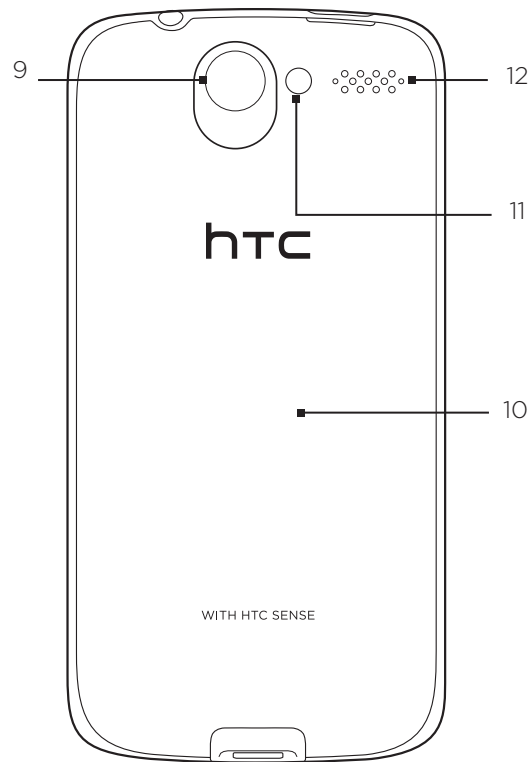

---

9 5 megapixel camera

---

10 Back cover

---

11 LED flashlight

---

12 Speaker

---

## Top panel

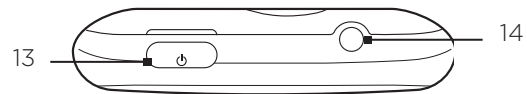

---

### 13 POWER

- When the phone is off, press to turn on the phone.
- When the phone is on and the screen is unlocked, press to turn off or on the phone display.
- With the screen unlocked, press and hold to open the phone options menu that lets you turn off the phone, switch your phone to silent mode, vibration mode, or airplane mode, and turn on/off the data connection.

---

### 14 3.5mm audio jack

Connect a 3.5mm stereo headset for hands-free conversation or for listening to music.

---

## Left panel

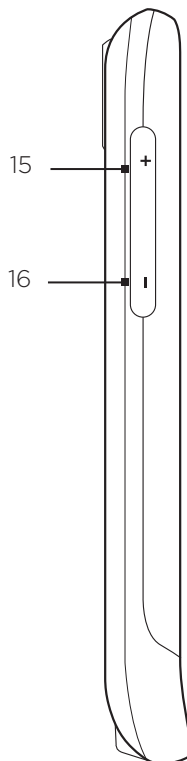

---

### 15 VOLUME UP

- While on a call, press to increase earpiece volume.
- While not on a call, press to increase the ringer volume.
- While watching videos or listening to the FM radio, press to increase the volume.

---

### 16 VOLUME DOWN

- While on a call, press to decrease earpiece volume.
  - While not on a call, press to decrease the ringer volume.
  - While watching videos or listening to the FM radio, press to decrease the volume.
-



## Bottom panel

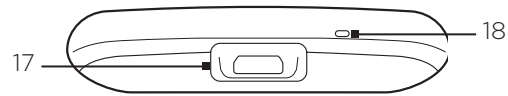

---

### 17 USB connector

- Connect the power adapter to charge the battery.
- Connect the supplied USB cable to transfer files to your phone from your computer or sync your phone with HTC Sync on your computer.

---

### 18 Microphone

---

# Before turning on your phone

---

## Back cover

### Removing the back cover

Remove the back cover to access the battery compartment, SIM card slot, and storage card slot.

1. With the phone turned off, hold your phone securely with the front facing down.
2. With your thumb or finger, lift up the top of the back cover from the small opening near the POWER button.

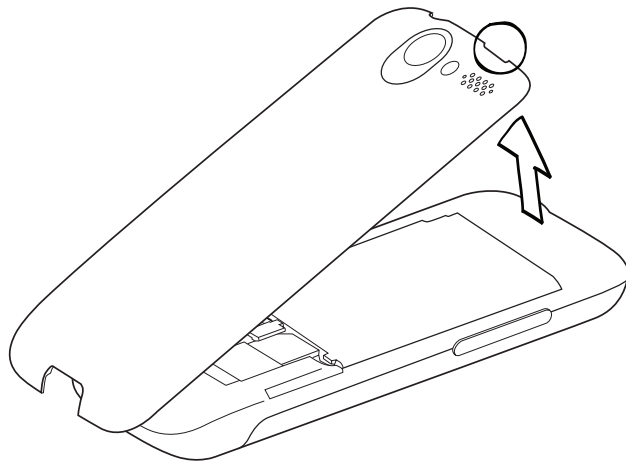

### Replacing the back cover

1. Secure and press the bottom part of the back cover first by aligning into the two openings located at the bottom part of the back of the phone.

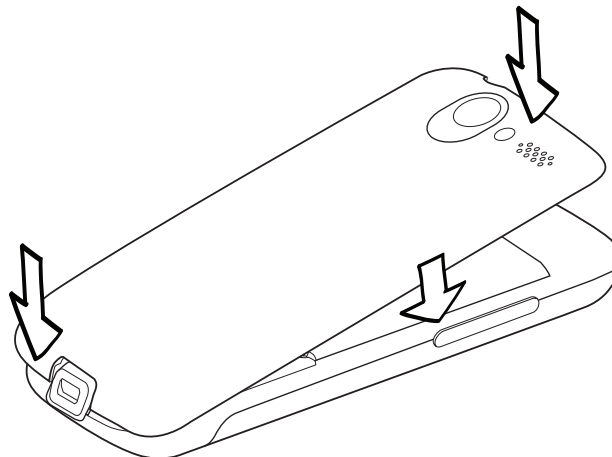

2. Press the sides and the top part of the back cover down to lock the cover into place. You will hear a click when the back cover is locked in place.

## SIM card

The SIM card contains your phone number, service details, and phonebook/message memory. Your phone supports both 1.8V and 3 V SIM cards.



Some legacy SIM cards may not function with your phone. You should consult with your mobile operator for a replacement SIM card. There may be fees for this service.

### Inserting the SIM card

1. Remove the back cover. Refer to “Removing the back cover.”
2. If the battery is installed, remove the battery. Refer to “Removing the battery.”
3. Insert the SIM card with its gold contacts facing down and its cut-off corner facing out.

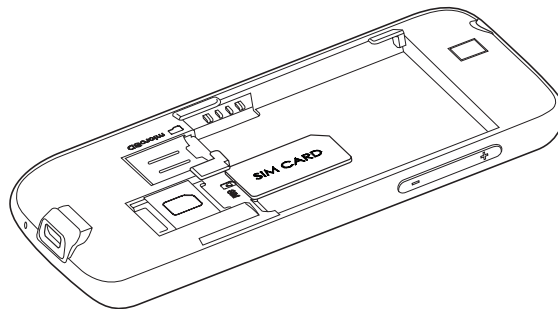

4. Push the SIM card all the way in.

### Removing the SIM card

1. Remove the back cover. Refer to “Removing the back cover.”
2. If the battery is installed, remove the battery. Refer to “Removing the battery.”
3. Push the SIM card out from the back of the slot, and then slide the SIM card out.

## Storage card

Store your pictures, music, and applications in the microSD card that is pre-installed on your phone.

### Inserting the storage card

1. Remove the back cover. Refer to “Removing the back cover.”
2. If the battery is installed, remove the battery. Refer to “Removing the battery.”
3. Insert the microSD card into the slot with its gold contacts facing down and push it in until it clicks into place.

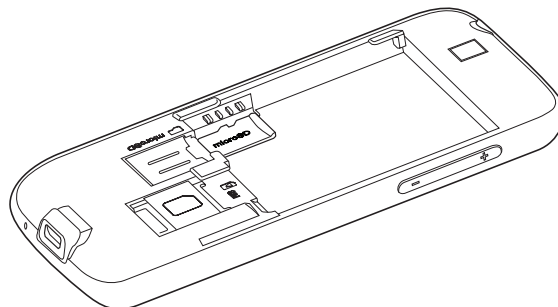

### Removing the storage card

1. Remove the back cover. Refer to “Removing the back cover.”
2. If the battery is installed, remove the battery. Refer to “Removing the battery.”
3. Push the storage card in to eject it from its slot.

### Removing the storage card while the phone is on

When you need to remove the storage card while the phone is on, unmount the storage card first to prevent corrupting or damaging the files in the storage card.

1. Press HOME > MENU, and then tap **Settings**.
2. Scroll down the screen, and then tap **SD card & phone storage**.
3. Tap **Unmount SD card**.
4. Remove the storage card by following the instructions in “Removing the storage card.”

## Battery

Your phone comes with a rechargeable Lithium-ion polymer or Lithium-ion battery and is designed to use only manufacturer-specified original batteries and accessories. Battery performance depends on many factors, including network configuration, signal strength, the temperature of the environment in which you operate your phone, the features and/or settings you select and use, items attached to connecting ports, and your voice, data, and other program usage patterns.

### Inserting the battery

1. Remove the back cover. Refer to “Removing the back cover.”
2. Insert the contacts side of the battery first and then gently push the battery into place..

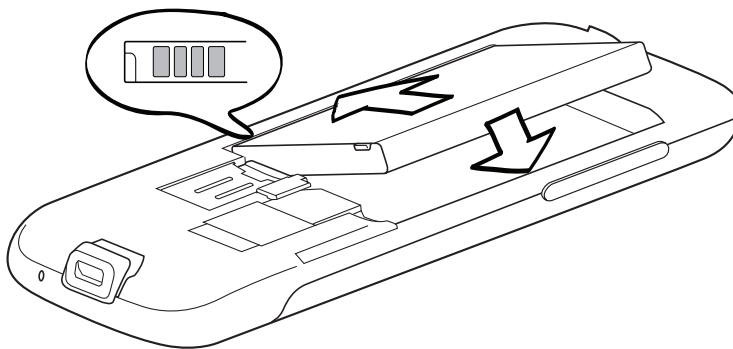

## Removing the battery

1. Remove the back cover. Refer to “Removing the back cover.”
2. Lift out the battery from the notch near the SIM card slot.

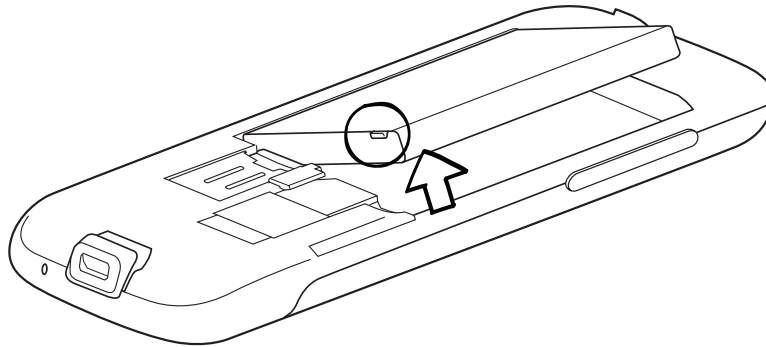

## Charging the battery

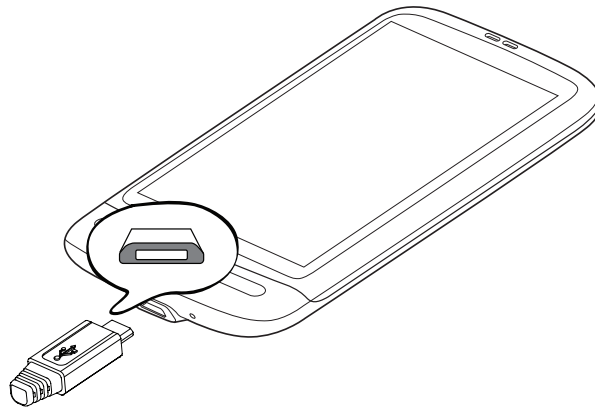

The battery is partially charged when shipped. Before you turn on and start using your phone, it is recommended that you charge the battery. Some batteries perform best after several full charge/discharge cycles.

1. Attach the power plug to the AC adapter.
2. Connect one end of the USB cable to the sync connector on your phone.



3. Connect the other end of the USB cable to the USB port of the AC adapter.
4. Plug in the AC adapter to an electrical outlet to start charging the battery.

As the battery is being charged, the notification LED shows a solid red light when the battery is being charged. The light turns to solid green when the phone is fully charged.

When you charge the battery while the phone is on, the charging battery icon (  ) is displayed in the status bar of the Home screen. After the battery has been fully charged, a full battery icon (  ) will be displayed in the status bar of the Home screen.



- Only the AC adapter and USB sync cable provided with your phone must be used to charge the battery.
- Do not remove the battery from the phone while you are charging it using the AC or car adapter.
- As a safety precaution, the battery stops charging when it overheats.

## Finger gestures

### Tap

When you want to type using the keyboard, select items onscreen such as application and settings icons, or press onscreen buttons, simply tap them with your finger.

### Press and hold

To open the available options for an item (e.g. contact or link in a web page), simply press and hold the item.

### Swipe or slide

To swipe or slide means to quickly drag your finger vertically or horizontally across the screen or optical joystick.

### Drag

Press and hold your finger with some pressure before you start to drag. While dragging, do not release your finger until you have reached the target position.

### Flick

Flicking the screen is similar to swiping, except that you need to swipe your finger in light, quicker strokes. This finger gesture is always in a vertical direction, such as when flicking the contacts or message list.

### Rotate

For most screens, you can automatically change the screen orientation from portrait to landscape by turning the phone sideways. When entering text, you can turn the phone sideways to bring up a bigger keyboard. Refer to the Settings chapter for more details.

### Pinch

For some applications, like Photos or the web browser, you can “pinch” the screen using 2 fingers (for example, thumb and index fingers) to zoom in or zoom out when viewing a picture or a web page.

## Getting started

---

Once you've installed your battery, you can turn on your phone and start using it.

### Turning on your phone

Press the POWER button.



When you turn on the phone for the first time, you will be prompted to set up your phone. For more information on how to set up your phone for the first time, see "Setting up your phone for the first time."

### Turning off your phone

If you do not need to use your phone, you can turn the power off to save battery life.

1. If the display is off, press the POWER button to turn the display back on.
2. Unlock your phone if the Lock screen is displayed. See "Unlocking the screen" in this chapter for details.
3. Press and hold the POWER button for a few seconds.
4. When the Phone options options menu appears, tap **Power off**.
5. Tap **OK** when prompted to turn off the phone.

### Setting up your phone for the first time

When you turn on your phone for the first time, your phone displays tutorials and guides you to set up your email accounts and favorite social networks such as Facebook®, YouTube™, and Twitter™. You can follow the onscreen instructions to complete the setup, or skip the setup and do it at another time.

1. Choose the phone language you want to use, and then tap **Next**.
2. Your phone walks you through a tutorial on how to use the onscreen keyboard. Follow through the tutorial to learn how to use the onscreen keyboard. Tap **Skip** to not go through the tutorial.
3. On the Internet connection screen, select how you want to connect to the Internet, and then tap **Next**.
4. If there are Wi-Fi networks in range, you will be asked if you want to connect to a Wi-Fi network. Tap **Next** and then tap the wireless network that you want, or clear the **Connect to Wi-Fi network** checkbox, and then tap **Next** to set up your Wi-Fi connection at a later time.
5. Some phone features such as Weather and Footprints require Google's location service to automatically determine your current location. On the Location consent screen, you can choose whether to allow Google's location service to collect information about your location. Clear or select the checkbox, and then tap **Next**.



This service may incur additional data transfer fees from your provider. You can enable or disable this service later in your phone's location settings.

6. On the Set up accounts screen, choose the type of account you want to set up and follow the onscreen instructions to complete the setup. Tap **Skip** to set up accounts at a later time.
  - To set up Backup Assistant, tap **Backup Assistant** and follow the instructions on the screen to sign in.
  - To set up your Google Account, tap **Google account > Next > Sign in**, enter your Google Account details, and then tap **Sign in**.
  - To learn how to set up POP3 and Microsoft Exchange ActiveSync accounts, see the Sync and Email chapters to learn how to set up these accounts.

After setting up an account, you will be taken back to the Set up accounts screen so you can set up more accounts. When you are done setting up your accounts, tap **Next**.

7. On the Set up social networks screen, choose the type of social network account such as Facebook (for HTC Sense) and Twitter that you want to access from your phone. Follow the onscreen instructions to log in to your social network account. Tap **Skip** to set up social network accounts at a later time. See the Social chapter for more information about Facebook for HTC Sense.

When you are done setting up your accounts, tap **Next** on the Set up social networks screen.

## Sleep mode

Sleep mode suspends your phone to a low power state while the display is off in order to save battery power. You will still be able to receive messages and calls while the phone is in Sleep mode.



For information on how to adjust the time before the screen turns off, see “Adjusting the time before the screen turns off” in the Settings chapter.

### Switching to Sleep mode

Briefly press the POWER button to turn off the display temporarily and switch your phone to Sleep mode. Your phone also automatically goes into Sleep mode when you leave the phone idle after a certain period of time. Switching to Sleep mode also prevents accidental button or touch screen presses when the phone is in your bag or pocket.

### Waking up from Sleep mode

Your phone wakes up automatically when you have an incoming call. To wake up your phone manually, press the POWER button. You will then see that the phone has locked the screen. To find out how to unlock the screen, see “Unlocking the screen.”



## Unlocking the screen

Press the bar on the lock screen and then slide your finger down to unlock the screen or to answer an incoming call.

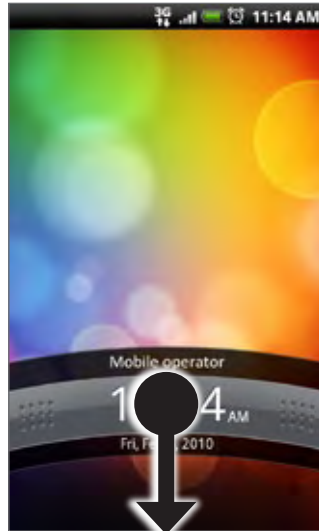

You can also press MENU while on the lock screen to unlock the screen.



If you have set up a screen unlock pattern, you will be prompted to draw the pattern on the screen before it unlocks. For more information on how to create and enable the screen unlock pattern, see “Protecting your phone with a screen lock” in the Security chapter.

## Home screen

The Home screen provides you with a weather clock that shows the time and weather of your current location. Tap the respective item to open the associated application.

The Home screen also lets you add the items you want and need on the Home screen. Add items like application icons, shortcuts, folders, and widgets to give you instant access to information and applications. To learn how to personalize your Home screen, see the Personalizing chapter.

## Extended Home screen

The Home screen extends beyond the screen width to provide more space for adding icons, widgets, and more. There are 6 “additional” screens apart from the main Home screen.



You cannot add more screens.

## Navigating the Home screen

You can go to the extended Home screen by sliding your finger horizontally across the screen to go to the left or right side of the Home screen. While on an extended Home screen, press HOME to return to the main Home screen.

### Directly going to a particular screen using Leap view

1. On any Home screen, pinch the screen to show the Leap view that shows the screens as thumbnails.



On the main Home screen, you can press HOME to show the Leap view.

2. Tap the screen you want to open.

























# Phone status and notifications

---

## Phone status icons

These are the icons that may appear on the phone status area of the status bar:



	EVDO available
	1xRTT available
	EVDO in use
	1xRTT in use
	Connected to a Wi-Fi network
	Bluetooth is on
	Connected to a Bluetooth device
	Airplane mode
	Alarm is set
	Speakerphone on
	Data synchronizing
	Signal strength
	Roaming
	No signal
	Vibrate mode
	Location setting on
	Location setting off
	Phone speaker is mute
	Phone microphone is mute
	Battery is very low (10% remaining)
	Battery is low (20% remaining)
	Battery is full
	Battery is charging
	Wired microphone headset connected

---















 Wired headset connected

---

## Notification icons

These are the icons that may appear on the notifications area of the status bar:



	New Gmail/Google Mail message
	New Microsoft Exchange ActiveSync or POP3/IMAP email
	New SMS/MMS
	Problem with SMS/MMS delivery
	New Google Talk instant message
	New voicemail
	Upcoming event
	Song is playing
	General notification (for example, Phone connected to computer via USB cable.)
	Storage card is low on free space
	Wi-Fi is on and wireless networks are available
	Data synchronizing or connected to HTC Sync
	New tweet
	FM Radio application in use
	More (not displayed) notifications
	Call in progress
	Missed call
	Call on hold
	Call forwarding on
	Compass needs orientation
	Uploading data (animated)
	Downloading data (animated)
	Waiting to upload
	Downloaded Android Market application installed successfully
	Update available for an application downloaded from Android Market



Storage card is safe to remove or storage card is being prepared



No storage card installed on the phone

## Checking notifications

Notification icons on the status bar report the arrival of new messages, calendar events, alarms set and ongoing settings such as when call forwarding is on or the current call status. You can open the Notifications panel to open the message, reminder, or event notification and see the mobile operator name.

### Opening the Notifications panel

When a new notification icon displays in the status bar, press and hold the status bar, then slide your finger downward to open the Notifications panel.



If you have several notifications, you can scroll down the screen to view more notifications.



You can also open the Notifications panel on the Home screen by pressing MENU and then tapping Notifications.

### Closing the Notifications panel

Do one of the following:



- Press and hold the bottom bar of the Notifications panel, then slide your finger up the screen.
- Press BACK.

# Adjusting the volume

---

Adjusting the ringer volume changes the volume level of the phone ringtone, whereas adjusting the media volume changes the volume level of sound notifications, music or video playback. The ringer volume and media volume can be separately adjusted.

## Adjusting the ringer volume

1. Press the VOLUME UP or VOLUME DOWN buttons on the left panel of the phone to adjust the ringer volume to your desired level. The Ringer volume window appears on the screen to display the volume levels. While in the lowest ringer volume level (Silent mode), press VOLUME DOWN once to set your phone to Vibrate mode. The phone vibrates and the vibrate mode icon (  ) appears on the status bar.
2. While in Vibrate mode, press VOLUME UP once to switch to silent mode. The speaker mute icon (  ) displays on the status bar.



To quickly switch your phone to silent mode, press and hold the POWER button, and then tap **Silent mode** on the options menu.

## Adjusting the media volume

When playing music or watching video, press the VOLUME UP or VOLUME DOWN buttons on the left panel of the phone to adjust the media volume. The Music/video volume window appears on the screen to display the volume level.

You can also adjust the media volume on the Settings screen.

1. Press HOME > MENU, and then tap **Settings > Sound & display > Media volume**.
2. When the Media volume window appears, drag the slider to the left to lower the volume or to the right to increase the volume.
3. Tap OK to close the window.

## Connecting your phone to a computer

---

Whenever you connect your phone to a computer using the USB cable, the Connect to PC dialog box displays and prompts you to choose the type of USB connection. Select one of the following choices, and then tap **Done**:

### Charge only

Select this mode if you only want to charge the phone's battery using your computer.

### HTC Sync

When selected, the phone automatically uses HTC Sync when connected to your computer and lets you synchronize Outlook and Windows Address Book (Outlook Express), contacts and calendar events between your computer and your phone. For more information, see "Using HTC Sync" in the Accounts and sync chapter.

### Disk drive

This mode is available only when you have installed a microSD card on your phone. Select this mode when you want to use your storage card as a USB thumb drive, and copy files between your phone's storage card and your computer.

When Disk Drive mode is enabled while your phone is connected to the computer, you will not be able to run applications that use the storage card, such as Music or Photos. For more information, see "Copying files to and from the storage card" in this chapter.

### Mobile Broadband Connect

When you do not have Internet connection on your computer, you can select this mode to share your phone's mobile data connection with your computer. For more information, see "Using Your Phone as a Modem" in the Internet chapter.



If you do not want to show the Connect to PC dialog box everytime you connect the phone to the computer, select the **Don't ask me again** checkbox in the Connect to PC dialog box. The default connection type will be used when you connect the phone to the computer.

To check or change the default connection type and to show or hide the Connect to PC dialog box, press HOME > MENU, and then tap **Settings > Connect to PC**.

## Copying files to and from the storage card

---

1. Connect the phone to your computer using the supplied USB cable.
2. When the Connect to PC dialog box appears, tap **Disk drive**, and then tap **Done**.
3. On your computer, the connected phone is recognized as a removable disk. Navigate to this removable disk and open it.
4. Do one of the following:
  - Copy the files from the computer to the phone's storage card's root folder.
  - Copy the files from the phone's storage card to a folder in your computer or computer desktop.
5. After copying the files, unmount the removable disk (that is, the connected phone) as required by your computer's operating system to safely remove your phone.
6. Do one of the following:
  - Disconnect the phone from the computer.
  - If you want to keep the phone connected to the computer but want the phone to be able to access the storage card, open the Notifications panel, tap **Disk drive**, select an option except **Disk drive**, and then tap **Done**. See "Opening the Notifications panel" in this chapter to learn how to open the Notifications panel.



## Searching your phone and the Web

---

You can search for information on your phone and on the Web by using the **Quick Search Box**. Some applications, such as People or Mail, have their own search box, which you can use to search within those applications (the application's icon is at the left of the search box.)

### Setting Web and Quick Search Box options

1. Press HOME > MENU, and then tap **Settings**.
2. Scroll down the screen, and then tap **Search**.
3. Tap Google search settings, and then do the following:
  - Select **Show web suggestions** if you want to include suggestions from Google when doing a search.
  - Select **Search history** to enable personalized search history. You need to sign in to your Google Account to use this feature. The **Show web suggestion** check box needs to be selected for this option to be enabled.

Press BACK when you are done.

4. Tap **Searchable items**, and then select the items you want included when doing a search.

### Searching the Web and your phone using the Quick Search Box

1. Press HOME > SEARCH.



If you are in an application such as Mail, press the SEARCH button to toggle between doing a search in the application only and searching your phone and the Web.

2. Enter the search item in the Quick Search Box. As you type, matching items on your phone and suggestions from Google web search are shown as a list.



The suggested items that appear will depend on the options that you have selected in the search settings. See "Setting Web and Quick Search Box options" for details.

3. Do one of the following:
  - If what you're searching for is in the list of suggestions, tap it in the list. The item opens in the appropriate application.
  - If what you're searching for is not in the list, tap  to search the Web. The web browser opens, displaying results of a Google search on the Web.

# Personalizing

## Making your phone truly yours

---

Make your phone look and sound just the way you want it. Personalize your phone with a different wallpaper, ringtone, and notification sound for events such as incoming text, email, calendar reminders, and more.

Your phone's Home screen is highly customizable and extends beyond the screen width, giving you plenty of space to add the information that matters most in your daily life and phone features that make communication quicker and easier. You have up to seven screens that extend to the left and right sides of your display as your Home screen, on which you can add elements such as widgets, program icons, shortcuts to information, and more.



To find out how to set notification sounds for events, see “Changing sound settings”.

## Changing the ringtone

---

Choose from the available selections of ringtones on your phone.

1. Press HOME > MENU, and then tap **Settings**.
2. Tap **Personalize > Default ringtone**. The Phone ringtone selection menu then opens.
3. Scroll through the available ringtones and tap the ringtone you want to use. The ringtone briefly plays when selected.
4. Tap OK.

You can also download or copy ringtones or songs to your phone's storage card. To find out how you can copy files to your storage card, see “Copying files to and from the storage card”.

Ringtones or songs downloaded or copied to your storage card are not automatically added to the ringtone selection menu. You need to go to the Music application and set a ringtone or song in your storage card as your ringtone. To find out how to set a ringtone using the Music application, see “Setting a song as ringtone” in the Music chapter.



See “Specifications” for a list of audio file formats supported by your phone.

## Personalizing your phone with scenes

Your phone becomes multiple phones in one when you use scenes. Scenes are personalized Home screen layouts that you can quickly apply to your phone. By switching between scenes, you instantly turn your phone into your perfect weekend phone, travel phone, work phone, or pure play phone.

### Using a preset scene

Your phone features preset scenes, each preconfigured with a different wallpaper and collection of widgets that reflect different moments in your life. You can choose a scene that is suitable for work, play, travel, or your social life.

1. Press HOME > MENU, and then tap **Scenes**.
2. In the Choose a scene menu, select a preset scene and then tap **Done**.



HTC (default)



Work



Play

### Customizing and saving a scene

After selecting a preset scene, you can add widgets and other elements, arrange the layout, change the wallpaper, and save the whole Home screen as your personalized scene.

1. Press HOME > MENU, and then tap **Scenes**.
2. In the Choose a scene menu, select a preset scene that already has some widgets, or select **Clean Slate** if you want to design your own Home screen.
3. Add widgets and other elements that you want.
4. Arrange the layout of your Home screen according to your preference.
5. Change the Home screen wallpaper. You can also change the lock screen wallpaper.
6. When you are done designing your Home screen, press HOME > MENU and then tap **Scenes** again.
7. Under **My scenes**, make sure the **Current (unsaved)** option is selected and then tap **Save**.
8. Enter a new scene name for your Home screen and then tap **Done**. Or, if you already created a scene, enter the same scene name, tap **Done** and then tap **Replace**.

## Renaming or deleting a scene

You can rename or delete a personalized scene that you created. Preset scenes cannot be renamed or deleted.

1. Press HOME > MENU and then tap **Settings > Personalize > Scenes**.
2. Under **My scenes**, press and hold a scene and choose whether to rename or delete it.

## Changing your wallpaper

---

Personalizing your Home screen wallpaper with your favorite photo is a quick and easy way to change the feel of your phone and give it a fresh look. Browse the collection of wallpapers included in your phone or choose from photos that you have taken with the camera. You can also change your Home screen to use an animated wallpaper.

The wallpaper that you choose for the Home screen will also be used as the lock screen wallpaper.

1. Press HOME > MENU, and then tap **Wallpaper**.
2. Do one of the following:
  - Tap **Live wallpapers** to choose from preset animated wallpapers.
  - Tap **My photos** to select a photo that you have taken using the camera or copied to your storage card. Crop the photo and then tap **Save**.
  - Choose from preset wallpapers.
3. After changing the wallpaper, remember to save it to the scene that you created or save it as a new scene. To find out how to save a scene, see “Customizing and saving a scene”.

## Personalizing your Home screen with widgets

Widgets put at-a-glance important information and media content up front on your Home screen. Some widgets are already added to your Home screen for your convenience. You can add more from the available selections of widgets, or download more widgets.

### Adding a widget to your Home screen

A wide selection of widgets is available for you to choose from, such as Calendar, Music, Photo Album, Friend Stream, Twitter, and more.

1. Press HOME. Go to the part of the Home screen where there's space to add a new widget. To find out how, see "Navigating the Home screen" in the Basics chapter.
2. Tap  or press and hold on the Home screen to open the Add to Home options menu.
3. Tap **Widget** and then select a widget that you want.
4. Most HTC widgets are available in a variety of designs and sizes to suit your needs. Tap the right or left arrow button at the bottom of the screen to view the different styles, and then tap **Select** to choose one.



You can also add widgets that allow you to quickly switch on or off certain settings of your phone, such as Wi-Fi, Mobile Network, Bluetooth, and more. Scroll down the widgets list, tap **Settings**, and then tap the widget that you want.

### Downloading HTC widgets

A selection of fun and useful HTC widgets are also available for download.

1. Press HOME. Go to the part of the Home screen where there's space to add a new widget. To find out how, see "Navigating the Home screen" in the Basics chapter.
2. Tap  or press and hold on the Home screen to open the Add to Home options menu.
3. Tap **Widget** and then tap **Get more HTC widgets**.
4. Tap to select a widget.
5. Tap **Details** to see a short description about the widget. After reading, press BACK.
6. When you're ready to download and add the widget to your Home screen, tap **Download**.

## Adding application icons and other shortcuts on your Home screen

---

Place application icons on your Home screen to open applications quicker. You can also add shortcuts to settings and specific information such as a bookmarked webpage, someone's phone number, a music playlist, route directions, and many other items, to your Home screen.



The shortcuts available depend on the applications that are installed on your phone.

1. Press HOME. Go to the part of the Home screen where there's space to add a new shortcut. To find out how, see "Navigating the Home screen" in the Basics chapter.
2. Tap  or press and hold on the Home screen to open the Add to Home options menu.
3. Do one of the following:
  - To add an application icon, tap **Program** and then select an application.
  - To add a shortcut to a setting or information, tap **Shortcut** and then select the type of information or setting.

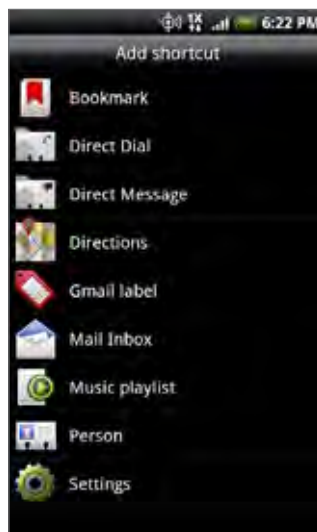

To add an application icon on the Home screen, you can also press HOME, tap , and then press and hold an application icon. Without lifting your finger, drag the icon to an empty area on the Home screen, and then release it.

## Adding folders on your Home screen

Use folders to group related applications and other shortcuts to keep your Home screen tidy and organized.



You can also add information folders that show up-to-date information such as Bluetooth received files, your Facebook phonebook, and more.

### Creating a new folder and adding items to it

1. Press HOME. Go to the part of the Home screen where there's space to add a new folder. To find out how, see "Navigating the Home screen" in the Basics chapter.
2. Tap  or press and hold on the Home screen to open the Add to Home options menu.
3. Tap Folder and then tap New Folder.
4. Press and hold an application icon or a shortcut that you want to move to the folder. The phone then vibrates. Don't lift your finger.
5. Drag the application icon or shortcut and drop it on top of the folder.



Simply tap the folder to open it so you can access the applications and shortcuts inside the folder.

### Renaming a folder

1. Tap the folder to open it.
2. Press and hold the folder window's title bar.
3. Enter a new folder name and then tap OK.



## Rearranging or removing widgets and icons on your Home screen

---

Rearrange the widgets and icons on your Home screen to give room for adding more items to the Home screen. You can also remove widgets and icons that you don't frequently use.

### Moving a widget or icon

1. Press and hold the widget or icon you want to move.

The phone vibrates and you'll see a green box around the widget or icon. Don't release your finger.

2. Drag the widget or icon to a new location on the screen.

Pause at the left or right edge of the screen to drag the widget or icon onto another Home screen panel.

3. When the widget or icon is where you want it, release your finger.

If you've released your finger but a message shows that there's no space to place the widget or icon, drag it right or left again to another Home screen panel.

### Removing a widget or icon

1. Press and hold the widget or icon you want to remove.

The phone vibrates and you'll see a green box around the widget or icon. Don't release your finger.

2. Drag the widget or icon to the **Phone** button. The **Phone** button then changes into the **Remove** button and turns red.

3. When the widget or icon also turns red, release your finger.

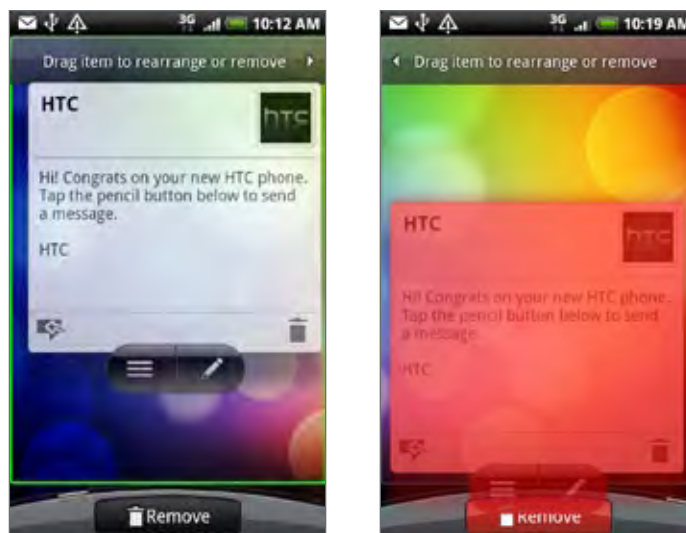

# Phone calls





## Making calls

---

There are several convenient methods to make a call from your phone.

### Calling somebody using your phone

You can either dial a number directly, or you can use the Smart Dial (see Smart Dial) feature to search and call a contact in your contacts list or a number from call history.

1. Press HOME, and then tap **Phone**.
2. Begin entering the first few digits or characters by tapping the keys on the phone keypad. As you enter digits or letters, the panel displays numbers and names that match the keys you tapped.  
  
If you enter a wrong digit, tap  to erase that digit. To erase the entire number, press and hold .
3. Tap  to close the phone keypad and to see if there are more matching numbers or contacts. To browse through the filtered list, flick through the list or slide your finger up or down the list slowly.
4. To place a call, do one of the following:
  - If there are no matching contacts in the list, after entering the number, tap **Call**.
  - Tap the phone number or contact from the list.
  - To call a different phone number associated with the contact, tap  at the right side of the contact name. On the contact details screen, tap the number you want to call.

### Smart Dial

The phone dialer's Smart Dial feature makes it quick and easy for you to place a call. Simply enter the phone number or first few letters of the person you want to call. Smart Dial automatically searches and filters your contacts list stored on your phone, and the phone numbers from the call history.

### Calling a speed dial number

1. Press HOME, and then tap **Phone**.
2. On the phone keypad, press and hold the number that is associated with the contact you want to call.

The number 1 on the phone keypad is generally reserved for your voicemail. Press and hold this button to call voicemail and retrieve your voicemail messages.

### Adding a contact to speed dial

1. Press HOME, and then tap **Phone**.
2. Press MENU, and then tap **Speed dial > Add new**.
3. Enter the name of the contact you want to add. When the name comes up in the list, tap the name.
4. On the Speed dial screen, select the phone number of the contact to use, and the phone keypad assignment. Tap **Save**.

## Calling using Voice Dialer

1. Press HOME, and then tap  > Voice Dialer.
2. When the Voice Dialer message box appears and you see “Listening” on the screen, say “Call [name of person]” in a clear voice into the phone.



The person you want to call should be in your People list.

3. A confirmation message will pop up asking if the person to call is correct. Tap **OK** if the person is correct or tap **Cancel** to try again.



- If the contact has more than one number, or if the Voice Dialer does not detect your voice accurately, the confirmation message displays a list of the contact’s phone numbers or suggested results.
- You can also use voice Dialer to open programs.

## Calling a phone number in a text message

1. Press HOME, tap **Messages**, and then tap the message with the phone number.
2. In the message thread, tap the message with the phone number.
3. On the **Select link** screen, tap the number you want to call.
4. Edit the phone number if needed, and then tap **Call**.



To call the message sender, in the All messages list, press and hold the message, and then tap **Call** on the options menu.

For more information about text messages, see the Messages chapter.

## Calling a phone number in an email

1. Press HOME, and then tap **Mail**.
2. Open the email account where the email with the number is located.
3. In the email account’s inbox, tap the email to open it.
4. In the email body, tap the phone number. The phone dialer screen opens with the phone number already entered.

The phone will recognize a number as a phone number if the number has a minimum of 5 digits and have at least one of the following:

- Numbers preceded by a “+” in front. For example, +1-987-654-321 or +1987654321.
- Numbers enclosed in parenthesis in front. For example, (02)987654321 or (02)987-654-321.
- Numbers separated by dashes. For example, (02)-987-654-321 or 0987-654-321.

5. Tap **Call**.

For more information about email, see the Email chapter.

## Making an emergency call

On the phone dialer screen, dial the international emergency number for your locale (for example, 000), and then tap **Call**.

## Using Assisted Dialing

Assisted Dialing allows you to easily dial international calls while roaming in another country.

### Turning Assisted Dialing on

1. Press HOME > MENU, and then tap **Settings > Call > Assisted Dialing**.
2. Select the **Enable Assisted Dialing** check box.
3. Under Reference Country, select the country that you want to call.

### Editing a country's international call settings

1. Press HOME > MENU, and then tap **Settings > Call > Assisted Dialing**.
2. Under Reference Country, select the country whose settings you want to edit.
3. Press MENU and then tap Edit.
4. Edit the Country Code, IDD Prefix (International Direct Dial), NDD Prefix (National Direct Dial), Area/City Code and National Number Length (length of phone number).
5. Tap **Save**.

To reset the Reference Country to the default

1. Press HOME > MENU, and then tap **Settings > Call > Assisted Dialing**.
2. Under Reference Country, select the country whose settings you want to set to default values.
3. Press MENU and then tap **Set Default**.

## Receiving calls

When you receive a phone call from a contact, the Incoming call screen appears and displays the caller ID icon, name, and phone number of the calling party. When you receive a phone call from someone who is not stored in People, only the default caller ID icon and phone number appear on the Incoming call screen.

### Answering an incoming call

Depending if the display is on or off, you need to:

- If the display is on, tap **Answer**.
- If the display is off, the display will turn on showing the Lock screen. Drag the bar down to answer the call.

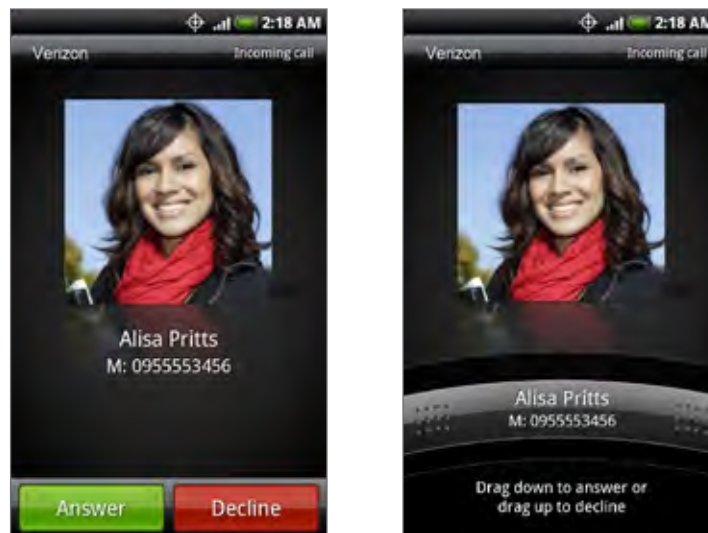

### Muting the ringing sound without rejecting the call

Do one of the following:

- Press the VOLUME DOWN button.
- Place the phone face down on a leveled surface.



If the phone is already facing down, the phone will still ring when there are subsequent incoming calls.

### Automatically scaling down the ring volume when picking up the phone

You can set your phone to automatically scale down the ring volume when you pick up the phone to answer calls.

1. Press HOME > MENU, and then tap **Settings > Sound & display**.
2. Scroll down the screen, and then select the **Quiet ring on pickup** check box.
3. Press BACK.

## Rejecting an incoming call

Depending upon if the display is on or off, you need to::

- If the display is on, tap **Decline** to reject and send the call to your voicemail.
- If the display is off, the display will turn on showing the Lock screen. While the Lock screen is showing, drag the bar up to reject and send the call to your voicemail.
- If the display is off, the display will turn on showing the Lock screen. While the Lock screen is showing, press MENU, and then tap **Decline** to reject and send the call to your voicemail.

## Rejecting a call and sending a text message

You can automatically send a default text message to the caller and reject the incoming call.

To reject and send a message when you receive an incoming call, press MENU, and then tap **Send message**.

### Editing the default message

You can change the message that is sent out.

1. Press HOME, and then tap **Phone**.
2. Press MENU, and then tap **Phone settings > Edit default message**.
3. Enter the new message, and then tap **OK**.

## Using in-call options



When a call is in progress, use the buttons onscreen to mute or unmute the microphone or to turn the speakerphone on or off. You can also press MENU to open the call options to let you add a call, place the call on hold, mute the microphone, and more.

### Handling multiple calls

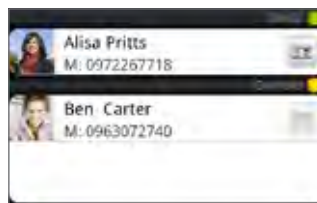

Your phone notifies you when you have another incoming call, and gives you the option of rejecting or accepting the call. If you are already on a call and accept the new call, you can choose to switch between the two callers.

1. When you receive another call, tap **Answer** to accept the second call, and to put the first call on hold.
2. To switch between callers, tap the person you want to talk to on the screen.



4. To end the current call and return to the other call, tap **End call**.



### Setting up a conference call

1. Make a call to the first participant.
2. When connected, press MENU, tap **Add call**, dial the number of the second participant, and then tap **Call**. The first participant is put on hold when you dial the second participant.
3. When connected to the second participant, tap  (merge).
4. To add another participant to the conference call, tap , and then dial the number of the contact you want to invite to the conference call.



 The conference call is put on hold when you call another contact. When you are connected to the other contact, you can talk to that party in private.

5. When connected, tap  to add the participant to the conference call.
6. When finished, tap **End call**.

## Muting the microphone during a call

On the screen, tap  to toggle between turning the microphone on or off. When the microphone is turned off, the Mute icon (  ) appears in the status bar.

## Turning the speakerphone on or off during a call

On the screen, tap  to toggle between turning the speakerphone on or off. The Speakerphone icon (  ) appears in the status bar when the speakerphone is on.

 To avoid damage to your hearing, do not hold your phone against your ear when the speakerphone is turned on.

## Ending a call

Do one of the following to end the call:

- On the screen, tap **End call**.



If the phone display is off, press **POWER** to turn on the screen so you can tap **End call**.

- If you are using the provided wired headset, press the button to end the call.

If the phone number of the person who called is not in your contacts list, you can choose to save the number to your contacts list after you hang up.



## Using call history

When you miss a call, the missed call icon (  ) appears in the title bar. Use the **Call history** tab in the People application to check who the caller was or view all your dialed numbers and received calls.

1. Press HOME, and then tap **Phone**.
2. Tap  at the bottom-right corner of the screen.
3. Do one of the following:
  - Tap the name or number in the list to call.

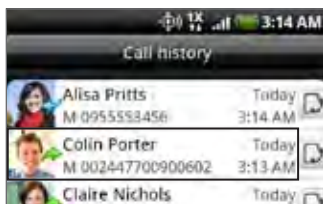

- Press and hold a name or number in the list to display the options menu where you can select to view the contact information (if the number is stored in your contacts list), edit the number before you redial, send a text message, or delete from call history.

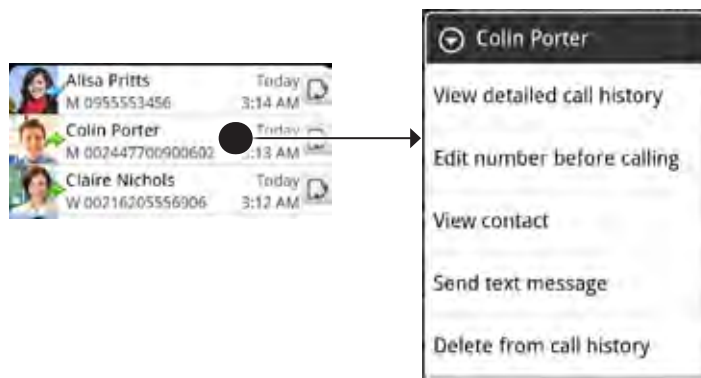

- Tap  to show the call history for that particular contact.



You can also access call history from the People application. See the People chapter for more information.

## Adding a new phone number to your contacts from call history



1. Press HOME, and then tap **Phone**.
2. Tap  at the bottom-right corner of the screen.
3. Press and hold the received call or number that is not in your contacts list that you want to save to your contacts list, and then tap **Save to contacts**.
4. In the blank contact record that appears, enter the contact name and other information. The phone number is automatically added to the **Mobile** field in the Phone section. To store it as another type of number, for example a home number, tap the **Mobile** button.
5. Scroll down the screen and tap **Save**.



To learn how to add new contacts or edit the contact information, see the People chapter.

## Checking a missed call

You will see the missed call icon  in the status bar when you miss a call.

1. Press HOME, and then tap **Phone**.
2. Tap  at the bottom-right corner of the screen.
3. In the call history list, missed calls are indicated by the missed call icon (  ).



You can also press and hold the status bar, and then slide your finger downward on the screen to open the Notifications panel. The missed call number or contact name is displayed.

## Clearing the call history list

1. Press HOME, and then tap **Phone**.
2. Tap  at the bottom-right corner of the screen.
3. Do one of the following:
  - To remove one name or number from the list, press and hold the name or number, and then tap **Delete from call history**.
  - To clear the entire list, press MENU, and then tap **Delete all**.

## Call services

---

Your phone can directly link to the mobile phone network, and enable you to access and change the settings of various phone services for your phone. Call services may include call forwarding, call waiting, voicemail, and more.

To open call services, press HOME > MENU, and then tap **Settings > Call**.

### **Voicemail service**

Shows the current voicemail service being used.

### **Voicemail settings**

Specify voicemail number.

### **Clear voicemail notification**

If you have a notification of a new voicemail, you can clear the notification with this option.

### **Auto Retry**

When enabled, the phone automatically redials a number when the attempted call fails.

### **TTY mode**

Allow the use of a TTY (teletypewriter) device for users who are visually or hearing impaired.

### **Hearing aids**

Turn on the Hearing Aid Compliance feature that reduces interference to hearing aids.

### **Phone settings**

Edit the call reject message, choose whether to open the message editor when you reject a call with a message, and choose whether to allow automatic saving of an unknown contact number when a call with that number ends.

### **NBPCD**

Set the calling parameters for the current country, such as country code and IDD prefix.

### **Assisted Dialing**

Assisted Dialing allows you to easily dial international calls while roaming in another country. See "Using Assisted Dialing" in this chapter for details.

### **Voice Privacy**

Encrypts outgoing voice calls and uses secure channels when available.

## Turning Airplane mode on or off

---

In many countries, you are required by law to turn off the phone while on board an aircraft. A way to turn off the phone function is to switch your phone to **Airplane mode**. When you enable Airplane mode, all wireless radios on your phone are turned off, including the call function, data services, Bluetooth, and Wi-Fi.

1. Press HOME > MENU, and then tap **Settings > Wireless & networks**.
2. Select or clear the **Airplane mode** check box to enable or disable Airplane mode. When enabled, the Airplane mode icon (  ) is displayed in the status bar.



When you disable Airplane mode, the call function is turned back on and the previous state of Bluetooth and Wi-Fi is restored.

# People

## About People

---

In **People**, you can easily manage your communications with contacts via phone, messaging, and email. You can also view updates on their Facebook and Flickr accounts.

If you are synchronizing contacts with your Google account, with your PC, and/or with an Exchange Server, any contacts stored in those accounts are displayed in People. You can also synchronize contacts from your Facebook account in People. For more information on synchronizing accounts, see “Ways of getting contacts into your phone” in this chapter.

## Ways of getting contacts into your phone

---

You can add contacts to your phone from:

- **Gmail/Google Mail contacts** Gmail/Google Mail contacts are imported to your phone after you set up a Google Account. For details, see the “Gmail/Google Mail” in the Email chapter.
- **Phone contacts** See “Adding a new contact” in this chapter for details.
- **Exchange ActiveSync Server** See “Synchronizing with a Microsoft Exchange ActiveSync account” in the Accounts and sync chapter for details.
- **Contacts on your computer** See “Using HTC Sync” in the Accounts and sync chapter for details.
- **Facebook** See “Adding an account” in the Accounts and sync chapter for details.

## People screen

The People screen gives you easy access to all your contacts, as well as even faster access to the people and groups of people you contact most often.

The People screen has the following tabs:



---

### 1 All tab

Gives you access to all contacts on your phone, including Google contacts, Exchange ActiveSync contacts, Phone contacts, and Facebook contacts. You can also use this tab to open or update My contact card. For more information, see “Setting up My Contact Card” in this chapter.

---

### 2 Groups tab

Lets you assign contacts to groups so you can easily send an SMS, MMS, or email message to a whole group. For more information, see “Contact groups” in this chapter.

---

### 3 Online directories tab

Search for contacts on your online directories such as your Exchange ActiveSync or Facebook account to copy to your phone.

---

### 4 Call history tab

Lists all your dialed numbers and received and missed calls. See “Using Call History” in the Phone calls chapter.

---

## Setting up My contact card

My contact card provides a convenient way to store your personal contact information so that you can easily send it via SMS, MMS, email, or Bluetooth.

1. Press HOME, and then tap  > People.
2. On the All tab of the People screen, tap Me, and then tap Tap here to edit contact.



If you are logged in to your Facebook account through Facebook for HTC Sense, instead of Me, you will see your the name you use in Facebook.

3. Enter your name and contact details.
4. Tap Save.

## Your contacts list

The All tab of the People screen shows all your contacts, including Google contacts, Exchange ActiveSync contacts, Phone contacts, and Facebook contacts.



If you signed in to your Google Account and Facebook account when you first set up the phone, your contacts from those accounts will appear in the contacts list when you open People.

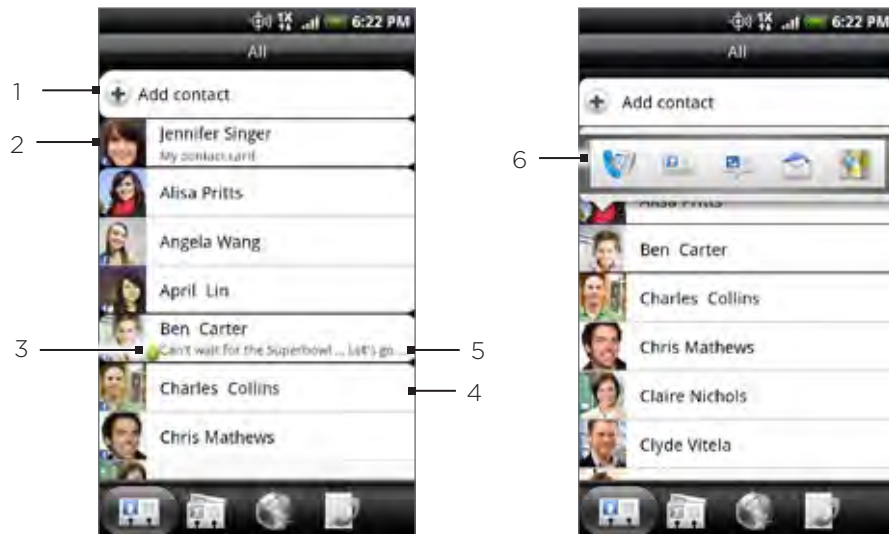

- 
- 1 Create a new contact.

---

  - 2 Tap to edit your My contact card.

---

  - 3 This icon appears when the contact:
    - Has sent you a new text or email message, or tried to call you but you missed the call.
    - Has updated his or her Facebook profile or has added photos on Flickr or Facebook.
    - Has upcoming Facebook events.

---

  - 4 Tap to open the contact details screen for that contact.

---

  - 5 This appears when the contact is a Facebook contact or you link the contact to his or her Facebook account.

---

  - 6 Tap the photo or icon to open a menu where you can quickly choose how to communicate with the contact. Depending on the contact information stored, you can call, send a message or email, see the contact's Facebook profile, and map his/her address in Google Maps.

---





To view only contacts of a particular type, for example Google contacts or Facebook contacts, press MENU, tap **View**, and select the contact types.

## Adding a new contact

1. Press HOME, and then tap  > People.
2. On the All tab, tap **Add contact** at the top of the screen.
3. Select the **Contact type**, for example **Google** or **Microsoft Exchange ActiveSync**. This determines which account the contact will sync with. For more information, see “Ways of getting contacts into your phone” in this chapter.
4. Tap the **Name** field, enter the first and last name of the contact, and choose the order in which to display the names. Tap **OK**.
5. Enter the contact information in the fields provided.
6. Scroll to the bottom of the screen, and then tap **Save**.

## Importing contacts from an Exchange ActiveSync account

Access contacts from your Exchange ActiveSync account, and then copy them to the phone. You need to have your Exchange ActiveSync account set up on your phone.





1. Press HOME, and then tap  > People.
2. On the Online directories tab, tap Company directory.
3. Enter the name, and then tap .
4. In the list, tap the name of the contact you want to copy to your phone.
5. Tap Save to People.

## Merging contact information



Merge duplicated contacts on your phone to avoid clutter and confusion. If you have the same contact appear in your Phone, Google, and Facebook accounts, you can merge the contact information into one contact.

The phone automatically merges contacts that it finds to have similar data. If you need to manually merge contacts or break the link between contacts, follow the procedures below.

### Manually merging contact information

1. Press HOME, and then tap  > People.
2. On the All tab, tap the name of the contact (not the icon or photo) you want to merge with another contact on your phone.
3. At the upper right corner of the screen, tap  or  (if there are suggested links.)
4. On the screen, you can:
  - If there are suggested links, tap  to link the contact to the selected account.
  - Tap one of the options available in the Add contact section.
5. Tap Done.

### Breaking the contact information link between contacts

1. Press HOME, and then tap  > People.
2. On the All tab, tap the name of the contact (not the icon or photo) whose contact information link you want to break.
3. On the upper right corner of the screen, tap .
4. On the Linked contacts section, tap  beside the name of the contact to break the link.
5. Tap Done.

## Editing a contact's information

1. Press HOME, and then tap  > People.
2. On the All tab, press and hold the contact, and then tap Edit contact.
3. Enter the new information for the contact.
4. Scroll to the bottom of the screen, and then tap Save.



## Searching for a contact

1. Press HOME, and then tap  > People.
2. Press the SEARCH button on the phone.
3. In the search bar, enter the first few letters of the first or last name of the contact you are looking for. Matching contacts are displayed.



If the list of matching contacts is long, you can view more results by tapping  to hide the onscreen keyboard.

4. Tap the contact to open his or her contact details screen. See “Contact information and conversations” in this chapter for details.

## Backing up your contacts to the storage card

1. Press HOME, and then tap  > People.
2. Press MENU, and then tap Import/Export > Export to SD card.
3. When asked to confirm, tap OK.

## Importing contacts from the storage card

1. Press HOME, and then tap  > People.
2. Press MENU, and then tap Import/Export > Import from SD card.



You can only import contacts that were exported to the storage card using the **Export to SD card** feature on the phone. See “Backing up your contacts to the storage card.”

3. If you have Google or Exchange ActiveSync accounts set up on your phone, tap the type for the imported contacts.



Press BACK to stop importing contacts from the storage card.

## Deleting contacts

1. Press HOME, and then tap  > People.
2. On the All tab, press MENU, and then tap Delete.
3. Select the contacts you want to delete, and then tap Delete.
4. When prompted, tap OK.



To delete a single contact, on the All tab, press and hold the name of the contact (not the icon or photo) who you want to delete and select **Delete contact** from the menu.

## Sending contact information as a vCard via MMS

1. Press HOME, and then tap  > People.
2. On the All tab, press and hold the name of the contact (not the icon or photo) whose contact information you want to send, and then tap **Send contact as vCard**.
3. Select the type of information you want to send, and then tap **Send**.
4. Enter the recipient’s number or email address, and then tap **Send**.



You cannot send a vCard using SMS.

You can also send a vCard via Bluetooth. To learn how to send files through Bluetooth, see the Bluetooth chapter.

## Sending your contact information as a vCard via MMS

1. Press HOME, and then tap  > People.
2. On the All tab, tap [Your name] My contact card.
3. Press MENU, and then tap **Send my contact info**.
4. Select the type of information you want to send, and then tap **Send**.
5. Enter the recipient's number or email address, and then tap **Send**.



You cannot send a vCard using SMS.

You can also send your contact vCard via Bluetooth. To learn how to send files through Bluetooth, see the Bluetooth chapter.

## Contact groups

---

On the **Groups** tab, you can assign contacts to groups so you can easily send an SMS, MMS, or email message to a whole group. You can also sync groups on your phone with the groups in your Google account, accessible via your computer's web browser.

### Creating a group and adding contacts

1. Press HOME, and then tap  > People.
2. On the **Groups** tab, at the top of the screen, tap **Add group**.
3. Enter a name for the group, and then tap **Add contact to group**.
4. Select the contacts you want to add to the group, and then tap **Save**.



If your contacts list is long, you can use the search bar to search for contacts quickly, or tap  to hide the onscreen keyboard and scroll through the list.

6. Tap  to add a group from photo.
7. Tap **Save**.



### Deleting a group

1. Press HOME, and then tap  > People.
2. On the **Groups** tab, press and hold the group you want to delete, and then tap **Delete group**.



You can only delete groups that you have created.

### Adding or removing contacts from a group

1. Press HOME, and then tap  > People.
2. On the **Groups** tab, press and hold the group, and then tap **Edit group**.
3. You can:
  - Tap the group name to change the name. You can only change the name for groups that you have created.
  - Tap the icon to the left of the group name to change or remove the group photo.
  - To add contacts to the group, tap **Add contact to group**, select the contacts you want to add, and then tap **Save**.
  - To remove a contact from the group, tap  at the right side of the contact name, and then tap **Save**.

## Sending an SMS/MMS message or email to a group

1. Press HOME, and then tap  > People.
2. On the **Groups** tab, tap the group you want to send an SMS/MMS message or email to.
3. Go to the **Group action** tab, and then do one of the following:
  - Tap **Send group message** to send an SMS/MMS message to the group. For information about composing and sending messages, see the Messages chapter.



You will be charged by your mobile provider for each message sent. For example, if you send a message to a group of five people, you will be charged for five messages.

- Tap **Send group mail** to send an email to the group. For information on composing and sending email, see the Email chapter.

## Contact information and conversations

---

When you tap a contact on the People screen, the contact details screen opens, showing you the information stored for that contact, exchanged messages and phone calls with that contact, Facebook notifications, and more.

The contact details screen has the following tabs:



---

### 1 Details tab

Shows the information you have stored for the contact, and allows you to get in touch with the contact directly by tapping any of the displayed methods. For example, if the contact has a stored work phone number, tap **Call Work** to call that number.

You can also add one of the contact's phone numbers as a speed dial number. For information, see "To add a contact to speed dial" in this chapter.

---

### 2 Messages tab

Shows your exchanged SMS messages with the contact. Tap a message to view it. To send a new message, tap **New message**. For more information about messages, see the Messages chapter.

---

### 3 Mail tab

Shows email messages you have received from the contact. Tap an email message to view it. To send a new email message, tap **New mail**. For more information about email, see the Email chapter.

---

### 4 Updates and events tab

Shows the contact's Facebook status, updates, and events, and shows when he or she uploads new photos to Flickr. When there is a notification of the contact's birthday, you can tap the notification to call the contact directly or send a message greeting.

You need to be logged in to your Facebook account to see the updates and events. If you are not logged in, tap **Link to Facebook**.

---

### 5 Photos tab

Shows the contact's Facebook and Flickr photo albums. Tap an album to look at the photos in the album.

You need to be logged in to your Facebook and Flickr accounts to see the photo albums. If you are not logged in, tap **Link to Facebook** and/or **Link to Flickr**.

---

### 6 Call history tab

Lists all your incoming, outgoing, and missed calls to and from the contact. Tap a list item to call the contact using the displayed number.

---

## People widget

---

Put the group of people you contact most right on the Home screen of your phone by adding them as the People widget. Using the People widget, you can instantly place a call, send a message, or view details of a favorite contact with a single tap.

### Adding the People widget

Slide your finger left or right on the Home screen to find the People widget. If you do not find the People widget on the Home screen, follow this procedure to add the widget to the Home screen.

1. Press HOME, and then tap  > Widget > People.
2. Choose the widget style, and then tap **Select**.
3. Select the group you want to add as a widget.
4. Drag the widget to a blank space on a Home screen, and then release.

### Setting the default communication method

1. Press HOME, and then go to the People widget.
2. Tap a contact on the widget.
3. On the Select default action screen, tap the communication method you want for the contact.

### Changing the default communication method

1. Tap the contact's name (not the photo) on the widget.
2. Press MENU and then tap **More > Set widget action**.
3. On the Select default action screen, tap the new communication method you want for the contact.

### Getting in touch with a contact

1. Press HOME, and then go to the People widget.
2. Tap a contact (photo not the name) on the widget. The default communication method will be performed.



Tap the name of the contact to open the contact details screen for that contact.

If you have not set a default communication method, the Select default action screen will open. See “Setting the default communication method” in this chapter for details.

# Keyboard

## Using the onscreen keyboard

---

When you start a program or select a field that requires text or numbers, the onscreen keyboard becomes available.

### Using the landscape onscreen keyboard

When entering text, you can choose to use the landscape orientation of the onscreen keyboard. Turn the phone sideways to use a larger keyboard that lets you type easily using two thumbs.



- The Orientation check box in HOME > MENU > Settings > Sound & display needs to be selected for the screen orientation to automatically change.
- The landscape orientation keyboard is not supported in all applications.









### Changing the onscreen keyboard layout

You can choose from three different keyboard layouts to suit your typing style. To change the keyboard layout, do the following:

1. On the onscreen keyboard, press and hold .
2. Tap **Keyboard types**, and then select the keyboard layout that you want to use. Choose from the following:
  - **QWERTY**. This layout is similar to a desktop computer keyboard. This is the default keyboard layout.
  - **Phone Keypad**. This layout resembles the traditional mobile phone keypad.
  - **Compact QWERTY**. This layout features two letters on each key. The key size is slightly bigger than on the Full QWERTY layout.

## Entering text

Use the following keys while entering text using the onscreen keyboard:

	Press and hold keys with gray characters at the top to enter numbers, symbols, or accented letters. The gray character displayed on the key is the character that will be inserted when you press and hold that key. Some keys have multiple characters or accents associated with them.
	This is the Shift key. Tap to enter an uppercase letter. The next letter you type will be uppercase. Tap twice to turn on caps lock.
	Tap to switch to the numeric and symbol keyboard.
	This is the Enter key. Tap to create a new line.
	This is the Backspace key. Tap to delete the previous character.
	Tap to hide the onscreen keyboard.
	<ul style="list-style-type: none"> <li>Tap to activate voice input. When prompted, speak clearly into the microphone to enter your text onscreen.</li> <li>Press and hold to open the Touch Input settings menu to change the keyboard type, enable or disable predictive mode in the QWERTY keyboard, and adjust other input settings.</li> </ul>
	Tap to toggle between Multitap and XT9 predictive modes when using the Compact QWERTY or Phone keypad layout. For more information, see “Entering words with predictive text” below.

## Entering words with predictive text

The onscreen keyboard has predictive text to help you type quickly and accurately. Predictive text input is enabled by default, and word suggestions are displayed as you type.

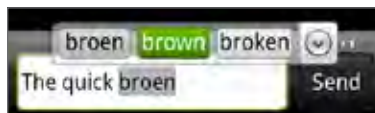

To enter a word in predictive mode, do any of the following:

- If you see the word you want highlighted in green or orange, you can simply tap the space bar to insert the word into your text.
- If you see the word you want shown in the suggestions before you have finished typing the entire word, tap the word to insert it into your text.
- If an arrow is shown to the right of the suggestion list, tap the arrow to see more suggestions.



## Adding a word to the predictive text dictionary

Your phone comes with a list of words that it references for predictive text suggestions. Sometimes you may need to add a word to the predictive text dictionary, for example a name or a specialized technical word.

While entering text using the QWERTY keyboard layout, if you tap any word on the suggestion list, it is automatically added to the predictive text dictionary if it was not in the dictionary already.

You can also add a word to the list manually:

1. On the onscreen keyboard, press and hold .
2. Tap **User Dictionary**.
3. Tap **Add new**.
4. Enter the word to add, and then tap **OK**.

## Editing or deleting a word in the user dictionary

You can edit or remove words that you previously added to the predictive text dictionary.

1. On the onscreen keyboard, press and hold .
2. Tap **User Dictionary**.
  - To edit a word, tap the word itself.
  - To delete a word, tap the **X** icon to the right of the word.

## Entering text with voice input

You can use the phone's microphone to input text vocally.

1. On the onscreen keyboard, press .
2. When prompted, say what you want written clearly into the microphone.

# Adjusting touch input settings

---

Open the Touch Input settings by doing one of the following:

- On any of the keyboard layouts, press and hold  to open the Touch Input settings.
- On the Home screen, press MENU and then tap **Settings > Language & keyboard > Touch Input**.

## Touch Input settings

### Keyboard types

Tap to select the keyboard layout to use. You can choose from QWERTY, Phone Keypad, or Compact QWERTY.

### Keyboard language

Tap to select the language layout of the keyboard.

### Text input

Tap to set text input options when entering text, calibrate the keyboard, and set a sound and/or vibration feedback whenever you tap a key. See “Text input” below for details.

### Tutorial

Learn how to use the onscreen keyboard with this interactive tutorial.

### User Dictionary

Add, edit or remove words in the predictive text dictionary. See “Entering words with predictive text” in this chapter for more information.

## Text input

### QWERTY

#### Prediction

Select to enable the word prediction feature which provides a list of possible words that reflect the characters of the keys you have tapped as well as characters of nearby keys.

#### Spell correction

Select to correct typographical errors by selecting from a list of possible words that reflect the characters of the keys you have tapped as well as characters of nearby keys.

### Phone keypad & compact QWERTY

#### Spell correction

Select to correct typographical errors by selecting from a list of possible words that reflect the characters of the keys you have tapped as well as characters of nearby keys.

#### Word completion

When using the Compact QWERTY or Phone keypad, lets you select from a list of possible combinations based on the characters that appear on the keys that you tapped.

## Other settings

### Sound feedback

Select to hear a clicking sound whenever you tap a key on the keyboard.

### Vibrate when typing

Select to enable vibration feedback whenever you tap a key on the keyboard.

## Finger touch precision

### Calibration tool

Tap to re-calibrate the keyboard touch accuracy. Re-calibrate the keyboard if you feel that the keyboard keys are not responding accurately to your taps.

### Reset calibration

Tap to reset the calibration back to factory default.

# Messages

## About Messages

---

**Messages** lets you compose and send text (SMS) and multimedia messages (MMS) to other mobile phones.

To open your message inbox, press HOME, and then tap  > **Messages**.

If the list of messages does not fit on the screen, you can scroll down to view more messages by swiping your finger on the screen or the optical joystick.

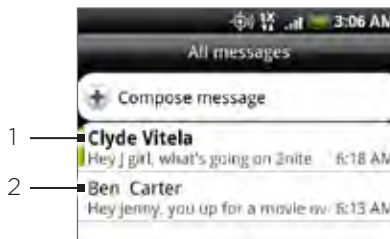

- 
- 1 Bold text indicates unread messages in the thread.
  - 2 Tap to open the message or message thread and read the text or view the picture message.
- 

## Sending text and multimedia messages



Send short text messages (SMS) and multimedia messages (MMS) to other mobile phones. If you exceed the limit on the number of characters for a single text message, your text message will be delivered as one but will be billed as more than one message. These are called concatenated messages.

Multimedia messages can contain text and a picture, a recorded voice, an audio or video file, a picture slideshow, contact card (vCard), or appointment (vCalendar).



The Messages application automatically converts a text message into a multimedia message when you enter an email address in the To field, add a message subject, attach an item, or compose a very long message.

### Sending a text message

1. Press HOME, and then tap  > **Messages**.
2. On the All messages screen, tap **New message**. The Compose screen opens.
3. Fill in one or more recipients. You can:
  - Enter phone numbers directly in the To field. If you're sending the message to several phone numbers, separate the phone numbers with a comma. As you enter information, any matching phone numbers from your contacts list are displayed. Tap a match to enter that number or address directly.
  - Tap the  icon, and then select the phone numbers of the contacts to whom you want to send the message. You can also select contact groups as recipients. When you have selected all the message recipients, tap **Done**.

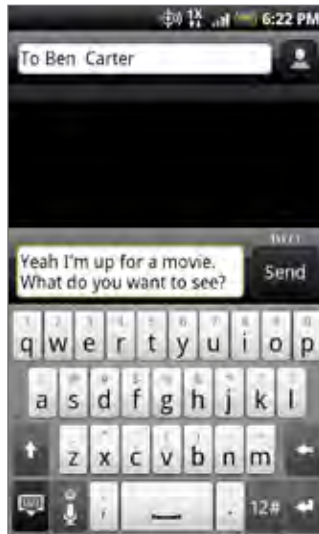

4. Tap the text box that contains the text “Tap to compose”, and then start composing your message.



5. When done, tap **Send** to send the text message.

 To receive delivery reports and know when a text message is received, in the All messages screen, press MENU and then tap **Settings**. In the SMS settings section, select the **Delivery reports** check box.

### Sending a multimedia (MMS) message

1. Press HOME, and then tap  > **Messages**.
2. On the All messages screen, tap **New message**. The Compose screen opens.
3. Fill in one or more recipients. You can:
  - Enter phone numbers or email addresses directly in the To field. If you're sending the message to several recipients, separate the phone numbers or email addresses with a comma. As you enter information, any matching phone numbers or addresses from your contacts list are displayed. Tap a match to enter that number or address directly.
  - Tap the  icon, and then select the contacts to whom you want to send the message. You can also select contact groups as recipients. When you have selected all the message recipients, tap **Done**.



You can add a subject line by pressing MENU and then tapping **Add subject**.

4. Tap the text box that contains the text “Tap to compose”, and then start composing your message.





Tap  to enter the message by speaking into the microphone.

5. Press MENU and then tap **Attach**.
6. On the Attach window, select from the following file attachments:
  - **Picture**. Select **Camera** to take a photo and attach it, or **Pictures** to attach a photo from your storage card.
  - **Video**. Select **Camcorder** to capture a video and attach it, or **Videos** to attach a video from your storage card.

- **Audio.** Select **Voice Recorder** to make a voice recording and attach it, or **Music & sounds** to attach a music file or voice recording from your storage card.
- **Location.** You can attach location information. Send your current location (requires GPS to be turned on), a location stored in Footprints, or a location you pick on a map. For more information about GPS, maps, and Footprints, see the Maps and location chapter.
- **Contact (vCard).** Select a contact from your phone, and then select which contact information you want to attach.
- **Appointment (vCalendar).** Select the calendar event you want to attach.
- **Slideshow.** Opens the Edit slideshow screen. Tap **Add slide** to create a new slide. Tap the created slide (for example, Slide 1), tap **Insert picture**, and then select the picture you want to add to the slide. You can also navigate to the text box and enter a caption for the picture. When finished, tap **Done** to attach the slideshow to your message.



- When editing multiple slides, tap  to edit the next slide or tap  to return to the previous slide.
- While editing the slideshow, press MENU to let you preview the slideshow, add music or video to a slide, remove a slide, and more.

7. When you have finished composing the multimedia message, tap **Send**.



To receive delivery reports and know when a picture message is received, in the All messages screen, press MENU, and then tap Settings. Select the **Delivery reports** check box in the MMS settings section.

### Saving and resuming a draft message

While composing a text or multimedia message, press BACK to automatically save your message as a draft. To resume composing the message:



1. On the All messages screen, press MENU, and then tap **Drafts**.
2. Tap the message to resume editing it.
3. When you finish editing the message, tap **Send**.

## New message notifications

---

Depending on your notification settings, the phone will play a ringtone, vibrate, or display the message briefly in the status bar when you receive a new text or multimedia message. To change the notification for new text and multimedia messages, see “Setting text and multimedia message options” later in this chapter.



A new message icon  also appears in the notifications area of the status bar to notify you of a new text or multimedia message. The **Messages** application icon (if shown on the Home screen) also displays the number of new messages .

To open the message, press and hold the status bar, and then slide the status bar down to open the Notifications panel. Tap the new message to open and read it. For information on reading and replying to messages see “Managing message conversations” in this chapter.

## WAP push messages

---

WAP push messages contain a web link. Often, the link will be to download a file that you have requested, for example a ringtone.

When you receive a WAP push message, a notification icon  is displayed in the status bar.

### Opening the link contained in a WAP push message

1. Press and hold the status bar, and then slide the status bar down to open the Notifications panel.
2. Tap the new message.
3. Tap Visit website.

### Viewing all your WAP push messages

1. Press HOME, and then tap  > Messages.
2. Press MENU, and then tap Push messages.



## Managing message conversations

---

Text and multimedia messages that are sent to and received from a contact (or a number) are grouped into conversations or message threads in the All messages screen. Threaded text or multimedia messages let you see exchanged messages (similar to a chat program) with a contact on the screen.

### Reading a text message

Do one of the following:

- On the All messages screen, tap the text message or message thread to open and read it.
- If you have a new message notification, slide the status bar down to open the Notifications panel. Tap the new message to open and read it.

To return to the All messages screen from a text message thread, press MENU and then tap **All messages**.



- To view the details of a particular message, in the message thread, press and hold the message to open the options menu, and then tap **View message details**.
- If a message contains a link to a web page, tap the message and then tap the link to open it in the web browser.
- If a message contains a phone number, tap the message and then tap the phone number to dial the number or add it to your contacts.

### Viewing a multimedia message

1. Press HOME, and then tap  > **Messages**.
2. On the All messages screen, tap a multimedia message or message thread to open it.
3. Tap the attachment to open it.
 

If the attachment is a vCard contact, it is imported to your Phone contacts list. For information about contacts, see the People chapter.

If the attachment is a vCalendar file, you can choose the calendar where you want to save the event. For information on using Calendar, see the Calendar chapter.
4. To save the attachment to the storage card, press and hold the sender's name or number, and then tap **Save [attachment type]** on the options menu.



- When **Auto-retrieve** in MMS settings is disabled, only the message header is downloaded. To download the entire message, tap the **Download** button at the right side of the message. For details, see "Setting text and multimedia message options" later in this chapter.
- If you are concerned about the size of your data downloads, check the multimedia message size before you download it.

### Replying to a text or multimedia message

1. Press HOME, and then tap  > **Messages**.
2. On the All messages screen, tap a text or multimedia message thread to open it.
3. Tap the text box at the bottom of the screen, enter your reply message, and then tap **Send**.



To reply to a text message with a multimedia message, open the text message, press MENU and then tap **More > Add subject**, or **Attach**. The text message is automatically converted into a multimedia message.

## Protecting a message from deletion

You can lock a message so that it will not be deleted even if you delete the other messages in the conversation.

1. Press HOME, and then tap  > Messages.
2. On the All messages screen, tap a message thread.
3. Press and hold the message that you want to lock
4. Tap **Lock message** on the options menu.

A lock icon  is displayed at the right hand side of the message.

## Deleting a message thread

1. Press HOME, and then tap  > Messages.
2. On the All messages screen, tap the message thread that you want to delete.
3. Press MENU, and then tap **Delete**.
4. When prompted to confirm, tap OK.



Any locked messages in the thread will not be deleted unless you select the **Delete locked messages** check box.

## Deleting several message threads

1. Press HOME, and then tap  > Messages.
2. On the All messages screen, press MENU, and then tap **Delete**.
3. Select the message threads you want to delete.
4. Tap **Delete**. Any locked messages will not be deleted.

## Deleting a single message

1. While viewing a message thread, press and hold the message that you want to delete.
2. If the message is locked, tap **Unlock message** on the options menu, and then press and hold the message to display the options menu again.
3. Tap **Delete message** on the options menu.
4. When prompted to confirm, tap OK.

## Viewing contact details and communicating with a contact

When you have received a message from someone in your stored contacts, you can tap the contact's photo or icon in the message thread to open a menu of options. Depending on the stored contact information, you can view the contact details, phone or send an email message to the contact, and more.

## Setting text and multimedia message options

---

Press HOME, and then tap  > Messages. On the All messages screen, press MENU and then tap **Settings** to set the text or multimedia message options. You can set the following:

### SMS settings

#### Delivery reports

Select this option to receive a report on the delivery status of your message.

#### Priority setting

Set the message priority of SMS messages sent

#### Send callback number

Enable your phone to include a number with the text message to allow the recipient to call you back by pressing the SEND button.

#### Callback number

Set the callback number.

### MMS settings

#### Delivery reports

Select this option to receive a report on the delivery status of your message.

#### Auto-retrieve

Select this option to automatically retrieve all your MMS messages completely. When selected, the MMS message header plus the message body and attachments will automatically download to your phone. If you clear this check box, only the MMS message header will be retrieved and shown in your All messages screen.

#### Priority setting

Set the message priority of MMS messages sent.

#### Maximum message size

Set the maximum file size of an MMS message. The MMS message will not be sent out if it exceeds the file size set here.

### Received messages

#### Received notification

Select this option if you want to receive a notification in the status bar when a new text or multimedia message arrives.

#### Play notification sound

If you want the phone to ring when a new message arrives, select this option.

#### Notification sound

Select a ringtone that is specific to new text and multimedia messages. Note that the ringtone briefly plays when selected.

#### Vibrate

Select this option if you want the phone to vibrate when a new text or multimedia message arrives.

## Sent messages

### Sent notification

Select this option if you want to receive a notification in the status bar when a message is sent successfully.

### Failure notification

Select this option if you want to receive a notification in the status bar when a message is not sent successfully.

### Play notification sound

If you want the phone to ring when a sent or failure notification is received, select this option.

### Notification sound

Select a ringtone that is specific to sent or failure notifications. Note that the ringtone briefly plays when selected.

### Vibrate

Select this option if you want the phone to vibrate when a new text or multimedia message arrives.

## Adding the Messages widget

---

Add the Messages widget to let you read your messages on the Home screen. To learn how to add widgets, refer to “Adding a widget to your Home screen” in the Personalizing chapter.

# Accounts and sync

## Synchronizing with online accounts

---

Your phone can sync information and receive updates from your Google™ and Microsoft® Exchange ActiveSync® accounts as well as popular online services such as Facebook®, Twitter™, and Flickr™.

These are some of the types of information you can sync:

- Gmail™/Google Mail and Exchange ActiveSync email.
- Google and Exchange ActiveSync contacts, as well as your Facebook friends' contact information. For information on contacts, see the People chapter.
- Calendar events from your primary Google Account and from Exchange ActiveSync. For information on using Calendar, see the Calendar chapter.
- Status updates and links shared by your friends and yourself on social networks such as Facebook and Twitter. For details, see the Social chapter.
- Flickr and Facebook photo uploads. For information on viewing photos, see the Photos chapter.

### Adding a social network account

You can sync with your accounts on popular online services such as Facebook, Twitter, and Flickr.

1. Press HOME > MENU, and then tap **Settings > Accounts & sync**.
2. Tap **Add account**, and then tap the account type you want to add.
3. Follow the onscreen instructions to enter the account information.

When you have finished, the account is added to the list on the Accounts & sync screen. Depending on how you configured the account, the new information may start synchronizing with your phone.

### Synchronizing with a Google Account

Signing in to your Google Account lets you synchronize Gmail/Google Mail and your Google contacts and calendars between your phone and the web. You also need to sign in to a Google Account to use Google applications such as Google Talk™ and Android Market.

You can add more than one Google Account on your phone. However, subsequent Google Accounts can only synchronize Gmail/Google Mail and contacts. Other Google services use the first Google Account you added.

1. Press HOME > MENU, and then tap **Settings > Accounts & sync**.
2. Tap **Add account > Google**.
3. Follow the onscreen instructions to sign in to an account or create a new account.

## Synchronizing with a Microsoft Exchange ActiveSync account

You can only add one Microsoft Exchange ActiveSync account on your phone. You can sync with Microsoft Exchange Server 2003 Service Pack 2 (SP2) or later.

1. Press HOME > MENU, and then tap **Settings > Accounts & sync**.
2. Tap **Add account > Exchange ActiveSync**.
3. Enter the Exchange ActiveSync account details, and then tap **Next**.



Your corporate Exchange Server must support auto-detect for the phone to automatically set up the Exchange ActiveSync account. If your corporate Exchange Server does not support auto-detect, you will need to enter your Exchange Server settings after you tap **Next**. Ask your Exchange Server administrator for details.

4. Select the types of information you want to synchronize, and then tap **Finish setup**.

## Managing your accounts

### Changing general sync settings

1. Press HOME > MENU, and then tap **Settings > Accounts & sync**.
2. Select or clear the following:
  - **Background data.** If this is selected, applications can send and receive online account information even if you are not currently using them.
  - **Auto-sync.** If this is selected, applications can use the sync schedule defined in the account settings. If this is cleared, you will need to sync accounts manually. For instructions on doing this, see “Synchronizing an account manually” below.

### Changing account settings

You can change settings such as the sync frequency and the types of information synchronized, the kinds of notification you receive, and the way that account information is displayed.

1. Press HOME > MENU, and then tap **Settings > Accounts & sync**.
2. Tap the account that you want to edit.
3. Edit the account settings.

### Synchronizing an account manually

1. Press HOME > MENU, and then tap **Settings > Accounts & sync**.
2. Tap the account that you want to sync.
3. Tap **Sync now**.

### Removing an account

You can remove an account to delete it and all information associated with it from your phone, for example messages, contacts, or settings. Removing an account does not delete information from the online service itself.



You cannot remove some accounts, such the first Google Account you signed into on the phone, except by deleting all personal information from your phone with a hard reset. For instructions on doing this, see “Performing a hard/factory reset” in the Backup, update and reset chapter.

1. Press HOME > MENU, and then tap **Settings > Accounts & sync**.
2. Tap the account that you want to remove.
3. Tap **Remove account**, and then confirm that you want to remove the account.

## Using HTC Sync

---

Are you using Microsoft Outlook or Outlook Express on your computer? You can use **HTC Sync** to synchronize your Outlook contacts and calendar or your Outlook Express contacts with your phone. Before you do a factory reset or a software (ROM) upgrade of your phone, you can also use HTC Sync to back up and sync this information from your phone back to your computer.

Here's what you'll need to do to install, set up, and use HTC Sync on your computer:

1. Download and install HTC Sync from the HTC support website. See "Downloading the latest HTC Sync upgrade" for details.
2. Connect your phone to your computer using the supplied USB cable and set up HTC Sync to recognize your phone. Follow the steps in "Setting Up HTC Sync to recognize your phone".
3. Choose what information to sync between your computer and your phone and how you want to sync them.
  - To easily set up synchronization using HTC Sync's guided wizard, follow the steps in "Setting up synchronization".
  - To choose from more sync options, see "Setting up more sync options".
4. Sync your computer with your phone automatically or manually. See "Synchronizing your phone" for details.

Here's more you can do with HTC Sync:

- If you have third-party applications on your computer (not from Android Market), you can use HTC Sync to install them from your computer to your phone. For more information, see "Installing apps from your computer to your phone".
- Repair contacts and/or calendar data, only if needed.

### Installing HTC Sync



- HTC Sync requires USB 2.0 on your computer to connect and sync with your phone. To see a complete list of the computer and software requirements, you can check them in the HTC Sync software download page on the HTC support website:  
[http://www.htc.com/www/SupportViewNews.aspx?dl\\_id=847&news\\_id=471](http://www.htc.com/www/SupportViewNews.aspx?dl_id=847&news_id=471)
  - For trouble-free installation, first quit all running programs and temporarily exit from your anti-virus program before you start installing HTC Sync.
1. Download HTC Sync from the HTC support website. See "Downloading the latest HTC Sync upgrade" for details.
  2. Run "HTC Sync.exe" to install it to your PC.
  3. From your PC, launch HTC Sync, and use the USB cable to connect your phone to the PC (if the phone is not connected to the PC there will be a sync failure).
  4. On your phone, check Notifications on the status bar for the icon to confirm if HTC Sync recognizes the phone.
  5. The first time you synchronize the phone, the Synchronization Settings Wizard will start automatically to help you set up HTC Sync. (If the Synchronization Settings Wizard does not start, click **Synchronize Now** on the HTC Sync screen.)
  6. On your PC, follow the instructions to finish the wizard on the HTC Sync screen.

## Setting up HTC Sync to recognize your phone

After installing, set up HTC Sync to recognize your phone.

1. Connect your phone to the computer with the supplied USB cable. Or, if your phone is already connected, press and hold the status bar and drag your finger down to open the Notifications panel. Then tap the status that shows “Select to change USB connection type”.
2. On the Connect to PC screen in your phone., tap **HTC Sync** and then tap **Done**.
3. Your phone attempts to find HTC Sync on your computer. Wait for a few seconds for the process to finish.



If your phone displays a message indicating that it's unable to find HTC Sync, try disconnecting and reconnecting the USB cable, and then repeat step 2.

4. When your phone finds HTC Sync, your computer will display the Phone Connection Wizard. Click **Next**.
5. Enter the name you want for your phone, and then click **Finish**.
6. Check the HTC Sync icon at the bottom-right side of your computer screen. If it appears green in color, that means your phone has successfully connected with your computer and HTC Sync recognizes your phone.



## Setting up synchronization

You can set up HTC Sync to synchronize your computer's Outlook contacts and calendar events with your phone. If you're using Outlook Express on your computer, you can only sync contacts with your phone.



Before you begin setting up synchronization, make sure you have set up HTC Sync to recognize your phone. If you have not yet done so, follow the steps in “Setting up HTC Sync to recognize your phone”.

1. On your computer, check and make sure the HTC Sync icon  at the bottom-right side of the screen appears in green which means that your phone is connected to HTC Sync.
2. Double-click the green HTC Sync icon on your computer to open HTC Sync.
3. Click **Synchronize Now**. (You can also click **Sync Manager > Settings**.)
4. In the Synchronization Settings Wizard, click **Next**.
5. In the next few dialog boxes, choose whether to sync Outlook or Outlook Express, select the type of information to sync (contacts and/or calendar), and choose to sync them automatically or manually with your phone.
6. Click **Finish**.  
HTC Sync then starts to sync your phone and your computer. Wait for the synchronization to finish.
7. A summary report is then displayed. Click **Close**.



## Setting up more sync options

HTC Sync gives you the flexibility to set many options, such as setting a sync schedule, choosing how to resolve conflicts when the same items are found on both the phone and the computer, and more.

1. On your computer, check and make sure the HTC Sync icon  at the bottom-right side of the screen appears in green which means that your phone is connected to HTC Sync.
2. If HTC Sync is not open, double-click the green HTC Sync icon to open it.
3. Click **Sync Manager > Settings**.
4. In the Synchronization Settings Wizard dialog box, click **Manual settings**.
5. From the left side of the Sync Manager Settings dialog box, click the type of setting you want to change, and then choose from the available options on the right. Settings that can be changed include the following:

### Contacts or Calendar folder to sync with

Change this only if you have personal folders created in your Outlook and you need to sync with a personal folder. Click **Contacts** or **Calendar** on the left side of the dialog box, click the **Properties** button, and then choose the personal folder to sync with.

### Calendar events to sync with

Choose the number of days of calendar events to sync. Click **Calendar** on the left side of the dialog box, click **Properties**, and then set the days under **Date range**.

### Conflict policy

In cases when the same contacts and/or calendar items exist in both your phone and your computer, choose whose data you want to keep when a conflict occurs.

### When to sync

Click **Automatic sync** on the left side of the dialog box. Then choose whether to sync manually, auto sync everytime you connect your phone to your computer, or sync at a set schedule.

6. Click **Apply** to save the sync options you've selected, and then click **OK**.

## Synchronizing your phone

After you've installed and set up HTC Sync, you can sync your phone with your computer.

### Synchronizing your phone with your computer automatically

Do the following first to make sure your phone will sync automatically with your computer:

1. Press **HOME > MENU**, and then tap **Settings > Applications > Development**.
2. Make sure the **USB debugging** check box is selected.

Whenever you connect your phone to your computer, synchronization starts automatically. Wait for the sync process to finish.

## Synchronizing your phone with your computer manually

1. Connect your phone to the computer with the supplied USB cable. Or, if your phone is already connected, press and hold the status bar and drag your finger down to open the Notifications panel. Then tap the status that shows “Select to change USB connection type”.
2. On the Connect to PC screen in your phone., tap **HTC Sync** and then tap **Done**.
3. On your computer, check and make sure that the HTC Sync icon  at the bottom-right side of the screen appears in green which means that your phone is connected to HTC Sync.
4. On your phone, tap **Sync now**.

## Downloading the latest HTC Sync upgrade

Visit the HTC support website ([www.htc.com/support](http://www.htc.com/support)) from time to time to check for the most recent HTC Sync upgrade so you can download and install it on your computer.

After installing the latest upgrade, set up HTC Sync again to recognize and sync with your phone. Follow the steps in “Setting up HTC Sync to recognize your phone” and “Setting up synchronization”.

## Installing apps from your computer to your phone

If you have applications (.apk files) on your computer, you can use HTC Sync to install them to your phone. We strongly recommend you install only applications that you trust.

1. On your phone, press HOME > MENU, tap **Settings > Applications**, and then select the **Unknown sources** check box to allow applications from your computer to be installed to your phone.



You only have to do this step once. You do not need to do this step again next time you install another application from your computer to your phone.

2. Connect your phone to the computer with the supplied USB cable. Or, if your phone is already connected, press and hold the status bar and drag your finger down to open the Notifications panel. Then tap the status that shows “Select to change USB connection type”.
3. On the Connect to PC screen in your phone., tap **HTC Sync** and then tap **Done**.
4. On your computer, double-click the green HTC Sync icon  to open HTC Sync.
5. In HTC Sync, click **Application Installer**.
6. In the Application Installer file types dialog box, make sure that the **Android OS installer file (apk)** check box is selected and then click **OK**.



This dialog box only appears the first time you use the Application Installer.

7. Click **Next**.
8. Click **Browse**, locate the application (.apk) on your computer, and then click **Open**.
9. After selecting the application, click **Next**.
10. Click **Finish**. Check your phone’s screen to see if there are additional instructions to complete the installation.

# Social

## Facebook for HTC Sense and Facebook for Android application

---

### Facebook for HTC Sense

View your Facebook® updates in supported applications on the phone. By signing in to Facebook for HTC Sense, your Facebook contacts and their contact details are downloaded to People, you can browse through Facebook photo albums in Photos, and read Facebook status updates in Friend Stream. To learn how to sign in to Facebook for HTC Sense, see the Accounts and sync chapter.



People



Friend Stream

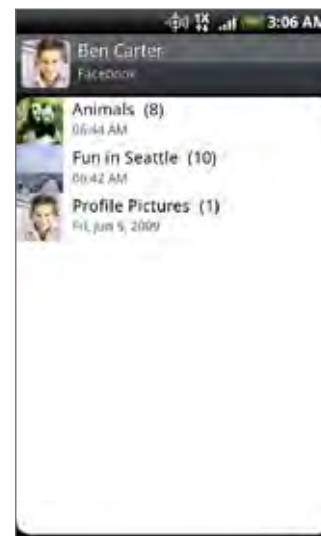

Photos

### Facebook for Android application

The Facebook application on your phone lets you keep up and stay close with your friends in Facebook. It offers most of the features that you are familiar with when using Facebook on your computer.



If you have more than one Facebook account, you can sign in to the Facebook application using your other Facebook account.

### Using the Facebook application

1. Press HOME, and then tap  > Facebook.
2. If this is your first time to use Facebook, follow the onscreen instructions to sign in to your Facebook account.
3. On the News Feed screen, press MENU, and then tap Home to access the other functions.



- While on the Facebook home screen, press MENU, and then tap Settings to set refresh and notification options.
- On some Facebook screens, you can press and hold an item to open an options menu.

### With the Facebook application, you can:

- Share your thoughts and check other people's status updates.
- View your friends list and write on someone's wall.
- Comment on a friend's post.
- View someone's personal information, including photo albums.
- Check your Facebook notifications.
- Take a photo and upload it straight to your Facebook account.

### Adding the Facebook widget

Add the Facebook widget to the Home screen to let you quickly share your thoughts and view your friends' status updates.



The widget will only link to the Facebook account that you logged into on the Facebook application.

1. Press HOME, and then tap  > Widget > Facebook.
2. Choose the widget style, and then tap **Select**.
3. Drag the widget to a blank space on the Home screen, and then release.

### Differences between Facebook for HTC Sense and Facebook for Android application

- Facebook for HTC Sense is not a standalone application. It is integrated into People, Friend Stream, and Photos to give you up-to-date information about your Facebook contacts (their status updates and new photos) in these applications.
- The Facebook for Android application is a standalone application. Use this application to do most of the things that you would do when you're using your computer's web browser to access your Facebook account, such as adding a friend and adding captions to photos you upload.
- The two do not share the same login credentials. Signing in to Facebook for HTC Sense does not sign you in to the Facebook application and vice versa. If you want to use the same Facebook account for both, you'll have to sign in to both using the same login credentials.

## Twittering on your phone

Peep is a Twitter™ client that lets you enjoy “twittering” on your phone. Send out tweets, read and receive tweets from people, search for new Twitter users to follow, all from your phone.



1. Press HOME, and then tap  > Peep.
2. If you did not sign in to your Twitter account when you first turned on the phone, follow the onscreen instructions to sign in to your Twitter account.
3. Peep opens in the **All Tweets** tab. Slide your finger on the bottom row to go to the tab you want.

### Peep screen





- 
- 1 Tap to view the Twitter user's profile. This also shows you all tweets from this Twitter user.
  - 2 Tap to enter a tweet to send out.
  - 3 Press and hold to open the options menu to let you reply, send a direct message, retweet, add to favorite, and view the profile.
- 
- 4 Shows all the tweets from people you follow and tweets that you have sent out.
  - 5 Shows all tweets that mentions your username using the “@[your username]” convention.
  - 6 Shows all private/direct messages that you have received or sent out.
  - 7 Shows tweets that were marked as favorites.
- 

### Sending a tweet

1. Press HOME, and then tap  > Peep.
2. On the **All Tweets** tab, tap the text field with the words “What's happening?”.
3. Enter your tweet, and then tap **Update**. Before tapping **Update**, you can:
  - Tap  to post a picture from Photos or Camera to your default photo hosting site and add the link to the picture into the tweet.
  - Tap  to insert your location into the tweet. You can choose to add a map link, insert your location name, or insert your position coordinates.

## Searching for Twitter users to follow

1. Press HOME, and then tap  > Peep.
2. While on the Peep screen, press the SEARCH button.
3. Tap the text field with the words "Search Twitter", enter the search criteria, and then tap .
4. On the Search result screen, scroll through the list, and then tap the twitter user you want to follow.



The search results will also list down tweets that contain the search word.

5. Press MENU, and then tap **Follow**.

## Unfollowing a Twitter user

1. Press HOME, and then tap  > Peep.
2. On the **All Tweets** tab, tap Twitter user you want to stop following.
3. Press MENU, and then tap **Unfollow**.

## Sending a direct message

You can only send a direct message to someone who is following you.

1. Press HOME, and then tap  > Peep.
2. Press MENU, and then tap **New message**.



You can also send a direct message from the **All Tweets** or **Direct Message** tab. On the **All Tweets** or **Direct Message** tab, press and hold the person you want to send the direct message to, and then tap **Send direct message** on the options menu.

3. Tap the **To** field, and then enter the name. As you enter characters, the names of the Twitter users that match the characters you enter will appear. Tap the name when you see it.
4. Enter your message, and then tap **Update**.

## Setting Peep options

1. Press HOME, and then tap  > Peep.
2. Press MENU, and then tap **More** > **Settings**. You can set these options:

### Account settings

Sign out of your Twitter account.

### General settings

Choose whether to show the screen name or the real name of the people you follow.

### Send & receive

Set the frequency to check for new tweets and set the number of tweets to download.

### Services

Set your photo hosting site, photo quality, location options, and URL shortening host.

### Notification settings

Select when to be notified and how you want to be notified.

## Adding the Twitter widget

Add the Twitter widget to let you send and follow your tweets right on the Home screen.

1. Press HOME, and then tap  > **Widget** > **Twitter**.
2. Choose the widget style, and then tap **Select**.
3. Drag the widget to a blank space on the Home screen, and then release.

## Using Friend Stream

Streamline your social network accounts through Friend Stream. Update your status simultaneously, view status updates, and look through photo updates from your Facebook, Twitter, and other social network accounts using Friend Stream.

1. Press HOME, and then tap  > Friend Stream.
2. If you are not signed in to a social network account, press MENU, tap **Settings > Accounts & sync**, and then tap the account you want to sign in to.
3. Friend Stream opens in the **All Updates** tab. Slide your finger on the bottom row to go to the tab you want.

### Friend Stream screen



Only updates from accounts that you are signed in to will be shown. You can filter the updates that show in Friend Stream by pressing MENU, and then tapping **Settings > Show updates**.



- 
- 1 Depending on the type, tap to open Peep, post a Facebook comment, look at the Flickr album, or open the link in the web browser.
  - 2 Tap to enter and send a status update.
  - 3 Shows all the messages from the social network accounts that you are signed in to.
  - 4 Shows only status updates from Facebook and Twitter.
  - 5 Shows only photo updates from Facebook and Flickr.
  - 6 Shows only links posted on Facebook.
-



## Updating your status

1. Press HOME, and then tap  > Friend Stream.
2. On the **All Updates** tab, tap the text field with the words “What’s on your mind?”.
3. Tap , and then on the Update Status dialog box, select which accounts you want the status update to be posted. Tap **Done**.



Only the accounts that you are signed in to will be shown on the dialog box.

4. Enter your status update, and then tap **Share**.

## Adding the Friend Stream widget

Add the Friend Stream widget so you can update your status simultaneously and view status updates from your social network accounts right on the Home screen.

1. Press HOME, and then tap  > Widget > Friend Stream.
2. Choose the widget style, and then tap **Select**.
3. Drag the widget to a blank space on the Home screen, and then release.

# Chatting in Google Talk

---

Google Talk is Google's instant messaging program. It lets you communicate with other people that also use Google Talk.

## Signing in to Google Talk

If you signed in to your Google Account when you first set up the phone, you are already signed in to Google Talk.

1. Press HOME, and then tap  > Talk > Next > Sign in.
2. Enter your Google Account username and password, and then tap **Sign in**.

When you are signed in to Google Talk, your online status in Google Talk will also appear in other Google Apps such as Gmail/Google Mail and Google Maps.

## Signing out of Google Talk

If you are not going to use Google Talk for an extended period of time, we recommend that you sign out of Google Talk to save battery power.

1. Press HOME, and then tap  > Talk.
2. In the Friends list, press MENU, and then tap **More > Sign out**.

## Chatting with friends

### Starting a chat

1. Press HOME, and then tap  > Talk.
2. Tap a friend in the Friends list.
3. Chat with your friend by entering text in the text box at the bottom of the screen.



To insert a smiley, press MENU, and then tap **More > Insert smiley**. Tap a smiley to insert it into your message.

4. After entering your message, tap **Send**.

### Accepting an invitation to chat

When a friend sends you a Google Talk message, you receive a notification. Their entry in the Friends list turns white and displays the message.

Do one of the following:

- In the Friends list, tap the friend who sent you the invitation to chat.
- Open the Notifications panel, and then tap the chat notification. See "Opening the Notifications panel" in the Basic chapter to learn how to open the Notifications panel.

### Returning to the Friends list

While on a chat screen, press MENU, and then tap **Friends list**.

## Switching between active chats

You can switch between chats if you have more than one chat going.

1. While on a chat screen, press MENU, and then tap **Switch chats**.
2. On the screen that opens, tap the friend you want to chat with.

## Inviting a friend to join a group chat

1. While on a chat screen, press MENU, and then tap **Add to chat**.
2. Tap the friend you want to invite. The friend you invited and the current participants receive an invitation to a group chat. Each one who accepts the invitation joins the group chat.

## Chatting on or off the record

Your Google Talk messages are stored, so you can review them later and even search for them in the Chats folder in Gmail/Google Mail. But, if you'd rather not store the messages in a chat, you can go off the record.

1. On a chat screen, press MENU, and then tap **Chat off record**.
2. To resume saving the messages in the chat, press MENU, and then tap **Chat on record**.



## Ending a chat

Do one of the following:

- In the Friends list, press and hold the friend you want to stop chatting with, and then in the menu that opens, tap **End chat**.
- While on a chat screen, press MENU, and then tap **End chat**.

## Changing your online status and picture



### Changing your online status

1. Press HOME, and then tap  > Talk.
2. In the Friends list, tap the online status icon (  ) beside your name, and then select the status you want on the options menu.

In addition to the standard status settings described in the table, you can also select a message that you've entered previously. Or tap **Clear custom messages** to erase them and start over.

Your status and any message appear in your contact's Friends lists and in other locations where your status or status message are displayed.

### Changing your status message

1. Press HOME, and then tap  > Talk.
2. In the Friends list, tap the text box to the left of your online status icon, and then enter your status message.
3. On the onscreen keyboard, tap .

## Changing your picture

1. Press HOME, and then tap  > Talk.
2. In the Friends list, tap the picture to the left of your status message.
3. In the Select an album screen, tap the album where the picture you want to use is located.
4. Tap the picture you want to use.
5. Drag the green box to select the portion of the picture to crop, and then tap **Save**.

## Managing your Friends list

### Adding a friend

You can invite anyone with a Google Account to become your friend in Google Talk, so you can chat with each other and view each others' online status.

1. Press HOME, and then tap  > Talk.
2. In the Friends list, press MENU and then tap **Add friend**.
3. Enter the Google Talk instant messaging ID or Google email address of the friend you want to add.

### Accepting an invitation to become a friend

When a contact invites you to become a friend in Google Talk, you receive a notification in the Status bar and the invitation appears in your Friends list.

1. Press HOME, and then tap  > Talk.
2. In the Friends list, tap **Chat invitation**.
3. Do one of the following:
  - Tap **Accept** in the menu that opens to accept the invitation.
  - Tap **Cancel** if you don't want to chat with and share your Google Talk status with the sender.

### Viewing the list of pending invitations to friends

1. Press HOME, and then tap  > Talk.
2. In the Friends list, press MENU, and then tap **Invites**. All the friends to whom you've extended invitations to become friends on Google Talk appear in the list until they accept or cancel your invitation.
3. Tap a pending invitation, and then tap **Accept** or **Decline**.

### Viewing all friends or only those most popular with you

By default, only the friends that you frequently chat with — the most popular — are shown in the Friends list. But you can view all friends instead.

1. Press HOME, and then tap  > Talk.
2. In the Friends list, press MENU, and then tap **All friends**. To switch back to just the friends with whom you chat most frequently, tap **Most popular** in the menu.

## Making a friend popular

1. Press HOME, and then tap  > Talk.
2. In the Friends list, press and hold a friend's name.



If you cannot see the friend, press MENU, and then tap **All friends**.

3. In the options menu, tap **Always show friend**.

## Blocking a friend

You can block a friend from sending you messages. When blocked, your friend is also removed from your Friends list.

1. Press HOME, and then tap  > Talk.
2. In the Friends list, press and hold the friend's name you want to block.



If you cannot see the friend, press MENU, and then tap **All friends**.

3. In the options menu, tap **Block friend**. Your friend is removed from your friends list and is added to the blocked friends list.





To unblock a friend, in the Friends list, press MENU and then tap **Blocked**. In the Blocked friends list, tap the name of the friend you want to unblock, and then tap **OK** when prompted.

## Changing Google Talk settings

### Setting notifications for new Google Talk messages

You can set the phone to play a sound, vibrate, or display a notification icon in the status bar each time you receive a new instant message.

1. Press HOME, and then tap  > Talk.
2. In the Friends list, press MENU and then tap **More > Settings**.
3. Select the **IM notifications** check box to receive a notification (  ) in the status bar when a new instant message arrives.
4. Do one of the following:
  - Tap **Select ringtone** to select the ringtone to use when a new instant message arrives. The ringtone briefly plays when selected. If you don't want a ringtone to play when you receive a new Google Talk message, select **Silent**.
  - Select the **Vibrate** check box to vibrate your phone when you receive a new Google Talk message.

## Showing or hiding the mobile indicator to friends

You can check what type of device your friend is using to chat in Google Talk. In the friends list, check the image that appears to the right of your friend's name.

1. Press HOME, and then tap  > Talk.
2. In the Friends list, press MENU, and then tap **More > Settings**.
3. Select the **Mobile indicator** option.

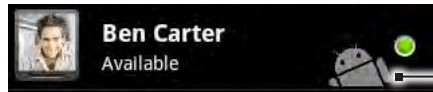

Indicates that the friend is using an Android phone.

## Setting whether you sign into Google Talk automatically

You can sign in to your Google Talk account automatically every time you turn on your phone.

1. Press HOME, and then tap  > Talk.
2. In the Friends list, press MENU, and tap **More > Settings**.
3. Select the **Automatically sign in** check box.

# Email

## Using Gmail/Google Mail

---

Gmail/Google Mail is Google's web-based email service. Gmail/Google Mail is configured when you first set up your phone. Depending on your synchronization settings, Gmail/Google Mail on your phone is automatically synchronized with one or more Gmail/Google Mail accounts on the web. For more information about synchronization, see "Synchronizing with a Google Account" in the Accounts and sync chapter.

### Viewing your Gmail/Google Mail inbox

The Inbox conversations list is your default Gmail/Google Mail view. All your received email messages are delivered to your Inbox.

Gmail/Google Mail groups each message you send with all the responses you receive. This conversation list continues to grow as new replies arrive, so you can always see your messages in context. A new message or a change to the subject of a current message will begin a new conversation.

1. Press HOME, and then tap  > Gmail/Google Mail.
2. To scroll through the conversation list, swipe your finger up/down on the screen or the optical joystick.

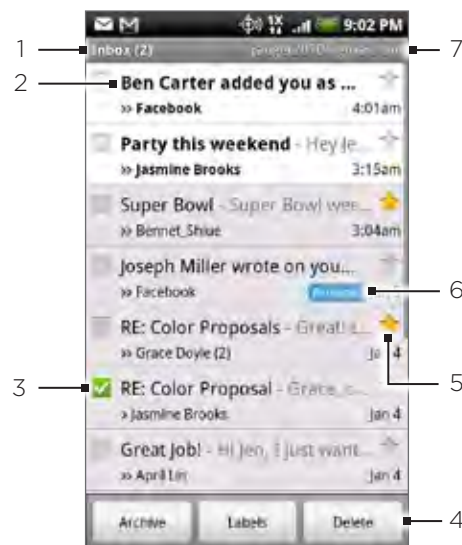

- 
- 1 Folder (or Label) and number of unread email messages.
  - 2 Unread messages are displayed in bold.
  - 3 Checked email. Select one or more emails to apply an action.  
Note: Batch operations needs to be enabled.
  - 4 Actions for checked email(s). This will not show if there is no item selected in the inbox.
  - 5 Starred message. Tap to add or remove the star. For more information, see "Starring a message" in this chapter.
  - 6 Message label.
  - 7 The Google Account you are currently viewing. To view another account, see "Switching to another Google Account" below.
-

## Switching to another Google Account

If you have set up more than one Google Account on your phone, you can switch between accounts in Gmail/Google Mail. For more information on setting up Google Accounts, see “Synchronizing with a Google Account” in the Accounts and sync chapter.

1. While viewing the Inbox, deselect any checked email messages.
2. Press MENU, and then tap **Accounts**.
3. Tap the account to switch to.

## Reading your messages

Depending on your notification settings, the phone plays a ringtone, vibrates, or displays the email message briefly in the status bar when you receive a new email. A new email message icon  also appears on the notifications area of the status bar to notify you of a new email. For more information on email notification settings, refer to “Changing Gmail/Google Mail settings” later in this chapter.

For information on automatic email synchronization, see “Changing Gmail/Google Mail synchronization settings” in this chapter.



To refresh your inbox manually, press MENU and then tap **Refresh**.

1. Do one of the following:
  - When you receive a new email notification, press and hold the status bar, and then slide your finger down on the screen to open the Notifications panel. Tap the new email to view it.
  - While in the Inbox, tap the unread email or the conversation with the unread email to view it.
2. To scroll through the messages in the conversation, swipe your finger up/down on the screen or the optical joystick.

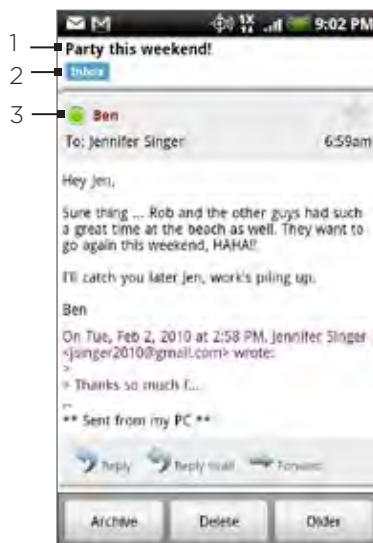

- 
- 1 Message subject.
  - 2 Message label.
  - 3 Online status. Appears when the contact is a Google Talk friend and you are signed in to Google Talk.
-



3. To manage the email message or conversation, do any of the following:

- Tap **Archive** to remove the conversation from your Inbox while still keeping it stored in your Google Account.



To display your archived messages, in the Inbox, press MENU and then tap **View labels > All Mail**.

- Tap **Delete** to delete the conversation from your Google Account. If you delete the conversation accidentally, you can tap **Undo** in the yellow bar at the top of the screen to undelete it.
- Tap **Older** to see the previous conversation in your Inbox.
- Press MENU to see more options.

### Replying to or forwarding an email message

1. In the message thread, scroll down to the end of the conversation.
2. Tap **Reply**, **Reply to all**, or **Forward**.



3. Do one of the following:

- If you selected **Reply** or **Reply to all**, enter your reply message.
- If you selected **Forward**, specify the message recipients.

4. Tap **Send**.

### Muting a conversation

If you're part of a long message conversation that isn't relevant, you can 'mute' the conversation to keep all future additions out of your Inbox.

While viewing the message thread, press MENU and then tap **More > Mute**.

### Reporting a conversation as spam

The Gmail/Google Mail webmail service works hard to prevent spam (unwanted and unsolicited "junk" mail) from reaching your Inbox. But when spam makes it through, you can help improve the service by reporting the conversation as spam.

While viewing the message thread, press MENU, and then tap **More > Report spam**.

## Sending a message

1. Press HOME, and then tap  > Gmail/Google Mail.
2. In the Inbox, press MENU and then tap **Compose**.
3. Enter the message recipient's email address in the **To** field. If you are sending the email to several recipients, separate the email addresses with a comma. You can add as many message recipients as you want.  
As you enter email addresses, any matching addresses from your contacts list are displayed. Tap a match to enter that address directly.

 If you want to send a carbon copy (Cc) or a blind carbon copy (Bcc) of the email to other recipients, press MENU and then tap **Add Cc/Bcc**.

4. Enter the email subject, and then compose your email.
5. If you want to add a picture attachment, press MENU and then tap **Attach**. Navigate to the picture you want to attach, and then tap the picture.

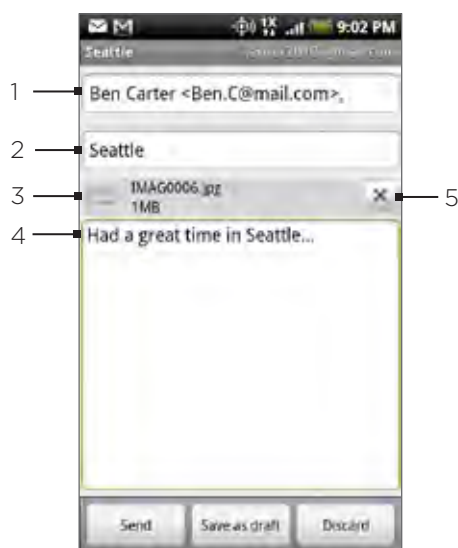

- 
- 1 Recipient.
  - 2 Subject.
  - 3 Attachment.
  - 4 Enter your message here.
  - 5 Tap to remove the attachment.
- 



6. After composing your message, tap **Send**.

 While composing the message, tap **Save as draft** or press the BACK button to save it as a draft. To view your draft email messages, in the Inbox, press MENU and then tap **View labels > Drafts**.

## Adding a signature to your messages

You can add a signature to email messages that you send.

1. In the Inbox, press MENU and then tap **Settings > Signature**.
2. Enter your signature in the text box, and then tap OK.

 You can create a signature consisting of multiple lines of text. At the end of each line of text, tap  on the onscreen keyboard to create another line.

## Viewing your sent messages

In the Inbox, press MENU and then tap **View labels > Sent**.

## Managing conversations and messages

### Searching for messages

You can search for messages that contain one or more words in their contents or in their addresses, subjects, labels, and so on. When you search for messages, all of the messages in your Gmail/Google Mail account on the web are included (except those labeled Trash or Spam), not just those that you've synchronized onto your phone.

1. In the Inbox, press SEARCH.
2. Enter the word or words to search for.
3. Tap , or tap the Enter key on the onscreen keyboard.

A conversation list opens, displaying all of the conversations with messages that contain the words you searched for. The words you searched for are displayed in the title bar. You work with the conversations in this list just as you would with the conversations in your Inbox or any other conversation list.

### Starring a message

You can star an important message so that you can easily find it again. Conversations with starred messages are displayed with a star in your Inbox and other conversation lists. To view just conversations with starred messages, see “Viewing conversations by label” in this chapter.

Do one of the following:

- While reading a message, touch the star in its header.
- When viewing a conversation, touch its star to start the newest message in the conversation.

To unstar a message, touch its star again. You can also touch a star in a conversation list to unstar all messages in the conversation.

### Labeling a conversation

You can organize conversations by labeling them. Gmail/Google Mail has several preset labels you can use, and you can also add your own labels, using Gmail/Google Mail on the web.

1. While viewing the messages in a conversation, press MENU and then touch **Change labels**.
2. Select the labels that you want to assign to the conversation, and then tap **OK**.

### Viewing conversations by label

You can view a list of the conversations that have the same label.

1. When viewing your Inbox or another conversation list, press MENU, and then touch **View labels**.
2. Touch a label to view a list of conversations with that label.

The conversation list resembles your Inbox, but the label replaces “Inbox” in the title bar. You work with labeled conversations lists in the same way as with your Inbox.

## Changing Gmail/Google Mail synchronization settings

1. Press HOME, and then tap  > Gmail/Google Mail.
2. Press MENU, and then tap Settings > Labels.
3. To set the number of days to synchronize, tap Number of days to sync.
4. To set synchronization for a particular label, tap the label. You can select to synchronize the default number of days, or you can sync all or none of the label's messages.

## Working with conversations in batches

You can archive, label, delete, or perform other actions on a batch of conversations at once, in your Inbox or in another labeled list of conversations.

1. In the Inbox or other conversation list, select the check boxes for the conversations you want to work with as a batch. When you select a check box, the **Archive**, **Labels**, and **Delete** buttons are displayed at the bottom of the screen.

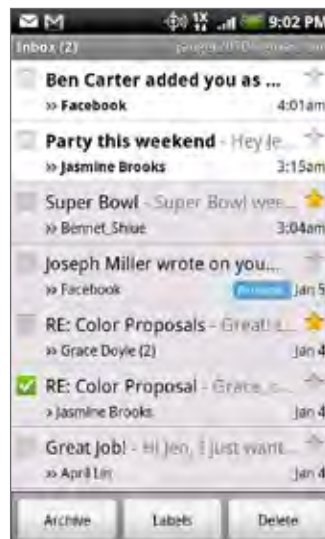

2. Tap the Archive, Labels, or Delete button to perform one of those actions on the batch of conversations, or press MENU for more options.

## Changing Gmail/Google Mail settings



1. Press HOME, and then tap  > Gmail/Google Mail.
2. In the Inbox, press MENU and then tap **Settings**.
3. Set the following options:
  - **Signature.** Tap to enter a signature that is appended at the end of your emails.
  - **Confirm delete.** Select the check box to show a confirmation box when you delete a conversation.
  - **Batch operations.** When selected, this adds a check box to the left of each conversation so you can add it to a batch. See “Working with conversations in batches” above.
  - **Clear search history.** Remove the searches you have performed.
  - **Labels.** Tap to select how many days and which Gmail/Google Mail labels to synchronize.
  - **Email notifications.** Select the check box to show a notification icon on the status bar when you receive a new email.
  - Tap **Select ringtone** if you want your phone to play a notification sound when a new email message arrives. On the ringtone menu, select a ringtone specific to new email messages. The ringtone plays briefly when selected. If you don't want a ringtone to play when you receive a new email message, tap **Silent**. To confirm your ringtone selection, tap **OK**.
  - Select **Vibrate** if you want your phone to vibrate when you receive a new email message.

# Mail

The Mail application lets you send and receive email from your webmail or other accounts, using POP3 or IMAP.

It also lets you access your Exchange ActiveSync email and other features on your phone. For information on this, see “Exchange ActiveSync email” in this chapter.

## Adding a POP3/IMAP email account

1. Press HOME, and then tap  > Mail.
2. Do one of the following:
  - If this is your first time to add an email account in Mail, tap **Other (POP3/IMAP)** on the **Choose a mail provider** screen.
  - If you have already added an email account in Mail, tap  on the upper-left corner, and then tap **New Account**. If the **Choose a mail provider** screen is displayed, tap **Other (POP3/IMAP)**.
3. Enter the **Email address** and **Password** for the email account and then tap **Next**.  
If the account type you want to set up is not in the phone database, you will be asked to enter more details.
4. Enter the **Account name** and **Your name** and then tap **Finish setup**.

## Viewing your email inbox

1. Press HOME, and then tap  > Mail.
2. Tap a tab at the bottom of the screen to filter the inbox.



- 
- 1 Tap to view a different email account or add a new email account.
  - 2 Filter tabs. See “Inbox filter tabs” for details.
  - 3 Marked (Exchange ActiveSync only)
  - 4 Meeting invitation (Exchange ActiveSync only)
  - 5 Number of unread email messages.
-