

# ***User Guide***

**hTC EVO™ 4G**

***[www.sprint.com](http://www.sprint.com)***

*©2010 Sprint. SPRINT and the logo are trademarks of Sprint.  
Other marks are the property of their respective owners.*

*4/19/10*



**Note:** Para encontrar esta guía para usuarios en español, por favor visita a [www.sprint.com](http://www.sprint.com) y haz clic en **Support > Phones & Devices**.

---

To find this user guide in Spanish, please visit [www.sprint.com](http://www.sprint.com) and click **Support > Phones & Devices**.

**Important Privacy Message** – Sprint's policies often do not apply to third-party applications. Third-party applications may access your personal information or require Sprint to disclose your customer information to the third-party application provider. To find out how a third-party application will collect, access, use, or disclose your personal information, check the application provider's policies, which can usually be found on their website. If you aren't comfortable with the third-party application's policies, don't use the application.

# Table of Contents

---

**Tip:** Looking for something? If you don't see it in the headings listed here, try the **Index** on page 185.

Introduction .....	i
Your Device's Menu .....	i
<b>Section 1: Getting Started</b> .....	<b>1</b>
<b>1A. Setting Up Service</b> .....	<b>2</b>
Setting Up Your Device .....	2
Activating Your Device .....	2
Setting Up Your Voicemail .....	3
Sprint Account Passwords .....	3
Getting Help .....	4
<b>Section 2: Your Device</b> .....	<b>5</b>
<b>2A. Device Basics</b> .....	<b>6</b>
Your Device .....	6
Turning Your Device On and Off .....	8
Viewing the Display Screen .....	9
Battery and Charger .....	12
Getting Around Your Device .....	13
Displaying Your Phone Number .....	14
Making and Answering Calls .....	15
Speed Dialing .....	19
Dialing Sprint Services .....	19
Entering Text .....	19
Home Screen .....	22
<b>2B. Settings</b> .....	<b>26</b>
Personalization Settings .....	26
Sound Settings .....	27
Display Settings .....	29
Location Settings .....	30
Messaging Settings .....	31
Airplane Mode .....	32
TTY Use With Sprint Service .....	32
Security Settings .....	33
Data Synchronization Settings .....	34
Social Network Settings .....	35
Application Settings .....	36

Date & Time Settings .....	37
Locale & Text Settings .....	37
Power-Saving Tips .....	37
<b>2C. History .....</b>	<b>39</b>
Viewing History .....	39
Making a Call From History .....	39
Saving a Number From History .....	40
Prepending a Number From History .....	40
Erasing History .....	40
<b>2D. People .....</b>	<b>41</b>
About People .....	41
Using the People Screen .....	42
Adding a New People Entry .....	43
Saving a Phone Number .....	44
Using the Contact Details Screen .....	44
Merging Entries in People .....	45
Editing an Entry in People .....	45
Finding Entries in People .....	47
Backing Up and Importing Entries in People .....	48
Working with Groups .....	48
Using the People Widget .....	49
Connecting with Your Social Networks .....	50
Using Friend Stream .....	52
<b>2E. Calendar and Tools .....</b>	<b>54</b>
Calendar .....	54
Calculator .....	59
Clock .....	59
Quickoffice .....	63
PDF Viewer .....	64
HTC Sync .....	65
Updating Your Device .....	68
<b>2F. Voice Services .....</b>	<b>69</b>
Automatic Speech Recognition (ASR) .....	69
Managing Voice Memos .....	70
<b>2G. microSD Card .....</b>	<b>72</b>
Your Device's microSD Card .....	72
Using the Device's microSD Card as a USB Drive .....	74
<b>2H. Camera and Multimedia .....</b>	<b>75</b>
Taking Pictures and Shooting Videos .....	75
Viewing Pictures and Videos Using Gallery .....	81
Sharing Live Videos with Qik .....	88
Listening to Music .....	88
Listening to the Radio .....	92

2I. Bluetooth .....	94
Using Bluetooth .....	94
<b>Section 3: Sprint Service .....</b>	<b>99</b>
<b>3A. Sprint Service: The Basics .....</b>	<b>100</b>
Voicemail .....	100
Text Messaging (SMS) and Multimedia Messaging (MMS) .....	102
Caller ID .....	108
Call Waiting .....	108
Making a 3-Way Call .....	108
Call Forwarding .....	108
Roaming .....	109
<b>3B. Web and Data Services .....</b>	<b>111</b>
Ways of Connecting to the Internet .....	111
Connecting Using Wi-Fi .....	111
Connecting Using Sprint 4G .....	113
Getting Started With Data Services .....	114
Connecting to a Virtual Private Network (VPN) .....	115
Using the Device's Web Browser .....	116
Accessing Email Messages .....	122
Google Talk .....	131
Downloading Applications and Games From Android Market .....	136
Peep .....	138
Stocks .....	140
Weather .....	141
News Feeds .....	143
Sprint Mobile Hotspot .....	145
Using Your Device as a Modem (Internet Sharing) .....	147
Data Services FAQs .....	147
<b>3C. Entertainment: TV and Music .....</b>	<b>148</b>
TV .....	148
Music - MP3 Store .....	150
Streaming Music .....	150
YouTube .....	151
NASCAR Sprint Cup Mobile .....	152
<b>3D. GPS Navigation .....</b>	<b>155</b>
GPS Services .....	155
Sprint Navigation .....	155
Google Maps .....	156
Google Latitude .....	160
Footprints .....	163

<b>Section 4: Safety and Warranty Information</b> .....	<b>165</b>
<b>4A. Important Safety Information</b> .....	<b>166</b>
Important Health Information and Safety Precautions .....	166
General Precautions .....	170
Additional Safety Information .....	172
<b>4B. Regulatory Notices</b> .....	<b>176</b>
Regulatory Agency Identifications .....	176
Federal Communication Commission Interference Statement .....	176
SAR Information .....	178
Telecommunications & Internet Association (TIA) Safety Information .....	179
WEEE Notice .....	180
RoHS Compliance .....	180
<b>4C. Manufacturer's Warranty</b> .....	<b>181</b>
Manufacturer's Warranty .....	181
Privacy Restrictions .....	182
Weather Disclaimer .....	183
Warranty Disclaimer .....	183
Limitation of Damages .....	183
<b>4D. Copyright, Trademark, and Proprietary Notices</b> .....	<b>184</b>
<b>Index</b> .....	<b>185</b>

## Introduction

---

This **User Guide** introduces you to Sprint® service and all the features of your new device. It's divided into four sections:

- ◆ Section 1: Getting Started
- ◆ Section 2: Your Device
- ◆ Section 3: Sprint Service
- ◆ Section 4: Safety and Warranty Information

**WARNING:** Please refer to the **Important Safety Information** section on page 166 to learn about information that will help you safely use your device. Failure to read and follow the Important Safety Information in this device guide may result in serious bodily injury, death, or property damage.

## Your Device's Menu

---

The following table outlines your device's main menu structure. From the Home screen, press  to open the menu.

<b>All apps</b>
<b>Scenes</b>
1: Sprint Scene
2: HTC
3: Social
4: Work
5: Play
6: Travel
7: Clean Slate
<b>Add to Home</b>
1: Widget
2: Program
3: Shortcut
1: Bookmark      2: Direct Dial      3: Direct Message      4: Directions & Navigation 5: Gmail label      6: Mail Inbox      7: Music playlist      8: Person 9: Settings
4: Folder
1: New Folder      2: All People      3: Bluetooth Received      4: Facebook Phonebook 5: Phones      6: Starred
<b>Wallpaper</b>
<b>Notifications</b>
<b>Settings</b>
1: Personalize
1: Scenes
2: Home wallpaper
3: Default ringtone
2: Wireless & networks
1: Airplane mode
2: Wi-Fi
3: Wi-Fi settings
1: Wi-Fi      2: Network notification      3: Add Wi-Fi network

<b>4: Bluetooth</b>
<b>5: Bluetooth settings</b>
1: Bluetooth    2: Device name    3: Discoverable    4: Advanced Settings 5: Scan for devices
<b>6: Sprint Hotspot</b>
<b>7: Sprint Hotspot settings</b>
<b>8: 4G</b>
<b>9: 4G settings</b>
1: 4G    2: Network notification    3: Network provider    4: Signal strength 5: IP address
<b>10: VPN settings</b>
1: Add VPN
<b>11: Mobile network</b>
<b>12: Mobile networks</b>
1: Data roaming    2: Data Roam Guard    3: Data roaming sound    4: Enable always-on mobile data 5: Roaming    6: Call guard
<b>13: Internet sharing</b>
<b>3: Call</b>
<b>1: Voicemail service</b>
<b>2: Voicemail settings</b>
<b>3: Clear voicemail notification</b>
<b>4: TTY mode</b>
1: TTY Off    2: TTY Full    3: TTY HCO    4: TTY VCO
<b>5: Hearing aids</b>
<b>6: Phone settings</b>
1: Edit default message    2: Edit message    3: Save to contacts
<b>7: DDTM mode</b>
<b>8: Voice Privacy</b>
<b>9: Automatic prepend</b>
<b>10: Plus code dialing</b>
1: North American dialing    2: International dialing
<b>4: Sound &amp; display</b>
1: Sound profile    2: Ringer volume    3: Media volume    4: Phone ringtone 5: Phone vibrate    6: Notification sound    7: Quiet ring on pickup    8: Audible touch tones 9: Audible selection    10: Haptic feedback    11: SD card notifications    12: Roaming ringtone 13: Emergency tone    14: Orientation    15: Animation    16: Brightness 17: Screen timeout    18: Notification flash    19: G-Sensor calibration
<b>5: Accounts &amp; sync</b>
<b>1: Background data</b>
<b>2: Auto-sync</b>
<b>3: Exchange ActiveSync (if you have set up an Exchange ActiveSync email account)</b>
1: Account settings    2: Schedule    3: Mail    4: Contacts 5: Calendar
<b>4: Facebook for HTC Sense (if you have logged in to your Facebook account)</b>
1: Account settings    2: Sync Contacts
<b>5: Google (if you have set up a Google Account)</b>
1: Sync Contacts    2: Sync Gmail    3: Sync Calendar
<b>6: Twitter (if you have logged in to your Twitter account)</b>
1: Account settings    2: Sync Peep    3: Sync Friend
<b>7: Weather</b>
1: Account settings    2: Sync weather data
<b>6: Location</b>
1: Use wireless networks    2: Location setting    3: Use GPS satellites
<b>7: Search</b>
1: Google search settings    2: Searchable items    3: Clear search shortcuts



<b>8: Privacy</b>			
1: Use My Location	2: Factory data reset		
<b>9: Connect to PC</b>			
1: Default connection type 2: Ask me			
<b>10: Security</b>			
1: Set unlock pattern			
2: Require pattern			
3: Use visible pattern			
4: Use tactile feedback			
5: Visible passwords			
6: Set password			
7: Use secure credentials			
8: Install from SD card			
9: Clear storage			
<b>11: Applications</b>			
1: Unknown sources	2: Manage applications	3: Running services	4: Development
<b>12: SD &amp; phone storage</b>			
1: Total space	2: Available space	3: Unmount SD card	4: Format SD card
5: Available space			
<b>13: Date &amp; time</b>			
1: Automatic	2: Set date	3: Select time zone	4: Set time
5: Use 24-hour format 6: Select date format			
<b>14: Language &amp; keyboard</b>			
1: Select locale			
2: Touch Input			
1: Keyboard types	2: Keyboard language	3: Text input	4: Tutorial
5: User Dictionary			
<b>15: Accessibility</b>			
<b>16: Text-to-speech</b>			
1: Listen to an example	2: Install voice data	3: Always use my settings	4: Speech rate
5: Language			
<b>17: System updates</b>			
1: Firmware update	2: Update profile	3: Update PRL	4: HTC software update
<b>18: About phone</b>			
1: Network			
1: Operator name	2: Signal strength	3: Mobile network type	4: Service state
5: Roaming 6: Current username			
2: Phone identity			
1: Model number	2: MEID	3: Phone number	4: IMSI
3: Battery			
1: Battery status	2: Battery level	3: Battery use	4: Up time
5: Awake time			
4: Hardware information			
1: Hardware version	2: Wi-Fi MAC address	3: Bluetooth address	4: 4G MAC address
5: Software information			
1: Firmware version	2: Baseband version	3: Kernel version	4: Build number
5: Software number 6: Browser version 7: PRL Version 8: PRL Version			
6: Legal information			
1: HTC legal	2: Sprint legal	3: Google legal	4: Open source licenses

**Tip:** For most programs or games on the device, pressing  brings up options available for the application or game.



*Section 1*  
***Getting Started***



## 1A. Setting Up Service

- ◆ Setting Up Your Device (page 2)
- ◆ Activating Your Device (page 2)
- ◆ Setting Up Your Voicemail (page 3)
- ◆ Sprint Account Passwords (page 3)
- ◆ Getting Help (page 4)

### Setting Up Your Device

---

#### 1. Install the battery:



- Insert your fingernail into the slot at the top left of the battery compartment cover and lift gently to remove.
- Align the battery's exposed copper contacts with the battery connectors inside the battery compartment.
- Insert the contact end of the battery first then gently push the battery into place.
- Replace the back cover making sure all the locking tabs are seated and there are no gaps around the cover.

#### 2. Press ( ) to turn the device on (black button located at the top of the device and on the right).

**Note:** When you turn on your device for the first time, you will be given options to let you quickly set up various accounts, such as Google™ account, Facebook™, Flickr®, Twitter™, Microsoft® Exchange ActiveSync, and other email accounts. We recommend that you skip these.

- If your device is activated, it will turn on, search for Sprint service, and enter standby mode.
- If your device is not yet activated, see “Activating Your Device” on page 2 for more information.

#### 3. Make your first call.

- Tap .
- Use the onscreen keypad to enter a phone number.
- Tap .

**Note:** Your device's battery should have enough charge for your device to turn on and find a signal, set up your voicemail, and make a call. You should fully charge your battery as soon as possible. See “Charging the Battery” on page 13 for details.

### Activating Your Device

---

- **If you purchased your device at a Sprint Store**, it is probably activated and ready to use.
- **If you received your device in the mail and it is for a new Sprint account or a new line of service**, it is designed to activate automatically. To confirm your activation, make a phone call.
- **If you received your device in the mail and you are activating a new device for an existing number on your account**, you will need to go online to activate your new device.
  - From your computer's Web browser, go to [www.sprint.com/activate](http://www.sprint.com/activate) and complete the onscreen instructions to activate your device.



When you have finished, make a phone call to confirm your activation. If your device is still not activated or you do not have access to the Internet, contact Sprint Customer Service at **1-888-211-4727** for assistance.

**Tip:** Do not press  while the device is being activated. Pressing  cancels the activation process.

**Note:** If you are having difficulty with activation, contact Sprint Customer Service by dialing **1-888-211-4727** from any other phone.

## Setting Up Your Voicemail

Your device automatically transfers all unanswered calls to your voicemail, even if your device is in use or turned off. You should set up your Sprint Voicemail and personal greeting as soon as your device is activated.

1. Press  and tap  > **Voicemail**.
2. In the Personalize your Voicemail window, tap **Personalize now**.
3. Your device will automatically connect with Sprint Voicemail service. Follow the voice prompts to:
  - Create your passcode.
  - Record your name announcement.
  - Record your greeting.

**Note: Voicemail Passcode**

Sprint strongly recommends that you create a passcode when setting up your voicemail to protect against unauthorized access. Without a passcode, anyone who has access to your handset is able to access your voicemail messages.

For more information about using your voicemail, see “Voicemail” on page 100.

## Sprint Account Passwords

As a Sprint customer, you enjoy unlimited access to your personal account information, your voicemail account, and your data services account. To ensure that no one else has access to your information, you will need to create passwords to protect your privacy.

### Account Username and Password

If you are the account owner, you will create an account username and password when you sign on to [www.sprint.com](http://www.sprint.com). (Click **Need to register for access?** to get started.) If you are not the account owner (if someone else receives the bill for your Sprint service), you can get a sub-account password at [www.sprint.com](http://www.sprint.com).

### Voicemail Password

You'll create your voicemail password (or passcode) when you set up your voicemail. See Setting Up Your Voicemail for more information on your voicemail password.

### Data Services Password

With your Sprint device, you may elect to set up an optional data services password to control access and authorize Premium Service purchases.

For more information, or to change your passwords, sign on to [www.sprint.com](http://www.sprint.com) or call Sprint Customer Service at **1-888-211-4727**.

## Getting Help

---

### Managing Your Account









Online: [www.sprint.com](http://www.sprint.com)

- Access your account information.
- Check your minutes used (depending on your Sprint service plan).
- View and pay your bill.
- Enroll in Sprint online billing and automatic payment.
- Purchase accessories.
- Shop for the latest Sprint phones.
- View available Sprint service plans and options.
- Learn more about data services and other products like Sprint Picture Mail, games, ringers, screen savers, and more.

### From Your Sprint Device

1. From the Home screen, tap .

2. Do any of the following:

- Tap    to check minute usage and account balance.
- Tap    to make a payment.
- Tap    to access a summary of your Sprint service plan or get answers to other questions.

### From Any Other Phone

- Sprint Customer Service: **1-888-211-4727**.
- Business Customer Service: **1-800-927-2199**.

### Sprint 411

Sprint 411 gives you access to a variety of services and information, including residential, business, and government listings; movie listings or showtimes; driving directions, restaurant reservations, and major local event information. You can get up to three pieces of information per call, and the operator can automatically connect your call at no additional charge.

There is a per-call charge to use Sprint 411, and you will be billed for airtime.

▶ Tap    .

### Sprint Operator Services

Sprint Operator Services provides assistance when you place collect calls or when you place calls billed to a local telephone calling card or third party.

▶ Tap  .



For more information or to see the latest in products and services, visit us online at [www.sprint.com](http://www.sprint.com).

*Section 2*  
***Your Device***



## 2A. Device Basics

- ◆ Your Device (page 6)
- ◆ Turning Your Device On and Off (page 8)
- ◆ Viewing the Display Screen (page 9)
- ◆ Battery and Charger (page 12)
- ◆ Getting Around Your Device (page 13)
- ◆ Displaying Your Phone Number (page 14)
- ◆ Making and Answering Calls (page 15)
- ◆ Speed Dialing (page 19)
- ◆ Dialing Sprint Services (page 19)
- ◆ Entering Text (page 19)
- ◆ Home Screen (page 22)

**Tip: Device Software Upgrades** – Updates to your device's software may become available from time to time. Sprint will automatically upload critical updates to your device. You can also check for and download updates by pressing  > , and then tapping **Settings** > **System updates** > **Firmware update** to search for and download available updates.

### Your Device

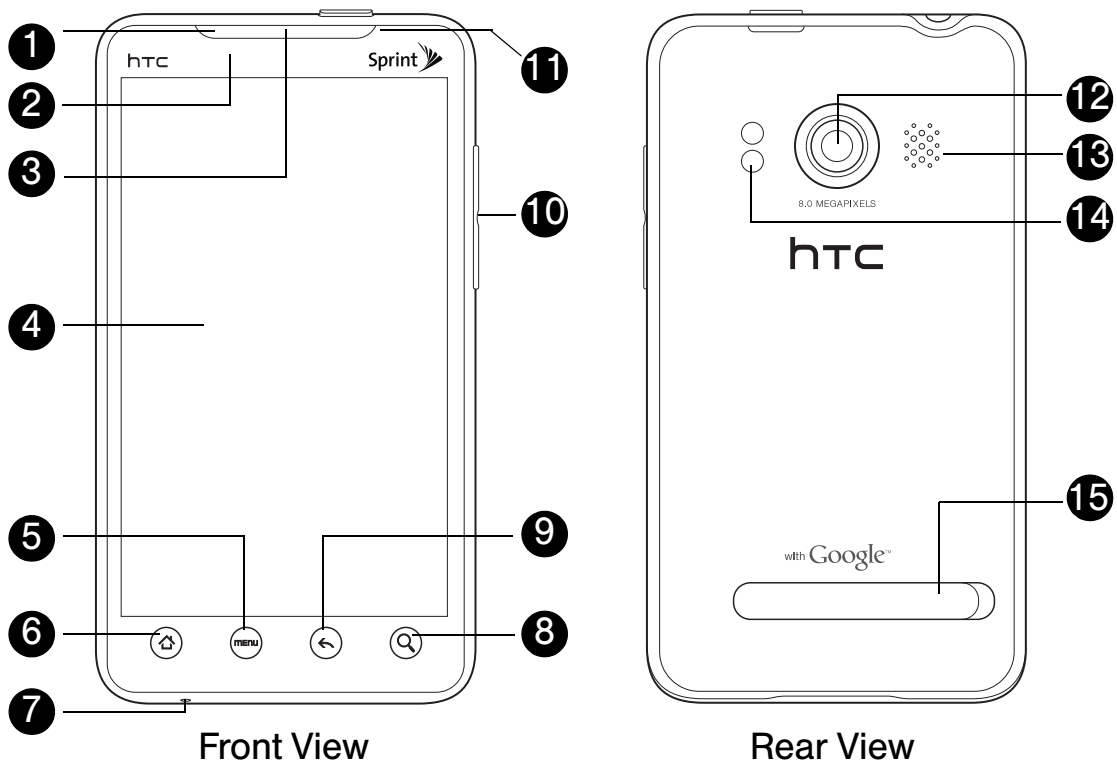



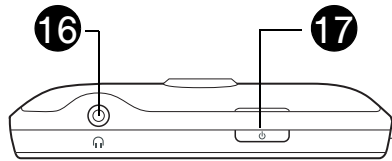

Top View

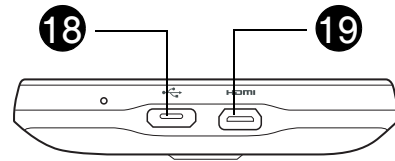

End View

## Key Functions

1. **Front Indicator Light (LED)** shows your device's connection status at a glance.
2. **Proximity Sensor** automatically switches the display screen off when you hold the device near your face during a call. When activated, the proximity sensor does not reduce transmission power for WiMAX, CDMA, or Wi-Fi.
3. **Earpiece** lets you hear the caller and automated prompts.
4. **Display Screen** displays all the information needed to operate your device, such as the call status, the People list, the date and time, and the signal and battery strength.
5. **Menu Key** allows you to open a list of actions that you can do on the current screen.
6. **Home Key** takes you back to the Home screen. When in standby mode, press and hold to open the recently-used applications window.
7. **Microphone** allows other callers to hear you clearly when you are speaking to them.
8. **Search Key** allows you to search information on the current screen or application. For example, while in People, press  to search for a contact in the device.
9. **Back Key** allows you to go back to the previous screen, or close a dialog box, options menu, the Notifications panel, or onscreen keyboard.
10. **Volume Button** allows you to adjust the ringer or media volume or adjust the voice volume during a call.
11. **Front Camera** lets you capture a self-portrait or a video.
12. **Camera Lens** as part of the built-in camera, lets you take pictures and videos.
13. **Speaker** lets you hear the different ringers and sounds. The speaker also lets you hear the caller's voice in speakerphone mode.
14. **Dual Flash** helps illuminate subjects in low-light environments when the camera is focusing and capturing a photo or video.
15. **Kickstand** lets you prop up the device on a desk or other flat surface for more comfortable viewing.
16. **3.5 mm Headset Jack** allows you to plug in either a stereo headset or an optional headset for convenient, hands-free conversations. CAUTION! Inserting an accessory into the incorrect jack may damage the device.
17. **Power Button** lets you turn the device on or off or turn on/off the screen. While in standby mode and the screen is unlocked, press and hold to open a menu to let you turn on/off the device, turn on/off your mobile network connection, or switch your device to silent mode, vibration mode, or airplane mode.
18. **Charger/Accessory Jack** allows you to connect the device charger or the USB cable (included). CAUTION! Inserting an accessory into the incorrect jack may damage the device.
19. **HDMI Jack** allows you to use an HDMI cable to connect to an HDMI-capable external display, such as an LCD TV. You can then display photos and videos on your device to the connected external display. CAUTION! Inserting an accessory into the incorrect jack may damage the device.

## Turning Your Device On and Off

---

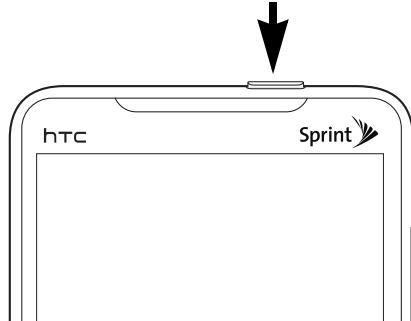

### Turning Your Device On

- ▶ Press the power button (  ) at the top panel of the device.



### Turning Your Device Off

1. Press and hold  for about two seconds.



**Note:** When the screen is locked and you press , it will only turn off the screen and not the device. You will need to unlock the screen first before you press and hold . See “Turning Off the Screen When Not in Use” for details.

2. On the **Phone options** menu, tap **Power off**.
3. On the **Power off** confirmation box, tap **OK**.

### Turning Off the Screen When Not in Use

To save battery power, the device automatically turns off the screen when you leave it idle after a certain period of time. You will still be able to receive messages and calls while the device’s screen is off.

**Tip:** For information on how to adjust the time before the screen turns off, see “Display Settings” on page 29.

You can also turn off and lock the screen by pressing . Pressing  again or incoming calls will turn on your device screen and show the lock screen.

To unlock the screen:



Press and hold the lock screen bar and then slide your finger down to unlock the screen or answer an incoming call.







**Note:** If you have set up a screen unlock pattern, you will be prompted to draw the pattern on the screen before it unlocks. For more information on how to create and enable the screen unlock pattern, see “Protecting Your Device with a Screen Lock” on page 33.

## Viewing the Display Screen

























Your device’s display screen provides information about notifications and your device’s status. This list identifies the symbols you’ll see on your device’s display screen:



Status Bar – Notification Icons			
	New Text or Multimedia Message		More (undisplayed) notifications
	New Voicemail		Call in progress (Voice Privacy locked/unlocked)
	New Gmail message		Missed call
	New Microsoft Exchange ActiveSync or POP3/IMAP email message		Compass needs orientation
	Problem with Text/Multimedia Message delivery		Uploading data (animated)
	New instant message from Google Talk		Downloading data (animated)
	Upcoming event		Waiting to upload
	Music is playing		Content downloaded
	General notification (for example, sync error)		Device connected to computer via USB cable
	Storage card is low on free space		Storage card is safe to remove or storage card is being prepared
	Wi-Fi is on and wireless networks are available		No storage card installed on the device.

<b>Status Bar – Notification Icons</b>			
	Data synchronizing – connected to HTC Sync		New tweet
	New location detected		Updates available for an application downloaded from Android Market



<b>Status Bar – Device Status Icons</b>			
	Signal Strength (More bars = stronger signal)		Shows current battery charge level (Icon shown is fully charged)
	No Service		Bluetooth on
	Device is “roaming” off the Nationwide Sprint Network		Connected to Bluetooth device
	Sprint 3G data service (EVDO) available (when active, icon animated)		Airplane mode
	Sprint 1xRTT network available (when active, icon animated)		Alarm set
	Data service is currently unavailable		Speakerphone on
	Device’s location feature is on and available for location-based services such as GPS Navigation		Wired microphone headset connected
	Device’s location feature off and your location available only for 911 (page 17)		Wired headset connected
	Device microphone muted		Connected to Wi-Fi network
	Device speaker muted		Connected to a 4G network
	Vibrate mode		4G is on and 4G networks are available
	Sprint Mobile Hotspot is on and is ready to share its 4G connection		Sprint Mobile Hotspot is on and is ready to share its 3G connection

## Notifications Panel

Notification icons report the arrival of new messages, calendar events, alarms being set and ongoing settings such as call forwarding being on or the current call status. You can open the Notifications panel to access message, reminder, or event notification tabs.

### To open the Notifications panel:

When a new notification icon displays in the status bar, press and hold the status bar, and then slide your finger downward to open the Notifications panel.

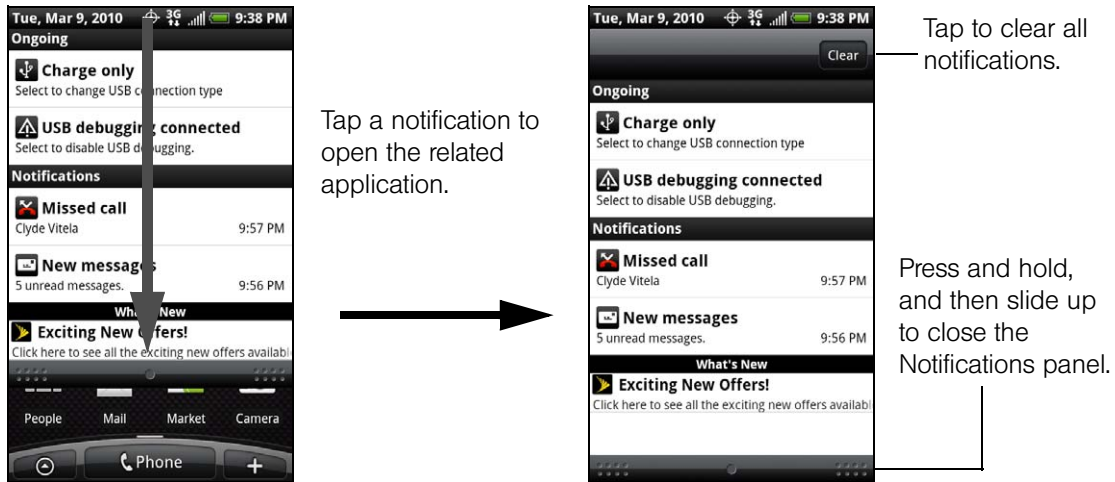

If you have several notifications, you can scroll down the screen to view more notifications.

**Tip:** You can also open the Notifications panel from the Home screen by pressing  and then tapping **Notifications**.

### To close the Notifications panel:

- ▶ Press and hold the bottom bar of the Notifications panel, and then slide your finger up the screen.
- or –
- Press .

## Notification LED

The Notification LED located at the right corner of the earpiece provides information on the device status or pending notifications.

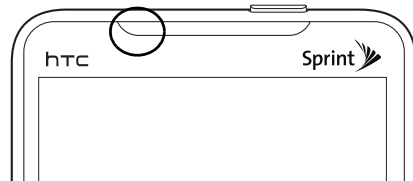

LED Status	Indication
Solid green	Battery is fully charged. (When the device is connected to the AC adapter/computer.)
Solid amber	Battery is charging.
Flashing amber	Battery is low. (Battery power is below 14%.)
Flashing green	You have a pending notification (for example, a new message or a missed call).

**Note:** The indicators are listed in order of priority. For example, if your device is connected to a power adapter and is charging the battery, the LED will be solid amber and will not switch to a flashing green light even if there is a pending notification.

## Battery and Charger

**WARNING:** Use only Sprint-approved or HTC-approved batteries and chargers with your device. The failure to use an Sprint-approved or HTC-approved battery and charger may increase the risk that your device will overheat, catch fire, or explode, resulting in serious bodily injury, death, or property damage.

Sprint-approved or HTC-approved batteries and accessories can be found at Sprint Stores or through HTC; or call **1-866-866-7509** to order. They're also available at [www.sprint.com](http://www.sprint.com).

### Battery Capacity

Your device is equipped with a Lithium Ion (Li-Ion) battery. It allows you to recharge your battery before it is fully drained. The battery provides up to 6 hours of continuous talk time. For battery-saving tips, see "Power-Saving Tips" on page 37.

**Note:** Long backlight settings, searching for service, vibrate mode, browser use, and other variables may reduce the battery's talk and standby times.

**Tip:** Watch your device's battery level indicator and charge the battery before it runs out of power.

### Installing the Battery

1. With the device turned off, insert your fingernail into the slot at the top left of the battery compartment cover and lift gently to remove.

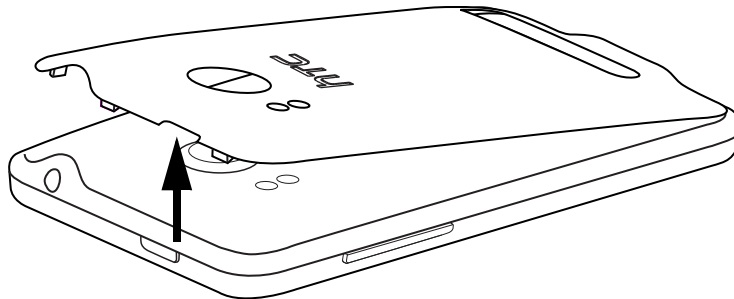

2. Align the battery's exposed copper contacts with the battery connectors inside the battery compartment.
3. Insert the contact end of the battery first then gently push the battery into place.

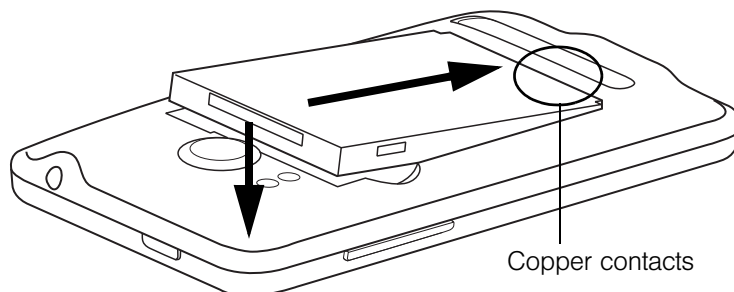

4. Replace the back cover, making sure all the locking tabs are seated and there are no gaps around the cover.

## Removing the Battery

1. Make sure the power is off so that you don't lose any stored numbers or messages.
2. Remove the back cover. (See step 1 of "Installing the Battery.")
3. Lift the battery from the notches on the upper left and right sides of the battery compartment.

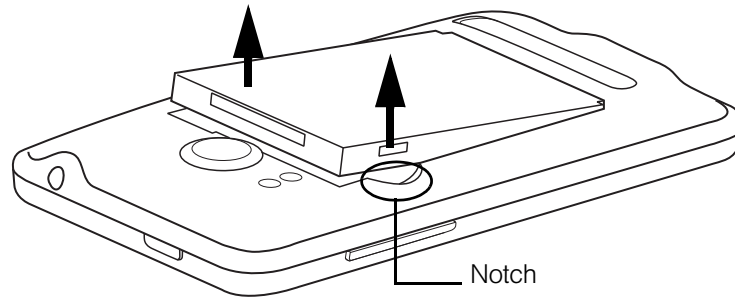



**WARNING:** Do not handle a damaged or leaking Li-Ion battery as you can be burned.

## Charging the Battery

Keeping track of your battery's charge is important. If your battery level becomes too low, your device automatically turns off, and you will lose any information you were just working on.

Always use a Sprint-approved or HTC-approved desktop charger, travel charger, or vehicle power adapter to charge your battery.

1. Plug the USB connector of the AC adapter into the charger/accessory jack at the bottom of your device.
2. Plug in the AC adapter to an electrical outlet to start charging the battery.

Charging is indicated by a solid amber light in the Notification LED. As the battery is being charged while the device is on, the charging battery icon (  ) is displayed in the status bar of the Home screen. After the battery has been fully charged, the Notification LED shows a solid green light and a full battery icon (  ) displays in the status bar of the Home screen.

For more information about Notifications, see "Notification LED" for more details.

With the Sprint-approved Li-Ion battery, you can recharge the battery before it becomes completely run down.

## Getting Around Your Device

---

There are different ways to navigate around the your device's Home screen, menus, and application screens.

### Tap

When you want to type using the onscreen keyboard, select items onscreen such as application and settings icons, or press onscreen buttons, simply tap them with your finger.

### Press and hold

To open the available options for an item (for example, contact or link in a Web page), simply press and hold the item.

### Swipe or slide

To swipe or slide means to quickly drag your finger vertically or horizontally across the screen.

## Drag



To drag, press and hold your finger with some pressure before you start to move your finger. While dragging, do not release your finger until you have reached the target position.

## Flick

Flicking the screen is similar to swiping, except that you need to swipe your finger in light, quick strokes. This finger gesture is always in a vertical direction, such as when flicking the contacts or message list.

## Rotate

For most screens, you can automatically change the screen orientation from portrait to landscape by turning the device sideways. When entering text, you can turn the device sideways to bring up a bigger keyboard. See “Using the Onscreen Keyboard” for more details.

**Note:** The **Orientation** check box in  >  > **Settings** > **Sound & display** needs to be selected for the screen orientation to automatically change.

## Pinch

The device screen supports multi-touch. On the Home screen, you can “pinch” the screen using two fingers (for example, thumb and index fingers) to switch to thumbnail view and see all the Home screens. For some applications, like Gallery or the browser, pinch the screen to zoom in or zoom out when viewing a picture or a Web page.



## Navigation keys

If the onscreen keyboard is open, tap the navigation keys to go to a text box or an area on the screen.



## Displaying Your Phone Number

---

- ▶ Press  >  and tap **Settings** > **About phone** > **Phone identity**. (Your phone number and other information about your device and account will be displayed.)



## Making and Answering Calls

---





### Making Calls

There are several convenient methods to make a call from your device.

#### Calling Using the Phone Dialer

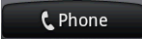
In the Phone's dialer, you can either dial a number directly, or you can use the **Smart Dial** feature to search and call a contact in People or a number from Call History.



When you enter the first letter of the name or number of a contact, Smart Dial searches for contact phone numbers and the first character of a contact name as well as from the character that appears after a space, dash, or underscore in a contact name. As you enter more letters or numbers, the list shows only the corresponding matches.

1. Press  and tap .
2. Begin entering the first few digits or characters by tapping the keys on the Phone keypad. As you enter digits or letters, the Smart Dial panel displays matches found. If you enter a wrong digit, tap  to erase that digit. To erase the entire number, press and hold .
3. Tap  to close the Phone keypad and to see if there are more matching numbers or contacts. To browse through the filtered list, flick through the list or slide your finger up or down the list slowly.
4. Tap the phone number or contact from the list.  
– or –

To call a different phone number associated with the contact, tap the contact card icon at the right side of the contact name. On the contact details screen, tap the number you want to call.

#### Calling a Phone Number in a Text Message

While viewing a text message, you can place a call to a number that is in the body of the message.

1. Press , and then tap  > **Messages**.
2. Tap the message with the phone number, and then tap the phone number.
3. On the **Select link** screen, tap the number you want to call.
4. The Phone screen then opens, with the phone number automatically filled in and ready to be dialed. To place the call, tap **Call**.

For more information about text messages, see “Text Messaging (SMS) and Multimedia Messaging (MMS)” on page 102.

#### Calling a Phone Number in an Email Message

While viewing a received email message, tap a phone number that is displayed in the body of the email message to open the Phone screen so you can call that number.

#### Calling a Speed Dial Number

To call a stored speed dial number, press and hold a number button. For information on setting up speed dial numbers, see “Speed Dialing” on page 19.

You can also place calls from your device using your History listings (page 39) and Automatic Speech Recognition (page 69).

## Receiving Calls

When you receive a phone call from a contact, the Incoming call screen appears and displays the caller ID icon, name, and phone number of the calling party. When you receive a phone call from someone who is not stored in People, only the default caller ID icon and phone number appear on the Incoming call screen.

**Note:** Make sure your device is on. (If your device is off, incoming calls go to voicemail.)

### Answering an Incoming Call

- ▶ If the display is on, tap **Answer**.
- ▶ If the display is off, the display will turn on showing the Lock screen. Drag the bar down to answer the call.



### Muting the Ringing Sound

To mute the ring without rejecting the call, you can do any of the the following:

- ▶ Press the volume down button.
- ▶ Press  and tap **Mute**. (You can do this even on the Lock screen.)
- ▶ Place the device face down on a level surface.

### Using the Quiet Ring on Pickup Feature

Your device automatically scales down the ring volume when you pick up the device to answer calls.

1. Press  > , and then tap **Settings > Sound & display**.
2. Scroll down the screen, and then select the **Quiet ring on pickup** check box.
3. Press .

### Rejecting an Incoming Call

- ▶ If the display is on, tap **Decline**.
- ▶ If the display is off, the display will turn on showing the Lock screen. Press  and then tap **Decline** to reject and send the call to your voicemail.

### Rejecting a Call and Sending a Text Message

You can automatically send a default text message to the caller and reject the incoming voice call. Press  and tap **Send message** when you have an incoming call to send the text message.

You can change the default text message by pressing  and tapping **Phone settings > Edit default message** while on the Phone screen.

### Answering a Roam Call With Call Guard Enabled

Call Guard is an option that helps you manage your roaming charges when making or receiving calls while outside the Nationwide Sprint Network. See “Roaming” on page 109 for more information.

- ▶ Tap **Answer** to answer the call. (See “Call Guard” on page 110 for more information.)

**Note:** When your device is off, calls go directly to voicemail.

### Ending a Call

- ▶ Tap **End call**.

## Missed Call Notification

When you do not answer an incoming call, you will see the missed call icon  in the status bar when you miss a call.





To check who the caller was, press and hold the status bar, and then slide your finger downward on the screen to open the Notifications panel. The missed call number or contact name is displayed.

Tap the missed call number or contact name to open the Call history. Missed calls are indicated by the missed call icon (  ).





## Calling Emergency Numbers

You can place calls to 911 (dial     ), even if the device's screen is locked with a pattern or your account is restricted.

*To call the 911 emergency number when the device's screen is locked with a pattern:*

1. Unlock the screen. For more information, see “Turning Off the Screen When Not in Use.”
2. Tap **Emergency call** on the screen.
3. Tap    , and then tap .

*To call the 911 emergency number normally or when your account is restricted:*

1. Unlock the screen. For more information, see “Turning Off the Screen When Not in Use.”
2. Tap  on the Home screen.
3. Tap    , and then tap .

## Enhanced 911 (E911) Information

This device features an embedded Global Positioning System (GPS) chip necessary for utilizing E911 emergency location services where available.

When you place an emergency 911 call, the GPS feature of your device seeks information to calculate your approximate location. Depending on several variables, including availability and access to satellite signals, it may take up to 30 seconds or more to determine and report your approximate location.

**Important:** Always report your location to the 911 operator when placing an emergency call.

Some designated emergency call takers, known as Public Safety Answering Points (PSAPs) may not be equipped to receive GPS location information from your device.

## In-Call Options

Pressing  during a call displays a list of available in-call features. To select an option, tap the option. The following options may be available through the Options menu:

**Note:** When the device is completing a call, only the **People**, **Flash** and **Speaker on** options are available.

- **Add call** to initiate a three-way call.
- **People** to display your contacts list.
- **Flash** to accept another incoming call and put the first caller on hold. Tap **Flash** again to talk to the first caller.
- **Mute** to mute the microphone. Tap **Unmute** to unmute the microphone.
- **Speaker on** or **Speaker off** to route the device's audio through the speaker or through the earpiece.

- ▶ Tap **Speaker On** to route the device's audio through the speaker. (You can adjust the speaker volume using the volume button on the side of the device.)
- ▶ Tap **Speaker Off** to use the device's earpiece.

**WARNING:** Because of higher volume levels, do not place the device near your ear during speakerphone use.

## End-of-Call Options



After you receive a call from or make a call to a phone number that is not in your People list, you can choose to save the number to People. On the Phone screen, tap  at the right side of the number to add the new number to People. (See "Saving a Phone Number" on page 18.)

**Tip:** After receiving a call from a phone number that is not in your People list, an options menu is briefly displayed to allow you to save the number to People. On the options menu, tap **Yes, create new contact**.

## Saving a Phone Number



Store contacts entries in your device. Your device automatically sorts People entries alphabetically. (For more information, see "People" on page 41.)

*To save a number from standby mode:*



1. Press  and tap .
2. Enter the phone number by tapping the keys on the keypad.
3. Tap **Save to People**. (This button appears after tapping six digits.)
4. Tap **Create new contact** or **Save to existing contact**.
5. Use the keyboard to enter the new contact name and tap **Save** to save the new entry.  
– or –  
Tap an existing contact name and tap **Save** to save the new number.

## Finding a Phone Number

You can search People for entries by name.

1. Press , tap  > **People**, and then press .
2. Enter the first letter or letters of an entry. (The more letters you enter, the more specific the search.)
3. Tap the contact to display his/her contact information.

## Dialing From the People List



1. Press , tap  > **People**.
2. Tap the entry you want to call.
3. Tap **Call [Type of Number]**. (For example, **Call mobile**.)

## Speed Dialing

---

Your device can store up to nine phone numbers in speed dial locations.

To assign a speed dial number to a People entry:

1. Press , tap  > **People**, and then tap an entry in People.
2. Press  and tap **More > Set speed dial**.
3. Tap the list menu under **Number** to select a number from the contact to assign to speed dial.
4. Tap the list menu under **Location** to assign the number to a speed dial location.
5. Tap **Save**.



**Note:** If you assign a number to an already in-use speed dial location, the new phone number will automatically replace the previous speed dial assignment.

To call using Speed Dial:

- ▶ Press and hold the appropriate key on the Phone keypad for approximately two seconds. The display confirms that you have dialed the number when it shows “Dialing” on the upper right side of the screen.

**Note:** Speed dialing is not available when you are roaming; when you are roaming off the Nationwide Sprint Network, you must always dial using eleven digits (1 + area code + number).

### Finding Speed Dial Numbers













1. Press , tap .
2. Press  and tap **Speed dial**.
3. Tap a speed dial entry to call the contact.

**Tip:** While on the Speed dial screen, press  and tap **Add** to add new speed dial entries from People.

## Dialing Sprint Services

---

- ▶ Dial the appropriate service number:

- **Customer Service** –   
- **Sprint 411** –    
- **Account Info.** –   
- **Sprint Operator** –  

## Entering Text

---

### Using the Onscreen Keyboard

When you start a program or select a box that requires text or numbers, the onscreen keyboard becomes available. You can choose from three keyboard layouts: **QWERTY**, **Compact QWERTY**, and **Phone Keypad**.

## Using the Landscape Onscreen Keyboard

When entering text, you can choose to use the landscape orientation of the onscreen keyboard, by turning the device sideways, to use a larger keyboard that lets you type easily using two thumbs.

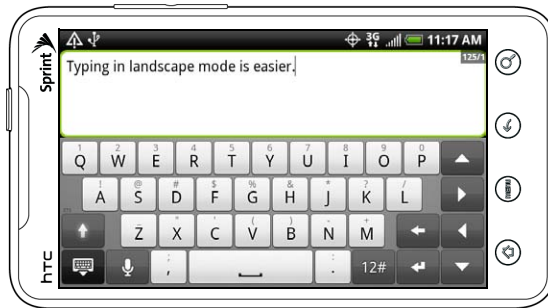

**Note:** The **Orientation** check box in > > **Settings** > **Sound & display** needs to be selected for the screen orientation to automatically change.

The landscape orientation keyboard is not supported in all applications.

## Changing the Onscreen Keyboard Layout

You can choose from three different keyboard layouts to suit your typing style. To change the keyboard layout, do the following:

1. Press > , and then tap **Settings** > **Language & keyboard** > **Touch Input**.
2. Tap **Keyboard types**, and then select the keyboard layout that you want to use. Choose from the following:
  - **QWERTY**. This layout is similar to a desktop computer keyboard. This is the default keyboard layout.
  - **Phone Keypad**. This layout resembles the traditional wireless phone keypad.
  - **Compact QWERTY**. This layout features two letters on each key. The key size is slightly bigger than on the Full QWERTY layout.

## Entering Text

Use the following keys while entering text using the onscreen keyboard:

	Press and hold keys with gray characters at the top to enter numbers, symbols, or accented letters. The gray character displayed on the key is the character that will be inserted when you press and hold that key. Some keys have multiple characters or accents associated with them.
	<b>Shift</b> key. Tap to enter an uppercase letter. The next letter you type will be uppercase. Tap twice to turn on caps lock.
	Tap to switch to the numeric and symbol keyboard.
	<b>Enter</b> key. Tap to create a new line.
	<b>Backspace</b> key. Tap to delete the previous character.
	Tap to hide the onscreen keyboard.
	Tap to toggle between <b>Multitap</b> and <b>XT9</b> predictive modes when using the Compact QWERTY or Phone Keypad layout. (See “Entering Words with Predictive Text” for details.)

## Entering Words with Predictive Text

The onscreen keyboard has predictive text to help you type quickly and accurately. Predictive text input is enabled by default, and word suggestions are displayed as you type.

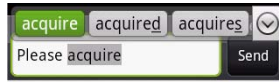

To enter a word in predictive mode, do any of the following:

- If you see the word you want highlighted in green or orange, you can simply tap the space bar to insert the word into your text.
- If you see the word you want shown in the suggestions before you have finished typing the entire word, tap the word to insert it into your text.
- If an arrow is shown to the right of the suggestion list, tap the arrow to see more suggestions.

## Adding a Word to the Predictive Text Dictionary

Your device comes with a list of words that it references for predictive text suggestions. Sometimes you may need to add a word to the predictive text dictionary, for example a name or a specialized technical word. While entering text using the QWERTY keyboard layout, if you tap any word on the suggestion list, it is automatically added to the predictive text dictionary if it was not in the dictionary already.

*To manually add a word to the predictive text dictionary:*

1. Press > and then tap **Settings > Language & keyboard > Touch Input > User Dictionary**.
2. Tap **Add new**.
3. Enter the word to add, and then tap **OK**.

## Editing or Deleting a Word in the User Dictionary

You can edit or remove words that you previously added to the predictive text dictionary.

1. Press > and then tap **Settings > Language & keyboard > Touch Input > User Dictionary**.
2. Do any of the following:
  - To edit a word, tap the word, enter your changes, and then tap **OK**.
  - To delete a word, tap the **X** icon to the right of the word.

## Adjusting Touch Input Settings

- Press > , and tap **Settings > Language & keyboard > Touch Input**.

### Touch Input Settings

- **Keyboard types** lets you select the keyboard layout to use. You can choose from **QWERTY**, **Phone Keypad**, or **Compact QWERTY**.
- **Keyboard language** lets you select the language layout of the keyboard.
- **Text input** lets you set text input options when entering text, calibrate the keyboard, and set a sound or vibration feedback whenever you tap a key.
  - **QWERTY**
    - **Prediction:** Enable the word prediction feature.
    - **Spell correction:** Correct typographical errors by selecting from a list of possible words that reflect the characters of the keys you have tapped as well as characters of nearby keys.

- Phone keypad & compact QWERTY
  - **Spell correction:** Correct typographical errors by selecting from a list of possible words that reflect the characters of the keys you have tapped as well as characters of nearby keys.
  - **Word completion:** Select from a list of possible combinations based on the characters that appear on the keys that you tapped.
- Other settings
  - **Sound feedback:** Make a clicking sound whenever you tap a key on the keyboard.
  - **Vibrate when typing:** Enable vibration feedback whenever you tap a key on the keyboard.
- Finger touch precision
  - **Calibration tool:** Recalibrate the keyboard touch accuracy. Recalibrate the keyboard if you feel that the keyboard keys are not responding accurately to your taps.
  - **Reset calibration:** Reset the calibration back to factory default.
- **Tutorial** lets you go through tutorials to learn how to use the onscreen keyboard features.
- **User Dictionary** lets you add, edit, or remove words in the predictive text dictionary. For more information, see “Adding a Word to the Predictive Text Dictionary” and “Editing or Deleting a Word in the User Dictionary.”

## Home Screen

---

The Home screen is the starting point for many applications and functions, and it allows you to add items like application icons, shortcuts, folders, and HTC or Google widgets to give you instant access to information and applications.



1. **Status Bar:** Displays device status and notification icons. See “Viewing the Display Screen” for a list of icons you will see on the status bar.
2. **Application icon:** Tap to open the related application.
3. **All apps:** Tap to open the All apps screen. The All apps screen holds all applications on your device.
4. **Add to Home:** Tap to add shortcuts, widgets, and folders on the Home screen.
5. **Phone:** Tap to open the Phone screen to make calls.

**Tip:** While in any application, press  to go back to the Home screen.



## Extended Home Screen

The Home screen extends beyond the screen width to provide more space for adding icons, widgets, and more. Press , and then slide your finger horizontally across the screen to go to the left or right side of the extended Home screen. There are six “additional” screens apart from the main Home screen.

Your Home screen may look like this:



**Note:** You cannot add more screens.

**Tip:** While on an extended Home screen, press  to return to the main Home screen.

*To directly go to a particular Home screen:*

1. On any Home screen, pinch the screen to bring up a snapshot of the Home screen.

**Tip:** On the main Home screen, you can press  to show the snapshot of the Home screen.

2. Tap the screen you want to open.

## Customizing the Home Screen

*To add a Home screen item:*

1. Press  and tap .



**Note:** You can also press and hold an empty area on the Home screen.

2. In the **Add to Home** options menu, tap the item you want to add to the Home screen:
  - **Widget:** Add HTC or Android™ widgets to the Home screen such as a clock, calendar, mail, people, Footprints, and more.
  - **Program:** Add shortcuts to applications on your phone. To quickly add an application shortcut that is on the All apps screen to the Home screen, press and hold an application icon. When the device vibrates, drag the icon on an empty area on the Home screen, and then release it.
  - **Shortcut:** Add shortcuts to bookmarked Web page, a favorite contact, a Gmail™ label, a music playlist, and more.
  - **Folder:** Add a folder where you can organize Home screen items. Add a shortcut to all your contacts, contacts with phone numbers, or starred contacts. Contact details are automatically updated when there are changes in the source.

Customize your Home screen by adding application shortcuts and widgets. You can also use preset widgets from a Scene. To use a Scene, press  >  and tap **Scenes**.

**Tip:** You can also create and save your custom scene. (See “Creating and Saving a Custom Scene” for details.)

*To add a widget:*

1. Press  and tap .
2. In the **Add to Home** options menu, tap **Widget**.
3. Select a widget to add to the Home screen, and then select a layout to use, when available.

**Note:** Most HTC widgets offer various layouts and sizes to fit your needs.

4. Tap **Select**.

**Note:** You may need to slide to another screen or remove a widget on the Home screen first if there is no space to place the new widget.

*To reposition a Home screen item:*

1. Press and hold the item on the Home screen you want to reposition to activate Edit mode.

**Note:** When Edit mode is activated, the item expands and the device vibrates.

2. Without lifting your finger, drag the icon to the position you want on the screen, and then release it.

**Note:** To move an item from the Home screen to an extended Home screen, press and hold the item and then drag it to the left or right edge of the screen until the display shifts to the extended Home screen. Position the item on the screen, and then release it.

*To remove a Home screen item:*

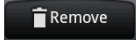

1. Press and hold the item on the screen you want to remove to activate Edit mode.

**Note:** When Edit mode is activated, the item expands and the device vibrates.

2. Drag the icon to the Phone button (The Phone button changes into .)
3. When the icon and the Remove button turn red, release pressure.

*To create a folder and add items to it:*

You can create folders on the Home screen to hold application icons or shortcuts.

1. Press  >  and tap **Add to Home > Folder > New folder**. A new folder appears on the screen.
2. Press and hold an application icon or a shortcut on the Home screen to activate Edit mode, and then drag it on top of the folder.

To access the items inside a folder, tap the folder to open it and then tap the icon of the application or shortcut you want to open.

**Note:** To delete a folder, follow the same procedure as you would for removing a Home screen item.

*To rename a folder:*

1. Tap the folder to open it.
2. Press and hold the folder's title bar to open the **Rename folder** dialog box.
3. Enter the **Folder name** and then tap **OK**.

## *Creating and Saving a Custom Scene*

Create your own custom scene and save it on your device.

1. Customize the Home screen by adding or removing widgets or application shortcuts, repositioning items, or changing the wallpaper.
2. After customizing, press  and tap **Scenes**.
3. On the Choose a scene options menu, select **Current (unsaved)** and tap **Save**.
4. Enter the **Scene name** and tap **Done**.

## 2B. Settings

- ◆ Personalization Settings (page 26)
- ◆ Sound Settings (page 27)
- ◆ Display Settings (page 29)
- ◆ Location Settings (page 30)
- ◆ Messaging Settings (page 31)
- ◆ Airplane Mode (page 32)
- ◆ TTY Use With Sprint Service (page 32)
- ◆ Security Settings (page 33)
- ◆ Data Synchronization Settings (page 34)
- ◆ Social Network Settings (page 35)
- ◆ Application Settings (page 36)
- ◆ Date & Time Settings (page 37)
- ◆ Locale & Text Settings (page 37)
- ◆ Power-Saving Tips (page 37)

### Personalization Settings

---

#### Scenes

##### Selecting a Scene

Customize your device's Home screen appearance by selecting a scene to reflect your lifestyle. Scenes are preset Home screen layouts that you can quickly apply.

- ▶ Press  > , tap **Scenes**, and then tap a scene to apply it to the Home screen.



##### To save a custom scene:

- ▶ Customize the Home screen by changing the wallpaper and adding widgets, press , and then tap **Scenes > Current (unsaved) > Save**. Enter the **Scene name** and then tap **Done**.

**Tip:** You can rename or delete a custom scene in the Settings screen. On the Settings screen, tap **Personalize > Scenes**, and then press and hold a custom scene.

##### Renaming or Deleting a Scene

You can rename or delete a custom scene. To learn how to create a custom scene, see “Creating and Saving a Custom Scene” on page 25.

1. Press  >  and tap **Settings > Personalize > Scenes**.
2. Press and hold the custom scene (under **My scenes**) and tap **Rename** or **Delete**.
3. Tap **Rename**, enter the new **Scene name**, and then tap **Done**.  
– or –  
Tap **Delete > OK**.

**Note:** You cannot rename or delete a preset scene.

## Home Screen Wallpaper

See “Changing the Display Screen” for details.

## Default Ring Tone

See “Phone Ring Tone” for details.

## Sound Settings

---

### Phone Ring Tone

Select a default ring tone for incoming calls.

#### Selecting the Default Ring Tone

Your device provides a variety of ring tones that you can set as the default ring tone of your device.

1. Press  >  and tap **Settings > Sound & display > Phone ringtone**.
2. Tap the ring tone you want to use, and then tap **OK**. The ring tone briefly plays when selected.



**Note:** You can use \*.wav, \*.mid, \*.mp3, \*.wma, or other types of sound files that you downloaded from the Internet or copied from your computer as ring tones.

### Notification Sound

Select a default sound for notifications.



#### Selecting the Default Notification Sound

Your device provides a variety of sounds that you can set as the default sound for notifications.

1. Press  >  and tap **Settings > Sound & display > Notification sound**.
2. Tap the sound you want to use, and then tap **OK**. The sound plays when selected.

### Adjusting the Device's Volume Settings

Adjust your device's volume settings to suit your needs and your environment.

1. Press  >  and tap **Settings > Sound & display**.
2. Tap **Ringer volume** or **Media volume**.
3. Drag the volume slider on the screen to adjust the volume and then tap **OK**.

**Note:** You can adjust the ringer volume in standby mode (or the earpiece volume during a call) by using the volume buttons on the right side of your device.

## Vibrate



*To set your device to vibrate instead of making any sounds:*

- ▶ Press the volume button down in standby mode until you see the image below on the screen.



The device vibrates and the vibrate mode icon (  ) appears on the status bar.

*To set your device to always vibrate in addition to any ringer settings:*

1. Press  >  and tap **Settings > Sound & display**.
2. Select the **Phone vibrate** check box.
3. Press .

## Silence All

The Silence All option allows you to mute all sounds without turning your device off.

*To activate Silence All:*

- ▶ Press the volume button down in standby mode until you see the image below on the screen.





The Silence All mode icon (  ) appears on the status bar.

*To deactivate Silence All:*

- ▶ Press the volume button up repeatedly to select a volume level.



## Alert Notification

Set your device to alert you with an audible tone when you are not within the Sprint coverage area or when you make an emergency call.

1. Press  >  and tap **Settings > Sound & display**.
2. Do any or all of the following:
  - Select the **Roaming ringtone** check box.
  - Tap **Emergency tone**, and then tap **Alert**.
3. Press .

## Enabling Touch Tones

You can set the device to play a sound when you are using the phone keypad or tapping the screen.



1. Press  >  and tap **Settings > Sound & display**.
2. Do any or all of the following:
  - Select the **Audible selection** check box to set the device to play a sound every time you tap the screen.
  - Tap **Audible touch tones**, and then tap **Long tones** or **Short tones** to set the device to play a sound when you are using the phone keypad.
3. Press .

## Display Settings

---

### Changing the Screen Timeout Period

After a period of inactivity, the device screen turns off to conserve battery power. You can set the idle time before the screen turns off.



1. Press  >  and tap **Settings > Sound & display > Screen timeout**.
2. Tap the time before the screen turns off.

**Note:** Extended screen timeout periods reduce the battery's talk and standby times.

**Tip:** To turn off and lock the screen quickly, press the (  ) key.

### Changing the Display Screen

Changing the device's display screen wallpaper with preset wallpapers or your favorite photo is a quick and easy way to change the feel of your device and give it a fresh look. Browse the collection of wallpapers included in your device or choose from photos that you have taken with the camera. You can also change your Home screen to use an animated wallpaper.



1. Press  >  and tap **Wallpaper**.
2. Do one of the following:
  - Tap **HTC wallpapers** or **Android wallpapers** to use preset images.
  - Tap **Live wallpapers** to choose from preset animated wallpapers.
  - Tap **Gallery** to use a picture that you have captured using the camera or copied to your device as a wallpaper. You can crop the picture before setting it as a wallpaper.
3. Tap **Save** or **Set wallpaper**.

After changing the wallpaper, remember to save it to the scene that you created or save it as a new scene. For more information, see "Creating and Saving a Custom Scene."

## Adjusting the Brightness



By default, the screen brightness automatically adjusts depending on the surrounding lighting conditions.

*To manually adjust screen brightness*

1. Press  >  and tap **Settings > Sound & display**.
2. Tap **Brightness** and then clear the **Automatic brightness** check box.
3. Drag the slider to adjust the brightness.
4. Tap **OK**.

## Changing the Screen Orientation

By default, the screen orientation automatically changes when the device is rotated. To disable automatic screen orientation:



1. Press  >  and tap **Settings > Sound & display**.
2. Clear the **Orientation** check box and press .

**Note:** Not all application screens support automatic rotation.

The screen orientation automatically changes to landscape mode when you turn the device counterclockwise 90 degrees. If you turn the device clockwise 90 degrees, the screen orientation will not change to landscape mode.

## Recalibrating the Screen

Recalibrate the screen if you feel that the screen orientation does not respond properly to the way you hold the device.

1. Press  >  and tap **Settings > Sound & display > G-Sensor calibration**.
2. Place the device on a flat surface and then tap **Calibrate**.
3. After the recalibration process, tap **OK**.

## Location Settings



---

Your device is equipped with a Location feature for use in connection with location-based services.

The Location feature allows the network to detect your position. Turning Location off will hide your location from everyone except 911.

**Note:** Turning **Location** on will allow the network to detect your position using GPS technology, making some Sprint applications and services easier to use. Turning **Location** off will disable the GPS location function for all purposes except 911, but will not hide your general location based on the cell site serving your call. No application or service may use your location without your request or permission. GPS-enhanced 911 is not available in all areas.

*To enable your device's Location setting feature:*

1. Press  >  and tap **Settings > Location > Location setting**.
2. Read the Location disclaimer and then tap **ON**.
3. Press .

When you turn the Location setting feature on, the device displays the  icon on the status bar. When you turn Location setting off, the device displays the  icon.



## Messaging Settings

---



Your device's advanced messaging capabilities let you send and receive many different kinds of text messages without placing a voice call. (For more information, see "Accessing Email Messages" on page 122.)

Messaging settings allow you to decide how you would like to be notified of new messages and create your own preset messages.

### Setting Message Notification

When you receive a message, your device notifies you by displaying an icon on your display screen. You can also choose to vibrate the device and have the screen flash when you receive a message.



*To display a notification and vibrate the device when you receive a message:*

1. Press  and tap  > **Messages**.
2. Press  and then tap **Settings**.
3. Scroll down the screen and select the **Play notification sound** and **Vibrate** check boxes.

**Note:** Tap **Notification sound** to choose a notification sound.

4. Press .





*To flash the screen when you receive a message:*

1. Press  >  and tap **Settings** > **Sound & display** > **Notification flash**.
2. Select the **SMS/MMS** check box and then press .

### Managing Preset Messages

Your device is loaded with nine preset messages to help make sending text messages easier. Customize or delete these messages, such as "Where are you?," "Let's catch up soon," and "Just checking in" to suit your needs, or add your own messages to the list.

*To edit or delete a preset message:*





1. Press  and tap  > **Messages** > **New message**.
2. Tap the text box with the text "Tap to compose."
3. Press  and tap **Quick text**. (You will see the list of preset messages.)
4. Press  and:

Tap **Edit**, tap the message you want to edit, edit the message (see "Entering Text" on page 19), and then tap .

– or –

Tap **Delete**, select the message you want to delete, and tap **OK**. (Tap **Cancel** to cancel the deletion.)

*To add a new preset message:*



1. Press  and tap  > **Messages** > **New message**.
2. Tap the text box with the text "Tap to compose."
3. Press  and tap **Quick text**. (You will see the list of preset messages.)
4. To add a new message, press  and tap **Insert**.
5. Enter your message and tap . (Your new message will be added to the beginning of the list.)

## Airplane Mode





---

Airplane Mode allows you to use many of your device's features, such as Gallery, camera, and Music, when you are on an airplane or in any other area where making or receiving calls or data is prohibited. When you set your device to Airplane Mode, it cannot send or receive any calls or access online information.

*To quickly turn Airplane Mode on or off:*

- ▶ Press and hold the power button (  ), and then tap **Airplane mode** in Phone options. While in Airplane Mode, the status bar will display .

*To turn Airplane Mode on or off in Settings:*





1. Press  >  and tap **Settings > Wireless & networks**.
2. Select the **Airplane mode** check box and press . While in Airplane Mode, the status bar will display .

## TTY Use With Sprint Service



---

A TTY (teletypewriter, also known as a TDD or Text Telephone) is a telecommunications device that allows people who are deaf, hard of hearing, or who have speech or language disabilities, to communicate by telephone.

Your device is compatible with select TTY devices. Please check with the manufacturer of your TTY device to ensure that it supports digital wireless transmission. Your device and TTY device will connect using a special cable that plugs into your device's headset jack. If this cable was not provided with your TTY device, contact your TTY device manufacturer to purchase the connector cable.

When establishing your Sprint service, please call Sprint Customer Service using the state Telecommunications Relay Service (TRS) by first dialing    . Then provide the state TRS with this number: **866-727-4889**.

*To turn TTY Mode on or off:*

1. Press  >  and tap **Settings > Call > TTY mode**.
2. Tap **TTY Full**, **TTY HCO**, or **TTY VCO** to turn TTY mode on.  
– or –  
Tap **TTY Off** to turn TTY mode off.

**Note:** When enabled, TTY mode may impair the audio quality of non-TTY devices connected to the headset jack.

### **WARNING: 911 Emergency Calling**

Sprint recommends that TTY users make emergency calls by other means, including Telecommunications Relay Services (TRS), analog cellular, and landline communications. Wireless TTY calls to 911 may be corrupted when received by public safety answering points (PSAPs), rendering some communications unintelligible. The problem encountered appears related to TTY equipment or software used by PSAPs. This matter has been brought to the attention of the FCC, and the wireless industry and the PSAP community are currently working to resolve this.



## Security Settings

---

### Protecting Your Device with a Screen Lock

You can increase the security of your device by creating a screen unlock pattern. When enabled, you have to draw the correct unlock pattern on the screen to unlock the device's control keys and buttons and touch screen.

*To create and enable the screen unlock pattern:*



1. Press  >  and tap **Settings > Security > Set unlock pattern**.
2. Read the information on the screen and tap **Next**.
3. Study the example pattern on the screen, and then tap **Next**.
4. Draw the screen unlock pattern by connecting at least four dots in a vertical, horizontal or diagonal direction. Lift your finger from the screen when finished.

**Note:** You must slide your finger on the screen to create the pattern and not tap individual dots.

5. The device records the pattern. Tap **Continue**.
6. When prompted, draw the screen unlock pattern again, and then tap **Confirm**.

**Tip:** Clear the **Use visible pattern** check box if you do not want the unlock pattern to display on the screen when you unlock it.

If you want to disable the unlock screen pattern, clear the **Require pattern** check box. You will be prompted to draw the unlock screen pattern.

**Note:** To change your unlock screen pattern, press  > , and then tap **Settings > Security > Change unlock pattern**.



When you fail to draw the correct unlock pattern on the screen after five attempts, you will be prompted to wait for 30 seconds before you can try again.

### Updating Your Device's System Software

From time to time, system software updates for your device may be available. Your device can automatically check and then notify you if an update is available. You can then download and install the update to your device. Depending on the type of update, the update may erase all your personal data and customized settings, and also remove any programs you have installed. Make sure that you have backed up the information and files you want to keep.

**Note:** Checking and downloading system software updates may incur additional data transfer fees.

*To check for phone system software updates manually*

1. Press  >  and then tap **Settings > System updates > HTC software update**.
2. On the System software updates screen, tap **Check now**.

## Resetting Your Device

Resetting the device deletes all data, including downloaded applications, and resets the device back to its initial state—the state before you turned on the device for the first time.

**Important:** Make sure to back up important data you have on the device before you reset it.

▶ Press  >  and tap **Settings > Privacy > Factory data reset > Reset phone**.

*To reset the device using the device keys:*



1. With the device turned off, press and hold the volume down button (located at the right panel of the device), and then press the power button.
2. When the device's display turns on, release the volume down button.
3. Use the volume buttons to select **CLEAR STORAGE**, and then press the power button. (All data will be deleted from the device.)

## Security Features for Data Services

### Enabling and Disabling Data Services

You can disable data services without turning off your device; however, you will not have access to all data services, including Web and messaging. Disabling data services will avoid any charges associated with these services. While signed out, you can still place or receive phone calls, check voicemail, and use other voice services. You may enable data services again at any time.

*To enable or disable data services:*

1. Press  >  and tap **Settings > Wireless & networks**.
2. Select the **Mobile network** check box to enable data services.  
– or –  
Clear the **Mobile network** check box to disable data services

## Data Synchronization Settings

---

### Synchronizing Google Apps

Your device's Google Apps™, such as Gmail, Calendar, and Contacts, give you access to the same personal information (emails, events, and contacts) that you add, view, and edit on your computer using Gmail or Calendar. Synchronize the Google Apps you want to keep information up-to-date.

**Note:** You need to be signed in to your Google account to synchronize Google Apps.

*To select which Google Apps to synchronize:*

1. Press  >  and then tap **Settings > Accounts & sync**.

**Tip:** Select the **Auto-sync** check box to automatically synchronize all applications. When the **Auto-sync** check box is cleared, you can synchronize individual applications manually by selecting their respective check boxes.

2. Tap **Google**.
3. Select the Google Apps you want to synchronize.

*To stop synchronization:*



- ▶ When the device is synchronizing, tap **Cancel sync** to stop synchronization.

## *Synchronizing Exchange ActiveSync*



You can synchronize your device with your company's Microsoft Exchange Server to let you access your device's Exchange Server account's email, contacts, and calendar events.

**Note:** You need to have an Exchange ActiveSync account set up on your device. See "Email" on page 122.

*To select which Exchange ActiveSync items to synchronize:*

1. Press  >  and tap **Settings > Accounts & sync > Exchange ActiveSync**.
2. Select the Exchange ActiveSync items you want to synchronize.



*To change the synchronization schedule:*

1. Press  >  and tap **Settings > Accounts & sync > Exchange ActiveSync > Schedule**.
2. Tap the time interval the device will check for new data.

*To manually start synchronization:*

- ▶ On the Microsoft Exchange ActiveSync screen, tap **Sync now**.

*To change account settings:*

1. Press  >  and tap **Settings > Accounts & sync > Exchange ActiveSync > Account settings**.
2. Change the general settings, mail, and calendar settings according to your preference.
3. Press .

## *Social Network Settings*



---

### *Logging in to and Synchronizing Your Social Network Accounts*



If you have set up a Facebook for HTC Sense, Flickr, or Twitter account when you first turn on your device, you can quickly login and synchronize information such as status messages and friends list between your device and your social network accounts on the Web.

**Note:** You need to have an existing Facebook, Flickr, or Twitter account.



*To log in to your Facebook or Twitter account:*

1. Press  >  and tap **Settings > Accounts & sync**.
2. Tap **Facebook for HTC Sense** or **Twitter**.
3. Enter your username and password and then tap **Sign in**.



*To log in to your Flickr account:*

1. Press  >  and tap **Settings > Accounts & sync**.
2. Tap **Add account > Flickr**.
3. Enter your Yahoo! ID and password and tap **Sign in**.
4. Follow the screen instructions to log in to your Flickr account.

To synchronize your Facebook or Twitter account:

1. Press  >  and tap **Settings > Accounts & sync**.
2. Tap **Facebook for HTC Sense** or **Twitter**.
3. Tap **Sync now**.

To remove a social network account:

1. Press  >  and tap **Settings > Accounts & sync**.
2. Tap the account you want to remove.
3. Tap **Remove account**.

**Tip:** On the Social Networks screen, press  and tap **Log out all** to log out from all the social network accounts.



## Application Settings

---

### Allowing Third-Party Programs to be Installed



By default, you can only install programs and games downloaded from Android Market™.

To install third-party programs on the device:

- ▶ Press  > , tap **Settings > Applications**, and then select the **Unknown sources** check box.

To uninstall third-party programs on the device:

You cannot uninstall programs that are preinstalled on the device.

1. Press  >  and tap **Settings > Applications > Manage applications**.
2. On the Manage applications screen, tap the application you want to uninstall.
3. On the Application info screen, tap **Uninstall**.

### Clearing Application Cache and Data

Free up storage space and device memory by deleting application cache and data.

1. Press  >  and tap **Settings > Applications > Manage applications**.
2. In the Manage applications list, tap the application whose cache or data you want to delete.

**Tip:** Press  to bring up sort and filter options.



3. In the Application info screen, tap **Clear data** or **Clear cache**.

## Date & Time Settings

---

### Setting Local Date, Time Zone, and Time

By default, your device automatically uses the network-provided date, time zone, and time. However, you can set the date, time zone, and time manually if you need to.

1. Press  >  and tap **Settings > Date & time**.
2. Clear the **Automatic** check box.
3. Tap **Set date**. On the Change date window, adjust the date by scrolling the date wheel. Tap **Done** when finished.
4. Tap **Select time zone**, and then select the time zone in the list. Scroll down the list to view more time zones.
5. Tap **Set time**. On the time window, adjust the time by scrolling the time wheel. Tap **Done** when finished.
6. Select the **Use 24-hour format** check box to toggle between using a 12-hour or 24-hour format.
7. Tap **Select date format**, and then select how you want dates to display on your device. The selected date format also applies to the date displayed in the Alarm Clock.

## Locale & Text Settings

---







### Setting Onscreen Keyboard Settings

8. Press  >  and tap **Settings > Language & keyboard > Touch Input**. (See “Adjusting Touch Input Settings” on page 21 for details.)

## Power-Saving Tips



---

### Adjusting the Display Brightness and Screen On-Time



- Press  > , tap **Settings > Sound & display > Brightness**, and then modify the backlight setting as desired. For more information, see “Display Settings.”
  - or –
- Add the **Power Control** widget to the home screen to easily adjust the screen brightness. Press  and then tap  > **Add to Home > Widget > Power Control**.
- Set a shorter time before the screen turns off when the device is idle. Press  > , tap **Settings > Sound & display > Screen timeout**, and then select a timeout value.
- To turn off the screen, press the power button. The device will continue to function.

## Managing Your Device's Wireless Functions

Disable the 4G, Sprint Mobile Hotspot, Wi-Fi, Bluetooth, and GPS functions of the device when not in use.





- ▶ Press  > , and then tap **Settings > Wireless & networks**. Disable any wireless functions (for example, **Bluetooth** or **Wi-Fi**) that are not in use.

– or –

- ▶ Add a Bluetooth, GPS, and Wi-Fi widget to the home screen. Press  and then tap  > **Add to Home > Widget > Settings**.

## Setting the Email Synchronization Schedule

If you use the device to send and receive email, you can set your email account to download email more or less frequently as desired.

1. Press  and tap  > **Mail**.
2. If you have set up multiple email accounts on your device, switch to the email account that you want to edit by tapping .
3. In the Inbox, press  and tap **More > Settings > Send & Receive > Schedule**.
4. In the **Frequency** section, tap **Peak times** or **Off-peak times**, and then select an email download frequency.

**Note:** The more frequently your device checks for new messages, the more quickly the battery will run down.

**Tip:** You can also close applications that are not in use to conserve battery power. To do so, you will need to download and install a third-party application called a **task manager** from the Android Market. For more information, see “Downloading Applications and Games From Android Market” on page 136.



## 2C. History

- ◆ Viewing History (page 39)
- ◆ Making a Call From History (page 39)
- ◆ Saving a Number From History (page 40)
- ◆ Prepending a Number From History (page 40)
- ◆ Erasing History (page 40)

### Viewing History

History is a list of phone numbers (or People entries) for calls you placed, accepted, or missed. History makes redialing a number fast and easy. It is continually updated as your device automatically adds new numbers to the beginning of the list.

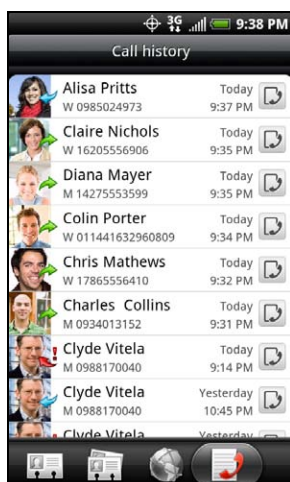

Each entry contains the phone number (if it is available) and People entry name (if the number is in People). Duplicate calls (same number and type of call) may only appear once on the list.

1. Press and tap > **People**.
2. Tap the Call history tab .
3. Tap at the right side of a number of contact to view the call history for that number or contact.

**Note:** History records only calls that occur while the device is turned on. If a call is received while your device is turned off, it will not be included in history.

### Making a Call From History

1. Press and tap > **People**.
2. Tap the Call history tab .
3. Tap an entry on the Call history list to place a call to that entry.



**Note:** You cannot make calls from History to entries identified as **No ID** or **Restricted**.

**Tip:** Press and hold an entry in the Call history list to open the options menu where you can select to view the contact information (if number is stored in People), edit the number before you redial, send a text message, or delete the entry from the Call history list.

## Saving a Number From History

---

If the phone number of a person who called is not in People, you can choose to save the number after you hang up.

1. Press  and tap  > **People**.
2. Tap the Call history tab .
3. Press and hold the received call and then tap **Save to contacts** on the options menu.
4. The phone number is automatically added to the **Mobile** box in the Number section. Enter the name and other contact information.

**Tip:** To store the number as another type (for example, home number), tap the **Mobile** button.

5. Scroll down the screen and tap **Save**.





After you have saved the number, your device displays the new People entry. (See “Displaying an Entry in People” on page 45.)

**Note:** You cannot save phone numbers already in People or from calls identified as **No ID** or **Restricted**.

## Prepending a Number From History

---



If you need to make a call from History and you are outside your local area code, you can add the appropriate prefix by prepending the number.

1. Press  and tap  > **People**.
2. Tap the Call history tab .
3. Press and hold the entry you want to call and tap **Edit number before calling**.
4. Enter the prefix and tap  to call the number.





## Erasing History

---

*To erase a History entry:*

1. Press  and tap  > **People**.
2. Tap the Call history tab .
3. Press and hold the entry you want to delete and tap **Delete from call history**.

*To erase all History entries:*

1. Press  and tap  > **People**.
2. Tap the Call history tab .
3. Press  and tap **Delete all**.

## 2D. People

- ◆ About People (page 41)
- ◆ Using the People Screen (page 42)
- ◆ Adding a New People Entry (page 43)
- ◆ Saving a Phone Number (page 44)
- ◆ Using the Contact Details Screen (page 44)
- ◆ Merging Entries in People (page 45)
- ◆ Editing an Entry in People (page 45)
- ◆ Finding Entries in People (page 47)
- ◆ Backing Up and Importing Entries in People (page 48)
- ◆ Working with Groups (page 48)
- ◆ Using the People Widget (page 49)
- ◆ Connecting with Your Social Networks (page 50)
- ◆ Using Friend Stream (page 52)

### About People

---

In People, you can easily manage your communications with contacts through phone, messaging, and email. You can also view updates on their Facebook, Flickr, and Twitter accounts.



If you are synchronizing contacts with your Google account, with your PC, or with an Exchange Server, any contacts stored in those accounts are displayed in People. You can also synchronize contacts from your Facebook account in People.

#### Ways of Getting Contacts Into Your Device

You can add contacts to your device from:

- **Gmail contacts** that are imported to your device after you set up a Google Account. (For more information, see “Gmail” on page 126 for details.)
- **Phone contacts** (For more information, see “Adding a New People Entry” for details.)
- **Exchange ActiveSync Server** (For more information, see “Email” on page 122 for details.)
- **Contacts on your computer** (For more information, see “HTC Sync” on page 65 for details.)
- **Facebook** (For more information, see “Your Contacts List” for details.)

*To open People:*

- ▶ Press  and tap  > **People**. (You may need to scroll down the screen to see the icon.)

## Using the People Screen

---

The People screen gives you easy access to all your contacts, as well as even faster access to the people and groups of people you contact most often.

The People screen has the following tabs:



1. **All** gives you access to all contacts on your device, including Google contacts, Exchange ActiveSync contacts, Phone contacts, and Facebook contacts. You can also use this tab to open or update My contact card. For more information, see “Setting Up My Contact Card” in this chapter.
2. **Groups** lets you assign contacts to groups so you can easily send an SMS, MMS, or email message to a whole group. (For more information, see “Working with Groups” for details.)
3. **Online directories** lets you search for contacts on your online directories such as your Exchange ActiveSync or Facebook account to copy to your device. (For more information, see “Connecting with Your Social Networks.”)
4. **Call history** lists all your dialed numbers and received and missed calls. (See “History” on page 39 for details.)

### Setting Up My Contact Card

My contact card provides a convenient way to store your personal contact information so that you can easily send it using MMS, email, or Bluetooth.

*To set up My contact card:*

1. On the **All** tab of the People screen, tap **Me**.

**Tip:** If you are logged in to your Facebook account through Facebook for HTC Sense, instead of **Me**, you will see the name you use in Facebook.

2. Enter your name and contact details.
3. Tap **Save**.

## Your Contacts List

The **All** tab of the People screen shows all your contacts, including Google contacts, Exchange ActiveSync contacts, Phone contacts, and Facebook contacts.

**Note:** If you signed in to your Google Account and Facebook account when you first set up the device, your contacts from those accounts will appear in the contacts list when you open People.



1. Add a contact.
2. Edit or update My Contact Card.
3. Tap a contact to open the contact details for that contact.
4. The green icon (  ) appears when the contact:
  - Has sent you a new text or email message, or tried to call you but you missed the call.
  - Has updated his or her Facebook profile or has added photos on Flickr or Facebook.
  - Has upcoming Facebook events.
5. The Facebook status appears when you link the contact to their Facebook account.
6. Tap the photo or icon to open a menu where you can quickly choose how to communicate with the contact. Depending on the contact information stored, you can call, send a message or email, see the contact's Facebook profile, and locate the contact's address in Google Maps.

## Adding a New People Entry

1. On the **All** tab, tap **Add contact** at the top of the screen.

**Note:** If you have set up a Google Account or an Exchange ActiveSync email account, the **Contact type** option appears to determine which account the contact will sync with.



2. Tap the **Name** box, enter the first and last name of the contact, and choose the order in which to display the names. Tap **OK**.
3. Enter the contact information in the boxes provided.
4. Scroll to the bottom of the screen and tap **Save**.

After saving the number, your device displays the new entry in the contacts list.

## Saving a Phone Number

---

To save a number from standby mode:

1. Press  and tap .
2. Enter the phone number by tapping the keys on the keypad.
3. Tap **Save to People**. (This button appears after tapping six digits.)
4. Tap **Add contact** or **Save to existing contact**.
5. Use the keyboard to enter the new contact name and tap **Save** to save the new entry.  
– or –  
Tap an existing contact name and tap **Save** to save the new number.

## Using the Contact Details Screen

---

When you tap a contact on the People screen, the Contact Details screen opens, showing you the information stored for that contact, exchanged messages and phone calls with that contact, Facebook notifications, and more.

The Contact Details screen has the following tabs:



1. **Details** shows the information you have stored for the contact, and allows you to get in touch with the contact directly by tapping any of the displayed methods. For example, if the contact has a stored work phone number, tap **Call Work** to call that number. You can also add one of the contact's phone numbers as a speed dial number. For more information, see "Speed Dialing" on page 19.
2. **Messages** shows your exchanged SMS messages with the contact. Tap a message to view it. To send a new message, tap **New message**. For more information about messages, see "Text Messaging (SMS) and Multimedia Messaging (MMS)" on page 102.
3. **Mail** shows email messages you have received from the contact. Tap an email message to view it. To send a new email, tap **New mail**. For more information about email, see "Email" on page 122.
4. **Updates and events** shows the contact's Facebook status, updates, and events, and shows when he or she uploads new photos to Flickr. When there is a notification of the contact's birthday, you can tap the notification to call the contact directly or send a message greeting.
5. **Gallery** shows the contact's Facebook and Flickr photo albums. For more information, see "Viewing Photos in Your Social Networks."
6. **Call history** lists all your incoming, outgoing, and missed calls to and from the contact. Tap a list item to call the contact using the displayed number.





## Merging Entries in People

---





Merge duplicated entries in People to avoid clutter and confusion. If you have the same contact appear in your Phone, Google, and Facebook accounts, you can merge the contact information into one entry.

The device automatically merges entries that it finds to have similar data. If you need to manually merge entries or break the link between entries, follow the procedures below.

### Manually Merging Entries in People

1. Press  and tap  > **People**.
2. On the **All** tab, tap the entry (not the icon or photo) you want to merge with another entry on your device.
3. On the upper right corner of the screen, tap  or  (if there are suggested links.)
4. On the screen, you can:
  - If there are suggested links, tap  to link the entry to the selected account.
  - Tap one of the options available in the Add contact section.
5. Tap **Done**.

### Breaking the Contact Information Link Between Entries

1. Press  and tap  > **People**.
2. On the **All** tab, tap the entry (not the icon or photo) whose contact information link you want to break.
3. On the upper right corner of the screen, tap .
4. On the Linked contacts section, tap  beside the entry to break the link.
5. Tap **Done**.

## Editing an Entry in People

---

### Displaying an Entry in People

- Press  and tap  > **People**, and then tap an entry.

### Adding a Number to an Entry in People

1. Display an entry in People. (See “Displaying an Entry in People” for details.)
2. Scroll down the screen and tap **Edit**.
3. Scroll down the screen and tap **Add > Phone**.
4. Tap the type of phone number you want to add. (For example, **Home** or **Work**.)
5. Enter the phone number and tap **Save**. (Scroll down the screen to see the **Save** button.)

### Editing an Entry in People

1. Display an entry in People. (See “Displaying an Entry in People” for details.)
2. Scroll down the screen and tap **Edit**.
3. Under the **Phone** section, tap the number you want to edit.
4. Edit the number using the keypad.

**Tip:** Tap the Number type (for example, ) , to change the type of number.

Tap **X** at the right side of a number to delete it.

5. Tap **Save**. (Scroll down the screen to see the **Save** button.)

### *Selecting a Ringer Type for an Entry*

Assign a ringer type to an entry in People so you can identify the caller by the ringer type. (See “Sound Settings” on page 27.)

1. Display an entry in People. (See “Displaying an Entry in People” for details.)
2. Scroll down the screen, and then tap **Ringtone**.
3. Select a ring tone (the ring tone plays back) from the menu and tap **OK**.

### *Assigning a Picture to an Entry*

Assign a picture to display each time a certain contact calls you.

1. Display an entry in People. (See “Displaying an Entry in People” for details.)
2. Scroll down the screen and tap **Edit**.
3. Tap  at the top-left corner of the screen.
4. Tap **Gallery** or **Camera**.
  - If you selected **Gallery**, select an album to find the picture, tap the picture you want to use, crop the picture, and tap **Save**.
  - If you selected **Camera**, the camera will launch and you will use it to take a new picture. (See “Camera and Multimedia” on page 75.)
5. Tap **Save**. (Scroll down the screen to see the **Save** button.)

### *Adding an Email Address to an Entry*

1. Display an entry in People. (See “Displaying an Entry in People” for details.)
2. Scroll down the screen and tap **Edit**.
3. Under the **Email** section, tap the box after .
4. Enter the email address and tap **Save**. (Scroll down the screen to see the **Save** button.)



### *Adding Additional Information to an Entry*

You can add additional information to an entry in People.

1. Display an entry in People. (See “Displaying an Entry in People” for details.)
2. Scroll down the screen and tap **Edit**.
3. Scroll down the screen and tap **Add**.
4. Tap the type of information you want to add such as **Phone**, **Email**, or **Postal address**.





## *Sending an Entry as a vCard Using MMS*

1. Press  and tap  > **People**.
2. On the **All** tab, press and hold the name of the contact (not the icon or photo) whose contact information you want to send, and then tap **Send contact as vCard**.
3. Select the type of information you want to send, and then tap **Send**.
4. Enter the recipient's number or email address, and then tap **Send**.



**Note:** You cannot send a vCard using SMS.

You can also send the vCard using Bluetooth. To learn how to send files through Bluetooth, see “Bluetooth” on page 94.

## *Deleting an Entry*

1. Press  and tap  > **People**.
2. Tap a contact you wish to delete.
3. Press  and then tap **Delete**.
4. Tap **OK** to confirm the deletion.



## *Deleting Multiple Entries*

1. Press  and tap  > **People**.
2. On the **All** tab, press , and then tap **Delete**.
3. Select the entries you want to delete, and then tap **Delete**.
4. Tap **OK** to confirm the deletions.



## *Finding Entries in People*

---

### Finding Contacts by Name

1. Press  and tap  > **People**.
2. Scroll through all the entries.  
– or –  
Press  and enter the first letter or letters of a name (such as “dav” for “Dave”). (The more letters you enter, the more your search narrows.)
3. To display an entry, tap an entry.
4. To dial the entry's default phone number (Primary), tap the number under **Action**.

### Finding Group Entries

1. Press  and tap  > **People**.
2. Scroll to the **Groups** tab.
3. Scroll through the group titles. To display entries belonging to a group, tap the group name.
4. To display an entry within the group, tap the entry.
5. To dial the entry's default phone number (Primary), tap the number under **Action**.

See “Working with Groups” for more details.

## Backing Up and Importing Entries in People



---

### Backing Up People Entries to the Storage Card

1. Press  and tap  > **People**.
2. Press  **menu**, and then tap **Import/Export** > **Export to SD card**.
3. When asked to confirm, tap **OK**.

### Importing Entries From the Storage Card

You can only import contacts that were exported to the storage card using the Export to SD card feature on the device. See “Backing Up People Entries to the Storage Card”.

1. Press  and tap  > **People**.
2. Press  **menu**, and then tap **Import/Export** > **Import from SD card**.
3. If you have Google or Exchange ActiveSync accounts set up on your device, tap the type for the imported contacts.



**Tip:** Press  to stop importing contacts from the storage card.

## Working with Groups





---

On the **Groups** tab, you can assign contacts to groups so you can easily send SMS, MMS, or email messages to a whole group. You can also sync your device's groups with the groups in your Google account, accessible using your computer's Web browser.



### Creating a Group and Adding Entries

1. Press  and tap  > **People** > **Groups** tab > **Add group**.
2. Enter a name for the group and tap **Add contact to group**.
3. Select the entries you want in the group. You can use the search bar to search for entries quickly.
4. Tap **Save**.

### Adding or Removing Entries From a Group

1. Press  and tap  > **People** > **Groups** tab.
2. Press and hold a group and tap **Edit group**.
3. To add entries to the group, tap **Add contact to group**, tap the entries you want to add, and tap **Done**.  
– or –  
To remove entries from the group, tap  at the right side of the entry you want to remove.
4. Tap **Save**. (Tap  to close the keyboard if you do not see the **Save** button.)



## *Sending a Text or Multimedia Message to All Entries in a Group*

1. Press  and tap  > **People** > **Groups** tab.
2. Tap the group you want to send a message to.
3. Go to the **Group action** tab, and then tap **Send group message** to send a message to the group.

**Note:** You will be charged per group member for each message sent. For example, if you send a message to a group of five people, you will be charged for five messages.

For instructions on composing and sending your message, see “Composing Text Messages” on page 102.

## *Sending an Email Message to All Entries In a Group*

1. Press  and tap  > **People** > **Groups** tab.
2. Tap the group you want to send an email to.
3. Go to the **Group action** tab, and then tap **Send group mail** to send an email to the group.
4. Tap **Compose** to use Gmail to send the email message. (You need to be signed in to your Google account to use Gmail.)
  - or –
  - Tap **Mail** to use your Exchange ActiveSync or POP3/IMAP email account to send the email message. (You need to have an email account set up on your device.)

For instructions on composing and sending your message, see “Composing and Sending Email” on page 123.

## *Deleting a Group*



1. Press  and tap  > **People** > **Groups** tab.
2. Press and hold a group and tap **Delete group**.

## *Using the People Widget*

---

Put the group of people you contact most right on the Home screen of your device by adding them as the People widget. Using the People widget, you can instantly place a call, send a message, or view details of a favorite contact with a single tap.

### *Adding the People Widget*

1. Press  and tap  > **Widget** > **People**.
2. Choose the widget style, and then tap **Select**.
3. Select the group you want to add as a widget.
4. Drag the widget to a blank Home screen, and then release.

**Tip:** The People widget requires a whole screen.

### *Setting the Default Communication Method*

1. Press , and then go to the People widget.
2. Tap a contact on the widget.
3. On the Select default action screen, tap the communication method you want for the contact.

## Changing the Default Communication Method

If you want to change the default action for communicating with a contact on the People widget, you must first remove this contact from the group. Add this contact back to the group, and then choose the new communication method.

1. Remove the contact from the group. See “Adding or Removing Entries From a Group” on page 48 for details.
2. Add the contact back to the group. See “Adding or Removing Entries From a Group” on page 48 for details.
3. Choose the default communication method. See “Setting the Default Communication Method” for details.

## Getting In Touch with a Contact

1. Press , and then go to the People widget.
2. Do any of the following:
  - Tap a contact’s icon or photo on the widget. The default communication method will be performed. If you have not set a default communication method, the Select default action screen will open. See “Setting the Default Communication Method” for details.
  - Tap the name of the contact to open the contact details screen. On the contact details screen, choose how you want to communicate with the contact by tapping an option under Action.

## Connecting with Your Social Networks

---

### Facebook for HTC Sense

View your Facebook® updates in supported applications on the device. See “Logging in to and Synchronizing Your Social Network Accounts” on page 35 to learn how to sign in to Facebook for HTC Sense.

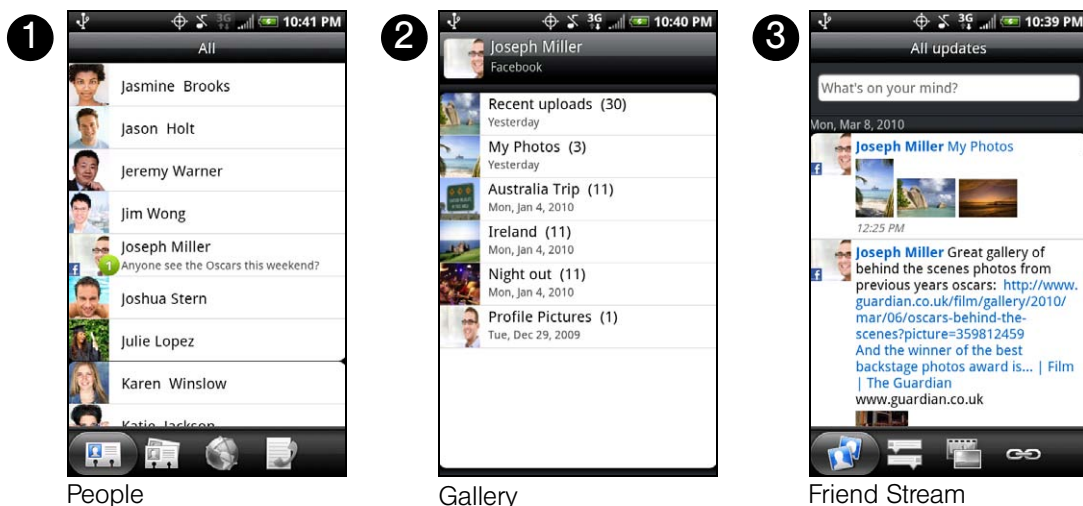

After signing in to Facebook for HTC Sense, you can:



1. Download your Facebook contacts and their contact details to People on your device. Your Facebook contacts’ status updates display on your contacts list.
2. Browse through Facebook photo albums in Gallery. For more information, see “Viewing Photos in Your Social Networks” on page 83

3. Read Facebook status updates in Friend Stream. For more information, see “Using Friend Stream”.



### Updating Your Facebook Status

1. Press  and tap  > **People** > **All** tab.
2. Tap **Me** or **[Your Name]** > **Facebook**.
3. Enter your status in the “What’s on your mind” text box and tap **Share**.

### Synchronizing Facebook for HTC Sense

See “Social Network Settings” on page 35.

### Changing Facebook for HTC Sense Update Settings



1. Press  >  and tap **Settings** > **Accounts & sync**.
2. Tap **Facebook for HTC Sense**.
3. Tap **Account settings** > **Update schedule**, and then select the time interval.

## Facebook for Android

The Facebook® application on your phone lets you keep up and stay close with your friends in Facebook. It offers most of the features that you are familiar with when using Facebook on your computer.

If you have more than one Facebook account, you can sign in to the Facebook application using your other Facebook account.

### Opening Facebook

1. Press  and then tap  > **Facebook**.
2. If this is your first time to use Facebook, follow the onscreen instructions to sign into your Facebook account. Your Facebook profile is then displayed on the screen.
3. Press  to go to the Facebook home screen and access other functions.

**Note:** While on the Facebook home screen, press , and then tap **Settings** to set refresh and notification options.

On some Facebook screens, you can press and hold an item to open an options menu.

With the Facebook application, you can:

- Share your thoughts and check other people’s status updates.
- View your friends list and write on someone’s wall.
- Comment on and like a friend’s post.
- View someone’s personal information, including photo albums.
- Check your Facebook notifications.
- Take a photo and upload it straight to your Facebook account.

### Adding the Facebook Widget

Add the Facebook widget to the Home screen to let you quickly share your thoughts and view your friends’ status updates.

1. Press  and then tap  > **Widget** > **Facebook**.
2. Choose the widget style, and then tap **Select**.
3. Drag the widget to a blank space on the Home screen, and then release.

## Facebook FAQ



### What are the differences Between Facebook for HTC Sense and Facebook for Android Application?

- Facebook for HTC Sense is not a standalone application. It is integrated into People, Friend Stream, and Gallery to give you up-to-date information about your Facebook contacts (their status updates and new photos) in these applications.
- The Facebook for Android application is a standalone application. Use this application to do most of the things that you would do when you're using your computer's Web browser to access your Facebook account, such as adding a friend and adding captions to photos you upload.
- The two do not share the same login credentials. Signing in to Facebook for HTC Sense does not sign you in to the Facebook application and vice versa. If you want to use the same Facebook account for both, you'll have to sign in to both using the same login credentials.

## Using Friend Stream

Streamline your social network accounts through Friend Stream. Update your status simultaneously, view status updates, and look through photo updates from your Facebook, Twitter, and other social network accounts using Friend Stream.

### Opening Friend Stream

1. Press  and then tap  > **Friend Stream**.
2. If you are not signed in to a social network account, you will be asked to sign in to at least one of the social network accounts.
3. Friend Stream opens in the All updates tab. Slide your finger on the bottom row to go to the tab you want.

### The Friend Stream Screen



Only updates from accounts that you are signed in to will be shown. You can filter the updates that show in Friend Stream by pressing , and then tapping **Settings > Show updates**.



1. Tap to enter and send a status update.
2. Depending on the type, tap to open Peep, post a Facebook comment, look at the Flickr album, or open the link in the Web browser.
3. Shows all the messages from the social network accounts that you are signed in to.
4. Shows only links posted on Facebook.

5. Shows only photo updates from Facebook and Flickr.
6. Shows only status updates from Facebook and Twitter.

### *Updating Your Status*

1. Press  and then tap  > **Friend Stream**.
2. On the All Updates tab, tap the text field with the words “What’s on your mind?”.
3. Tap , and then on the Update dialog box, select which accounts you want the status update to be posted. Tap **Done**.

**Note:** Only the accounts that you are signed in to will be shown on the dialog box.

4. Enter your status update, and then tap **Share**.

### *Adding the Friend Stream Widget*

Add the Friend Stream widget so you can update your status simultaneously and view status updates from your social network accounts right on the Home screen.

1. Press  and tap  > **Widget** > **Friend Stream**.
2. Choose the widget style, and then tap **Select**.
3. Drag the widget to a blank space on the Home screen, and then release.

## 2E. Calendar and Tools

- ◆ Calendar (page 54)
- ◆ Calculator (page 59)
- ◆ Clock (page 59)
- ◆ Quickoffice (page 63)
- ◆ PDF Viewer (page 64)
- ◆ HTC Sync (page 65)
- ◆ Updating Your Device (page 68)

### Calendar

---

Use Calendar to create and manage events, meetings, and appointments. Your Calendar helps organize your time and reminds you of important events. Depending on your synchronization settings, your device's Calendar stays in sync with your Calendar on the Web, Exchange ActiveSync calendar, and Outlook calendar.

#### Adding an Event to the Calendar

1. Press  and tap  > **Calendar**.
2. On any Calendar view, press  and tap **New event** to open the Event details screen.

**Note:** If you are in Agenda or Month view, you can also tap  at the bottom-right of the screen.

If you are in Day view, tap **Add event**.

3. If you have more than one calendar, select a calendar in which to add the event:
  - Select **My Calendar** to create an event that will appear only on your device.
  - Select your Google Account to create a Google Calendar event. If you have several Google Calendars on the Web, select one in which to add your event.

**Note:** You can create multiple Google Calendars only in Google Calendar on the Web. After creating them in Google Calendar on the Web, you'll be able to see them in the Calendar application on your device. For more information about creating and managing multiple Google Calendars, visit the Google website at the following URL:  
<http://calendar.google.com>.

If you have synchronized your device with an Exchange ActiveSync account or Outlook on your computer, you can also select these calendars.

- Select **PC Sync** to create an Outlook Calendar event to sync with your computer.
  - Select **Exchange** to create an Exchange ActiveSync calendar event.
4. Enter a name for the event.
  5. To specify the date and time of the event, do one of the following:
    - If there is a time frame for the event, tap the **From** and **To** dates and times to set them.
    - If the event is a special occasion such as a birthday or an all-day event, set the **From** and **To** dates, and then select the **All Day** check box.
  6. Enter the event location and description.



7. Set the event reminder time.

**Note:** You can add another reminder time in a Google Calendar event. Press  and then tap **Add reminder** to add another reminder.

8. If the event occurs on a regular basis, tap the **Repetition** box and then choose how often the event occurs.
9. Scroll to the bottom of the screen and then tap **Save**.

### *Inviting Guests to Your Event (Google Account Only)*



If you want to invite guests to your event, you need to create and add the event in your Google Calendar. An invitation email will be sent to your guests using your Google Account.

1. Open Calendar and create a new event. Tap the **Calendar** field and then select your Google Account (or one of your other Google Calendars). For the steps, see “Adding an Event to the Calendar.”
2. Add details about the event, such as date and time, location, and more.
3. In the **Guests** field, enter the email addresses of everyone you want to invite to the event. Separate multiple addresses with commas ( , ).
4. Tap **Save** to add the event to your Google Calendar.

If the people to whom you send invitations use Google Calendar, they’ll receive an invitation in Calendar and by email.

### *Sending a Meeting Request (Exchange ActiveSync only)*

If you have an Exchange ActiveSync account set up on your device, you can use Calendar to create a meeting appointment and send a meeting request email to the people you want to invite to your meeting.

1. Open Calendar and create a new event. Tap the **Calendar** field and then select **Exchange**. For the steps, see “Adding an Event to the Calendar.”
2. Add details about the meeting, such as date and time, location, and more.
3. Press  and then tap **Meeting Invitation**.
4. Tap  and choose attendees from your contacts or Company Directory.
5. Enter the email subject and your message, and then tap **Send**.
6. Tap **Save** to add the meeting appointment to your Exchange ActiveSync Calendar.

### *Event Alerts*

When your device is turned on and you have an event alarm scheduled, your device alerts you and displays the event summary. There are several ways your device alerts you to scheduled events:

- By playing the assigned ringer type.
- By showing the  icon on the status bar.
- By showing the Alert screen.

### *Event Reminders*

If you have set at least one reminder for an event, the upcoming event icon (  ) will appear in the notifications area of the status bar to remind you of the upcoming event.

*To view, dismiss, or snooze the reminder:*

1. Press the status bar, and then slide your finger down the screen to open the Notifications panel.
2. Tap the upcoming event name to display the event.

**Note:** If you have other pending event reminders, these events will also appear on the screen.

3. Do one of the following:

- Tap **Snooze all** to snooze all event reminders for five minutes.
- or –
- Tap **Dismiss all** to dismiss all event reminders.
- or –
- Press  to keep the reminders pending in the notifications area of the status bar.

*To set reminder settings:*

- ▶ On any Calendar view, press  and tap **More > Settings > Reminder settings**.

## Viewing Events

You can display the Calendar in daily, weekly, monthly, or agenda view. To change the Calendar view, press  and tap **Day, Agenda, Week, or Month**.

### Day and Agenda Views

Day view displays a list of the events of one day and also shows weather information at the bottom of the screen when you're viewing events of the current day. Agenda view shows a list of all your events in chronological order.

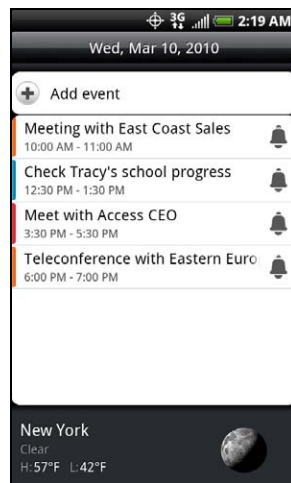

Day view

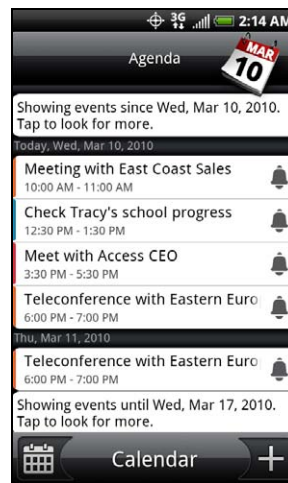

Agenda view

The color bars on the left side of the events indicate the type of calendar in which the event is part of. To find out what each color represents, press  and then tap **More > Calendars**.

When in **Day** view, slide left or right across the screen to view earlier or later days.

**Note:** In Day view, the weather information appears only if the event is within the five-day forecast of the Weather application.

Weather information does not appear in Day view when you change Day view to display as a time list. To check, in any calendar view, press , and tap **More > Settings > Calendar view setting > Day views**.

## Week View

Week view displays a chart of the events of one week.

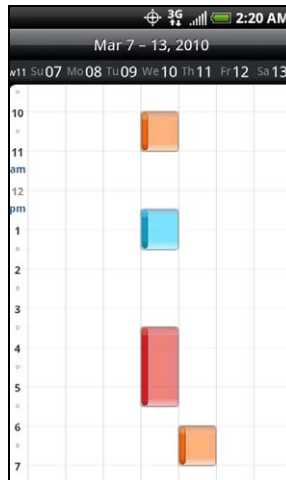

When in **Week** view:



- You can press and hold on a time slot to create a new event at that time.
- Tap an event to view its details.
- Slide left or right across the screen to view earlier or later weeks. Swipe your finger left or right to go to the earlier or later week.

## Month View

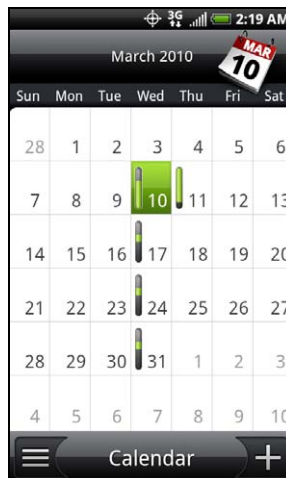

In Month view, you'll see markers on days that have events.



When in **Month** view:

- Tap  on the bottom left of the screen to switch to **Agenda** view. Tap  on the bottom right to create a new event.
- Tap a day to view the events of that day.
- Press and hold a day to open an options menu from which you can also choose to create an event or switch to either **Day** or **Agenda** view.
- Slide your finger up or down the screen to view earlier or later months.

## Erasing Events

1. Press  and tap  > **Calendar**.
2. Open the calendar event details by:
  - In **Agenda, Day, and Week** views, tap the calendar event you want to delete.
  - In **Month** view, tap the date where the calendar event occurs, and tap the calendar event.
3. Press  and tap **Delete event**.
4. In the Delete confirmation box, tap **OK**.
  - or –
  - If the calendar event is recurring, select **Only this event** or **All events**, and tap **OK**.

## Showing or Hiding Calendars



In any Calendar view, press , tap **More > Calendars**, and then select or clear a calendar to show or hide it. Tap **All calendars** to display all calendars.

The calendars are kept synchronized on your device, whether or not you hide them.

## Choosing Google Calendars to Synchronized with Your Device

You can choose which Google Calendars to keep synchronized on your phone or which ones to stop synchronizing.



### Stop Synchronizing a Google Calendar

1. In any Calendar view, press  and tap **More > Calendars**.
2. Press  and tap **Remove calendars**.
3. Select a Google Calendar to remove from your calendars list, and then tap **OK**.
4. Press  to update Calendar with the new changes and return to the Calendar view you were viewing.

The calendars that you remove from your calendars list will no longer be synchronized on your device, but you remain subscribed to them and can work with them in Google Calendar on the Web.

### Adding a Google Calendar to Synchronize

Only the calendars that you've created or subscribed to on the Web, but previously removed from your calendars list, are shown in the list of calendars that you can add.

1. In any Calendar view, press  and tap **More > Calendars**.
2. Press  and tap **Add calendars**.
3. Select a Google Calendar to add to your calendars list, and then tap **OK**.
4. Press  to update Calendar with the new changes and return to the Calendar view you were viewing.

## Synchronizing Exchange ActiveSync Calendar

If you have set up a Microsoft Exchange ActiveSync account on your device, you can also synchronize Exchange ActiveSync calendar events on your device. Calendar events on your Exchange ActiveSync will also show in Calendar if you chose to synchronize with the Exchange ActiveSync Server.



- To check if Exchange ActiveSync items are set to be synchronized, go to the Home screen, press , and tap **Settings > Accounts & sync > Exchange ActiveSync**.

## Synchronizing Outlook Calendar

See “HTC Sync” on page 65 for details.

## Sending a vCalendar

You can send a calendar event as a vCalendar to someone’s phone or your computer using Bluetooth. You can also send it as a file attachment with your message.

1. Press  and tap  > **Calendar**.
2. Press and hold the calendar event you want to send, and then tap **Share vCalendar**. In Month view, you need to tap the day when the event takes place before you can press and hold the event.
3. Choose whether to send the event using Bluetooth, Mail (email), or Message (Multimedia message or MMS).
4. Do one of the following:
  - If you chose to send using Bluetooth, in the next few steps, you’ll be asked to turn on Bluetooth on your device and connect to the receiving Bluetooth device so the vCalendar can be sent. For more information, see “Using Bluetooth” on page 94.
  - If you chose to send by email, a new message window opens and automatically includes the vCalendar as an attachment. Your default email account that’s selected in the Mail application will be used to send. For more information, see “Composing and Sending Email” on page 123.
  - If you chose to send by multimedia messaging (MMS), a new multimedia message window opens and automatically includes the vCalendar as an attachment. Enter your message recipients, compose your MMS message, and then tap **Send**. For more information, see “Sending a Multimedia Message (MMS)” on page 103.

## Calculator

---

Your device comes with a built-in calculator.

1. Press  and tap  > **Calculator**.
2. Enter numbers or formulas using the onscreen keys.

**Tip:** To switch to a scientific calculator, turn your device sideways to your left. The scientific calculator lets you perform more complex calculations with square roots, logarithmic, and trigonometric functions.

Tap  to remove one digit at a time. Press and hold  to delete the entire number.

3. Tap  for the result.

## Clock

---

The Clock application is more than just a regular date and time clock. It functions as a desk clock that shows the date, time, and weather information, and it can turn into a night clock or screensaver. It has a world clock that shows you the current time in several locations across the globe. There’s also an alarm clock, stopwatch, and countdown timer.

*To open the Clock application:*

- ▶ Press  and tap  > **Clock**.

Tap the tabs at the bottom row or slide your finger across the tabs to switch between the different functions of the Clock application.



1. **Desk Clock** For more information, see “Clock.”
2. **World Clock** For more information, see “World Clock.”
3. **Alarms** For more information, see “Alarm Clock.”
4. **Stopwatch** lets you use the clock as a stopwatch.
5. **Timer** lets you use the clock as a timer.

## Desk Clock

Opening the Clock application brings you directly to the Desk Clock screen.

The Desk Clock displays the current date, time, and weather, an alarm clock indicator, and a battery charging indicator. You can dim the screen to show only the time and date on the Desk Clock.



1. **Weather information of your current location.** Tap the weather information to open the Weather application where you can see weather forecasts of the next few days. For more information, see “Weather” on page 141.
2. **Dim button** dims the screen and displays only the time and date on the Desk Clock. To light up the screen again, tap anywhere on the screen or press (↶).
3. **Alarm clock indicator** shows whether the alarm clock is on or off. To find out how to turn on and set the alarm clock, see “Alarm Clock.”
4. **Screensaver button** dims the screen and go into screensaver mode. When in screensaver mode, the time and date will change position on the screen after every few minutes. To light up the screen again, tap anywhere on the screen or press (↶).
5. **Battery charging indicator** shows the battery charge level. You’ll see it only when your device is plugged with the power adapter or connected to your computer.

You can change the Desk Clock screen to display the date and time of another time zone. For more information, see “World Clock.”



## World Clock

Use the Clock application's World Clock screen to check the current time in several places around the globe simultaneously. You can also set your home city, add more cities to the world clock list, and manually set your time zone, date, and time.



*To view the time in different locations:*

- ▶ Press  and tap  > **Clock** > **World Clock** tab.



*To add cities to the World Clock list:*

1. Press  and tap  > **Clock** > **World Clock** tab > **Add city**.
2. Enter the city name you want to add. A list of matching cities and countries based on the letters you entered appear on the screen.
3. Tap the city.

*To designate your home city:*



1. Press , tap  > **Clock** > **World Clock** tab, and then press  > **Home settings**.
2. Enter your home city name. A list of matching cities and countries based on the letters you entered appear on the screen.
3. Tap your city when it appears on the list. Your home city will appear at the top of the list of cities.

*To delete a city on the World Clock list:*

1. Press , tap  > **Clock** > **World Clock** tab, and then press  > **Delete**.
2. Tap the cities you want to remove and tap **Delete**.

*To manually set the time zone, date, and time:*

To set the time zone, date, and time on your device manually, you need to turn off auto time synchronization first.



1. Press  and then tap the HTC Clock widget on the Home screen.
2. Tap the **World Clock** tab.
3. Press  and then tap **Local time settings** to open the Date & time settings screen.
4. Clear the **Automatic** check box.
5. Tap **Select time zone**. Scroll through the list and then tap the time zone that you want.
6. To change the date, tap **Set date**. Adjust the date by sliding your finger up or down on the day, month, and year, and then tap **Done**.
7. To change the time, tap **Set time**. Adjust the time by sliding your finger up or down on the hour and minute, and then tap **Done**.
8. Tap the **Use 24-hour format** check box to switch between using a 12-hour or a 24-hour time format.
9. Tap **Select date format** then select how you want dates to be displayed. (The selected date format also applies to the date displayed in the alarm clock.

## Alarm Clock

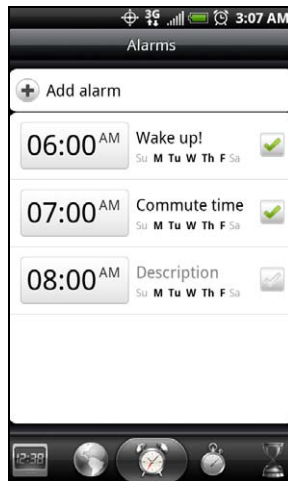
Your device comes with a built-in alarm clock that has multiple alarm capabilities.



### Setting an Alarm

1. Press  and tap  > **Clock** > **Alarms** tab.
2. Tap one of the default alarms on the screen.
3. In the Set alarm screen, set the alarm time by sliding your finger up or down on the numbers and AM/PM.
4. Enter the alarm **Description**, set the **Alarm sound** and **Repeat**, and select the **Vibrate** check box if you want the device to also vibrate when the alarm goes off.
5. Tap **Done**.

**Tip:** If you need to set more than 3 alarms, you can add more alarms by tapping **Add alarm**.



**Note:** You can temporarily disable an alarm by clearing the check box (  ) of the alarm on the **Alarms** tab.

### Deleting an Alarm

1. On the **Alarms** tab, press  and tap **Delete**.
2. Select the alarms you want to delete and then tap **Delete**.

### Changing Alarm Sound Settings

If you've set one or more alarms, you can change their settings such as the alarm volume, how long to snooze the alarm, and more.

1. Press  and tap  > **Clock** > **Alarms** tab.
2. Press  and tap **Settings**. You can change the following settings:
  - **Alarm in silent mode** This option is selected by default, which allows the alarm to sound even when your device's volume is set to silent mode. Clear this check box if you want to silence the alarm when the volume is in silent mode.
  - **Alarm volume** Set the volume level that you want for the alarm.
  - **Snooze duration** Set how long to snooze between alarms.
  - **Side button behavior** Choose what happens to the alarm when pressing the volume buttons of your device. You can set the button to snooze, dismiss the alarm, or disable the button. The side button works only when the device's screen is not locked. While on the lock screen, tap the onscreen **Snooze** button to snooze, or slide down the screen to dismiss the alarm.





## Quickoffice

Quickoffice lets you view Microsoft Office Word, Microsoft Office Excel, and Microsoft PowerPoint files on your device. Quickoffice supports viewing of Microsoft Office 2003 and 2007 Word (.doc), Excel (.xls), PowerPoint (.ppt) and text (.txt) files.

### Viewing Documents, Presentations, and Spreadsheets

Make sure you have copied the files to the device's microSD card before you open Quickoffice.

1. Press  and tap  > **Quickoffice**. (You may need to scroll down the screen to see the icon.)
2. Tap the file you want to open.

**Tip:** In the Open file screen, press  and tap **Sort** to let you sort the list by name or date.

3. Slide your finger on the screen to scroll horizontally or to flip through the pages of the file.

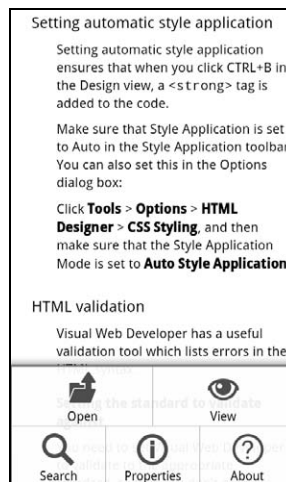

Quickoffice while viewing a Word document

4. While viewing a file:
  - Pinch the screen to zoom in or out or use the zoom controls on the screen to zoom in or out.
  - For Excel files, press  and then tap **Worksheet** to view other worksheets on the file.
  - For Word and PowerPoint files, tap a URL link to open the Web page in the browser.
  - When you open Word documents, Quickoffice reflows the text to make it fit the width of the screen. Double-tap the screen to switch to continuous view so you can view the page layout.

**Note:** Quickoffice does not reflow text in tables.



- When you view PowerPoint files, after your zoom in on a slide, you can double-tap the screen to zoom out automatically and fit the slide to the width of the screen.

## PDF Viewer

---

Use PDF Viewer to view PDF files that you have copied to the device's microSD card.

### Viewing a PDF File

1. Press  and tap  > **PDF Viewer**. (You may need to scroll down the screen to see the icon.)
2. On the Open file screen, tap the file you want to view.
3. Slide your finger on the screen to pan or go through the pages of the PDF file. While viewing a PDF file, press  to let you open another PDF file, zoom in, search the file, and more.

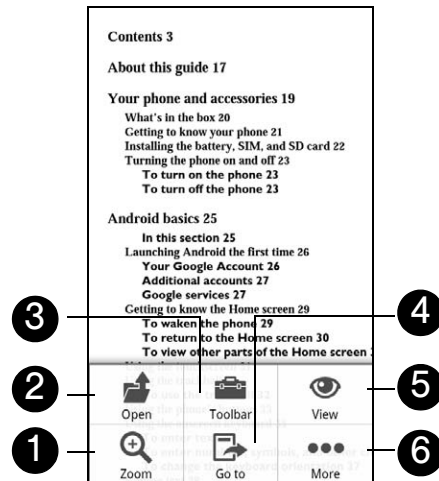

1. **Zoom** to zoom in on the page. You can also tap the screen quickly twice to zoom in or out of the page.
2. **Open** to open another PDF file.
3. **Toolbar** to toggle between showing and hiding the page toolbar.
4. **Go to** to go to a specific page on the PDF file.
5. **View** to let you change the view: **Continuous** or **Reflow**.
6. **More** to search for text in the PDF file, and view properties or information about PDF Viewer.

## HTC Sync

---

HTC Sync™ lets you synchronize Outlook and Windows Address Book (Outlook Express) contacts and calendar events on your computer with your device. It also lets you back up and sync these information from your device back to your computer before you do a factory reset or a software (ROM) upgrade of your device. HTC Sync also enables you to install third-party Android applications on the device.

Here's what you'll need to do to install, set up, and use HTC Sync on your computer:

1. Use the HTC Sync installer that's in the supplied microSD card to install. For the steps on how to install, see "Installing HTC Sync From the microSD Card."  
You can also download and install HTC Sync from the HTC support website. See "Downloading the Latest HTC Sync Upgrade" for details.
2. Connect your device to your computer using the supplied USB cable and set up HTC Sync to recognize your device. Follow the steps in "Setting Up HTC Sync to Recognize Your Device."
3. Choose what information to sync between your computer and your device and how you want to sync them.
  - To easily set up synchronization using HTC Sync's guided wizard, follow the steps in "Setting Up Synchronization."
  - To choose from more sync options, see "Setting up More Sync Options."
4. Sync your computer with your device automatically or manually. See "Synchronizing Your Device" for details.

### Installing HTC Sync From the microSD Card

The HTC Sync version in the microSD card that came with your device can be installed in Windows 7, Windows Vista, and Windows XP.

Make sure that the microSD card is inserted on your device. Copy the HTC Sync installer from the microSD card to your computer and use it to install.

**Important:** HTC Sync requires USB 2.0 on your computer to connect and sync with your device. To see a complete list of the computer and software requirements, you can check them in the HTC Sync software download page on the HTC support website:  
[http://www.htc.com/www/SupportViewNews.aspx?dl\\_id=847&news\\_id=471](http://www.htc.com/www/SupportViewNews.aspx?dl_id=847&news_id=471)

For trouble-free installation, first quit all running programs and temporarily disable your anti-virus program before you start installing HTC Sync.

1. Connect your device to your computer using the USB cable that came with your device.
2. On the Connect to PC screen on your device, tap **Disk drive** and then tap **Done**.
3. After you've selected disk drive mode on your device, your computer will treat your device as a removable disk (just like any USB drive). Open this removable disk so you can see what's inside the microSD card.
4. Copy **HTCSync.exe** to your computer.
5. After copying, unmount the removable disk (that is, the connected device) as required by your computer's operating system to safely remove your device.
6. On your computer, double-click **HTCSync.exe** and follow the onscreen instructions to install HTC Sync.

## Setting Up HTC Sync to Recognize Your Device

After installing, set up HTC Sync to recognize your device.

1. Connect your device to the computer with the supplied USB cable. Or, if your device is already connected, press and hold the status bar and drag your finger down to open the Notifications panel. Then tap the status that shows **Select to change USB connection type**.
2. On the Connect to PC screen in your device, tap **HTC Sync** and then tap **Done**.
3. Your device attempts to find HTC Sync on your computer. Wait for a few seconds for the process to finish

**Note:** If your device displays a message indicating that it's unable to find HTC Sync, try disconnecting and reconnecting the USB cable, and then repeat step 2.

4. When your device finds HTC Sync, your computer will display the Phone Connection Wizard. Click **Next**.
5. Enter the name you want for your device, and then click **Finish**.
6. Check the HTC Sync icon at the bottom-right side of your computer screen. If it appears green in color, that means your device has successfully connected with your computer and HTC Sync recognizes your device.



## Setting Up Synchronization

You can set up HTC Sync to synchronize your computer's Outlook contacts and calendar events with your device. If you're using Outlook Express on your computer, you can only sync contacts with your device.

**Important:** Before you begin setting up synchronization, make sure you have set up HTC Sync to recognize your device. If you have not yet done so, follow the steps in "Setting Up HTC Sync to Recognize Your Device."

1. On your computer, make sure the HTC Sync icon  at the bottom-right side of the screen appears in green, which means that your device is connected to HTC Sync.
2. Double-click the green HTC Sync icon on your computer to open HTC Sync.
3. Click **Synchronize Now**. (You can also click **Sync Manager > Settings**.)
4. In the Synchronization Settings Wizard, click **Next**.
5. In the next few dialog boxes, choose whether to sync Outlook or Outlook Express, select the type of information to sync (contacts or calendar), and choose to sync them automatically or manually with your device.
6. Click **Finish**.  
HTC Sync then starts to sync your device and your computer. Wait for the synchronization to finish.
7. A summary report is then displayed. Click **Close**.

## Setting up More Sync Options

HTC Sync gives you the flexibility to set many options, such as setting a sync schedule, choosing how to resolve conflicts when the same items are found on both the device and the computer, and more.

1. On your computer, make sure the HTC Sync icon  at the bottom-right side of the screen appears in green, which means that your device is connected to HTC Sync.
2. If HTC Sync is not open, double-click the green HTC Sync icon to open it.
3. Click **Sync Manager > Settings**.
4. In the Synchronization Settings Wizard dialog box, click **Manual settings**.



5. From the left side of the Sync Manager Settings dialog box, click the type of setting you want to change, and then choose from the available options on the right. Settings that can be changed include the following:
  - **Contacts or Calendar folder to sync with** Change this only if you have personal folders created in your Outlook and you need to sync with a personal folder. Click **Contacts** or **Calendar** on the left side of the dialog box, click the **Properties** button, and then choose the personal folder to sync with.
  - **Calendar events to sync with** Choose the number of days of calendar events to sync. Click **Calendar** on the left side of the dialog box, click **Properties**, and then set the days under **Date range**.
  - **Conflict policy** In cases when the same contacts or calendar items exist in both your device and your computer, choose whose data you want to keep when a conflict occurs.
  - **When to sync** Click **Automatic sync** on the left side of the dialog box. Then choose whether to sync manually, auto sync everytime you connect your device to your computer, or sync at a set schedule.
6. Click **Apply** to save the sync options you've selected, and then click **OK**.

## *Synchronizing Your Device*

After you've installed and set up HTC Sync, you can sync your device with your computer.

### *Synchronizing Your Device Automatically with Your Computer*

Do the following first to make sure your device will sync automatically with your computer:

1. Press  > , and then tap **Settings > Applications > Development**.
2. Make sure the **USB debugging** check box is selected.
3. Whenever you connect your device to your computer, synchronization starts automatically. Wait for the sync process to finish.

### *Synchronizing Your Device Manually with Your Computer*

1. Connect your device to the computer with the supplied USB cable. Or, if your device is already connected, press the status bar and drag your finger down to open the Notifications panel. Then tap the status that shows **Select to change USB connection type**.
2. On the Connect to PC screen in your device, tap **HTC Sync** and then tap **Done**.
3. On your computer, make sure that the HTC Sync icon  at the bottom-right side of the screen appears in green, which means that your device is connected to HTC Sync.
4. On your device, tap **Sync now**.

## *Downloading the Latest HTC Sync Upgrade*

Visit the HTC support website ([www.htc.com/support](http://www.htc.com/support)) from time to time to check for the most recent HTC Sync upgrade so you can download and install it on your computer.

After installing the latest upgrade, set up HTC Sync again to recognize and sync with your device. Follow the steps in "Setting Up HTC Sync to Recognize Your Device" and "Setting Up Synchronization."

## Installing Apps From Your Computer to Your Device

If you have applications (.apk files) on your computer, you can use HTC Sync to install them to your device. We strongly recommend you install only applications that you trust.

1. On your device, press  > , tap **Settings > Applications**, and then select the **Unknown sources** check box to allow applications from your computer to be installed to your device.

**Note:** You only have to do this step once. You do not need to do this step again next time you install another application from your computer to your device.

2. Connect your device to the computer with the supplied USB cable. Or, if your device is already connected, press the status bar and drag your finger down to open the Notifications panel. Tap the status that shows **Select to change USB connection type**.
3. On the Connect to PC screen in your device, tap **HTC Sync** and then tap **Done**.
4. On your computer, double-click the green HTC Sync icon  to open HTC Sync.
5. In HTC Sync, click **Application Installer**.
6. In the Application Installer file types dialog box, make sure that the **Android OS installer file (apk)** check box is selected, and then click **OK**.



**Note:** This dialog box only appears the first time you use the Application Installer.

7. Click **Next**.
8. Click **Browse**, locate the application (.apk) on your computer, and then click **Open**.
9. After selecting the application, click **Next**.
10. Click **Finish**. Check your device's screen to see if there are additional instructions to complete the installation.

## Updating Your Device

---

*To download software updates to your device:*

- ▶ Press  >  > **Settings > System updates > Firmware update**. (Your device automatically downloads and installs any available updates. You may be required to power your device off and back on to complete the software upgrade.)



## 2F. Voice Services

- ◆ Automatic Speech Recognition (ASR) (page 69)
- ◆ Managing Voice Memos (page 70)

### Automatic Speech Recognition (ASR)

You can use your device's built-in automatic speech recognition (ASR) software to dial a phone number in People or to launch device functions. All you have to do is to talk into the device, and ASR will recognize your voice and complete tasks by itself.

#### Activating ASR

▶ Press  and tap  > **Voice Dialer**. (You may need to scroll down the screen to see the icon.)

The screen displays “Listening...” and the device prompts you to say the name of the command you want to use. To complete your task, simply follow the voice prompts.



Available ASR commands include:

- **Call** <Name or Voicemail> to call an entry in your People list or voicemail. (See “Making a Voice Call With ASR.”)
- **Dial** <Number> to dial a spoken phone number.
- **Redial** to dial the last outgoing call.
- **Open** <Application Name> to open an application in your device. (See Opening Applications With ASR)

**Tip:** Use ASR in a quiet environment so it can accurately recognize your commands.

**Note:** Regardless of which command you use, you will be asked to confirm your choice, or choose from a menu if ASR is not sure what you would like to do.

#### Making a Voice Call With ASR



1. Press  and tap  > **Voice Dialer**.
2. Wait until you hear a tone and the word “Listening...” appears on the screen.
3. Say “Call [contact name]” to call a person stored in your People list.  
– or –  
Say “Dial [contact number]” to dial a spoken phone number.

**Note:** When dialing a phone number, numbers can be three digits (for example, 911), seven digits (for example, 555-1234), or ten digits (for example, 222-555-1234).

4. Tap **YES** to confirm or **CANCEL** to cancel the command; or choose from a menu if ASR is not sure what you would like to do.

## Opening Applications With ASR

You can jump directly to many applications by saying “Open” followed by the application name.



1. Press  and tap  > **Voice Dialer**.
2. Wait until you hear a tone and the word “Listening...” appears on the screen.
3. Say “Open [application name]” to open an application in your device.
4. Tap **YES** to confirm or **CANCEL** to cancel the command; or choose from a menu if ASR is not sure what you would like to do.

## Managing Voice Memos

---

Use your device’s Voice Recorder to record brief memos to remind you of important events, phone numbers, grocery list items, or create a ring tone.

### Recording Voice Memos



1. Press  and tap  > **Voice Recorder**. (You may need to scroll down the screen to see the icon.)
2. Tap  and speak into the device’s microphone.

*To end the recording of your memo:*



- ▶ Tap .

### Voice Memo Options

*To play the voice memos you have recorded:*



- ▶ After recording a voice memo, tap .
- or –
- Tap  and then tap the file you want to play.

*To share a voice memo:*

1. Press  and tap  > **Voice Recorder**.
2. On the Voice Recorder screen, tap .
3. On the All recordings screen, press and hold the voice memo you want to share, and then tap **Share** on the options menu.
4. On the Share options menu, select how you want to share the voice memo.



To learn how to send files using Bluetooth, see “Bluetooth” on page 94.

*To set a voice clip as a ring tone*





1. Press  and tap  > **Voice Recorder**.
2. On the Voice Recorder screen, tap .
3. On the All recordings screen, press and hold the voice memo you want to set as a ring tone, and then tap **Set as ringtone** on the options menu.



### *Renaming Voice Memos*

1. Press  and tap  > **Voice Recorder**.
2. On the Voice Recorder screen, tap .
3. On the All recordings screen, press and hold the voice memo you want to rename, and then tap **Rename** on the options menu.
4. Enter the new name and tap **Save**.

### *Erasing Voice Memos*

1. Press  and tap  > **Voice Recorder**.
2. On the Voice Recorder screen, tap .
3. On the All recordings, press  and then tap **Delete**.
4. Do any of the following:
  - To erase one or more voice memos, select the check boxes at the right side of the voice memo names, and then tap **Delete**.
  - To erase all voice memos, press , tap **Select All**, and then tap **Delete**.

## 2G. microSD Card

- ◆ Your Device's microSD Card (page 72)
- ◆ Using the Device's microSD Card as a USB Drive (page 74)

### Your Device's microSD Card

---

#### The microSD Card

Your device is equipped with a 2 GB microSD™ (Secure Digital) memory card to expand the device's available memory space. It allows you to store images, videos, music, documents, and voice data in your device.

**Important:** Your device comes with the microSD card preinstalled.

#### Removing the microSD Card

1. With the device turned off, insert your fingernail into the slot at the top left of the battery compartment cover and lift gently to remove.
2. Lift the battery from the notches on the upper left and right sides of the battery compartment, and then set it aside.
3. Locate the latch at the bottom-right corner of the battery compartment, and then lift the latch to unlock the microSD card slot.

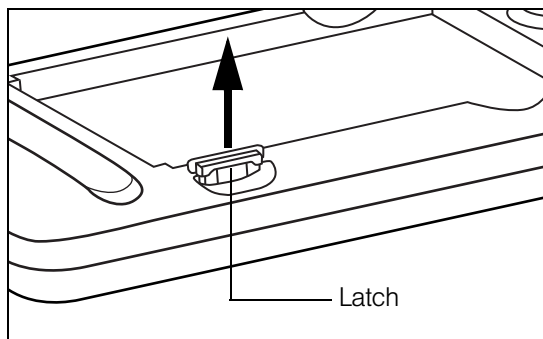

4. Gently pull the microSD card out from the slot, and then press the latch back to lock position.

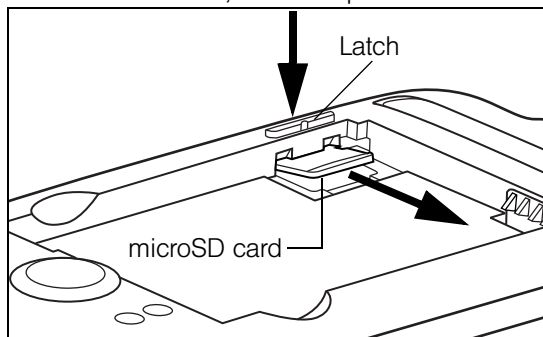

5. Re-install the battery and the back cover. For more information on how to remove and re-install the back cover and battery, see "Battery and Charger" on page 12.

**Note:** You can easily damage the microSD card by improper operation. Please be careful when inserting, removing, or handling the microSD card.

Make sure your battery is fully charged before using the microSD card. Your data may become damaged or unusable if the battery runs out while using the microSD card.

### Inserting the microSD Card

1. With the device turned off, insert your fingernail into the slot at the top left of the battery compartment cover and lift gently to remove.
2. Lift the battery from the notches on the upper left and right sides of the battery compartment, and then set it aside.
3. Locate the latch at the bottom-right corner of the battery compartment, and then lift the latch to unlock the microSD card slot.

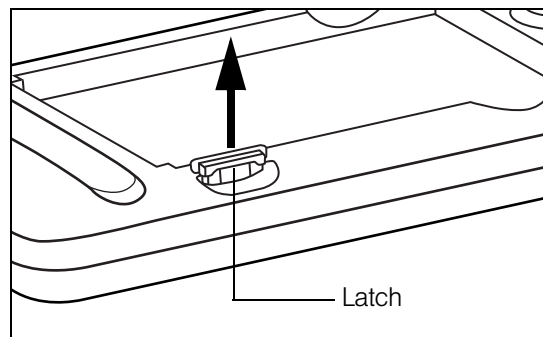

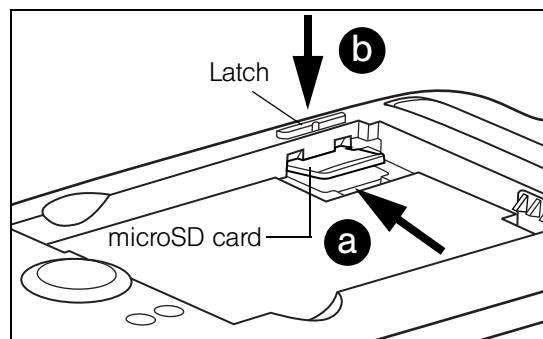

4. Carefully insert the microSD card into the slot (a), and then press the latch (b) to lock the slot and secure the card in place.





5. Re-install the battery and the back cover. For more information on how to remove and re-install the back cover and battery, see "Battery and Charger" on page 12.

## Viewing the microSD Card Memory

- ▶ With the microSD card inserted, press  >  and tap **Settings > SD & phone storage**. (The total and available memory space will be displayed.)

## Formatting the microSD Card

Formatting a microSD card permanently removes all files stored on the card.

1. Press  >  and tap **Settings**.
2. Scroll down the screen, tap **SD & phone storage > Unmount SD card > Format SD card > Format SD card > Erase everything**.

**Note:** The formatting procedure erases all the data on the microSD card, after which the files CANNOT be retrieved. To prevent the loss of important data, please check the contents before you format the card.

When you unmount the SD card, you need to remove and then reinsert the microSD card or turn the device off and then on for the device to recognize the microSD card again.

## Unmounting the microSD Card

When you need to remove the microSD card, you must unmount the microSD card first to prevent corrupting the data inside or damaging the microSD card. Since you will remove the battery first before you can remove the microSD card, close all running applications on your device and save any data before doing this.

1. Press  >  and tap **Settings**.
2. Scroll down the screen, tap **SD & phone storage > Unmount SD card**.
3. Remove the microSD card by following the instructions in “Removing the microSD Card” on page 72.

## Using the Device’s microSD Card as a USB Drive

---

To transfer music, pictures, and other files from your computer to your device's microSD card, you need to set the device's microSD card as a USB drive.

1. Connect the device to your computer using the supplied USB cable.
2. When the Connect to PC dialog box appears, tap **Disk drive**, and then tap **Done**.
3. On your computer, the connected device is recognized as a removable disk. Navigate to this removable disk and open it.
4. Do one of the following:
  - Copy files from the computer to the device's storage card's root folder.
  - Copy files from the device's storage card to a folder in your computer or computer desktop.
5. After copying the files, unmount the removable disk (that is, the connected device) as required by your computer's operating system to safely remove your device.
6. Do one of the following:
  - Disconnect the device from the computer.
  - If you want to keep the device connected to the computer but want the device to be able to access and use the storage card, open the Notifications panel, tap **Disk drive**, select an option except **Disk drive**, and then tap **Done**.

**Note:** The device will not recognize the microSD card when it is connected to a computer as a disk drive. You will not be able to use some of the device's applications such as the camera or Music.

## 2H. Camera and Multimedia





- ◆ Taking Pictures and Shooting Videos (page 75)
- ◆ Viewing Pictures and Videos Using Gallery (page 81)
- ◆ Sharing Live Videos with Qik (page 88)
- ◆ Listening to Music (page 88)
- ◆ Listening to the Radio (page 92)

### Taking Pictures and Shooting Videos

You can use the camera or camcorder to take and share pictures and videos. Your device comes with a 8.0 megapixel main camera with autofocus feature that lets you capture sharp pictures and videos. A 1.3 megapixel front camera is also available for self-portrait and video capture.

**Important:** Make sure the microSD card is installed before you use the camera or camcorder. All pictures or videos that you capture using your device are stored on the microSD card. For more information on how to install a microSD card on your device, see “Inserting the microSD Card” on page 73.

### Opening the Camera

- ▶ To open the camera in photo mode and take photos, press  and then tap  > **Camera**.
- ▶ To open the camera directly in video mode so you can immediately start capturing videos, press  and tap  > **Camcorder**.

### Viewfinder Screen

The camera controls are oriented to landscape view, although you take pictures in portrait format also. You'll find the following controls on the Viewfinder screen:



1. **Menu tab** opens the menu panel and lets you change the camera settings. For more information, see “Camera Settings.”
2. **Autofocus indicator** Whenever you point the camera at a different subject or location, the screen shows the autofocus indicator at the center as the camera automatically focuses on the center of the screen. When you tap another area on the screen, the indicator will move to where you tapped and the camera will automatically focus on that area. The autofocus indicator is not available when you are using the second (front) camera.
3. **Flash button** Tap to switch between various camera flash modes.

4. **Zoom button** displays or hides the onscreen zoom bar. For more information, see “Zooming.” The zoom button is not available when you are using the second (front) camera.
5. **Shutter release button** Tap this button to take a photo or begin capturing video. Tap it again to stop capturing video.
6. **View button** Opens the Gallery application so you can browse through and view the photos and videos in your storage card. For more information, see “Viewing Pictures and Videos Using Gallery.”

## Review Screen

After capturing a photo or video, the review screen lets you save, view, send, or delete the picture or video by tapping a button at the bottom of the screen.





1. Go **Back** to the live camera or camcorder screen.
2. **Delete** the captured image or video.
3. **Share** the captured photo or video to another phone or your computer using Bluetooth, send it by email or multimedia message, or select a social network where you want to upload it to.
4. **View** the captured image or video in Gallery.

## Zooming

Before taking a photo or video, you can first use the onscreen zoom bar to zoom in or out of your subject.

1. To display the onscreen zoom bar, tap the zoom button . You can also slide your finger up or down the viewfinder screen. While the zoom bar is shown on the viewfinder screen, you will also see the remaining photo shots or remaining video recording duration on the upper-right side of the screen.
2. You can do the following:
  - To slowly zoom in or out, slide your finger up or down the viewfinder screen. You can also drag your finger along the zoom bar.



- Tap  to zoom in to the highest magnification.
- Tap  to zoom out to the actual size.

3. After you're done, wait for a few seconds for the zoom bar to automatically disappear from the screen. You can also tap the zoom button again or tap the viewfinder screen to hide it.

**Note:** Zooming is not available when you are using the second (front) camera.

## Face Detection

When you're autofocusing the device's camera to take photos of people, the camera can automatically recognize faces and adjust the focus.

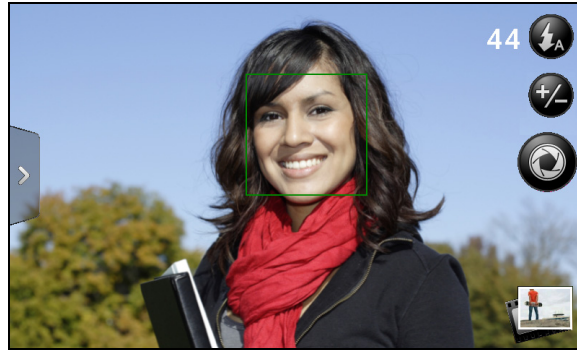

**Note:** Face detection does not work in video mode and is not available when you are using the second (front) camera.

## Taking Pictures

1. Press and then tap > **Camera**.
2. Before taking the photo, you can zoom in on your subject. For more information, see “Zooming.”
3. On the Viewfinder screen, tap the flash button repeatedly to select a camera flash mode depending on your lighting conditions:
  - Auto flash
  - Flash on
  - Flash off

4. Frame your subject on the screen.

**Tip:** Hold the device vertically when taking portrait shots or hold the device horizontally when taking landscape shots. By doing this, you do not need to rotate the photo after capturing it.

5. You can either let the camera autofocus on the center of the screen, or you can touch another area on the screen that you want to focus on.

**Note:** The second camera (front) is fixed-focus and does not support zooming and face detection.

6. Tap to take the photo.
7. Choose what you want to do with the photo you've just taken. See “Review Screen” for details.



## Camera Flash FAQ

### Camera flash light doesn't turn on?

The flash light quickly consumes battery power. To save battery power, the camera disables the flash light or locks it to **Flash off** mode (even when you have set it to **Auto flash** or **Flash on**) when one of the following occurs:

- You have an incoming call. If you have set the flash light to **Flash on**, it turns back on after you answer and end the call.
- Your device's battery level reaches 20% or lower. Recharge the battery so that the camera can have enough battery power to use the flash light.
- Cold weather lowers battery performance and affects the flash light. To make sure the camera has enough battery life to power up the flash light, keep your device warm. When not in use, put the device inside your jacket to keep it warm, and try to avoid sudden temperature changes that may affect battery performance.

## Capturing Videos

1. Press  and then tap  > **Camcorder**.
2. Before capturing the video, you can zoom in on your subject. For more information, see “Zooming.”
3. Frame your subject on the screen.
4. You can either let the camcorder autofocus on the center of the screen, or you can touch another area on the screen that you want to focus on.
5. Tap  to start capturing video.

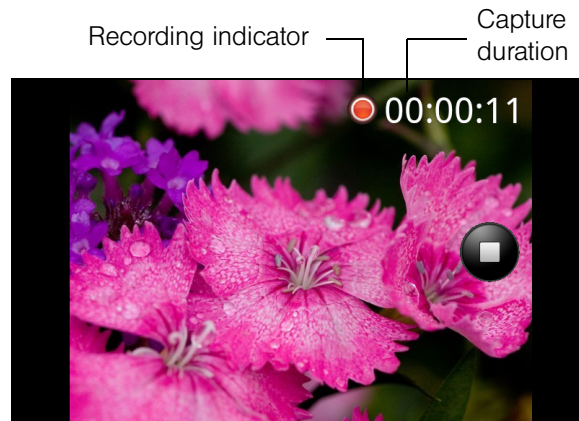

6. Tap  again to stop capturing.
7. Choose what you want to do with the video you've just captured. See “Review Screen” for details.



## Camera Settings

Open the menu panel to change basic camera settings and access more camera settings. You can also switch between photo and video modes from the menu panel.

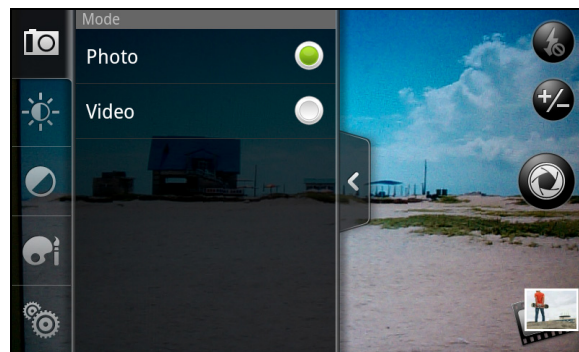

### Changing Basic Settings

1. On the viewfinder screen, tap  to open the menu panel.

2. To change basic camera settings, tap one of these icons in the menu panel:

- Exposure 

There's a brightness bar that allows you to adjust the brightness level. Slide your finger up or down the brightness bar to increase or decrease brightness.

- Image properties 

Slide your finger across each of the slider bars to adjust the contrast, saturation, and sharpness.

- Effect 

You can apply a special effect to photos and videos that you will capture. Scroll through the Effect menu and choose from effects such as adding a sepia tone, solarization, and posterizing.

### Changing Advanced Settings

1. On the viewfinder screen, tap  to open the menu panel.

2. Tap  in the menu panel to display the Settings menu and access more camera settings. You can change the following settings from the Settings menu:

- **Switch camera:** Lets you switch between the main camera and the second (front) camera.

- **White balance:** Lets you change the white balance to enable the camera to capture colors more accurately by adjusting to your current lighting environment. White balance settings include: **Auto**, **Incandescent**, **Fluorescent**, **Daylight**, and **Cloudy**.

- **ISO (photo mode only):** Lets you choose an ISO level or set it back to **Auto**. Higher ISO numbers are better for taking pictures in low light conditions. This option is not available when you are using the second (front) camera.

- **Resolution:** Lets you select a photo or video resolution to use for capturing.

- **Widescreen (photo mode only):** Lets you change the ratio between the width and height of your pictures. When this check box is selected (default), photo resolutions available for selection are in a 3:2 ratio and you can use the entire viewfinder screen to frame your subject. When not selected, photo resolutions available for selection are in a standard 4:3 ratio. This option is not available when you are using the second (front) camera.

- **Storage:** Lets you select where to save captured photos or videos. You can select the storage card or internal memory, if available.

- **Quality (photo mode only):** Lets you select the quality level to use for capturing photos.

- **Self-timer (photo mode only):** Lets you select take a self-portrait or group photo; you can set the self-timer to either 2 seconds or 10 seconds.
- **Geo-tag photos (photo mode only):** Lets you store the GPS location in your captured photos.
- **Encoding type (video mode only):** Lets you choose the type of compression to use when capturing video.
- **Recording length (video mode only):** Lets you set the maximum duration or file size for capturing video.
- **Record with audio (video mode only):** Lets you choose whether to record audio when capturing videos.
- **Metering mode:** Lets you set how the camera measures the amount of light to calculate the best exposure:
  - **Spot metering** mode allows the camera to measure light around the focus point.
  - **Center area** mode allows the camera to measure light in the center.
  - **Average** mode allows the camera to measure light in the whole image.

This option is not available when you are using the second (front) camera.
- **Review duration:** Lets you specify how long a captured photo or video is displayed on the review screen before the camera changes back to the viewfinder screen.
- **Flicker adjustment:** Lets you reduce flicker when taking indoor shots under fluorescent lighting. Keep this setting on **Auto** or manually set it to match the frequency (**50Hz** or **60Hz**) of the electrical power used for the country you are in.
- **Auto Focus:** Enables or disables centered autofocus. Autofocus is enabled by default. This option is not available when you are using the second (front) camera.
- **Face detection:** Allows the camera to recognize faces and automatically adjust the focus. Face detection is turned off when you disable **Auto Focus** and is not available when you are using the second (front) camera.
- **Shutter sound:** Allows you to select whether the camera plays a shutter sound when you press the shutter release.
- **Time stamp (photo mode only):** Lets you add the date and time to captured photos.
- **Grid (photo mode only):** Allows you to display a grid on the viewfinder screen so you can easily frame and center your subject before taking the photo.
- **Reset to default:** Lets you change the camera back to default settings.

### *Closing Camera*

On the camera screen, press  or .

## Viewing Pictures and Videos Using Gallery

Using the Gallery application, you can view photos and watch videos that you've taken with your device's camera, downloaded, or copied onto your storage card. You can also take a look at your photos and your friends' photos that are on your social networks (Facebook and Flickr only).

For photos that are in your storage card, you can do basic editing such as rotating and cropping. You can also easily make a photo as your contact picture or wallpaper and share photos with your friends.

### Opening Gallery

► Press  and tap  > **Gallery**.

The Gallery application opens in the Albums tab where your photos and videos are organized by albums for easy viewing.

If you stored your files in folders (directories) on the microSD card, Gallery will display these folders as separate albums.



1. **Camera shots** lets you view photos and videos that are stored in the camera's folder.
2. **All photos** lets you view all photos that are stored in all the folders on the storage card.
3. **All videos** lets you view all videos that are stored in all the folders on the storage card.
4. Photos and videos that you set as your favorites will be grouped under **Favorites**.

Photos or videos that are under the root path of your storage card (that are not contained in folders) are grouped in **Others**.

Folders in your storage card that contain photos and videos will also be treated as albums and will be listed below the preset albums. The actual folder names will be used as the album names. If you have downloaded any photos and videos, these will be placed in the **All downloads** album.

When viewing pictures in Gallery, scroll up the screen to view more albums. Simply tap an album to view the photos or videos in that album.

**Note:** Depending on the number of pictures stored on the microSD card, it may take awhile for Gallery to load all your photos on the screen.

## Viewing Photos and Videos

After selecting an album from the Albums tab, you can browse through the photos and videos of that album either in filmstrip or grid view. Tap a photo or video to view it in full screen.

By default, photos and videos are presented in a horizontal filmstrip. Slide your finger left or right across the filmstrip to go through the photos and videos.

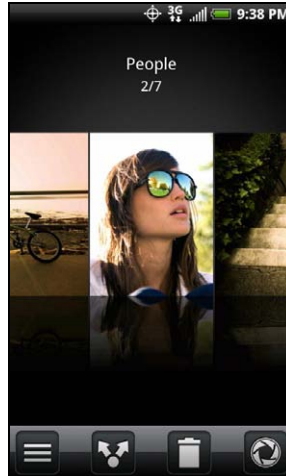

From the filmstrip view, press  and then tap **Grid view** to browse photos and videos by thumbnails. Slide your finger up or down to scroll through the thumbnails.

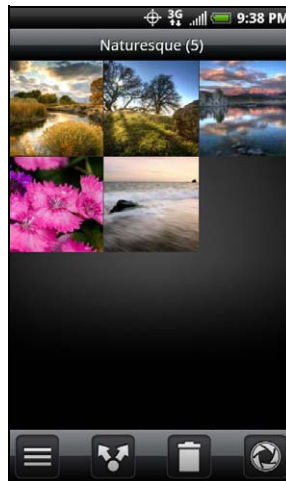

To change back to displaying photos and videos in a filmstrip, press  and then tap **Filmstrip view**.

**Note:** Whether you're in filmstrip or grid view, you can press and hold on a photo or video to open a selection menu and choose what to do with the photo or video.

If you want to select another album, tap  to return to the Albums tab.

## Zooming In or Out on a Photo

There are two ways you can zoom in or out of a photo:

- ▶ Tap the screen twice quickly to zoom in, then tap the screen twice quickly again to zoom out.  
– or –

You can also use pinch zooming. Press your thumb and index finger on the screen and then spread your fingers apart to zoom in. Pinch your fingers together to zoom out.

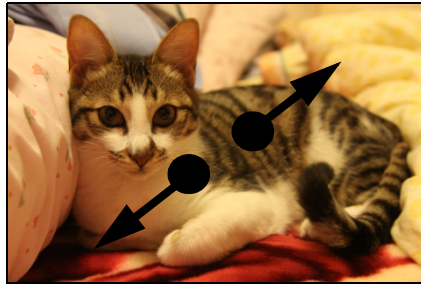

Zooming in

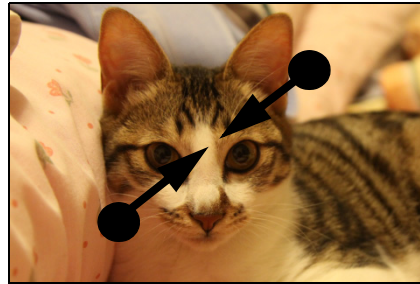

Zooming out

## Watching Video

The screen automatically switches to landscape mode when you play a video. Use the onscreen controls to play, pause, or stop the video.

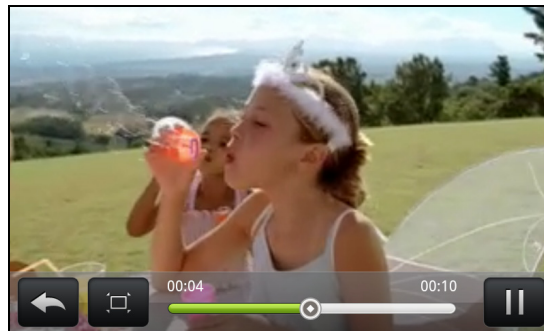

The video is displayed in full screen size. You can tap  to make it best fit on the screen based on the video size. Tap the button again to change back to full screen size.

You can play these high-definition MP4 video formats in **Gallery**:

- H.263 profile 0 @ 30 fps, WVGA (800x480), max 2 Mbps
- MPEG-4 simple profile @ 30 fps, 720p (1280x720), max 6 Mbps
- H.264 baseline profile @ 30 fps, 720p (1280x720), max 6 Mbps

## Viewing Photos in Your Social Networks

Using Gallery, you can view your photos and your friends' photos that are in your social networks (Facebook and Flickr only).

### Viewing Photos on Facebook

You need to be logged in to your Facebook account to view Facebook photos.



1. Press  and tap  > **Gallery**.

2. Tap the **Facebook** tab.
3. Tap your account name or your friend's account on the list to view the pictures in the account.

You can view photos in your online albums the same way as how you view photos in your storage card.

### Viewing Photos on Flickr

You need to be logged in to your Flickr account to view Flickr photos.



1. Press  and tap  > **Gallery**.
2. Tap the **Flickr** tab.  
You may be asked to give authorization for the application to connect to the Flickr website. If this happens, you need to give authorization to access your Flickr account.
3. Tap your account name or your friend's account on the list to view the photos in the account.

You can view photos in your online albums the same way as how you view photos in your storage card.

### Viewing Photos and Videos on Another Display Device

An HDMI jack at the bottom panel of your device lets you connect it with an HDMI-compliant external display device such as an LCD TV.



**Note:** An HDMI cable must be purchased separately. It is not included with your device. (An HTC-approved HDMI cable may be purchased at [www.sprint.com/accessories](http://www.sprint.com/accessories).)

1. Connect one end of the HDMI cable to the HDMI jack at the bottom panel of your device.  
CAUTION! Inserting an accessory into the incorrect jack may damage the device.
2. Make sure the external display device is turned off, and then connect the other end of the HDMI cable to the HDMI jack on the external display device.
3. Turn on the external display device and then select the HDMI video input. Refer to the display's documentation for details.
4. On your device, press  and tap  > **Gallery**.
5. Open a photo or video album, and then do any of the following:
  - Start a photo slideshow by pressing  and tapping **Slideshow**.
  - Tap a video to start playing it on the screen.
 The device screen should show on the external display device.

### Working with Photos



Whether you're browsing photos in filmstrip or grid view in the Gallery application, you can press and hold on a photo to open a selection menu and choose what to do with it. You can choose to delete the photo, rotate or crop it, and more.

#### Rotating and Saving a Photo

1. Press  and tap  > **Gallery**.
2. On the Albums tab, tap an album.
3. Choose whether to browse photos and videos in the album in filmstrip or grid view. For more information, see "Viewing Photos and Videos."
4. Press and hold on the photo that you want to rotate.
5. In the menu that opens, tap **Rotate**, and then select either **Rotate left** or **Rotate right**.

**Tip:** You can also rotate a photo while you're viewing it in full screen. Press , tap **Rotate**, and then select either **Rotate left** or **Rotate right**.

## Cropping a Photo

1. Press  and tap  > **Gallery**.
2. On the Albums tab, tap an album.
3. Choose whether to browse photos and videos in the album in filmstrip or grid view. For more information, see “Viewing Photos and Videos.”
4. Press and hold on the photo that you want to rotate.
5. In the menu that opens, tap **Crop**. A crop box then appears on the photo.

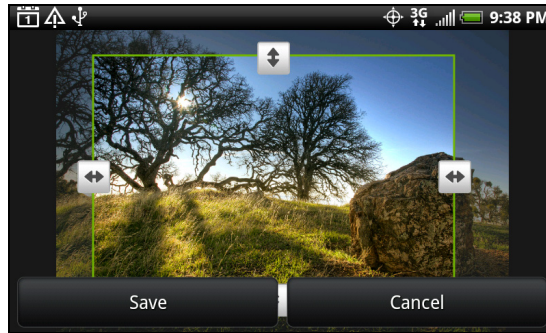

6. To adjust the crop box size, press and hold the edge of the box. When directional arrows appear, drag your finger inward to or outward to resize the crop box.
7. To move the crop box to the part of the photo that you want to crop, drag the crop box to the desired position.
8. Tap **Save** to apply the changes to the picture.

The cropped picture is saved in the storage card as a copy. The original picture remains unedited.



**Tip:** You can also crop a photo while you're viewing it in full screen. Press , tap **More** > **Crop**, and follow the same cropping steps as above.

## Sharing Photos and Videos

The Gallery application lets you send photos and videos using email or multimedia message. You can share photos on your social networks (such as Facebook, Flickr, Picasa, and Twitter) and share videos on YouTube or Qik. You can also send them to another phone or your computer using Bluetooth.

### Sending Photos or Videos by Email



You can send several photos, videos, or both in an email message. They are added as file attachments in your email.

1. Press  and tap  > **Gallery**.
2. Tap the album where the photos or videos you want to share are in.
3. Tap  and then on the Share options menu, tap **Gmail** or **Mail**.
4. Select the photos or videos you want to share and then tap **Next**.
5. Compose your message and then tap **Send**.

**Note:** If you selected **Mail** and you have multiple email accounts, the default email account will be used.



### Sending a Photo or Video by Multimedia Message

Although you can send several photos or videos in a multimedia message, it may be better to just send one at a time, especially if the files are big in size.

1. Press  and tap  > **Gallery**.
2. Tap the album where the photos or videos you want to share are in.
3. Tap  and then on the Share options menu, tap **Messages**.
4. Tap the photo or video you want to send. The photo or video is automatically added into the multimedia message.
5. Compose your message and then tap **Send**.

### Sending Photos or Videos Using Bluetooth



You can select several photos, videos, or both and send them to someone's phone or your computer using Bluetooth.

1. Press  and tap  > **Gallery**.
2. Tap the album where the photos or videos you want to share are in.
3. Tap  and then on the Share options menu, tap **Bluetooth**.
4. Select the photos or videos you want to share and then tap **Next**.

In the next few steps, you'll be asked to turn on Bluetooth on your device and connect to the receiving Bluetooth device so the files can be sent. For more information, see "Bluetooth" on page 94.



### Sharing Photos on Facebook for HTC Sense

You need to be logged in to your Facebook account to be able to upload photos.

1. Press  and tap  > **Gallery**.
2. Tap the album where the photos you want to share are in.
3. Tap  and then on the Share options menu, tap **Facebook for HTC Sense**.
4. Select the photos you want to share and then tap **Next**.
5. Add a caption for the photos and then tap **Upload**.
6. Select which album to upload to and set privacy settings for the uploaded pictures. Tap **Done**.

### Sharing Photos on Facebook for Android



You need to be logged in to your Facebook account to be able to upload photos. When using Facebook for Android, you can only upload one photo at a time.

1. Press  and tap  > **Gallery**.
2. Tap the album where the photos you want to share are in.
3. Tap  and then on the Share options menu, tap **Facebook**.
4. Select the photo you want to share and then tap **Next**.
5. Add a caption for the photo and then tap **Upload**.
6. Check the status bar for the upload information.



## Sharing Photos on Flickr

You need to be logged in to your Flickr account to be able to upload pictures.





1. Press  and tap  > **Gallery**.
2. Tap the album where the photos or videos you want to share are in.
3. Tap  and then on the Share options menu, tap **Flickr**.
4. Select the pictures you want to share and then tap **Next**.
5. Add a description for the photos and then tap **Upload**.

**Note:** If you are not logged in to your Flickr account, you will be prompted to do so and download the HTC Flickr Downloader application. Follow screen instructions to proceed.

6. Select which album to upload to and set privacy settings for the uploaded pictures. Tap **Done**.



## Sharing Photos on Picasa

You need to be signed in to a Google Account to be able to upload pictures to the Picasa™ photo organizing service.

1. Press  and tap  > **Gallery**.
2. Tap the album where the photos or videos you want to share are in.
3. Tap  and then on the Share options menu, tap **Picasa**.
4. Select the pictures you want to share and then tap **Next**.
5. Select the online album where you want to upload the pictures, or tap  to create a new album.
6. Tap **Upload**. You can view the photos online at <http://picasaweb.google.com>.

## Sharing Videos on YouTube

You can share your videos by uploading them to YouTube™. Before you do this, you must create a YouTube account and sign in to that account on your device.

1. Press  and tap  > **Gallery**.
2. Tap the album where the photos or videos you want to share are in.
3. Tap  and then on the Share options menu, tap **YouTube**.
4. Select the videos you want to share and then tap **Next**.
5. Enter the prompted information, such as description and tags, and select a privacy option.
6. Tap **Upload**.

## Closing Gallery

- ▶ While in the Gallery screen, press  to close the application.





## Sharing Live Videos with Qik

---

Use Qik to share live videos from your device. Before you start sharing live videos in Qik, you must create and sign in to your Qik account. To create a Qik account, visit <http://qik.com> and click **Sign Up**.

### Sharing a Live Video in Qik

Qik lets you stream live video from your device to your Qik account where your friends can view it.

1. Press  and tap  > **Qik**.
2. When prompted, sign in to your Qik account.
3. On the Qik screen, do any of the following:
  - Tap **Share** to share the video with specific contacts.
  - Tap **Title** to specify a title for the live video.
  - Tap **Public** to set the video privacy settings to **Private** or **Public**.
  - Press  and tap **Settings** to set up your sharing preferences, video quality, the camera to use, and more.
4. Tap  to start streaming live video to your Qik account. Tap  to stop streaming live video.

### Closing Qik



- ▶ On the Qik screen, press  and tap **Exit**.

## Listening to Music

---



Enjoy listening to songs and music on your device using the Music application. You need to copy music files to your storage card first to use the Music application to play music. To find out how to copy files to the storage card, see “Using the Device’s microSD Card as a USB Drive” on page 74.

### Playing Music

To open the Music application, press  and tap  > **Music**.

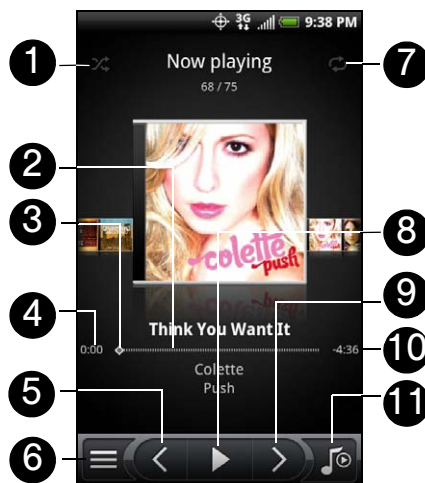
The Music application opens in the Playback screen. Use the onscreen controls to control music playback, select a song to play, repeat songs, and more. On the Playback screen, you can also swipe your finger from right to left or left to right to go to the next or previous music album.



1. Tap to turn shuffle on or off. (Shuffle is off when button is gray.)
2. Shows the progress bar.
3. Press and drag to jump to another part of the song.
4. Shows the elapsed time.
5. Tap to go to the previous song in the Now playing list.
6. Tap to go to the Library.
7. Tap to cycle through the repeat modes:  Repeat all songs,  Repeat current song, and  don't repeat.
8. Tap to pause or resume playing the song.
9. Tap to go to the next song in the Now playing list.
10. Shows the remaining time.
11. Tap to toggle between showing the Now playing list and Playback screen.

When you are playing music and the screen turns off, you can control the music playback right from the Lock screen when you “wake up” the device by pressing . If you do not see the playback controls on the Lock screen, tap anywhere on the screen to display the playback controls.

**Tip:** You can also swipe your finger from right to left or left to right to go to the next or previous song in the Now playing list.

**Note:** Press the volume up or down button to adjust the playback volume.

## Browsing Music in the Library

Tap  at the bottom-left corner of the Playback screen or the Now playing list screen to go to the Library.

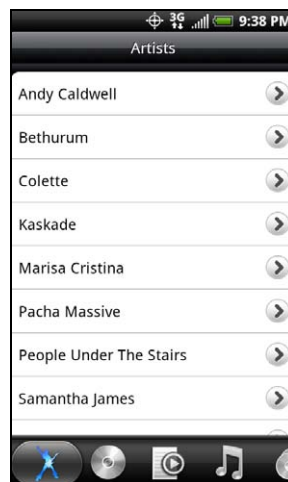

In the Library, your music is organized into different categories such as Artists, Albums, Playlists, Genres, Composers, and more. Select a category by tapping one of the category tabs at the bottom of the screen.



When you tap a song in a category to play it, the Now playing list is updated with the song list from your selected category.

## Creating Playlists

Personalize your music experience by creating music playlists. Make a playlist containing just your favorite songs or create one to match your mood for the day. You can make as many playlists as you like.

1. Press  and tap  > **Music**.
2. Tap  at the bottom-left corner of the screen to go to the Library.
3. In the Library, tap or slide your finger on the bottom row to go to the Playlists category.
4. Tap **Add playlist**.
5. Enter a playlist name, and then tap **Add songs to playlist**.
6. Tap or slide your finger on the bottom row to change among the different categories. If you go to the Songs category, you can see a complete list of songs on your storage card.
7. Select the check boxes of songs you want to add to the playlist and then tap **Add**.
8. Tap **Save**.

## Playing the Songs in a Playlist

1. In the Library, tap or slide your finger on the bottom row to go to the Playlists category.
2. Tap a playlist to open it.
3. Tap the first song or any song in the playlist.

When you tap a song in the list to play it, the Now playing list is updated with the song list from your playlist.

## Managing Your Playlists



After creating a playlist, you can add more songs to it, rearrange their order, and more.

### *To add songs to a playlist:*

1. In the Library, tap or slide your finger on the bottom row to go to the Playlists category.
2. Tap a playlist to open it.
3. Press  and then tap **Add songs**.
4. Go to the Songs category or any other category.
5. Select the songs you want to add to the playlist and then tap **Add**.

**Tip:** While playing back a song, press  and then tap **Add to playlist** to add the current song to a playlist.

### *To rearrange the songs in a playlist:*

1. In the Library, tap or slide your finger on the bottom row to go to the Playlists category.
2. Tap a playlist to open it.
3. Press  and then tap **Change order**.
4. Press and hold  at the end of the song title you want to move. When the row is highlighted, drag it to its new position, and then release.
5. Tap **Done**.