

Your **HTC** phone

User guide

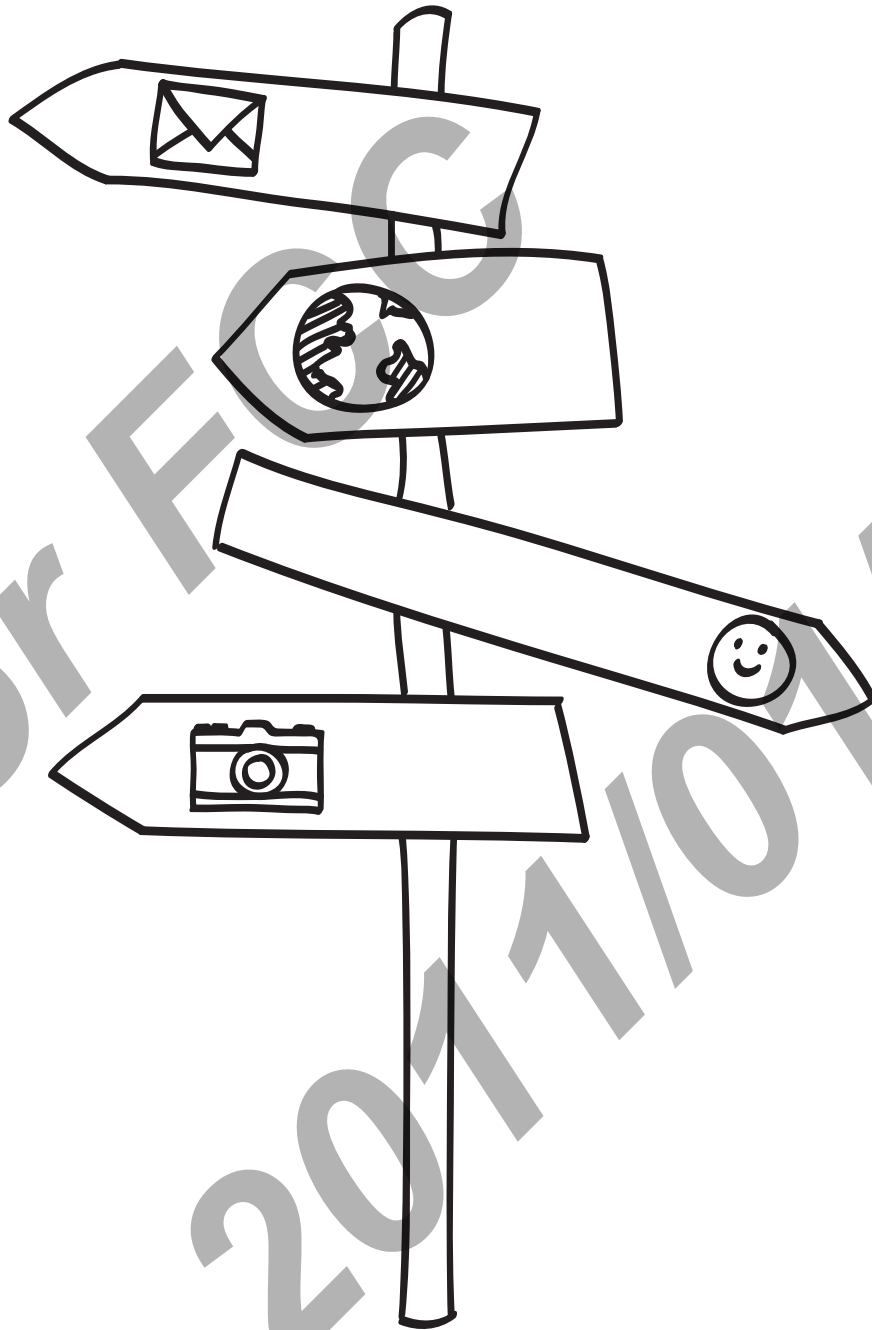

htc
quietly brilliant

Conventions used in this guide

In this user guide, we use the following symbols to indicate useful and important information:



This is a note. A note often gives additional information, such as what happens on your phone when you choose to do or not to do a certain action. A note also provides information that may only be applicable to some situations.



This is a tip. A tip gives you an alternative way to do a particular step or procedure, or lets you know of an option that you may find helpful.



This indicates that something is very important. Important information is something that you need to do in order to accomplish a certain task or to get a phone feature to work properly.



This provides safety precaution information, that is, information that you need to be careful about to prevent potential problems when using your phone.

For FCC
2011/01/24

Basics

Inside the box

You will find the following inside the box:

- Phone
- Battery (preinstalled)
- microSD™ card (preinstalled)
- USB cable
- 3.5mm stereo headset
- Power adapter
- Quick start guide
- Safety and regulatory guide

Your phone

Front panel



You'll see the HOME, MENU, BACK, and SEARCH buttons when your phone is switched on. And when you turn your phone sideways, these buttons rotate along with the screen.



Top panel

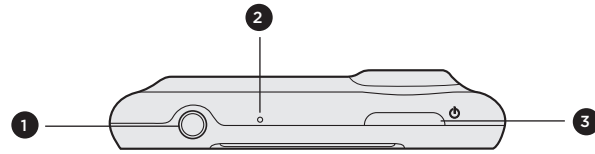

- 1 3.5mm headset jack
- 2 Microphone
- 3 POWER

Left panel

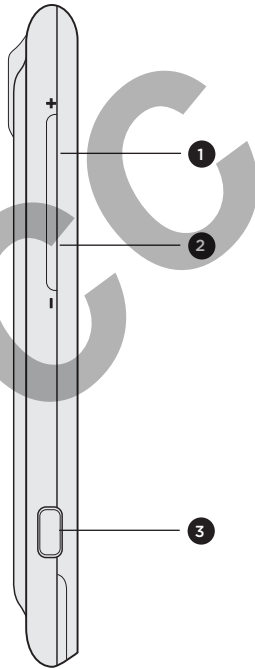

- 1 VOLUME UP
- 2 VOLUME DOWN
- 3 USB connector

Back panel

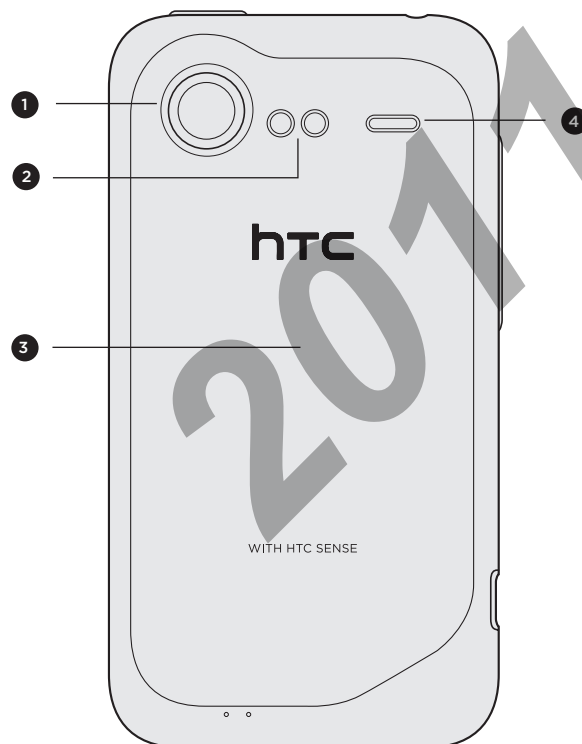

- 1 8 megapixel camera
- 2 Dual LED flash
- 3 Back cover
- 4 Speaker

Back cover

Removing the back cover

Remove the back cover to access the battery compartment, SIM card slot, and storage card slot.

1. With the phone switched off, hold your phone securely with the front facing down.
2. Starting from the small opening at the bottom of the phone, lift the back cover and remove it completely.

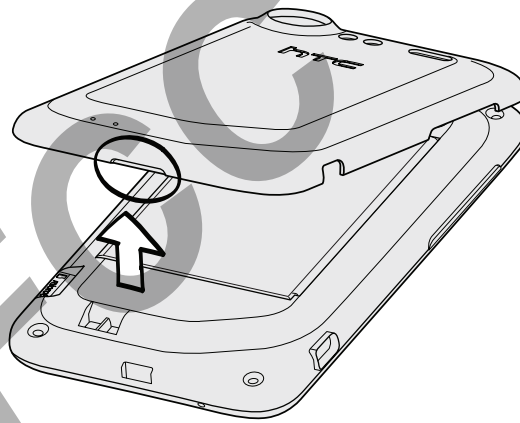

Replacing the back cover

Please handle the back cover with care since your phone's antennas are placed underneath it. Avoid twisting or bending the back cover.

To get the best signal for calls, data connection, or GPS navigation, be sure to secure the back cover tightly to the phone.

1. Align the back cover onto the phone's top panel.
2. Press all sides of the back cover towards the phone.

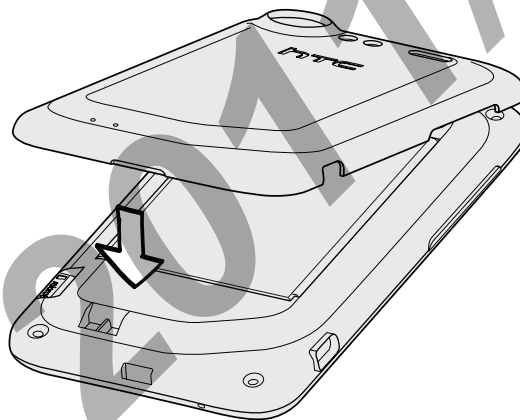

You'll hear clicks when the small tabs underneath the back cover are locked in place.

SIM card

The SIM card contains your phone number, service details, and phonebook/message memory. Your phone supports both 1.8 V and 3 V SIM cards.



Some legacy SIM cards may not function with your phone. You should consult with your mobile operator for a replacement SIM card. There may be fees for this service.

Inserting the SIM card

1. Take the back cover off. See “Back cover” for details.
2. Take the battery out. See “Battery” for details.
3. With the SIM card’s gold contacts facing down and its cut-off corner facing out, insert the SIM card all the way into the SIM card slot.

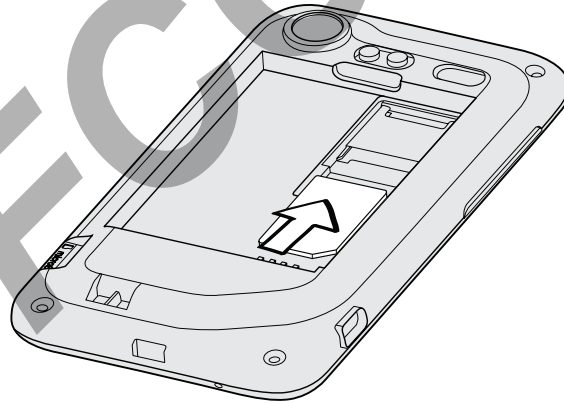

Removing the SIM card

1. Take the back cover off. See “Back cover” for details.
2. Take the battery out. See “Battery” for details.
3. Press and hold the SIM card tab, then push the SIM card out from the opposite end.

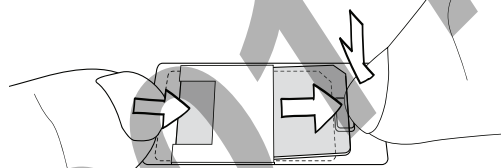

4. Slide the SIM card out.

Storage card

Use the microSD card to store your photos, videos, and music. You'll find the microSD card already inserted in your phone.

Inserting the storage card

1. Take the back cover off. See "Back cover" for details.
2. Insert the microSD card into the storage card slot with its gold contacts facing down and push it until it clicks into place.

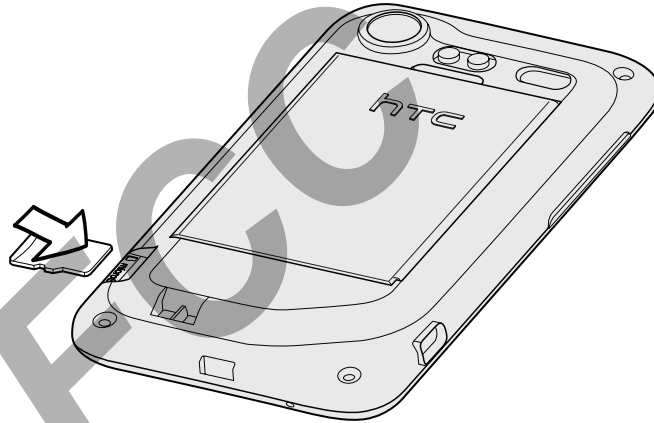

Removing the storage card

If your phone is on you must first "unmount" the storage card before removing it to prevent corrupting or damaging the files in the storage card.

1. Take the back cover off. See "Back cover" for details.
2. Push the storage card in to eject it from its slot.
3. Slide the storage card out.

Removing the storage card while the phone is on

When you need to remove the storage card while the phone is on, unmount the storage card first to prevent corrupting or damaging the files in the storage card.

1. On the Home screen, press MENU, and then tap **Settings**.
2. Scroll down the screen, and then tap **SD & phone storage**.
3. Tap **Unmount SD card**.
4. Remove the storage card by following the steps in "Removing the storage card".

Battery

Your phone uses a rechargeable battery. Please use only original batteries and accessories that came with your phone or replacements that we recommend.

How long the battery can last before it needs recharging depends on how you use your phone. Among these are the phone features and accessories you use (for example, leaving your Bluetooth connection always on uses more power). Long phone calls and frequent web browsing use up much battery. Also, consider your location: poor signal strength from your mobile network and extreme temperature make the battery work harder.

Removing the battery



When you take your phone out from the box, make sure to peel off the thin film of the battery that's inside your phone. Pull the flap of the film to release the battery.

1. Take the back cover off. See “Back cover” for details.
2. Lift the battery from the groove at the top of the battery compartment.

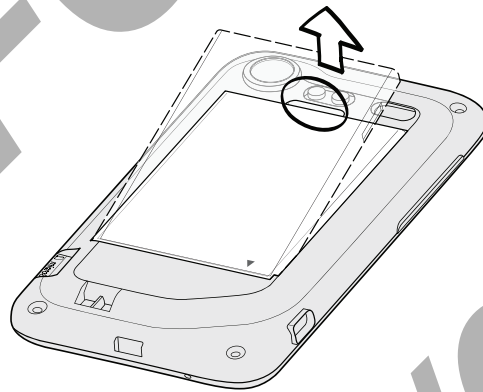

Inserting the battery

1. Take the back cover off. See “Back cover” for details.
2. Insert the battery (with its exposed copper contacts first) into the battery compartment.

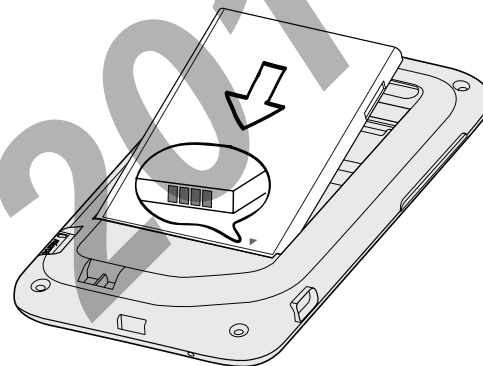

3. Replace the back cover.

Charging the battery

The battery is partially charged when shipped. Before you turn on and start using your phone, it is recommended that you charge the battery. Some batteries perform best after several full charge/discharge cycles.

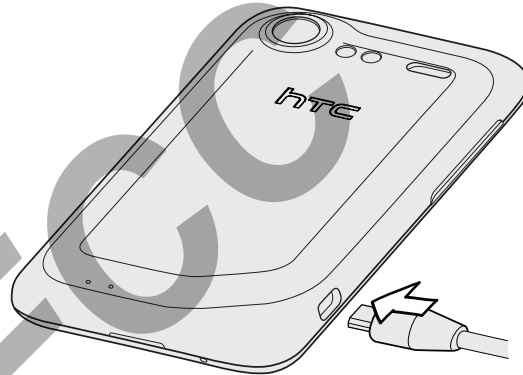

- ⚠️ ▪ Only the power adapter and USB sync cable provided with your phone must be used to charge the battery.
- Do not remove the battery from the phone while you are charging it using the power or car adapter.

1. Plug the power adapter into the USB connector of your phone.



2. Plug in the power adapter to an electrical outlet to start charging the battery.

As the battery is being charged, the notification LED shows a solid orange light. The light turns to solid green when the phone is fully charged.

When you charge the battery while the phone is on, the charging battery icon () is displayed in your phone's status bar. After the battery has been fully charged, the charging battery icon turns to a full battery icon ().



As a safety precaution, the battery stops charging when it overheats.

Switching your phone on or off

Switching your phone on

Press and hold the POWER button. Easy.



When you turn on the phone for the first time, you'll need to set it up. See the Getting started chapter for details.

Switching your phone off

1. If the display is off, press the POWER button to turn it back on, then unlock the screen by sliding down the bar on the lock screen.

See “Unlocking the screen” in the Getting started chapter for details.

2. Press and hold the POWER button for a few seconds.
3. When the Power options menu appears, tap **Power off**.

Entering your PIN

Most SIM cards come with a PIN (personal identification number) set by your mobile operator. If you're asked for a PIN, enter it and then tap **OK**.

To find out how to enable, disable, or change the PIN, see “Protecting your SIM card with a PIN” in the Security chapter.



If you enter the wrong PIN three times, your SIM card is blocked. No problem. Just contact your mobile operator and ask for the PUK (PIN Unblocking Key).

Finger gestures

Tap	When you want to type using the keyboard, select items onscreen such as application and settings icons, or press onscreen buttons, simply tap them with your finger.
Press and hold	To open the available options for an item (for example, a contact or link in a web page), simply press and hold the item.
Swipe or slide	To swipe or slide means to quickly drag your finger vertically or horizontally across the screen.
Drag	Press and hold your finger with some pressure before you start to drag. While dragging, do not release your finger until you have reached the target position.
Flick	Flicking the screen is similar to swiping, except that you need to swipe your finger in light, quicker strokes. This finger gesture is always in a vertical direction, such as when flicking the contacts or message list.
Rotate	For most screens, you can automatically change the screen orientation from portrait to landscape by turning the phone sideways. When entering text, you can turn the phone sideways to bring up a bigger keyboard.
Pinch	In some apps, like Gallery or the web browser, you can “pinch” the screen using two fingers (for example, thumb and index finger) to zoom in or zoom out when viewing a picture or a web page.

Getting started

Setting up your phone for the first time

When you switch on your phone for the first time, you'll be asked to set up your phone. You can choose your language, how you want to connect to the Internet, and whether you want your current location to be automatically detected. If you still have personal contacts and calendar events stored on your old phone, you can easily transfer them to your new phone through Bluetooth as well.

Be sure to sign in to your Google Account so you can use Google apps like Gmail™. You can also set up your other email accounts, favorite social networks like Facebook® and Twitter™, and more.

Just follow the onscreen instructions and you'll be up and running with your phone in no time.



Some features that need to connect to the Internet such as location-based services and auto-sync of your online accounts may incur extra data fees from your mobile operator. Don't worry. You can enable or disable them in your phone's settings as you go along later on. To find out how, see the Settings chapter.

Home screen

Your Home screen is where you make your phone your own. It comes with a weather clock widget that shows the time and weather in your current location. You can also add your favorite apps, shortcuts, folders and widgets so they're always just a tap away.

To find out how, see the Personalizing chapter.

Extended Home screen

As you start to do more things with your phone, you might find that one Home screen is not enough. No problem. You can use up to six extra screens. It should be plenty.

Slide your finger horizontally to the left or right and you'll discover more space for adding icons, widgets, and more.

Press HOME to return to the main Home screen (that is, the center home screen).

Using Leap view

To jump straight to the screen that you want, press HOME while on the main Home screen or pinch the screen to show the Leap view. It reveals all seven Home screens as thumbnails.

















Just tap the one you want and you'll leap right there.

Status and notifications

Status icons

You can tell a lot about your phone by checking the icons in its status bar. Here's what each one means:



 Signal strength	 Battery is full
 GPRS connected	 Battery is charging
 GPRS in use	 Battery is low (20% remaining)
 EDGE connected	 Battery is very low (10% remaining)
 EDGE in use	 Silent mode
 3G connected	 Vibrate mode
 3G in use	 Phone microphone is mute
 HSDPA connected	 Speakerphone on
 HSDPA in use	 Wired microphone headset connected
 Roaming	 Wired headset connected
 No signal	 Bluetooth is on
 No SIM card installed	 Connected to a Bluetooth device
 Connected to a Wi-Fi network	 Airplane mode
 Data synchronizing	 GPS is on
 Network sharing is on	 Alarm is set

Notification icons

A busy life means a busy phone. Notification icons on the status bar make it easy for you to keep on top of your messages, calendar events and alarms. Here's what each one means:



	New Gmail/Google Mail message		Call in progress
	New Microsoft Exchange ActiveSync or POP3/IMAP email		Missed call
	Problem with email delivery		Call on hold
	New SMS/MMS		Call forwarding on
	Problem with SMS/MMS delivery		Message forwarding on
	New Google Talk instant message		The phone is connected to a computer via USB cable
	New voicemail		Wi-Fi is on and wireless networks are available
	Upcoming event		Portable Wi-Fi Hotspot is on
	New updates from your social networks		Uploading data (animated)
	New tweet		Downloading data (animated)
	Matched contacts suggestion		Waiting to upload
	New push message		Downloaded Android Market app installed successfully
	Bluetooth pairing request		Update available for an app downloaded from Android Market
	Phone software update available		Storage card is safe to remove or storage card is being prepared
	TV out		No storage card installed on the phone
	Song is playing		Storage card is low on free space
	FM Radio app in use		General notification
	Voice recording is on		More (not displayed) notifications
	Compass needs orientation		

Notification LED

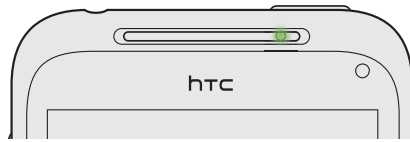

The notification LED shows a:

- Solid green light when the phone is connected to the power adapter or a computer and the battery is fully charged.
- Flashing green light when you have a pending notification.
- Solid orange light when the battery is being charged.
- Flashing orange light when the battery level reaches very low.

Notifications panel

When you get a new notification, you can open the Notifications panel to see the message, reminder or event notification. The Notifications panel also lets you switch between recently-opened apps as quickly as possible.

Opening the Notifications panel

Press and hold the status bar, then slide your finger downward to open the Notifications panel.



If you have several notifications, you can scroll down the screen to see them all.



You can also open the Notifications panel on the Home screen by pressing MENU and then tapping Notifications.

Switching between recently-opened apps

On the Notifications panel, you can easily access up to eight apps you just recently opened.

1. Press and hold the status bar, then slide your finger downward to open the Notifications panel.
2. In the Recent apps section, slide your finger left or right to see recently-opened apps.

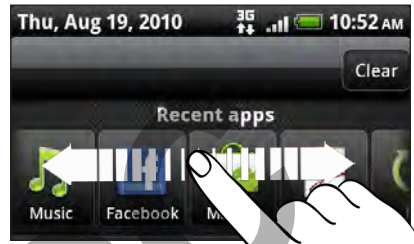

3. Tap an app to open it.



You can also go to the Recent apps screen when you press and hold HOME.

Closing the Notifications panel

Press and hold the bottom bar of the Notifications panel, then slide your finger up the screen. Or just press BACK.

Connecting your phone to a computer

Whenever you connect your phone to a computer using the USB cable, the Connect to PC screen opens and lets you choose the type of USB connection. Select one of the following choices, and then tap **Done**:

Charge only	Select this option if you only want to charge the battery while your phone is connected to your computer.
HTC Sync	Select this option to synchronize contacts, calendar, and other information between your computer and your phone. For more information, see “Synchronizing with your computer” in the Accounts and sync chapter.
Disk drive	This mode is available only when there's a microSD card on your phone. Select this mode when you want to copy files between your phone's storage card and your computer. For more information, see “Copying files to or from the storage card” in this chapter. When Disk drive mode is enabled while your phone is connected to the computer, you will not be able to use apps on your phone to access the storage card.
USB tethering	When you do not have Internet connection on your computer, you can select this mode to share your phone's mobile data connection with your computer. For more information, see “Using your phone as a modem (tethering)” in the Internet connections chapter.

Internet pass-through If you don't have a data plan for your phone or you don't have access to a Wi-Fi network, you can select this mode to share your computer's Internet connection with your phone. For more information, see the Internet connections chapter.

You can also change the type of USB connection on-the-fly, without having to disconnect and reconnect your phone. Slide open the Notifications panel, and then tap the notification that says "Select to change USB connection type" to open the Connect to PC screen again.



To change the default connection type or choose between showing and hiding the Connect to PC screen, press MENU from the Home screen, and then tap **Settings > Connect to PC**.

Copying files to or from the storage card

You can copy your music, photos, and other files to your phone's storage card.



1. Connect your phone to your computer using the supplied USB cable.
2. On your phone's Connect to PC screen, tap **Disk drive**, and then tap **Done**.
On your computer, the connected phone is recognized as a removable disk.
3. Navigate to the removable disk and open it.
4. Do one of the following:
 - Copy the files from the computer to the phone's storage card's root folder.
 - Copy the files from the phone's storage card to a folder in your computer.
5. After copying the files, unmount the removable disk (that is, the connected phone) as required by your computer's operating system to safely remove your phone.
6. Do one of the following:
 - Disconnect the phone from the computer.
 - If you want to keep the phone connected to the computer but want the phone to be able to access the storage card, open the Notifications panel, tap **Disk drive**, select an option except **Disk drive**, and then tap **Done**.

Searching your phone and the Web

Find all types of information on your phone and the Web. Search Anywhere sifts through different files, information, and apps on your phone. You can also choose to search the Web using your favorite web search service.

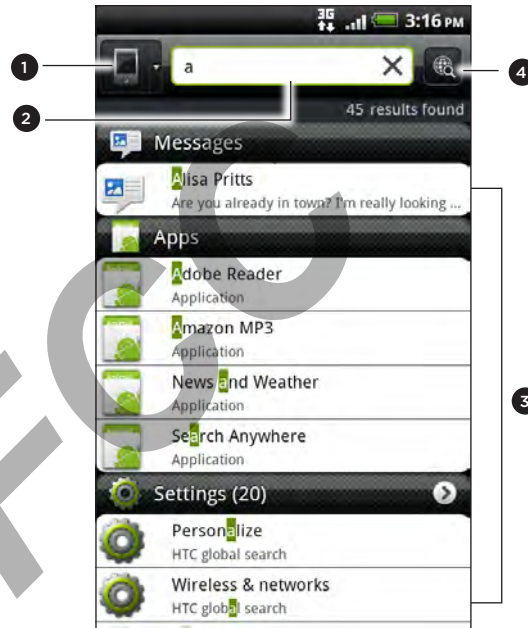
Simply press SEARCH from the Home screen. Then enter the first few letters of what you want to search for. Matching items will be shown as you type.



- 1 This icon () indicates that your phone will search for all types of information. Tap it if you want to choose and search only for one type of item, for example, Mail.
- 2 Type in what you want to search for.
- 3 Matching search suggestions and results. You can:
 - Scroll down to see more search results.
 - Tap  to see more results for a particular category.
 - Tap a search result item to open its app.
- 4 After entering a word or phrase in the search box, tap to search the Web using your favorite search service. To find out how to select a search service to use, see “Setting your phone’s search options”.

Setting your phone’s search options

1. From the Home screen, press SEARCH.
2. When the search box appears, press MENU, and then tap **Settings**.
3. Tap any of the following:

Web search engine	Choose a web search service you want to use.
Select areas to search	Choose the types of items or apps to include in the search. You can also press and hold  and arrange items according to search priority.

Quickly looking up information on the Web

Quick Lookup helps you learn about something right on the spot. When you enter a new word or phrase, you can readily look it up in popular websites or search services such as Google Search, Wikipedia, YouTube, Google Translate, and Google Dictionary.

1. From the Home screen, tap  > **Quick Lookup**.
2. If the onscreen keyboard is open, press BACK to close it first so you'll see the bottom tabs.
3. Slide across the tabs to pick where you want to look up information. Then in the search box, enter what you want to search for.

If, for example, you've found the information you were looking for in one tab such as Wikipedia, you can switch to the other tabs to automatically search the same item in Google Search on the Web, watch related videos in YouTube, or look up translations and meanings in Google Translate and Google Dictionary.



Translating words to other languages

1. From the Home screen, tap  > **Quick Lookup**.
2. Press BACK to hide the onscreen keyboard first, then slide to the **Google Translate** tab.
3. Under **From language**, choose the original language, then enter the word or phrase you want to translate.
4. Under **To language**, choose from the languages available for translation.
5. Tap **Translate**.

Adjusting the volume

Adjusting the ringer volume changes the volume level of the phone ringtone, while adjusting the media volume changes the volume level of sound notifications and music or video playback.

Adjusting the ringer volume

- Press the VOLUME UP or VOLUME DOWN button on the left panel of the phone to adjust the ringer volume to your desired level. The Ringer volume window appears on the screen to display the volume levels.
- While in the lowest ringer volume level (Silent mode), press VOLUME DOWN once to set your phone to Vibrate mode. The phone vibrates and the vibrate mode icon () appears in the status bar.
- While in Vibrate mode, press VOLUME UP once to switch to silent mode. The speaker mute icon () displays in the status bar.

Adjusting the media volume

When playing music or watching video, press the VOLUME UP or VOLUME DOWN button on the left panel of the phone to adjust the media volume. The Media volume window appears on the screen to display the volume level.

Adjusting the earpiece volume for phone calls

During a phone call, press the VOLUME UP or VOLUME DOWN button.

Adjusting the volume via settings

1. From the Home screen, press MENU, and then tap **Settings > Sound > Volume**.
2. Drag the volume sliders to the left or right to adjust the volume levels of your phone's ringtone, media playback, alarms, and notifications.
Your phone briefly plays a sample tone with the volume being adjusted as you drag a slider.
3. If you want the same volume for your ringtone and notifications, select **Use incoming call volume for notifications**.
4. When you're done, tap **OK**.

Sleep mode

Sleep mode saves battery power by putting your phone into a low power state while the display is off. It also stops accidental button presses when the phone's in your bag or pocket. You'll still receive messages and calls though.



To change the delay before your screen turns off, see "Adjusting the time before the screen turns off" in the Settings chapter.

Switching to Sleep mode

Quickly press the POWER button to turn off the display and switch your phone to Sleep mode. Your phone also automatically goes into Sleep mode when it's idle for a while.

Waking up from Sleep mode

Your phone automatically wakes up when you have an incoming call. To wake it up manually, press the POWER button. You'll need to unlock the screen.

Unlocking the screen

Press the bar on the lock screen and then slide your finger down to unlock the screen or answer an incoming call.

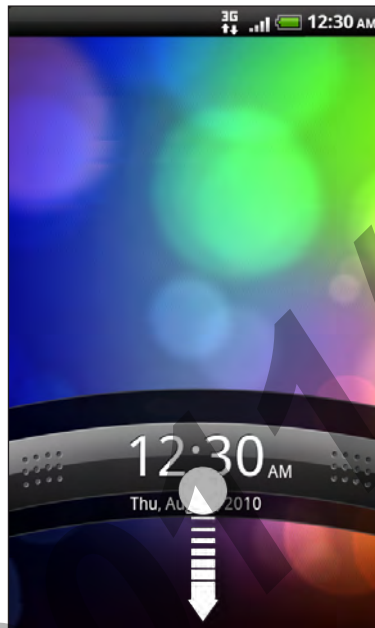

If you have set up a screen unlock pattern, pin, or password, you will be asked to draw the pattern on the screen or enter the PIN or password before it unlocks. See "Protecting your phone with a screen lock" in the Security chapter for details.

Phone calls

Making calls



Most SIM cards come with a PIN (personal identification number) set by your mobile operator. If you're asked for a PIN, enter it and then tap **OK**.

If you enter the wrong PIN three times, your SIM card is blocked. To unlock your SIM card, see "Restoring a SIM card that has been locked out" in the Security chapter.





Your phone's antennas are placed underneath the back cover. To get the best signal for calls, be sure to secure the back cover tightly to the phone.



Making a call on the Phone dialer screen

You can either dial a number directly, or use the Smart dial feature to search and call a stored contact or a number from your call history.

1. On the Home screen, tap **Phone**.
2. Begin entering the first few digits of a phone number or characters of a contact name on the phone keypad.

The Phone dialer screen then displays a list of matching numbers and names.

If you enter a wrong digit or letter, tap  to delete it. To erase the entire entry, press and hold .

3. Tap  to close the phone keypad and to see if there are more matching numbers or contacts. To browse through the filtered list, flick through the list or slide your finger up or down the list slowly.
4. To place a call, do one of the following:
 - Tap a phone number or contact from the list.
 - After entering a complete number, tap **Call**.
 - To call a different phone number associated with the contact, you can tap  at the right side of the contact name. On the contact details screen, tap the number you want to call.

While dialing or when the call is in progress, the status bar displays the Call in progress icon () and its color changes to pulsing green.

What is Smart dial?

The phone dialer's Smart Dial feature makes it quick and easy for you to place a call. Simply enter the phone number or first few letters of the person's name you want to call. Smart Dial automatically searches and filters your contacts list (stored on your phone, SIM card, and online accounts such as Google Account and Exchange ActiveSync) and the phone numbers from the call history.

Using Speed dial

Use Speed dial to call a phone number with a single tap. For example, if you assign a contact's number to the number 2 key, you can simply press and hold this key on the Phone dialer keypad to dial that number.

Assigning a speed dial key

1. On the Home screen, tap **Phone**.
2. Press **MENU**, and then tap **Speed dial > Add new**.
3. Enter the name of the contact you want to add. When the name comes up in the list, tap the name.
4. On the Speed dial screen, choose the phone number of the contact to use, and a speed dial key to assign.
5. Tap **Save**.

Calling a speed dial number

1. On the Home screen, tap **Phone**.
2. On the phone keypad:
 - The number 1 key is generally reserved for your voicemail. Press and hold this key to call voicemail and retrieve your voicemail messages.
 - Press and hold the key that is associated with the contact you want to call.

Calling a phone number in a text message

1. From the Home screen, tap  > **Messages**.
2. Tap the number or name of the person who sent you the text message.
3. Tap the phone number within the message.

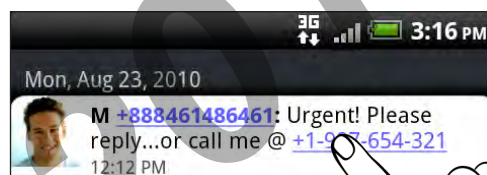

4. Edit the phone number if needed, and then tap **Call**.



To call the message sender, press and hold the sender or the received message, and then tap **Call** on the options menu.

To find out more about text messaging, see the Messages chapter.

Calling a phone number in an email

1. From the Home screen, tap  > Mail.
2. In your email account's inbox, tap the email that contains the phone number to call.
3. In the email body, tap the phone number. A selection menu then pops up and the phone number is highlighted.

The phone will recognize a number as a phone number if the number has a minimum of 5 digits and have at least one of the following:

- Numbers starting with a plus sign (+). For example, +1-987-654-321 or +1987654321.
 - Numbers starting with an area or country code enclosed in a parenthesis. For example, (02)987654321 or (02)987-654-321.
 - Numbers separated by dashes. For example, (02)-987-654-321 or 0987-654-321.
4. Tap **Call**.
 5. When the phone dialer screen opens with the phone number already entered, tap **Call**.

To find out more about using email on your phone, see the Email chapter.

Making an emergency call

You can make emergency calls from your phone even if you don't have a SIM card installed or your SIM card has been blocked.

1. From the Home screen, tap **Phone**.
2. Dial the international emergency number for your locale (for example, 000), and then tap **Call**.



Additional emergency numbers may be included in your SIM card. Contact your mobile operator for details.

If you've enabled but forgotten your lock screen password, lock pattern, and/or the SIM lock, you can still make emergency calls by tapping **Emergency call** on the screen.

Receiving calls

When you receive a phone call from a contact, the Incoming call screen appears and displays the caller ID icon, name, and phone number of the calling party.

When you receive a phone call from someone who is not stored in People, only the default caller ID icon and phone number appear on the Incoming call screen.



You can use your phone's polite ringer and pocket mode features for receiving calls. To find out how, see "Turning on or off automatic ring volume adjustment" in the Settings chapter.

Answering or rejecting an incoming call



If	To answer the call	To reject the call
Display is on	Tap Answer.	Tap Decline.
Display is off	When the Lock screen appears, drag the bar that shows the caller name or number downward.	Drag the bar upward. Or, press MENU and then tap Decline.

You can also do one of the following to reject an incoming call:

- Press the POWER button twice.
- To reject the call and send a text message, press MENU, and then tap Send message.

Changing the text message to send out for rejected calls

1. On the Phone dialer screen, press MENU.
2. Tap Settings > Edit default message.
3. Enter the new message, and then tap OK.

Muting the ringing sound without rejecting the call

Do one of the following:

- Press the VOLUME DOWN or VOLUME UP button.
- Press the POWER button.
- Place the phone face down on a leveled surface.



If the phone is already facing down, the phone will still ring when there are subsequent incoming calls.

HTC Caller ID

Everytime you make a call or your friend gives you a ring, you get to see your friend's latest status update from social networks like Facebook or Twitter right on the call screen.

You also won't miss people's birthdays. You'll see a birthday reminder, if your friend's birthday will occur sometime within the next seven days.



Using in-call options

When a call is in progress, use the buttons onscreen to mute or unmute the microphone or to turn on or off the speakerphone. You can also press MENU and choose whether to add a call, place the call on hold, mute the microphone, and more.

Putting a call on hold

Press MENU and then tap Hold to put the call on hold. When you put a call on hold, the status bar displays the Hold call icon () and its color changes to pulsing red. Press MENU, and then tap Unhold to resume the call.

Switching between calls

If you're already on a call and accept another call, you can choose to switch between the two calls.

1. When you receive another call, tap **Answer** to accept the second call, and to put the first call on hold.
2. To switch between the calls, tap the person you want to talk to on the screen.

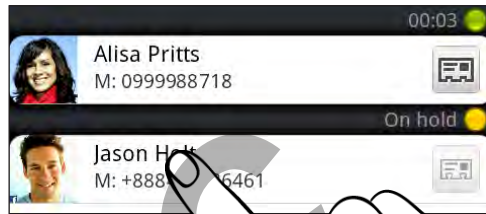





3. To end the current call and return to the other call, tap **End call**.

Setting up a conference call

Conference calling with your friends, family, or co-workers is easy. Make the first call (or accept a call), and then simply dial each subsequent call to add to the conference.





Make sure your SIM card is enabled with conference calling service. Contact your mobile operator for details.

1. Make a call to the first conference call participant.
2. When connected, press MENU, tap **Add call**, and then dial the number of the second participant. The first participant is put on hold when you dial the second participant.
3. When connected to the second participant, tap  (merge).
4. To add another participant to the conference call, tap  on the conference call screen, and then dial the number of the contact you want to invite to the conference call.
5. When connected, tap  to add the participant to the conference call.
When you want to talk to a person in the conference call in private, tap , and then select **Private call** on the options menu.
6. When finished, tap **End call**.

Turning the speakerphone on or off during a call

To turn the speakerphone on, you can do any of the following:

- Flip your phone over during a call (be sure that **Flip for speaker** is selected in HOME > MENU > Settings > Sound).
- On the call screen, tap .



The speakerphone icon () appears in the status bar when the speakerphone is on.

To turn the speakerphone off, just flip the phone over again, facing it up. Or tap  again.



To decrease potential damage to your hearing, do not hold your phone against your ear when the speakerphone is on.

Muting the microphone during a call

On the call screen, tap  to toggle between turning the microphone on or off. When the microphone is turned off, the Mute icon () appears in the status bar.

Ending a call

Do one of the following to end the call:

- On the call screen, tap **End call**.



If the phone display is off, press POWER to turn on the screen so you can tap **End call**.

- Slide open the Notifications panel, then tap .
- If you are using the provided wired headset, press the button to end the call.

If the phone number of the person who called is not in your contacts list, you can choose to save the number to your contacts list after you hang up.

Using Call history



Use the Call history to check missed calls, your dialed numbers and received calls.

Checking a missed call

You will see the missed call icon  in the status bar when you miss a call.

1. Slide open the Notifications panel to check who the caller is.
2. To return the call, tap the missed call notification. Then tap the caller's name or number on the Call history screen.

Checking calls in the call history

1. From the Home screen, tap  > **Call history**. You can also tap  on the Phone dialer screen.
2. On the Call history screen, you can:
 - Tap a name or number in the list to call.
 - Press and hold a name or number in the list to display the options menu where you can select to check the call history details, view contact information (if the number is stored in your contacts list), send a text message, delete from call history, or block the caller.
 - Tap  to check only the call history of a particular contact.
 - Press MENU, then tap **View** to display just a particular type of calls such as Missed calls or Outgoing calls.



You can also access Call history from the People app. For details, see the People chapter.

Adding a new phone number to your contacts from call history

1. On the Call history screen, press and hold a phone number that you want to save to your contacts, and then tap **Save to People**.
2. Choose whether to create a new contact or to save the number to an existing contact on your phone.
3. Do any of the following:
 - When creating a new contact, enter the contact name, contact type, and other information in the blank contact record that appears. The phone number is automatically added to the **Mobile** field in the Phone section. To store it as another type of number, for example a home number, tap the **Mobile** button.
 - When saving the number to an existing contact, tap a contact stored on your phone, and then select the number type.
4. Tap **Save**.



To find out how to add new contacts or edit the contact information, see the People chapter.

Clearing the call history list

On the Call history screen, you can do the following:

- To remove one name or number from the list, press and hold the name or number, and then tap **Delete from call history**.
- To clear the entire list, press MENU, and then tap **Delete all**.

Call services

Your phone can directly link to the mobile phone network, and enable you to access and change the settings of various phone services for your phone. Call services may include call forwarding, call waiting, voicemail, and more. Contact your mobile operator to find out about the availability of call services for your phone.

To open call services, press MENU from the Home screen, and then tap **Settings > Call**.

Fixed Dialing Numbers	Restrict outgoing calls to a fixed set of numbers. To enable this feature, you must know your SIM card's PIN2 code.
Voicemail service	Shows the current voicemail service being used.
Voicemail settings	Specify another voicemail number aside from the voice mail number on your SIM card.
Clear voicemail notification	If you have a notification of a new voicemail, you can clear the notification with this option.
Phone settings	Edit the call reject message, choose whether to open the message editor when you reject a call with a message, and choose whether to allow automatic saving of an unknown contact number when a call with that number ends.
Cell broadcast	Enable or disable receipt of cell broadcast messages from your service provider.
Cell broadcast settings	Configure channels and language for cell broadcast messages.
Call forwarding	Select how you want your phone to handle busy, unanswered, and unreachable calls. You can also set the call forwarding option for all incoming calls.
Call barring settings	Choose whether to block various categories of incoming and outgoing call.
Additional call settings	Enable or disable operator services such as caller ID and call waiting.

Turning Airplane mode on or off

In many countries, you are required by law to turn off the phone while on board an aircraft. A way to turn off the phone function is to switch your phone to **Airplane mode**. When you enable Airplane mode, all wireless radios on your phone are turned off, including the call function, data services, Bluetooth, and Wi-Fi.

To turn Airplane mode on or off, you can:

- Press and hold POWER, and then tap **Airplane mode**.
- From the Home screen, press MENU. Tap **Settings > Wireless & networks**, and then select or clear the **Airplane mode** check box.

When enabled, the Airplane mode icon () is displayed in the status bar.



When you disable Airplane mode, the call function is turned back on and the previous state of Bluetooth and Wi-Fi is restored.

For FCC
2011101124

People

About People

With the People app, you can sync your phone with contacts from your Google Account, computer, and Facebook. You can also sync with work contacts from the Exchange ActiveSync Server in your workplace. To find out how, see “Ways of getting contacts into your phone.”

Per contact, link the person’s information from all these different sources as one so you won’t have duplicated entries in your contacts list. To find out how to link, see “Merging contact information”.

And that’s not all. You can manage your communications with your contacts via phone, messaging, and email without the need to jump from one app to another. After you’ve linked contacts to their social network accounts like Facebook, Twitter, and Flickr, you’ll also see their updates and events from these accounts all in one place.

Adding a new contact

1. From the Home screen, tap  > People.
2. On the All tab, tap Add contact.
3. Select the **Contact type**, for example Google or Microsoft Exchange ActiveSync. This determines which account the contact will sync with. For more information, see “Ways of getting contacts into your phone” in this chapter.



Some fields may not be supported when you’re adding contacts to your SIM card.

4. In the Name field, enter the first and last name of the contact, then tap OK.
5. Enter the contact information in the fields provided.
Press BACK if you want to close the onscreen keyboard first and easily scroll through the other fields.
6. Tap Save.

Importing contacts from your SIM card

You can copy all your SIM contacts to your phone. You can import them as Phone contacts, Google contacts, or Exchange ActiveSync contacts, if you have set up the relevant accounts.



1. From the Home screen, tap  > People.
2. On the All tab, press MENU, and then tap Import/Export > Import from SIM card.
3. If you have Google or Exchange ActiveSync accounts set up on your phone, tap the type for the imported contacts.

4. Do one of the following:
 - To import all contacts, press MENU, and then tap **Select all**.
 - To import a contact, tap the contact.
5. Tap **Save**.

Importing a contact from an Exchange ActiveSync account

You can search for a work contact from your Exchange ActiveSync account, and then copy it to your phone.

You need to have your Exchange ActiveSync account set up on your phone first. To find out how, see “Adding a Microsoft Exchange ActiveSync account” in the Email chapter.

1. From the Home screen, tap  > **People**.
2. On the **Online directories** tab, tap **Company directory**.
3. Enter the name, and then tap .
4. In the list, tap the name of the contact you want to copy to your phone.
5. Tap **Save to People**.

Filtering your contacts list

You can choose to display contacts of a particular type only, for example Google contacts or Facebook contacts.

1. From the Home screen, tap  > **People**.
2. On the **All** tab, press MENU, then tap **View**.
3. Select the types of contacts you want to show in your contacts list.

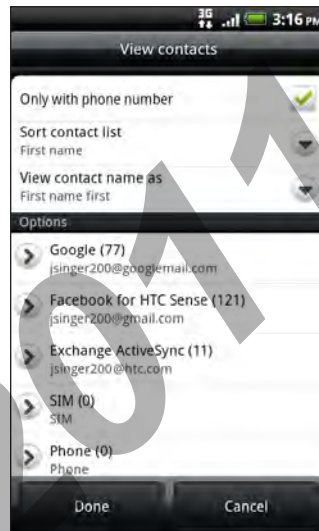

You can also choose how you want to display and sort your contacts.

4. Tap **Done**.

Searching for a contact

1. From the Home screen, tap  > People.
2. Press SEARCH, then enter the first few letters of a contact's first or last name, email, or company name.

You can also type in the first few digits of your contact's phone number. Matching contacts are displayed.

3. Tap the contact to open his or her contact details screen. See "Contact information and conversations" in this chapter for details.

Backing up your contacts to the storage card

1. From the Home screen, tap  > People.
2. Press MENU, and then tap Import/Export > Export to SD card.
3. Select an account or type of contacts to export, then tap OK.

Importing contacts from the storage card

1. From the Home screen, tap  > People.
2. Press MENU, and then tap Import/Export > Import from SD card.



You can only import contacts that were exported to the storage card using the Export to SD card feature on the phone. See "Backing up your contacts to the storage card."

3. If you have Google or Exchange ActiveSync accounts set up on your phone, tap the type for the imported contacts.

Deleting contacts

1. From the Home screen, tap  > People.
2. On the All tab, press MENU, and then tap Delete.
3. Select the contacts you want to delete, and then tap Delete.
4. When prompted, tap OK.

Contact groups

Assign contacts to groups so you can easily send a message or email to a whole group. You can also sync groups on your phone with the groups in your Google account, accessible via your computer's web browser.

We've also added the **Frequent** group as a special group type that automatically stores the contacts you dial or get calls from the most.

Creating a group



1. From the Home screen, tap  > People.
2. On the **Groups** tab, tap **Add group**.
3. Enter a name for the group, and then tap **Add contact to group**.
4. Select the contacts you want to add to the group, and then tap **Save**.



If your contacts list is long, you can use the search bar to search for contacts quickly, or press BACK to hide the onscreen keyboard and scroll through the list.

5. Tap  to select a photo for the group.
6. Tap **Save**.

Editing a contact group

1. From the Home screen, tap  > People.
2. On the **Groups** tab, press and hold the group, and then tap **Edit group**.
3. You can:
 - Tap the group name to change the name. You can only change the name for groups that you have created.
 - Tap the icon beside the group name to change or remove the group photo.
 - To add contacts to the group, tap **Add contact to group**, select the contacts you want to add, and then tap **Save**.
 - To remove a contact from the group, tap  at the right side of the contact name.
4. Tap **Save**.

Keyboard

Using the onscreen keyboard

When you start an app or select a field that requires text or numbers, the onscreen keyboard becomes available.

After entering your text, you can tap  or press BACK to close the onscreen keyboard.

Selecting a keyboard layout

You can choose from three different keyboard layouts to suit your typing style.

1. On the onscreen keyboard, tap the Language key (for example, tap  if you're currently using the English onscreen keyboard). Then on the International keyboard options menu, tap **Settings**.

If tapping the **Language** key doesn't display the International keyboard menu, press HOME > MENU, and tap **Settings > Language & keyboard > Touch Input**.

2. Tap **Keyboard types**, and then select the keyboard layout that you want to use. Choose one from the following:

QWERTY	This layout is similar to a desktop computer keyboard. This is the default keyboard layout.
Phone Keypad	This layout resembles the traditional mobile phone keypad.
Compact QWERTY	This layout features two letters on each key. The key size is slightly bigger than on the full QWERTY layout.

Entering text

Use the following keys while entering text using the onscreen keyboard:





 Press and hold keys with gray characters at the top to enter numbers, symbols, or accented letters. The gray character displayed on the key is the character that will be inserted when you press and hold that key. Some keys have multiple characters or accents associated with them.

 **Shift** key. Tap to enter an uppercase letter. Tap twice to turn on caps lock.

 Tap to switch to the numeric and symbol keyboard.

 **Enter** key. Tap to create a new line.

Tap the **Up**, **Down**, **Left**, or **Right** key to move the text cursor in the direction that you want while you are entering or editing text.

	Backspace key. Tap to delete the previous character.
	Language key. The key you see depends on the keyboard language you are currently using. Tap to switch to another keyboard language (see “Enabling multiple keyboard languages”). You can also access onscreen keyboard settings.
	Tap to toggle between Multitap and XT9 predictive modes when using the Compact QWERTY or Phone keypad layout. For more information, see “Entering words with predictive text.”
	Tap to hide the onscreen keyboard.

Enabling multiple keyboard languages

If there are multiple keyboard languages available on your phone, you can choose which languages to enable in the onscreen keyboard so that you can switch to these languages and use them to enter text.

1. On the onscreen keyboard, tap the **Language** key (for example, tap  if you're currently using the English onscreen keyboard). Then on the International keyboard options menu, tap **Settings**.

If tapping the Language key doesn't display the International keyboard menu, press HOME > MENU, and tap **Settings > Language & keyboard > Touch Input**.

2. Tap **International keyboard**.
3. Choose the languages that you want.

Available languages depend on the region where you purchased the phone.

Changing to the landscape onscreen keyboard

When entering text, you can choose to use the landscape orientation of the onscreen keyboard. Turn your phone sideways to use a larger keyboard for easy typing.

- The **Auto-rotate screen** check box in HOME > MENU > Settings > Display needs to be selected for the screen orientation to automatically change.
- The landscape orientation keyboard is not supported in all apps.

Entering words with predictive text

The onscreen keyboard has predictive text to help you type quickly and accurately. Predictive text input is enabled by default, and word suggestions are displayed as you type.

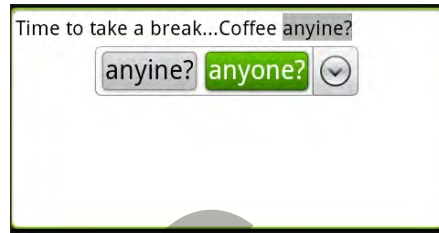

To enter a word in predictive mode, do any of the following:

- If you see the word you want highlighted in green or orange, you can simply tap the space bar to insert the word into your text.
- If you see the word you want shown in the suggestions before you have finished typing the entire word, tap the word to insert it into your text.
- If an arrow is shown to the right of the suggestion list, tap the arrow to see more suggestions.

Setting a second language for the keyboard

Aside from the keyboard language you are currently using, you can set the predictive text to be bilingual. As you type, you'll get word suggestions in two languages that you've selected.

1. On the onscreen keyboard, tap the **Language** key (for example, tap  if you're currently using the English onscreen keyboard). Then on the International keyboard options menu, tap **Settings**.

If tapping the Language key doesn't display the International keyboard menu, press HOME > MENU, and tap **Settings** > **Language & keyboard** > **Touch Input**.

2. Tap **Bilingual prediction**, and then choose the language you want.

Adding a word to the predictive text dictionary

Your phone comes with a list of words that it references for predictive text suggestions. Sometimes you may need to add a word to the predictive text dictionary, for example a name or a specialized technical word.

While entering text using the QWERTY keyboard layout, if you tap any word on the suggestion list, it is automatically added to the predictive text dictionary if it was not in the dictionary already.

You can also add a word to the list manually:

1. From the Home screen, press MENU, and then tap **Settings** > **Language & keyboard** > **Touch Input**.
2. Tap **Personal dictionary** > **Edit personal dictionary** > **Add new**.
3. Enter the word to add, and then tap **OK**.

Editing or deleting a word in the predictive text dictionary

You can edit or remove words that you previously added to the predictive text dictionary.

1. From the Home screen, press MENU, and then tap **Settings > Language & keyboard > Touch Input**.
2. Tap **Personal dictionary > Edit personal dictionary**.
 - To edit a word, tap the word itself.
 - To delete words from the dictionary, press MENU and tap **Delete**. Then choose the words to remove and tap **OK**.

Backing up your personal dictionary to your storage card

You can use your storage card to back up the new words you've added to the predictive text dictionary.

1. From the Home screen, press MENU, and then tap **Settings > Language & keyboard > Touch Input**.
2. Tap **Personal dictionary > Sync personal dictionary > Copy to storage card**.
3. When prompted, tap **OK**.

Importing your personal dictionary from your storage card

1. From the Home screen, press MENU, and then tap **Settings > Language & keyboard > Touch Input**.
2. Tap **Personal dictionary > Sync personal dictionary > Restore from storage card**.
3. When prompted, tap **OK**.

Entering text by speaking

No time to type? Try speaking the words to enter it in most text fields that let you use the onscreen keyboard.

Simply press and hold the **Language** key. When your phone cues you to “Speak now”, tell your phone what you want to be typed in.



- First make sure to select the language you'll be using in the **Voice input & output** settings. See “Setting the voice input language”.
- Since your phone uses Google's speech-recognition service, you need to be connected to the Internet to enter text by speaking.

Setting the voice input language

1. From the Home screen, press MENU, then tap **Settings > Voice input & output > Voice recognizer settings**.
2. Tap **Language**, then choose the language you want.

Available languages depend on the voice input languages supported by Google.

Editing text

You can select, copy, or cut the text you enter using the onscreen keyboard, then paste it in another text field within or across apps.



Some apps may offer their own way of selecting or copying text.

Selecting text

Highlight a portion of a text or select all that you want to copy or cut.

1. Press and hold the text field that contains the text to select. Don't lift your finger just yet to display the magnifier.

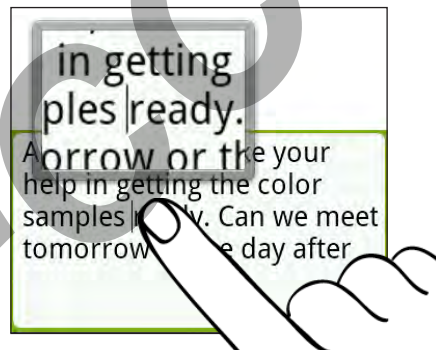

2. Drag your finger to move the text cursor to a letter within the text that you want to select. It should be easy since the magnifier gives you a bigger view of the text.
3. After positioning the text cursor, lift your finger. The text selection menu then pops up.
4. Do one of the following:
 - Tap **Select text**. When the word where you've placed the text cursor is highlighted, drag the start and end markers to select the text you want.

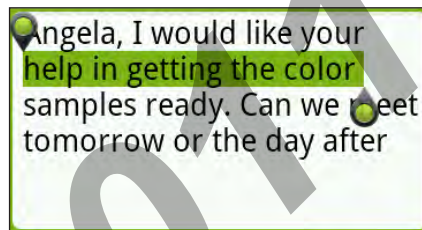

- Tap **Select all** to select everything in the text field.

Copying and pasting text

1. After you have selected the text you want to copy, tap **Copy** or **Cut**.

The selected text is then copied to the clipboard.

2. Within the same or another app, press and hold a text field where you want to paste the text. Don't lift your finger just yet to display the magnifier.

3. Drag your finger to move the text cursor to where you want to paste the text.
4. After positioning the text cursor, lift your finger. The text selection menu then pops up.
5. Tap Paste.

Adjusting touch input settings

Open the Touch Input settings by doing one of the following:

- On the onscreen keyboard, tap the **Language** key (for example, tap  if you're currently using the English onscreen keyboard). Then on the International keyboard options menu, tap **Settings**.
- From the Home screen, press MENU and then tap **Settings > Language & keyboard > Touch Input**.

Touch Input settings

Keyboard types	Select the keyboard layout to use. You can choose from QWERTY, Phone Keypad, or Compact QWERTY.
International keyboard	Add or remove languages from the onscreen keyboard language list.
Bilingual prediction	Select a secondary keyboard language to use. See "Setting a second language for the keyboard".
Text input	Set text input options when entering text, calibrate the keyboard, and set a sound and/or vibration feedback whenever you tap a key. See "Text input" for details.
Tutorial	Learn how to use the onscreen keyboard with this interactive tutorial.
Personal dictionary	Add, edit or remove words in the predictive text dictionary. See "Entering words with predictive text."

Text input

QWERTY	
Prediction	Select to enable the word prediction feature which provides a list of possible words that reflect the characters of the keys you have tapped as well as characters of nearby keys.
Spell correction	Select to correct typographical errors by selecting from a list of possible words that reflect the characters of the keys you have tapped as well as characters of nearby keys.
Phone keypad & compact QWERTY	
Spell correction	Select to correct typographical errors by selecting from a list of possible words that reflect the characters of the keys you have tapped as well as characters of nearby keys.
Word completion	When using the Compact QWERTY or Phone keypad, lets you select from a list of possible combinations based on the characters that appear on the keys that you tapped.

Other settings

Sound feedback	Select to hear a clicking sound whenever you tap a key on the keyboard.
Vibrate when typing	Select to enable vibration feedback whenever you tap a key on the keyboard.

Finger touch precision

Calibration tool	Tap to re-calibrate the keyboard touch accuracy. Re-calibrate the keyboard if you feel that the keyboard keys are not responding accurately to your taps.
Reset calibration	Tap to reset the calibration back to factory default.

For FCC
2011101124

Messages

About Messages

Keep in touch with important people in your life. Use the Messages app to compose and send text (SMS) and multimedia messages (MMS).

From the Home screen, tap  > Messages.

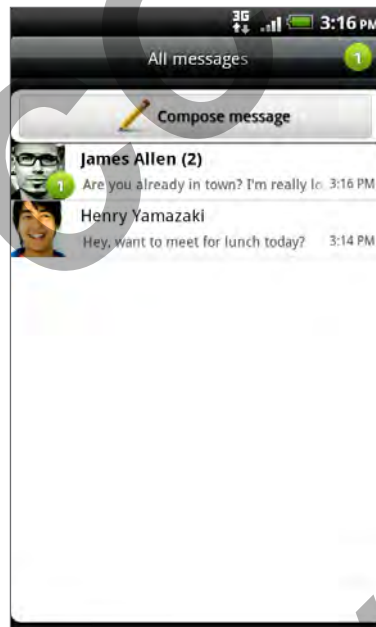

On the All messages screen, all your sent and received messages are neatly grouped into conversations, by contact name or phone number. You can:

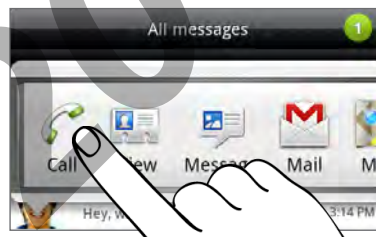

- Scroll up or down the list of conversations by swiping your finger on the screen.
- Tap a contact name or number to view the exchange of messages.
- Tap the photo or icon to open a menu where you can quickly choose how to communicate with the contact.



You can also view your messages on the Home screen with the Messages widget. If this widget is not there already, you can add it by following the steps in “Personalizing your Home screen with widgets” in the Personalizing chapter.

Sending a text message (SMS)

If you exceed the limit on the number of characters for a single text message, your text message will be delivered as one but will be billed as more than one message.

1. From the Home screen, tap  > Messages.
2. On the All messages screen, tap **Compose message**.
3. Fill in one or more recipients. You can:
 - Enter the first few letters of a contact name or starting digits of a mobile number. As you type, matching names with phone numbers from your stored contacts are displayed. Tap a name or one of the contact's number.
 - Tap the  icon, and then select the phone numbers of the contacts to whom you want to send the message. You can also select contact groups as recipients.
When you have selected all the message recipients, tap **Done**.
 - Enter the complete phone numbers directly in the **To** field.
4. Tap the box that says "Add text", and then enter your message.

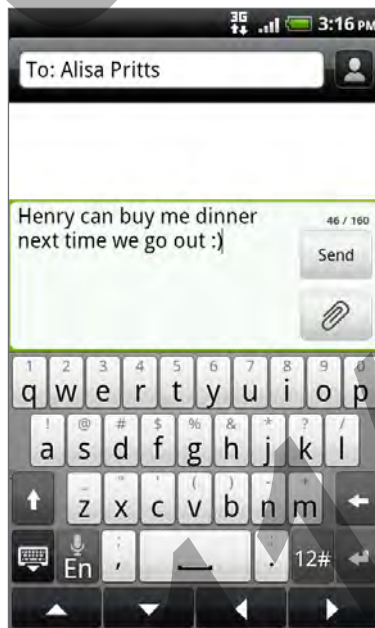

5. Tap **Send**.





Or press **BACK** to save it as a draft. To open and edit a draft message, see "Resuming a draft message."



Your text message automatically becomes a multimedia message when you enter an email address as the recipient, add a message subject, attach an item, or compose a very long message.

Sending a multimedia message (MMS)

To compose a multimedia message, start by creating a new text message. Then choose the type of attachment to include in your message.

1. From the Home screen, tap  > Messages.
2. On the All messages screen, tap **Compose message**.
3. Fill in one or more recipients. You can:
 - Enter the first few letters of a contact name or starting digits of a mobile number. As you type, matching names with phone numbers and email addresses from your stored contacts are displayed. Tap a contact's number or email address.
Email addresses will be displayed when **Show email address** is selected in Recipient list settings. To find out more about message settings, see "Setting message options".
 - Tap the  icon, and then select the phone numbers of the contacts to whom you want to send the message. You can also select contact groups as recipients.
When you have selected all the message recipients, tap **Done**.
 - Enter the complete phone numbers or email address directly in the **To** field.
4. To add a subject line, press MENU and then tap **Add subject**.
5. Tap the box that says "Add text", and then enter your message.
6. Tap  and then choose the type of attachment.
7. To make changes to your attachment, tap  or  (depending on the type of file you've attached).
You can also press MENU, then tap **Remove** to start over.
8. Tap **Send**.
Or press BACK to save it as a draft. To open and edit a draft message, see "Resuming a draft message."

Replying to another phone number of the contact

When a contact has multiple phone numbers stored on your phone, you'll see the particular phone number used within the message. There's also a bold letter before the phone number to indicate the number type (for example, **M** stands for **Mobile**).

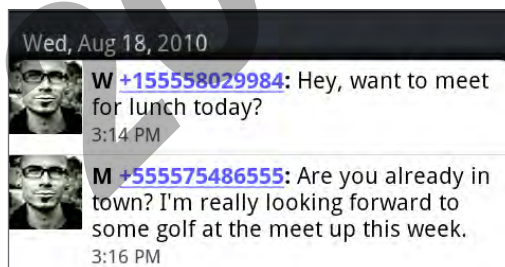

Keep in mind that your response will be sent to the phone number of the latest message you've received from this contact.

If you want to change the phone number before you send out your reply, press MENU, then tap **More > Recipient phone number**. Select another phone number of this contact, and then tap OK.

Viewing and saving an attachment from a multimedia message

If you are concerned about the size of your data downloads, check the multimedia message size first before you download it.



When **Auto-retrieve** in MMS settings is disabled, only the message header is downloaded. To download the entire message, tap the **Download** button at the right side of the message. To find out more about message settings, see “Setting message options.”

- If there’s a media attachment such as a photo or video in a received message, tap it to view the content.
- If the attachment is a contact (vCard), tap it to view the contact information, then tap **Save** to add to your contacts. Open the People app to view the contact. See the People chapter.
- If the attachment is an appointment or event (vCalendar), tap it and then choose the calendar where to save it. Tap **Import**. Open the Calendar app to view the appointment or event. See the Calendar chapter.
- To save the attachment to your storage card, press and hold the multimedia message, and then tap **Save [attachment type]** on the options menu.

Viewing push messages

Push messages contain a web link. Often, the link will be to download a file that you have requested, for example a ringtone.

When you receive a push message, a notification icon  is displayed in the status bar.

Opening and reading a new push message

1. Press and hold the status bar, and then slide the status bar down to open the Notifications panel.
2. Tap the new message.
3. Tap **Visit website**.

Viewing all your push messages

1. From the Home screen, tap  > Messages.
2. Press MENU, and then tap **Push messages**.

Calendar

Creating calendar events

You can create events that sync with your Google Calendar, your computer's Outlook Calendar, or Exchange ActiveSync calendar, as well as events that appear on your phone only.

1. From the Home screen, tap , and then tap **Calendar**.
2. On any Calendar view, press **MENU** and then tap **Add event**.



When you are in the Month or Agenda view, you can also tap  at the bottom-right of the screen to create a new event.

3. If you have more than one calendar, select a calendar in which to add the event:
 - Select your Google Account to create a Google Calendar event. If you have several Google Calendars on the Web, select one in which to add your event.
 - Select **PC Sync** to create calendar events on your phone. You can sync them with your computer using HTC Sync. For details, see the Accounts and sync chapter.
 - Select your Exchange ActiveSync account to create an Exchange ActiveSync calendar event.
4. Enter a name for the event.
5. To specify the date and time of the event, do one of the following:
 - If there is a time frame for the event, tap the **From** and **To** date and time to set them.
 - If it is a special occasion such as a birthday or a whole-day event, set the **From** and **To** date, then select the **All day** check box.
6. Enter the event location and description.
7. Set the reminder time.



You can add another reminder time in a Google Calendar event. Press **MENU** and then tap **Add reminder**.

8. If the event occurs on a regular basis, tap the **Repetition** box and then choose how often the event occurs.
9. Tap **Save**.

Managing calendar events

You can view, edit, delete, or share events that you created. You can also view and share event invitations that other people sent to you.

Viewing an event

1. From the Home screen, tap , and then tap **Calendar**.
2. In Month view, tap the day when the event takes place, and then tap the event to open it.

The Event details screen then opens and shows the summary of the event.

3. When viewing the event summary, you can do the following:
 - Find the event's location in **Maps**.
 - Call any phone number included in the event location or description.
 - Check the participants of the event you sent or are invited to.
 - Respond whether you'll attend the event you're invited to.
 - If it's an Exchange ActiveSync calendar event, reply by email to the organizer or to all the guests. Press MENU, and then either tap **Reply** or **Reply all**.
 - Select any text and look it up on the web. To learn more, see "Selecting text" in the Keyboard chapter and "Quickly looking up information on the Web" in the Getting started chapter.
 - Tap the reminder time to change it. Press BACK to save changes.

Editing an event

1. While viewing an event, press MENU, and then tap **Edit event**.
2. Make your changes to the event.
3. When you're done editing, tap **Save**.

Deleting an event

There are a number of ways to delete an event.

- While viewing the summary of an event on the Event details screen, press MENU and then tap **Delete event**.
- In Day, Agenda or Week view, press and hold an event and then tap **Delete event**.
- When editing an event, tap **Delete**.

If the event repeats, you'll be asked whether you want to delete just that occurrence, this and all future occurrences, or all past and future occurrences in your Calendar.

Sharing an event (vCalendar)

You can share a calendar event as a vCalendar to someone's phone using Bluetooth or by sending it as a file attachment with your email or message.

1. While viewing an event, press MENU, and then tap **Share vCalendar**.
2. Do one of the following:
 - Tap **Bluetooth**. you'll be asked to turn on Bluetooth on your phone and connect to the receiving Bluetooth device. Follow the steps in "Sending information using Bluetooth" in the Bluetooth chapter.
 - Tap **Mail**. A new message window opens and automatically includes the vCalendar as an attachment. Your default email account that's selected in the Mail app will be used to send. For more information, see the Email chapter.
 - Tap **Message**. A new message window opens and automatically includes the vCalendar as a multimedia attachment. For more information, see the Messages chapter.

Calendar event reminders

If you have set at least one reminder for an event, the upcoming event icon  will appear in the notifications area of the status bar to remind you of the upcoming event.

Dismissing or snoozing event reminders

1. Tap the status bar, then slide your finger down the screen to open the Notifications panel.
2. Do one of the following:
 - Tap **Clear** to dismiss event reminders and all other notifications. Other types of notifications such as new messages and missed calls will also be deleted.
 - After sliding open the Notifications panel, tap the calendar event reminder. You'll then see a list of all pending event reminders. Tap **Snooze all** to snooze all event reminders for five minutes, or tap **Dismiss all** to dismiss all event reminders.
 - Press BACK to keep the reminders pending in the notifications area of the status bar.

Changing Calendar settings

You can change Calendar settings to specify how it displays events and how it notifies you of upcoming events. In any Calendar view, press MENU and then tap **More > Settings** to access Calendar's settings.

Reminder settings

Choose how you want Calendar to issue event reminders when there are upcoming events.

All calendars	Select this check box to use the same event reminder settings for all types of calendars. If you clear this check box, you can set different reminder settings for each calendar.
Alerts & notifications	Configure event reminders to open an alert, send you a notification, or turn off event notifications on your phone.
Default reminder time	Choose how soon before an event you want to be notified.
Select ringtone	Choose a ringtone to sound when you receive an event reminder.
Vibrate	Choose whether you want your phone to vibrate when you receive an event notification.
Hide declined events	Choose whether to show or hide events to which you've declined invitations.

Calendar view settings

Choose what appears in Calendar when opened and what's shown in Day, Week, and Month views.

Start in	Choose the default Calendar view that is displayed when you open Calendar.
Day views	Choose whether to display Day view in the form of an event list or time list.
First day of week	Set the Month and Week views to start on a Sunday or Monday.
Include weather	Make sure this check box is selected so that weather information is shown in Day view's event list.
City	By default, Day view displays your current location's weather. You can change it to display the weather of another city.

About the Calendar widget

There's a Calendar widget available that you can add to your Home screen, and it comes in different calendar views. Tapping a day or event on the widget brings you to the Calendar app. To find out how you can add a widget, see "Personalizing your Home screen with widgets" in the Personalizing chapter.

Clock and Weather

About the HTC Clock widget

Use the HTC Clock widget to see your current date, time, and location. It's added by default on your Home screen. Tap the weather image to open the Weather app and check for more weather forecasts. See “Checking weather” for details.



If you want to show the time of another city, you can:

- Edit the widget settings. Press and hold the HTC Clock widget on the Home screen, then drag it to the **Edit** button. Select the city you want to show.
- Add another clock widget to the extended Home screen. Select from a variety of looks and designs. To find out how you can add a widget, see “Personalizing your Home screen with widgets” in the Personalizing chapter.

About the Clock app

Get more from the Clock app than just the regular date and time. Use your phone as a desk clock complete with weather information. Or let it serve as a night clock or a screensaver. As a world clock, see what time it is in several cities across the globe. You could also use it as an alarm clock, stopwatch, and countdown timer.

To open the Clock app, you can:

- Tap the HTC Clock widget on the Home screen.
- From the Home screen, tap , and then tap **Clock**.

Tap the tabs at the bottom row or slide your finger across the tabs to switch between the different functions of the Clock app.

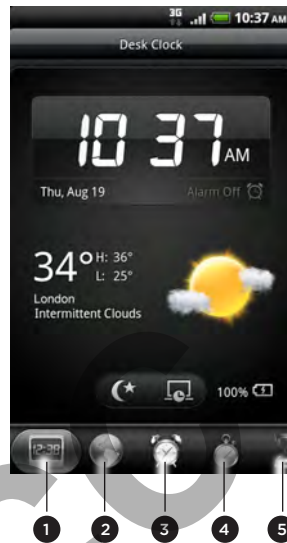

- 1 Desk Clock tab
- 2 World Clock tab
- 3 Alarms tab
- 4 Stopwatch tab
- 5 Timer tab

Using Desk Clock

Opening the Clock app brings you directly to the Desk Clock screen.

The Desk Clock displays the current date, time, and weather. It also has an alarm clock indicator and a battery charging indicator. You can dim the screen to show only the time and date on the Desk Clock.



- 1 Shows whether the alarm clock is on or off. To find out how to turn on and set the alarm clock, see “Setting the alarm clock.”
- 2 Shows the weather information of your current location. Tapping it brings you to the Weather app where you can see weather forecasts of the next few days. See “Checking weather” for more information about the Weather app.
- 3 Shows the battery charge level. You’ll see it only when your phone is plugged with the power adapter or connected to your computer.
- 4 Tap to dim the screen and display only the time and date on the Desk Clock. To light up the screen again, tap anywhere on the screen or press the BACK button on your phone.
- 5 Tap to dim the screen and go into screensaver mode. When in screensaver mode, the time and date will change position on the screen after every few minutes. To light up the screen again, tap anywhere on the screen or press the BACK button on your phone.

You can change the Desk Clock screen to display the date and time of another time zone. To find out how to select a different time zone, see “Setting the time zone, date, and time.”

Using World Clock

Use the Clock app’s World Clock screen to check the current time in several places around the globe simultaneously. You can also set your home city, add more cities to the world clock list, and manually set your time zone, date, and time.

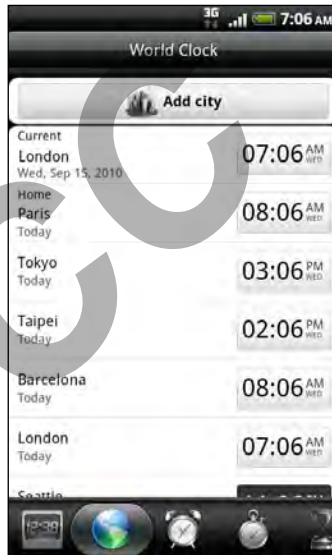

Setting your home city

1. Tap the HTC Clock widget on the Home screen.
2. Tap the World Clock tab.
3. Press MENU and then tap Home settings.
4. Enter your home city’s name. As you enter letters, the list is filtered to show matching cities and countries.
5. Scroll through the list and tap your home city.

Setting the time zone, date, and time

To set the time zone, date, and time on your phone manually, you need to turn off auto time synchronization first.

1. Tap the HTC Clock widget on the Home screen.
2. Tap the World Clock tab.
3. Press MENU and then tap Local time settings to open the Date & time settings screen.
4. Clear the Automatic check box.
5. Tap Select time zone. Scroll through the list and then tap the time zone that you want.

6. To change the date, tap **Set date**. Adjust the date by rolling the day, month, and year scroll wheels onscreen and then tap **OK**.
7. To change the time, tap **Set time**. Adjust the time by rolling the hour and minute scroll wheels onscreen and then tap **OK**.
8. Tap the **Use 24-hour format** check box to toggle between using a 12-hour or a 24-hour time format.
9. Tap **Select date format** then select how you want dates to be displayed. (The selected date format also applies to the date displayed in the alarm clock.)



From the Home screen, you can also press MENU and then tap **Settings > Date & time** to open the Date & time settings screen.

Adding a city to the World Clock screen

Add more cities to the World Clock screen so you can instantly check the date and time in these cities. In addition to the current and home cities, the World Clock screen can display up to 15 cities.

1. Tap the HTC Clock widget on the Home screen.
2. Tap the **World Clock** tab.
3. Tap **Add city**. Enter the city name you want to add. As you enter letters, the list is filtered to show matching cities and countries.
4. Scroll through the matching list and tap the city that you want to add.

Setting the alarm clock

You can use the Clock app's Alarms screen to set up one or more wake-up alarms.



Setting an alarm

1. Tap the HTC Clock widget on the Home screen.
2. Tap the **Alarms** tab.
3. Select the check box of an alarm, and then tap that alarm.
4. On the Set alarm screen, drag your finger up or down to roll the time scroll wheels and set the alarm time.
5. Scroll through the Set alarms screen to see all the available alarm options. You can:
 - Enter the alarm **Description** and choose the **Alarm sound** to use.
 - Tap **Repeat**. Select what days of the week to sound the alarm and then tap **OK**.
 - Select the **Vibrate** check box if you want your phone to also vibrate when the alarm goes off.
6. When you've finished setting the alarm, tap **Done**.



- To turn off an alarm, clear the check box of that alarm.
- If you need to set more than three alarms, press **MENU** while you're on the Alarms screen and then tap **Add alarm**.

Deleting an alarm

1. Tap the HTC Clock widget on the Home screen.
2. Tap the **Alarms** tab.
3. On the **Alarms** screen, press **MENU** and then tap **Delete**.
4. Select the alarms you want to delete and then tap **Delete**.

Changing alarm sound settings

If you've set one or more alarms, you can change their settings such as the alarm volume, how long to snooze the alarm, and more.

1. Tap the HTC Clock widget on the Home screen.
2. Tap the **Alarms** tab.
3. On the **Alarms** screen, press **MENU** and then tap **Settings**. You can change the following settings:

Alarm in silent mode	Selected by default, this option allows the alarm to sound even when your phone's volume is set to silent mode. Clear this check box if you want to silence the alarm when the volume is in silent mode.
Alarm volume	Set the volume level that you want for the alarm.
Snooze duration	Set how long to snooze between alarms.

Side button behavior

Choose what happens to the alarm when pressing the side button (VOLUME UP/DOWN) of your phone. You can set the button to snooze, dismiss the alarm, or disable the button.

The side button works only when the phone's screen is not locked. While on the lock screen, tap the onscreen **Snooze** button to snooze, or slide down the screen to dismiss the alarm.

Checking weather

If you consented to turn location service on when you were setting up your phone for the first time, you'll see the weather of your current location right on the HTC Clock widget of your Home screen.

You can also use the Weather app and widget to check the current weather and weather forecasts for the next four days of the week. In addition to your current location's weather, this app also displays the weather forecasts of other cities around the globe.



If you declined to turn location service on during first-time setup of your phone, turn location service on in your phone's settings so that you'll be able to check your current location's weather on the HTC Clock widget, Weather app, and the Weather widget. From the Home screen, press MENU, tap **Settings** > **Location**, and then select the **Use wireless networks** check box.

1. Connect to the Internet using your phone's Wi-Fi or data connection. To find out how, see the Internet connections chapter.
2. From the Home screen, tap , and then tap **Weather**.
3. On the Weather screen, you'll first see your current location's weather. To check the weather in other cities, swipe your finger up or down the screen.

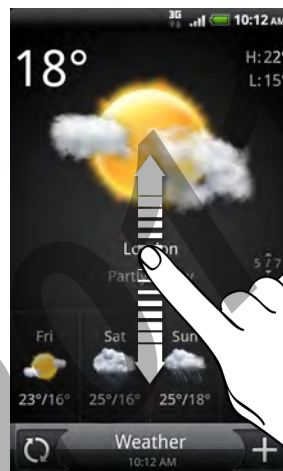

4. The Weather app automatically downloads and displays the latest weather updates. Tap  to update the information anytime.
5. To see more weather details on the Web, tap **Weather** at the bottom center of the Weather screen.

Adding a city to the Weather screen

Add more cities to the Weather screen so you can instantly check the weather forecasts in these cities. In addition to your current location, the Weather screen can display up to 15 cities.

1. On the Weather screen, tap .
2. Enter the location you want to add. As you type, the list is filtered to show the possible locations based on the letters you entered.
3. Tap the desired city to select it.

Changing the order of cities on the Weather screen

1. On the Weather screen, press MENU and then tap **Rearrange**.
2. Press and hold  at the end of the item you want to move. When the row is highlighted in green, drag it to its new position, then release.
3. Tap Done.

Deleting cities from the Weather screen

1. On the Weather screen, press MENU and then tap **Delete**.
2. Select the cities you want to remove and then tap **Delete**.

Changing weather options

1. On the Weather screen, press MENU and then tap **Settings**.
2. You can change the following weather settings:

Update when opened	Select this check box to refresh weather updates every time you open the Weather app.
Update automatically	Select this check box to automatically download weather updates.
Update schedule	Set an auto update schedule.
Temperature scale	Choose whether to display weather in Celsius or Fahrenheit.

About the Weather widget

Use the Weather widget to instantly check weather forecasts of your current location and other cities without having to open the Weather app. The Weather widget comes in different looks and styles.

You can add this widget to the Home screen, if it's not yet added. To find out how you can add a widget, see "Personalizing your Home screen with widgets" in the Personalizing chapter.

Internet connections

Data connection

Your phone will be automatically set up to use your mobile operator's data connection when you turn on your phone (if the SIM card is inserted) for the first time.

Checking the data connection you are using

1. From the Home screen, press MENU, and then tap **Settings**
2. Tap **Wireless & networks > Mobile networks > Network operators or Access Point Names**.

Turning the data connection on or off

Turning your data connection off can help save battery life and save money on data charges. However, if you don't have data connection turned on and you're also not connected to a Wi-Fi network, you won't receive automatic updates to your email, social network accounts, and other synchronized information.

1. From the Home screen, press MENU, and then tap **Settings**.
2. Tap **Wireless & networks**.
3. Select the **Mobile network** check box to turn on the data connection; clear the check box to turn off the data connection.

Creating a new access point

Before you add another data connection on your phone, have the access point name and settings (including username and password if required) from your mobile operator ready.

1. From the Home screen, press MENU, and then tap **Settings**.
2. Tap **Wireless & networks > Mobile networks > Access Point Names**.
3. On the APNs screen, press MENU and then tap **New APN**.
4. On the Edit access point screen, enter the APN settings. Tap the APN setting item to edit it.
5. Press MENU and then tap **Save**.

Enabling data roaming

Connect to your mobile operator's partner networks and access data services when you're out of your mobile operator's coverage area.



Using data services while roaming will be costly. Check with your mobile operator for data roaming rates before you use data roaming.

1. From the Home screen, press MENU, and then tap **Settings**.
2. Tap **Wireless & networks > Mobile networks**, and then select the **Data roaming** check box.

Select the **Data roaming sound** check box if you'd like your phone to play a sound so you'll know when it's connecting to a roaming network.

Wi-Fi

To use Wi-Fi on your phone, you need access to a wireless access point or "hotspot". The availability and strength of the Wi-Fi signal will vary depending on objects, such as buildings or simply a wall between rooms, the Wi-Fi signal has to pass through.

Turning Wi-Fi on and connecting to a wireless network

1. From the Home screen, press MENU, and then tap **Settings**.
2. Tap **Wireless & networks**, and then select the **Wi-Fi** check box to turn Wi-Fi on. The phone then scans for available wireless networks.
3. Tap **Wi-Fi settings**. The network names and security settings of detected Wi-Fi networks are displayed in the Wi-Fi networks section.
4. If the wireless network you want to connect to is not in the list of detected networks, scroll down the screen, and then tap **Add Wi-Fi network**. Enter the wireless network settings, and then tap **Save**.
5. Tap the Wi-Fi network you want to connect to.
 - If you selected an open network, you'll be automatically connected to the network.
 - If you selected a network that is secured with WEP, enter the key and then tap **Connect**.



Depending on the network type and its security settings, you may also need to enter more information or choose a security certificate.

When your phone is connected to a wireless network, the Wi-Fi icon  appears in the status bar and tells you the approximate signal strength (number of bands that light up).

The next time your phone connects to a previously accessed secured wireless network, you won't be asked to enter the key or other security information again, unless you reset your phone to its factory default settings.

Connecting to a Wi-Fi network with EAP-TLS security

You may need to install a network certificate (*.p12) to your phone before you can connect to a Wi-Fi network with EAP-TLS authentication protocol.

1. Save the certificate file to the root folder of the storage card.
2. From the Home screen, press MENU, and then tap **Settings**.
3. Tap **Security > Install from SD card**.
4. Select the network certificate needed to connect to the EAP-TLS network.
5. Follow the steps in the previous section to connect to the Wi-Fi network.

Checking the wireless network status

1. From the Home screen, press MENU, and then tap **Settings**.
2. Tap **Wireless & networks**.
3. On the Wireless & networks screen, tap **Wi-Fi settings**, and then tap the wireless network that the phone is currently connected to.

A message box is then displayed showing the Wi-Fi network name, status, speed, signal strength, and more.



If you want to remove the wireless network settings on your phone, tap **Forget**. You'll need to enter the settings again if you want to connect to this wireless network.

Connecting to another Wi-Fi network

1. From the Home screen, press MENU, and then tap **Settings**.
2. Tap **Wireless & networks > Wi-Fi settings**. Detected Wi-Fi networks are displayed in the Wi-Fi networks section.
3. To manually scan for available Wi-Fi networks, on the Wi-Fi settings screen, press MENU and then tap **Scan**.
4. Tap another Wi-Fi network to connect to it.

Adding connection widgets

Add the Mobile Network and Wi-Fi widgets or the Data dashboard widget to the Home screen to make it faster for you to turn on or off these connections. Tap the widget or icon on the dashboard to turn on or off the connection.



To find out how to add widgets, see “Adding a widget” in the Personalizing chapter.

Connecting to a virtual private network (VPN)

Add, set up, and manage virtual private networks (VPNs) so you can connect and access resources inside a secured local network, such as your corporate network.

Depending on the type of VPN you're using at work, you may be asked to enter your login credentials and install security certificates before you can connect to your company's local network. You can get this information from your network administrator.

Also, your phone must first establish a Wi-Fi or data connection before you can start a VPN connection. For information about setting up and using these connections on your phone, see "Data connection" and "Wi-Fi" in this chapter.

Setting up secure credential storage

If your network administrator tells you to download and install security certificates, you must first set up the phone's secure credential storage.

1. From the Home screen, press MENU, and then tap **Settings**.
2. Tap **Security > Set password**.
3. Enter a new password for the credential storage.
4. Scroll down and confirm the password, and then tap **OK**.
5. Select the **Use secure credentials** check box.

You can then download and install the certificates needed to access your local network. Your network administrator can tell you how to do this.

Adding a VPN connection

1. From the Home screen, press MENU, and then tap **Settings**.
2. Tap **Wireless & networks > VPN settings**.
3. Tap **Add VPN**, and then tap the type of VPN you want to add.
4. Tap the VPN settings and set them up according to the security details your network administrator gave you.
5. Press MENU, and then tap **Save**.

The VPN is then added to the VPNs section of the VPN settings screen.

Connecting to a VPN

1. From the Home screen, press MENU, and then tap **Settings**.
2. Tap **Wireless & networks > VPN settings**.
3. In the VPNs section, tap the VPN that you want to connect to.
4. When asked, enter your login credentials, and then tap **Connect**.
When you're connected, the VPN connected icon  appears in the notification area of the status bar.

You can then open the web browser to access resources such as your corporate network intranet.

Disconnecting from a VPN

1. Press and hold the status bar, and then slide down your finger to open the Notifications panel.
2. Tap the VPN connection to return to the VPN settings screen, and then tap the VPN connection to disconnect from it.

When your phone has disconnected from the VPN, the VPN disconnected icon  is displayed in the notification area of the status bar.

Using your phone as a modem (tethering)

No Internet connection available for your computer? No problem. Use your phone's data connection to connect to the Internet using your computer.

You need your SIM card inserted on your phone to use the data connection. To find out how to set up and use the data connection, see "Data connection" earlier in this chapter.

Before you can use your phone as a modem, be sure to install HTC Sync on your computer first. To find out how to install HTC Sync, see "Synchronizing with your computer" in the Accounts and sync chapter.

1. Make sure your phone's data connection is turned on. See "Turning the data connection on or off" earlier in this chapter to find out how to turn on the phone's data connection.
2. Connect the phone to the computer using the provided USB cable.
3. On the Connect to PC screen, select **USB tethering**, and then tap **Done**.

Connecting your phone to the Internet through a computer (Internet Pass-through)

If you don't have a data plan for your phone or you don't have access to a Wi-Fi network, you can still go online on your phone by using your computer's Internet connection.

Before you can use your computer as a modem, be sure to install HTC Sync on your computer first. To find out how to install HTC Sync, see "Synchronizing with your computer" in the Accounts and sync chapter.

1. Make sure your computer is connected to the Internet.

F Two things to check for your computer's Internet connection. One, we recommend that you turn off your local network's firewall. Two, if your computer connects to the Internet via PPP (e.g. Dial UP, xDSL, or VPN), Internet Pass-through will only support TCP protocol.

2. Connect the phone to the computer using the provided USB cable.
3. On the Connect to PC screen, select **Internet Pass-through**, and then tap **Done**.
4. On the message window, tap **OK**.

Using your phone as a wireless router

Share your data connection with other devices by turning your phone into a wireless router. Make sure your phone's data connection is turned on before you use it as a wireless router. To find out how to turn on your phone's data connection, see "Data connection" earlier in this chapter.

1. From the Home screen, press MENU, and then tap **Settings**.
2. Tap **Wireless & networks > Portable Wi-Fi hotspot settings**.



The first time you open Portable Wi-Fi hotspot, a brief introduction describing the app is displayed. Tap **OK**.

3. Enter a name in **Router name (SSID)**, or use the default router name.
4. Choose the type of **Security** and set the **Password** (key) for your wireless router. If you selected **None** in Security, you don't need to enter a password.
The password is the key other people need to enter on their device so they can connect and use your phone as a wireless router.
5. Select the **Portable Wi-Fi Hotspot** check box to turn on your phone's wireless router.

Your phone is ready to be used as a wireless router when you see  on the status bar.

For FCGC
2011101124

Bluetooth

Bluetooth basics

Turning Bluetooth on or off

1. From the Home screen, press MENU, and then tap **Settings > Wireless & networks**.
2. Select or clear the **Bluetooth** check box.

An even easier way to turn Bluetooth on or off is with the Bluetooth widget or Bluetooth setting shortcut on the Home screen. To find out how to add widgets and shortcuts to the Home screen, see the Personalizing chapter.



Turn off Bluetooth when not in use to save battery power, or in places where using a wireless device is prohibited, such as on board an aircraft and in hospitals.

Changing the phone name

The phone name identifies your phone to other devices.

1. From the Home screen, press MENU, and then tap **Settings > Wireless & networks > Bluetooth settings**.
2. If the **Bluetooth** check box is not selected, select it to turn Bluetooth on.
3. Tap **Device name**.
4. Enter the name for your phone in the dialog box, and then tap **OK**.

Connecting a Bluetooth headset or car kit

You can listen to music over a Bluetooth stereo headset, or have hands-free conversations using a compatible Bluetooth headset or car kit. It's the same procedure to set up stereo audio and hands-free.

- For you to listen to music with your headset or car kit, the headset or car kit must support the A2DP Bluetooth profile.
- Before you connect your headset, you need to make it discoverable so your phone can find it. You can find out how to do this by referring to your headset manual.

1. From the Home screen, press MENU, and then tap **Settings > Wireless & networks > Bluetooth settings**.
2. If the **Bluetooth** check box is not selected, select it to turn Bluetooth on.
3. Make sure that the headset is discoverable.

4. Tap **Scan for devices**. Your phone will start to scan for Bluetooth devices within range.
5. When you see the name of your headset displayed in the Bluetooth devices section, tap the name. Your phone then automatically tries to pair with the headset.
6. If automatic pairing fails, enter the passcode supplied with your headset.

The pairing and connection status is displayed below the hands-free headset or car kit name in the Bluetooth devices section. When the Bluetooth headset or car kit is connected to your phone, the Bluetooth connected icon  is displayed in the status bar. Depending on the type of headset or car kit you have connected, you can then start using the headset or car kit to listen to music and/or make and receive phone calls.

Reconnecting a headset or car kit

Normally, you can easily reconnect your headset by switching on Bluetooth on your phone, and then turning on the headset. However, you might have to connect manually if your headset has been used with another Bluetooth device.

1. From the Home screen, press MENU, and then tap **Settings > Wireless & networks > Bluetooth settings**.
2. If the **Bluetooth** check box is not selected, select it to turn Bluetooth on.
3. Make sure that the headset is discoverable.
4. Tap the headset's name in the Bluetooth devices section.
5. If prompted to enter a passcode, try 0000 or 1234, or consult the headset/car kit documentation to find the passcode.

If you still cannot reconnect to the headset or car kit, follow the instructions in “Unpairing from a Bluetooth device”, and then follow the steps under “Connecting a Bluetooth headset or car kit.”

Disconnecting or unpairing from a Bluetooth device

Disconnecting a Bluetooth device

1. From the Home screen, press MENU, and then tap **Settings > Wireless & networks > Bluetooth settings**.
2. In the Bluetooth devices section, press and hold the device to disconnect.
3. Tap **Disconnect**.

Unpairing from a Bluetooth device

You can make your phone forget its pairing connection with another Bluetooth device. To connect to the other device again, you may need to enter or confirm a passcode again.

1. From the Home screen, press MENU, and then tap **Settings > Wireless & networks > Bluetooth settings**.
2. In the Bluetooth devices section, press and hold the device to unpair.
3. Tap **Disconnect & unpair**.

Or, tap **Unpair** if the Bluetooth device is currently not connected to your phone.

Sending information using Bluetooth







You can use Bluetooth to send information from your phone to another Bluetooth enabled device such as a phone or notebook computer. Depending on the device you are sending to, you can send the following types of information:

- Photos and videos
- Calendar events
- Contacts
- Audio files

Before you begin, set the receiving device to discoverable mode. You may also need to set it to “Receive Beams” or “Receive Files”. Refer to the device’s documentation for instructions on receiving information over Bluetooth.

The first time you transfer information between your phone and another device, you need to enter or confirm a security passcode. After that, your phone and the other device are paired, and you will not need to exchange passcodes to transfer information in the future.

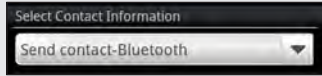
1. On your phone, open the app that contains the information or file you want to send.
2. Follow the steps for the type of item you want to send:

Captured photo or video	After capturing, on the Camera preview screen, tap the Share button  , and then tap Bluetooth .
Photos or videos	<ol style="list-style-type: none"> 1. On the Albums tab  of the Gallery app, choose an album. 2. Tap the Share button , and then tap Bluetooth. 3. Choose the photos and videos you want to share, and then tap Next.
Contact	<ol style="list-style-type: none"> 1. On the All tab  of the People app, press and hold a contact, and then tap Send contact as vCard. 2. Tap the down arrow icon, and then select Bluetooth from the displayed list.
	
Calendar event	In Day view, Agenda view, or Week view, press and hold the event, and then tap Share vCalendar > Bluetooth .
Music track	With the track displayed on the Music app’s Now playing screen, press MENU, and then tap Share > Bluetooth .
Voice recording	On the main Voice Recorder screen, tap the Share button  , and then tap Bluetooth .

3. Turn on Bluetooth if you're asked to do so.
4. If you haven't paired with the receiving device before, tap **Scan for devices**.
5. Tap the name of the receiving device.
6. If prompted, accept the pairing request on your phone and the receiving device.
Also enter the same passcode on both your phone and the other device, or confirm the auto-generated passcode.
7. On the receiving device, accept the file.

Where sent information is saved

When you send information from your phone using Bluetooth, the location where it's saved depends on the type of information and the receiving device.

If you send a calendar event or contact, it is normally added directly to the corresponding app on the receiving device. For example, if you send a calendar event to a compatible phone, the event is shown in that phone's calendar app.

If you send another file type to a Windows computer, it is normally saved in the Bluetooth Exchange folder within your personal document folders.

- On Windows XP, the path may be:
C:\Documents and Settings\[your username]\My Documents\Bluetooth Exchange
- On Windows Vista, the path may be:
C:\Users\[your username]\Documents
- On Windows 7, the path may be:
C:\Users\[your username]\My Documents\Bluetooth Exchange Folder

If you send a file to another device, the saved location may depend on the file type. For example, if you send an image file to another mobile phone, it may be saved in a folder named "Images."

Receiving information using Bluetooth

Your phone is capable of receiving a wide variety of file types with Bluetooth, including photos, music tracks, and documents such as PDFs.

The first time you transfer information between your phone and another device, you need to enter or confirm a security passcode. After that, your phone and the other device are paired, and you will not need to exchange passcodes to transfer information in the future.

To receive files using Bluetooth, you need to have a microSD card on your phone.

1. From the Home screen, press MENU, and then tap **Settings > Wireless & networks > Bluetooth settings**.
2. If the **Bluetooth** check box is not selected, select it to turn Bluetooth on.
3. Select the **Discoverable** check box.
4. On the sending device, send one or more files to your phone. Refer to the device's documentation for instructions on sending information over Bluetooth.

5. If prompted, accept the pairing request on your phone and the receiving device.

Also enter the same passcode on both your phone and the other device, or confirm the auto-generated passcode.

A Bluetooth authorization request is then displayed on your phone.

6. If you want to automatically receive files from the sending device in the future, select the **Always** check box.
7. Tap **Accept** or **OK**.
8. When your phone receives a file transfer request notification, slide down the Notifications panel, tap the incoming file notification, and then tap **Accept**.
9. When a file is transferred, a notification is displayed. To open the file immediately, slide down the Notifications panel, and then tap the relevant notification.

When you open a received file, what happens next depends on the file type:

- Media files and documents are usually opened directly in a compatible app. For example, if you open a music track, it starts playing in the Music app.
- For a vCalendar file, choose the calendar where you want to save the event, and then tap **Import**. The vCalendar is added to your Calendar events. For information on using Calendar, see the Calendar chapter.
- For a vCard contact file, if there are multiple vCard files on your storage card, you can choose to import one, several, or all of those contacts to your contacts list.

Adding the Bluetooth received folder to the Home screen

You can add a folder to the Home screen that shows all files you have received with Bluetooth.

1. From the Home screen, tap .
2. On the Personalize screen, tap **Folder > Bluetooth received**.
3. Press and hold the Bluetooth received folder icon, and drag it to the Home screen position you want.

To view the folder contents, tap the folder icon. To open a file, tap the file name.

Security

Protecting your SIM card with a PIN

Add another layer of security for your phone by assigning a PIN (personal identification number).

Make sure you have the default SIM PIN provided by your mobile operator before continuing.

1. From the Home screen, press MENU, and then tap **Settings > Security**.
2. Tap **Set up SIM card lock**, then select **Lock SIM card**.
3. Enter the default SIM card PIN, and then tap **OK**.
4. To change the SIM card PIN, tap **Change SIM PIN**.



Emergency calls can be placed at any time without requiring a PIN. See “Making an emergency call” in the Phone calls chapter for more details.

Restoring a SIM card that has been locked out

If you enter the wrong PIN more times than the maximum number of attempts allowed, your SIM card will become “PUK-locked.” You need a PUK code to restore access to the phone. This code may have been provided by your mobile operator when you received your SIM card.

1. On the Phone dialer screen, enter the PUK code, and then tap **Next**.
2. Enter the new PIN you want to use, and then tap **Next**.
3. Enter the new PIN again, and then tap **Next**.

Protecting your phone with a screen lock

Protect your personal information and prevent others from using your phone without your permission by setting a screen lock password, a PIN, or a lock pattern.

Your screen lock will be asked every time your phone is turned on or when it's idle for a certain period of time.

1. From the Home screen, press MENU, and then tap **Settings > Security**.
2. Tap **Set up screen lock**.
3. Tap one of the following:

None	Disable the screen lock you've previously created.
Pattern	Set a screen lock pattern by following the onscreen instructions.
PIN	Set a numeric password of at least four digits.
Password	Set an alpha-numeric password.

4. On the Security screen, tap **Lock phone after**, then specify the idle time you can allow before the screen is locked.



You can also clear the **Use visible pattern** or **Visible passwords** on the Security screen if you don't want your screen lock to display as you enter it onscreen.

Changing your screen lock

1. From the Home screen, press MENU, and then tap **Settings > Security**.
2. Tap **Change screen lock**.
3. Enter your current screen lock to confirm that you want to change it.
4. Choose a different screen lock type, then enter your new pattern, PIN, or password.

Or tap **None** if you don't want to use a screen lock.

Forgot your screen lock pattern?

If you've forgotten your screen lock pattern, you have up to five attempts to try and unlock your phone. If this fails, you can unlock your phone by entering your Google Account user name and password.

1. On the unlock screen, enter your lock pattern.
2. After the fifth attempt and you're asked to wait for 30 seconds, tap **OK**.
3. If the display goes off, press the **POWER** button to turn the display back on, and then press the bar on the lock screen and slide your finger down to unlock the screen.
4. Tap the **Forgot pattern?** button in the lower right corner when it appears.
5. Enter your Google Account name and password, and then tap **Sign in**.

You'll then be asked to create a new screen lock pattern. If you no longer want to do so, tap **Cancel**.

Settings

Settings on your phone

Control and customize phone settings on the Settings screen.

From the Home screen, press MENU, and then tap **Settings**.

Personalize	Choose a scene, set the Home screen wallpaper to use, apply a skin, and set sound options.
Wireless & networks	Set up your phone's wireless connections, such as Wi-Fi and Bluetooth, enable the Airplane mode, or set the options for mobile networks, roaming, Wi-Fi hotspot, Virtual Private Networks, and more.
Call	Set up call services such as voicemail, call forwarding, call waiting, and caller ID.
Sound	<ul style="list-style-type: none"> ▪ Choose sounds to use for your phone ringtone and notifications. ▪ Adjust media playback volume. See “Adjusting the volume” in the Getting started chapter. ▪ Set to lower the ring volume when you move the phone when it's ringing, make the phone ring louder when inside a bag or pocket, and turn on the speakerphone when you flip over the phone.
Display	Set up display settings such as automatic screen orientation, brightness, screen timeout, and more.
Accounts & sync	Log in or out of your social network accounts, Google Account, Exchange ActiveSync account, and HTC Sense.com account. You can also manage synchronization and other settings for your accounts. See the Accounts and sync chapter for details.
Location	Select the sources to use when determining your location. Select Phone finder so you can use HTC Sense.com to locate your phone.
Search	Select items to include when you do a search on your phone and set Google search options.
Privacy	Choose to automatically back up some settings on the phone (e.g. Wi-Fi passwords or Bookmarks) to Google servers using your Google Account so you can restore them when needed.
Connect to PC	<ul style="list-style-type: none"> ▪ Set the default USB connection type to use whenever you connect your phone to your computer. ▪ Or, select the Ask me check box to set your phone to always display the screen for selecting the USB connection type. To find out more, see “Connecting your phone to a computer” in the Getting started chapter.
Security	Set a screen lock, enable the SIM card lock, or manage the phone's credential storage. See the Security chapter for details.

Dock	If you purchased the car kit, choose the behavior when you mount your phone to the car kit.
Power	Turn on power saver to automatically switch to power saving mode when the battery level goes down to the level that you set. See “Optimizing your phone’s battery life” in this chapter for details.
Applications	Manage running applications, move applications to or from the storage card, and install or uninstall programs.
SD & phone storage	<ul style="list-style-type: none"> ▪ Check the available storage card and phone memory. ▪ From this screen, be sure to unmount your microSD card before you remove it from your phone. ▪ You can also do a factory reset. See the Update and reset chapter for more details.
Date & time	Set the date and time, time zone, and date or time format. To turn off auto time synchronization and be able to manually change time zone settings, see “Setting the time zone, date, and time” in the Clock and weather chapter.
Language & keyboard	Set the operating system language and region. You can also set onscreen keyboard options.
Accessibility	Use these settings when you’ve downloaded and installed an accessibility tool, such as a screen reader that provides voice feedback. You can turn accessibility functions or services on or off.
Voice input & output	Set up the voice input options of your phone. Also, if you’ve installed a text-to-speech (voice data) app, use this to set the text-to-speech settings.
About phone	<ul style="list-style-type: none"> ▪ Turn on or off scheduled checks for system software updates, or manually check for updates. ▪ Turn Tell HTC on or off. When enabled, you’re helping us know if your phone encounters a technical problem. ▪ View different information about your phone, such as the mobile network type, signal strength, battery level, battery use of individual applications, software version of your phone, and more. See “Checking information about your phone” in this chapter.

Changing display settings

Adjusting the screen brightness manually

1. From the Home screen, press MENU, and then tap **Settings**.
2. Tap **Display > Brightness**.
3. Clear the **Automatic brightness** check box.
4. Drag the brightness slider to the left to decrease or to the right to increase the screen brightness. Tap **OK**.

Adjusting the time before the screen turns off

After a period of inactivity, the phone screen turns off to conserve battery power. You can set the idle time before the screen turns off.

1. From the Home screen, press MENU, and then tap **Settings**.
2. Tap **Display > Screen timeout**.
3. Tap the time before the screen turns off.

Turning automatic screen rotation off

By default, the screen orientation automatically adjusts depending on how you hold the phone.



Automatic rotation is not supported in all application screens.

1. From the Home screen, press MENU, and then tap **Settings**.
2. Tap **Display**, and then clear the **Auto-rotate screen** check box.

Recalibrating the G-sensor

Recalibrate the screen if you feel that the screen orientation does not respond properly to the way you hold the phone.

1. From the Home screen, press MENU, and then tap **Settings**.
2. Tap **Display > G-Sensor calibration**.
3. Place the phone on a flat and level surface, and then tap **Calibrate**.
4. After the recalibration process, tap **OK**.

Keeping the screen on while charging the phone

You can keep the phone screen from turning off while you're charging the phone.

1. From the Home screen, press MENU, and then tap **Settings**.
2. Tap **Applications > Development**.
3. Select the **Stay awake** check box.

Switching animation effects on or off

You can turn off the animation or enable only some animations when switching between screens.

1. From the Home screen, press MENU, and then tap **Settings**.
2. Tap **Display > Animation**.
3. On the options menu, select the animation setting you want.

Changing sound settings

Switching between silent, vibration, and normal modes

- To change back from silent to normal mode, simply press the VOLUME UP button.
- To change back from vibration to normal mode, press the VOLUME UP button twice.
- From the Home screen, press MENU, and then tap **Settings > Sound > Sound profile**.
- You can also add the Profile widget to your Home screen. To find out how to add a widget, see “Personalizing your Home screen with widgets” in the Personalizing chapter.

Enabling or disabling audible selection

You can choose to play a sound when you're selecting items onscreen.

1. From the Home screen, press MENU, and then tap **Settings**.
2. Tap **Sound**, and then select the **Audible selection** check box.

Turning on or off automatic ring volume adjustment

Quiet ring on pickup

Your phone has a quiet ring feature that automatically lowers the ring volume when you move your phone.

1. From the Home screen, press MENU, and then tap **Settings**.
2. Tap **Sound**, and then select or clear the **Quiet ring on pickup** check box.

Turning on Pocket mode

To help avoid missing incoming calls when your phone is in your pocket or bag, the pocket mode feature gradually increases the ring volume and vibrates when you receive a call. When not in your pocket or bag, the phone will ring at the normal volume you set.

1. From the Home screen, press MENU, and then tap **Settings**.
2. Tap **Sound**, and then select or clear the **Pocket mode** check box.

Switching to speakerphone automatically

You can switch to speakerphone by simply flipping over your phone.

1. From the Home screen, press MENU, and then tap **Settings**.
2. Tap **Sound**, and then select or clear the **Flip for speaker** check box.

Changing the phone language

When you turn your phone on for the first time, you're asked to choose the language you want to use for your phone. If you want, you can still change the phone language after you set up your phone. Changing the language adjusts the keyboard layout, date and time formatting, and more.

The languages available to choose from may depend on the version of phone you have.

1. From the Home screen, press MENU, and then tap **Settings**.
2. Tap **Language & keyboard > Select language**.
3. Tap the language and corresponding region you want to use.
4. Press HOME to return to the Home screen. You may need to wait a few seconds for the new language to be applied.

Optimizing your phone's battery life

You can set the phone to automatically switch to power saving mode when the battery level reaches a certain level.

1. From the Home screen, press MENU, and then tap **Settings**.
2. Tap **Power**.
3. Select the **Enable power saver** check box.
4. Tap **Turn power saver on at**, and then select when to switch to power saver mode.
5. In the **Power saver settings** section, set and select the phone behavior when the phone switches to power saving mode.

Using the GSM network of your mobile operator

Switch to using the GSM network of your mobile operator if you're not using a data connection to connect to the Internet. Connecting to your mobile operator's GSM network consumes less battery power.

1. From the Home screen, press MENU, and then tap **Settings**.
2. Tap **Wireless & networks > Mobile networks > Network Mode**.
3. Tap **GSM only**.

Checking the power usage of applications

1. From the Home screen, press MENU, and then tap **Settings**.
2. Tap **About phone > Battery > Battery use**.

Managing memory

Checking how much phone memory is available for use

1. From the Home screen, press MENU, and then tap **Settings**.
2. Tap **SD & phone storage**. The available phone memory is displayed in the Internal phone storage section.

Checking the available storage card space

1. From the Home screen, press MENU, and then tap **Settings**.
2. Tap **SD & phone storage**. The total and available storage card space is displayed in the SD card section.

Clearing application cache and data

1. From the Home screen, press MENU, and then tap **Settings**.
2. Tap **Applications > Manage applications**.
3. On the Manage applications screen, switch to the **Running** tab, and then tap the application whose cache and/or data you want to delete.
4. In the Application info screen, tap **Clear data** and/or **Clear cache**.

Uninstalling third-party applications

You cannot uninstall applications that are preinstalled on the phone.

1. From the Home screen, press MENU, and then tap **Settings**.
2. Tap **Applications > Manage applications**.
3. On the **Downloaded** tab, tap the application you want to uninstall.
4. On the Application info screen, tap **Uninstall**.

Moving applications to or from the storage card

Move applications that you've downloaded to the phone to the storage card if your phone's memory is getting low. Or, if your storage card is getting full, you can also move applications that are on your storage card to the phone.



You can only move applications that are not preinstalled on your phone.

1. From the Home screen, press MENU, and then tap **Settings**.
2. Tap **Applications > Manage applications**.
3. On the **Downloaded** tab, tap the application you want to move.
4. On the Application info screen, tap **Move to SD card** or **Move to phone**.

Checking information about your phone

1. From the Home screen, press MENU, and then tap **Settings**.
2. Tap **About phone**.
3. Select one of the following:

System software updates	Enable or disable the automatic check feature for software updates for your phone. You can also tap Check now to manually check for software updates.
Tell HTC	Turn Tell HTC on or off. When enabled, you're helping us know if your phone encounters a technical problem. You can also choose when you want to send error reports.
Network	Check information about your mobile operator and its service status.
Phone identity	Check information about your phone and the SIM card you're using.
Battery	Check information about the battery such as its current battery level, status, and what programs are using the battery.
Hardware information	Check the Wi-Fi MAC and Bluetooth addresses.
Software information	Check the version and other information about the Android platform being used by the phone. You can also check the version of the web browser.
Legal information	Read legal information from HTC and Google, and licenses used by the phone.

Update and reset

Updating the phone software

From time to time, software updates for your phone may be available. Your phone can check and then notify you if there's a new update. You can then download and install the software update using your phone's Wi-Fi or data connection.



- Checking and downloading phone software updates may incur additional data transfer fees from your mobile operator.
- Make sure your phone has a microSD card inserted. The update will be downloaded to the microSD card.

Depending on the type of update, the update may erase all your personal data and customized settings, and also remove any applications you've installed. Make sure that you've backed up the information and files you want to keep.

- When there is an update available, the Install system software update dialog box will appear onscreen. Select **Install now** and then tap **OK**.
- If you're in the middle of a call and there's an update available, you'll receive an update notification. After you end the call, slide open the Notifications panel (see "Opening the Notifications panel" in the Getting started chapter). Then tap the update notification to download and install the software update.

Wait for the update process to finish. When the update is finished, the phone will automatically reset.

Checking for phone system software updates manually

1. From the Home screen, press MENU, and then tap **Settings**.
2. Tap **About phone > System software updates**.
3. On the System software updates screen, tap **Check now**.

Restarting or factory resetting your phone

Restarting your phone (soft reset)

If your phone is running slower than normal, an application is not performing properly, or your phone becomes unresponsive, try restarting your phone and see if that helps solve the problem.

1. If the display is off, press the POWER button to turn it back on.
2. Unlock your phone if the Lock screen is displayed. See “Unlocking the screen” in the Getting started chapter.
3. Press and hold the POWER button, and then tap **Restart**.
4. When asked to confirm, tap **Restart**.

If you can't restart the phone following the above steps, remove the battery, wait for a few seconds, reinsert the battery, and then turn the phone on.

Performing a factory reset (hard reset)

If you're passing your phone on to someone else or your phone has a persistent problem that cannot be solved, you can do a factory reset (also called a hard reset). This returns your phone to the state it was in before the first time you turned it on.



Factory reset will not erase the data and files that are on the storage card.

Factory reset is not a step to be taken lightly. It'll permanently delete all your data and customized settings, and will remove any applications you've downloaded and installed. Be sure to back up any data and files you want to keep before you do a factory reset.

Performing a factory reset via settings

1. From the Home screen, press MENU, and then tap **Settings**.
2. Tap **SD & phone storage > Factory data reset**.
3. On the Factory data reset screen, tap **Reset phone**, and then tap **Erase everything**.

Performing a factory reset using phone buttons

If you can't turn on your phone or access the phone settings, you can still perform a factory reset by using the buttons on the phone.

1. Remove the battery, wait for a few seconds, then reinsert the battery.
2. Press and hold the VOLUME DOWN button, and then briefly press the POWER button.
3. Wait for the screen with the three Android images to appear, and then release the VOLUME DOWN button.
4. Press VOLUME DOWN to select **FACTORY RESET**, and then press the POWER button.