

Your **HTC** Flyer

User guide



Contents

Getting started

Inside the box	5
HTC Flyer	5
Top cover	7
SIM card	8
Storage card	9
Battery	10
Switching the power on or off	10
Entering your PIN	11
Finger gestures	11
Setting up HTC Flyer for the first time	12
Ways of getting contacts into HTC Flyer	12
Home screen	13

Basics

Adjusting the volume	14
Sleep mode	14
Status and notifications	15
Notifications panel	18
Connecting HTC Flyer to a computer	19
Copying text, looking up information, and sharing	20
Printing	22

Personalizing

Making HTC Flyer truly yours	23
Personalizing HTC Flyer with scenes	23
Changing your wallpaper	24
Applying a new skin	25
Personalizing your Home screen with widgets	25
Adding icons and other shortcuts on your Home screen	27
Adding folders on your Home screen	27
Rearranging or removing widgets and icons on your Home screen	28
Using sound sets	28
Rearranging or hiding application tabs	30

Tablet pen and fun apps

About the tablet pen	32
Scribbling	34
About Notes	35
Writing a note	36
Sketching	37
Switching to Kid Mode	39

Snapbooth and Camera

Snapbooth	40
Camera	41

Photos, videos, and music

Gallery	45
Music	53

Accounts and sync

About online accounts	58
Synchronizing with a Google Account	58
Adding a social network account	59
Managing your online accounts	59

Social

Facebook for HTC Sense	61
Facebook app	62
What's the difference between Facebook app and Facebook for HTC Sense?	63
Twitter for HTC Sense	63
Using Friend Stream	64
Tweeting in Friend Stream	67
Chatting in Google Talk	68

Internet connections

Data connection	71
Wi-Fi	72
About connection widgets	74
Connecting to a virtual private network (VPN)	74
Using HTC Flyer as a modem (USB tethering)	75
Connecting HTC Flyer to the Internet through a computer (Internet Pass-through)	76
Using HTC Flyer as a wireless router	76

Bluetooth

Bluetooth basics	77
Connecting a Bluetooth headset or car kit	77
Disconnecting or unpairing from a Bluetooth device	78
Sending information using Bluetooth	79
Receiving information using Bluetooth	81

Trademarks and copyrights

Index

Conventions used in this guide

In this user guide, we use the following symbols to indicate useful and important information:



This is a note. A note often gives additional information, such as what happens when you choose to do or not to do a certain action. A note also provides information that may only be applicable to some situations.



This is a tip. A tip gives you an alternative way to do a particular step or procedure, or lets you know of an option that you may find helpful.



This indicates important information that you need in order to accomplish a certain task or to get a feature to work properly.



This provides safety precaution information, that is, information that you need to be careful about to prevent potential problems.

Getting started

Inside the box

You will find the following inside the box:

- HTC Flyer
- Tablet pen
- Tablet pen battery
- USB cable
- Power adapter
- 3.5mm stereo headset
- Protective case
- Quick guide
- Safety and regulatory guide
- Call center card (hotline card)
- Warranty card

HTC Flyer

Front panel

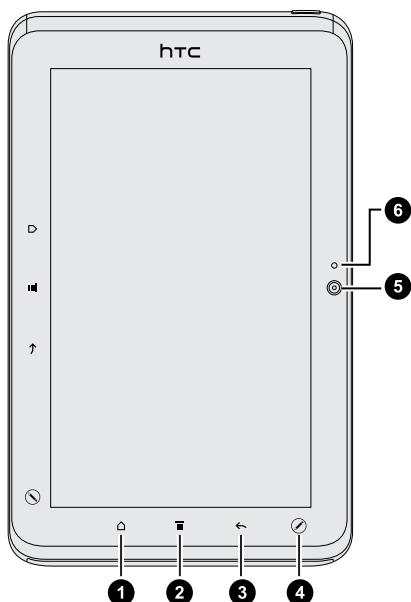

1. HOME
2. MENU
3. BACK
4. PEN OPTIONS
5. Front camera
6. Front camera on or off indicator

Right panel

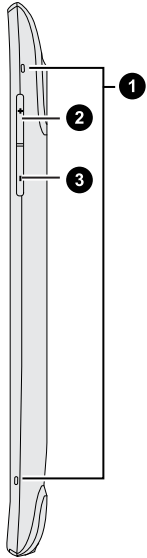

1. Microphones
2. VOLUME UP
3. VOLUME DOWN

Back panel

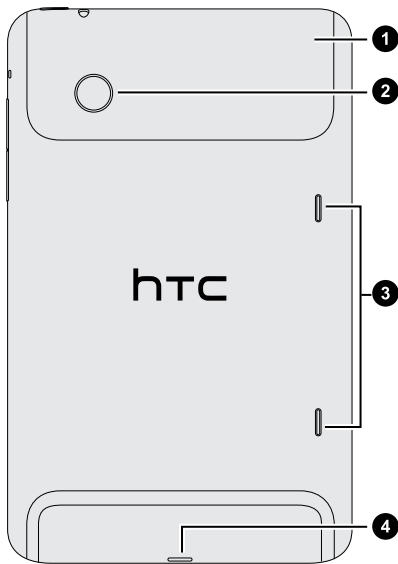

1. Top cover
2. 5 megapixel camera
3. Speakers
4. USB connector

Top panel

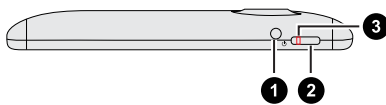

1. 3.5mm headset jack
2. POWER
3. Notification LED

Top cover

Removing the top cover

Remove the top cover to access the SIM card and storage card slots.

1. Turn off HTC Flyer and hold it securely with the front facing down.
2. With your right and left thumbs, push the top cover out to remove it.

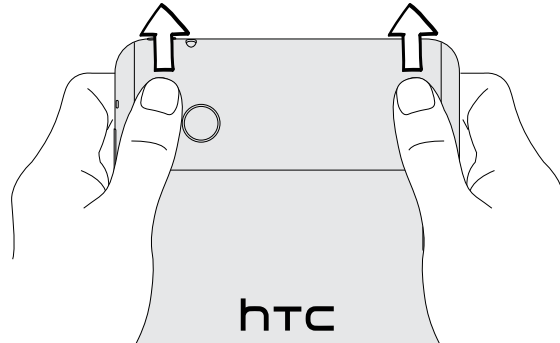

Replacing the top cover

1. Align the two teeth underneath the top cover (one on each side) with the two notches on the top of HTC Flyer.

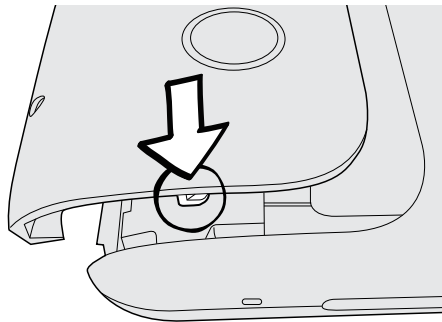

2. Place the top cover on HTC Flyer, gently press down on the cover with your thumbs, and then push it in until it clicks and locks into place.

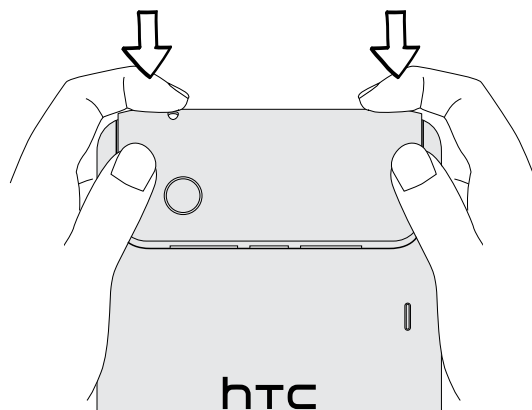

SIM card

You'll need a SIM card inserted in HTC Flyer to use a data connection. Both 1.8V and 3V SIM cards can be used.



Some legacy SIM cards may not function with HTC Flyer. You should consult with your mobile operator for a replacement SIM card. There may be fees for this service.

Inserting the SIM card

1. Turn off HTC Flyer and hold it securely with the front facing down.
2. Take the top cover off
3. With the SIM card's gold contacts facing down and its cut-off corner facing out, insert the SIM card into the SIM card slot.

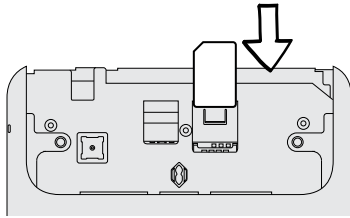

Removing the SIM card



Make sure to switch off HTC Flyer before removing your SIM card.

1. Take the top cover off
2. With your finger, press down the small tab located near the opening of the SIM card slot.

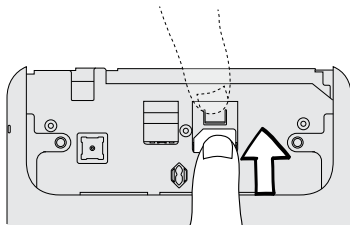

3. Slide the SIM card out from the SIM card slot.

Storage card

HTC Flyer comes with an internal storage that you can use to store your photos, videos, and music. If you need more storage space, you can insert a storage card into HTC Flyer.

Inserting the storage card

1. Take the top cover off
2. Insert the storage card into the storage card slot with its gold contacts facing down and push it until it clicks into place.

Removing the storage card



If HTC Flyer is on you must first "unmount" the storage card before removing it to prevent corrupting or damaging the files in the storage card.

1. Take the top cover off
2. Push the storage card in to eject it from its slot.
3. Slide the storage card out from its slot.

Unmounting the storage card

When you need to remove the storage card while HTC Flyer is on, unmount the storage card first to prevent corrupting or damaging the files in the storage card.

1. From the Home screen, press , and then tap **Settings**.
2. Tap **SD & phone storage > Unmount SD card**.

Battery

HTC Flyer uses a rechargeable battery. How long the battery can last before it needs recharging depends on how you use HTC Flyer. Among these are the features and accessories you use (for example, leaving your Bluetooth™ connection always on uses more power). Frequent web browsing uses up a lot of battery power. Also, consider your location: poor signal strength from your mobile network and extreme temperature make the battery work harder.

Charging the battery

The battery is partially charged when shipped. Before you turn on and start using HTC Flyer, it is recommended that you charge the battery. Some batteries perform best after several full charge/discharge cycles.



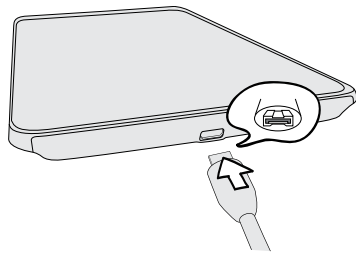

Only the power adapter provided in the box must be used to charge the battery.

1. Plug the power adapter into the USB connector of HTC Flyer.



2. Plug in the power adapter to an electrical outlet to start charging the battery.

As the battery is being charged, the notification LED shows a solid orange light. The light turns to solid green when HTC Flyer is fully charged.

When you charge the battery while HTC Flyer is on, the charging battery icon  is displayed in your tablet's status bar. After the battery has been fully charged, the charging battery icon turns to a full battery icon .



As a safety precaution, the battery stops charging when it overheats.

Switching the power on or off

Switching the power on

Press the POWER button. Easy.



When you turn on HTC Flyer for the first time, you'll need to set it up.

Switching the power off

1. If the display is off, press the POWER button to turn it back on, then unlock the screen.
2. Press and hold the POWER button for a few seconds.
3. When the Power options menu appears, tap **Power off**.

Entering your PIN

Most SIM cards come with a PIN (personal identification number) set by your mobile operator. If you're asked for a PIN, enter it and then tap **OK**.



If you enter the wrong PIN three times, your SIM card is blocked. No problem. Just contact your mobile operator and ask for the PUK (PIN Unblocking Key).

Finger gestures

Tap	When you want to type using the keyboard, select items onscreen such as application and settings icons, or press onscreen buttons, simply tap them with your finger.
Press and hold	To open the available options for an item (for example, a contact or link in a web page), simply press and hold the item.
Swipe or slide	To swipe or slide means to quickly drag your finger vertically or horizontally across the screen.
Drag	Press and hold your finger with some pressure before you start to drag. While dragging, do not release your finger until you have reached the target position.
Flick	Flicking the screen is similar to swiping, except that you need to swipe your finger in light, quicker strokes. This finger gesture is always in a vertical direction, such as when flicking the contacts or message list.
Rotate	For most screens, you can automatically change the screen orientation from portrait to landscape by turning HTC Flyer sideways. When entering text, you can turn HTC Flyer sideways to bring up a bigger keyboard.
Pinch	In some apps, like Gallery or the web browser, you can “pinch” the screen using two fingers (for example, thumb and index finger) to zoom in or zoom out when viewing a picture or a web page.

Setting up HTC Flyer for the first time

When you switch on HTC Flyer for the first time, you'll be asked to set it up. You can choose your language, how you want to connect to the Internet, and whether you want your current location to be automatically detected. If you still have personal contacts and calendar events stored on your old phone, you can easily transfer them to HTC Flyer through Bluetooth as well.

Be sure to sign in to your Google Account so you can use Google apps like Gmail™ and Android Market™. You can also set up your other email accounts, favorite social networks like Facebook and Twitter™, and more.

Just follow the onscreen instructions and you'll be up and running in no time.



Some features that need to connect to the Internet such as location-based services and auto-sync of your online accounts may incur extra data fees from your mobile operator. Don't worry. You can enable or disable them in settings later on.

Ways of getting contacts into HTC Flyer

There are several ways you can add contacts to HTC Flyer. You can sync HTC Flyer with contacts from your Google Account, computer, Facebook, and more.

HTC Sync	Sync the contacts from your old phone to your computer, and then use HTC Sync to sync HTC Flyer with your computer's Microsoft Outlook, Outlook Express or Windows Contacts.
Gmail	Google contacts are imported to HTC Flyer after you sign in to your Google Account. You can also create more Google contacts right from HTC Flyer.
Facebook	Log in to your Facebook account through Facebook for HTC Sense to import your Facebook friends' contact information.
Phone contacts	You can choose to create and store contacts directly in HTC Flyer or transfer existing ones from your old phone.
SIM card	Copy all your SIM contacts to HTC Flyer.
Microsoft Exchange ActiveSync	HTC Flyer syncs your work contacts from the Microsoft Exchange ActiveSync Server in your workplace.
Transfer	Use the Transfer app to transfer not only your contacts, but also calendar events and text messages from your old phone to HTC Flyer.

Home screen

Your Home screen is where you make HTC Flyer your own. It comes with a weather clock widget that shows the time and weather in your current location. You can also add your favorite applications, shortcuts, folders and widgets so they're always just a tap away. To find out how, see [Personalizing](#) on page 23.

Using Leap view

To jump straight to the screen that you want, press  or pinch the screen to show the Leap view. It reveals all eight Home screens as thumbnails.



Just tap the one you want and you'll leap right there.

Basics

Adjusting the volume

Change the volume levels for alarms, notifications, and when you're playing back music or video on HTC Flyer.

Adjusting the media volume

Press the VOLUME UP or VOLUME DOWN button to adjust the volume. The Media volume window appears on the screen to display the volume level.

Adjusting the volume via settings

1. From the Home screen, press , and then tap **Settings > Sound > Volume**.
2. Drag the volume sliders to the left or right to adjust the volume levels of media playback, alarms, and notifications. A sample tone is briefly played with the volume being adjusted as you drag a slider.
3. When you're done, tap **OK**.

Sleep mode

Sleep mode saves battery power by putting HTC Flyer into a low power state while the display is off. It also stops accidental button presses when HTC Flyer is in your bag. You'll still receive messages though.

Switching to Sleep mode

Briefly press the POWER button to turn off the display and switch to Sleep mode. HTC Flyer also automatically goes into Sleep mode when it's idle for a while.

Waking up from Sleep mode

To wake HTC Flyer up manually, press the POWER button. You'll need to unlock the screen.



HTC Flyer automatically wakes up when you have an event reminder or set an alarm.

Unlocking the screen

Do one of the following:

- Drag up the ring (until the whole ring is shown onscreen), and then release your finger to unlock the screen.



If you have set up a screen unlock pattern, pin, or password, you will be asked to draw the pattern on the screen or enter the PIN or password before it unlocks.

- On the lock screen, you'll see icons for different apps. Drag one of the icons to the ring to open the app.
- If you've set an event reminder or an alarm, you can drag or to the ring to snooze or dismiss the event or alarm.

Status and notifications

Status icons



Here's what each icon means:

	Signal strength		Battery is full
	Roaming		Battery is charging
	No signal		Battery is low (20% remaining)







 GPRS connected	 Battery is very low (10% remaining)
 GPRS in use	 Silent mode
 EDGE connected	 Vibrate mode
 EDGE in use	 Wired microphone headset connected
 3G connected	 Wired headset connected
 3G in use	 Bluetooth is on
 HSDPA connected	 Connected to a Bluetooth device
 HSDPA in use	 Airplane mode
 No SIM card installed	 GPS is on
 Connected to a Wi-Fi network	 Alarm is set
 Data synchronizing	





















Notification icons

Notification icons on the status bar make it easy for you to keep on top of your messages, calendar events, and alarms.



Here's what each one means:

 New Gmail message	 Compass needs orientation
 New Microsoft Exchange ActiveSync or POP3/IMAP email	 More (not displayed) notifications
 Problem with email delivery	 General notification

 New SMS/MMS	 HTC Flyer is connected to a computer via USB cable
 Problem with SMS/MMS delivery	 Wi-Fi is on and wireless networks are available
 New Google Talk instant message	 Portable Wi-Fi Hotspot is on
 New voicemail	 Uploading data (animated)
 Upcoming event	 Downloading data (animated)
 New updates from your social networks	 Waiting to upload
 Matched contacts suggestion	 Downloaded Android Market app installed successfully
 Bluetooth pairing request	 Update available for an app downloaded from Android Market
 HTC Flyer software update available	 Storage card is safe to remove or storage card is being prepared
 Song is playing	 Storage card or internal storage is low on free space

Notification LED

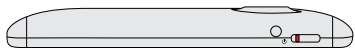

The notification LED shows a:

- Solid green light when HTC Flyer is connected to the power adapter or a computer and the battery is fully charged.
- Flashing green light when you have a pending notification.
- Solid orange light when the battery is being charged.
- Flashing red light when the battery level reaches very low.

Notifications panel

When you get a new notification, you can open the Notifications panel to see the message, reminder or event notification. The Notifications panel lets you quickly switch between recently-opened apps, and also lets you easily turn on settings such as Wi-Fi and Bluetooth.

To open the Notifications panel, press and hold the status bar, then slide your finger downward.

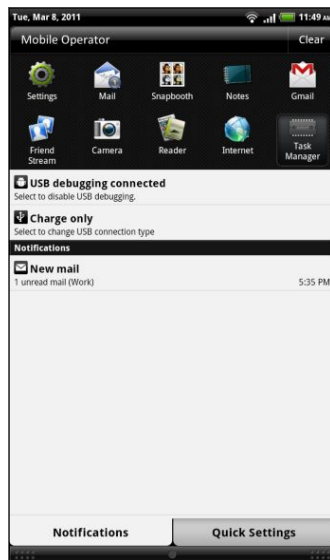

If you have several notifications, you can scroll down the screen to see them all.



You can also open the Notifications panel on the Home screen by pressing and then tapping Notifications.

Switching between recently opened apps

On the Notifications panel, you can easily access up to ten apps you just recently opened.

1. Press and hold the status bar, then slide your finger downward to open the Notifications panel.
2. In the Recent apps section, tap an app to open it.



Press and hold to view recently used apps.

Using Quick Settings

The Quick Settings tab lets you easily turn on Wi-Fi, Bluetooth, GPS, and more, and also provides a quick shortcut to all HTC Flyer settings.

1. Press and hold the status bar, then slide your finger downward to open the Notifications panel.
2. Tap the Quick Settings tab.
3. Tap the check box next to an item to turn it off or on.

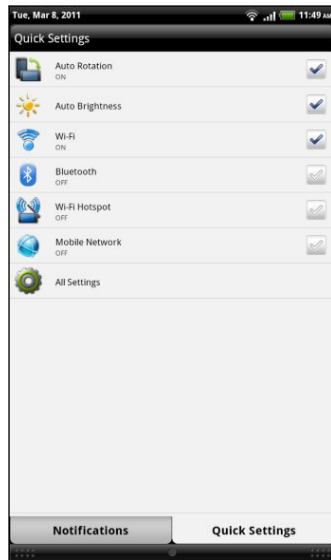

Closing the Notifications panel

Press and hold the bottom bar of the Notifications panel, then slide your finger up the screen. Or just press .

Connecting HTC Flyer to a computer

Whenever you connect HTC Flyer to a computer using the USB cable, the Connect to PC screen opens and lets you choose the type of USB connection.

Select one of the following choices, and then tap **Done**:

Charge only	Select this option if you only want to charge the battery while HTC Flyer is connected to your computer.
HTC Sync	Select this option to synchronize contacts, calendar, and other information between your computer and HTC Flyer.

Disk drive	Select this mode when you want to copy files between the internal storage of HTC Flyer or storage card (if one is inserted) and your computer. When Disk drive mode is enabled while HTC Flyer is connected to the computer, you will not be able to use apps on HTC Flyer to access the internal storage or storage card (if one is inserted).
USB tethering	When you do not have Internet connection on your computer, you can select this mode to share the mobile data connection of HTC Flyer with your computer.
Internet pass-through	If you don't have a data plan or you don't have access to a Wi-Fi network, you can select this mode to share your computer's Internet connection with HTC Flyer.

Copying text, looking up information, and sharing

In applications such as the web browser and Mail, you can select text and choose what you want to do with it.

After selecting text, you can:

- Copy it.
- Search for it using Google Search.
- Look it up on Wikipedia®, YouTube™, or Google Dictionary™.
- Get a translation of the text from Google Translate™.
- Share the text in a new email, text, or multimedia message or in your status update on a social network.

Selecting text

1. Press and hold on a word.
2. Drag the start and end markers to highlight the surrounding text you want to select.









To select text in a link, press and hold the link, and then tap Copy link URL.

Copying and pasting text

1. After you have selected the text you want to copy, tap **Copy**.
The selected text is then copied to the clipboard.
2. In a text entry field (for example while composing a message), press and hold at the point where you want to paste the text.
3. Tap **Paste**.

Searching or translating text

1. After you have selected the text you want to search for or translate, tap .
2. Tap one of the following tabs:

	Google Search Look for related information using Google Search, based on the text that you selected.
	Wikipedia Look for related information on Wikipedia, based on the text that you selected.
	YouTube Look for videos on YouTube, based on the text that you selected.
	Google Translate Translate the text to another language.
	Google Dictionary Look up the selected text in the dictionary.

Pasting text in a new message or social network status update

1. After you have selected the text you want to share, tap .
2. Choose whether to paste the selected text in a new text, multimedia, or email message or in your status update on a social network such as Twitter.

Printing

Connect HTC Flyer to a supported printer and print out documents, email messages, photos, and more.



- Both printer and HTC Flyer must be turned on and connected to the same local network. Connect HTC Flyer to the local network using Wi-Fi. To learn how to connect the printer to a local network, refer to your printer user guide.
- The local network must not be behind a firewall.

1. Open an app such as Mail or Gallery, and then select the file you want to print.
2. Press , and then tap **Print**. In some apps, after pressing , you may need to tap **More** to see **Print**.
3. In the Print screen, tap the printer you want to use.
4. Select the files you want to print at the top of the screen or set the page range you want to print, and then tap **Print**.



Before tapping **Print**, tap **Advanced** to set the page size, print layout, and page orientation, and choose if you want to print in color or black and white.

You can check the printing details by opening the Notifications panel, and then tapping the item you're printing.

Personalizing

Making HTC Flyer truly yours

Make HTC Flyer look and sound just the way you want it. Personalize it with a different wallpaper, skin, and notification sound for events such as incoming text, email, and calendar reminders.

Tap the Personalize button  right on the Home screen to get started.

Personalizing HTC Flyer with scenes

Use scenes to create different Home screen arrangements that reflect different aspects of your life. Customize different Home screens for your work, play or travel, and easily switch between them.



Everytime you add or modify something on the Home screen, HTC Flyer automatically saves your changes to the current scene.

Using a preset scene

HTC Flyer features preset scenes, each preconfigured with a different wallpaper and collection of widgets that reflect different moments in your life. You can choose a scene that is suitable for work, play, travel, or your social life.



1. From the Home screen, tap  > **Scene**.
2. Slide your finger on the screen from right to left to select the scene you want.
3. Tap **Apply**.



To download more scenes, tap  > **Scene** > **Get more**.

Creating a new scene



You'll start with an empty Home screen when you create a new scene.

1. From the Home screen, tap  > **Scene**.
2. Press , and then tap **New**.
3. Enter a new scene name, then tap **Done**.
4. Personalize the scene by adding widgets and other elements, arranging the Home screen layout, and changing the skin or wallpaper. All of your changes will be automatically saved to this scene.

Renaming a scene

1. From the Home screen, tap  > **Scene**.
2. Slide your finger on the screen from right to left to select the scene you want to rename.
3. Press and hold a scene thumbnail, then tap **Rename**.
4. Enter a new scene name, then tap **Done**.

Deleting scenes

1. From the Home screen, tap  > **Scene**.
2. Press , and then tap **Delete**.
3. Slide your finger on the screen from right to left to browse through scenes, then tap one or more scenes you want to delete.
4. Tap **Delete**.

Changing your wallpaper

Personalizing your wallpaper with your favorite photo is a quick and easy way to give HTC Flyer a fresh look. Browse the collection of wallpapers included in HTC Flyer or choose from photos that you have taken with the camera. You can also change your Home screen to use an animated wallpaper.

1. From the Home screen, tap  > **Wallpaper**.
2. Tap one of the following:

HTC wallpapers	Choose a preset wallpaper, then tap Preview > Apply .
Live wallpapers	Choose from preset animated wallpapers. Tap Preview to view the animation, and then tap Apply .
Gallery	Choose a photo that you have taken using the camera or copied to your storage card. Crop the photo and then tap Save .



To download more wallpapers, tap  > **Wallpaper** > **HTC wallpapers** > **Get more**.

Applying a new skin

Personalize beyond the Home screen by applying a new skin. Skins are set to give a different look and feel to most onscreen buttons, application screens, option menus, and other items.

1. From the Home screen, tap  > **Skin**.
2. Slide your finger on the screen from right to left to select the skin you want.
3. Tap **Apply**.



To download more skins, tap  > **Skin** > **Get more**.

Personalizing your Home screen with widgets

Widgets put at-a-glance important information and media content up front on your Home screen. Some widgets are already added to your Home screen for your convenience. You can add more from the available selections of widgets.

Adding a widget to your Home screen

1. Go to a part of the Home screen where there's space to add a new widget.
2. Tap  > **Widget**.
3. Select a widget that you want.
4. Most HTC widgets are available in a variety of designs and sizes to suit your needs. Slide your finger on the screen from right to left to view the different styles, and then tap **Select** to choose one.

You can also add widgets that allow you to quickly switch on or off certain settings such as Wi-Fi, Mobile Network, and Bluetooth. Scroll down the widgets list, tap **Settings**, and then tap the widget that you want.



To download more widgets, tap  > **Widget** > **Get more HTC widgets**.

Changing the settings of a widget

You can modify basic settings of some widgets (for example, the People and Mail widgets) from the Home screen.

1. Press and hold a widget on the Home screen. HTC Flyer vibrates and you'll see a colored box around the widget. Don't lift your finger just yet.
2. Drag the widget to the edit button  (if it's enabled).



The relevant screen where you can change some settings for this widget then opens.

3. Customize the widget settings.

Adding icons and other shortcuts on your Home screen



Place app icons on your Home screen to open apps quicker. You can also add shortcuts to settings and specific information such as a bookmarked webpage, someone's phone number, a music playlist, route directions, and many other items, to your Home screen.



The shortcuts available depend on the apps that are installed on HTC Flyer.

1. Go to a part of the Home screen where there's space to add a new icon or shortcut.
2. Tap  and then tap **App** to add an app icon, or **Shortcut** to add a shortcut to a setting or information.



To add an app icon on the Home screen, you can also press , tap , and then press and hold an app icon. Without lifting your finger, drag the icon to an empty area on the Home screen, and then release it.

Adding folders on your Home screen

Use folders to group related apps and other shortcuts to keep your Home screen tidy and organized. You can also add information folders that show up-to-date information such as Bluetooth received files, your Facebook phonebook, and more.

Creating a new folder and adding items to it

1. Go to a part of the Home screen where there's space to add a new folder.
2. Tap  > **Folder**.
3. Tap **New Folder**.
4. Press and hold an app icon or a shortcut that you want to move to the folder. HTC Flyer then vibrates. Don't lift your finger just yet.
5. Drag the app icon or shortcut and drop it on top of the folder.

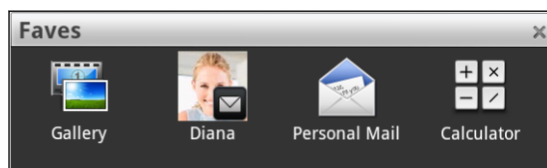

Simply tap the folder to open it so you can access the apps and shortcuts inside the folder.

Renaming a folder

1. Tap the folder to open it.
2. Press and hold the folder window's title bar.
3. Enter a new folder name and then tap **OK**.

Rearranging or removing widgets and icons on your Home screen

Rearrange the widgets and icons on your Home screen to make room for adding more items. You can also remove widgets and icons that you don't frequently use.

Moving a widget or icon

1. Press and hold the widget or icon you want to move. HTC Flyer vibrates and you'll see a colored box around the widget or icon. Don't lift your finger just yet.
2. Drag the widget or icon to a new location on the screen. You can pause at the left or right edge of the screen to drag the widget or icon onto another Home screen panel.
3. When the widget or icon is where you want it, lift your finger.



Removing a widget or icon

1. Press and hold the widget or icon you want to remove. HTC Flyer vibrates and you'll see a colored box around the widget or icon. Don't lift your finger just yet.
2. Drag the widget or icon to the remove button .
3. When the widget or icon also turns red, lift your finger.

Using sound sets

Personalize HTC Flyer to use different sound notifications. By switching between sound sets, you can instantly make HTC Flyer alert you with fun sounds when you're out with friends or change to subtle sounds while you're at work. Each sound set gives you a different combination of sounds for incoming messages, email, calendar event reminders, alarms, and other notifications.

Choosing a preset sound set

1. From the Home screen, tap  > **Sound set**.
2. On the Sound sets screen, tap a sound set name.
3. You can tap  to listen to the different sounds for that sound set.
4. Tap **Apply**.



To download more sound sets, tap  > **Sound set** > **Get more**.

Creating a sound set

1. From the Home screen, tap  > **Sound set**.
2. On the Sound sets screen, tap **New sound set**.
3. Enter a new sound set name, and then tap **Done**.

The newly created sound set is then added to the list of sound sets. You can assign different tones to the sound set to your preference.

Customizing a sound set

Customize a sound set by choosing different sounds for alarms, notifications, new messages, email, and calendar reminders from the preset selection or your storage card (except for notification sounds).

1. From the Home screen, tap  > **Sound set**.
2. Choose a sound set you want to customize or create a new one, and then tap **Apply**.
3. Change the notification sound and alarm from the Personalize screen. Go to the Messages, Mail and Calendar apps to choose sounds for new messages, email, and calendar reminders respectively.

HTC Flyer automatically saves your choices to the current sound set.

Changing notification sounds

1. From the Home screen, tap  > **Notification sound**.
2. Choose the type of notification that you want to change.
3. Tap the sound you want to use. A sample tone briefly plays when selected.
4. Tap **Apply**.





Although you can't import notification sounds from your storage card, you can tap **Get more** to download more audio files from HTC Hub.

Changing the alarm sound

1. From the Home screen, tap  > **Alarm**.
2. Tap the sound you want to use. A sample tone briefly plays when selected.
3. If the audio file is on your storage card, tap **New alarm**, select the item you want to import to the Alarms list, then tap **OK**.
4. Tap **Apply**.

Deleting sound sets

1. From the Home screen, tap  > **Sound set**.
2. Press , and then tap **Delete**.

3. Tap one or more sound sets you want to delete.
4. Tap **Delete**.

Rearranging or hiding application tabs

You can rearrange the tabs at the bottom of some apps to prioritize the types of information you frequently use or remove the tabs you don't really need.

1. Open an app that has the usual tabs at the bottom of its screen (for example, the library screen in Music).

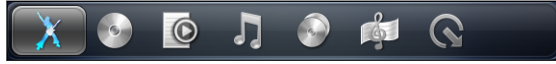

2. Press and hold a tab. When the screen changes and shows you an empty area, lift your finger.
3. Do any of the following:

Move a tab	Press and hold the tab you want to move, and then drag it to its new position.
Remove a tab	Press and hold a tab you want to hide, then drag it up. When you see a colored box, lift your finger.

4. When you're done, press .

Adding a tab back

1. Open the app from which you previously removed some tabs.
2. Press and hold a tab. When the screen changes and shows you some of your hidden tabs, lift your finger.

3. Press and hold the tab you want to show, then drag it down to where you want to position it again.

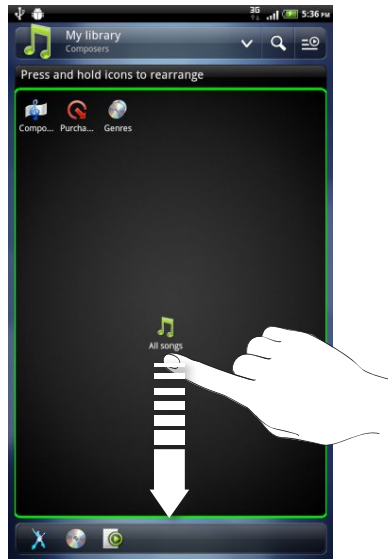

4. When you're done, press .

Tablet pen and fun apps

About the tablet pen

Whether for work or play, we've made something so common yet useful as a pen seamlessly fit your mobile experience. On HTC Flyer, use the tablet pen to take notes, draw pictures, sign contracts, and more.

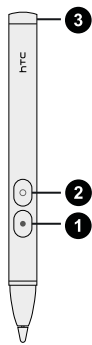

1 Highlighter button	Lets you highlight text in pen-integrated apps. For example, highlight your favorite quotes when in Reader.
2 Eraser button	Lets you erase your pen strokes on the current screen.
3 Battery cap	Open the cap when you want to replace the battery of your tablet pen.

Inserting a battery into the tablet pen

Before you start using the tablet pen, you need to first install the disposable AAAA battery that's included in the box. After a period of time, change the tablet pen's battery when you feel that HTC Flyer is not responding too well to your pen strokes.

1. Twist the battery cap counter-clockwise until it detaches from the tablet pen, then remove it completely.

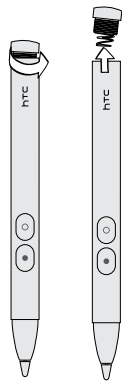

2. With the positive pole first, insert a new battery into the tablet pen.
3. Put the battery cap back into the tablet pen, and then twist it clockwise until it locks in place.

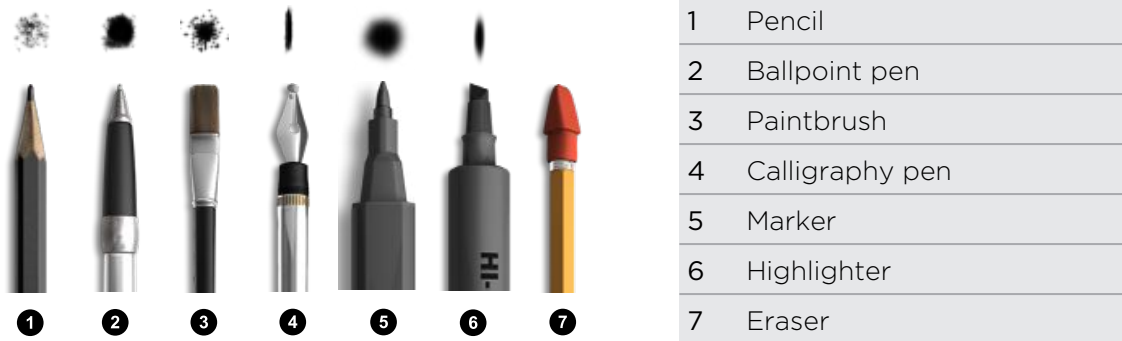

What your tablet pen can do

Use the tablet pen to tap the  button on HTC Flyer and open the Pen options palette. This lets you choose from a variety of pen types, strokes, and colors. Here are some of the pens and strokes you can use:



How you typically use your regular pen on a piece of paper is also the way you can use the tablet pen on HTC Flyer. In other words, your tablet pen is for:

- **Writing and drawing.**

If  is lighted green, it means that you're in an app where you can freely write and draw. If  is lighted red, then you're in an area where you can't write or draw unless you switch to Scribble mode.

- **Highlighting text.**

When you're reading something interesting in pen-integrated apps, use the tablet pen as a highlighter and mark your favorite words and phrases.

- **Erasing.**

Make quick edits to your notes or sketches.



You still need to use your finger to slide to another screen, scroll through a web page, or select onscreen items in the Home screen and other apps.

Scribbling

Use the tablet pen to capture app screens as images where you can freely scribble, draw, or mark items. For example, you can switch to Scribble mode while you're reading a web page on HTC Flyer, write down what you think on the same page, and then print or email it to your friends.

1. While you're in an app that supports Scribble mode, just tap any part of the screen with the tablet pen.



Scribble mode is not supported when you're:

- Using an app that lets you freely draw with the tablet pen.
- Playing a video or slideshow in Gallery.
- Reading, playing, or viewing copyrighted materials.
- Framing subjects in the Viewfinder screen of Camera or Camcorder.
- Entering text using the onscreen keyboard.

2. Press when you no longer want to be in Scribble mode. This discards all your scribbles on the current screen.

If you don't want to enter Scribble mode every time you tap the tablet pen on HTC Flyer, press from the Home screen, and then tap **Settings > Pen**. Clear the **Auto launch Scribble mode** check box.

After scribbling

Tap with your finger to select the next action you want for your scribbles.

When you're done scribbling on an app screen, press to show the following options:

Save	Tap to save the clipped screen and your scribbles as an image. When you select this option, your scribbled image is automatically inserted into a page in Notes. You can also view your scribbles in Gallery.
Share via	Tap to send the image to your computer or another device using Bluetooth, send it by email, or select a social network where you want to upload it to.
Print	If you're connected to a printer over Wi-Fi, tap to send the image for printing.
Discard	Tap to delete the image and exit Scribble mode.



You can also tap the screen with your finger to show or hide the Scribble mode options.

About Notes

Seen something inspiring lately? Jot it down in Notes and make it easy to remember your ideas, questions, and everything else. You can write, record audio, attach photos and documents, and even clip your favorite web pages. If you're taking notes during a meeting, you can conveniently link them to the meeting event saved in Calendar.



Create and sign in to your Evernote account from HTC Flyer if you want to back up your notes to Evernote's secure online server. For details, visit www.evernote.com/about/learn_more.

Creating a notebook

1. From the Home screen, tap  > **Notes**.

The first time you open the app, you can take a quick tour and set up your Evernote® account. If you choose to skip this, you can later on log in to Evernote in the Accounts & sync settings.

2. On the All notes screen, tap  > **New notebook**.
3. Type in a notebook title.
4. Select a notebook type.
 - Tap **Local notebook** to save this notebook only on HTC Flyer.
 - Tap **Synchronized notebook** to sync your notes with your Evernote account.
5. Tap **Create**.



To open or switch to another notebook, simply tap , then tap a notebook name.

Syncing notes

You can choose whether to automatically or manually sync your notes between HTC Flyer and your Evernote account on the Web.



You need to log in to your Evernote account from HTC Flyer to start syncing notes.



1. From the Home screen, tap  > **Notes**.
2. To manually sync notes, press , and then tap **Sync**.
3. To set Notes to automatically update, press  on the All notes screen, and then tap **More > Settings > Accounts and sync**.
4. Customize your sync settings.

Writing a note

1. From the Home screen, tap  > **Notes**.





If you open the Notes app while you have an ongoing meeting (saved in Calendar), you can associate a note directly with this event.

2. Open a notebook, and then tap .
3. Do any of the following:
 - Tap **Enter title** with your finger, and then type in a note title.
 - Tap on the note to move the text cursor to a page line, then start typing in your text.
4. Use your tablet pen to write, draw over text, highlight, doodle, and more.
5. When done, press , and then tap **Save**.

Adding a photo or attachment to your note

While you have a note open, do any of the following:

Insert a photo

- Move the text cursor to where you want to insert the photo, and then tap  > **Picture** to insert a photo from HTC Flyer.
- Tap  to take a picture.

Attach a document

Tap  > **Document**, and then browse for the document to attach.

Clipping an app screen or a web page

On HTC Flyer, you can clip app screens and web pages as images, and then insert them to your notes.

1. Open the app or web page you want to clip.
2. With the tablet pen, tap any part of the screen to enter Scribble mode.
3. Tap **Save** to add the clipped image into a new note.





If you want to clip web pages without converting them to images, you can sign in and use Evernote on your computer, and then sync your clipped notes with the Notes app. You need to install the Evernote Web Clipper on your computer before you can clip content from the Web. For details, see www.evernote.com.

Taking notes during meetings or discussions

The Notes app lets you capture thoughts, action plans, and meeting minutes better than just writing them down.

While you have a note open, you can:

Create a new note	Tap  .
Record voice clips	Tap  to start and stop audio recording. (You also need to stop recording first when you want to create a new note page.)
Link the note to an event	Tap  , and then select the event to link to in Calendar.



Saving a note

Although the Notes app automatically saves your work when you press , you can still manually save your notes to make sure nothing is lost.

While you have your note open, press , and then tap **Save**.



Sketching

Unleash the artist in you and create your own sketch portfolio. While you're at it, you can also record your tablet pen strokes and add your voice-over.

1. From the Home screen, tap  > **Sketchbook**.
2. On the All sketches screen, tap .
3. Tap **Enter title**, and then type in a title for your sketch. Press  to close the onscreen keyboard.
4. Tap the blank sketch pad with your finger when you're ready to start.
5. Use your tablet pen to sketch a character, design, or doodle.



Your pen strokes and audio will automatically be recorded. If you don't want to record a voice-over, tap .

6. To stop recording, tap the sketch pad with your finger to show the onscreen controls, and then . You can tap  again to resume recording.
7. When you're done sketching, press  to save and close your sketch.

Playing back a recorded sketch demo

1. From the Home screen, tap  > **Sketchbook**.
2. On the All sketches screen, tap a sketch thumbnail to open it.

3. Tap .

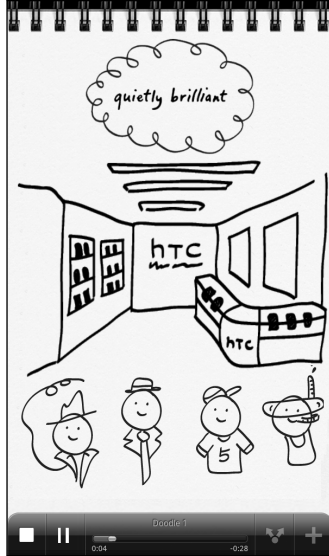



If you don't see the play button, tap the sketch pad with your finger to show the onscreen controls.

4. To pause or stop your sketch demo, tap  or .

Sharing your sketches

You can send image files of your sketches by email or Bluetooth, or share them with friends in your social networks.

1. From the Home screen, tap  > Sketchbook.
2. Do one of the following:

Share multiple sketches On the All sketches screen, tap , then choose how you want to share your sketches. Select one or more items, and then tap **Next**.

Share a sketch On the All sketches screen, tap a sketch thumbnail to open it. Tap  in the onscreen control bar, and then choose how you want to share your sketch.



You can also print your sketches when HTC Flyer is connected to a printer over Wi-Fi. While viewing a sketch, press , and then tap **Print**.

Switching to Kid Mode

Afraid that your kids might wander off to inappropriate web sites or your important work files while using HTC Flyer? Don't worry. Open Kid Mode and let your children enjoy fun games, art, and books that are right for their age.



To learn more about Kid Mode, visit www.zoodles.com.

To use this app, you need to:

- Connect to the Internet (using a data or Wi-Fi connection)
- Create or sign in to your Zoodles™ account

From the Home screen, tap  > **Kid Mode**.

Setting your Zoodles Kid Mode options

1. From the Home screen, tap  > **Kid Mode**.
2. On the Zoodles main screen, press , and then tap **Settings**.



To return to the Zoodles main screen, tap  on the upper left corner of the app.

3. With your finger, confirm the action by drawing the letter Z on the screen.
4. Under Device options, do any of the following:

Lock Home Button	Select this option to disable  while in Kid Mode.
Data Over 3G/4G	Select if it's OK to use data connection for playing games and doing other activities from Zoodles. Clear this option if you only want to use a Wi-Fi connection for this app.
High-quality Video	Tap to choose whether to play high-quality videos always or just when you're connected to Wi-Fi. Selecting Always may incur additional fees from your mobile operator.
Startup Volume	Set the volume level for the app's startup sound.
Maximum Volume	Set the maximum volume limit to use for this app.

5. Press  to return to the Zoodles main screen.

Closing Kid Mode

Press  twice, and then confirm your action by drawing the letter Z with your finger.

Snapbooth and Camera

Snapbooth

Using Snapbooth

Have fun taking closeup shots of yourself or with your loved ones using Snapbooth. Choose from virtual lenses or add effects to make moments memorable. You can also choose to take a composite photo with four different shots.

Taking your closeup shot

1. From the Home screen, tap  > Snapbooth.
2. Choose how you want to take your photo.



In **One shot** mode, the front camera takes a single shot.



In **Four shots** mode, the front camera takes four shots and combines them into a single photo.

3. Choose an effect to apply to your photo.
4. Hold HTC Flyer in portrait or landscape position with both hands, and then adjust or move it to center yourself inside the Viewfinder window.
5. When you're ready to take your photo, look at the front camera lens, and then tap .



Snapbooth counts down before taking the shot. To cancel the shot, tap .

After taking your photo, you can choose to share it or just delete it if you want to take another shot.

Your photo is then displayed as a thumbnail on the screen. Tap the thumbnail to view it in full screen or edit it.



You can use Gallery to view the photos you've taken. Go to the **Snapbooth** album in Gallery to view them.

Viewing or editing a photo in full screen

- While viewing a photo in full screen, swipe your finger left or right across the screen to go through the other photos you've taken.
- Tap anywhere on the screen and then choose what to do with the current photo.

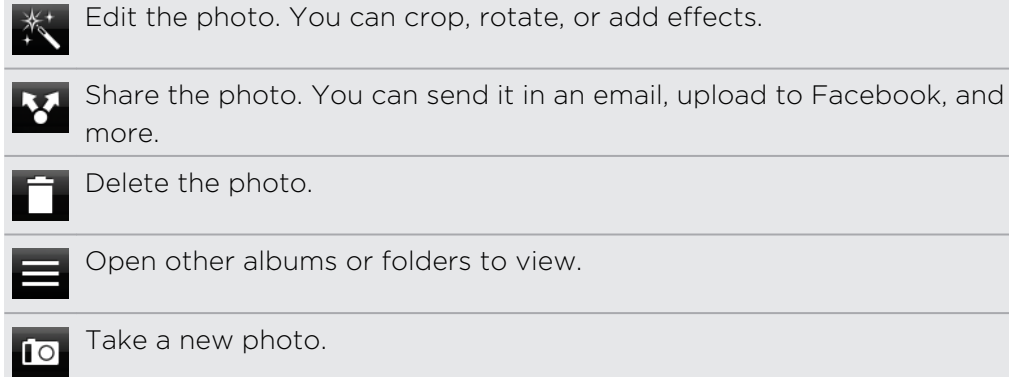

- You can also zoom in or out of a photo.

Camera

Taking a photo

1. From the Home screen, tap  > **Camera**.
2. Before taking the photo, you can zoom in or out first on your subject.
3. Choose the resolution and other camera settings you want to use.
4. Choose an effect to apply to your photo.
5. Point the camera and focus on your subject.



If you're taking people's photo, the camera will automatically recognize faces and adjust the focus. You'll see boxes on people's faces.



Make sure the **Auto focus** and **Face detection** check boxes are selected in the camera settings.

6. When you're ready to take the photo, tap .
7. Choose what you want to do with the photo you've just taken.

Recording video

1. From the Home screen, tap  > **Camcorder**.
2. Choose the video quality and other camera settings you want to use.
3. Choose an effect to apply to your video.
4. Frame your subject on the Viewfinder screen.
5. Tap  to start recording.
6. You can freely zoom in or out while recording video.
7. You can change focus to a different subject or area by just tapping it on the Viewfinder screen.
8. To stop recording, tap  again.
9. Choose what you want to do with the video you've just recorded.

Adding effects

Want to make your photos look more interesting? Easy. Use the available camera effects to make your photos look like they've been taken through special lenses and filters. You can also add certain effects to videos.



Choose an effect first before you start taking a photo or video.

1. Tap .
2. Scroll through the available effects and tap one that you like.

When you choose certain photo effects such as depth of field, distortion, or vignette, drag the bar that appears on the screen to adjust the intensity of the effect.

After capturing

After capturing a photo or video, the Review screen will display the photo or the starting image of the video that you have just captured. Tap the onscreen buttons to choose what you want to do next.

	Return to the Viewfinder screen.
	Delete the photo or video
	Send the photo or video to your computer or another device using Bluetooth, send it by email, or select a social network where you want to upload it to.



Choose how you want to use the photo, such as to use it as your wallpaper



Watch the video.

Changing camera settings

Open the menu panel to access and change camera settings.

To open the camera settings, press .



Some camera features are not available when you're using the front camera, such as auto focusing, zooming, and face detection.

Self-timer (photo mode only)	Set a time delay before your camera automatically takes the photo.
Image adjustments	Slide your finger across each of the slider bars to adjust the exposure, contrast, saturation, and sharpness.
White balance	White balance enables the camera to capture colors more accurately by adjusting to your current lighting environment.
Resolution/Video quality	Choose a photo or video resolution to use.
ISO (photo mode only)	Choose an ISO level or set it back to Auto . Higher ISO numbers are better for taking pictures in low light conditions.
Review duration	Set the time for a captured photo or video to be displayed on the Review screen before the camera changes back to the Viewfinder screen.
Widescreen (photo mode only)	When this check box is selected (default), photo resolutions available for selection are in 16:9 ratio and you can use the entire Viewfinder screen to frame your subject. When not selected, photo resolutions available for selection are in standard 4:3 ratio.
Geo-tag photos (photo mode only)	Select to store GPS location in your captured photos.
Mirror mode (front camera only)	Select to show the mirror image on the viewfinder screen.
Auto enhance (photo mode only)	Select to reduce noise when using a high ISO setting and to automatically adjust photo brightness.
Auto focus (photo mode only)	Enables or disables centered auto focus.
Face detection (photo mode only)	Select to automatically recognize faces and adjust the focus when you take people photos. Face detection will be turned off if you disable auto focus.

Shutter sound	Select to play a sound when you press the shutter release or record button.
Grid (photo mode only)	Select to display a grid on the Viewfinder screen so you can easily frame and center your subject before taking the photo.
Record with audio (video mode only)	Select to record audio when capturing videos.
Reset to default	Change the camera settings back to default.

Photos, videos, and music

Gallery

About the Gallery app

Relive the fun while viewing photos and videos of your latest travels or your pet's newest tricks. Get an audience by tagging your Facebook and Flickr friends. You can even play your media on a TV screen.



To start using Gallery, check first if you have photos or videos copied to the internal storage.

What's more, you can edit and add effects to your photos. You can also easily use a photo as your contact icon, location icon, or wallpaper.

Selecting an album

From the Home screen, tap  > **Gallery**. The Gallery app opens on the Albums screen where your photos and videos are organized by albums for easy viewing.



Turn HTC Flyer to the left to see your albums and thumbnail previews of the albums' content side-by-side.

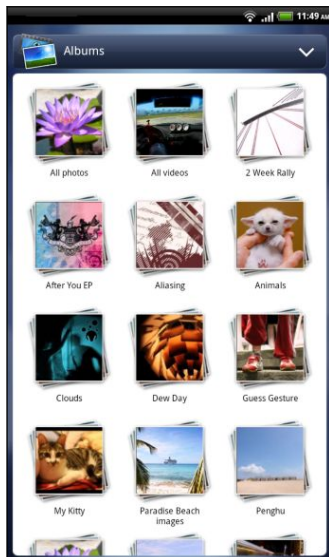

The following are preset albums:

- **Camera shots** lets you view photos and videos that are stored in the camera's folder.
- **My favorites** lets you group photos and videos that you set as your favorites.
- **All photos** lets you view all photos that are stored in all the folders on the internal storage.
- **All videos** lets you view all videos that are stored in all the folders on the internal storage.
- **All downloads** lets you view photos and videos that you downloaded.
- **Snapbooth** lets you view all photos you've taken using Snapbooth.

Folders in the internal storage that contain photos and videos will also be treated as albums and will be listed after the preset albums. The actual folder names will be used as the album names.



- If there are photos or videos under the root path of the internal storage (that are not contained in folders), they will be grouped under the **Other** album.
- If you've inserted a storage card into HTC Flyer, the photos and videos in the storage card will show as well.

Viewing photos

After you've selected an album, you can browse through your photos and videos.

Slide your finger up or down to scroll through the thumbnails. Tap a photo or video to view it in full screen.



Zooming in or out on a photo

There are two ways you can zoom in or out of a photo.

- Tap the screen twice quickly to zoom in, then tap the screen twice quickly again to zoom out.
- Press your thumb and index finger on the screen and then spread your fingers apart to zoom in; pinch your fingers together to zoom out.

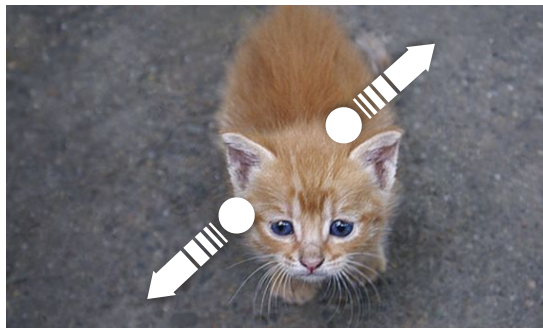

Viewing photos as a slideshow

View the photos in an album as a slideshow.

1. Select an album whose photos you want to view as a slideshow.
2. Tap .



- Tap the screen to show the playback controls.
- With the playback controls showing, tap  to set slideshow preferences.

Watching videos



While browsing an album, tap a video to play it.



Another way to easily get to your videos is to tap  from the Homescreen, and then tap **Videos**.

- Use the onscreen controls to play, pause, or stop the video.



- For an enhanced audio experience, tap  to turn on SRS. (Not available when you're using a Bluetooth headset.)
- Tap  to toggle between full and best-fit screens.

Editing your photos

Do basic editing tasks on your photos such as rotate and crop. You can also enhance your photos by applying effects such as high contrast, vintage, and more.

Rotating a photo

1. On the Gallery app's Albums screen, tap an album.
2. Press and hold on the photo that you want to rotate.
3. In the menu that opens, tap **Edit**, and then tap either **Rotate left** or **Rotate right**.

Cropping a photo

1. On the Gallery app's Albums screen, tap an album.
2. Press and hold on the photo that you want to crop.

3. In the menu that opens, tap **Edit**, and then tap **Crop**. You'll see a crop box around the photo.
4. To adjust the crop box size, press and hold the edge of the box.



5. When directional arrows appear, drag your finger inward or outward to resize the crop box.
6. To move the crop box to the part of the photo that you want to crop, drag the crop box to the desired position.
7. Tap **Save** to keep the changes.

The cropped photo is saved as a copy. The original photo remains unedited.

Adding effects

1. On the Gallery app's Albums screen, tap an album.
2. Press and hold on the photo that you want to add effects to.
3. In the menu that opens, tap **Edit**, and then tap **Effects**. On the panel that opens, you'll see options available to you.
4. Tap an effect to apply on the photo.
5. Tap **Save** to keep the changes.



The enhanced photo is saved as a copy. The original photo remains unedited.

Sending your photos and videos

Send photos and videos via email or MMS to your computer or another device using Bluetooth.

Sending photos or videos by email

You can send several photos, videos, or both in an email message. They are added as file attachments in your email.



1. From the Home screen, tap  > **Gallery**.
2. Tap the album that has the photos or videos you want to share.
3. Tap  and then tap **Gmail** or **Mail**.

4. Select the photos or videos you want to share and then tap **Next**.
5. Compose your message and then tap  (Gmail) or **Send** (Mail).





If you selected **Mail** and you have multiple email accounts, the default email account will be used.

Sending a photo or video by MMS

1. From the Home screen, tap  > **Gallery**.
2. Tap the album that has the photos or videos you want to share.
3. Tap  and then tap **Messages**.
4. Tap the photo or video you want to send. The photo or video is automatically added into the MMS message.
5. To add another photo or video to your slideshow attachment, tap  and then tap **Picture** or **Video**.
6. Compose your message and then tap **Send**.

Sending photos or videos using Bluetooth

You can select several photos, videos, or both and send them to someone's device or your computer using Bluetooth.

1. From the Home screen, tap  > **Gallery**.
2. Tap the album that has the photos or videos you want to share.
3. Tap  and then tap **Bluetooth**.
4. Select the photos or videos you want to share and then tap **Next**.

In the next few steps, you'll be asked to turn on Bluetooth on HTC Flyer and connect to the receiving Bluetooth device so the files can be sent.

Sharing your photos and videos on the Web

Using the Gallery app, you can share photos and videos on your social networks, as well as post videos on YouTube.





You can also use the Camera or Camcorder app to share a photo or video right after you've captured it.

Sharing photos or videos on Facebook



You need to be logged in to your account to be able to upload photos or videos.



1. From the Home screen, tap  > **Gallery**.
2. Tap the album that has the photos or videos you want to share.
3. Tap  and then tap **Facebook for HTC Sense**.
4. Select the photos or videos you want to share and then tap **Next**.

5. Enter a different caption on each photo or video. You can also tag friends on your photos. Tap **Tap to add tag**, and then tap the part where your friend is. From the list that shows, select who you want to tag.
6. Slide to the left to go to the next photo or video.
7. Tap **Upload**.
8. Select which album to upload to and set privacy settings for the uploaded photos or videos.
9. Tap **Done**.

Sharing photos and videos on Flickr





You need to be logged in to your Flickr account to be able to upload photos or videos.

1. From the Home screen, tap  > **Gallery**.
2. Tap the album that has the photos or videos you want to share.
3. Tap  and then tap **Flickr**.
4. Select the photos or videos you want to share and then tap **Next**.
5. Enter a different title and description on each photo or video. You can also tag friends on your photos. Tap **Tap to add tag**, and then tap the part where your friend is. From the list that shows, select who you want to tag.
6. Slide to the left to go to the next photo or video.
7. Tap **Upload**.
8. Select which album to upload to and set privacy settings for the uploaded photos or videos.
9. Tap **Done**.

Sharing photos on Picasa





You need to be signed in to a Google Account to be able to upload photos to the Picasa photo organizing service.

1. From the Home screen, tap  > **Gallery**.
2. Tap the album that has the photos you want to share.
3. Tap  and then tap **Picasa**.
4. Select the photos you want to share and then tap **Next**.
5. Enter a caption for the photos you're uploading.
6. Select the online album where you want to upload the photos, or tap  to create a new album.
7. Tap **Upload**.

You can view the photos online at <http://picasaweb.google.com>.

Sharing videos on YouTube

You can share your videos by uploading them to YouTube.

1. From the Home screen, tap  > **Gallery**.
2. Tap the album that has the videos you want to share.
3. Tap  and then tap **YouTube**.
4. Select the videos you want to share and then tap **Next**. Sign in to your YouTube or Google Account, if you're asked to do so.
5. Enter a title for the videos you're uploading.
6. Tap **More details** where you can enter information such as description and tags, and select a privacy option.
7. Tap **Upload**.

Viewing photos in your social networks

Right in the Gallery app, check what you and your friends have uploaded to your social networks (Facebook and Flickr only).

Viewing photos on Facebook

You need to be logged in to your Facebook account to view Facebook photos.

1. From the Home screen, tap  > **Gallery**.
2. On the top of the screen, tap the bar that displays the current view (for example, **Albums**), and then tap **Facebook**.

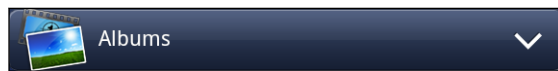

3. Tap your account name or your friend's account on the list to view the photos in the account.

You can view photos in your online albums in the same way as you view photos in Gallery.

Viewing photos on Flickr

You need to be logged in to your Flickr account to view Flickr photos.

1. From the Home screen, tap  > **Gallery**.
2. On the top of the screen, tap the bar that displays the current view (for example, **Albums**), and then tap **Flickr**.

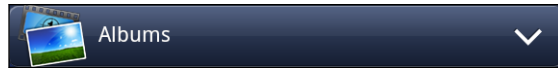

You may be asked to give authorization for the app to connect to the Flickr website. If this happens, you need to give authorization to access your Flickr account.

3. Tap your account name or your friend's account on the list to view the photos in the account.

You can view photos in your online albums in the same way as you view photos in Gallery.

Commenting on photos in your social networks

Add comments to your uploaded photos as well as your friends' photos.

1. Do one of the following:
 - While browsing online albums, press and hold a photo and then tap **Add comment**.
 - While viewing a photo in full screen, tap anywhere on the screen, and then tap .
2. Tap the box that says "Write a comment."
3. Enter your text, and then tap **Comment**.

Music

Listening to music



Enjoy listening to songs and music on HTC Flyer using the Music app.



You need to copy music files to the internal storage first (or an inserted storage card) to use the Music app to play music.

1. From the Home screen, tap  > **Music**.
2. In the playback screen, swipe your finger left or right across the screen to go to the next or previous music album.



If you're not in the playback screen, tap  or .

3. Tap the onscreen icons to control music playback, select a song to play, repeat songs, and more.

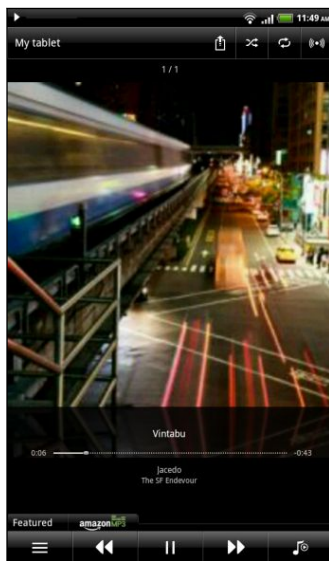

Tap to share music on your home network.



Turn shuffle on or off. (Shuffle is off when button is gray.)



Cycle through the repeat modes: repeat all songs, repeat current song, and don't repeat.



Enjoy listening to your music with SRS. Or, if you're using a wired headset, you can also choose from various preset equalizer settings. (SRS and equalizer are not available when you're using a Bluetooth stereo headset.)



Press and drag your finger across the progress bar to jump to any part of the song.



Tap to check out featured albums from HTCSense.com. (Availability depends on your country.)



Go to the library.



Switch between showing the Now playing list and playback screen. You can rearrange songs in the Now playing list.

Playing music from the Lock screen

When you're listening to music and the screen turns off, press POWER to turn the screen back on and control the music playback directly on the Lock screen.

If you don't see the playback controls on the Lock screen, swipe your finger from left to right on the box onscreen.



You can also pause music playback right from the Notifications panel.

Browsing and playing music in landscape view

Turn HTC Flyer to the left to switch to landscape view. In landscape view, you can see the library and the playback screen or Now playing list side-by-side making it easier for you to browse and play your music at the same time.

In landscape view, tap  to let you skim through your albums easily.

- If you have lots of albums, flick left or right across the screen to quickly skim through them.
- Tap an album to see the song list of the current album.

About the Music widget

You can use the Music widget to play music right from your Home screen.

Browsing music in the library



1. Tap  on the Music app's playback screen or Now playing list to go to the library. In the library, your music is organized by categories such as Artists and Albums. Choose a category by tapping one of the tabs at the bottom of the screen.
2. Tap a song in a category to play it. The Now playing list is updated with the song list from your selected category.



You can add, remove, or rearrange the tabs in the library.

Creating a playlist

Personalize your music experience by creating music playlists. Make a playlist containing just your favorite songs or create one to match your mood for the day. You can make as many playlists as you like.

1. From the Home screen, tap  > Music.
2. Tap  to go to the library.
3. In the library, tap or slide your finger on the bottom row to go to the **Playlists** category.
4. On the upper-right corner of the screen, tap .
5. Enter a playlist name, and then tap **Add songs to playlist**.
6. Choose a category.
7. Select the check boxes of songs you want to add to the playlist and then tap **Add**.
8. Tap **Save**.

Playing the songs in a playlist

1. In the library, tap or slide your finger on the bottom row to go to the **Playlists** category.
2. Tap a playlist to open it.
3. Tap the first song or any song in the playlist.

When you tap a song in the list to play it, the playback screen is updated with the songs from your playlist.

Managing playlists

After creating a playlist, you can add more songs to it, rearrange their order, and more.

1. In the library, tap or slide your finger on the bottom row to go to the **Playlists** category.
2. Tap a playlist to open it.
3. Press , and then choose what you want to do:



Add more songs to a playlist	<ol style="list-style-type: none"> 1. Tap Add songs. 2. Go to the Songs category or any other category. 3. Select the songs you want to add to the playlist and then tap Add.
Rearrange songs	<ol style="list-style-type: none"> 1. Tap Change order. 2. Press and hold  at the end of the song title you want to move. When the row is highlighted, drag it to its new position, then release.
Delete songs from a playlist	<ol style="list-style-type: none"> 1. Tap Remove songs. 2. Select the songs you want to delete and then tap Remove.
Change playlist name	Tap Rename playlist .

Deleting playlists

1. In the library, tap or slide your finger on the bottom row to go to the **Playlists** category.
2. Press  and then tap **Delete playlists**.
3. Select the playlists to delete and then tap **Delete**.

Sharing music using Bluetooth

You can choose a song from the Music app's library and send it to someone's phone or your computer using Bluetooth.

1. From the Home screen, tap  > **Music**.
2. Tap  to go to the library.

3. In the library, choose the song that you want to send via Bluetooth and then play it back.
4. On the playback screen, press  and then tap **Share > Bluetooth**.

In the next few steps, you'll be asked to turn on Bluetooth on HTC Flyer and connect to the receiving Bluetooth device so the music can be sent.

Finding music videos on YouTube

You can find music videos of the song you're listening to on YouTube. It's simple. On the playback screen, just press  and then tap **Find videos**.

Accounts and sync

About online accounts

HTC Flyer can sync with popular online social networking and email accounts.

The information you can get includes:

- Gmail, Exchange ActiveSync®, and other POP3/IMAP email.
- Google and Exchange ActiveSync contacts, as well as your friends' contact information in Facebook and their Twitter profiles.
- Calendar events from your Google Account(s), from Exchange ActiveSync, and from your Facebook account.
- Status updates and links shared by your friends and yourself on social networks such as Facebook and Twitter.
- Flickr and Facebook photo uploads.



You can set up your Exchange ActiveSync and POP3/IMAP email accounts on HTC Flyer either in the Mail app or the Accounts & sync settings.

Synchronizing with a Google Account

Signing in to your Google Account lets you sync Gmail and your Google contacts and calendars between HTC Flyer and the Web. You also need to sign in to a Google Account to use Google apps such as Google Talk™ and Android Market.



If you skipped adding a Google Account when you first set up HTC Flyer, you may encounter problems when using some Google apps. If these problems persist, you may need to factory reset HTC Flyer and enter your Google Account details when you set up HTC Flyer again.

Adding more Google Accounts

You can add more than one Google Account. However, subsequent Google Accounts can only sync contacts, emails, and calendar events. Other Google services use the first Google Account you added.

1. From the Home screen, press , and then tap **Settings > Accounts & sync**.
2. Tap **Add account > Google**.
3. Follow the onscreen instructions to sign in to an account or create a new account.

Forgot your Google Account password?

If you have forgotten your Google Account password, you can try to recover it by going to the Google website.

1. On HTC Flyer or on your computer, open your web browser and go to <https://www.google.com/accounts/ForgotPasswd>.
2. Enter the email address or username that you use to sign in to your Google Account and click **Submit**.
3. Follow the instructions on the screen to reset your password.

If you don't have an alternate email address or cannot access the email account you used to create your Google Account, you can reset your Google Account after 24 hours by answering the security question for password recovery.

Adding a social network account

Skipped signing in to your social network accounts (such as Facebook, Twitter, or Flickr) when you first turned on and set up HTC Flyer? You can still add these accounts.

1. From the Home screen, press , and then tap **Settings > Accounts & sync**.
2. Tap **Add account**, and then tap the account type you want to add.
3. Follow the onscreen instructions to enter the account information.

Your social network account is then added to the list on the Accounts & sync screen. Depending on how you configured the account, the new information may start synchronizing with HTC Flyer.

Managing your online accounts

Changing general sync settings

1. From the Home screen, press , and then tap **Settings > Accounts & sync**.
2. Select or clear the following:

Background data	If this is selected, apps can send and receive online account information even if you are not currently using them.
Auto-sync	If this is selected, apps can use the sync schedule defined in the account settings. If this is cleared, you will need to sync accounts manually.

Synchronizing an account manually

1. From the Home screen, press , and then tap **Settings > Accounts & sync**.
2. Tap the account that you want to sync.
3. Tap **Sync now**.

Changing account settings

You can change settings such as the sync frequency and the types of information synchronized, the kinds of notification you receive, and the way that account information is displayed.

1. From the Home screen, press , and then tap **Settings > Accounts & sync**.
2. On the Accounts & sync screen, tap the account that you want to edit.
3. Tap the type of information you want to sync or select an item to edit its settings.

Removing an account

You can remove an account to delete it and all information associated with it from HTC Flyer, for example messages, contacts, or settings. Removing an account does not delete information from the online service itself.



You cannot remove some accounts, such as the first Google account you signed into, except by deleting all personal information from HTC Flyer with a hard reset.

1. From the Home screen, press , and then tap **Settings > Accounts & sync**.
2. Tap the account that you want to remove.
3. Tap **Remove account**, and then confirm that you want to remove the account.

Social

Facebook for HTC Sense

If you signed in to your Facebook account when you turned on and set up HTC Flyer for the first time, that means your Facebook account is linked to Facebook for HTC Sense on HTC Flyer.

With Facebook for HTC Sense, you can:

- See all your Facebook contacts and their instant status updates in People.



When you tap a contact on the All tab, slide to the Updates and events tab to see updates such as posted status messages, uploads, and profile changes.

When there is a notification of the contact's birthday, you can tap the notification to send a greeting.

- See Facebook photos right on the Gallery app.

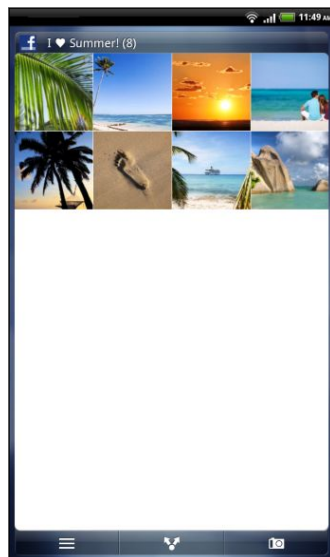

You can also upload one or more photos to Facebook, then tag and add captions that go with it.

When you're viewing the albums of a Facebook friend, you can also share a link to a particular album, or comment on the album photos.

- Check your friends' Facebook status updates in Friend Stream.
- Add your Facebook events and your friends' birthdays to the Calendar app.



Facebook app

The Facebook app lets you keep up and stay close with your friends in Facebook. It offers most of the features that you are familiar with when using Facebook on your computer.

With the Facebook app, you can:

- Share your thoughts and check other people's status updates.
- View your friends list and write on someone's wall.
- Comment on and like a friend's post.
- View someone's personal information, including photo albums.
- Check your Facebook notifications.
- Take a photo and upload it straight to your Facebook account.

Using the Facebook app

1. From the Home screen, tap  > **Facebook**.
2. If this is your first time to use Facebook, follow the onscreen instructions to sign in to your Facebook account.
3. On the News Feed screen, tap  to access the other functions.



- While on the Facebook home screen, press , and then tap **Settings** to set refresh and notification options.
- On some Facebook screens, you can press and hold an item to open an options menu.

Adding the Facebook widget

Add the Facebook widget to the Home screen so you can easily post updates and check status updates of your friends.



The widget will only link to the Facebook account that you logged into on the Facebook app.

What's the difference between Facebook app and Facebook for HTC Sense?

- Facebook for HTC Sense is not a standalone app. It is integrated in People, Friend Stream, Gallery, and Calendar to give you up-to-date information about your Facebook contacts (their status updates, shared links, and photos) in these apps.
- The Facebook app is a standalone app. Use this app to do most of the things that you would do when you're using your computer's web browser to access your Facebook account, such as adding a friend and sending Facebook messages.
- The two do not share the same login credentials. Signing in to Facebook for HTC Sense does not sign you in to the Facebook app and vice versa. If you want to use the same Facebook account for both, you'll have to sign in to both using the same login credentials.



If you have more than one Facebook account, you may sign in to the Facebook app using your second account, since the Facebook app does not share the same login credentials as Facebook for HTC Sense.

Twitter for HTC Sense

If you signed in to your Twitter account when you turned on and set up HTC Flyer for the first time, that means your Twitter account is linked to Twitter for HTC Sense on HTC Flyer. (If you did not do this, add the Twitter for HTC Sense account in **Settings > Accounts & sync.**)

With Twitter for HTC Sense, you can:

- Link your contacts in People to their Twitter profiles (if you're following them).
- Send tweets and check your friends' tweets in Friend Stream.



Twitter for HTC Sense and the Twitter for app do not share the same login credentials. Signing in to Twitter for HTC Sense does not sign you in to the Twitter app and vice versa. If you want to use the same Twitter account for both, you'll have to sign in to both using the same login credentials.

Using Friend Stream

Friend Stream connects you to your social networks. Share and get updates from friends in popular networks like Facebook and Twitter in a single feed. With Friend Stream, you can easily track your friends' status messages, photo uploads, notifications, and more — or comment and post your own.

- You must be signed in to at least one social network account to use Friend Stream.
- To use your Facebook account on Friend Stream, you need to be signed in via Facebook for HTC Sense.

From the Home screen, tap  > **Friend Stream**. Friend Stream opens on the All updates tab.

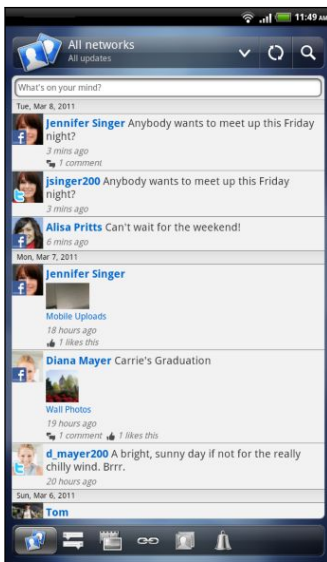

When you tap someone's status update, you can:

- View all tweets.
- Write a comment. Like or unlike someone's Facebook posts.
- Look at someone's album photos.



When you tap someone's photo or name, you can:

- Check the person's profile details.
- Look at the person's Facebook wall.
- Check the person's posted tweets.

Slide to the other tabs to view social network updates grouped as status updates only, photo uploads, links, updates from members of your Facebook list, or social network notifications.

Updating your status

You can update your status simultaneously on all the social network accounts you are signed in to.

1. From the Home screen, tap  > **Friend Stream**.
2. On the All updates tab, tap the text box that says **What's on your mind**.
3. Enter your status update.
4. If you do not want to send the status update to all your social network accounts, tap  and clear the check boxes of the social networks to exclude.

- Tap  and then choose what you want to attach to your tweet or status update.



Picture	Select From Camera to take a photo and attach it or From Gallery to attach a photo.
Location	Add your current location or a location you pick on a map.
App recommendation	Choose an app you've installed from Android Market that you want to share with others. The URL from which the app can be downloaded will be inserted to your status.

- Tap Post.

Commenting on and liking Facebook posts

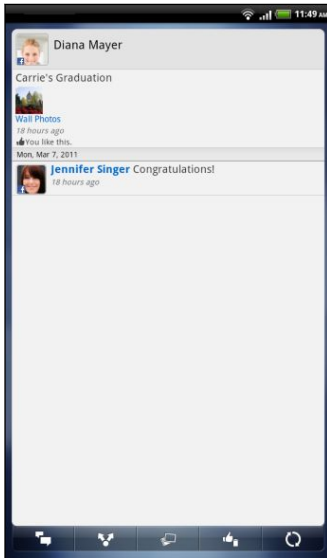
Tap someone's status update on the All updates tab, and do any of the following:



- Tap  or  to like or unlike the person's status update.
- Tap  to comment on the person's status update.

Checking notifications from your social networks

Slide to the Notifications tab to easily see a single feed of your notifications from different social networks. It can be a comment on your Facebook post, a mention or direct message in Twitter, a tagged photo of you, and more.

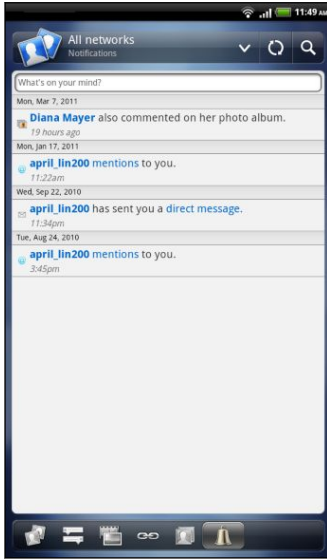

About the Friend Stream widget

Use the Friend Stream widget so you can easily update your status and view other people's status updates right on the Home screen. If you want to keep up with just one person's Facebook updates, you can add the Friend Channel widget. You can find it in the Friend Stream widget layout options.

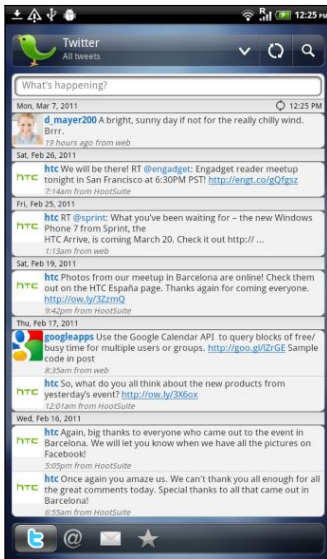

Tweeting in Friend Stream

In Friend Stream, tap the bar at the top of the screen (for example, All networks), and then tap Twitter.



	Tap to compose and send a tweet.
	Tap a person's name to check profile details and all of his or her tweets.
	If you have linked the contact in People, tap the photo or icon to open a menu where you can quickly choose how to communicate with the contact.
	Press and hold a tweet to open an options menu to reply, send a direct message, retweet, and more.
	View all the tweets from people you follow and tweets that you have posted.
	View all tweets that mention your username using the “[@your username]” convention.
	View all private/direct messages that you have received or sent.
	View tweets that you have marked as favorites.

Sending a tweet

1. On the All tweets tab, tap the text box that says **What's happening**.
2. Type your tweet.
3. Add a picture or location to your tweet.
 - Tap  to post a picture from Gallery or Camera to your default photo hosting site and add the link to the picture in your tweet.
 - Tap  to insert your location into the tweet. You can choose to add a map link, insert your location name, or insert your position coordinates.
4. Tap Post.

Searching for Twitter users to follow

1. In any of the tabs, tap .
2. Type a Twitter name in the search box, and then tap **Search online**.



If you don't see **Search online**, scroll down the screen.

3. In the list of search results, tap the Twitter user you want to follow.
4. Press , and then tap **Follow**.

Sending a direct message

You can only send a direct message to someone who is following you.



1. In any of the tabs, press , and then tap **New message**.
2. Tap the text box at the top of the screen, and then enter the name. As you enter characters, the names of the Twitter users that match the characters you enter will appear. Tap the name when you see it.
3. Enter your message, and then tap **Post**.

You can also send a direct message when you press and hold a tweet of the person you want to send the direct message to, and then tap **Send direct message** on the options menu.

Chatting in Google Talk

Google Talk is Google's instant messaging program. It lets you communicate with other people that also use Google Talk. If you signed in to your Google Account when you first set up HTC Flyer, you are already signed in to Google Talk.

Chatting with a friend

1. In Google Talk, tap a friend in the Friends list.
2. Enter your message in the text box. You can also insert a smiley by pressing , and then tapping **More > Insert smiley**.
3. Tap **Send**.
4. While chatting, press  and then tap any of these options:

Chat off record	Your Google Talk messages are stored in the Chats folder of your Gmail account. Tap this option if you don't want to store your chat messages.
Switch chats	If you have more than one chat going, tap to switch chat with another friend.
Friends list	Return to the Friends list.

Add to chat	Add another friend to your chat. The friend you invited and the friend you're currently chatting will receive an invitation to a group chat. Each one who accepts the invitation joins the group chat.
End chat	End your current chat.
More	Clear the chat history, insert a smiley or view your friend's contact details.

Accepting a chat invitation

When a friend sends you a Google Talk message, you receive a notification. Their entry in the Friends list displays the message.

Do one of the following:

- In the Friends list, tap the friend who sent you the invitation to chat.
- Open the Notifications panel, and then tap the chat notification.

Changing your online status and picture







1. In Google Talk's Friends list, tap your name to open the Set Status screen.
2. Enter your new status message. Or press  to choose a custom status from the list.
3. Tap the online status beside your picture, and then select the status you want on the menu.
4. Tap your picture, and then do one of the following:
 - Tap **Remove** to remove your photo.
 - Tap **Change** to select another picture.
5. Tap **Done**.

Your online status, message, and picture appear in your contacts' Friends list and in other apps where your Google Talk status are displayed.

Adding and managing friends

The Friends list is where you add and manage your friends in Google Talk.

In Google Talk's Friends list, you can:

Invite a friend	<ol style="list-style-type: none"> 1. Press , and then tap Add friend. 2. Enter the Google Talk instant messaging ID or Gmail address of the friend you want to add. 3. Tap Send invitation.
View all friends	Initially, only those friends that you often chat with — the most popular — are shown in the Friends list. To view all your friends, press  , and then tap All friends . To view only friends that you often chat with, press  , and then tap Most popular .
Make a friend popular	<ol style="list-style-type: none"> 1. Press , and then tap All friends. 2. Press and hold a friend's name, and then tap Always show friend.
Block a friend	<p>You can block a friend from sending you messages. When blocked, your friend is removed from the Friends list and is added to the Blocked friends list.</p> <ol style="list-style-type: none"> 1. Press , and then tap All friends. 2. Press and hold a friend's name, and then tap Block friend.
Unblock a friend	Press  , and then tap More > Blocked .
View all invited friends	Press  , and then tap More > Invites . Friends who have not yet accepted your invitation are listed on the screen.

Changing settings or signing out

In Google Talk's Friends list, press  and then tap:

- **Settings** to change the app and notification settings.
- **Sign out** to sign out.

Internet connections

Data connection

When you turn on HTC Flyer for the first time, it will be automatically set up to use your mobile operator's data connection (if the SIM card is inserted).

Checking the data connection you're using

1. From the Home screen, press , and then tap **Settings > Wireless & networks**.
2. Tap **Mobile networks > Network operators** or **Access Point Names**.



Turning the data connection on or off

Turning your data connection off can help save battery life and save money on data charges. However, if you don't have data connection turned on and you're also not connected to a Wi-Fi network, you won't receive automatic updates to your email, social network accounts, and other synchronized information.

1. From the Home screen, press , and then tap **Settings > Wireless & networks**.
2. Select the **Mobile network** check box to turn on the data connection; clear the check box to turn off the data connection.

Adding a new access point

Before you add another data connection, have the access point name and settings (including username and password if required) from your mobile operator ready.

1. From the Home screen, press , and then tap **Settings > Wireless & networks**.
2. Tap **Mobile networks > Access Point Names**.
3. On the APNs screen, press  and then tap **New APN**.
4. On the Edit access point screen, enter the APN settings. Tap an APN setting item to edit it.
5. Press  and then tap **Save**.

Enabling data roaming

Connect to your mobile operator's partner networks and access data services when you're out of your mobile operator's coverage area.



Using data services while roaming will be costly. Check with your mobile operator for data roaming rates before you use data roaming.

1. From the Home screen, press , and then tap **Settings > Wireless & networks**.
2. Tap **Mobile networks**, and then select the **Data roaming** check box.

Select the **Data roaming sound** check box if you'd like HTC Flyer to play a sound so you'll know when it's connecting to a roaming network.

Wi-Fi

To use Wi-Fi, you need access to a wireless access point or "hotspot". The availability and strength of the Wi-Fi signal will vary depending on objects, such as buildings or simply a wall between rooms, the Wi-Fi signal has to pass through.

Turning Wi-Fi on and connecting to a wireless network

1. From the Home screen, press , and then tap **Settings > Wireless & networks**.
2. Select the **Wi-Fi** check box to turn Wi-Fi on. HTC Flyer then scans for available wireless networks.
3. Tap **Wi-Fi settings**. The network names and security settings of detected Wi-Fi networks are displayed in the Wi-Fi networks section.
4. If the wireless network you want to connect to is not in the list of detected networks, scroll down the screen, and then tap **Add Wi-Fi network**. Enter the wireless network settings, and then tap **Save**.
5. Tap the Wi-Fi network you want to connect to. If you selected an open network, you will be automatically connected to the network.
6. If you selected a network that is secured with WEP, enter the key and then tap **Connect**.

When HTC Flyer is connected to the wireless network, the Wi-Fi icon  appears in the status bar and tells you the approximate signal strength (number of bands that light up).

The next time HTC Flyer connects to a previously accessed secured wireless network, you won't be asked to enter the key or other security information again, unless you reset HTC Flyer to its factory default settings.

Connecting to a Wi-Fi network with EAP-TLS security

You may need to install a network certificate (*.p12) to HTC Flyer before you can connect to a Wi-Fi network with EAP-TLS authentication protocol.

1. Save the certificate file to the root folder of the storage card.
2. From the Home screen, press , and then tap **Settings > Security**.
3. Tap **Install from SD card**.
4. Select the network certificate needed to connect to the EAP-TLS network.
5. Turn on Wi-Fi and connect to a wireless network.

Checking the wireless network status



1. From the Home screen, press , and then tap **Settings > Wireless & networks**.
2. On the Wireless & networks screen, tap **Wi-Fi settings**, and then tap the wireless network that HTC Flyer is currently connected to.

A message box is then displayed showing the Wi-Fi network name, status, speed, signal strength, and more.



If you want to remove the settings for this network, tap **Forget**. If you want to reconnect to a wireless network that you have removed, you'll need to choose the wireless network from the list of available Wi-Fi networks again. If it is a secured wireless network, you'll need to enter the wireless network credentials again.

Connecting to another Wi-Fi network

1. From the Home screen, press , and then tap **Settings > Wireless & networks**.
2. Tap **Wi-Fi settings**. Detected Wi-Fi networks are displayed in the Wi-Fi networks section.
3. To manually scan for available Wi-Fi networks, on the Wi-Fi screen, press , and then tap **Scan**.
4. Tap another Wi-Fi network to connect to it.

About connection widgets

Add the Mobile Network and Wi-Fi widgets or the Data dashboard widget to the Home screen to make it faster for you to turn on or off these connections. Tap the widget or icon on the dashboard to turn on or off the connection.



Connecting to a virtual private network (VPN)

Add, set up, and manage virtual private networks (VPNs) so you can connect and access resources inside a secured local network, such as your corporate network.

Depending on the type of VPN you're using at work, you may be asked to enter your login credentials and install security certificates before you can connect to your company's local network. You can get this information from your network administrator.

Also, HTC Flyer must first establish a Wi-Fi or data connection before you can start a VPN connection.

Setting up secure credential storage

If your network administrator tells you to download and install security certificates, you must first set up secure credential storage on HTC Flyer.

1. From the Home screen, press **≡**, and then tap **Settings > Security**.
2. Tap **Set password**.
3. Enter a new password for the credential storage.
4. Scroll down and confirm the password, and then tap **OK**.
5. Select the **Use secure credentials** check box.



You can then download and install the certificates needed to access your local network. Your network administrator can tell you how to do this.

Adding a VPN connection

1. From the Home screen, press **≡**, and then tap **Settings > Wireless & networks**.
2. Tap **VPN settings > Add VPN**, and then tap the type of VPN you want to add.
3. Tap the VPN settings and set them up according to the security details your network administrator gave you.
4. Press **≡**, and then tap **Save**.

The VPN is then added to the VPNs section of the VPN settings screen.

Connecting to a VPN

1. From the Home screen, press , and then tap **Settings > Wireless & networks**.
2. Tap **VPN settings**.
3. In the VPNs section, tap the VPN that you want to connect to.
4. When asked, enter your log in credentials, and then tap **Connect**. When you're connected, the VPN connected icon  appears in the notification area of the title bar.

You can then open the web browser to access resources such as your corporate network intranet.

Disconnecting from a VPN

1. Press and hold the title bar, and then slide down your finger to open the Notifications panel.
2. Tap the VPN connection to return to the VPN settings screen, and then tap the VPN connection to disconnect from it.

When HTC Flyer has disconnected from the VPN, the VPN disconnected icon  is displayed in the notification area of the title bar.

Using HTC Flyer as a modem (USB tethering)

No Internet connection available for your computer? No problem. Use the data connection on HTC Flyer to connect to the Internet.



- You need your SIM card inserted on HTC Flyer to use the data connection.
- To use HTC Flyer as a modem, you need to install HTC Sync on your computer first.

1. Make sure the data connection on HTC Flyer is turned on.
2. Connect HTC Flyer to the computer using the provided USB cable.
3. On the Connect to PC screen, select **USB tethering**, and then tap **Done**.

Connecting HTC Flyer to the Internet through a computer (Internet Pass-through)

If you don't have a data plan for HTC Flyer or you don't have access to a Wi-Fi network, you can still go online on HTC Flyer by using your computer's Internet connection.



Before you can use your computer as a modem, be sure to install HTC Sync on your computer first.

1. Make sure your computer is connected to the Internet.



Two things to check for your computer's Internet connection. One, you may need to turn off your local network's firewall. Two, if your computer connects to the Internet via PPP (e.g. Dial UP, xDSL, or VPN), Internet Pass-through will only support TCP protocol.

2. Connect HTC Flyer to the computer using the provided USB cable.
3. On the Connect to PC screen, select **Internet pass-through**, and then tap **Done**.

Using HTC Flyer as a wireless router

Share your data connection with other devices by turning HTC Flyer into a wireless router.

Make sure the data connection on HTC Flyer is turned on before you use it as a wireless router.

1. From the Home screen, press , and then tap **Settings > Wireless & networks**.
2. Tap **Portable Wi-Fi hotspot settings**.
3. Enter a router name or use the default router name.
4. Choose the type of Security and set the password (key) for your wireless router. If you selected **None** in Security, you don't need to enter a password.



The password is the key other people need to enter on their device so they can connect and use HTC Flyer as a wireless router.

5. Select the **Portable Wi-Fi hotspot** check box to turn on the wireless router.

HTC Flyer is ready to be used as a wireless router when you see  on the status bar.

Bluetooth

Bluetooth basics

Turning Bluetooth on or off

1. From the Home screen, press , and then tap **Settings** > **Wireless & networks**.
2. Select or clear the **Bluetooth** check box.

An even easier way to turn Bluetooth on or off is with the Bluetooth widget on the Home screen.



Turn off Bluetooth when not in use to save battery power, or in places where using a wireless device is prohibited, such as on board an aircraft and in hospitals.

Changing the device name

The device name identifies HTC Flyer to other devices.

1. From the Home screen, press , and then tap **Settings** > **Wireless & networks**.
2. Tap **Bluetooth settings**.
3. If the **Bluetooth** check box is not selected, select it to turn Bluetooth on.
4. Tap **Device name**.
5. Enter the new name for HTC Flyer in the dialog box, and then tap **OK**.

Connecting a Bluetooth headset or car kit

You can listen to music over a Bluetooth stereo headset, or have hands-free conversations using a compatible Bluetooth headset or car kit. It's the same procedure to set up stereo audio and hands-free.



- For you to listen to music with your headset or car kit, the headset or car kit must support the A2DP Bluetooth profile.
- Before you connect your headset, you need to make it discoverable so HTC Flyer can find it. You can find out how to do this by referring to your headset manual.

1. From the Home screen, press , and then tap **Settings** > **Wireless & networks**.
2. Tap **Bluetooth settings**.
3. If the **Bluetooth** check box is not selected, select it to turn Bluetooth on.
4. Make sure that the headset is discoverable.

5. Tap **Scan for devices**. HTC Flyer will start to scan for Bluetooth devices within range.
6. When you see the name of your headset displayed in the Bluetooth devices section, tap the name. HTC Flyer then automatically tries to pair with the headset.
7. If automatic pairing fails, enter the passcode supplied with your headset.

The pairing and connection status is displayed below the hands-free headset or car kit name in the Bluetooth devices section. When the Bluetooth headset or car kit is connected to HTC Flyer, the Bluetooth connected icon  is displayed in the status bar. Depending on the type of headset or car kit you have connected, you can then start using the headset or car kit to listen to music and/or make and receive phone calls.

Reconnecting a headset or car kit

Normally, you can easily reconnect your headset by switching on Bluetooth on HTC Flyer, and then turning on the headset. However, you might have to connect manually if your headset has been used with another Bluetooth device.

1. From the Home screen, press , and then tap **Settings > Wireless & networks**.
2. Tap **Bluetooth settings**.
3. If the **Bluetooth** check box is not selected, select it to turn Bluetooth on.
4. Make sure that the headset is discoverable.
5. Tap the headset's name in the Bluetooth devices section.
6. If prompted to enter a passcode, try 0000 or 1234, or consult the headset/car kit documentation to find the passcode.

If you still cannot reconnect to the headset or car kit, follow the instructions in [Unpairing from a Bluetooth device](#) on page 79, and then follow the steps under [Connecting a Bluetooth headset or car kit](#) on page 77.

Disconnecting or unpairing from a Bluetooth device

Disconnecting a Bluetooth device

1. From the Home screen, press , and then tap **Settings > Wireless & networks**.
2. Tap **Bluetooth settings**.
3. In the Bluetooth devices section, press and hold the device to disconnect.
4. Tap **Disconnect**.

Unpairing from a Bluetooth device

You can make HTC Flyer forget its pairing connection with another Bluetooth device. Doing so may require you to enter or confirm a passcode again if you want to reconnect to the other device.

1. From the Home screen, press , and then tap **Settings > Wireless & networks**.
2. Tap **Bluetooth settings**.
3. In the Bluetooth devices section, press and hold the device to unpair.
4. Tap **Disconnect & unpair**, or tap **Unpair** if the Bluetooth device is currently not connected to HTC Flyer.

Sending information using Bluetooth

You can use Bluetooth to send information from HTC Flyer to another Bluetooth enabled device such as a phone or notebook computer. You can send the following types of information, depending on the device you are sending to:



- Images and videos
- Calendar events
- Contacts
- Audio files





Before you begin, set the receiving device to discoverable mode. You may also need to set it to “Receive Beams” or “Receive Files”. Refer to the device’s documentation for instructions on receiving information over Bluetooth.

1. On HTC Flyer, open the app that contains the information or file you want to send.
2. Follow the steps for the type of item you want to send:

Captured photo or video	After capturing, on the Camera preview screen, tap  , and then tap Bluetooth .
--------------------------------	--

Photos or videos	<ol style="list-style-type: none"> 1. On the Albums tab  of the Gallery app, choose an album. 2. Tap , and then tap Bluetooth. 3. Choose the photos and videos you want to share, and then tap Next.
-------------------------	---

Contact	<ol style="list-style-type: none"> 1. On the All tab  of the People app, press and hold a contact, and then tap Send contact as vCard. 2. Tap the down arrow icon, and then select Bluetooth from the displayed list. 3. Tap Send.
Calendar appointment or event	In Day view, Agenda view, or Week view, press and hold the event, and then tap Share vCalendar > Bluetooth .
Music track	With the track displayed on the Music app's Now playing screen, press  , and then tap Share > Bluetooth .
Voice recording	On the main Voice Recorder screen, tap  , and then tap Bluetooth .

3. Turn on Bluetooth if you're asked to do so.
4. If you haven't paired with the receiving device before, tap **Scan for devices**.
5. Tap the name of the receiving device.
6. If prompted, accept the pairing request on HTC Flyer and on the receiving device. Also enter the same passcode or confirm the auto-generated passcode on both devices.
7. On the receiving device, accept the file.

Where sent information is saved

When you send information using Bluetooth, the location where it's saved depends on the type of information and the receiving device.

If you send a calendar event or contact, it is normally added directly to the corresponding application on the receiving device. For example, if you send a calendar event to a compatible phone, the event is shown in that phone's calendar application.

If you send another file type to a Windows computer, it is normally saved in the Bluetooth Exchange folder within your personal document folders.

- On Windows XP, the path may be: C:\Documents and Settings\[your username]\My Documents\Bluetooth Exchange
- On Windows Vista, the path may be: C:\Users\[your username]\Documents
- On Windows 7, the path may be: C:\Users\[your username]\My Documents\Bluetooth Exchange Folder

If you send a file to another device, the saved location may depend on the file type. For example, if you send an image file to another mobile phone, it may be saved in a folder named "Images".

Receiving information using Bluetooth

HTC Flyer lets you receive various files with Bluetooth, including photos, music tracks, and documents such as PDFs.

To receive files using Bluetooth, make sure that your storage card is inserted.

1. From the Home screen, press , and then tap **Settings > Wireless & networks**.
2. Tap **Bluetooth settings**.
3. If the **Bluetooth** check box is not selected, select it to turn Bluetooth on.
4. Select the **Discoverable** check box.
5. On the sending device, send one or more files to HTC Flyer. Refer to the device's documentation for instructions on sending information over Bluetooth.
6. If asked, accept the pairing request on HTC Flyer and on the receiving device. Also enter the same passcode or confirm the auto-generated passcode on both devices.

You'll then get a Bluetooth authorization request.

7. If you want to automatically receive files from the sending device in future, select the **Always** check box.
8. Tap **Accept** or **OK**.
9. When HTC Flyer receives a file transfer request notification, slide down the Notifications panel, tap the incoming file notification, and then tap **Accept**.
10. When a file is transferred, a notification is displayed. To open the file immediately, slide down the Notifications panel, and then tap the relevant notification.

When you open a received file, what happens next depends on the file type:

- Media files and documents are usually opened directly in a compatible app. For example, if you open a music track, it starts playing in the Music app.
- For a vCalendar file, choose the calendar where you want to save the event, and then tap **Import**. The vCalendar is added to your Calendar events.
- For a vCard contact file, if there are multiple vCard files on your storage card, you can choose to import one, several, or all of those contacts to your contacts list.

Adding the Bluetooth received folder to the Home screen

You can add a folder to the Home screen that shows all files you have received with Bluetooth.

1. From the Home screen, tap .
2. On the Personalize screen, tap Folder > Bluetooth received.
3. Press and hold the Bluetooth received folder icon, and drag it to the Home screen position you want.

To view the folder contents, tap the folder icon. To open a file, tap the file name.

Trademarks and copyrights

©2011 HTC Corporation. All Rights Reserved.

HTC, the HTC logo, the HTC quietly brilliant logo, HTC Flyer, Footprints, HTC Sense, and HTC Sync are trademarks or service marks of HTC Corporation.

©2011 Google Inc. Used with permission. Google, the Google logo, Android, the Android logo, Android Market, the Android Market logo, Google Apps, Google Calendar, Google Checkout, Google Earth, Google Latitude, Google Maps, Google Talk, Gmail, Picasa, and YouTube are trademarks of Google Inc.

Microsoft, Windows, ActiveSync, Outlook, PowerPoint, Windows Media, Windows Vista, and Word are either registered trademarks or trademarks of Microsoft Corporation in the United States and/or other countries.

Bluetooth and the Bluetooth logo are trademarks owned by Bluetooth SIG, Inc.

This device contains Adobe® Flash® Player and Adobe® Reader® Mobile software under license from Adobe Systems Incorporated. Copyright ©1995–2011 Adobe Systems Incorporated. All rights reserved. Adobe and Reader are trademarks of Adobe Systems Incorporated.

Wi-Fi is a registered trademark of the Wireless Fidelity Alliance, Inc.

microSD is a trademark of SD Card Association.

Facebook is a trademark of Facebook, Inc.

Twitter is a trademark of Twitter, Inc., and is used under license.

Flickr is a trademark of Yahoo! Inc.

DLNA is a registered trademark, DLNA disc logo is a service mark, and DLNA Certified is a trademark of the Digital Living Network Alliance.

©2011 Kobo Inc. All rights reserved. Kobo and the Kobo logo are trademarks of Kobo Inc.

iTunes is a trademark of Apple Inc.

All other company, product and service names mentioned herein are trademarks, registered trademarks or service marks of their respective owners.

HTC shall not be liable for technical or editorial errors or omissions contained herein, nor for incidental or consequential damages resulting from furnishing this material. The information is provided “as is” without warranty of any kind and is subject to change without notice. HTC also reserves the right to revise the content of this document at any time without prior notice.

No part of this document may be reproduced or transmitted in any form or by any means, electronic or mechanical, including photocopying, recording or storing in a retrieval system, or translated into any language in any form without prior written permission of HTC.

Index

Symbols

3G 71

B

Bluetooth

- connecting a Bluetooth headset or car kit 77
 - disconnecting or unpairing 78
 - sending information 79
 - turning on or off 77
-

C

Camera

- effects 42
- recording a video 42
- settings 43
- taking a photo 41

Copying text 20

D

Data connection

- access point 71
 - turning on or off 71
-

F

Facebook 62

Friend Stream 64

G

Gallery

- editing photos 47
- sending photos and videos 48
- sharing photos and videos 49
- viewing photos in social networks 51
- watching video 47

Getting started 5

Google Account 58

Google Talk 68

H

Hands free 77

Headphones 77

Home screen

- about 13
 - adding widgets 25
 - rearranging items 28
-

I

Internet connection

- data connection 71
- Internet pass-through 76
- Tethering 75
- VPN 74
- Wi-Fi 72
- wireless router 76

Internet pass-through 76

K

Kid Mode 39

L

Leap view 13

M

Modem 75, 76

N

Notes

- about 35
- attaching files 36
- clipping screens 36
- creating notebooks 35
- linking to a calendar event 37
- syncing notes 35
- writing 36

Notifications

- panel 18

O

- Online accounts
 - about 58
 - managing 59
-

P

- Pair a Bluetooth device 77
-

Q

- Quick Settings 19
-

R

- Router 76
-

S

- Scenes 23
 - Scribble mode 34
 - SIM card
 - inserting 8
 - Sketchbook
 - about 37
 - playing a sketch demo 37
 - sharing 38
 - Snapbooth 40
 - Social networks
 - adding 59
 - viewing photos 51
 - Sound set 28
 - Sync
 - online accounts 60
-

T

- Tablet pen
 - about 32, 33
 - changing the battery 32
 - Photos
 - editing 41, 47
 - sharing 49
 - viewing 41
 - Tethering 75
-

U

- USB 75
-

V

- Videos
 - recording 42
 - sharing 49
 - watching 47
 - VPN
 - adding a connection 74
 - connecting 75
-

W

- Wallpaper
 - changing 24
 - Wi-Fi
 - connecting to another network 73
 - network status 73
 - turning on 72
 - Widgets
 - adding 25
 - changing settings 26
 - removing 28
 - Wireless router 76
-

Y

- YouTube
 - sharing videos 51
-

Z

- Zoodles 39
-