

Your **HTC** = 5<; 2

User guide

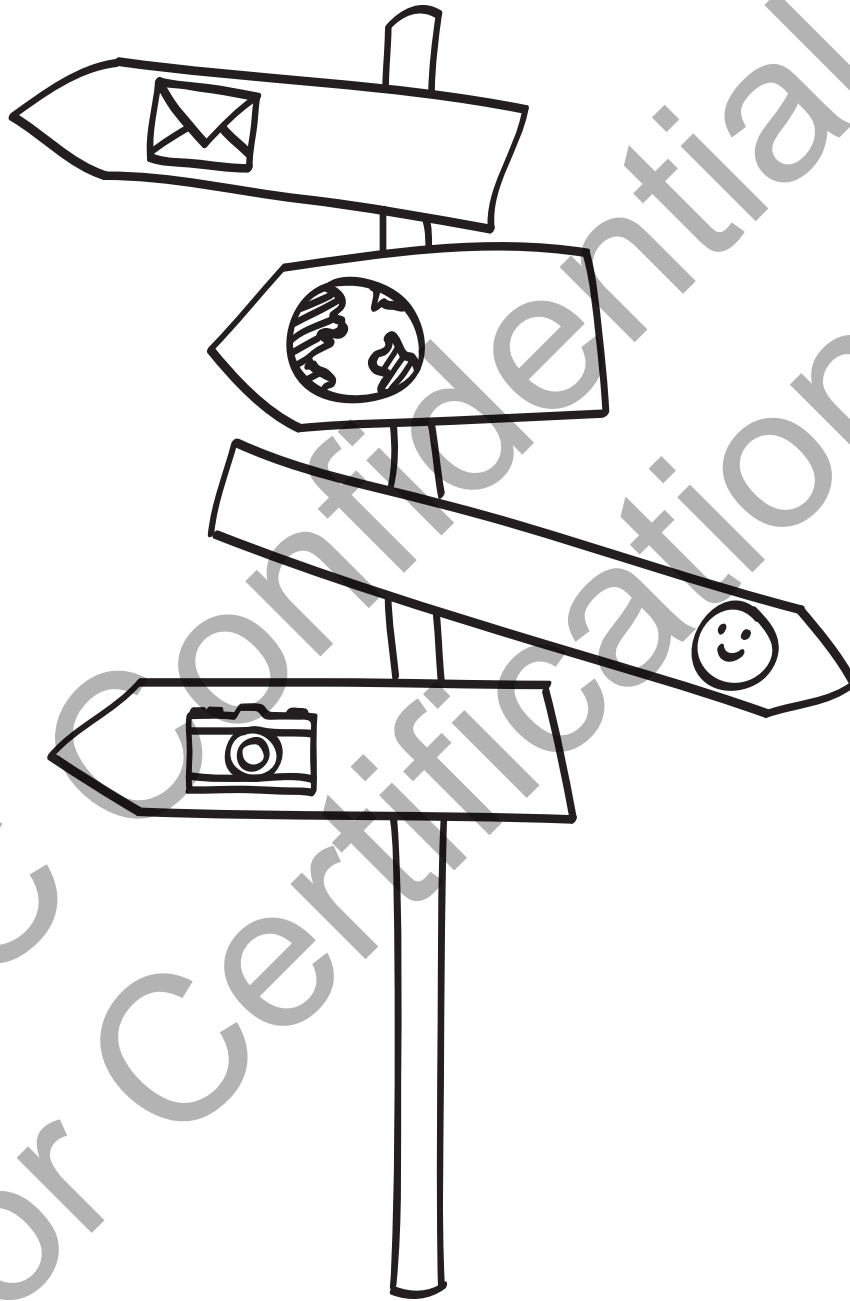

Contents

Getting started

Inside the box	6
Your phone	6
Back cover	8
SIM card	10
Battery	11
Switching the power on or off	13
Entering your PIN	13
Finger gestures	13
Setting up your phone for the first time	14
Start screen	14

Basics

Adjusting the volume	16
Sleep mode	16
Lock screen	17
Changing the ringtone	17
Changing the theme	18
Account setup	18
Switching between apps	19
Windows Marketplace	19

Phone calls

Making a call	20
Receiving calls	21
What can I do during a call?	21
Starting a conference call	22
Call history	23
Turning airplane mode on or off	24

People

Keeping in touch	25
Importing contacts from your SIM card	25
Adding a new contact	25
Filtering your contacts list	26
Merging contact profiles	26
Searching, editing or deleting	27
Contact groups	28
What is the Me card?	28
Posting to social networks	29
Filtering social updates	30

Messaging

Texting and chatting in one place	31
Sharing a picture in a message	32
Viewing and replying to a message	33
Managing conversations	33

Email

Adding your Windows Live account	35
Adding a POP3/IMAP email account	35
Adding a Microsoft Exchange ActiveSync account	36
Checking email	36
Sending email	37
Managing email messages	38
Changing email account settings	39

Camera

Camera basics	40
Taking a photo	41
Recording video	42
Camera flash doesn't turn on?	42
After capturing	43
Taking a panoramic photo	43
Taking continuous photo shots	44

Photos, videos, and music

About the Pictures hub	45
Adding a photo to your favorites	45
Changing the background on the Pictures hub	45
Sharing	46
Using Photo Enhancer	46
Playing music, videos, and podcasts	47
Listening to FM radio	47

Internet connections

Data connection	49
Wi-Fi	50

Search and Web browser

Searching the Web	52
Scanning codes, tags, and text	52
Opening and navigating web pages	54

More apps

Working with Notes	56
--------------------	----

Bluetooth

Connecting a Bluetooth accessory	59
Disconnecting a Bluetooth accessory	59

Trademarks and copyrights

HTC Confidential
for Certification only

Conventions used in this guide

In this user guide, we use the following symbols to indicate useful and important information:



This is a note. A note often gives additional information, such as what happens when you choose to do or not to do a certain action. A note also provides information that may only be applicable to some situations.



This is a tip. A tip gives you an alternative way to do a particular step or procedure, or lets you know of an option that you may find helpful.



This indicates important information that you need in order to accomplish a certain task or to get a feature to work properly.



This provides safety precaution information, that is, information that you need to be careful about to prevent potential problems.

HTC Confidential
for Certification Only

Getting started

Inside the box

You will find the following inside the box:

- Phone
- Battery (preinstalled)
- USB cable
- 3.5mm stereo headset
- Power adapter
- Quick start guide
- Safety and regulatory guide

Your phone

Front panel

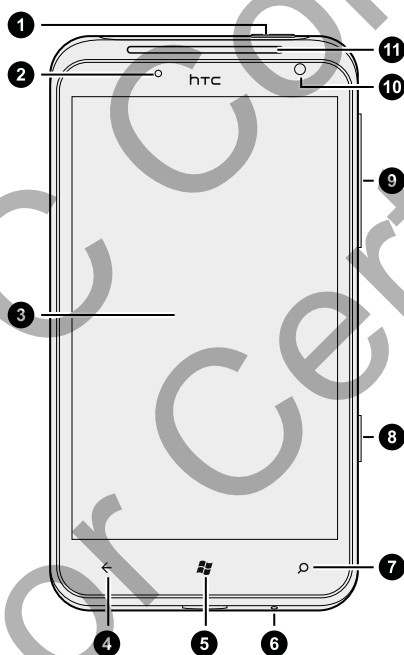

1. POWER
2. Notification LED
3. Touch screen
4. BACK
5. START
6. Microphone
7. SEARCH
8. CAMERA
9. VOLUME UP and VOLUME DOWN
10. Front camera
11. Earpiece

Back panel

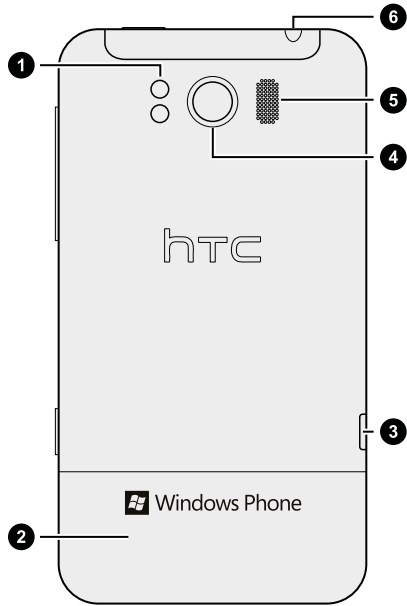

1. Dual LED flash
2. Bottom cover
3. USB connector
4. 8 megapixel camera
5. Speaker
6. 3.5mm headset jack

HTC Confidential
for Certification only

Back cover

Removing the back cover

Remove the back cover to access the battery compartment and SIM card slot.



Make sure to switch off your phone before removing the back cover.

1. Securely hold your phone facing up.
2. Press and hold the RELEASE button at the bottom of the phone, and then slightly lift the front panel.

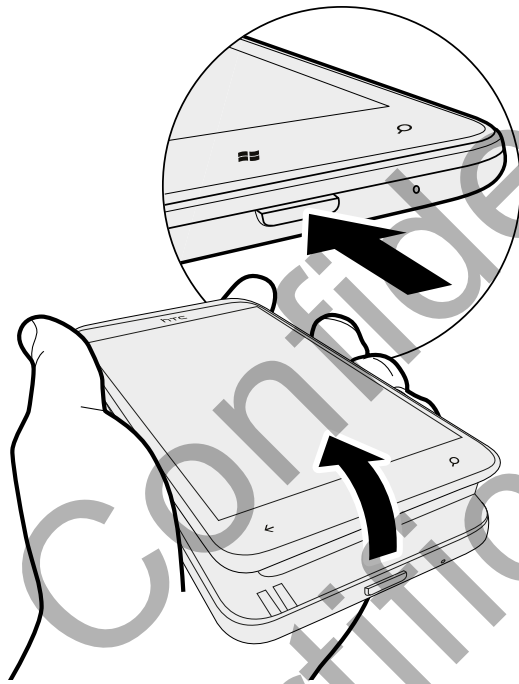

This detaches the bottom part of the phone from the back cover.

3. Gently pull the phone out of its back cover.

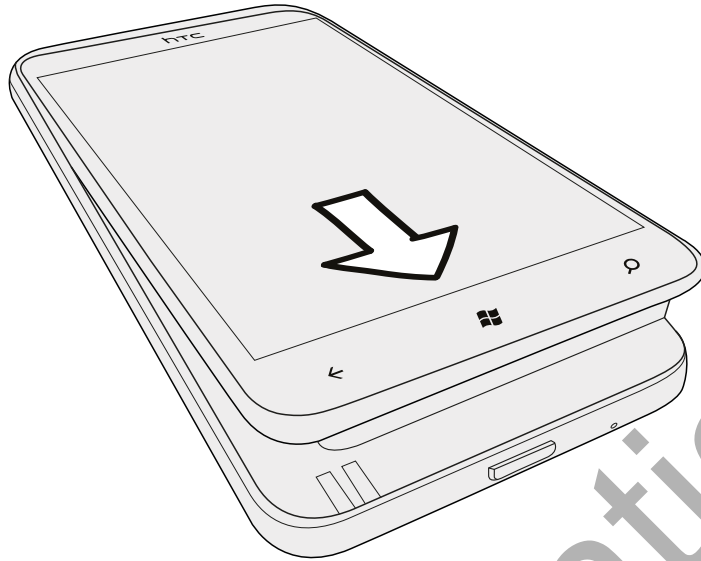

Replacing the back cover

T Your phone's antennas are placed underneath the back cover. To get the best signal for calls, data connection, and GPS navigation, be sure to secure the back cover tightly to the phone.

1. Securely hold the back cover with the exposed side facing up.
2. Insert the top part of the phone into the back cover.

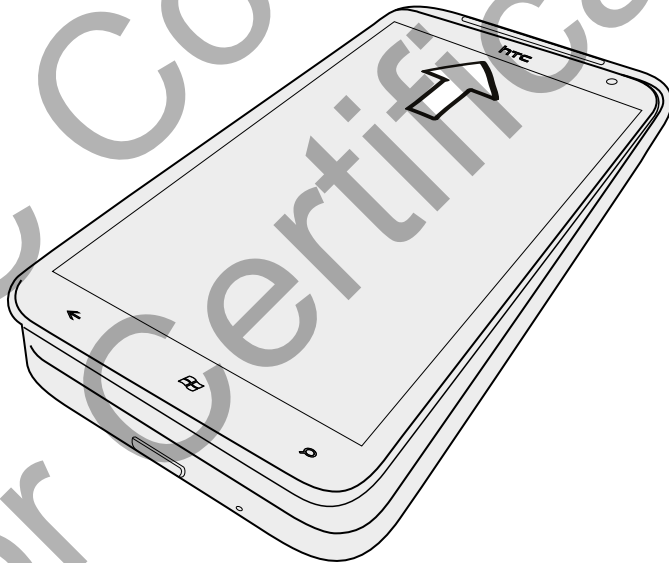

3. Press the phone down to lock the cover into place. You'll hear a click when the back cover is locked in place.

SIM card

The SIM card contains your phone number, service details, and memory for storing phonebook contacts and/or text messages.

Inserting the SIM card

1. Take the back cover off.
2. Take out the battery.
3. Insert the SIM card with its gold contacts facing down and its cut-off corner facing out.
4. Push the SIM card all the way in.

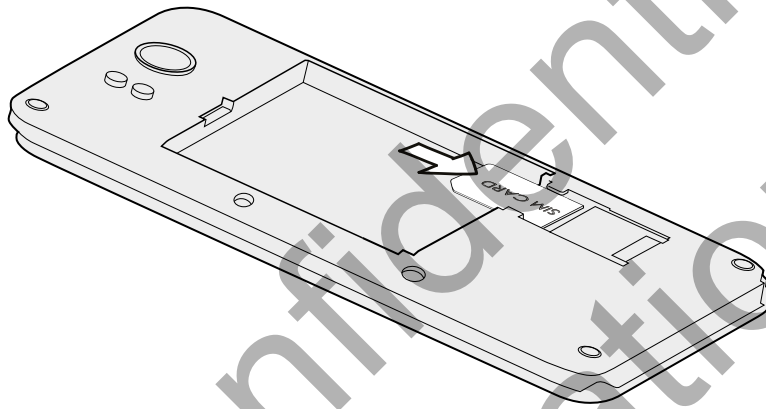

Removing the SIM card



Make sure to switch off your phone before removing your SIM card.

1. Take the bottom cover off.
2. Take out the battery.
3. With your thumb, slide the SIM card out from the SIM card slot.

Battery

Your phone uses a rechargeable battery. How long the battery can last before it needs recharging depends on how you use your phone. The features and accessories you use can affect battery life. For example, leaving your Bluetooth® connection always on uses more power. Long phone calls and frequent web browsing use up a lot of battery power. Also, consider your location: poor signal strength from your mobile network and extreme temperature make the battery work harder.

Removing the battery thin film

Before using your phone for the first time, you need to remove the thin film wrapped around the phone's battery.

1. Take the back cover off.
2. Take out the battery.
3. Remove the thin film around the battery.

Inserting the battery



Please use only original batteries that came in the box or replacements that we recommend.

1. Take the back cover off.
2. Insert the battery with its exposed copper contacts into the phone first. The exposed copper contacts should be on the left when you insert the battery.

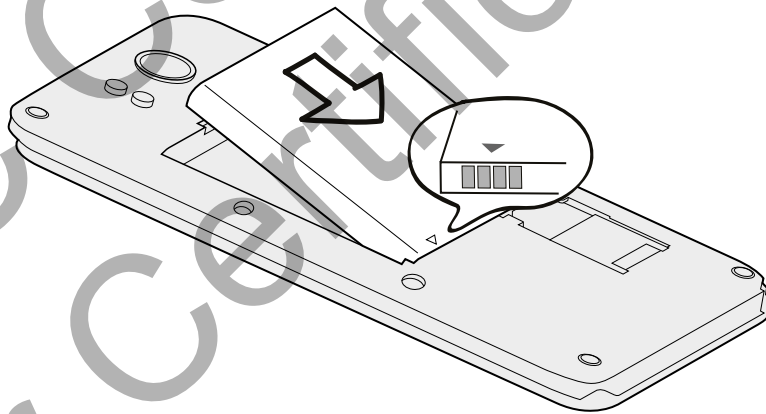

Removing the battery

1. Take the back cover off.
2. With your thumb or finger, lift the battery from the battery compartment.

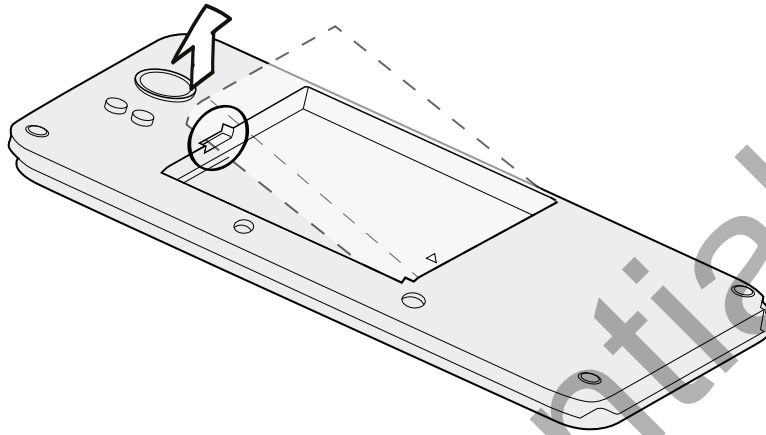

Charging the battery

Before you turn on and start using your phone, it is recommended that you charge the battery.



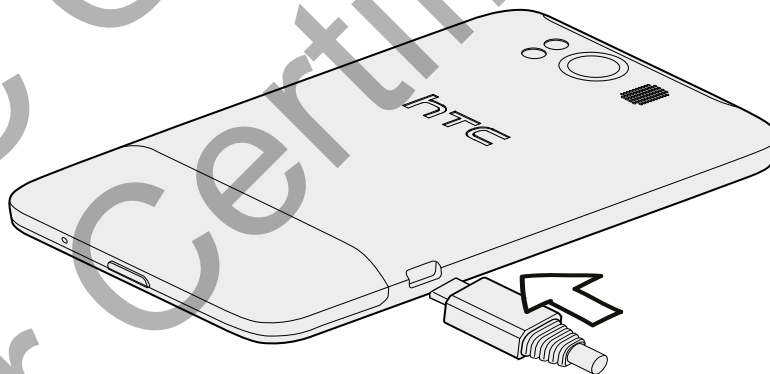

- Only the power adapter and USB cable provided in the box must be used to charge the battery.
- Do not remove the battery from the phone while you are charging it using the power or car adapter.

1. Insert the small end of the USB cable into the USB connector.



2. Insert the other end of the USB cable into the power adapter.
3. Plug in the power adapter to an electrical outlet to start charging the battery.

As the battery is being charged, the notification LED shows a solid orange light. The light turns to solid green when the battery is fully charged.

When you charge the battery and the phone is on, the charging battery icon  is displayed in the status bar. After the battery has been fully charged, the charging battery icon turns to a full battery icon .



As a safety precaution, the battery stops charging when it overheats.

Switching the power on or off

Switching the power on

Press the POWER button. Easy.



When you turn on your phone for the first time, you'll need to set it up.

Switching the power off

1. If the display is off, press the POWER button to turn it back on, then unlock the screen.
2. Press and hold the POWER button until you see the message, slide down to power off.
3. Swipe your finger down the screen.

Entering your PIN

Most SIM cards come with a PIN (personal identification number) set by your mobile operator.

If you're asked for a PIN, enter it and then tap **enter**.

Finger gestures

Tap	When you want to type using the keyboard, select items onscreen such as apps and settings, or press onscreen buttons, simply tap them with your finger.
Press and hold	To open the available options for an item (for example, a contact or link in a web page), simply press and hold the item.
Swipe or slide	To swipe or slide means to quickly drag your finger vertically or horizontally across the screen.
Drag	Press and hold your finger with some pressure before you start to drag. While dragging, don't release your finger until you have reached the target position.

Flick	Flicking the screen is similar to swiping, except that you need to swipe your finger in light, quicker strokes. This finger gesture is always in a vertical direction, such as when flicking the contacts or message list.
Rotate	On most screens, you can automatically change the screen orientation from portrait to landscape by turning your phone sideways. When entering text, you can turn your phone sideways to bring up a bigger onscreen keyboard.
Pinch	In some apps, like Pictures or the web browser, you can “pinch” the screen using two fingers (for example, thumb and index finger) to zoom in or zoom out when viewing a picture or web page.

Setting up your phone for the first time

When you switch on your phone for the first time, you'll be asked to set it up. Just follow the onscreen instructions and you'll be up and running in no time.

Be sure to sign in with your Windows Live® ID so you can use services such as Hotmail®, Marketplace, Xbox LIVE®, and more.

Start screen

Up front on the Start screen, you'll see live tiles that continuously update and show what's most personal to you. You'll see things like your photo album, how many new messages and email you have, and more.

- Simply swipe your finger up or down to scroll through the tiles.
- On the Start screen, tap  to access apps and settings.
- To return to the Start screen from any app or setting's screen, press .

Rearranging tiles

1. Press and hold the tile you want to move until it floats.
2. Drag the tile where you want it to go.
3. Keep rearranging until all tiles are where you want them.
4. When you're done moving tiles, tap anywhere onscreen or press .

Pinning items to the Start screen

You can pin just about anything you want to the Start screen: apps, pictures, songs, favorite websites, documents, and even contacts.

For example, when you pin a contact to the Start screen, you'll get all of that person's updates — feeds, email, text messages, and call notifications — right from that tile.

1. To pin something, press and hold it until a menu appears.
2. Tap **pin to start**.

Unpinning a tile

1. Press and hold the tile you want to remove.
2. Tap .

HTC Confidential
for Certification only

Basics

Adjusting the volume

1. Press the VOLUME UP or VOLUME DOWN button to make the volume bar appear.
2. Keep pressing until you get the volume level that you want.

Silencing your ringer

1. Press the VOLUME UP or VOLUME DOWN button to make the volume bar appear.
2. Tap .

If the **Vibrate** option is on in the settings, your phone will change to vibrate mode. If it's not, your phone will change to silent mode.

Sleep mode

Sleep mode saves battery power by putting your phone into a low power state while the display is off. It also stops accidental button presses when your phone is in your bag or pocket. You'll still receive messages and calls though.

Switching to Sleep mode

Briefly press the POWER button to turn off the display and switch to Sleep mode. Your phone also automatically goes into Sleep mode when it's idle for a while.

Waking up from Sleep mode

To wake your phone up manually, press the POWER button. You'll need to unlock the screen.



Your phone automatically wakes up when you have an incoming call.

Lock screen

Unlocking the screen

Swipe your finger up to unlock the screen or answer an incoming call.



If you've set up a password in the settings, you'll need to enter it to unlock the screen.

Changing your lock screen wallpaper

Browse the collection of preset wallpapers or choose from photos that you've taken with the camera.

1. On the Start screen, tap .
2. Tap **Settings** > **lock + wallpaper**.
3. Tap **change wallpaper** and then choose a preset wallpaper or a camera photo.
4. If the photo you selected is bigger than the allowable wallpaper size, crop the photo.

To crop, drag the photo and position the part that you want to be your wallpaper inside the crop box, and then tap .

Changing the ringtone

Choose from the preset ringtones.

1. On the Start screen, tap .
2. Tap **Settings** > **ringtones + sounds**.
3. Tap the **Ringtone** box.

4. Listen to a ringtone by tapping the play icon beside its name.
5. Tap the ringtone you want to use.

Changing the theme

Feeling a little blue? You can change the screen's background and accent colors to match your mood. The accent color you choose will appear in various places, like the tiles on the Start screen, app icons, on web links, in messages, and more.

1. On the Start screen, tap .
2. Tap **Settings** > **theme**.
3. Choose the background and accent colors that you like by tapping their respective boxes.

Account setup

Set up your online accounts such as your Windows Live, Outlook® (Exchange ActiveSync®), and Google® accounts so you can send and receive email.

Depending on the type of email account that you set up, other items such as contacts, calendar, or other information can appear on your phone as well. And when you sign in to your social networking accounts such as Facebook®, you'll also get your friends' status updates and see the pictures they've posted.

Setting up an account

1. On the Start screen, tap .
2. Tap **Settings** > **email + accounts**.
3. Tap **add an account**, and then tap the type of account you want to set up.
4. Enter your email address and password, and then tap **sign in**.

Syncing an account

If you're not seeing your most recent email messages or status updates in an account, you can manually sync the account to download them.

1. On the Start screen, tap .
2. Tap **Settings** > **email + accounts**.
3. Press and hold the account whose information you want to download, and then tap **sync**.

Deleting an account

1. On the Start screen, tap .
2. Tap **Settings** > **email + accounts**.
3. Press and hold the account you want to delete, and then tap **delete**.

Switching between apps

Many apps can run at the same time, and there's an easy way to switch between them all.

1. Press and hold  to see what apps are currently running.
2. Slide left or right across the screen to see all of the open apps, and then tap the one you want to use.

Windows Marketplace

In Windows® Marketplace, it's easy to download and purchase apps that fit your needs. A wide collection of free and paid apps is available, from everyday apps, powerful business apps, to fun games. You can also purchase songs.



From the Start screen, tap  > Marketplace and start shopping.

HTC Confidential
for Certification Only

Phone calls

Making a call

 Most SIM cards come with a PIN (personal identification number) set by your mobile operator. If you're asked for a PIN, enter it and then tap **OK**. If you enter the wrong PIN three times, your SIM card is blocked. Don't worry. Just contact your mobile operator and ask for the PUK (PIN Unblocking Key).



1. On the Start screen, tap .
2. Tap  to open the keypad.
3. Enter the number you want to call and then tap **call**.

To hang up, tap **end call**.

 If you're ready to hang up but the Phone dialer screen isn't displayed anymore, tap the notification at the top of the screen, and then tap **end call**.



Making an emergency call

In some regions, you can make emergency calls even if you don't have a SIM card installed or your SIM card has been blocked.

1. On the Start screen, tap .
2. Tap  to open the keypad.
3. Dial the emergency number for your locale and then tap **call**.

 If you enabled your password but forgot it, you can still make an emergency call without entering the password by tapping **emergency call** on the lock screen and then dialing the local emergency number.

Making an international call

1. On the Start screen, tap .
2. Tap  to open the keypad.
3. Press and hold the **0** key until the + sign appears.

The plus sign (+) shows that you're making an international call (instead of entering the international access number for the country you're in).

4. Enter the following on the keypad:
 - Country or region code
 - Area code (without the 0 at the beginning)
 - Phone number
5. Tap call.

Receiving calls

When you receive a phone call, the **Incoming call** screen appears.

Answering a call

- Tap **answer**.
- Or if the display is off and wakes up when you get a call, slide up from the bottom to unlock the screen first and then tap **answer**.

Rejecting a call

- Tap **ignore**.
- Or if the display is off and wakes up when you get a call, slide up from the bottom to unlock the screen first and then tap **ignore**.

Muting the ringing sound without rejecting the call

Do one of the following:

- Place your phone face down on a level surface.



If your phone is already facing down, it will still ring when there are subsequent incoming calls.

- Press the VOLUME UP or VOLUME DOWN button.
- Press the POWER button to silence the ringer and turn the display off.

What can I do during a call?

When a call is in progress, use the onscreen buttons to turn the speaker on, put the call on hold, and more.

Turning the speaker on during a call



To decrease potential damage to your hearing, do not hold your phone against your ear when the speaker is on.

On the call screen, tap **speaker**.

To turn the speaker off, just tap **speaker** again.

Putting a call on hold

On the call screen, tap **hold**.

To resume the call, tap **hold** again.

Switching between calls

If you're already on a call and accept another call, you can choose to switch between the two calls.

1. When you receive another call, tap **answer** to accept the second call and put the first call on hold.
2. To switch between the calls, tap the bar at the top of the screen.



3. To end the current call and return to the other call, tap **end call**.

Muting the microphone during a call

On the call screen, tap **mute**.

To turn the microphone back on, tap **mute** again.

Starting a conference call

Conference calling with your friends, family, or co-workers is easy. Make the first call (or accept a call), and then simply dial each subsequent call to add it to the conference.

- Make sure your SIM card is enabled with conference calling service. Contact your mobile operator for details.
- The maximum number of people you can have on a conference call varies by mobile operator.

1. Make a call to the first conference call participant.
2. When connected, tap **add call**, and then call the second participant.
The first participant is then put on hold.
3. When connected to the second participant, tap **merge calls**.
4. To add another participant, tap **add call**, and then call the person you want to invite.

5. When connected, tap **merge calls**.
6. To have a private conversation with someone in the call, tap **private**, and then tap the person's name or number.
 - Tap **merge calls** to merge the other people back and continue the conference call.
 - Or to end the private conversation, tap **end call**.

To end the conference call, tap **end call**.





Call history

Access the call history to check missed calls, your dialed numbers, and received calls.

Checking calls in the call history

1. On the Start screen, tap .
2. In the **history** list, you can:
 - Press and hold a number or contact name and delete it.
 - Tap a number or contact name to go to the **profile list** where you can choose to return the call, send a text message, save the number (if it's not yet stored in your contacts), and more.

Adding a new phone number from the call history to your contacts

1. On the Start screen, tap .
2. Tap the phone number that you want to save and then tap .
3. Tap  to create a new contact.
4. Edit the number if you need to, select the phone number type, and then tap .
5. Add the contact name and other information and then tap .



You can also save a phone number from the call history to an existing contact.

Clearing the call history

In the **history** list, you can:

Remove a number or name	Press and hold the number or name, and then tap delete item.
-------------------------	---

Clear the entire history	Tap  > delete all .
--------------------------	---

Turning airplane mode on or off

In many countries, you are required by law to turn off wireless devices while on board an aircraft. A quick way to turn off wireless functions is to switch your phone to airplane mode.

When you enable airplane mode, all wireless radios are turned off, including the call function, data services, Bluetooth, and Wi-Fi®. When you disable airplane mode, the call function is turned back on and the previous states of Bluetooth and Wi-Fi are restored.

1. On the Start screen, tap .
2. Tap **Settings** > **flight mode**.
3. Tap the **Status** switch to turn it on or off.

When airplane mode is on, you'll see the  icon in the status bar.

HTC Confidential
for Certification only

People

Keeping in touch

The People hub is more than just your address book. It's also where you can keep up with your social networks and stay in touch with the people you care about most.

1. On the Start screen, tap **People**.
2. Slide left and right across the screen to access your contacts list and see what's happening with your contacts.

all	Your contacts list. Just tap a contact to call, text, chat, write on a wall, or see that person's updates and pictures. Tap a group to send a group message and see updates and pictures from the group members
what's new	Here's where you can check out your contacts' latest updates, all handily rolled together from your various social network accounts.
recent	Here you'll see and get quick access to the contacts you've viewed or communicated with most recently.

Importing contacts from your SIM card

When you import contacts from your SIM card, they're automatically synced to your Windows Live account. They won't be deleted from the SIM card. If you haven't set up a Windows Live account, your contacts are saved to the memory.

1. On the Start screen, tap **People**.
2. Tap  > settings > import SIM contacts.

Adding a new contact



1. On the Start screen, tap **People**.
2. In the all contacts list, tap .
3. Tap new contact.
4. Tap the account you want to create the contact in.
5. Tap each item (such as name, phone, email) and then enter the information.

After entering information for each item, make sure to tap  to save it.

6. Tap **add photo** to assign a picture or use the camera to take a picture of your contact.
7. When you're done, tap  to save the new contact.

Filtering your contacts list

You can filter the list to show contacts only from the accounts you choose.

1. In People, tap  > **settings**.
2. Tap **filter my contact list**.
3. Select the accounts from which you want to show contacts, and then tap .

Merging contact profiles

In People, you might have two or more versions of the same contact. This is usually because you have the contact's profile on different social network or email accounts. In most cases, your phone will combine contact profiles automatically. For those that are not combined, you can link them manually.

1. Tap a contact that has one or more duplicate entries in the **all** contacts list.
2. Tap .
3. You can:
 - Under **suggested links** (if available), tap the one that you want to link to the contact.
 - Tap **choose a contact** and then tap one that's a duplicate entry.

Unlinking contact profiles

1. In the **all** contacts list, tap the contact that has linked profiles.
2. Tap the link icon that shows the number of links .
3. Under **linked profiles**, tap the one that you want to unlink.
4. Tap **unlink**.

Searching, editing or deleting

Searching for a contact

If your contacts list is especially long, search is probably the quickest way to find a contact.

1. In the **all** contacts list, tap .
2. In the search bar, enter the first few letters of the first or last name of the contact you're looking for.
Matching contacts are then displayed.
3. Tap the contact to view the person's contact information.

Editing a contact's information



Contacts from Facebook, Twitter™, or LinkedIn® cannot be edited. But you can add information, and then save it to a different account (such as Windows Live).

1. In the **all** contacts list, tap the contact whose information you want to change.
2. Tap .
3. If this is a linked contact (someone with multiple accounts that show up as one entry in your contacts list), tap the account you want to edit (for example, tap **edit Windows Live**).
4. Edit or add new information for the contact.
After entering new information for an item, remember to tap  to apply the changes.
5. When you're done, tap  to save the changes.

Deleting a contact



While you can't delete a Facebook, Twitter, or LinkedIn contact on your phone, you can delete contacts from other services. When you do this, the contact will be deleted both from your phone and from the online service where it's stored.

1. In the **all** contacts list, tap the contact you want to delete.
2. Tap  > **delete**.
3. If the contact is a linked contact (someone with multiple accounts), choose which account to remove the contact from.





You can also press and hold a contact and then tap **delete**.

Contact groups

Groups help you cut through social networking clutter to stay in touch with the people who matter most — family, friends, your bowling league. When you create a group, it shows up at the top of your contact list.

Tap it, and you'll see the group members and their social networking updates, along with options for group email, texting, and chat.



Creating a new group

1. On the Start screen, tap **People**.
2. In the **all contacts** list, tap .
3. Tap **new group**.
4. Enter a group name.
5. Tap **add contact** and then choose a contact to add to the group.
Repeat this to add more contacts to the group.
6. When you're done, tap .



Press and hold a group to pin it to the Start screen.

Editing a group

1. Tap the group you want to edit and then tap .
2. You can:
 - Change the group name.
 - Add more contacts to the group.
 - Remove someone from the group. Tap the member, and then tap **remove from group**.
 - Change the preferred contact number or email address for a member. Tap the member, tap the information you want to change, and then tap .

Deleting a group

Press and hold a group, and then tap **delete**.

What is the Me card?

The Me card is your profile. It's also your one-stop shop for social networking. You can access the Me card either from the Start screen or the People hub.

- On the Start screen, tap **Me**.
- On the Start screen, tap **People**. Tap your profile picture.

Here are some things you can do:

- Post a new message on your social networks.
- See, comment on, and like social network posts.
- Reply to or retweet updates on Twitter.
- Update your profile picture on Facebook and Windows Live.
- Set your chat status. Let other people see when you're available on instant messaging.

Posting to social networks



You can post messages to your social networks and comment or like other people's posts. You can also check in to share your location with friends.

Go to **Settings > email + accounts** to check what types of social network accounts can be set up on your phone.

Posting a message

1. On the Start screen, tap **Me**.
2. Tap **post a message** and then type your message.
3. If you have more than one social network account, tap the **Post to** text box, choose which accounts to post to, and then tap .
4. Tap .





Commenting or liking someone's post

1. On the Start screen, tap **People**.
2. Slide left or right to go to **what's new** so you can see recent posts from your contacts.
3. When you see a post you want to comment on or like, tap .
4. You can:
 - Tap the box that says **add a comment**, type your comment, and then tap .
 - Tap  to like (or tap  to unlike).

Checking in on Facebook or Windows Live

When you check in to a place, you share your location with your contacts by posting it on one or more of your social networks. You can find nearby locations, or you can add one yourself.

1. On the Start screen, tap **Me**.
2. Tap **check in**.

3. Do one of the following:
 - Tap a place in the list to check in from there.
 - If you don't see your location listed, tap  to make the app find your location. Type the name of the place where you're at, and then tap .
 - To search for a nearby place, tap , type the name of the place, and then tap .
4. Once you've found the place you want to check in from, choose each account you want to check in on.
5. Tap  to check in.

Filtering social updates

Flooded with updates? Try viewing posts from one social network at a time. Or you can hide the updates from one or more of your social networks.

- In People, slide left or right to go to **what's new**. Tap **all accounts**, and then tap the account you want to view posts from.
- Or tap  > **settings**, and then select **Only show posts from people visible in my contact list**.

Posts from the social networks you've filtered out of your contacts list will no longer be visible.



Messaging

Texting and chatting in one place

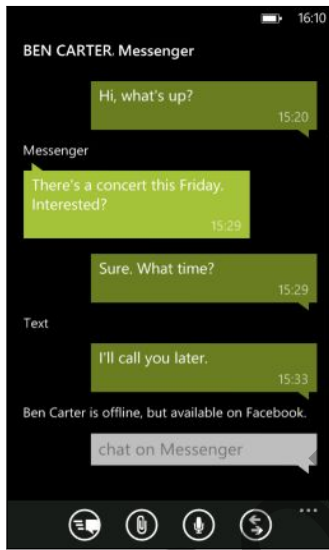
With the Messaging app, you can both text and chat in one place. Whether your friends and family are on their mobile phone or at their computer, you can send them text messages, Windows Live instant messages, or start a Facebook chat.



- To chat on Messenger, you need to set up your Windows Live account first.
- To chat over Facebook, you need to set up your Facebook account. Also, make sure to turn on Facebook chat in the Messaging app's settings.

1. On the Start screen, tap Messaging.
2. If you want to send an instant message over Windows Live Messenger, set your chat status first, if you haven't done so.
3. Tap .
4. Tap , choose a contact, and then tap the contact's phone number, Messenger, or Facebook to determine how you want to send the message. Repeat to add more recipients, and their names will be added automatically in the To box.
5. Tap the box that says type a message, and then enter your text.
6. Tap  to send it.

When adding recipients, you can also:

- Tap , and then select a contact group. The **Group text** option in the app's settings is turned on by default and can help keep replies in one thread when you're texting with a group of people. When it's turned on, replies are sent as multimedia messages instead of text messages.
- Begin typing a person's name in the **To** box, and then tap a matching contact name. The contact info you choose or enter determines if the message is sent as a text message or instant message over Messenger or Facebook. Repeat to add more recipients.
- Enter a mobile phone number or email address in the **To** box. To enter additional recipients, tap Enter after each one.

Setting your chat status

1. On the Start screen, tap Messaging.
2. Tap , and then tap a status.

For example, tap **available** to sign in so that your family and friends will see you online in their Windows Live Messenger.



You can also set your chat status from the Me card.





After you set your chat status and sign in, you'll see who's online in the Messaging app. Tap a contact to send the person an instant message.

Sharing a picture in a message

You can send a multimedia message by attaching a picture to a text message. You can also send a picture in an instant message on Windows Live Messenger or Facebook.





Your mobile operator might charge you extra to send multimedia messages, and this service must be available with your current data plan.

1. On the Start screen, tap Messaging.
2. Tap  to create a new message.
3. In the **To** box, fill in the recipient's name, mobile phone number, or email address.
4. Tap . You can:
 - Select an existing photo to attach to your message.
 - Or tap  to take a photo and attach it.
5. Enter your message.
6. Tap  to send.

Viewing and replying to a message

When you receive a new message, you'll hear a notification sound (if set) and see the message briefly display at the top of the screen.



1. To open and read the message, you can:
 - Tap the message bar at the top of the screen.
 - Or open the Messaging app to access and read the message.
2. Tap , and then choose whether to reply with a text, Messenger, or Facebook message.
3. Enter your reply, and then tap .

Copying and pasting a message

You can copy a previous message and paste it to the new message you're composing.

1. In the **threads** list, tap a contact (or phone number) to display the exchange of messages with that contact.
2. Press and hold the message you want to copy, and then tap **copy**.
3. Tap the text box where you're composing your new message.
4. To paste the copied message, tap .

Managing conversations

Forwarding a message

1. In the **threads** list, tap a contact (or phone number) to display the exchange of messages with that contact.
2. Press and hold the message you want to forward, and then tap **forward**.
3. Fill in the recipient.
4. Tap  to send.

Deleting a message

1. In the **threads** list, tap a contact (or phone number) to display the exchange of messages with that contact.
2. Press and hold the message you want to delete, and then tap **delete**.

Deleting a whole conversation

In the **threads** list, press and hold a contact (or phone number) whose messages you want to delete, and then tap **delete**.

HTC Confidential
for Certification only

Email

Adding your Windows Live account

When you first set up your phone, you're asked to sign in with your Windows Live ID. If you didn't sign in then or if you have more than one Windows Live ID, go to the settings to set up your primary Windows Live ID or additional Windows Live IDs.

1. On the Start screen, tap .
2. Tap **Settings > email + accounts**.
3. Tap **add an account > Windows Live**.
4. Enter your Windows Live ID and password, and then tap **sign in**.

Your Windows Live email, contacts, calendar, photos, and feeds will be synced to your phone.



- The first Windows Live account that you set up can't be deleted from your phone.
- If you set up additional Windows Live IDs, photos from these accounts won't be synced to your phone.

Adding a POP3/IMAP email account

1. On the Start screen, tap .
2. Tap **Settings > email + accounts**.
3. Tap **add an account**.
4. Choose the type of email account that you want.
If you don't see it in the account list, tap **other account**.
5. Enter your email address and password, and then tap **sign in**.

Your phone then looks for your account settings, completes the setup, and syncs information from your account.

If what you've set up is your Google Account, your phone will sync and download your Gmail™, contacts, and calendar from your account.

If you've set up other POP3 or IMAP accounts, your phone will sync email from those accounts.



If your phone can't find your account settings, go to the advanced setup to enter the incoming and outgoing server and other settings manually. You'll need to get these information from your email provider.

Adding a Microsoft Exchange ActiveSync account

1. On the Start screen, tap .
2. Tap **Settings > email + accounts**.
3. Tap **Outlook**.
4. Enter your email address and password, and then tap **sign in**.

If your account settings are found, wait for your phone to finish syncing with your work email, contacts, and calendar.



If your account settings can't be found, follow the onscreen instructions to enter your Exchange ActiveSync account settings manually. Ask your Exchange Server administrator for these settings.

Checking email

After you've set up your email accounts, a new tile for each account will be added to the Start screen.

1. To open an email account, tap its tile on the Start screen.



If you don't see the tile, tap  on the Start screen, and then tap your email account in the apps list.

2. In the **all** email list, scroll up or down to skim through your email messages.

Email messages are neatly grouped into conversations. If there were back and forth replies to an email, tapping that email expands and shows its series of messages.

3. Tap an email message to open and read it.



If you have a long email list, you can also slide left or right to skim through unread, flagged, or urgent email only.

Replying or forwarding email

1. Open and read the email message.
2. Tap .
3. Choose whether to reply only to the sender, reply to all, or forward the email.

Linking inboxes as one

To check your email from all your accounts just in one place without having to switch to different accounts, you can link your inboxes as one.

1. Tap  > **linked inboxes**.
2. Under **other inboxes**, tap one or more email accounts that you want to combine to your unified inbox.

The default name for your unified inbox is **Linked inbox**.



Tap **rename linked inbox** if you want to change the name of your unified inbox.



3. Press  to return to your inbox. You'll now see just one inbox containing all your email from your different accounts.



Next time you want to check your email, tap **Linked inbox** on the Start screen or in the apps list.

Unlinking an inbox

1. Tap  > **linked inboxes**.
2. Under **this inbox**, tap the email account you want to remove from the unified inbox.
3. Tap **unlink**.

Sending email

1. Open the email account that you want to use for sending your email.
2. Tap .
3. Fill in one or more recipients. In the **To** field, you can:
 - Tap  to choose a contact. Tap it again to add more.
 - Start typing a person's name or email address. If there are matches found from your stored contacts as you type, they will be listed. Tap the one that you want.
4. Enter the subject and compose your message.

5. To attach a picture, tap .
6. When you're ready to send your email, tap .



- When entering several email addresses manually, separate them with a semicolon.
- To send a carbon copy (cc) or blind carbon copy (bcc), tap  > **show cc & bcc** and add other recipients.

Setting the priority for an email message

You can set the priority for an email message before sending it.

1. While composing the message, tap  > **priority**.
2. Select the priority for the message.

Saving or discarding the email





1. While composing your email, tap .
2. Choose whether to save your email as a draft or delete it.

Resuming an email draft

1. While in the email list, tap  > **folders** > **drafts**.
2. Tap the draft email to edit it.
3. Send the email.

Managing email messages

Deleting, moving, flagging, or marking several email messages

1. Tap .
2. To quickly select all email messages in a conversation, select the top one (the one that shows the subject and number of messages).
Or to select individual email messages, tap their respective check boxes.
3. Choose what you want to do with the selected messages.
 - Tap  to delete.
 - Tap  to move them to another mail folder.
 - Tap  and choose whether to flag or mark the messages as read or unread.



You can also just tap on the far left of an email to select the email first. Check boxes will then appear and you can select more email messages.



Deleting, moving, flagging, or marking one email

1. Press and hold a conversation or a single message.
2. On the options menu, choose what you want to do with the whole conversation or the single message.

Switching to another mail folder

1. Tap  > **folders**.
2. Tap **show all folders** to see all the available mail folders.
3. Tap the mail folder whose email messages you want to view.

Changing email account settings

1. On the Start screen, tap the email account that you want.
2. Tap  > **settings**.
3. Tap **sync settings** to choose how often to download items or change the items that you want to sync.
4. Choose if you want a signature to appear in your sent email.
5. Tap .

HTC Confidential only
for Certification

Camera

Camera basics

Whether traveling for business or fun, enjoy taking photos and videos with the camera.

- From the Start screen, tap  > Camera to open the Camera app.
- Or press the CAMERA button.

The first time you open the Camera app, you'll be asked whether you want to let it use your location. If you allow this, location information will be stored in your captured photos and you'll be able to know where they were taken. When you share your photos, other people can also see that information.







Did you know you can open the Camera app even if the display is off or locked? Just press and hold the CAMERA button.

Viewfinder screen

You'll find the following onscreen controls on the Viewfinder screen:



	Photo/Video mode switch
	Switch to front or rear camera
	Zoom control
	Settings
	Go to viewer



Flash and other settings are not available when you're using the front camera.

Zooming

Before taking a photo or video, you can first use the onscreen zoom control to zoom in or out of your subject.

Simply tap + or - on the screen to zoom in or out.

Changing settings

1. Tap  to choose from various settings such as flash mode, resolution, effects, and more.
2. To save your changed settings, tap **Save settings** after you make the change. Otherwise, the camera will return to the default settings the next time you use it.



When you go to **settings > applications > pictures + camera** from the Start screen, you'll find more settings that can change how the CAMERA button functions, where to share photos and videos, and more.

Taking a photo

1. Open the Camera app.
2. Tap 
 - Tap one of the flash icons to set the camera to auto flash, flash on, or flash off.
 - Choose the resolution and other settings you want to use.
3. Hold your phone steady, either vertically (portrait view) or horizontally (landscape view).



If you're taking a photo of a group of people, the camera will automatically recognize faces and adjust the focus. You'll see boxes on people's faces.

4. Before taking the photo, you can zoom in and out first on your subject.
5. To take the photo, you can:
 - Press the CAMERA button halfway down to focus, and then press the button all the way down to take the photo. The camera will auto focus on what's in the center of the screen (or on people's faces) and take the shot.
 - Or tap any point on the screen to focus there and take the photo. The camera will auto focus and apply auto exposure on what you tapped.

The photo will be saved in the **Camera Roll** album of the Pictures hub.

Recording video

You can record videos in either portrait or landscape orientation. For the best viewing experience of your videos, the most ideal way is to capture them in landscape.

1. Open the Camera app.
2. Tap  to switch to video mode. You'll see a video counter on the screen.
3. Tap .
 - Tap one of the light bulb icons to switch the camera light on or off during recording.
 - Choose the resolution and other settings you want to use.
4. Before recording, you can zoom in and out first on your subject.
5. Press the CAMERA button to start recording.

While recording, the camera will always auto focus on what's in the center of the screen if **Continuous Focus** is enabled in the settings.
6. To stop recording, press CAMERA again.

The video will be saved in the **Camera Roll** album of the Pictures hub.

Camera flash doesn't turn on?

Camera flash drains the battery. To save battery power, the camera disables the flash (even when you have set the flash mode to auto flash or flash on) when one of the following occurs:

- **You have an incoming call.**



The flash will be disabled temporarily when you have an incoming call. After the call ends, you'll be able to use the flash again.
- **Battery level reaches 20% or lower.**

Recharge the battery so that the camera can have enough battery power to use the flash.
- **Cold weather may lower battery performance which affects the flash.**

To make sure the camera has enough battery life to power up the flash, keep your phone warm. When not in use, put the phone inside your jacket to keep it warm, and try to avoid sudden temperature changes that may affect battery performance.

After capturing

After taking a photo or video, you can view it and others you've captured without leaving the Camera app. You can also choose what to do with a photo or video, such as upload or send it.

1. While on the Viewfinder screen, press . Or slide your finger on the screen. You'll see the photo or video you last captured.
2. If it's a photo, double-tap or pinch and stretch if you want to zoom in and out of a photo. If it's a video, just tap the play icon to view the recording.
3. Tap  to see options of what you can do with your photo or video. You can choose to delete it, upload to Facebook or SkyDrive®, and more.
4. Pinch the screen to change to filmstrip view. You can then easily flick left or right onscreen to browse through your photos and videos.
5. To continue capturing, slide your finger left if you're holding the phone horizontally (or slide up if holding the phone vertically) until you're back on the Viewfinder screen.

Taking a panoramic photo

Whether it's the Golden Gate Bridge or the Eiffel Tower, you can capture anything wide or tall in a single photo. The camera lets you take up to three shots to create your panoramic photo.

 When you're using panorama mode, zooming, flash, touch focus, and touch capture are not available. Settings such as brightness and exposure are set to auto.



1. While on the Viewfinder screen, tap  > **Panorama Shot**.
2. While pointing the camera on your subject, hold your phone steady. Align the dotted line with the solid line onscreen.

3. When you're ready to capture the first shot, press the CAMERA button.
A message then appears, guiding you in what direction you should move to take the next shot. As you move, directional arrows appear.
4. Using the directional arrows, dotted line, and circles onscreen as your guidance, pan left or right in landscape view (or pan up or down in portrait view). When the ring reaches and centers on the next circle, the camera automatically takes the shot.
5. Do the same thing to take the last shot.

The camera stitches your shots into a single photo.



Press the CAMERA button or tap  anytime if you want to stop taking more shots. The camera stitches only those shots that were captured.

Tap  to view the panoramic photo you've just taken. If you want to delete it and start over, tap  > **delete**.

Press the  button to quit panorama mode and resume the normal photo mode.

Taking continuous photo shots

Is your subject in motion? Use burst mode to take consecutive shots.

1. While on the Viewfinder screen, tap  > **Burst Shots**.



When you're in this mode, flash and touch focus are not available. Other settings such as brightness and exposure are set to auto.

2. Point the camera and focus on your subject.
3. When you're ready to take the photo, press the CAMERA button.

The camera takes five consecutive shots of your subject.



Press the  button to quit burst mode and resume the normal photo mode.

Photos, videos, and music

About the Pictures hub

On the Pictures hub, you can view the photos and videos you captured with the camera, flip through online albums (from Facebook and SkyDrive), or catch up with your friends' latest snapshots.

1. On the Start screen, tap .
2. Tap **Pictures**.
3. Slide left or right across the screen and you'll see the following:

picture collection	You can view your pictures and videos by album or date, or see what's on the camera roll. You can also check out your friends' online albums or your own.
favorites	See up to 8 pictures you've tagged as favorites, or tap see all to view the rest. You can even pin your favorites to the Start screen for one-tap access.
what's new	Here you'll find the latest pictures your social networking friends have uploaded. Tap one to post a comment or tag a face.

Adding a photo to your favorites

Some snapshots are so great you just can't get enough of them. To get to these photos quicker, add them to your favorites.

1. On the Pictures hub, find a photo you like and tap to open it.
2. Press and hold the photo, and then tap **add to favorites**.



Before you can add a photo from an online album to your favorites, you need to save it first to your phone. Open the photo, and then tap  > **save to phone**.

Changing the background on the Pictures hub

You can pick out any photo to use as the background on your Pictures Hub — even photos from online albums. Better yet, your Pictures hub can also show a rotating selection of your favorite pictures.

1. On the Start screen, tap .
2. Tap **Pictures**.

3. Tap .
4. You can:
 - Choose a photo to use as the background. Tap **choose background**, select a photo, and crop it.
 - Tap **shuffle background** to just shuffle photos that are tagged as favorites.



If you have the Pictures tile on your Start screen, the background you choose will also show up in the tile.

Sharing

Share photos or videos with your friends and loved ones. You can send a photo in a multimedia message. Or send any photo or video by email. You can also upload a photo or video to your social networking sites.



- Make sure you've signed in to your social networking accounts before uploading.
- You can share photos on SkyDrive, Facebook, or Twitter.
- You can share videos on SkyDrive or Facebook.

1. On the Pictures hub, find and open the photo or video you want to share.
2. Tap  > share.
3. Choose how to send it or where you want to share it.

Using Photo Enhancer

Photos need a bit of touch-up? Improve photos taken in poor lighting conditions with one tap. Or apply special effects to give your photos a unique touch.



This app is preinstalled in most phones. If you don't see it on your phone, open the HTC Hub and download this free app.

1. On the Start screen, tap .
2. Tap **Photo Enhancer**.
3. Tap **choose picture**.
4. Open the album where the photo you want to edit is located, and then tap the photo.
5. To see what's available, slide left or right across the thumbnails of the various effects.

6. Tap an effect to apply it to your photo.
7. Tap  to save.



The enhanced photo will be saved in another album called **Saved Pictures**.

Playing music, videos, and podcasts

Listen to music, catch up on your favorite podcasts on your commute, or enjoy a movie on your next flight.



If you don't have music, videos, or podcasts yet, connect your phone to your computer and use the Zune® software to sync them first to your phone.

1. On the Start screen, tap .
2. Tap **Music + Videos**.
3. Under **zune**, tap **music**, **videos**, or **podcasts**.
4. Slide left or right to different categories (such as artists or albums when browsing through music).
5. Tap the item that you want to play. The playback screen opens and starts to play the music, video, or podcast.
6. Use the onscreen controls to control the playback.
7. When you're done, keep pressing  until you're back on the main screen of the **Music + Videos** hub.

Listening to FM radio

Tune in to your favorite station or catch the news.



You need to connect a stereo headset first to the audio jack of your phone. Your phone uses it as the FM radio antenna.

1. On the Start screen, tap .
2. Tap **Music + Videos**.

3. Under **zune**, tap **radio**.
4. Press the VOLUME UP or VOLUME DOWN button to show the mini playback controls. Use them to go to the next or previous station, pause, or resume the radio.



When choosing stations, you can also:

- Swipe left or right to go to a radio station.
- If you flick instead of swipe, the radio jumps to the strong stations and skips over weak stations.

Adding or removing a favorite station

To quickly tune into radio stations that you like, add them to your favorites.

1. Tune in to a station.
2. Tap  to add the station as a favorite. To remove from your favorites, tap .

Listening to a favorite station

1. If you've added some favorite stations, tap  to see them.
2. Tap a favorite station in the list.

HTC Confidential
for Certification only

Internet connections

Data connection

When you turn on your phone for the first time, it will be automatically set up to use your mobile operator's data connection (if the SIM card is inserted).

Turning the data connection on or off



Turning your data connection off can help save battery life and save money on data charges. However, if you don't have data connection turned on and you're also not connected to a Wi-Fi network, you won't receive automatic updates to your email, social network accounts, and other synchronized information.

1. On the Start screen, tap .
2. Tap **Settings** > **mobile network**.
3. Tap the **Data connection On/Off** switch.

Adding a new access point

An access point name (APN) is the address your phone uses to connect to the data network. By default, APNs are set automatically when your phone is first set up. If your cellular data connection isn't working, try entering a new APN based on your location and mobile operator.

 Before adding, have the access point name and settings (including username and password if required) from your mobile operator ready.

1. On the Start screen, tap .
2. Tap **Settings** > **mobile network**.
3. Tap **add apn**.
4. Enter the APN and other required settings.
5. Tap  to save.

Enabling data roaming

Connect to your mobile operator's partner networks and access data services when you're out of your mobile operator's coverage area.



Using data services while roaming will be costly. Check with your mobile operator for data roaming rates before you use data roaming.

1. On the Start screen, tap .
2. Tap **Settings > mobile network**.
3. Tap **Mobile networks**, and then select the **Data roaming** check box.
4. Tap the **Data roaming options** box, and then tap **Roam**.

Wi-Fi

To use Wi-Fi, you need access to a wireless access point or "hotspot". The availability and strength of the Wi-Fi signal will vary depending on objects, such as buildings or simply a wall between rooms, the Wi-Fi signal has to pass through.

Connecting to a Wi-Fi network

1. On the Start screen, tap .
2. Tap **Settings > Wi-Fi**.
3. Tap the **Wi-Fi networking On/Off** switch to turn Wi-Fi on.
You'll then see a list of available wireless networks.
4. Tap the wireless network you want to connect to.
 - If you selected an open network, your phone will automatically connect to the network. (Some Wi-Fi networks, such as ones you might find in coffee shops, restaurants, hotels, or elsewhere, may require you to enter a password in your web browser before you can connect.)
 - If you selected a secured network, enter the required password and then tap **done**.

When you're connected to a wireless network, the Wi-Fi connected icon  appears in the status bar and shows you the signal strength (indicated by the number of bands that light up).



The next time you connect to the same secured wireless network, you won't be asked to enter the password or other security information again, unless you do a factory reset.

Connecting to a hidden Wi-Fi network

A Wi-Fi network might be hidden, which means the network name isn't broadcasted. In this case, it won't appear in the list of available networks on the **Wi-Fi Settings** screen and a notification won't appear when the network is in range. To connect to a hidden Wi-Fi network when it's in range, you'll need to enter the network name and password.



The network name and password are case sensitive.

1. On the Start screen, tap .
2. Tap **Settings** > **Wi-Fi**.
3. Make sure that Wi-Fi is turned on.
4. Tap **advanced**.
5. Tap , enter the network name, and then tap **add**.
6. On the **Sign in** screen, enter the password, and then tap **done**.

Disconnecting from a Wi-Fi network

1. On the Start screen, tap .
2. Tap **Settings** > **Wi-Fi**.
3. Tap the **Wi-Fi networking On/Off** switch to turn Wi-Fi off and disconnect from the wireless network.

You can also press and hold the network name and then tap **delete** to disconnect. But this removes the security settings if it's a secured network, and you'll need to enter them again next time you reconnect to this Wi-Fi network.



Search and Web browser

Searching the Web

Just press the search button on your phone to search the Web using Bing®.



Some web search features may not be available in certain countries.

1. Press . The Bing Search screen opens.
2. Tap the search box, enter what you want to search for, and then tap  on the keyboard.
3. Slide left or right across the screen to narrow or broaden the search results to web, local, or images.



Under the **web** results, scroll up or down to see different kinds of results, such as news, related searches, apps, products, flight status, and more. The types of results displayed will depend on what you've entered and searched for.

Scanning codes, tags, and text



Want to scan something? Using Vision search, you can use the camera to scan lots of things you see, and then search for those things on the Web.

You can scan QR Codes and Microsoft® Tags that you see in magazines, online, on signs, or anywhere else. You can also scan text to search, have it translated, and paste scanned text into a message.





The items you can scan and search for vary by country or region.

Scanning a QR Code

1. Press .
2. On the Bing Search screen, tap .
3. Point the camera at the QR Code you want to scan.
You'll then see the Results screen.
4. Tap the result to get info about the QR Code. The information that appears depends on the QR Code and can be a message, contact info, email address, website, or phone number.

Scanning a Microsoft Tag

1. Press .
2. On the Bing Search screen, tap .
3. Point the camera at the Microsoft Tag you want to scan.
You'll then see the Results screen.
4. Tap the result to get info about the Tag.

Searching by scanning a barcode, book, CD, or DVD cover

1. Press .
2. On the Bing Search screen, tap .
3. Point the camera at the barcode, book cover, CD cover, or DVD cover you want to scan.
You'll then see the Results screen.
4. Tap the result to get info from the Web about the item you've just scanned.

Searching by scanning text





You can scan text and then search the Web using the scanned words. Or you can have the text translated.

1. Press .
2. On the Bing Search screen, tap .



- Point the camera at the text you want to scan, and then tap **scan text**.
- You can:

Search the Web.	Tap each of the squares that contain the words you want to search for, and then tap search .
See a translation for text that's recognized.	Tap translate , and then choose a language.

Copying and pasting scanned text

- Press .
- On the Bing Search screen, tap .
- Point the camera at the text to scan, and then tap **scan text**.
- Tap  > **copy all**.
- Open the file, app, or message where you want to paste the text.
- Tap where you want to paste the text.
- In the text suggestion bar above the keyboard, tap the paste icon .

Selecting from previous image search results

- Press .
- On the Bing Search screen, tap .
- Tap **history**.
- On the Vision history screen, tap a past result.

Opening and navigating web pages



Internet Explorer® Mobile makes it quick and easy to surf the Web on the go. By using tabs, you can open multiple web pages and switch between them quite easily.

Opening a web page

- On the Start screen, tap **Internet Explorer**.
- Tap the address bar, and then enter a web address. As you type, Internet Explorer will suggest possible matches.
- If you see the site you're looking for, tap it. Or tap  on the onscreen keyboard.

Using tabs to open multiple web pages

You can open up to six separate browser windows (called "tabs" in Internet Explorer) simultaneously. Tabs make it easy to hop between sites.

1. In Internet Explorer, tap  > tabs.
2. Tap  to open a new tab. A blank browser screen then opens.
3. On the new browser screen, go to a website that you want.

Switching between tabs

1. In Internet Explorer, tap  > tabs.
2. Tap the thumbnail that shows the website you want to open.

If you no longer need to view a website, you can close the tab by tapping .

HTC Confidential
for Certification only

More apps



Working with Notes

Note to self - pick up flowers for wife before going to dinner. Use the Notes app to create short reminders to yourself.



This app is preinstalled in most phones. If you don't see it on your phone, open the HTC Hub and download this free app.

Creating a note

1. On the Start screen, tap .
2. Tap Notes.
3. To create a new note, tap .
4. Enter your note and then tap .



You can also tap the sticky note image at the lower left of the Notes screen to create a new note.

HTC Confidential for Certification only

Browsing through your notes

- You can browse your last few notes on the bulletin board.

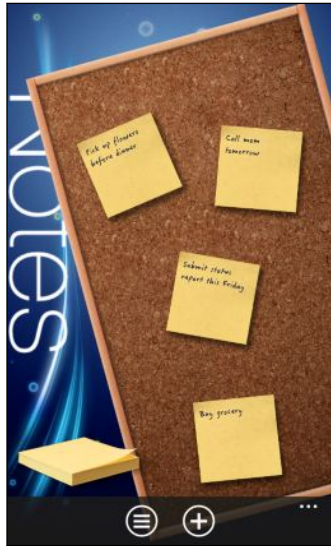

- Or tap  to see all your notes in list view. Swipe up or down to scroll through your notes.

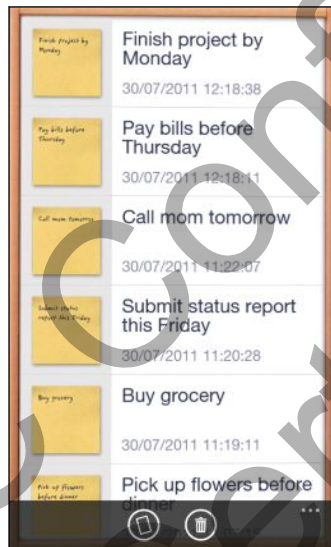

You can also swipe left or right to switch between the bulletin board and list view.

Moving a note around the bulletin board

- Press and hold a note until it floats.
- Drag the note to where you want to put it on the bulletin board, and then release it.



Editing a note

1. On the bulletin board or in list view, tap a note to open it.
2. Tap the note again to edit it.
3. Tap  to save your changes.

Deleting a note

1. On the bulletin board or in list view, tap the note you want to delete.
2. Tap .

Deleting multiple notes

1. Tap  to go to list view.
2. Tap .
3. Select the notes you want to delete, and then tap **done**.

HTC Confidential
for Certification only

Bluetooth

Connecting a Bluetooth accessory

You can connect a variety of Bluetooth accessories such as headsets, car kits, or speakers to your phone.



- To listen to music, use an accessory such as a Bluetooth stereo headset that supports the A2DP profile.
- Before connecting, make sure to set the accessory to discoverable. To find out how, please refer to the accessory's manual.

1. On the Start screen, tap .
2. Tap **Settings** > **Bluetooth**.
3. Tap the **On/Off** switch to turn Bluetooth on. Your phone becomes discoverable. It also automatically searches for Bluetooth devices within range.
4. Tap the name of the accessory that you want to pair with your phone.
5. If auto pairing fails, enter the pairing code supplied with the accessory.

When the accessory is connected to your phone, the Bluetooth icon appears on the status bar. You can also check the connection status shown below the accessory name on the **Bluetooth Settings** screen.



Turn Bluetooth off when not in use to save battery power, or in places where using a wireless device is prohibited, such as on board an aircraft and in hospitals.

Disconnecting a Bluetooth accessory

1. On the Start screen, tap .
2. Tap **Settings** > **Bluetooth**.
3. Tap the accessory to disconnect it.

To reconnect, just tap the accessory again.

Unpairing

If you no longer want to use a connected accessory with your phone, you can unpair and remove it from your phone.

1. On the Start screen, tap .
2. Tap **Settings** > **Bluetooth**.
3. Press and hold the name of the accessory, and then tap **delete**.

HTC Confidential
for Certification only

Trademarks and copyrights

©2011 HTC Corporation. All Rights Reserved.

HTC, the HTC logo, the HTC quietly brilliant logo, and HTC Footprints are trademarks of HTC Corporation.

Microsoft, Windows, Windows Phone, ActiveSync, Bing, Excel, Hotmail, Internet Explorer, OneNote, Outlook, PowerPoint, SkyDrive, Windows Live, Windows Phone Marketplace, Windows Media, Windows Vista, Xbox LIVE, and Zune are either registered trademarks or trademarks of Microsoft Corporation in the United States and/or other countries.

Google, the Google logo, Gmail, and YouTube are trademarks of Google Inc.

The *Bluetooth*[®] word mark and logos are registered trademarks by Bluetooth SIG, Inc.

Wi-Fi[®] is a registered trademark of the Wireless Fidelity Alliance, Inc.

Facebook is a trademark of Facebook, Inc.

Twitter is a trademark of Twitter, Inc., and is used under license.

LinkedIn, the LinkedIn logo, the IN logo, and InMail are registered trademarks or trademarks of LinkedIn Corporation and its affiliates in the United States and/or other countries.

All other company, product and service names mentioned herein are trademarks, registered trademarks or service marks of their respective owners.

Screen images contained herein are simulated. HTC shall not be liable for technical or editorial errors or omissions contained herein, nor for incidental or consequential damages resulting from furnishing this material. The information is provided “as is” without warranty of any kind and is subject to change without notice. HTC also reserves the right to revise the content of this document at any time without prior notice.

No part of this document may be reproduced or transmitted in any form or by any means, electronic or mechanical, including photocopying, recording or storing in a retrieval system, or translated into any language in any form without prior written permission of HTC.