



POCKET PC

PHONE EDITION





USER MANUAL



Table of Contents

Chapter 1: Getting Started	8
Welcome	8
Where to Find Information.....	8
Chapter 2: Hardware Features	9
Front Panel Components	9
Back Panel Components	10
Bottom Edge Components	11
USB Cradle	11
Temperature and Battery Life	11
Recharging the Battery.....	12
When Your Battery Is Low	13
Optional Accessories	13
SD and MMC Cards	13
Inserting or removing a memory card.....	13
External Battery.....	13
Attaching the External Battery.....	14
To view the current charge of the external battery.....	14
USB Cable	15
Serial Cable	15
DC Connector	15
Chapter 3: Knowing Your Pocket PC Phone	16
Resetting the Pocket PC Phone and Clearing Memory	16
To perform a soft reset	16
To perform a full reset.....	16
Backing Up Files	17
To save Word or Excel files to a memory card.....	17
Back up or restore your system using SD Backup.....	18
Screen Tapping Calibration and Recalibration	18
To recalibrate the screen	18
Today Screen	19
Programs	20
Navigation Bar and Command Bar	21
Pop-up Menus	21
Notifications	21
Entering Information on Your Pocket PC Phone	22
Entering Text Using the Input Panel.....	22
To type with the soft keyboard.....	23
To use Letter Recognizer	23
To use Block Recognizer	24
To switch to Transcriber	24
To punctuate in Transcriber	25
To see how to write a letter in Transcriber.....	25
To select typed text	26
To edit text	26
Writing on the Screen	26
To write on the screen.....	26





To select writing.....	27
To convert writing to text.....	27
Tips for getting good recognition	27
Drawing on the Screen.....	28
To create a drawing	28
To select a drawing	28
Recording a Message.....	29
To create a recording.....	29
Using My Text	29
Finding and Organizing Information.....	30
Managing Memory	31
To view memory allocation and availability	31
Finding Space in Storage Memory.....	31
To make available storage memory	31
Customizing Your Pocket PC Phone	32
Customizing the Today Screen.....	32
To change the background.....	32
Adjusting Settings	33
Changing the Default Button Settings	33
To change the default buttons	34
Adding or Removing Programs	34
To add programs using ActiveSync	34
To add a program directly from the Internet.....	35
To add a program to the Start menu.....	35
To remove programs	35
Chapter 4: Phone Features	36
About Your Phone	36
Installing the Smart Card.....	36
Removing the Smart Card.....	36
About The Dialer Screen.....	37
The Navigation Pad and Dialing	38
Entering Your PIN	38
Checking You Are Connected.....	39
Turning The Phone On and Off.....	39
To turn off the phone.....	39
To turn on the phone	39
Adjusting the Phone Volume	40
Back Spacing and Deleting	40
To back space over numbers	40
To delete the number.....	40
Basic Dialing Features	41
Making a call	41
To make a call from the Dialer.....	41
To make a call from Contacts	42
To make a call from Speed Dial (A).....	43
To make a call from Speed Dial (B)	43
To make a call from the Call Log	44
To make a call from Phone Book.....	44
To send SMS in phone dialer	45
Enabling the Speakerphone Mode	46

Answering or Rejecting a Call	46
Ending a Call	47
Managing More Than One Call	47
Putting a Call on Hold	47
To swap between calls	48
To set up conference calling	48
Making a Note	49
To make a note	49
To view a note	50
Call Related Features.....	50
Checking Your Voice Mail	50
To retrieve your voice mail	50
Adding and Transferring Contact Information.....	50
Places where contacts can enter your Pocket PC Phone and be stored.....	50
Why transfer numbers?	51
Microsoft Contacts: Adding and transferring contacts	51
Phone Book: Adding and transferring contacts.....	52
To create a Smart Card contact.....	52
To transfer contacts from Smart Card to Microsoft Contacts	52
To transfer a number to Speed Dial	53
To add a record to Microsoft Contacts from Call Log	53
Managing Your Call Log	54
Viewing details of calls	54
To view duration of call	54
To delete individual calls from Call Log	55
To delete all calls from Call Log.....	55
To set limits on the size of your Call Log.....	55
Customizing Your Phone	55
To select ring type and tone, and keypad sounds	55
Downloading Ring Tones.....	56
To enable the PIN.....	56
To change the PIN	56
To enable Caller ID.....	56
Call Forwarding.....	57
To activate or deactivate Call Forwarding.....	57
Call Waiting	57
To activate or deactivate Call Waiting.....	58
Voice Mail and SMS.....	58
To view your voice mail and SMS access numbers.....	58
To find a network	59
To select a network	59
To set preferred networks	60
To select automatic pickup.....	60
Using Key Lock.....	61
To enable Key Lock.....	61
Enabling Broadcast Channels	61
To enable Broadcast Channels	61
Additional Dialing Information	62
To make an emergency call.....	62
To make an international call	62

Chapter 5: Getting Connected.....	63
Getting Help on Connecting	63
Chapter 6: Wireless Data Programs	64
 Pocket Internet Explorer: Browsing Web and WAP pages.....	64
Using Pocket Internet Explorer.....	65
To view Mobile Favorites and Channels	65
To browse the Internet	65
The Mobile Favorites Folder.....	66
Favorite Links	66
Mobile Favorites	66
To create a Mobile Favorite	66
Saving Pocket PC Phone Memory.....	66
To browse the Internet.....	67
Using AvantGo Channels.....	67
To sign up for AvantGo	67
 MSN Messenger: Instant Messaging	67
To switch to MSN Messenger	67
Setting Up An Account.....	68
Working with Contacts.....	68
Chatting with Contacts.....	69
 Inbox: Sending and Receiving E-mail or SMS	69
Synchronizing E-mail Messages	70
Connecting Directly to an E-mail Server	70
Using the Message List.....	70
Creating an SMS text message or E-mail.....	72
Managing Messages and Folders	72
Folder behavior with a direct connection to an e-mail server.....	72
Transferring Items Using Infrared.....	73
To send information	73
To receive information	73
 Terminal Services Client	73
To connect to a Terminal Server	73
To disconnect without ending a session.....	74
To disconnect and end a session	74
To navigate within Terminal Services Client.....	74
To improve display performance	74
To improve browser performance.....	74
Chapter 7: Microsoft ActiveSync	75
Synchronizing Files.....	76
To synchronize files	76
Chapter 8: Microsoft Pocket Outlook	77
 Calendar: Scheduling Appointments and Meetings	77
To create an appointment	78

Using the Summary Screen.....	78
Creating Meeting Requests	78
To schedule a meeting.....	79
 Contacts: Tracking Friends and Colleagues.....	79
To create a contact.....	80
To find a contact.....	80
Using the Summary Screen.....	81
 Tasks: Keeping a To Do List.....	81
To create a task.....	82
Using the Summary Screen.....	82
 Notes: Capturing Thoughts and Ideas	83
To create a note	83

Chapter 9: Companion Programs84

 Pocket Word.....	84
Typing Mode	85
Writing Mode	85
Drawing Mode.....	86
Recording Mode	86
 Pocket Excel	86
Tips for Working in Pocket Excel.....	87
 Windows Media Player for Pocket PC Phone	87
 Microsoft Reader.....	88
Getting Books on Your Pocket PC Phone.....	89
Using the Library	89
Reading a Book.....	90
Using Reader Features	90
Removing a Book.....	91
 Image Viewer.....	91
Transferring Images to your Pocket PC Phone	91
Changing your Image List Layout	91
Viewing Images.....	92
Deleting an Image	92
Refreshing All Images	92
Arranging Order	92

Appendix A: Character Recognizer.....93

Appendix B: Troubleshooting94

Resetting the Pocket PC Phone and Clearing Memory	94
To perform a soft reset	94
To perform a full reset.....	94
Battery loses power.....	94

Use external power whenever possible	95
Shorten auto suspend time.....	95
To turn off sounds you do not need.....	95
To turn off notification light.....	95
If you forget your password	95
If you run out of phone memory.....	95
Finding Space in Storage Memory.....	95
Finding Space in Program Memory.....	96
Screen freezes or responds slowly.....	96
Screen is blank	96
Screen is dark	96
Screen is hard to read	96
Inaccurate response to stylus taps	96
Slow or no response.....	97
Infrared (IR) connection problems.....	97
Phone connection problems	97
Internet connection problems	97
Network connection problems.....	97
Cable and cradle connection problems	97
<i>Appendix C: Regulatory Notices</i>	<i>99</i>
Regulatory Agency Identification Numbers	99
European Union Notice.....	99
Important Safety Information.....	100
General Precautions	100
Safety Precautions for Power Supply Unit	100
<i>Appendix D: Hardware Specifications</i>	<i>101</i>
<i>Appendix E: Icons</i>	<i>102</i>
Phone	102
Pocket PC.....	103
Statement according FCC part 15.19	105
RF exposure	106

Copyright Information

Microsoft, ActiveSync, Outlook, Pocket Outlook, Windows, Windows NT, and the Windows logo are either registered trademarks or trademarks of Microsoft Corporation in the United States and/or other countries. Microsoft products are licensed to OEMs by Microsoft Licensing, Inc., a wholly owned subsidiary of Microsoft Corporation.

Chapter 1: Getting Started

Welcome

Congratulations on purchasing a Pocket PC Phone. The integrated wireless voice and data capabilities mean that as well as keeping your important Personal Information Manager (PIM) information up-to-date and close at hand, you can make calls, send and receive e-mail, and look up valuable information from the Internet or your company's network anytime, anywhere. Also, with Microsoft ActiveSync, the power of your Pocket PC Phone is increased by allowing you to synchronize the information on your PC with your Pocket PC Phone. Picture yourself in the following situations:

- ?? While walking with a colleague, your Pocket PC Phone rings. You look at the caller ID and see your manager is calling. She asks if you two are free this afternoon for an emergency meeting. While your colleague fumbles through his paper organizer, you press a button on your Pocket PC Phone and instantly see a list of today's appointments and meetings. You are quickly able to tell your manager your available times, and make a note of the new meeting while on the call. You hang up and send e-mail with a meeting request for the three of you at the desired location.
- ?? You are meeting your friends tonight for dinner and a movie. You download the latest movie information from the Internet to your PC, and then synchronize it with your Pocket PC Phone. At dinner, you pull out your Pocket PC Phone and review your movie options with your friends. A Calendar reminder alerts you that it is time to see the movie. You grab your Pocket PC Phone, check driving directions and head towards the theater.
- ?? Because ActiveSync keeps the information on your Pocket PC Phone up-to-date, you can leisurely review your current task list, make notes on the new books and DVDs you want to buy, and read and respond to e-mail messages quickly and conveniently. When you get back to the office, ActiveSync transfers any task changes you made - new notes, responses to e-mails, etc. - directly to your PC.

Where to Find Information

This User Manual describes your Pocket PC Phone hardware, provides an overview of the programs on your Pocket PC Phone, and explains how to connect your Pocket PC Phone to a PC, to a network or to the Internet. For instructions on setting up your Pocket PC Phone, see the **Quick Start Guide**, the **Welcome Guide** and the **Product Tour** video on the enclosed **Pocket PC Phone Companion CD**. The following table is a guide to additional information to help you use your Pocket PC Phone.

For information on:	See this source:
Programs on your Pocket PC Phone	This User Manual and Pocket PC Phone Help. To view Help, tap  and then Help .
Additional programs that can be installed on the Pocket PC Phone	The Pocket PC Phone Companion CD.
Connecting to and synchronizing with a PC	The Quick Start Guide or ActiveSync Help on your Pocket PC Phone. To view ActiveSync Help, click Help and then Connections .
Last-minute updates and detailed technical information	The Read Me files, located in the Microsoft ActiveSync folder on the PC and on the Pocket PC Phone Companion CD.
Up-to-date information on your Pocket PC Phone	http://www.pocketpc.com

Chapter 2: Hardware Features

Your Pocket PC Phone has hardware buttons and a stylus for selecting items and entering information.

Front Panel Components

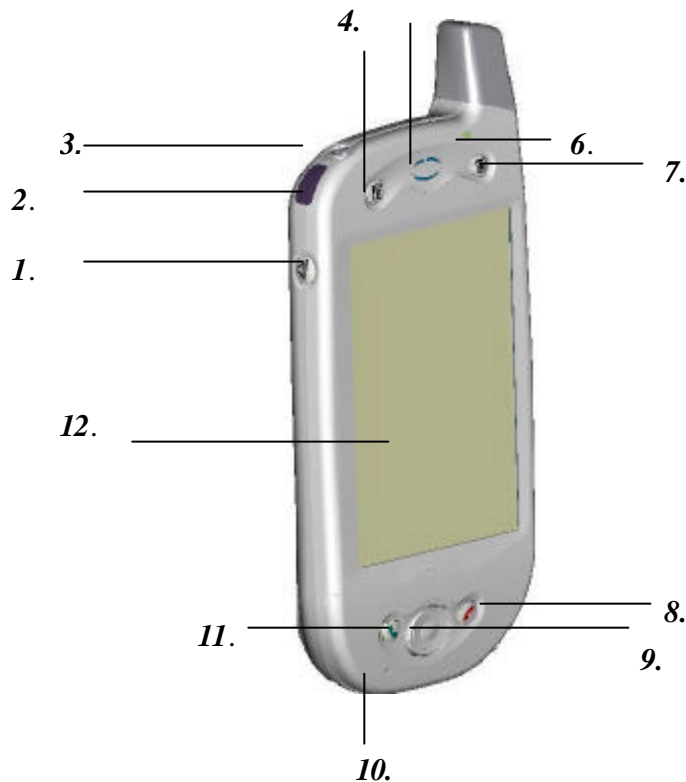

- 1 Volume.** Press to adjust the volume of your Pocket PC Phone.
- 2 Infrared Port.** Enables you to exchange file(s) or data with other Pocket PC Phones without cables/wires.
- 3 Power Button.** Press to turn on/off your Pocket PC Phone.
Backlight. Press and hold to turn the backlight on/off.
- 4 Contacts.** Press for quick access to your Contacts.
- 5 Speaker.** Listen to audio media or a phone call from here.
- 6 Notification LED:**
- a) Flashing Green (Every 3 seconds) – GSM Network Signal.
 - b) Flashing Green (Every second) – Notification Alarm Reminder.
 - c) Steady Red – Battery empty.
 - d) Flashing Red – Low battery.
 - e) Steady Amber – Battery charging.
 - f) Steady Green – Fully charged.
- 7 Calendar.** Press to quickly access the Calendar.
- 8 End.** Press to end a call.
Phone On/Off. Press and hold to turn on/off your Pocket PC Phone's phone.

- 9 Navigation Pad:**
Allows you to move up/down and left/right through any of the drop-down menus or program instructions; select by pressing in the center.
Left: When in the Dialer screen, press once to access the Speed Dial feature.
Right: When in the Dialer screen, press once to access the Call Log feature.
- 10 Microphone.** Speak into the microphone when receiving/making a phone call or voice recording.
- 11 Take Call.** Press to take an incoming call.
Dialer Screen. Press to activate the dialer screen.
Speakerphone. Press and hold to turn on/off the speakerphone.
Dial. Press to dial a number.
- 12 Touch Screen.** Use the touch screen to write, draw or make a selection with the stylus.

Back Panel Components

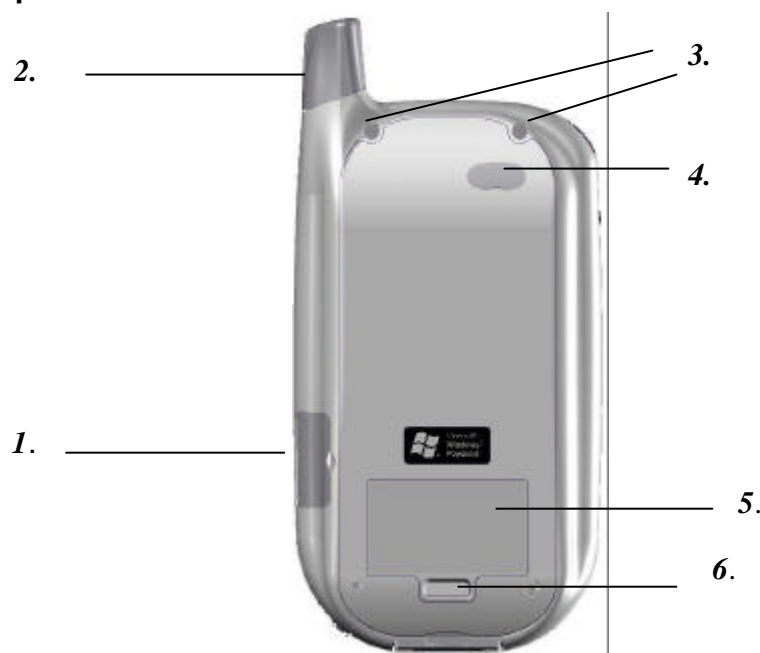

- 1. Smart Card Door.** Open the rubber door to insert the Smart Card.
- 2. Stylus Slot and Stylus.** The antenna has a neatly hidden slot for housing the stylus.
- 3. To Secure External Battery.** The optional External Battery should be fastened here. (See the section, *Attaching the External Battery*)
- 4. External Battery Connector Cover.** Remove this to uncover the connection between your Pocket PC Phone and the optional External Battery.
- 5. Main Battery Unit.** The main battery is housed permanently inside the Pocket PC Phone– it should only be changed through an authorized sales center.
- 6. External Battery Clip** Before screwing the External Battery into position, secure the clip on the bottom into this hole.

Bottom Edge Components

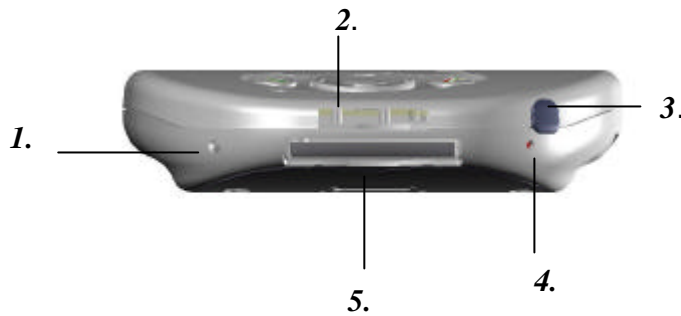

- 1 **Soft Reset.** Press into the hole with the end of your stylus to reset your Pocket PC Phone.
- 2 **Sync Connector.** Use this connector when synchronizing/transmitting data or when recharging.
- 3 **Earphone Jack.** Use the earphone jack or the phone's hands-free kit to listen to audio media.
- 4 **Battery On/Off Switch.** Press into the hole with the end of the top-half of your stylus to return the Pocket PC Phone to factory settings.
 - CAUTION: Battery Off** will wipe all the data from your Pocket PC Phone!
- 5 **MMC And SD Card Slot.** Insert either MMC or SD cards in this slot.

USB Cradle



?? Your Pocket PC Phone comes with a USB cradle. This allows you to recharge your Pocket PC Phone, as well as synchronize information between your Pocket PC Phone and a PC using ActiveSync.

To synchronize, plug the USB cradle into an available USB port on your PC.

Temperature and Battery Life

Your Pocket PC Phone contains a rechargeable Lithium Polymer battery, which is housed permanently in your Pocket PC Phone. After a few years of continual use and recharging the battery will become unusable and should be changed through a service center. While you are using your Pocket PC Phone the amount of power consumed depends on whether you are talking on the phone, using the PIM and Internet functions or the Pocket PC Phone is on standby. The estimates for battery life (talk time: 4~5 hours, PIM: 15-17 hours and standby: 150 -170 hours) are based on only using one function. Since you will be continually swapping between functions, these estimates will vary.



Your Pocket PC Phone contains a Lithium Polymer battery pack. There is a risk of fire and burns if the battery pack is handled improperly. Do not disassemble, crush, puncture, short external contacts, or dispose of in fire or water. Do not attempt to open or service the battery pack. Replace only with the battery pack designated for this product. Dispose of batteries properly.

Recharging the Battery

Remembering to charge your battery is extremely important, as your Pocket PC Phone does not have a hard drive. All your data and any new programs you install are stored in Random Access Memory (RAM). In the event that the battery loses all its power, personal data and newly installed software programs will be wiped off. Only the default programs installed when you bought the Pocket PC Phone will remain. You can recharge your Pocket PC Phone in the following ways:

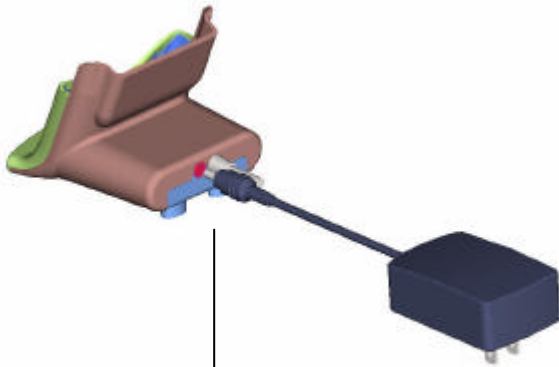

AC adapter plugs into the back of the cradle

- ?? Place your Pocket PC Phone in the cradle and connect the cradle to an external power source. The first time you use it initially charge for three to four hours. Then place your Pocket PC Phone in the cradle for a short time each day to recharge to its full capacity.

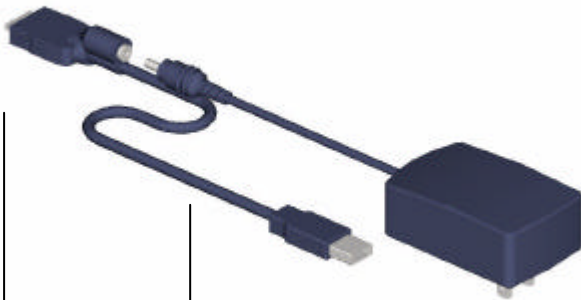

To your Pocket PC Phone

USB synchronization cable

Plug the AC adapter into a socket

- ?? You can plug the AC adapter into the optional USB/Serial cable head and then connect your Pocket PC Phone directly to an external power source.



To your Pocket PC Phone

To AC adapter

?? You can plug the AC adapter into the optional DC Converter and then connect your Pocket PC Phone directly to an external power source.

When Your Battery Is Low

Your Pocket PC Phone has only one battery; however, a portion of that battery is saved as backup. If the battery gets very low, your Pocket PC Phone displays a warning message. If this occurs, save any unsaved data you are working on, perform synchronization with your PC and then turn off your Pocket PC Phone. Do not try to restart your Pocket PC Phone until you have connected to external power. If your Pocket PC Phone does shut down, the backup portion of your battery will protect your data for approximately 72 hours.

Optional Accessories

SD and MMC Cards

Your Pocket PC Phone has an expansion slot compatible with a range of SD and MMC memory cards, which are primarily used to back up or transfer files and data.

Inserting or removing a memory card



1. Push the memory card into the bottom slot until it clicks into place. The card is secure when it is not protruding from the base.

External Battery

You can purchase an optional External Battery to increase the battery life of your Pocket PC Phone by up to another 4 hours, and standby time by another 150 hours. The External Battery can be charged with either your Pocket PC Phone or with an External Battery charger. Charging with the External Battery charger should take about two and a half hours; when it is attached to the Pocket PC Phone, total charging for the External Battery and Pocket PC Phone should be approximately five hours.

Attaching the External Battery

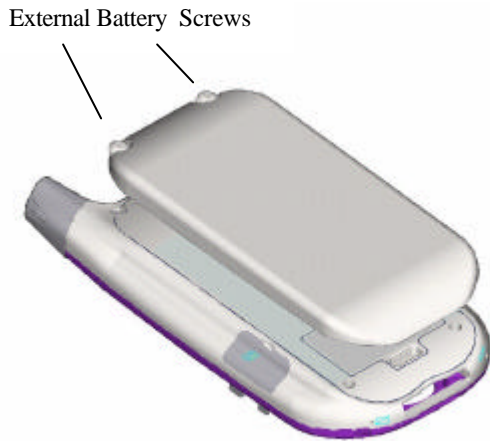

1. Remove the rubber cap protecting the Pocket PC Phone connector for the External Battery. The cap is situated just below the right screw on the back of the Pocket PC Phone.
2. Hook the External Battery into the embedded slot near the base of the back of your Pocket PC Phone (see picture to the left).
3. Tighten the screws at the top of the External Battery into your Pocket PC Phone.

To view the current charge of the external battery

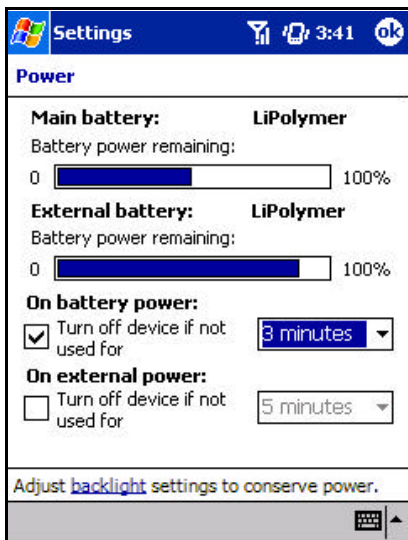

When you attach the External Battery an extra indicator will be added to the **Power** screen.

To view this indicator tap **Start, Settings, System** and then **Power**.



Your Pocket PC Phone contains a Lithium Polymer battery pack. There is a risk of fire and burns if the battery pack is handled improperly. Do not disassemble, crush, puncture, short external contacts, or dispose of in fire or water. Do not attempt to open or service the battery pack. Replace only with the battery pack designated for this product. Dispose of batteries properly.

USB Cable



- ?? The USB cable allows you to synchronize with your desktop PC without the cradle. The DC converter in the head also allows you, in combination with an AC adapter, to recharge your Pocket PC Phone.

Serial Cable



- ?? The Serial cable allows you to synchronize with your desktop PC without the cradle. The DC converter in the head also allows you, in combination with an AC adapter, to recharge your Pocket PC Phone.

DC Connector



- ?? The DC connector, in combination with the AC adapter, allows you to recharge your Pocket PC Phone without the cradle.

Chapter 3: Knowing Your Pocket PC Phone

Resetting the Pocket PC Phone and Clearing Memory

You can perform a soft reset or a full reset— a soft reset restarts your Pocket PC Phone and a full reset switches the battery off. The result of a soft reset is that some data may be lost in programs that are open. The result of a full reset is wiping all the data and new programs you have added- and returning the Pocket PC Phone to factory settings – which will only have the software that was present when you bought it. Therefore, it is important not to think about a full reset as you would restarting, shutting down or even switching off your desktop PC, but rather like a complete crash requiring you to wipe your operating system (OS). The importance of backing up data to an SD card or your computer cannot be stressed enough - in the event you have to perform a full reset your data will not be lost.

To perform a soft reset

If your Pocket PC Phone responds slowly, stops responding or freezes, try soft resetting it. A soft reset causes the Pocket PC Phone to restart and re-adjust memory allocation. Unsaved data in open windows may be lost.

?? Use the stylus to press and hold the Reset button for about two seconds. (For details on finding soft reset, see “Chapter 2, Bottom Edge Components.”)

To perform a full reset



Clearing memory deletes all data and restores the Pocket PC Phone to its default settings. Programs installed at the factory remain, while data you have created and programs you have installed are erased.



1. Unscrew the stylus and use the smaller point of the top-half.



2. Press the battery switch once to turn it off, and then once more to turn it back on.

Backing Up Files

Because any new programs or data are stored in RAM and will be lost if you have to perform a full reset, or your Pocket PC Phone loses all power for any other reason, it is absolutely paramount that you back up files to your computer or a memory card. When you are at your desktop PC you can synchronize with your computer to back up files. However, if you are unable to access your desktop PC, you will need to back up files to a SD or MMC card. In this case, you can back up individual files in Word or Excel or all files in SD backup.

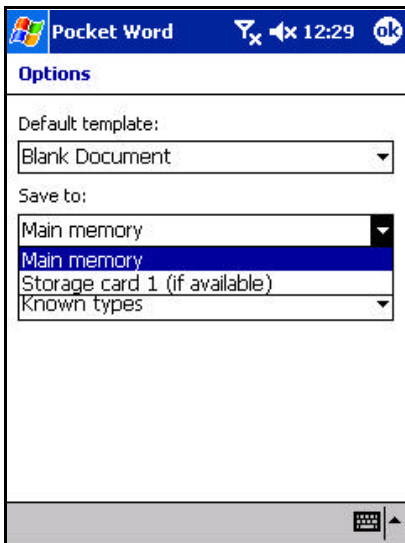

To save Word or Excel files to a memory card

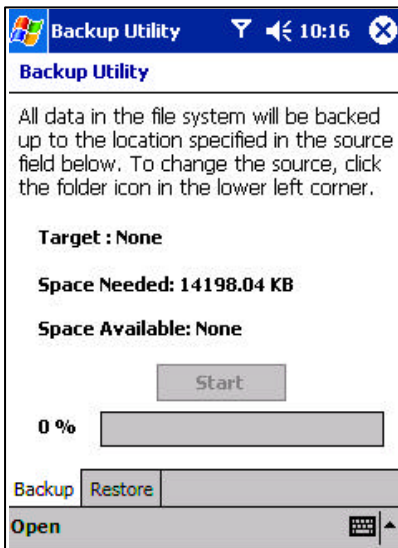

1. In application programs (e.g. Pocket Word or Excel) press **Tools, Options.**
2. Tap the drop-down menu box under **Save To** and select **Storage Card.**

Back up or restore your system using SD Backup



1. Push the memory card into the slot until it clicks into place (see Chapter 2, “Inserting or removing a memory card”). The card is secure when it is not protruding from the base.
2. Tap , **Programs**,  (**SD Backup**) then the **Backup** or **Restore** tab.
3. Tap **Open, Storage Card**
4. Make sure there are no application programs running in the background, and then tap **Start**.

Screen Tapping Calibration and Recalibration

When you first start up your Pocket PC Phone, you will be asked to calibrate the screen by tapping the center of a cross with your stylus as it moves around the screen. This process ensures when you tap the screen with your stylus the item tapped is activated. If you are using your Pocket PC Phone and you discover tapping an item does not bring up the appropriate response, your Pocket PC Phone has lost its calibration.

To recalibrate the screen

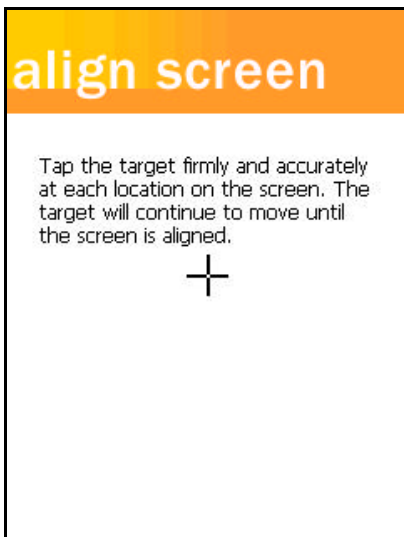

- ?? Tap **Settings, System** and then **Screen**.
- ?? As described above, tap the center of the cross to with your stylus as it moves around the screen.
- ?? **Tap** Touch the screen once with the stylus to open items and select options.
- ?? **Drag**. Hold the stylus on the screen and drag across the screen to select text and images. Drag in a list to select multiple items.
- ?? **Tap and hold** Tap and hold the stylus on an item to see a list of actions available for that item. On the pop-up menu that appears, tap the action you want to perform.

Today Screen

When you turn on your Pocket PC Phone for the first time each day (or after 4 hours of inactivity), you will see the **Today** screen. You can also display it by tapping  and then **Today**. On the **Today** screen, you can see at glance important information for the day.

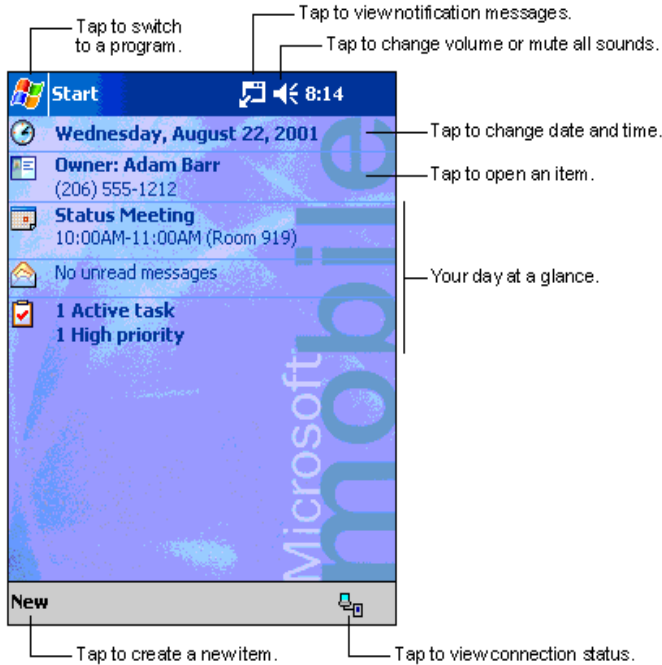

Following are some of the status icons you may see.



Turns all sounds on and off



Main battery low



Main battery very low



Connection is active



Synchronization is beginning or ending



Synchronization is in progress



Notification that one or more instant messages were received





Notification that one or more e-mail/SMS messages were received





Shows the connection to your mobile phone service provider is on and the strength of the signal



Indicates your phone is switched off

 If more notification icons need to be displayed than there is room to display them, the Notification icon  will display. Tap this icon to view all notification icons.















Programs

You can switch from one program to another by selecting it from the  menu. You can customize which programs you see on this menu. For information, see “Adjusting Settings” later in this chapter. To access some programs, you will need to tap , **Programs**, and then the program name.

You can also switch to some programs by pressing a program button. Your Pocket PC Phone has one or more program buttons located on the front or side of the Pocket PC Phone. The icons on the buttons identify the programs they switch to.

-  Some programs have abbreviated labels for check boxes and drop-down menus. To see the full spelling of an abbreviated label, tap and hold the stylus on the label. Drag the stylus off the label so that the command is not carried out.

The following table contains a partial list of programs that are on your Pocket PC Phone. Look on the Pocket PC Phone Companion CD for additional programs that you can install on your Pocket PC Phone.

Icon	Program	Description
	ActiveSync	Synchronize information between your Pocket PC Phone and PC.
	Calendar	Keep track of your appointments and create meeting requests.
	Contacts	Keep track of your friends and colleagues.
	Inbox	Send and receive e-mail/SMS messages.
	Pocket Internet Explorer	Browse Web and WAP sites, and download new programs and files from the Internet.
	Notes	Create handwritten or typed notes, drawings, and recordings.
	Tasks	Keep track of your tasks.
	Pocket Excel	Create new workbooks or view and edit Excel workbooks.
	MSN Messenger	Send and receive instant messages with your MSN Messenger contacts.
	Pocket Word	Create new documents or view and edit MS-Word documents.
	Phone	Make and receive calls, swap between calls and set up conference calling.
	SD Backup	Back up your Pocket PC Phone files to a SD card.
	Phone Book	Loads contents of your Smart Card to your Pocket PC Phone and allows you to transfer to Contacts.
	Windows Media Player	To enable the multimedia function on your Pocket PC Phone.

Navigation Bar and Command Bar

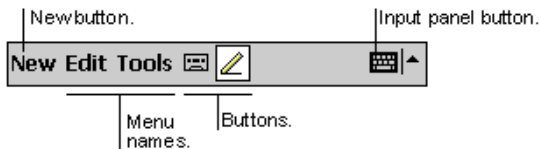
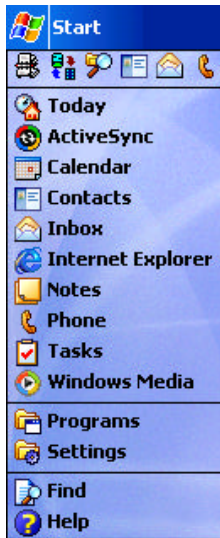

- ?? The navigation bar is located at the top of the screen. It displays the active program and current time, and allows you to switch to programs and close screens.
- ?? Use the command bar at the bottom of the screen to perform tasks in programs. The command bar includes menu names, buttons, and the Input Panel button. To create a new item in the current program, tap **New**. To see the name of a button, tap and hold the stylus on the button. Drag the stylus off the button so that the command is not carried out.

Pop-up Menus

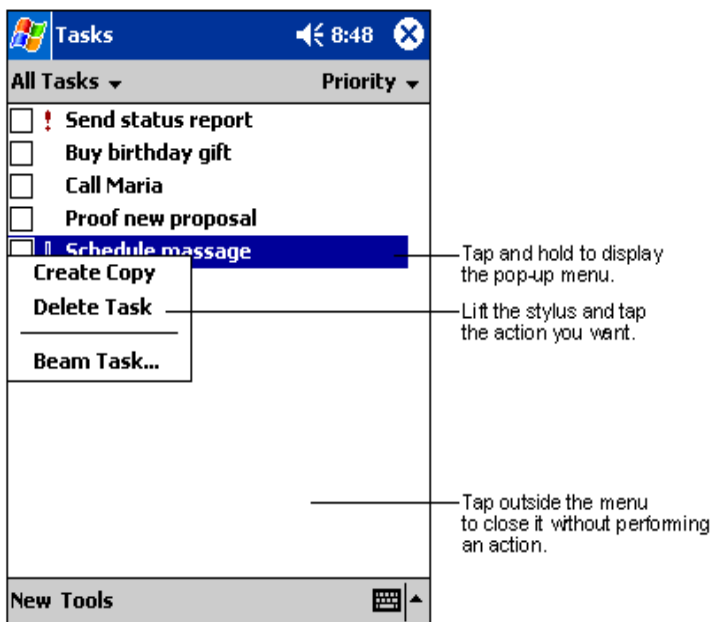

- ? With pop-up menus, you can quickly choose an action for an item. For example, you can use the pop-up menu in the contact list to quickly delete a contact, make a copy of a contact, or send an e-mail message to a contact. The actions in the pop-up menu vary from program to program. To access a pop-up menu, tap and hold the stylus on the item name that you want to perform the action on. When the menu appears, lift the stylus and tap the action you want to perform. Or tap anywhere outside the menu to close the menu without performing an action.

Notifications

Your Pocket PC Phone reminds you in a variety of ways when you have something to do or you receive an SMS. For example, if you have set up an appointment in **Calendar**, a task with a due date in **Tasks**, or an alarm in **Clock**, you will be notified in any of the following ways:

- ?? A message box appears on the screen.
- ?? A sound, which you can specify, is played.

?? A light flashes on your Pocket PC Phone.

?? The Pocket PC Phone vibrates.

To choose reminder types and sounds for your Pocket PC Phone, tap  and then **Settings**. In the **Personal** tab, tap **Sounds & Notifications**. The options you choose here apply throughout the Pocket PC Phone.

Entering Information on Your Pocket PC Phone

You have several options for entering new information:

- ?? Use the input panel to enter typed text, either by using the soft keyboard or other input method.
- ?? Write directly on the screen.
- ?? Draw pictures on the screen.
- ?? Speak into your Pocket PC Phone microphone to record a message.
- ?? Use Microsoft ActiveSync to synchronize or copy information from your PC to your Pocket PC Phone. For more information on ActiveSync, see ActiveSync Help on your desktop PC.

Entering Text Using the Input Panel

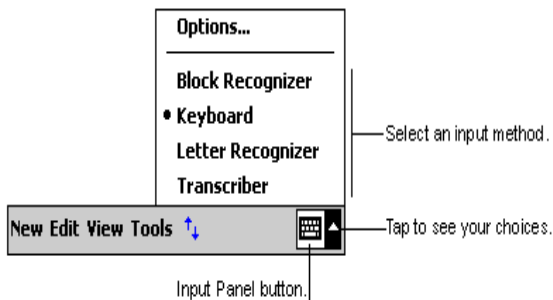

- ?? Use the input panel to enter information in any program on your Pocket PC Phone. You can either type using the soft keyboard or write using Letter Recognizer, Block Recognizer, or Transcriber. In all cases, the characters appear as typed text on the screen.
- ?? To show or hide the input panel, tap the Input Panel button. Tap the arrow next to the Input Panel button to see your choices.

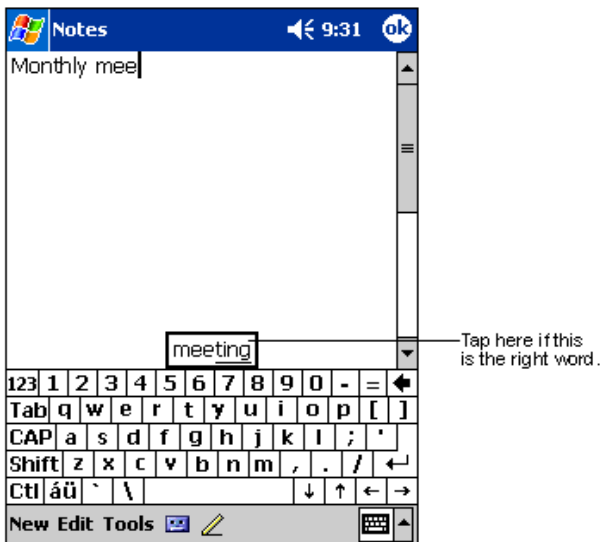

- ?? When you use the input panel, your Pocket PC Phone anticipates the word you are typing or writing and displays it above the input panel. When you tap the displayed word, it is inserted into your text at the insertion point. The more you use your Pocket PC Phone, the more words it learns to anticipate.

To type with the soft keyboard

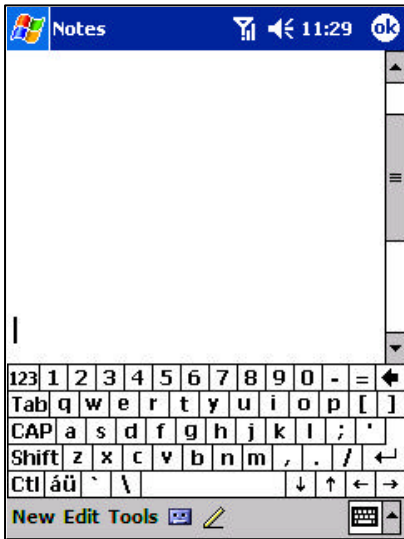

1. Tap the arrow next to the Input Panel button and then **Keyboard**.
2. On the soft keyboard that is displayed, tap the key with your stylus.

To use Letter Recognizer

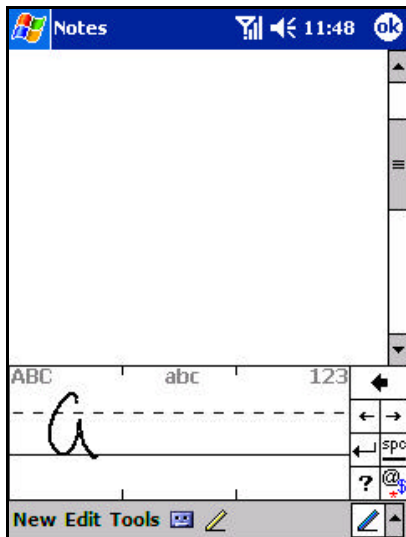

With Letter Recognizer you can write letters using the stylus just as you would on paper.

1. Tap the arrow next to the Input Panel button and then **Letter Recognizer**.
2. Write a letter in the box.

When you write a letter, it is converted to typed text that appears on the screen. For specific instructions on using Letter Recognizer, with Letter Recognizer open, tap the question mark next to the writing area.

To use Block Recognizer

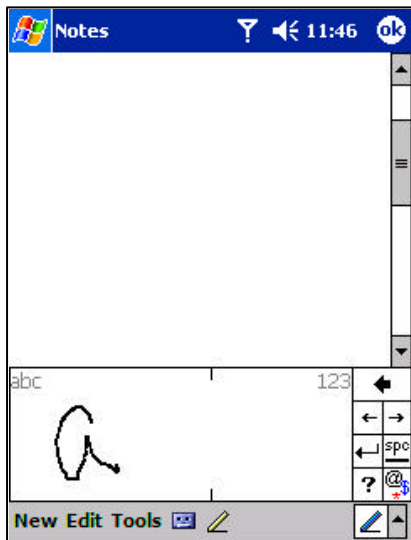

With Block Recognizer you can input character strokes using the stylus that are similar to those used on other Pocket PC Phones.

1. Tap the arrow next to the Input Panel button and then **Block Recognizer**.
2. Write a letter in the box.

When you write a letter, it is converted to typed text that appears on the screen. For specific instructions on using Block Recognizer, with Block Recognizer open, tap the question mark next to the writing area.

To switch to Transcriber

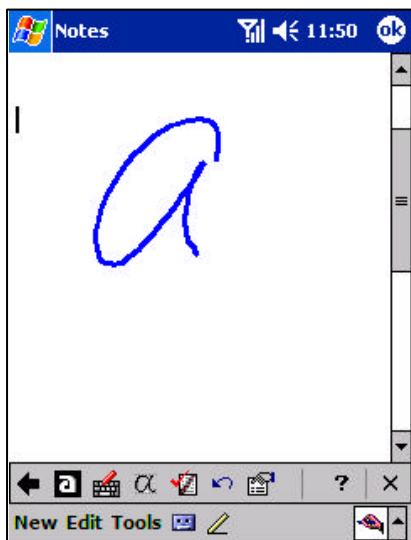

With Transcriber you can write anywhere on the screen using the stylus just as you would on paper. Unlike Letter Recognizer and Block Recognizer, you can write a sentence or more of information. Then, pause and let Transcriber change the written characters to typed characters.

1. Tap the arrow next to the Input Panel button and then **Transcriber**.
2. Write anywhere on the screen.

For specific instructions on using Transcriber, with Transcriber open, tap the question mark in the lower right hand corner of the screen.

To punctuate in Transcriber

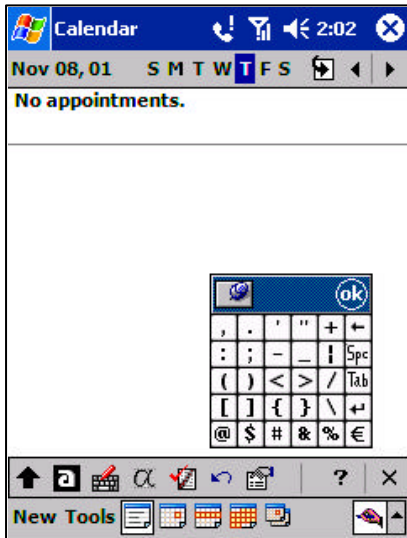

1. Tap the keyboard on the toolbar.
2. Tap **OK** to hide the keyboard.

Click on a letter for a demonstration.

To see how to write a letter in Transcriber

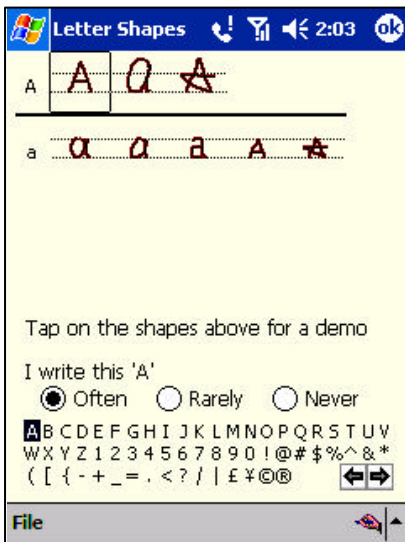

1. Tap “a” on the toolbar.
2. In the screen that appears, select the letter you want to learn about, and then tap on one of the examples given above.

For specific instructions on using Transcriber, with Transcriber open, tap the question mark in the lower right hand corner of the screen.

Click on a letter for a demonstration

To select typed text

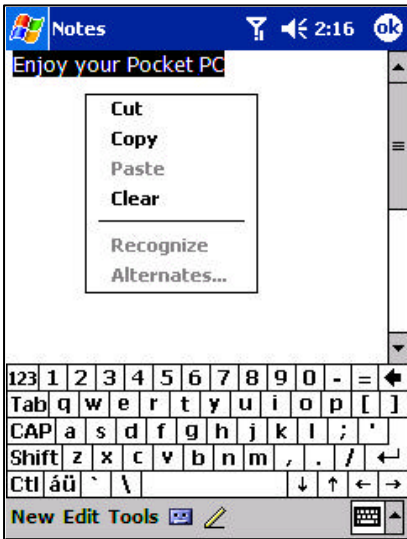

If you want to edit or format typed text, you must select it first. To do so:

- ?? Drag the stylus across the text you want to select. You can cut, copy, and paste text by tapping and holding the selected words and then tapping an editing command on the pop-up menu, or by tapping the command on the **Edit** menu.

- To change word suggestion options, such as the number of words suggested at one time, tap , **Settings**, **Personal** tab, **Input**, and then the **Word Completion** tab.

To edit text

Each input program provides cursor keys to move through text and backspace so that you can correct spelling, grammar or insert additional information. You can also use your stylus to make an insert. After you have made an insert, you can use any of the input methods described above to add additional text at the insertion point.

Writing on the Screen

In any program that accepts writing, such as the Notes program, and in the **Notes** tab in Calendar, Contacts, and Tasks, you can use your stylus to write directly on the screen. Write the way you do on paper. You can edit and format what you have written and convert the information to text at a later time.

To write on the screen

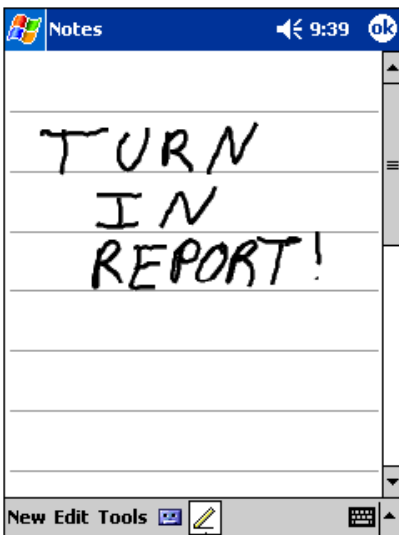

- ?? Tap the Pen button to switch to writing mode. This action displays lines on the screen to help you write.

Tap the Pen button and use your stylus like a pen.

- Some programs that accept writing may not have the Pen button. See the documentation for that program to find out how to switch to writing mode.

To select writing

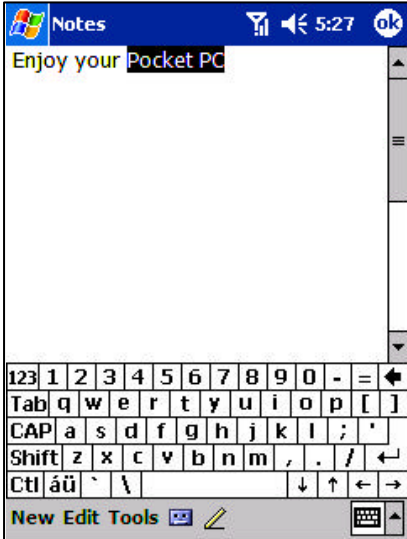

If you want to edit or format writing, you must select it first.

1. Tap and hold the stylus next to the text you want to select until the insertion point appears.
2. Without lifting, drag the stylus across the text you want to select.

If you accidentally write on the screen, tap **Tools**, then **Undo** and try again. You can also select text by tapping the Pen button to deselect it and then dragging the stylus across the screen.

You can cut, copy and paste written text in the same way you work with typed text: tap and hold the selected words and then tap an editing command on the pop-up menu, or tap the command on the **Edit** menu.

To convert writing to text

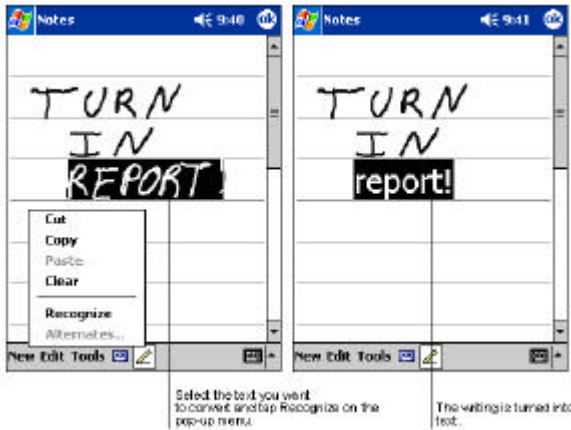

1. Tap **Tools** and then **Recognize**.
2. If you want to convert only certain words, select them before tapping **Recognize** on the **Tools** menu (or tap and hold the selected words and then tap **Recognize** on the pop-up menu). If a word is not recognized, it is left as writing.
3. If the conversion is incorrect, you can select different words from a list of alternates or return to the original writing. To do so, tap and hold the incorrect word (tap one word at a time). On the pop-up menu, tap **Alternates**. A menu with a list of alternate words appears. Tap the word you want to use, or tap the writing at the top of the menu to return to the original writing.

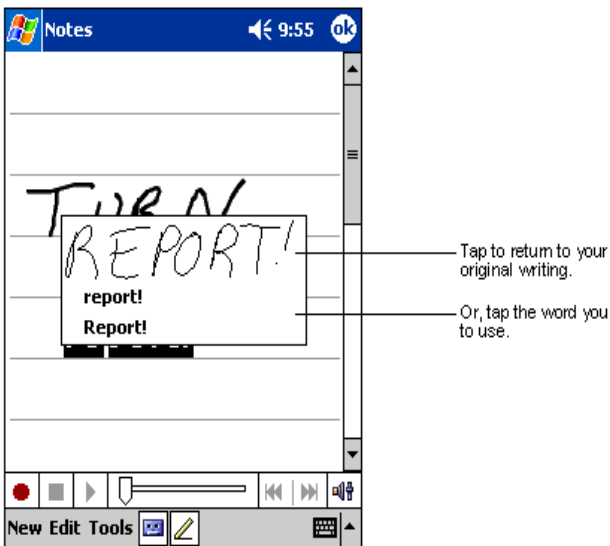

Tips for getting good recognition

1. Write neatly.
2. Write on the lines and draw the end of lowercase letters (y, g, p) below the line. Write the cross of the “t” and apostrophes below the top line so that they are not confused with the word above. Write periods and commas above the line.
3. For better recognition, try increasing the zoom level to 300% using the **Tools** menu.
4. Write the letters of a word closely and leave big gaps between words so that the Pocket PC Phone can easily tell

where words begin and end.

5. Hyphenated words, foreign words that use special characters such as accents, and some punctuation cannot be converted.
6. If you change a word or number (such as changing a “3” to an “8”) after you attempt to recognize it, the writing you add will not be included if you attempt to recognize the writing again.

Drawing on the Screen

You can draw on the screen in the same way that you write on the screen. The difference between writing and drawing on the screen is how you select items and how they can be edited. For example, selected drawings can be resized, while writing cannot.

To create a drawing

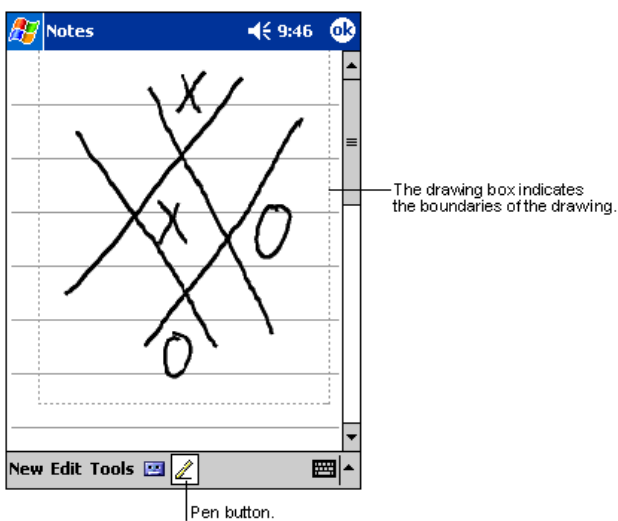

- ?? Cross three ruled lines on your first stroke. A drawing box appears. Subsequent strokes in or touching the drawing box become part of the drawing. Drawings that do not cross three ruled lines will be treated as writing.

To select a drawing

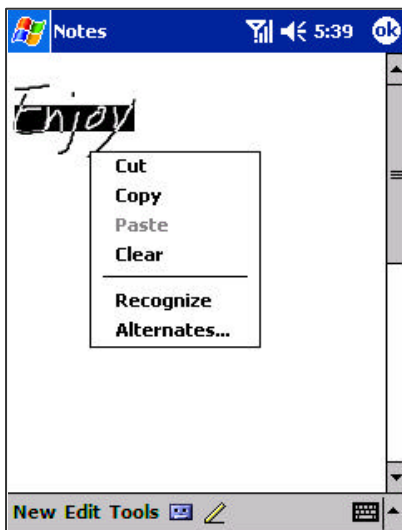

If you want to edit or format a drawing, you must select it first.

- ?? Tap and hold the stylus on the drawing until the selection handle appears. To select multiple drawings, deselect the Pen button and then drag to select the drawings you want.
- ?? You can cut, copy and paste selected drawings by tapping and holding the selected drawing and then tapping an editing command on the pop-up menu, or by tapping the command on the **Edit** menu. To resize a drawing, make sure the Pen button is not selected, and drag a selection handle.



- ▣ You may want to change the zoom level so that you can more easily work on or view your drawing. Tap **Tools** and then a zoom level.

Recording a Message

In any program where you can write or draw on the screen, you can also quickly capture thoughts, reminders, and phone numbers by recording a message. In Calendar, Tasks, and Contacts, you can include a recording in the **Notes** tab. In the Notes program, you can either create a stand-alone recording or include a recording in a written note. If you want to include the recording in a note, open the note first. In the Inbox program, you can add a recording to an e-mail message.

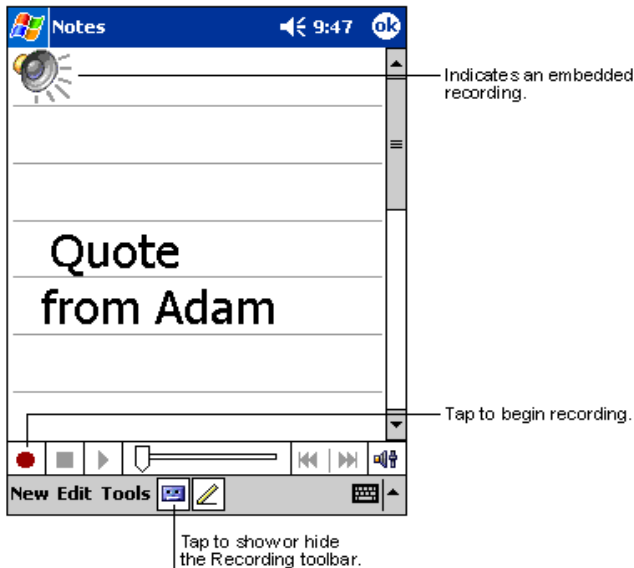
To create a recording



1. Hold your Pocket PC Phone's microphone near your mouth or other source of sound.
2. Tap , and then **Notes**.
3. Tap  to make your recording. A beep will sound in the beginning of the recording.
4. Tap  to stop recording. Two beeps will sound. The new recording appears in the note list or as an embedded icon.

 You can also make a recording by tapping the **Record** button on the Recording toolbar.

Using My Text

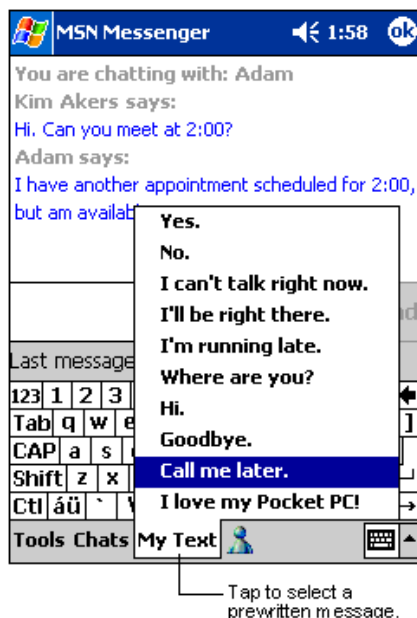

- ?? When using Inbox or MSN Messenger, use **My Text** to quickly insert preset or frequently used messages into the text entry area. To insert a message, tap **My Text** and tap a message.
- ?? To edit a My Text message, in the **Tools** menu, tap **Edit** and then tap **My Text Messages**. Select the message you wish to edit and make desired changes.

 You can add text to a **My Text** message after inserting it.

Finding and Organizing Information

The Find feature on your Pocket PC Phone helps you quickly locate information.



?? On the  menu, tap **Find**. Enter the text you want to find, select a data **Type**, and then tap **Go** to start the search.

 To quickly find information that is taking up storage space on your Pocket PC Phone, select **Larger than 64 KB** in **Type**.

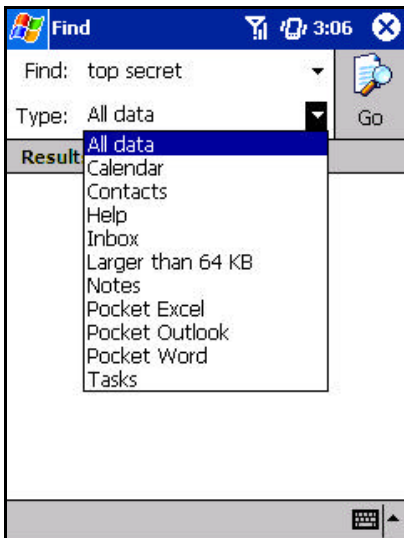

?? Tap in a file name, select a file type and press **Go**.

?? The name of the file will appear in the box entitled **Results**.

Managing Memory

Memory on your Pocket PC Phone is shared between storage memory and program memory. Storage memory is used to store the information you create and programs you install. Program memory is used to run programs on your Pocket PC Phone. The Pocket PC Phone automatically manages the allocation between storage and program memory.

To view memory allocation and availability



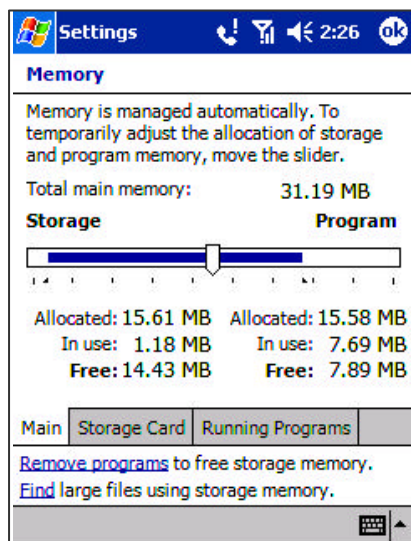

Tap , **Settings**, **System** and then **Memory**.



Finding Space in Storage Memory

In some situations, such as when memory is low, your Pocket PC Phone may not be able to automatically adjust the allocation. If you receive a message stating that storage or program memory is unavailable, try the following solutions.

To make available storage memory

1. Move data to a SD storage card.
2. Tap , **Programs**, and then **File Explorer**. Tap and hold the file you want to move, and tap **Cut**. Go to the **My Documents** folder in the storage card folder, tap **Edit**, and then tap **Paste**. Files stored in folders other than **My Documents** or stored in folders within subfolders in **My Documents** may not show up in the list view of some programs. When using **Notes**, **Pocket Word**, or **Pocket Excel**, you can also move files by opening the item and tapping **Tools** or **Edit** and then **Rename/Move**.
3. Move e-mail attachments. In **Inbox**, tap **Tools** and then **Options**. On the **Storage** tab, select **Store attachments on storage card**. All attachments are moved to the storage card, and new attachments are automatically stored on the storage card.
4. Set programs such as **Notes**, **Pocket Word**, and **Pocket Excel** to automatically save new items on the storage card. In the program, tap **Tools** and then **Options**.
5. If you are copying files from your PC or another Pocket PC Phone to your Pocket PC Phone, try adjusting the slider in the **Memory** setting. Tap  and then **Settings**. On the **System** tab, tap **Memory** and check whether the slider can be adjusted manually before copying files.
6. Delete unnecessary files. Tap , **Programs**, and then **File Explorer**. Tap and hold the file, and then tap **Delete** on the pop-up menu. To find your largest files, tap  and then **Find**. In the **Type** list, tap **Larger than 64 KB**, and then tap **Go**.

7. In **Internet Explorer** options, delete all files and clear history. In **Internet Explorer**, tap **Tools** and then **Options**. Tap **Delete Files** and **Clear History**.

Customizing Your Pocket PC Phone

You can customize your Pocket PC Phone by adjusting Pocket PC Phone settings and installing additional software.

Customizing the Today Screen

You can customize the Today screen in the following ways: change the background picture, select the information you want displayed and in what order, and further customize to show future appointments.

To change the background

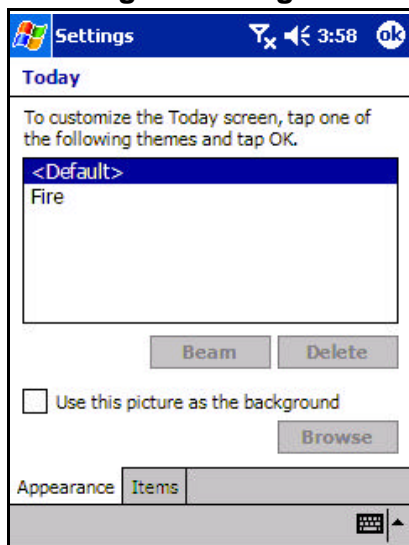

1. Tap **Start, Settings, Personal** and then **Today**.
2. On the **Appearance** tab, select the desired theme for the background and then tap **OK**. To use your own background, select **Use this picture as the background** and tap **Browse** to locate the desired file.
3. Choose a **Folder** and **Type** and then tap **Find**.
4. Tap the picture you want to use and then tap **OK**.

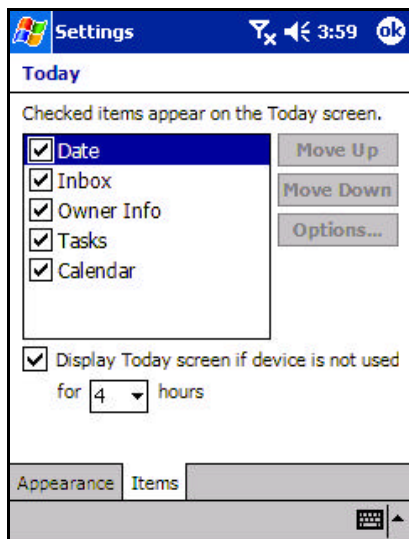

To customize the information you want displayed:

1. Tap **Start, Settings, Personal** and then **Today**.
2. On the **Items** tab:
 - ?? Uncheck a box to remove its information.
 - ?? Select an item and tap **Move Up** or **Move Down** to change its position.
 - ?? Select or deselect **Display Today screen if device is not used for**, and then select a number of hours from the box.

















To customize **Tasks** or **Calendar**:

1. Select **Tasks** or **Calendar**, **Tools** and then **Options** to further customize.

Adjusting Settings

You can adjust Pocket PC Phone settings to suit the way you work. To see available options, tap , **Settings**, then the **Personal** or **System** tab located at the bottom of the screen.

?? You might want to adjust the following:

Icon	Program	Description
	Buttons	To assign application programs to hardware buttons.
	Input	To set up the input methods of your Pocket PC Phone.
	Menu	To customize what appears on the  menu, and to enable a pop-up menu from the New button.
	Owner Information	To enter your personal contact information.
	Password	To limit access to your Pocket PC Phone.
	Phone	To set up the phone function of your wireless feature.
	Sounds & Notification	To set the notification type, event and volume.
	Today	To customize the look and the information that is displayed on the Today screen.
	Backlight	To customize the backlight brightness and automatic turnoff for power saving purposes.
	Clock	To change the time and date or to set alarms.
	Microphone AGC	To enable/disable the microphone Automatic Gain Control (AGC).
	Power	To maximize battery life and control external power.
	Regional Settings	To customize language, number format, currency, time and date display.
	Remove Programs	To save the limited memory you may use this function to remove some application programs not used frequently.
	Screen	To recalibrate screen tapping and enable/disable the Clear Type feature.

Changing the Default Button Settings

The hardware buttons on your Pocket PC Phone are default set for **Calendar**, **Contacts** and **Phone**. The phone buttons cannot be changed; however, you can change the **Calendar** and **Contacts** buttons to open other programs.

To change the default buttons

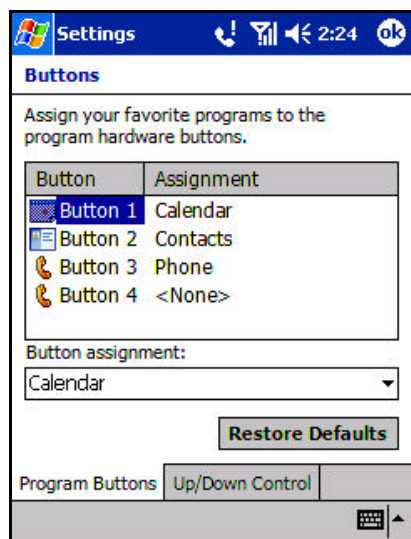

1. Tap , **Settings**, **Personal** and then **Buttons**.
2. Highlight a button, select a program in **Button assignment**, and then tap **OK**.

Adding or Removing Programs

Programs added to your Pocket PC Phone at the factory are stored in ROM (read-only memory). You cannot remove this software, and **you will** never accidentally lose ROM contents. ROM programs can be updated using special installation programs with a *.xip extension. All other programs and data files added to your Pocket PC Phone after factory installations are stored in RAM (random access memory).

You can install any program created for your Pocket PC Phone as long as your Pocket PC Phone has enough memory. The most popular place to find software for your Pocket PC Phone is on the Pocket PC web site (<http://www.microsoft.com/mobile/pocketpc>).

To add programs using ActiveSync

You will need to install the appropriate Pocket PC Phone software on your PC before installing it on your Pocket PC Phone.

1. Determine your Pocket PC Phone and processor type so you know which version of the software to install.
Tap  and then **Settings**. On the **System** tab, tap **About**. In the **Version** tab, make a note of the information in **Processor**.
2. Download the program to your PC (or insert the CD or disk that contains the program into your PC). You may see a single *.xip, *.exe, or *.zip file, a Setup.exe file, or several versions of files for different Pocket PC Phone types and processors. Be sure to select the program designed for the Pocket PC Phone and your Pocket PC Phone processor type.
3. Read any installation instructions, Read Me files, or documentation that comes with the program. Many programs provide special installation instructions.
4. Connect your Pocket PC Phone and PC.
5. Double click the *.exe file.
?? If the file is an installer, the installation wizard will begin. Follow the directions on the screen. Once the software has been installed on your PC, the installer will automatically transfer the software to your Pocket PC Phone.
?? If the file is not an installer, you will see an error message stating that the program is valid but it is designed for a different type of PC. You will need to move this file to your Pocket PC Phone. If you cannot find any installation instructions for the program in the Read Me file or documentation, use ActiveSync Explore to copy the program file to the Program Files folder on your Pocket PC Phone. For more information on copying files using ActiveSync, see ActiveSync Help.

Once installation is complete, tap , **Programs**, and then the program icon to switch to it.

To add a program directly from the Internet

1. Determine your Pocket PC Phone and processor type so that you know which version of the software to install.

Tap  and then **Settings**. On the **System** tab, tap **About**. In the **Version** tab, make a note of the information in **Processor**.

2. Download the program to your Pocket PC Phone straight from the Internet using Pocket Internet Explorer. You may see a single *.xip, *.exe or *.zip file, a Setup.exe file, or several versions of files for different Pocket PC Phone types and processors. Be sure to select the program designed for the Pocket PC Phone and your Pocket PC Phone processor type.
- 4.3. Read any installation instructions, Read Me files, or documentation that comes with the program. Many programs provide special installation instructions.
4. Tap the file, such as a *.xip or *.exe file. The installation wizard will begin. Follow the directions on the screen.

To add a program to the Start menu

1. Tap , **Settings**, **Menus**, the **Start Menu** tab, and then the check box for the program. If you do not see the program listed, you can either use File Explorer on the Pocket PC Phone to move the program to the Start Menu folder, or use ActiveSync on the PC to create a shortcut to the program and place the shortcut in the Start Menu folder.

2. **Using File Explorer on the Pocket PC Phone:** Tap , **Programs**, **File Explorer**, and locate the program (tap the folder list, labeled **My Documents** by default, and then **My Pocket PC Phone** to see a list of all folders on the Pocket PC Phone). Tap and hold the program and tap **Copy** on the pop-up menu. Open the **Start Menu** folder located in the **Windows** folder, tap and hold a blank area of the window, and tap **Paste** on the pop-up menu.

3. The program will now appear on the  menu. For more information on using File Explorer, see “Finding and Organizing Information” earlier in this chapter.

4. **Using ActiveSync on the PC:** Use the Explorer in ActiveSync to explore your Pocket PC Phone files and locate the program. Right click the program, and then click **Create Shortcut**. Move the shortcut to the Start Menu folder in the Windows folder. The shortcut now appears on the  menu. For more information, see ActiveSync Help.

To remove programs

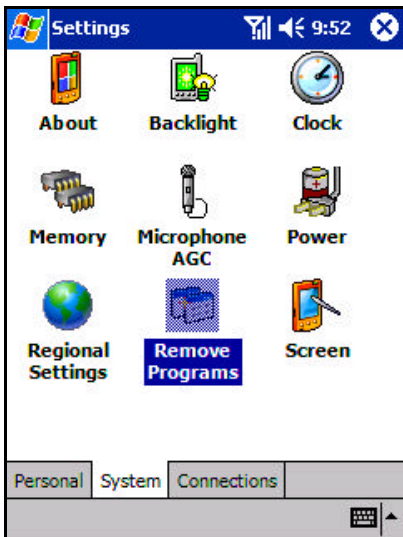

?? Tap  and then **Settings**.

On the **System** tab, tap **Remove Programs**.

?? If the program does not appear in the list of installed programs, use File Explorer on your Pocket PC Phone to locate the program, tap and hold the program, and then tap **Delete** on the pop-up menu.

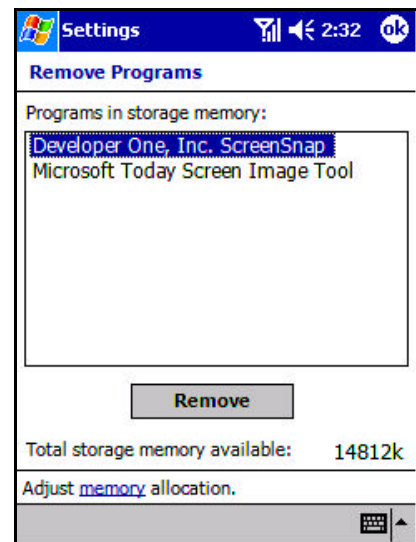

Chapter 4: Phone Features

About Your Phone

As well all the standard features of a mobile phone - such as mailbox and call log – there are several dialing features unique to your Pocket PC Phone. For example, you can take notes while talking, dial directly from Microsoft Contacts and easily transfer contacts between your Smart Card and the RAM of your Pocket PC Phone.

Additionally, like with a conventional mobile phone, you easily use one hand to access and navigate through the important features of your Pocket PC Phone and make calls.

Installing the Smart Card

?? Remove the stylus.



?? Turn over your Pocket PC Phone and open the Smart Card door with the stylus.



?? Slide the Smart Card into the slot until it clicks into place. The Smart Card should be inserted exactly as the picture shows.



Removing the Smart Card



Make sure you have saved any data in open programs; opening the Smart Card door will turn your Pocket PC Phone off.

?? Remove the stylus.



?? Turn over your Pocket PC Phone and open the Smart Card door with the stylus.



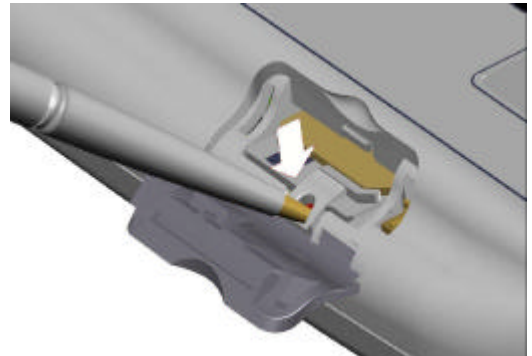

Press the point of your stylus into the hole until the Smart Card springs out; then use your fingers to finish removing.

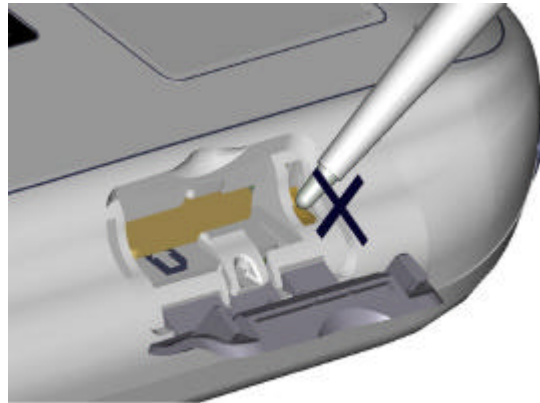

Please pay particular attention to the stylus positions in the picture above related to removing the Smart Card, and the picture to the right. Do not put the stylus in the hole in the picture to the right; it will permanently damage your Pocket PC Phone.



About The Dialer Screen

To access the Dialer Screen, tap  and then **Phone**, or press . From the dialer screen you can make calls, access **Call Log**, **Speed Dial** and **Phone Settings**. You can also find signal status information and important icons that tell you about your call.

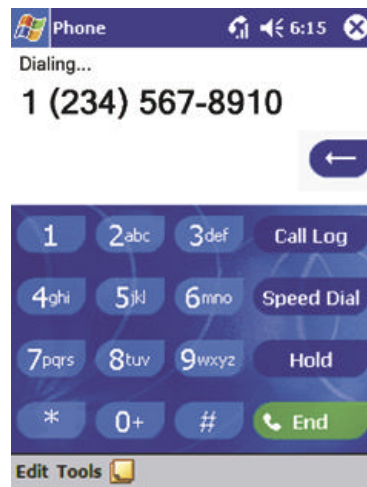



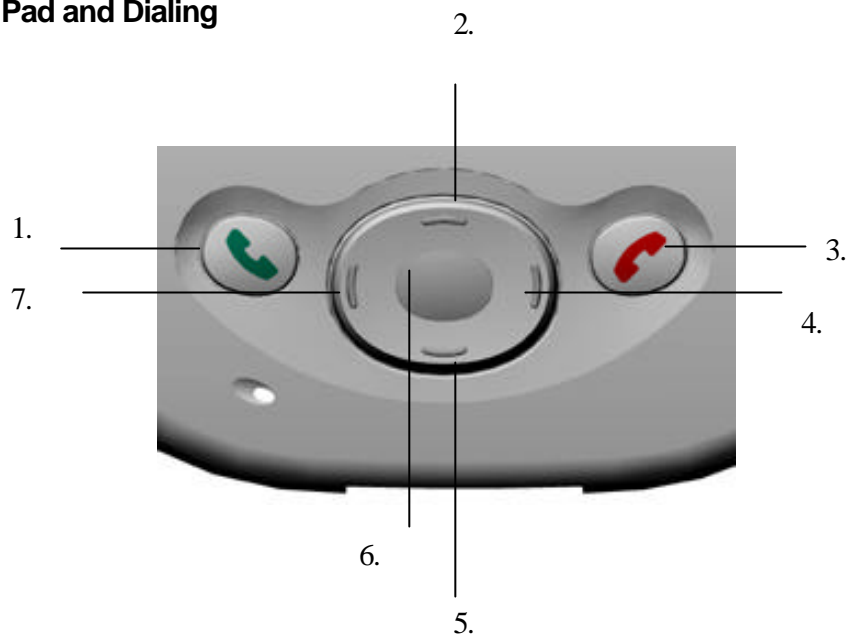



The Navigation Pad and Dialing



1. **Take Call** – Press to take an incoming call.
Dialer Screen – Press to activate the dialer screen.
Speakerphone – Press and hold to turn on/off the speakerphone.
Dial – Press to dial a number.
2. **Scroll Up** – Press to scroll up through a list.
3. **End Call** – Press to end a call.
Phone Signal - Press and hold to turn on/off your phone.
4. **Call Log** – After launching the dialer screen, press to enter the Call Log feature.
5. **Scroll Down** – Press to scroll down through a list.
6. **Center** – Press to select.
7. **Speed Dial** – After launching the dialer screen, press to enter the Speed Dial feature.

The icons listed below may be seen in the top bar of the screen:

-  - **Phone off or out of network service** - tap this icon to turn on the phone.
-  - **In network service** - tap this icon to turn off the phone.
-  - **Call Missed** - tap this icon to view the call(s) you missed.
-  - **Unread E-mail or SMS** - tap the icon to view unread SMS or E-mail.
-  - **Connecting in progress** - the icon will disappear when you are connected to your ISP.
-  - **Shows your connection is at full strength**

Entering Your PIN

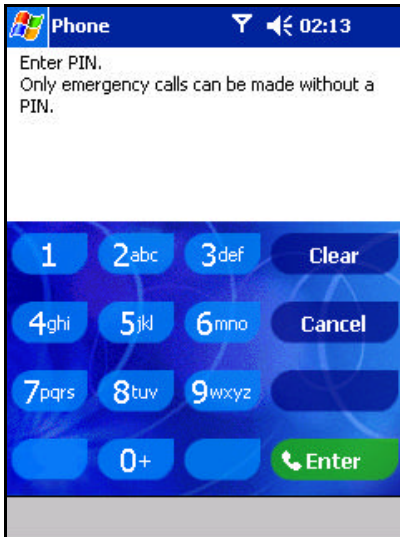

Most Smart Cards are preset with a PIN (Personal Identity Number), provided by your mobile service provider, which you need to enter whenever you use your Pocket PC Phone. If you are required to enter a PIN, try 1234 as your default.



1. Enter the preset PIN from your mobile phone service provider (please contact your mobile service provider).
2. Tap **Enter**.
 - ☐ If your PIN is entered incorrectly three times, the Smart Card will be blocked. If this happens, you can unblock it with the **PIN Unblocking Key** from your mobile phone service provider.
3. To change your default PIN go to **Settings**, tap **Phone** and then tap **Change PIN**.

Checking You Are Connected

The default settings for your Pocket PC Phone are programmed to assume you want to use your phone so, providing you have inserted a Smart Card, your Pocket PC Phone will turn on your mobile phone connection to your service provider's network.



The icon  indicates that you are connected to the network of your mobile phone operator. Thereafter a full strength signal is indicated by , and as the strength of the signal diminishes so will the number of vertical bars in the icon, with no bars indicating no signal.

☐ If you have turned the phone off, removed and then reinserted the Smart Card, your Pocket PC Phone will not automatically turn the phone on. In this event, turn it on as described below in **Turning the Phone On and Off**.



Turning The Phone On and Off

As indicated above your Pocket PC Phone will turn on your phone when you insert a Smart Card. However, you can choose to turn off your phone and just use the Pocket PC features at any time— and then turn the phone back on when you want.

To turn off the phone

Press and hold the  button until  appears in the navigation bar.

To turn on the phone

Press and hold  until  appears in the top toolbar.

Adjusting the Phone Volume



1. You can tap the  icon or press the volume on the side bar of your Pocket PC Phone during a call.
 - ▣ To adjust the conversation phone volume, you must do it during a call. If you adjust the volume at another time it will affect the ring and notification levels, and MP3.

Back Spacing and Deleting

If you tap a wrong number when you are keying in, you can back space to erase individual numbers one at a time or you can delete all the numbers in the window.

To back space over numbers

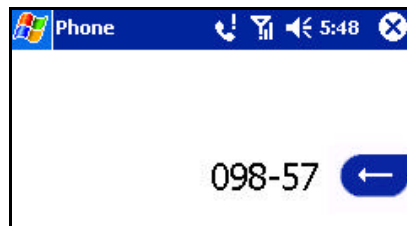

Tap here to back space and erase numbers individually.

To delete the number

Tapping **Clear** will erase **098-57**, or you can hold down the backspace key.

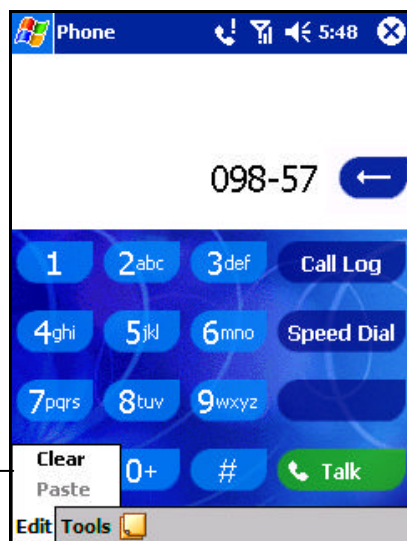



Basic Dialing Features

In this section you can find information on the basic features of your phone: making or answering a call, using the speakerphone, making notes during a call, putting a call on hold, and using the conferencing facility. You can also send SMS from the Dialer screen.

Making a call

With your Pocket PC Phone, you can make a call from the **Dialer**, **Speed Dial**, **Call Log**, **Contacts** and **Phone Book**.

To make a call from the Dialer

1. Press  to bring up the dialer screen.
2. Tap the number into the keypad and then tap  or press  button.

The number will appear here.

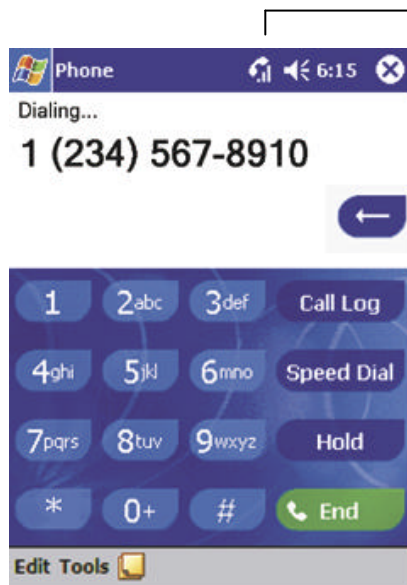

The signal icon will change when you are making a call.

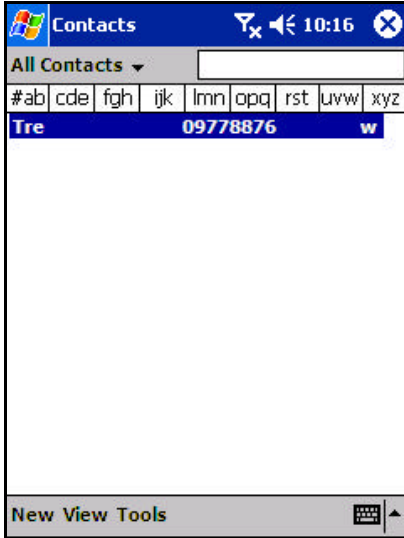

Tap the number you wish to dial here.

To make a call from Contacts



You can make a call from Contacts in the following way:

1. Press the Microsoft Contacts Button, find the contact and then tap  twice – once to send to the dialer screen and once to call.

 The pop-up menu and  button will by default display **Call Work Tel.** However, you can customize so that the mobile number or e-mail is displayed instead:

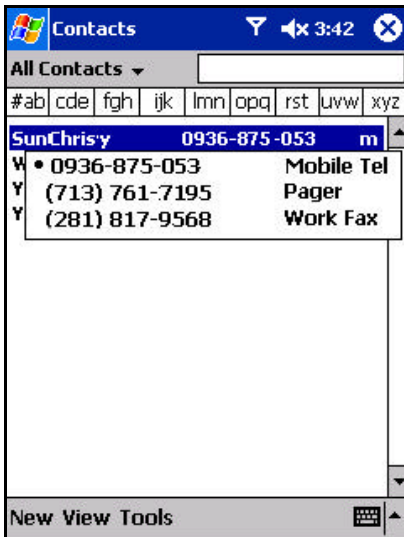

Either:

1. Select a contact in the contact list and then press left or right on the navigation pad – the number on the screen will change.

Or:

1. In the contacts list tap the “w” in the right column next to the contact you want to customize. A pop-up menu will display the phone numbers and e-mail addresses for this contact with a dot next to the priority number.
2. In the pop-up menu select a priority. If you selected mobile number, “m” should now be in the right column next to the contact.

To make a call from Speed Dial (A)



Speed dial is a list you can create of often-dialed numbers. Information on adding a number to Speed Dial is detailed later in this chapter.

By memorizing the position of a number in the Speed Dial list, you can dial the number by entering its position number. For example:

In the picture on the left John Fredericks is at position 4. To dial his number simply tap and hold "4" on the dialer keypad. If the number holds a position of 10 or more tap the first number "1", and then tap and hold the second number "0" to dial.

Another way to speed dial a number is to simply tap on the position number next to the entry.

To make a call from Speed Dial (B)



Alternatively, if you **do not** remember the position of a number in the **Speed Dial** list use the method below:

1. Go to **Phone**, press once on the left side of navigation pad, or tap **Speed Dial**.
2. In **Speed Dial** use the navigation pad to find the number you want to dial, and then press .

To make a call from the Call Log

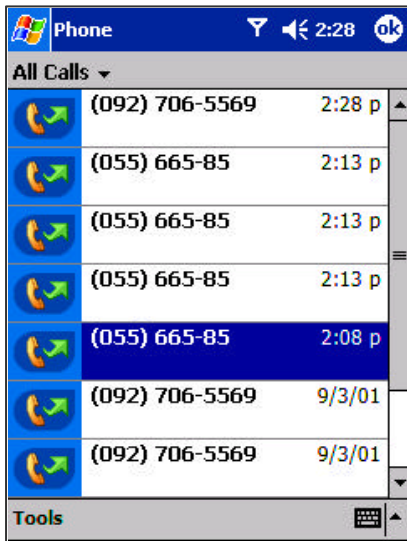

1. Go to **Phone** and press the right side of the navigation pad or tap **Call Log**.
2. Find the call details by first selecting the category it is filed under. For example, if it is in **All calls** select **All calls** from the drop-down menu in the top-left corner.
3. Use the navigation pad to find the number and then tap or the icon to the left of the number you wish to call.

Icon is for incoming calls; icon is for outgoing calls and icon is for missed calls.

To make a call from Phone Book

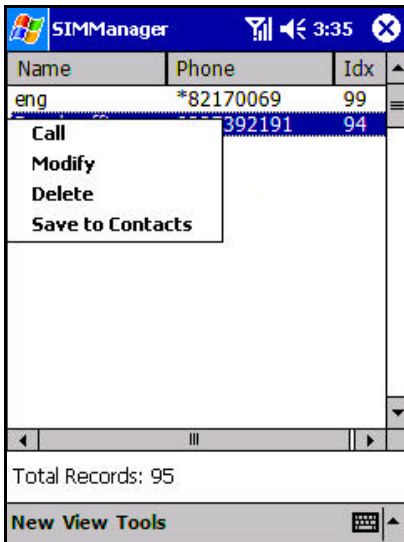

1. Tap , **Programs**, and then tap **Phone Book**– wait for your Smart Card contents to load.
2. Tap and hold the name or phone number of the person you wish to call, and then select **Call** from the pop-up menu.

Or
3. Tap the name or phone number of the person you wish to call, tap **Tools** and then tap **Call**.

To send SMS in phone dialer

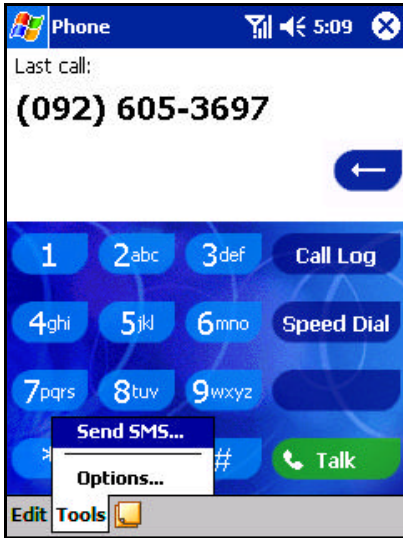

Tap to send the message.



Tap to show or hide the complete header.

Tap to show / hide the recording toolbar.

Tap to display the Address Book.



Tap to insert common messages.

1. Tap **Tools**, and then **Send SMS**.
 2. The screen below will appear.
 3. Tap **New**.
 4. In the **To** field, enter either **e-mail address** or **SMS number** of one or more recipients, separating them with a semicolon, or select a name from the contact list by tapping the **Address Book** button. All e-mail addresses entered in the e-mail fields in Contacts appear in the Address Book.
 5. Compose your message. To enter preset or frequently used messages, tap **My Text** and select a message.
 6. Tap **Send** when
 7. finished the message. If you are working offline, the message is moved to the Outbox folder and will be sent the next time you connect.
1. Whether you want to send or read **E-mail** or a **SMS**, you can swap by tapping **Services** then choose what service you want.
 2. If you are sending an SMS message and want to know if it was received, tap **Edit**, **Options**, and select **Request SMS text message delivery notification** before sending the message.

Enabling the Speakerphone Mode

Your Pocket PC Phone has a speakerphone that allows you to talk hands-free and/or let other people to listen to the caller.



1. Wait until the phone is ringing.
2. Hold down the  button until the speakerphone comes on and the icon  appears in the top toolbar.
3. To turn off the speakerphone hold down the  button again.

 Do not leave the phone in speakerphone mode and hold it to your ear; the sound may damage your ear.

Answering or Rejecting a Call

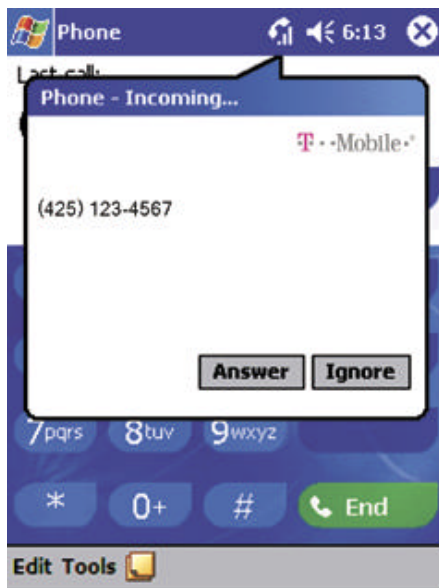



?? Tap **Answer**, or press  on your Pocket PC Phone.

?? Tap **Ignore** or press  to reject the call.

 If you reject a call the busy tone will be sent out, or the call will go to voice mail.

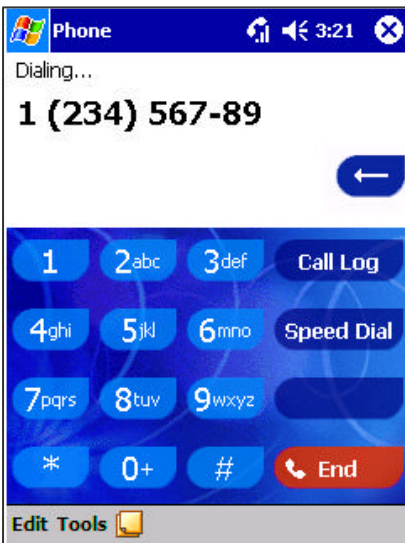
Ending a Call



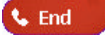

?? Once an incoming or outgoing call is proceeding, you can press  or tap  to end the call.

Managing More Than One Call

Your Pocket PC Phone will notify you when you have another caller - you have the choice of rejecting or accepting the incoming call. If you accept you can then choose to swap between this caller and the original, or set up a conference call between all 3 parties. You can, of course, also initiate the situation above- with conference calling you can create a conversation between up to 6 people.

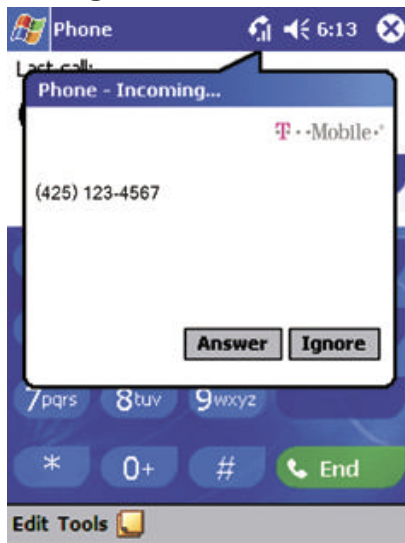
Putting a Call on Hold



1. If another person is trying to call you when you are talking on the phone, the screen to the left will pop up.
2. Tap **Answer** to take the 2nd call and put the 1st call on hold.
3. To end the 2nd call and go back to the 1st, tap **End** or .

1.

To swap between calls

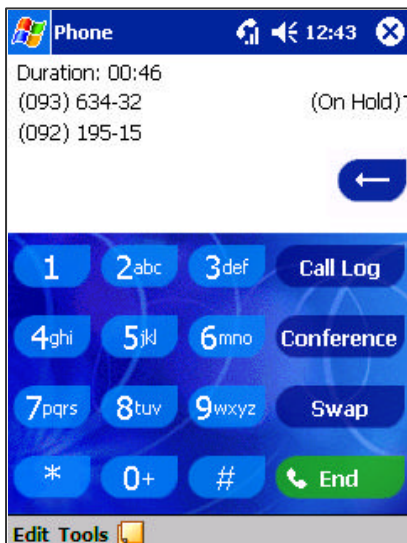

Indicates which number is on hold

?? You can choose to swap between 2 calls by pressing **Swap**.

To set up conference calling

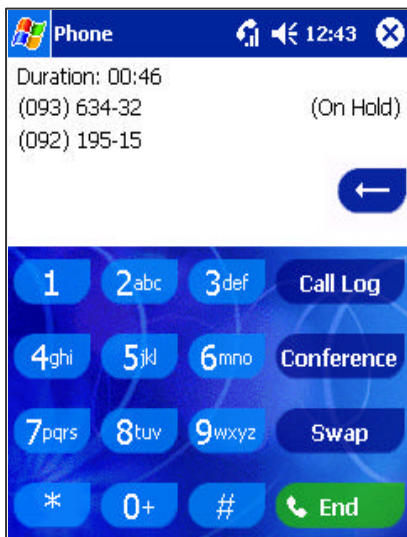

1. Either put a call on hold, dial a 2nd number and wait for it to be picked up. Or, accept a 2nd incoming call when you already have one in progress.
2. In the screen that appears tap **Conference**.

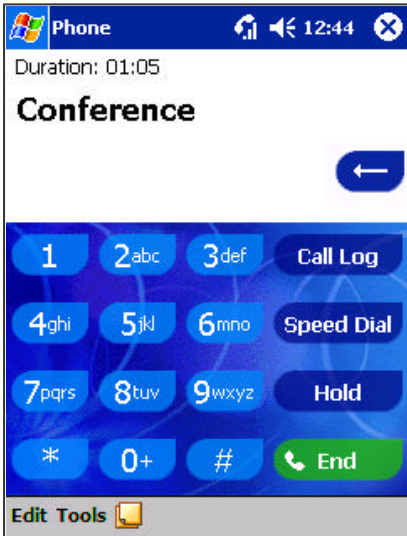





3. If the conference connection is successful, the screen at left will appear.
4. To add additional people to your conference call tap **Hold**, key in the number, and then **Resume** to return and continue.

Making a Note

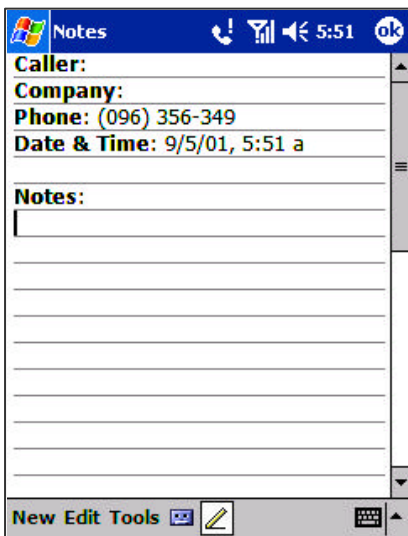
Regardless of whether you call from the Dialer, Contacts, Call Log, Speed Dial or Phone Book, you can take a note during a call. After you have finished the note it will be saved as an attachment to your call in one of the Call Log folders.

To make a note



1. After you have entered a number and tapped  or , tap the  icon situated at the bottom of the screen.
2. Use any of the input methods to record your note and then tap **OK**. You can finish your note during or after the call.

To view a note

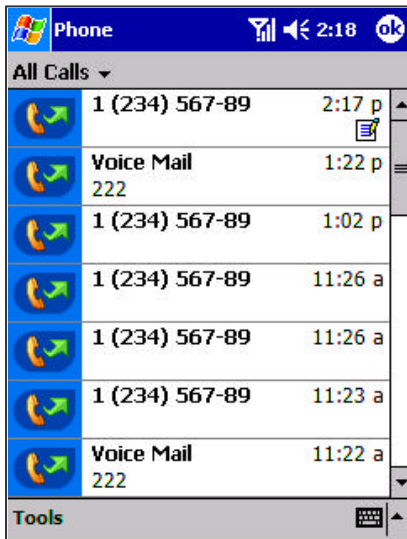

1. Press the right side of the navigation pad or tap **Call Log**, tap and hold the call, and then from the pop-up menu tap **View Note**. (The icon  indicates a note).
2. Or go to **Notes**, and then tap the name of the file from the list.

 If you decide to create a contact for this caller – see “Adding and Transferring Contact Information” – the call and file names will be amended to the name of the new contact and the file will be unaffected.

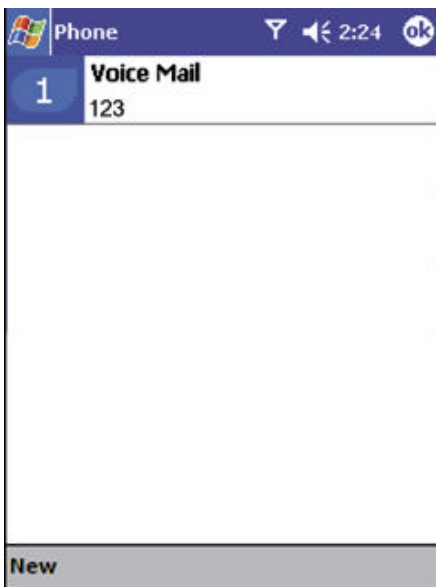

Call Related Features

Checking Your Voice Mail



?? The first speed dial location defaults as your voice mailbox. When you insert your Smart Card into your Pocket PC Phone, it will automatically detect and set as default the voice mailbox number of your mobile service provider.

To retrieve your voice mail

?? Press  the left side of the navigation pad, select  **Voice Mail** and then press .

Adding and Transferring Contact Information

Since there are a number of ways to enter and store telephone numbers and contacts on your Pocket PC Phone and a number of ways to make a phone call, it is important to be able transfer those contacts between the programs used to make a call.

Places where contacts can enter your Pocket PC Phone and be stored

- ?? Your Smart Card - You interchange your Smart Card between your Pocket PC Phone and another Pocket PC Phone; while using the other Pocket PC Phone you create one or more new contacts on the Smart Card.
- ?? Microsoft Contacts.
- ?? Call Log – New contact numbers can be found in incoming or missed calls.

Why transfer numbers?

- ? ? In the event you lose your Smart Card while using it with another Pocket PC Phone, your Smart Card numbers will be backed up to your Pocket PC Phone.
- ? ? If you want to transfer a number to **Speed Dial** it must be in **Contacts**, not on the Smart Card.
- ? ? If you are using your Smart Card with another Pocket PC Phone, you may need the numbers stored in Microsoft Contacts.
- ? ? Transferring numbers to Microsoft Contacts allows you to create a more detailed record.

Microsoft Contacts: Adding and transferring contacts

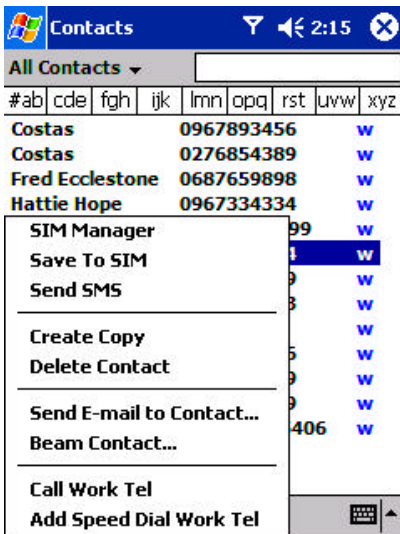

1. To create a contact, see creating a contact in **Chapter 8**.
2. To transfer a contact to your Smart Card, press and hold the center of the navigation pad - or tap and hold the contact - and then select **Save to SIM** from the pop-up menu.
3. To transfer a contact to **Speed Dial**, press and hold the center of the navigation pad - or tap and hold the contact - and then select **Add Speed Dial Work Tel** from the pop-up menu.
4. In the next screen add the contact details, select a location and tap **OK**.

By default the **Location** function will give you the next available position in the **Speed Dial** list. If you want to put a number in a position that is already occupied, the new number will replace the number already there.

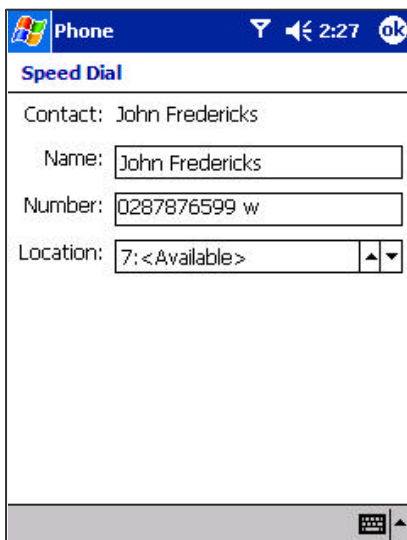

Phone Book: Adding and transferring contacts

To create a Smart Card contact

1. Tap **Phone Book** (wait for Smart Card contents to load), then **New**.
2. Fill in the **Name** and **Number** details and tap **Save**.

To transfer contacts from Smart Card to Microsoft Contacts

1. Tap **Phone Book** (wait for Smart Card contents to load), then
Either:
Tap **Tools**, then **Copy All to Contacts**.

Or:

Press and hold the center of the navigation pad— or tap and hold a contact from the list - and then select **Copy to Contacts** from the pop-up menu.

To transfer a number to Speed Dial

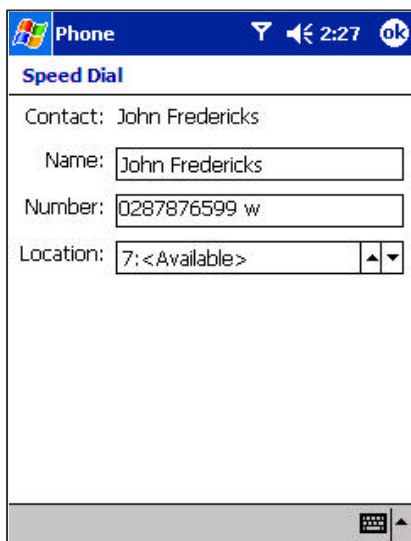

1. Press , either the left side of the navigation pad or **Speed Dial**, and then **New**.
2. Find the contact you want to add, and then press the navigation pad center.
3. When the contact name and number appears in the screen, select an available location using the arrow keys.

 By default the **Location** function will give you the next available position in the **Speed Dial** list. If you want to put a number in a position that is already occupied, the new number will replace the number already there.

To add a record to Microsoft Contacts from Call Log

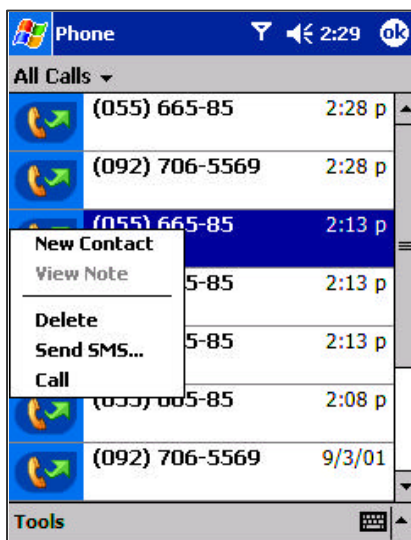

1. Press , and then the right side of the navigation pad.
2. Find the call details by first selecting the category it is filed under. For example, if it is a missed call select **Missed** from the drop-down menu in the top-left corner.
3. Press and hold the navigation pad center; in the pop-up menu that appears select **New Contact**.
4. In the **New Contact** screen add additional contact details and press the navigation pad center or tap **OK**.
5. The call details in the **Call Log** will then be amended and displayed under the name of the contact, not the telephone number.