

# Smart Phone User Manual

[www.htc.com](http://www.htc.com)



Congratulations on the purchase of your new Windows Mobile® Smartphone!

**Please Read Before Proceeding.**

**THIS PHONE IS NOT FULLY CHARGED WHEN YOU TAKE IT OUT OF THE BOX.**

**DO NOT REMOVE THE BATTERY PACK WHEN THE PHONE IS CHARGING.**





**YOUR WARRANTY IS INVALIDATED IF YOU OPEN OR TAMPER WITH THE PHONE'S OUTER CASING.**

**PRIVACY RESTRICTIONS**

Some countries require full disclosure of recorded telephone conversations, and stipulate that you must inform the person with whom you are speaking that the conversation is being recorded. Always obey the relevant laws and regulations of your country when using the recording feature of your phone.

**COPYRIGHT INFORMATION**

Copyright © 2007 High Tech Computer Corp. All Rights Reserved.

    ExtUSB are trademarks and/or service marks of High Tech Computer Corp.

Microsoft, MS-DOS, Windows, Windows Vista, Windows NT, Windows Server, Windows Mobile, ActiveSync, Windows Media, Excel, Internet Explorer, MSN, Outlook, PowerPoint, and Word are either registered trademarks or trademarks of Microsoft Corporation in the United States and/or other countries.

Bluetooth and the Bluetooth logo are trademarks owned by Bluetooth SIG, Inc.

Wi-Fi is a registered trademark of the Wireless Fidelity Alliance, Inc.

microSD is a trademark of SD Card Association.

Java, J2ME and all other Java-based marks are trademarks or registered trademarks of Sun Microsystems, Inc. in the United States and other countries.

Copyright © 2007, Adobe Systems Incorporated.

Copyright © 2007, Macromedia Netherlands, B.V.

Macromedia, Flash, Macromedia Flash, Macromedia Flash Lite and Reader are trademarks and/or registered trademarks of Macromedia Netherlands, B.V. or Adobe Systems Incorporated.

Copyright © 2007, JATAAYU SOFTWARE (P) LTD. All Rights Reserved.

Copyright © 2007, Dilithium Networks, Inc. All Rights Reserved.

ArcSoft MMS Composer™ Copyright © 2003-2007, ArcSoft, Inc. and its licensors. All Rights Reserved. ArcSoft and the ArcSoft logo are registered trademarks of ArcSoft, Inc. in the United States and/or other countries.

Licensed by QUALCOMM Incorporated under one or more of the following patents:

4,901,307 ; 5,490,165 ; 5,056,109 ; 5,504,773 ; 5,101,501 ; 5,778,338 ; 5,506,865  
5,109,390 ; 5,511,073 ; 5,228,054 ; 5,535,239 ; 5,710,784 ; 5,267,261 ; 5,544,196  
5,267,262 ; 5,568,483 ; 5,337,338 ; 5,659,569 ; 5,600,754 ; 5,414,796 ; 5,657,420  
5,416,797

All other company, product and service names mentioned herein are trademarks, registered trademarks or service marks of their respective owners.

HTC shall not be liable for technical or editorial errors or omissions contained herein, nor for incidental or consequential damages resulting from furnishing this material. The information is provided "as is" without warranty of any kind and is subject to change without notice. HTC also reserves the right to revise the content of this document at any time without prior notice.

No part of this document may be reproduced or transmitted in any form or by any means, electronic or mechanical, including photocopying, recording or storing in a retrieval system, or translated into any language in any form without prior written permission of HTC.

## Important Health Information and Safety Precautions

When using this product, the safety precautions below must be taken to avoid possible legal liabilities and damages. Retain and follow all product safety and operating instructions. Observe all warnings in the operating instructions on the product.

To reduce the risk of bodily injury, electric shock, fire, and damage to the equipment, observe the following precautions.

### **ELECTRICAL SAFETY**

This product is intended for use when supplied with power from the designated battery or power supply unit. Other usage may be dangerous and will invalidate any approval given to this product.

### **SAFETY PRECAUTIONS FOR PROPER GROUNDING INSTALLATION**

**CAUTION:** Connecting to an improperly grounded equipment can result in an electric shock to your device.

This product is equipped with a USB Cable for connecting with desk-top or notebook computer. Be sure your computer is properly grounded (earthed) before connecting this product to the computer. The power supply cord of a desktop or notebook computer has an equipment-grounding conductor and a grounding plug. The plug must be plugged into an appropriate outlet which is properly installed and grounded in accordance with all local codes and ordinances.

### **SAFETY PRECAUTIONS FOR POWER SUPPLY UNIT**

- **Use the correct external power source**

A product should be operated only from the type of power source indicated on the electrical ratings label. If you are not sure of the type of power source required, consult your authorized service provider or local power company. For a product that operates from battery power or other sources, refer to the operating instructions that are included with the product.

- **Handle battery packs carefully**

This product contains a Li-ion Polymer battery. There is a risk of fire and burns if the battery pack is handled improperly. Do not attempt to open or service the battery pack. Do not disassemble, crush, puncture, short external contacts or circuits, dispose of in fire or water, or expose a battery pack to temperatures higher than **60°C (140°F)**.



**WARNING:** DANGER OF EXPLOSION IF BATTERY IS INCORRECTLY REPLACED. TO REDUCE RISK OF FIRE OR BURNS, DO NOT DISASSEMBLE, CRUSH, PUNCTURE, SHORT EXTERNAL CONTACTS, EXPOSE TO TEMPERATURE ABOVE **60°C (140°F)**, OR DISPOSE OF IN FIRE OR WATER. REPLACE ONLY WITH SPECIFIED BATTERIES. RECYCLE OR DISPOSE OF USED BATTERIES ACCORDING TO THE LOCAL REGULATIONS OR REFERENCE GUIDE SUPPLIED WITH YOUR PRODUCT.



**Note** This product should be operated only with the following designated Battery Pack(s).

- SImplo, model LIBR160
- Sanyo, model LIBR160
- SAMSUNG, model WING160

- **Take extra precautions**

- Keep the battery or device dry and away from water or any liquid as it may cause a short circuit.
- Keep metal objects away so they don't come in contact with the battery or its connectors as it may lead to short circuit during operation.
- Do not use a battery that appears damaged, deformed, or discolored, or the one that has any rust on its casing, overheats, or emits a foul odor.
- Always keep the battery out of the reach of babies and small children, to avoid swallowing of the battery. Consult the doctor immediately if the battery is swallowed.

- If the battery leaks:
  - Do not allow the leaking fluid to come in contact with skin or clothing. If already in contact, flush the affected area immediately with clean water and seek medical advice.
  - Do not allow the leaking fluid to come in contact with eyes. If already in contact, DO NOT rub; rinse with clean water immediately and seek medical advice.
  - Take extra precautions to keep a leaking battery away from fire as there is a danger of ignition or explosion.
- Communicate the appropriate steps immediately in case a hazard occurs.

#### **SAFETY PRECAUTIONS FOR DIRECT SUNLIGHT**

Keep this product away from excessive moisture and extreme temperatures. Do not leave the product or its battery inside a vehicle or in places where the temperature may exceed **60°C (140°F)**, such as on a car dashboard, window sill, or behind a glass that is exposed to direct sunlight or strong ultraviolet light for extended periods of time. This may damage the product, overheat the battery, or pose a risk to the vehicle.

#### **PREVENTION OF HEARING LOSS**



**CAUTION:** Permanent hearing loss may occur if earphones or headphones are used at high volume for prolonged periods of time.

**Note** For France, mobile headphones, earphones, and wired remote controllers (listed below) for this device have been tested to comply with the Sound Pressure Level requirement laid down in NF EN 50332-1:2000 and/or NF EN 50332-2:2003 standards as required by French Article L. 5232-1.

1. Earphone, manufactured by HTC, Model name: HS S168 and S200.
2. Wired Remote Controller, manufactured by HTC, Model RC W100.

**SAFETY IN AIRCRAFT**

Due to the possible interference caused by this product to an aircraft's navigation system and its communications network, using this device's phone function on board an airplane is against the law in most countries. If you want to use this device when on board an aircraft, remember to turn off the phone by switching to Flight Mode.

**ENVIRONMENT RESTRICTIONS**

Do not use this product in gas stations, fuel depots, chemical plants or where blasting operations are in progress, or in potentially explosive atmospheres such as fuelling areas, fuel storehouses, below deck on boats, chemical plants, fuel or chemical transfer or storage facilities, and areas where the air contains chemicals or particles, such as grain, dust, or metal powders. Please be aware that sparks in such areas could cause an explosion or fire resulting in bodily injury or even death.

**EXPLOSIVE ATMOSPHERES**

When in any area with a potentially explosive atmosphere or where flammable materials exist, the product should be turned off and the user should obey all signs and instructions. Sparks in such areas could cause an explosion or fire resulting in bodily injury or even death. Users are advised not to use the equipment at refueling points such as service or gas stations, and are reminded of the need to observe restrictions on the use of radio equipment in fuel depots, chemical plants, or where blasting operations are in progress.

Areas with a potentially explosive atmosphere are often, but not always, clearly marked. These include fueling areas, below deck on boats, fuel or chemical transfer or storage facilities, and areas where the air contains chemicals or particles, such as grain, dust, or metal powders.

**ROAD SAFETY**

Vehicle drivers in motion are not permitted to use telephony services with handheld devices, except in the case of emergency. In some countries, using hands-free devices as an alternative is allowed.

**SAFETY PRECAUTIONS FOR RF EXPOSURE**

- Avoid using your device near metal structures (for example, the steel frame of a building).
- Avoid using your device near strong electromagnetic sources, such as microwave ovens, sound speakers, TV and radio.
- Use only original manufacturer-approved accessories, or accessories that do not contain any metal.
- Use of non-original manufacturer-approved accessories may violate your local RF exposure guidelines and should be avoided.

**INTERFERENCE WITH MEDICAL EQUIPMENT FUNCTIONS**

This product may cause medical equipment to malfunction. The use of this device is forbidden in most hospitals and medical clinics.

If you use any other personal medical device, consult the manufacturer of your device to determine if it is adequately shielded from external RF energy. Your physician may be able to assist you in obtaining this information.

Turn the phone OFF in health care facilities when any regulations posted in these areas instruct you to do so. Hospitals or health care facilities may be using equipment that could be sensitive to external RF energy.

**HEARING AIDS**

Some digital wireless phones may interfere with some hearing aids. In the event of such interference, you may want to consult your service provider, or call the customer service line to discuss alternatives.

**NONIONIZING RADIATION**

This product should be operated in the suggested normal condition only to ensure the radiative performance and safety of the interference. As with other mobile radio transmitting equipment, users are advised that for satisfactory operation of the equipment and for the safety of personnel, it is recommended that no part of the human body be allowed to come too close to the antenna during operation of the equipment.

Use only the supplied integral antenna. Use of unauthorized or modified antennas may impair call quality and damage the phone, causing loss of performance and SAR levels exceeding the recommended limits as well as result in non-compliance with local regulatory requirements in your country.



To assure optimal phone performance and ensure human exposure to RF energy is within the guidelines set forth in the relevant standards, always use your device only in its normal-use position. Do not touch or hold the antenna area unnecessarily when placing or receiving a phone call. Contact with the antenna area may impair call quality and cause your device to operate at a higher power level than needed. Avoiding contact with the antenna area when the phone is IN USE optimizes the antenna performance and the battery life.



## General Precautions

- **Heed service markings**

Except as explained elsewhere in the Operating or Service documentation, do not service any product yourself. Service needed on components inside these compartments should be done by an authorized service technician or provider.

- **Damage requiring service**

Unplug the product from the electrical outlet and refer servicing to an authorized service technician or provider under the following conditions:

- Liquid has been spilled or an object has fallen into the product.
- The product has been exposed to rain or water.
- The product has been dropped or damaged.
- There are noticeable signs of overheating.
- The product does not operate normally when you follow the operating instructions.

- **Avoid hot areas**

The product should be placed away from heat sources such as radiators, heat registers, stoves, or other products (including, but not limited to, amplifiers) that produce heat.

- **Avoid wet areas**  
Never use the product in a wet location.
- **Avoid using your device after a dramatic change in temperature**  
When you move your device between environments with very different temperature and/or humidity ranges, condensation may form on or within the device. To avoid damaging the device, allow sufficient time for the moisture to evaporate before using the device.  
**NOTE:** When taking the device from low-temperature conditions into a warmer environment or from high-temperature conditions into a cooler environment, allow the device to acclimate to room temperature before turning on the power.
- **Avoid pushing objects into product**  
Never push objects of any kind into cabinet slots or other openings in the product. Slots and openings are provided for ventilation. These openings must not be blocked or covered.
- **Mounting Accessories**  
Do not use the product on an unstable table, cart, stand, tripod, or bracket. Any mounting of the product should follow the manufacturer's instructions, and should use a mounting accessory recommended by the manufacturer.
- **Avoid unstable mounting**  
Do not place the product with an unstable base.
- **Use product with approved equipment**  
This product should be used only with personal computers and options identified as suitable for use with your equipment.
- **Adjust the volume**  
Turn down the volume before using headphones or other audio devices.
- **Cleaning**  
Unplug the product from the wall outlet before cleaning. Do not use liquid cleaners or aerosol cleaners. Use a damp cloth for cleaning, but NEVER use water to clean the LCD screen.

# Contents

<b>Chapter 1</b>	<b>Getting Started</b>	<b>15</b>
1.1	Getting to Know Your Phone and Its Accessories.....	16
1.2	Starting Up .....	22
1.3	Home Screen .....	24
1.4	Start Menu .....	30
1.5	Quick List .....	34
1.6	Entering Information.....	34
1.7	Battery Information.....	38
<b>Chapter 2</b>	<b>Using Phone Features</b>	<b>41</b>
2.1	Using the Phone.....	42
2.2	Making a Call.....	43
2.3	Making a Video Call .....	45
2.4	Receiving a Call .....	47
2.5	In-Call Options .....	48
2.6	Additional Dialing Information .....	49
2.7	SIM Tool Kit (STK) .....	50
2.8	Setting Up Bluetooth SIM Access for Car Kit Phones .....	51
<b>Chapter 3</b>	<b>Synchronizing Information with Your Computer</b>	<b>53</b>
3.1	About Synchronization .....	54
3.2	Using Microsoft Windows Mobile® Device Center.....	55

3.3	Installing and Using Microsoft ActiveSync® .....	56
3.4	Synchronizing with Your Computer .....	57
3.5	Synchronizing via Bluetooth .....	59
3.6	Synchronizing Music and Video .....	60
<b>Chapter 4 Managing your Phone</b>		<b>61</b>
4.1	Personalizing Your Phone .....	62
4.2	Adding and Removing Programs .....	66
4.3	Using Task Manager and Managing Memory .....	67
4.4	Managing and Backing Up Files .....	68
4.5	Protecting Your Phone .....	70
4.6	Restarting Your Phone.....	71
4.7	Resetting Your Phone .....	72
<b>Chapter 5 Organizing Phone Information</b>		<b>73</b>
5.1	Contacts .....	74
5.2	SIM Manager .....	77
5.3	Calendar .....	78
5.4	Tasks .....	81
5.5	Quick Notes .....	82
5.6	Voice Notes.....	82
<b>Chapter 6 Exchanging Messages</b>		<b>85</b>
6.1	Messaging .....	86
6.2	Text Message.....	87
6.3	MMS Messages.....	88
6.4	VoiceMail .....	91

6.5 Setting Up E-mail Accounts.....	92
6.6 E-mail .....	95

## **Chapter 7 Working with Company E-mails and Meeting Appointments 101**

7.1 Synchronizing with Your Company E-mail Server .....	102
7.2 Working with Company E-mails.....	103
7.3 Managing Meeting Requests .....	107
7.4 Finding Contacts in the Company Directory .....	109
7.5 E-mail Security .....	110

## **Chapter 8 Getting Connected 113**

8.1 Comm Manager.....	114
8.2 Connecting to the Internet .....	115
8.3 Internet Explorer Mobile.....	119
8.4 Internet Sharing.....	120
8.5 Bluetooth.....	121
8.6 Windows Live™ .....	130
8.7 Windows Live Messenger .....	132

## **Chapter 9 Experiencing Multimedia 137**

9.1 Camera.....	138
9.2 Pictures & Videos .....	146
9.3 Windows Media Player Mobile .....	148
9.4 Streaming Media .....	152
9.5 Audio Manager .....	154
9.6 MP3 Trimmer .....	159

9.7 Using Audio Booster.....	160
9.8 Flash Lite Player .....	163
9.9 Java .....	164

## **Chapter 10 Using Other Applications 167**

10.1 Microsoft® Office Mobile .....	168
10.2 Microsoft® Office Word Mobile .....	168
10.3 Microsoft® Office Excel® Mobile .....	170
10.4 Microsoft® Office PowerPoint® Mobile .....	173
10.5 Adobe® Reader® LE.....	175
10.6 Speed Dial.....	176
10.7 Voice Speed Dial.....	177

## **Appendix 179**

A.1 Regulatory Notices .....	180
A.2 Specifications .....	186

## **Index 189**

# Chapter 1

## Getting Started

**1.1 Getting to Know Your Phone  
and Its Accessories**

**1.2 Starting Up**

**1.3 Home Screen**

**1.4 Start Menu**

**1.5 Quick List**

**1.6 Entering Information**

**1.7 Battery Information**

### 1.1 Getting to Know Your Phone and Its Accessories

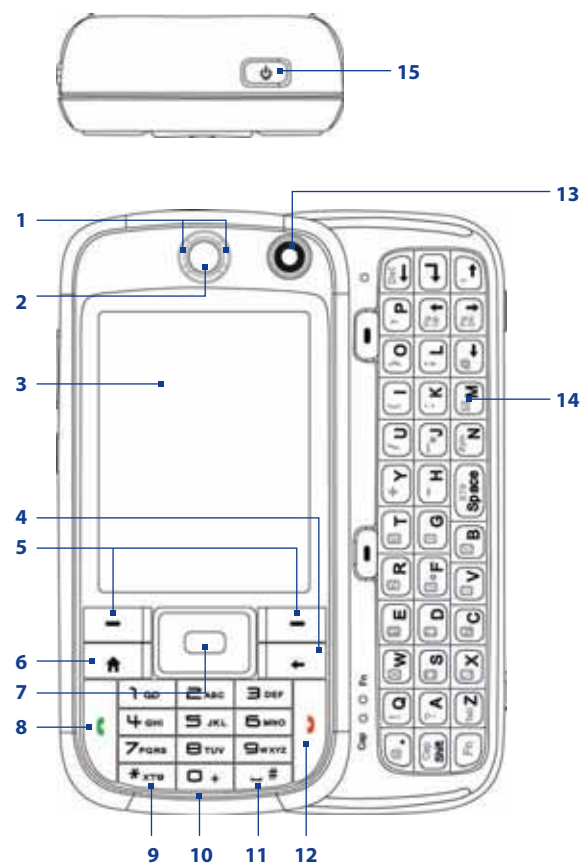



Item	Function
<b>1. LED Indicators</b>	Notifies you of connectivity, battery, and network status. For more information about LED Indicators, see the table at the end of this section.
<b>2. Earpiece</b>	Listen to a phone call through the earpiece.
<b>3. Display Screen</b>	The 2.4-inch LCD provides ample viewing room for watching video, looking at pictures, or browsing the Internet.
<b>4. BACK</b>	Press to go to the previous screen, or backspace over characters.
<b>5. Left/Right SOFT KEYS</b>	Press to perform the command shown in the label above the button.
<b>6. HOME</b>	Press to go to the Home Screen.
<b>7. NAVIGATION CONTROL/CENTER OK</b>	Use to scroll left, right, up, or down. Press the center to use as the CENTER OK button.
<b>8. TALK</b>	Press to dial a phone number, answer a call, switch to another call, or put a call on hold. Press and hold to activate/deactivate speakerphone mode.
<b>9. * Key</b>	Press to switch to different input modes or press and hold to choose an input mode from a list.
<b>10. Light Sensor</b>	A light sensor is hidden under the casing. Dark conditions sensed here will activate a backlight under the keypad.
<b>11. # Key</b>	Press to add a space or press and hold to display a list of symbols.
<b>12. END</b>	Press to end a call, or press and hold to lock the phone.
<b>13. Second Camera</b>	Use this camera for video call conversations or to take a self-portrait.
<b>14. QWERTY Keyboard</b>	Slide out to use the QWERTY keyboard. This is similar to a standard keyboard on a PC. For more information about the QWERTY keyboard, see "Using the QWERTY Keyboard" in this chapter.
<b>15. POWER</b>	Press and hold (about 3 seconds) to turn on and off the phone. Press and quickly release to display the Quick List. See "Quick List" later in this chapter for more details.

18 Getting Started

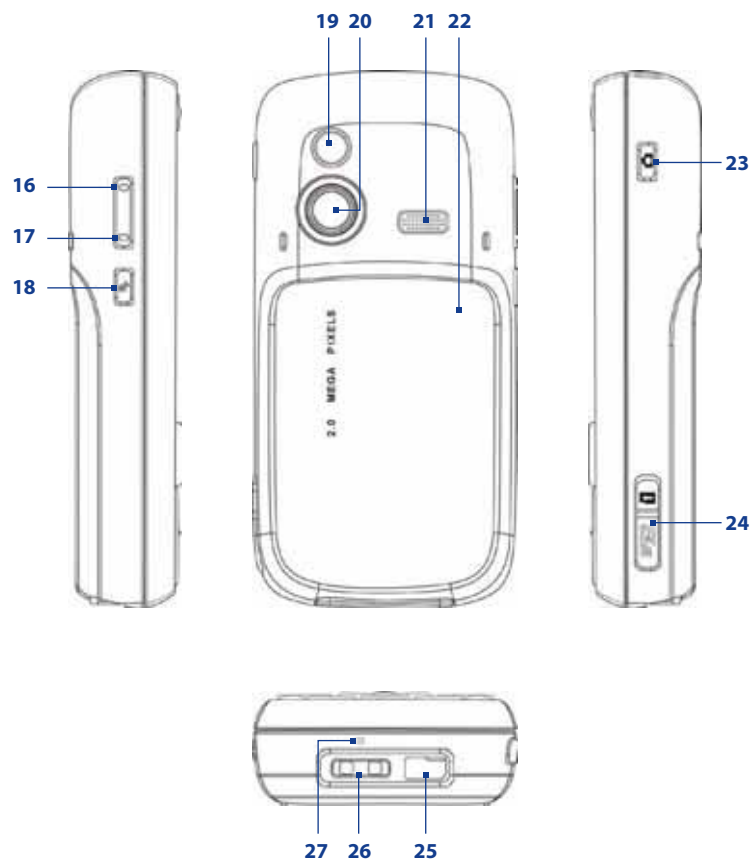

Item	Function
<b>16. Volume Up/ Voice Tag</b>	Press to increase the earpiece volume during a call. Press and hold to launch the Voice Tag feature.
<b>17. Volume Down/ Voice Notes</b>	Press to decrease the earpiece volume during a call. Press and hold to start the Voice Notes recorder.
<b>18. COMM MANAGER</b>	Press to open the Comm Manager, which lets you easily turn on/off your phone's connections (such as Bluetooth, Wi-Fi, and cellular data connection), ringer, phone, etc.
<b>19. Self-portrait Mirror</b>	Use it when taking self-portrait shots.
<b>20. Main Camera Lens</b>	The rear camera lens enables you to take snapshots and record video clips.
<b>21. Speaker</b>	Listen to audio media or a phone call when using speakerphone mode.
<b>22. Battery Cover</b>	Remove to insert battery and SIM/USIM card.
<b>23. CAMERA</b>	Press to open the Camera program. If the Camera program is already opened, press to take the photo or to start shooting video.
<b>24. microSD™ slot</b>	Pry open the rubber cover to insert the microSD card.
<b>25. HTC ExtUSB™ port</b>	Connect the USB cable to synchronize data or recharge the battery. You can also connect the earphone to listen to audio media or use the phone's hands-free kit.
<b>26. Strap Holder</b>	Let you attach a strap to carry your phone. Loop the end of a strap through this opening.
<b>27. Microphone</b>	Speak into the microphone when in a call, recording voice, or using a voice command.

**LED indicator lights**

Various colors that might display in the two LED Indicators are summarized here.

Left LED	Status
<b>Flashing blue</b>	Bluetooth mode set to "On" or "Visible" mode.
<b>Flashing green</b>	Connected to Wi-Fi network.

Right LED	Status
<b>Solid green</b>	Battery is fully charged.
<b>Blank</b>	Battery case is empty, no SIM/USIM card inserted or phone is off.
<b>Solid orange</b>	Battery is charging or the phone is using ActiveSync to synchronize with a PC.
<b>Solid red</b>	Battery is not installed or battery is over-discharged.
<b>Flashing green</b>	Connected to the network.
<b>Flashing red</b>	Battery very low (less than 5%).
<b>Flashing orange</b>	Battery temperature is hotter or colder than the functional limits of 0 to 48 degrees Celsius (32 to 118 degrees Fahrenheit), and has stopped charging.
<b>Orange/Green LED off</b>	Battery fault. The "Battery Fault" indicator (🔋) is displayed. In this case, the flashing green LED can be recovered by unplugging the AC adapter.

## Accessories

The following accessories are provided with the phone:

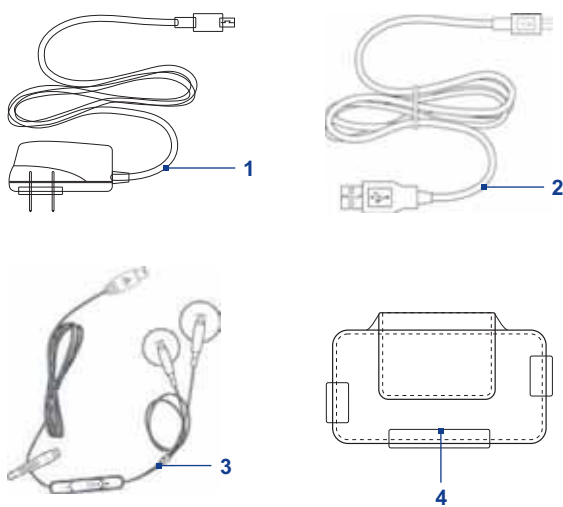

Accessory	Function
<b>1. AC adapter</b>	Recharge the phone battery.
<b>2. USB cable</b>	Connect your phone to a PC to synchronize data and/or to charge the phone.
<b>3. Stereo headset</b>	Provide a volume control slider and a Send/End button. You can press the button to pick up a call or put a call on hold or press and hold the button to end the call. Plug into Earphone Jack to listen to audio files.
<b>4. Pouch</b>	Act as a protective carrying case for your phone.

## 1.2 Starting Up

### Insert the SIM/USIM Card

Your SIM (Subscriber Identity Module) or USIM (Universal Subscriber Identity Module) card is given to you by your wireless service provider and contains your basic subscriber information, such as your phone number and your address book.

Before you begin, make sure the phone is turned off.

1. Hold the phone in one hand with the front panel facing down in the palm of your hand, and then press the battery cover downward to slide it open.
2. Insert the SIM/USIM card into the slot with the gold contacts facing down. Push the SIM/USIM card all the way in until the card locks into place.  
To take the SIM/USIM card out, press and hold the slot latch then push the SIM/USIM card out from the bottom of the card.
3. Replace the battery cover.



### Insert the Battery

1. Slide the battery cover downward to remove it.
2. Align the exposed metal contacts on the edge of the battery with the prongs in the body of the phone.
3. Push the bottom of the battery into place and then replace the battery cover.

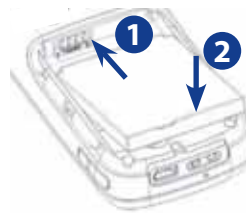

### Install a microSD™ Card

1. Pry open the rubber cover of the microSD card slot on the right side of the phone.
2. Insert the microSD card into the slot with the gold contacts facing down, and then close the cover.



To remove the microSD card, press it to pop it out of the slot.

**Note** microSD card is not included in the box.

### Turn On and Off the Phone

Press and hold the POWER button for about 3 seconds to turn on or off the phone.

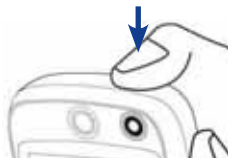

### 1.3 Home Screen

The Home screen displays important information, such as upcoming appointments, status indicators, the current date and time, and HTC Home.

- To access the Home screen from anywhere, press HOME.



Home Screen

- 1 HTC Home. See "HTC Home" later for details.
- 2 Number of new e-mail messages. Click this icon to view your e-mails.
- 3 Displays the time of your next appointment. Click to open the Calendar program.
- 4 Click to display the available programs in your phone.
- 5 Displays notifications, such as missed calls or new messages.
- 6 Displays the network or connectivity status.
- 7 Displays the power status.
- 8 Displays the network signal strength.
- 9 Number of missed calls. Click this icon to view the Call History.
- 10 Number of new text/MMS messages. Click this icon to view your text/MMS messages.
- 11 Click to open Contacts, Call History, or Messages.

Use the NAVIGATION CONTROL to scroll down the Home screen to see more information.

To learn about the different icons/notifications that you may see on the Title bar of the Home screen, please see "Status Indicators" at the end of this section.



### HTC Home

HTC Home is a Home screen plug-in that gives you up-to-date local information at a glance, such as time, day, and weather information. It also has a customizable contacts list where you can add your favorite contacts for quick access.

HTC Home has three components: **Home**, **Weather**, and **Favorite People**. At the bottom of HTC Home, there is a toolbar that allows you to switch between these components. Use the NAVIGATION Control to switch between the different components of HTC Home.

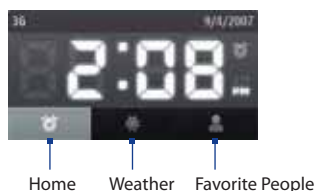

### The Home tab

**Home** displays the current day, date and local time. If you have set up the alarm, it also shows the Alarm icon.

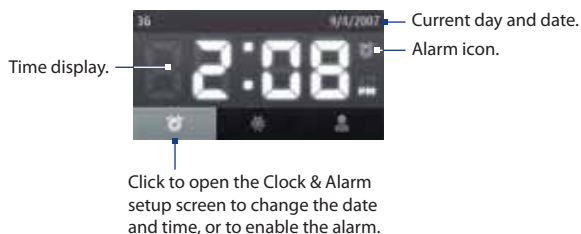

**The Weather tab**

**Weather** shows you the current weather as well as weather information of the next four days of the week. The first time you use this feature, you need to select your city first to get the weather information of your city.

1. Click the Weather icon (☁) to open the Select City screen.
2. On the Select City screen, browse through the list of cities and choose your city.
3. Click **Select**.



After selecting your city, your phone automatically connects to the Internet via the data connection and downloads weather information of the current day and the next four days of the week. The current temperature, the highest and lowest temperatures, and a visual indicator of the climate (showing if it's a cloudy or rainy day, etc.) will be displayed in the Weather tab.



**Note** If you have not connected to the Internet and downloaded weather information for five days, the following error message will be displayed: "Unable to retrieve data for selected city. Select here to retry." Use the data connection to connect your device to the Internet, and then click the area that shows the error message to download weather data.

You can also customize weather settings through the following steps:

1. Click the Weather icon (  ) to open the Select City screen.
2. Click **Menu > Weather Options**.
3. You can enable or disable the following options:

- **Download weather data automatically.**

When this option is selected, weather information will automatically be downloaded from the AccuWeather Web site whenever you select the Weather tab, if the data has not been updated within the last three hours. Weather data will also be downloaded every time an ActiveSync connection occurs (through over-the-air or USB connection).

- **Download when roaming.** Select this check box only if you want to allow automatic download of weather data when you're roaming. This may incur additional costs.

- **Temperature Scale.** Choose whether to display temperature in **Celsius** or **Fahrenheit**.

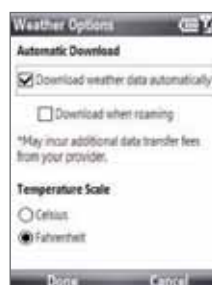

**Tip** To check for more detailed weather information on the AccuWeather Web site, click **Menu > About Weather** on the Select City screen, and then click the link that shows **AccuWeather.com**<sup>®</sup>. Internet Explorer Mobile then opens and brings you to the AccuWeather Web site.

### The Favorite People tab

**Favorite People** allows you to add up to eight favorite contacts. If you make calls or send messages to certain people frequently, you can add them as favorite contacts for quicker access.

**Note** You should already have contacts created or synchronized on your phone before you can add them as favorite contacts.



Shows the favorite contact with photo.

When you add a favorite contact and there is no photo associated to that contact, the contact's name will be displayed.

Click to open the People screen.



Click the empty slot to add a favorite contact.

























On the People screen, select the desired contact and click **Call** to place a call.

Click **Menu > Contact** to open the contact card; or click **Menu > Delete** to remove the selected contact.





















**Tip** To dial a different phone number (if any) of the selected contact, press NAVIGATION left or right (← →), select the mobile phone (📱), work phone (🏢), or home phone (🏠), and then click **Call**.

## Status Indicators

The following table lists common status indicators.

Icon	Description
	New text message
	New e-mail message
	New Live Messenger message
	Roaming
	Voice call in progress
	Data call in progress
	Calls forwarded
	Call on hold
	Missed call
	Battery level
	Low battery
	Very low battery
	Battery charging
	No battery or battery fault
	Signal strength
	Radio connected or no signal
	Radio off
	No SIM/USIM card installed
	SIM/USIM card with fault
	Microphone muted
	Speakerphone on
	Wi-Fi enabled, but phone not connected to a wireless network
	Wi-Fi connected
	Connecting to wireless network

## 30 Getting Started

Icon	Description
	HSDPA network available
	HSDPA in use
	UMTS network available
	UMTS in use
	GPRS available
	GPRS in use
	EDGE available
	EDGE in use
	Lowercase text input
	Uppercase text input, caps lock
	Uppercase text input
	Numeric or symbol (labeled in blue color on keyboard) input, locked
	Numeric or symbol input (labeled in blue color on keyboard)
	XT9 text input mode, lowercase
	XT9 text input mode, uppercase
	XT9 text input mode, caps lock
	Ringer off
	Vibrate call alert
	Bluetooth on or visible mode
	Bluetooth headset connected

## 1.4 Start Menu

Your phone comes with several bundled programs that you can start using immediately. You can also install additional programs from the included Windows Mobile® Getting Started Disc or from other sources and install them on your phone.









To see the available programs on your phone, click **Start** on the Home screen,

To see more programs, click **More**.



### Programs on your phone













The following table lists icons of the programs that are already installed on your phone or are available on the discs that came with your phone.

Icon	Program	Description
	<b>Calculator</b>	Does basic arithmetic and calculations.
	<b>Accessories</b>	<ul style="list-style-type: none"> <li> <b>Clear Storage</b> Clears the memory and restores the phone back to its factory default settings.</li> <li> <b>SIM Manager</b> Manages the contacts that are stored on your SIM/USIM card.</li> </ul>
	<b>ActiveSync</b>	Synchronizes information between your phone and PC.
	<b>Adobe Reader LE</b>	Allows you to view PDF files.
	<b>Audio Booster</b>	Enhances your music experience by providing you with controls for adjusting equalizer, 3D sound, treble, and bass settings.
	<b>Audio Manager</b>	Allows you to browse for music files by organizing music files into categories.
	<b>Bluetooth Explorer</b>	Allows you to search for other Bluetooth devices that have file sharing enabled and lets you access their Bluetooth shared folder.

## 32 Getting Started

Icon	Program	Description
	<b>Calendar</b>	Keeps track of your appointments, and creates meeting requests.
	<b>Call History</b>	Keeps track of all phone calls made, received, and missed.
	<b>Camera</b>	Captures photos in various modes.
	<b>Comm Manager</b>	Acts as a central switch where you can manage phone and connection settings.
	<b>Contacts</b>	Keeps track of contact information.
	<b>File Explorer</b>	Organizes and manages files and folders.
	<b>Flash Lite Player</b>	Allows you to play back Flash Lite™ contents (*.swf files) on your phone.
	<b>Games</b>	Plays two games: <b>Bubble Breaker</b> and <b>Solitaire</b> come with your phone.
	<b>Internet Explorer</b>	Browses Web and WAP sites, and to download new programs and files from the Internet.
	<b>Internet Sharing</b>	Lets your phone act as an external modem for your computer.
	<b>Java</b>	Allows you to download and install Java-based applications, such as games and tools, on your phone.
	<b>Messaging</b>	Allows you to send and receive e-mails, MMS and text messages.
	<b>Messenger</b>	Connects to the Windows Live Messenger service.
	<b>MP3 Trimmer</b>	Allows you to trim an MP3 file to a desired length.
	<b>Excel Mobile</b>	Views Excel worksheets.
	<b>PowerPoint Mobile</b>	Views PowerPoint files.
	<b>Word Mobile</b>	Views Word documents.
	<b>Pictures &amp; Videos</b>	Collects, organizes, and sorts media files.



Icon	Program	Description
	<b>Quick Notes</b>	Types and saves often used text messages.
	<b>SAPSettings</b>	Enables Bluetooth Remote SIM access on your phone. See chapter 2 for more details.
	<b>Settings</b>	Personalizes your phone to suit the way you use it.
	<b>STK (SIM Tool Kit) Service</b>	Allows you to access information and other services offered by your wireless service provider.
	<b>Speed Dial</b>	Creates speed dial entries for dialing frequently-called phone numbers or for opening frequently-accessed programs.
	<b>Streaming Media</b>	Allows you to stream live or on-demand video.
	<b>Task Manager</b>	Keeps track of all running programs on your phone.
	<b>Tasks</b>	Keeps track of your tasks.
	<b>Video Recorder</b>	Captures video clips in various modes and duration.
	<b>Voice Notes</b>	Creates short voice recordings.
	<b>Windows Live</b>	Use this mobile version of Windows Live™ to find information on the Web. It also lets you sign into your Windows Live account so that you can access your Live Mail messages and send/receive instant messages in Live Messenger.
	<b>Windows Media Player</b>	Allows you to play back video and audio files.

## 1.5 Quick List

The Quick List offers convenient access to a list of functions, such as locking your phone and keypad, opening Comm Manager, and choosing a different profile.

### To access the Quick List

1. Briefly press (press and quickly release) the POWER button.
2. Select the desired option and click **Select**.
3. To exit the Quick List at any time, click **Cancel**.

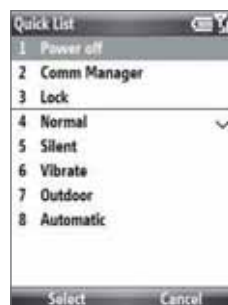

## 1.6 Entering Information

You can enter text, numbers, and symbols using the keypad or QWERTY keyboard. The status indicator on the top-right side of the display screen displays the input mode that you are currently using.

<b>abc</b>	Lowercase text input
<b>ABC</b>	Uppercase text input, caps lock
<b>ABC</b>	Uppercase text input
<b>12#</b>	Numeric or symbol (labeled in blue color) input, locked ( <b>Keyboard only</b> )
<b>12#</b>	Numeric or symbol (labeled in blue color) input
<b>xt9</b>	XT9 text input mode, lowercase
<b>Xt9</b>	XT9 text input mode, uppercase
<b>Xt9</b>	XT9 text input mode, caps lock

## Use the Keypad

Use the keypad to dial phone numbers or type short text messages.

### To change the input mode

1. Press and hold the **\*XT9** key.
2. On the menu, click the input mode you want.

## Use Multipress mode

In Multipress mode, you enter a character by pressing the numeric key on which the character appears.

### To enter text in Multipress mode

- To enter the first character on the numeric key, press once. To enter the second character on the numeric key, press twice, and so on.
- To enter character that are on the same numeric key, pause after you enter the first character.
- To enter punctuation, press **1** repeatedly until you see the punctuation you want.

### To change the Multipress time out

You can change the length of time to pause between keypresses on the same numeric key.

1. On the Home screen, click **Start > Settings > Accessibility**.
2. In **Multipress time out**, select the length of the pause between keypresses.

## Use XT9 mode

To enter a word in XT9 mode, press the numeric keys that contain the letters you want. As you enter letters, XT9 analyzes your keypresses and attempts to complete the word. For example, to enter the word "shoe," press **7, 4, 6, 3**.

### To enter text in XT9 mode

1. Press and hold the **\*XT9** key.
2. On the menu, click **XT9 English**.

3. Do any of the following to start entering text in XT9 mode:
  - Enter letters by pressing the keys on which the letters appear. Press a key only once for each letter. If there is more than one choice in the XT9 dictionary for your entry, a list of available words is displayed at the bottom of the screen.
  - Press the **\_#** key to enter a space after the word.
  - To enter punctuation, press **1**, and then select from the list at the bottom of the screen.

### Use Numeric mode

If a text box permits a numeric entry only, such as a phone number, the input mode automatically defaults to Numeric mode. However, if you need to enter numbers within a line of text, change to Numeric mode, and then change back to Multipress or XT9 mode to finish entering the text.

#### To enter numbers in text boxes

1. Press and hold the **\*XT9** key to change to Numeric mode (**12#**).
2. On the keypad, enter the number or numbers you want.
3. Change back to Multipress or XT9 input mode by pressing and holding the **\*XT9** key, and then finish entering your text.

### More text entry tasks

In both Multipress and XT9 modes, the first letter of a sentence is by default capitalized.

#### To change between uppercase, lowercase, and caps lock

- Press the **\*XT9** key to change between uppercase, lowercase, and caps lock within a text input mode.

#### To delete characters

- To backspace and delete a single character in any input mode, press the BACK key (←).
- To backspace and delete an entire text or numeric field in any input mode, press and hold the BACK key (←).

#### To enter a space

- In Multipress or XT9 mode, press the **\_#** key.

**To enter a symbol**

1. Press and hold the **\*XT9** key.
2. On the menu, click **Symbols** to display the Symbol page.
3. Select the symbol you want and press CENTER OK.

**To start a new line**

In a multi-line text box such as the notes area of a contact or a calendar appointment, do the following:

- In any input mode, press CENTER OK.

**Use the QWERTY Keyboard**

Slide the upper half of the phone (with the screen) to the left to reveal the QWERTY keyboard. Use the QWERTY keyboard to type e-mails and long messages.

When you slide open the QWERTY keyboard, the display orientation of the screen automatically changes to landscape mode; when you close it, the screen orientation switches back to portrait mode.

**Note** To enable/disable the QWERTY keyboard sliding open or closing sound, click **Start > Settings > Sounds**. In **Keyboard sliding**, select **None** to disable the sound or select a sound to enable the sound.

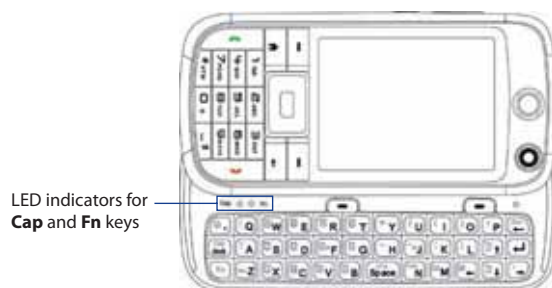

The LED indicators corresponding to the **Cap** and **Fn** keys on the keyboard display solid orange color when the **Fn** and **Cap Shift** keys are pressed to turn on their functionality. Press a desired corresponding key and turn them off after use.

## 38 Getting Started

You can do the following with the QWERTY keyboard:

- To type lowercase letters, press the keys using your thumbs or fingers.
- To type all uppercase letters, press **Fn** first, and then press **Cap Shift**. To turn off this function, press **Fn** first, and then press **Cap Shift** again.
- To type a single uppercase letter, press **Cap Shift** and then press the corresponding key.
- To enter a number or symbol (labeled in blue color) or to carry out a command like scrolling a page, press **Fn** and then press the corresponding key.
- To remain in the scrolling mode or to continue entering numbers or symbols (labeled in blue color), press **Fn** twice and then press the corresponding keys.
- Press the left or right SOFT KEY to perform the command shown in the label above the key.

## 1.7 Battery Information

Battery performance depends on many factors, including but not limited to your wireless service provider's network configuration, signal strength, and the temperature of the environment.

Battery life estimates (approximations):

- Talk time: Up to **3 - 5.3** hours (GSM); up to **1.1 - 1.9** hours (UMTS)
- Standby time: Up to **172 - 250** hours (GSM); up to **161 - 270** hours (UMTS)
- Playing WMV: Up to **8** hours
- Playing WMA: Up to **12** hours

### **WARNING!**

To reduce risk of fire or burns:

- Do not attempt to open, disassemble, or service the battery pack.
- Do not crush, puncture, shorten external contacts, or dispose of in fire or water.
- Do not expose to temperatures above **60°C (140°F)**.
- Replace only with the battery pack designated for this product.
- Recycle or dispose of used battery as stipulated by local regulation.

**To check and optimize battery power**

- On the Home screen, click **Start > Settings > Power Management**, and adjust the backlight, display, or light sensor settings.

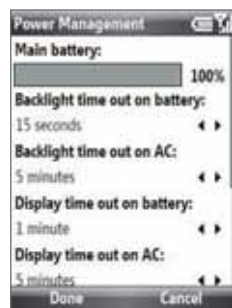

If you don't want to charge the battery while the phone is connected to the computer, click **Start > Settings > Power Management** and in **When device is turned on, do not charge the battery when connected to the PC**, select **On**.

**To manage low battery**

When the low-battery warning appears, do the following:

1. Immediately save your current data.
2. Synchronize with your PC or use the AC adapter to charge the battery.
3. Turn off your phone. Turn it back on only when you need to use it.

40 Getting Started



# Chapter 2

## Using Phone Features

**2.1 Using the Phone**

**2.2 Making a Call**

**2.3 Making a Video Call**

**2.4 Receiving a Call**

**2.5 In-Call Options**

**2.6 Additional Dialing Information**

**2.7 SIM Tool Kit (STK)**

**2.8 Setting Up Bluetooth SIM Access  
for Car Kit Phones**

## 2.1 Using the Phone

You can use your phone to make, receive, and keep track of voice calls, and send text messages (SMS, Short Message Service) and MMS (Multimedia Messaging Service) messages.

### The Phone screen

From the Phone screen, you can open, call, or find a contact, and even save a new number in Contacts. To access the Phone screen, do any of the following:

- Press TALK (  ).
- Enter the phone number by pressing the keys on the keypad.

### Enter your PIN

Most SIM/USIM cards are preset with a personal identification number (PIN) that is provided by your wireless service provider. You need to enter the PIN whenever you use your phone.

- Enter your PIN when prompted and click **Done**.

**Note** If your PIN is entered incorrectly three times, the SIM/USIM card will be blocked. If this happens, you can unblock it with the PIN Unblocking Key (PUK) obtained from your wireless service provider.

You can change the SIM PIN by clicking **Start** > **Settings** > **Security** > **Change SIM PIN**.

### Set ring tones

You can choose how to be notified for incoming calls, reminders, new messages, alarms, and more.

#### To set a ring tone for incoming calls



1. On the Home screen, click **Start** > **Settings** > **Sounds**.
2. In the **Ring tone** list, select a ring tone and click **Done**.

If you select **Vibrate**, the sound is muted and the phone will vibrate when you receive a call. The Vibrate icon (  ) appears in the title bar. Selecting **None** in the **Ring tone** list mutes the phone. For more information about sounds, see "Choose how to be notified about events or actions" in Chapter 4.

## 2.2 Making a Call

With your phone, you can make calls from the Home screen, the Phone screen, from Contacts, Speed Dial, Call History, or SIM Contacts (contacts stored on your SIM/USIM card).

### Make a call from the Home screen

- Use the quick dial feature from the Favorite People of HTC Home. For details, see “HTC Home” in Chapter 1.
- Enter the phone number by pressing keys on the keypad, and press TALK (  ). Press the BACK key (  ) if you need to backspace.



Phone Screen

**Note** You can also use the QWERTY keyboard to dial numbers on your phone.

**Tip** You will notice that when you press a key on the keypad, a list of names and numbers is displayed as your phone searches Contacts, Call History, Speed Dial, and your SIM/USIM card to find a matching name or number. For example, when you press a key such as 5, first and last names that begin with J, K, and L will be displayed as well as phone numbers that start with 5. The next key you press continues to narrow the search. When you see the name of the person you want to call, select it, and press TALK (  ).

### Make a call from Contacts

1. On the Home screen, click **Contacts** (if displayed) or click **Start > Contacts**.
2. Select the desired contact, and press TALK (  ).

### To specify the number to dial

By default, the mobile telephone number (m) of a contact is dialed when you make a call from Contacts; however, you can choose to dial a different phone number.

1. On the Home screen, click **Contacts** (if displayed) or click **Start > Contacts**.
2. Select the contact.
3. Press NAVIGATION left or right. The letter representing the number changes to **m** (mobile), **w** (work), or **h** (home).
4. Press TALK (  ) to dial the number.
  - To view or edit information associated with the selected contact, click **Menu > Edit**.
  - To save a contact on your SIM/USIM card, click **Menu > Save to SIM**.

To learn more about Contacts, see Chapter 5.

### Make a call from Call History

1. On the Home screen, click **Start > Call History** or click **Call History** (if displayed).
2. Select a name or number, and press TALK (  ).

In the Call History screen, press CENTER OK to view details, such as the dialed, missed, or received call, call duration, date, and time. Pressing CENTER OK again dials the associated number.

### To customize calls

On the Call History screen, click **Menu** to select various options to customize and filter the calls made, received, or missed.

**Note** You can also save a number in Contacts by clicking **Save** on the Call History screen.

### Make a call from Speed Dial

You can make calls using Speed Dial. To learn how to use Speed Dial, see “Speed Dial” in Chapter 10.

### Make a call from SIM Manager

1. Click **Start > Accessories > SIM Manager**. Wait for the contents of your SIM/USIM card to load.
2. Choose the contact you want to call and click **Menu > Call**.

For more information about SIM Manager, see Chapter 5.

## 2.3 Making a Video Call

This phone allows you to make video calls when you are within a 3G network coverage area. You need to install a 3G-enabled USIM card to make video calls.

### To make a video call

- Enter the phone number, and then click **Menu > Video Call**.
- In Contacts, select the contact, and then click **Menu > Video Call**.

**Note** The caller's image will appear on the screen after about 3 to 5 seconds after connection, depending on the signal strength. The streaming video quality may also be influenced by the signal strength.

If the video call is unsuccessful, a message pops up asking you if you want to try again. You can make a voice call or send an SMS/MMS message instead.

### Change Video Call settings

While on a video call, you can change certain settings such as the size of the image, brightness of the image, the camera to use, and more.

The following image shows the Video Call screen and control buttons during an ongoing call.



1. **Camera On/Off.** Click to toggle between turning on/off the camera. When the camera is turned off, the image displayed depends on the Video Call options you have set. See "Set up Video Call Options."
2. **Audio Mute/Unmute.** Click to toggle between muting/unmuting the audio.
3. **Main/Second Camera.** Click to toggle between using the Main (back) or Second (front) camera.
4. **Swap Image.** Click continuously to cycle through the available image display options.
5. **Image Display Area.** Displays your image and the other party's image depending on the selected Swap Image setting.

Use NAVIGATION left or right to choose the setting you want to change. Press CENTER OK to change the setting.

### Swap image settings

The following table describes swap image settings and icons.

Icon	Description
	<b>Both parties (My video small).</b> The caller's image is large while your image is small. This is the default setting.
	<b>Both parties (My video large).</b> The caller's image is small while your image is large.
	<b>Both parties (Equal).</b> Both the caller and your image are the same size.
	<b>Other party only.</b> Only the caller's image is displayed.

### To adjust the brightness level of your image

Use NAVIGATION up or down to adjust the brightness level of the image. A brightness level scale will appear on the upper-right corner of the screen.



**Note** The position of the brightness scale level on the upper right corner will depend on the Swap Image option selected.



### Set up Video Call Options

1. On the Home screen, click **Start > Settings > Video Call > General**.
2. In **Show still image**, select the image you want to display when you turn off the camera.
  - **Preset (female)**. Displays a female picture in place of your image.
  - **Preset (male)**. Displays a male picture in place of your image.
  - **Custom image**. Lets you use an image from file as your display picture. To choose a custom image, scroll down (**Select a picture** becomes available) then use NAVIGATION right to choose an image.
  - **Last video frame**. Uses the last video frame before you stopped the camera as your display image.
3. Select the **Flip the 2nd camera video** check box if you are going to show a text document to the other party using the second camera.
4. Select the **Switch camera off when answering video call** check box to not send a video feed of yourself to the other party. Instead, the option you selected in **Show still image** will be displayed.
5. Select the **Show call timer** check box to display the call duration.

## 2.4 Receiving a Call

When you receive a phone call or video call, you have the option to answer it or ignore it.

### To answer or ignore an incoming call

- To answer the call, press TALK (  ); to ignore, press END (  ).

### To end a call

- Press END (  ).

## 2.5 In-Call Options

Your phone lets you manage multiple calls at the same time.

During a call, click **Menu** to access in-call options.

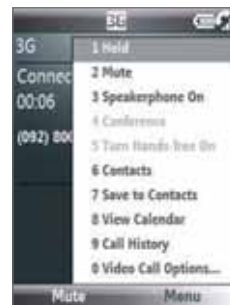

### To enable Call Waiting

Call Waiting should be enabled and supported for you to be notified of an incoming call when you are using the phone.

1. On the Home screen, click **Start > Settings > Phone > Call Waiting**.
2. After the settings have downloaded from the service provider, select the **Provide call waiting notifications** check box and click **Done**.

### To answer another call

1. Click **Answer** to take the second call and put the first call on hold.
2. Do one of the following while you are online with two calls.
  - To end the second call and return to the first call, press END ( **⏏** ).
  - To switch between the two calls, click **Swap**.

### To set up a conference call

Not all service providers support conference call. Contact your service provider for details.

1. Either put a call on hold (click **Menu > Hold**) and dial a second number, or, answer another incoming call during a call.
2. Click **Menu > Conference**.



- Notes**
- If the conference connection is successful, the word “Conference” appears at the top of the screen.
  - To add additional persons to your conference call, click **Menu > Hold**, enter the phone number, and then click **Resume** to return to the call.

**To turn on and off the Speakerphone**

- During a call, click **Menu > Speakerphone On**. The  icon appears at the top of the screen.
- To turn off the Speakerphone, click **Menu > Speakerphone Off**.

Alternatively, the speakerphone can be toggled on and off by pressing and holding TALK (  ) during the call.

**WARNING!** To avoid damage to your hearing, do not hold your phone against your ear when the Speakerphone is turned on.

**To mute a call**

- During a call, click **Mute**.

When the microphone is turned off, the  icon appears on the screen. Click **Unmute** to turn on the microphone again.



## 2.6 Additional Dialing Information

**Make an emergency call**

- Enter the appropriate emergency number for your locale, and press TALK (  ).

**Tip** Additional emergency numbers may be included in your SIM/USIM card. Contact your service provider for details.

**Make an international call**

1. Press and hold the **0** (Zero) key on the keypad until  appears.
2. Enter the full phone number, and press TALK (  ).

For example: +1-909-2222222, which is in the following format:  
+<country code>-<area code>-<phone number>.

### **Insert a pause or long pause in a dialing sequence**

Some international calls or phone numbers require a pause or long pause in the dialing sequence in order for the call to process successfully.

1. On the Home screen, click **Start > Contacts**.
2. Select the contact and press CENTER OK to open the contact card.
3. Click **Menu > Edit**.
4. Position the cursor on the phone number where you want to insert a pause.
5. Click **Menu > Insert Pause** or **Insert Wait**. The letter "p" (Insert Pause) or "w" (Insert Wait) will appear in the number sequence to indicate where the pause or long pause will occur.
6. Click **Done**.

- Notes**
- Long pause is not available for contacts stored on the SIM/USIM card.
  - When you call a number that contains a long pause, you must press TALK (  ) again to continue dialing.

## **2.7 SIM Tool Kit (STK)**

A SIM/USIM card must be inserted in your phone in order to use this feature, which allows you to access a range of information services provided by your service provider.

1. On the Home screen, click **Start > SIM Tool Kit (STK)**.
2. To access a service, click the item in the list.

## 2.8 Setting Up Bluetooth SIM Access for Car Kit Phones

Car kits that support the SIM Access Profile (SAP) can connect to your phone and access its SIM/USIM card via Bluetooth.

- Notes**
- Make sure that all phone contacts are stored in the SIM/USIM card and not in the phone memory. Configure the car kit to download contacts only from SIM/USIM card.
  - Contact your wireless service provider to find out which car kit phone models are compatible with your phone.
1. In your phone, make sure that Bluetooth is turned on and set to Visible mode.
  2. Click **Start > SAPSettings**.
  3. On the BT Remote SIM Access screen, select the **Remote SIM Access** check box and click **Done**.
  4. Connect the car kit phone to your phone via Bluetooth. To learn how to connect, consult your car kit phone's manual.
  5. A pop-up message should appear on your phone saying that a connection has been established between your phone and car kit. Click **OK**.
  6. On the BT Remote SIM Access screen, click **Done**.
- Note** You will not be able to make/receive calls, send/receive messages or perform related activities on your phone when the SIM Access Profile connection is active. You will be able to do all this from the car kit phone during this time.

52 Using Phone Features

# Chapter 3

## Synchronizing Information with Your Computer

**3.1 About Synchronization**

**3.2 Using Microsoft Windows Mobile®  
Device Center**

**3.3 Installing and Using Microsoft ActiveSync®**

**3.4 Synchronizing with Your Computer**

**3.5 Synchronizing via Bluetooth**

**3.6 Synchronizing Music and Video**

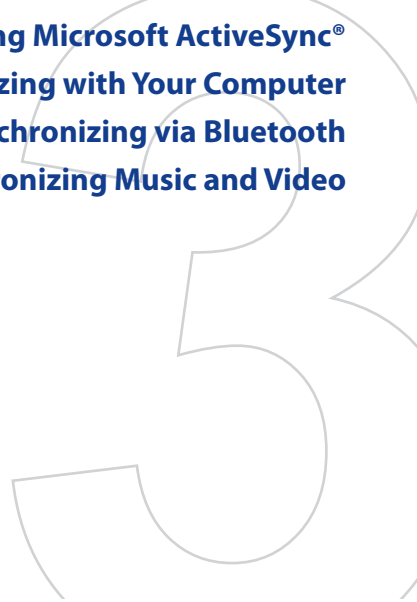

### 3.1 About Synchronization

You can take information from your computer wherever you go by synchronizing them to your phone. The following types of information can be synchronized:

- **Microsoft Outlook® information**, which include Outlook e-mail, contacts, calendar, tasks, and notes
- **Media**, such as pictures, music and video
- **Favorites**, which are the bookmarked links to your favorite web sites
- **Files**, such as documents and other files

Before you can synchronize, you will first need to install and set up the synchronization software on your computer. For information about installing and using the synchronization software on your computer, see "Using Windows Mobile Device Center" and "Installing and Using ActiveSync" in this chapter.

#### Ways to synchronize

After you have installed the synchronization software on your computer, synchronize your phone with your computer using one of the following methods:

- Connect and synchronize using the supplied USB sync cable. Upon connecting the sync cable to your phone and your computer, the synchronization process starts automatically.
- Connect and synchronize using Bluetooth. You must first set up a Bluetooth partnership between your phone and your computer before you can synchronize information between them using Bluetooth. For more information about setting up a Bluetooth partnership, see Chapter 8. For information about synchronizing through Bluetooth, see "Synchronizing via Bluetooth" later in this chapter.

**Note** You can also synchronize Outlook e-mail, contacts, calendar, and tasks on your phone with the Exchange Server at your work. For more information about setting up your phone to synchronize with the Exchange Server, see Chapter 7.

## 3.2 Using Microsoft Windows Mobile® Device Center

**Microsoft Windows Mobile® Device Center** is the replacement for Microsoft® ActiveSync® on Windows Vista®.

**Note** Some versions of Windows Vista come pre-installed with Windows Mobile Device Center. If Windows Mobile Device Center is not available on your Windows Vista, you can install it from the Getting Started Disc that came with your phone.

### Set up synchronization between your phone and PC

1. Connect your phone to your PC. Windows Mobile Device Center configures itself and then opens.
2. On the license agreement screen, click **Accept**.
3. On the Windows Mobile Device Home screen, click **Set up your device**.
4. Select the information types that you want to synchronize then click **Next**.
5. Enter a device name for your phone and click **Set Up**.

When you finish the wizard, Windows Mobile Device Center synchronizes your phone automatically. Notice that Outlook e-mails and other information will appear on your phone after synchronization.

**Note** In step 3, choose **Connect without setting up your device** if you only want to transfer media files, check for updates, and explore your phone but not sync Outlook information.

### 3.3 Installing and Using Microsoft ActiveSync®

Follow the steps below to install and set up ActiveSync 4.5 or later on Windows XP or other compatible Windows systems.

**Note** For a list of compatible Windows systems, please go to <http://www.microsoft.com/windowsmobile/activesync/activesync45.msp>

#### Install and set up ActiveSync

1. Insert the Getting Started Disc into the disc drive on your PC.
2. Follow the on-screen instructions to install ActiveSync.
3. After installation is completed, connect your phone to your PC.
4. The Synchronization Setup Wizard automatically starts and guides you to create a synchronization relationship. Click **Next** to proceed.
5. To synchronize your phone with your computer, clear the **Synchronize directly with a server running Microsoft Exchange Server** check box then click **Next**.
6. Select the information types that you want to synchronize and then click **Next**.
7. Click **Finish**.

When you finish the wizard, ActiveSync synchronizes your phone automatically. Notice that Outlook e-mails and other information will appear on your phone after synchronization.



### 3.4 Synchronizing with Your Computer

Connect your phone to your PC to synchronize the information between your phone and PC. While your phone is connected, ActiveSync (or Windows Mobile Device Center on your PC) synchronizes every time you make a change on either the PC or your phone.

You can also manually start and stop synchronization any time.

#### To start and stop synchronizing

1. After connecting your phone to your PC, click **Start > ActiveSync** on your phone.
2. Click **Sync** to start synchronization.  
To end synchronization before it completes, click **Stop**.

#### To change which information is synchronized

You can add or reduce the types of information to synchronize between your phone and PC.

1. Before changing synchronization settings on your phone, disconnect your phone from your PC.
2. On your phone, click **Start > ActiveSync**.
3. Click **Menu > Options**.
4. Select or clear the items you want to synchronize or not synchronize. If you cannot select a check box, you might have to clear the check box for the same information type elsewhere in the list.
5. To customize settings for an item, select that item and click **Settings**. Settings are not available for all items.

**Note** The check boxes of the Favorites, Files, Media, and OneNote items are always grayed out in ActiveSync Options on your phone. You can only select or clear these items from Windows Mobile Device Center or ActiveSync on your computer.

## 58 Synchronizing Information with Your Computer

### To synchronize with more than one computer

You can set up your phone to synchronize with more than one PC or with a combination of one or more PCs and Exchange Server. When synchronizing with multiple computers, the items that you synchronize will appear on all of the computers with which they are synchronized.

For example, if you have set up synchronization with two PCs (PC1 and PC2), which have different items, and you synchronize Contacts and Calendar on your phone with both computers, the result is as follows:

Location	New state
PC1	All Outlook contacts and calendar appointments that were on PC2 are now also on PC1.
PC2	All Outlook contacts and calendar appointments that were on PC1 are now also on PC2.
Phone	All Outlook contacts and calendar appointments from both PC1 and PC2 are on your phone.

- Notes**
- Outlook e-mail can be synchronized with only one computer.
  - To stop synchronizing with one PC completely, click **Menu > Options**, click the computer name, then click **Menu > Delete**.

### To resolve ActiveSync connection problem

When the PC is connected to the Internet or a local network, in some cases, the PC may disconnect the ActiveSync connection with your phone in favor of the Internet or network connection. If this happens, click **Start > Settings > Connections > USB to PC**, then clear the **Enable advanced network functionality** check box. This makes ActiveSync utilize a serial USB connection with your phone.

## 3.5 Synchronizing via Bluetooth

You can connect and synchronize your phone with the PC using Bluetooth.

### To synchronize with a computer via Bluetooth

1. Set up the synchronization software (Windows Mobile Device Center or ActiveSync) on your computer to use a Bluetooth connection. For more information, see the software Help on your computer.
2. On your phone, click **Start > ActiveSync**.
3. Make sure that Bluetooth on both your phone and the computer are turned on and set to **Visible** mode. For more information, see "Bluetooth" in Chapter 8.
4. Click **Menu > Connect via Bluetooth**.
5. If this is the first time you have connected to this computer via Bluetooth, you must first complete the Bluetooth wizard on your phone and set up a Bluetooth partnership between your phone and the computer. For more information about creating a Bluetooth partnership, see "Bluetooth partnerships" in Chapter 8.

- Notes**
- To preserve battery power, turn off Bluetooth when not in use.
  - To connect and synchronize your phone with a computer via Bluetooth, your computer must have built-in Bluetooth or installed with a Bluetooth adapter or dongle.

### **3.6 Synchronizing Music and Video**

If you want to carry your music or other digital media along with you while you travel, set up Microsoft Windows Media Player on your computer to synchronize music and video with your phone.

Other than selecting the media information type in ActiveSync to be synchronized, all media synchronization settings must be set in Windows Media Player. Before media can be synchronized, you must do the following:

- Install Windows Media Player Version 11 on the PC. (Windows Media Player 11 works only in Windows XP or later versions).
- Connect your phone to the PC with a USB cable.
- Set up a sync partnership between the phone and Windows Media Player.

For more information about Windows Media Player on your phone, see “Windows Media Player Mobile” in Chapter 9.

# Chapter 4

## Managing your Phone

**4.1 Personalizing Your Phone**

**4.2 Adding and Removing Programs**

**4.3 Using Task Manager and Managing Memory**

**4.4 Managing and Backing Up Files**

**4.5 Protecting Your Phone**

**4.6 Restarting Your Phone**

**4.7 Resetting Your Phone**



## 4.1 Personalizing Your Phone

### Set up the Home screen

The Home screen is the starting place for most of the tasks you perform on your phone. You can gain access to all features and programs from the Home screen.

#### To customize the Home screen

1. On the Home screen, click **Start > Settings > Home Screen**.
2. In **Home screen layout**, **Color scheme**, **Background image**, and **Time out**, select the options you want, and click **Done**.

#### To set a picture as the background

1. On the Home screen, click **Start > Pictures & Videos**.
2. Select the picture you want to set as the background. Click **View** or press CENTER OK for a larger view of the image.
3. Click **Menu > Use as Home Screen**.
4. Use the NAVIGATION CONTROL to select the portion of the picture you want to use, and click **Next**.
5. In **Adjust the transparency**, select a higher percentage for a more transparent picture and then click **Finish**.

**Note** If the picture fits the screen, step 4 is skipped.

### Set date, time, language, and other regional options

Your phone should already be set up with the regional settings that are appropriate for your locale.

#### To change regional settings

You can specify the language, locale, date and time style, as well as number and currency formatting options.

1. On the Home screen, click **Start > Settings > Regional Settings**.
2. In **Language**, select your preferred language.
3. In **Locale**, select the locale for the language you selected. The **Locale** option automatically changes the format of the remaining options (such as date, time, and currency) according to the locale you specify.
4. Click **Done**.

**To set the date and time**

1. On the Home screen, click **Start > Settings > Clock & Alarm > Date and Time**.
2. Set the **Time zone**, **Date**, and **Time**, and then click **Done**.

**Choose how to be notified about events or actions**

A profile is a group of settings that determine how your phone will alert you to phone events such as incoming calls and notifications.

**To change the current profile**

1. On the Home screen, click **Start > Settings > Profiles**.
2. Choose a new profile, and click **Done**.

**Tip** To quickly change the profile, briefly press **POWER** to display the Quick List, and choose a profile.

**To edit a profile**

1. On the Home screen, click **Start > Settings > Profiles**.
2. Select the profile to edit.
3. Click **Menu > Edit**.
4. Modify the settings, and click **Done**. To cancel without saving changes, click **Cancel**.

**Tip** To revert to the default profile settings, click **Menu > Reset to default**.

**To specify the sound for an event**

1. On the Home screen, click **Start > Settings > Sounds**.
2. For the desired event, select a sound. Select **None** if you do not want to hear a sound.
3. Click **Done**.

**Note** For ring tones, you can use sound files in either the **\*.wav**, **\*.mid**, **\*.wma**, or **\*.mp3** file format. For notifications or reminders, you can use **\*.wav** or **\*.mid** files.

**Tip** When you select a sound, the sound plays. To hear it again, select **Menu > Play**.

**To set sound for the keypad and keyboard**

1. On the Home screen, click **Start > Settings > Sounds**.
2. In **Keypad control**, select a sound. Select **None** if you do not want to hear any sound while pressing a key.
3. Click **Done**.

**To copy a sound to your phone**

After a sound file is located on your phone, you can use it for a ring tone, notification, or reminder. Sound files in either .wav, .mid, .wma, or .mp3 formats can be used.

1. Connect the phone to your PC using a USB connection.
2. On your PC, copy the sound file you want.
3. In Windows Mobile Device Center, click **File Management > Browse the contents of your device**.  
Or  
In ActiveSync on your PC, click **Explore** and double-click **My Windows Mobile-Based Device**.
4. Save the sound file on your phone by going to **Application Data > Sounds**, and pasting the file into that folder.

**To set an alarm**

1. On the Home screen, click **Start > Settings > Clock & Alarm > Alarm**.
2. In **Alarm time**, enter the time for the alarm to go off.
3. In **Alarm**, choose which whether to have the alarm go off every day or on weekdays only. To disable the alarm, select **Off**.
4. Click **Done**. The **Alarm** icon appears on the Time display area of HTC Home.

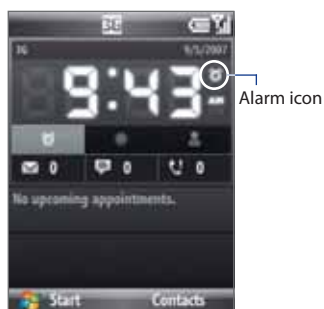



## Set personal information

Entering and displaying owner information are best practices; they allow someone to return the phone to you in case it is lost.

### To enter owner information

1. On the Home screen, click **Start > Settings > Owner Information**.
2. Enter the necessary information and click **Done**.

## Set performance and maintenance options

### To change accessibility settings

1. On the Home screen, click **Start > Settings > Accessibility**.
2. Select your preference for the following:
  - In **System font size**, set the size of the font that is displayed on the screen.
  - In **Multipress time out**, set the length of time between keypresses when entering text in Multipress mode.
  - In **Confirmation time out**, set the delay before an unconfirmed action times out.
  - In **In-call alert volume**, set the volume for incoming call or receiving new message alerts while you are in a call.
3. Click **Done**.

### To change power management settings

You can use Power Management to check the battery, and configure settings that prolong battery life.

1. On the Home screen, click **Start > Settings > Power Management**.
2. Adjust the available settings:
  - In **Light Sensor Enable**, select whether to turn it on or off. If this is turned on, the light sensor senses the dark conditions and activates a backlight under the keypad and keyboard.
  - In **When device is turned on, do not charge the battery when connected to PC**, select **Off** if you want to charge the phone battery when the phone is connected to the computer through USB.
3. Click **Done**.

**Tip** **Main battery** indicates the amount of battery life remaining.

**To find the operating system version number**

- On the Home screen, click **Start > Settings > About**.

**To find the phone specification**

- On the Home screen, click **Start > Settings > Device Information**.

**To turn on and off error reporting**

1. On the Home screen, click **Start > Settings > Error Reporting**.
2. Select **Enable** or **Disable** and click **Done**.

## 4.2 Adding and Removing Programs

Before you purchase additional programs for your phone, make sure that they are compatible for Windows Mobile® 6 Standard operating system.

**To add programs**

1. Download the program to your PC (or insert the disc that contains the program into your PC). You may see a single \*.exe file, a \*.zip file, a Setup.exe file, or several versions of files for different device types and processors. Be sure to select a program designed for your phone and processor type.
2. Read the installation instructions that came with the program.
3. Connect your phone to the PC and then double-click the \*.exe file.

**To remove a program**

Programs that are preinstalled on the phone cannot be removed.

1. On the Home screen, click **Start > Settings > Remove Programs**.
2. Scroll to the program to remove, and then click **Menu > Remove**.

## 4.3 Using Task Manager and Managing Memory

### Check Memory Status

#### To see how much memory is available

1. On the Home screen, click **Start > Settings > About**.
2. Scroll down to check the **Available Memory**.

#### To see how much storage space is available

1. On the Home screen, click **Start > Settings > About**.
2. Scroll down to check the **Available Storage**.

### Use Task Manager

Task Manager allows you to view all the programs currently running on your phone in the form of a list.

#### To start Task Manager

1. On the Home screen, click **Start > Task Manager**.
2. On the Task Manager screen, click **Menu** to open a list that lets you go to a specific program, stop running programs, and view system information.
3. To stop a running program, select a program on the list and click **Menu > Stop**.
4. To stop all running programs, click **Menu > Stop All**.

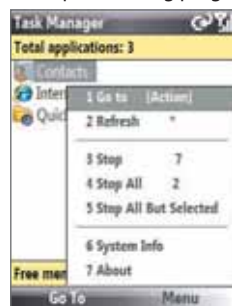

## 4.4 Managing and Backing Up Files

You can back up files to your PC using Windows Mobile Device Center or ActiveSync or copy files to a storage card that is installed on your phone. You can also efficiently manage your files and folders using File Explorer installed on your phone.

### To copy files using Windows Mobile Device Center/ActiveSync to the PC

1. Connect your phone to your PC.
2. In Windows Mobile Device Center, click **File Management > Browse the contents of your device.**  
Or  
In ActiveSync on your PC, click **Explore**. This opens the Mobile Device folder for your phone.
3. Browse your phone for files that you want to copy to your PC.
4. Select and copy the files [**Ctrl + C**] and then paste them [**Ctrl+V**] to the destination folder in the PC.

Copying a file results in separate versions of a file on your phone and PC. Changes made to one file will not affect the other since the files are not synchronized.

### Use File Explorer

File Explorer provides many easy-to-use features for file and folder management.

#### To start File Explorer

- On the Home screen, click **Start > File Explorer**.

File Explorer operates in the following two views:

- List View
- Icons View

File Explorer displays the entire file structure in your phone's memory. The functions focus primarily on folder management. When initially started, File Explorer is in List View by default. To switch between views, click **Menu > View > Icons** or **List**.



File Explorer - List View



File Explorer - Icons View

In File Explorer, click **Menu** to open a list that lets you send or beam the file, view the file's properties, sort the files, and more.

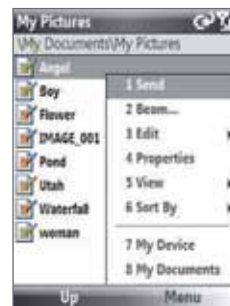

**To send a file as an e-mail attachment**

1. In File Explorer, select a file and click **Menu > Send**.
2. On the Messaging screen, select an e-mail account.
3. The file will automatically be attached to the new message. Specify the recipient and subject, and type your message.
4. Click **Send**.

**Note** You can also send the file via MMS.

## 4.5 Protecting Your Phone

You can protect your phone from unauthorized use by requiring a PIN (personal identification number) in order to make calls. Additionally, you can also lock the keypad/keyboard or the entire phone.

### To enable the SIM PIN

1. On the Home screen, click **Start > Settings > Security > Enable SIM PIN**.
2. Enter your PIN, and click **Done**.

**Note** To cancel without enabling the SIM PIN, click **Cancel**.

### To disable the SIM PIN

1. On the Home screen, click **Start > Settings > Security > Disable SIM PIN**.
2. Enter your PIN, and click **Done**.

### To change the SIM PIN

Be sure to make a note of your PIN. When the SIM PIN is enabled, you must provide this PIN to unlock the phone.

1. Click **Start > Settings > Security > Change SIM PIN**.
2. In **Old PIN**, enter the current PIN.
3. Enter and confirm the new PIN, and click **Done**.

### To lock the keypad and keyboard

Locking the keypad and keyboard turns off its functionality. This is a helpful feature if, for example, the phone is turned on and in your pocket, and you want to prevent accidental keypresses.

- On the Home screen, press and hold END (  ). Once the keypad and keyboard are locked, the left soft key label changes to **Unlock**.

**Tip** To quickly lock the keypad and keyboard, press **POWER** briefly to display the Quick List, and select **Lock**.

**Note** You can still receive calls and make emergency calls when the keypad and keyboard are locked.

**To unlock the keypad and keyboard**

- On the Home screen, click **Unlock** and press the **\*XT9** key.

**Tip** By default, the keypad will become unlocked when you slide the QWERTY keyboard out. You can change the setting by clicking **Start > Settings > Button Lock** and then selecting or clearing the **Unlock device when keypad is opened** option.

**To enable the phone lock**

1. On the Home screen, click **Start > Settings > Security > Device lock**.
2. Select **Prompt if device unused for**, then select the amount of time for the phone to be inactive before automatically locking.
3. Select the **Password type**, then enter and confirm your password.
4. Click **Done**.

**Note** Once you configure the phone lock settings, you can enable the phone lock from the Quick List directly without configuring the settings again.

**To disable the phone lock**

- Click **Unlock** and then enter the password you have set to unlock your phone.

**To encrypt files on the microSD card**

- Click **Start > Settings > Security > Encryption** and select **Encrypt files placed on storage cards**.

## 4.6 Restarting Your Phone

Restart your phone when a program is not performing properly or the phone is not responding to any keypresses.

**To restart the phone**

1. Remove the battery.
2. Wait for three seconds, then reinsert the battery and turn on your phone.

**WARNING!** If the phone is restarted while a program is running, any unsaved work will be lost.

## 4.7 Resetting Your Phone

Resetting your phone will remove all the data from its memory and restore the phone back to the factory default settings.

**Note** If **Encrypt files placed on storage cards** is or was enabled before, then backup all files from the storage card BEFORE using Clear Storage or updating the ROM system software. Otherwise you will no longer be able to access the encrypted files on the storage card. Use ActiveSync or Windows Mobile Device Center to transfer files between your storage card and computer. After the procedure, copy your files back to the storage card.

**WARNING!** Because all your data will be deleted, it is recommended that you back up your data first before resetting your phone.

### To reset your phone

1. Click **Start > Accessories > Clear Storage**.
2. Follow the on-screen instructions to reset the phone. The phone will restart after it has been reset.



# Chapter 5

## Organizing Phone Information

**5.1 Contacts**

**5.2 SIM Manager**

**5.3 Calendar**

**5.4 Tasks**

**5.5 Quick Notes**

**5.6 Voice Notes**

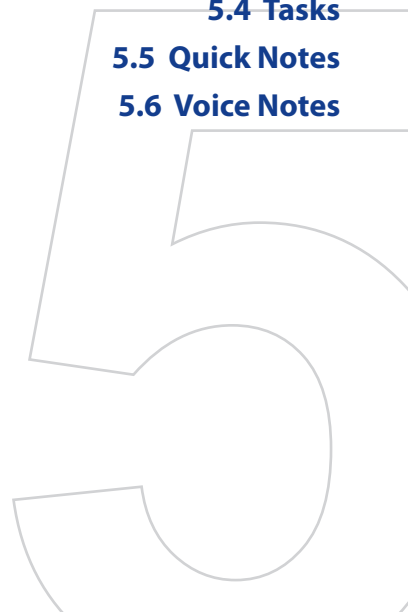

## 5.1 Contacts

Contacts is your address book and information storage for the people and businesses you communicate with.

If you use Outlook on your PC, you can synchronize contacts between your phone and PC.

### Create a contact on your phone

#### To create a new contact on your phone

1. On the Home screen, click **Start > Contacts > New > Outlook Contact**.

To create a new contact on your SIM/USIM card, select **SIM Contact**. You can also use SIM Manager to add contacts to your SIM/USIM card. For more information about SIM Manager, see "SIM Manager" in this chapter.

2. Enter information for the new contact.
  - To easily identify the caller, you can assign a custom ring tone to each Outlook contact. To assign a custom ring tone, scroll down to **Custom ring tone**, and select the desired ring tone.
  - To assign a picture to a contact, scroll down to **Pictures** and click **Select a picture** and select the picture you want. To remove the picture, click **Menu > Remove Picture**.
3. Click **Done**.

**Tip** If someone who is not in your list of contacts calls you or sends you a message, you can quickly create a contact from Call History or from the message by clicking **Menu > Save to Contacts**.

## Edit and call a contact

### To view and edit a contact information

1. On the Home screen, click **Start > Contacts**.
2. Select the contact whose information you want to view or edit and click **Menu > Edit**.
3. When finished making changes, click **Done**.

### To call a contact from the contact list

1. On the Home screen, click **Start > Contacts**.
2. Select the contact to call and press TALK (  ). The contact's default phone number is dialed.

**Tip** To call a phone number other than the default, click the contact, scroll to the number you want to dial, and press TALK (  ).

## Find a contact

### To find a contact

1. On the Home screen, click **Start > Contacts**.
2. Do one of the following:
  - Begin entering a name or phone number of the contact until the contact is displayed. When you press a key, such as **5**, you find first and last names that begin with **J, K, and L**, as well as phone numbers that start with **5**. The next key you press continues to narrow the search.
  - If you have assigned categories (e.g. Business) to your Outlook contacts, you can filter the contact list by categories. In the contact list, click **Menu > Filter** and then click a category. To show all contacts again, select **All Contacts**.
  - If you have entered information under **Company** for your Outlook contacts on your phone, you can quickly locate the contacts that work for a specific company. In the contact list, click **Menu > View By > Company**. Click the company to see the contacts who work there.

**Note** If you are not in Name view, click **Menu > View By > Name**.

### Share contact information

#### To beam contact information to another device via Bluetooth

1. On the Home screen, click **Start > Contacts** and then select the contact whose information you want to beam.
2. Click **Menu > Send Contact > Beam**.
3. Select the device where you want to beam the contact details to and click **Beam**.

**Note** Before you can beam, make sure Bluetooth is turned on and set to Visible mode on your phone and the target mobile device. For more information, see "Bluetooth" in Chapter 8.

#### To send contact information via a text message

1. On the Home screen, click **Start > Contacts** and then select the contact whose information you want to send.
2. Click **Menu > Send Contact > SMS \ MMS**. Select the contact information that you want to send and click **Done**.
3. In the new text message, enter the mobile phone number of the person to whom you are sending the contact information to and click **Send**.

#### To send contact information via MMS

1. On the Home screen, click **Start > Contacts**.
2. Select a contact, then click **Menu > Send as vCard**.
3. Enter the recipient in **To** of the MMS message, then click **Send**.

If the recipient accepts the beam, text message, or MMS message, the contact information you sent are automatically saved in that person's Contacts list.

## 5.2 SIM Manager

SIM Manager allows you to view the contents of your SIM/USIM card and transfer contacts from your SIM/USIM card to your phone and vice versa.

### To create a contact on your SIM/USIM card

1. Click **Start > Accessories > SIM Manager**.
2. Click **New** and enter the contact name and phone number.
3. Click **Save**.

**Tip** To change contact information on your SIM/USIM card, click a contact and edit it. After modifying, click **Save**.

### To copy SIM contacts to your phone

1. Click **Start > Accessories > SIM Manager**.
2. Select a SIM contact or select all SIM contacts by clicking **Menu > Select All**.
3. Click **Menu > Save to Contacts**.

### To copy phone contacts to the SIM/USIM card

Only one phone number per contact name can be stored on a SIM/USIM card. When you copy a contact that has several phone numbers to your SIM/USIM card, SIM Manager saves each number under a separate name.

To save each number under a different contact name on the SIM/USIM card, SIM Manager appends an indicator at the end of each name. You can edit this indicator first before you start copying contacts to your SIM/USIM card.

1. Click **Start > Accessories > SIM Manager > Menu > Tools > Options**.
2. On the Options screen, select the check boxes of the types of phone numbers that you want to be added to the SIM/USIM card.
3. Under the **Mark** column, you can change the indicator that will be appended to the SIM contact names for each phone number type. To do so, select a phone type, click **Edit**, enter your desired indicator, then click **Save**.
4. After modifying, click **OK**.

5. Click **Menu > Contacts to SIM**.
6. Select the check boxes of the contact's phone numbers that you want to copy to your SIM/USIM card, then click **Save**.

#### To display your phone number in SIM Manager

1. On the SIM Manager screen, click **Menu > Tools > List of Own Numbers**.
2. Click **Edit**.
3. Change the name, if desired, then enter your mobile phone number.
4. Click **Save**.

When your phone number is stored on the SIM/USIM card, it will appear on the SIM Manager screen.

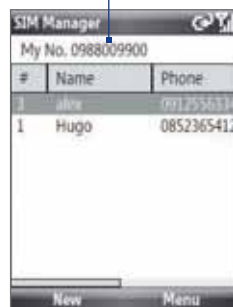

## 5.3 Calendar

Use Calendar to schedule appointments, including meetings and other events. If you use Outlook on your PC, you can synchronize appointments between your phone and PC.

### Create a personal appointment

#### To set Calendar options

1. On the Home screen, click **Start > Calendar**.
2. Click **Menu > Tools > Options**.
3. Scroll through the available settings and set your desired default options.
4. Click **Done**.

### To schedule an appointment

1. On the Home screen, click **Start > Calendar**.
2. Click **Menu > New Appointment**.
3. Enter information about the appointment.
  - To schedule an all-day event, in **End time**, select **All day event**.
  - To make the appointment recurring, click **Occurs**.
4. Click **Done**.

**Note** All-day events do not occupy blocks of time in Calendar; instead, they appear in banners at the top of the calendar.

### View your appointments

#### To view your schedule

You can view your schedule in three different views: **Month**, **Week**, and **Agenda**.

1. On the Home screen, click **Start > Calendar**.
2. Click the left SOFT KEY or click **Menu** and choose the view you want.

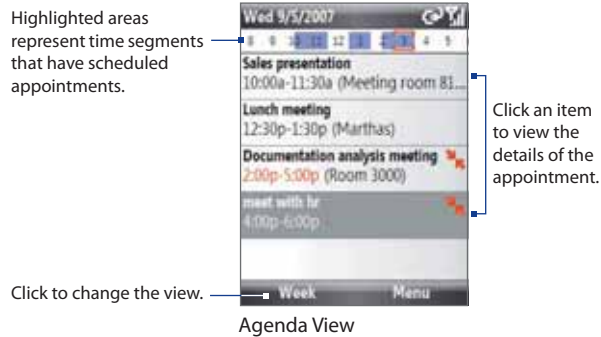

Agenda View

An appointment with the  icon indicates that the scheduled appointment has a conflict with one or more existing appointments.

## Send appointments

### To send a meeting request

You can send meeting requests via e-mail to persons that use Outlook or Outlook Mobile.

1. Click **Start > Calendar**.
2. Schedule a new appointment and then scroll down to **Attendees** and click **No Attendees**. Click **Add Required Attendee** or **Add Optional Attendee** to add the contacts you want to send the meeting request to.
3. Choose the contact(s) you want to send the meeting request to and click **Select**.
4. On the New Appointment screen, click **Done**. The meeting request is sent out.

- Notes**
- You can only specify if an attendee is required or optional if your phone is connected to a Microsoft Exchange 2007 server. Otherwise, all attendees are designated as required. For more information, see Chapter 7.
  - To remove an attendee from the list, select the attendee and click **Menu > Remove Attendee**.
  - When attendees accept your meeting request, the meeting is automatically added to their schedules. When their response is sent back to you, your calendar is updated as well.

### To send a calendar appointment

You can send a calendar appointment to another phone over MMS.

1. On the Home screen, click **Start > Calendar**.
2. Select an appointment, then click **Menu > Send as vCalendar**.
3. Enter the recipient in the **To** line of the MMS message, then click **Send**.



## 5.4 Tasks

Use Tasks to keep track of things you need to do.

### To create a task

1. On the Home screen, click **Start > Tasks**.
2. Click **Menu > New Task**.
3. Enter the necessary task information and click **Done**.
  - Set a **Priority** for the task. This item can be referenced when sorting tasks.
  - Enter a **Start date** and **Due date** if the task starts and ends at a specific time.
  - Enter a **Reminder** if you want to be notified if the task is due.
  - Enter the **Categories** (you can set more than one) that best describes the task. This item can be referenced when filtering tasks.

- Notes**
- You can synchronize information on your phone with your PC to keep your task list up to date in both locations.
  - If you create a new task with a reminder on your PC and then synchronize tasks with your phone, the reminder will play at the time that was set on your PC.

### To locate a task

1. On the Home screen, click **Start > Tasks**.
2. In the task list, do one of the following:
  - To sort the list, click **Menu > Sort by**, and click a sort option.
  - To filter the list by category, click **Menu > Filter**, and click the category you want displayed.

### To mark a task as completed

1. On the Home screen, click **Start > Tasks**.
2. Select the task, and click **Complete**.

## 5.5 Quick Notes

Quick Notes lets you type messages that you frequently use and save them on your phone. You can then send them via e-mail, text message, or MMS.

### To create a new note

1. On the Home screen, click **Start > Quick Notes**.
2. Click **New**.
3. Enter the text and click **Done**.

### To send a note

1. On the Home screen, click **Start > Quick Notes**.
2. On the Quick Notes list, select the text you want to send and click **Menu > Send**.
3. On the Messaging list, select the account you want to use and click **Select**.

## 5.6 Voice Notes

Use Voice Notes to create short voice recordings. Voice notes are included in the All Notes list and are named consecutively (Recording1, Recording2, and so on).

### To create a voice note

1. On the Home screen, click **Start > Voice Notes**.
2. Hold the phone's microphone near your mouth.
3. Click **Record** and say your voice note.
4. Click **Stop** to stop recording a voice note.

### To delete a voice note

1. On the Home screen, click **Start > Voice Notes**.
2. Select the voice note to delete.
3. Click **Menu > Delete**.
4. Click **Yes**.

**Tip** If you delete a voice note that has a default name, such as Recording1, this name becomes available for a new voice note.

**To listen to a voice note**

1. On the Home screen, click **Start > Voice Notes**.
2. Select the voice note to play, and press CENTER OK.

**Tip** To stop listening to the voice note, click **Stop** while the voice note is playing.

**To use a voice note as a ring tone**

1. On the Home screen, click **Start > Voice Notes**.
2. Select the voice note, and click **Menu > Set As Ringtone**.

84 Managing your Phone

# Chapter 6

## Exchanging Messages

**6.1 Messaging**

**6.2 Text Message**

**6.3 MMS Messages**

**6.4 VoiceMail**

**6.5 Setting Up E-mail Accounts**

**6.6 E-mail**



## 6.1 Messaging

**Messaging** is where all of your e-mail, text message, and MMS accounts are located. When you receive a new message, you can open that particular message from the Home screen. Simply scroll to the row where the new message is and click it.

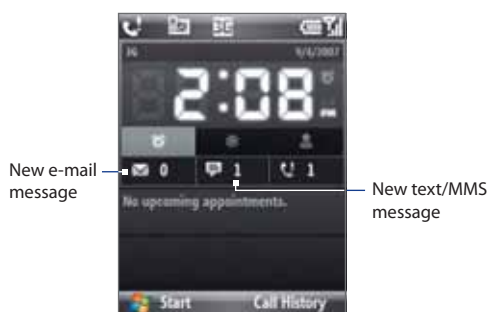

To access your message accounts, click **Start > Messaging** and then click the account you want to open. While in a messaging account's main screen, click **Menu > Tools > Switch Accounts** to switch to another message account.

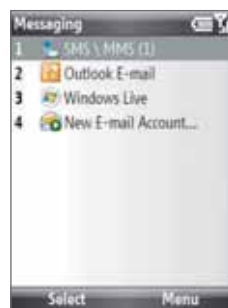

Messaging screen

### To change message account settings

- On the Messaging screen, select the message account whose settings you want to change and click **Menu > Settings**.
- On a message account's message list, click **Menu > Tools > Options**.

## 6.2 Text Message

Send short text messages to your contacts.

### Compose and send text messages

#### To compose and send a text message

1. On the Home screen, click **Start > Messaging > SMS \ MMS**.
2. Click **Menu > New > SMS**.
3. Enter the mobile phone number of one or more recipients, separating them with a semicolon (;).  
To access phone numbers from Contacts, in **To**, click **Menu > Add Recipient**. Select a contact from the list and press CENTER OK.
4. Enter your message. You can enter up to 160 characters in one message.
5. Click **Send**.

**Tips**

- To cancel the text message, click **Menu > Cancel Message**.
- If you want to know whether your text message has been received, before sending the message, click **Menu > Message Options** and select **Request message delivery notification**.

**Note** Text messages can only be sent if your phone is connected to a GSM/EDGE or HSDPA/UMTS network.

### Receive text messages

Text messages are automatically received when the phone function is turned on. When the phone is turned off, text messages are held by your wireless service provider until the next time your phone is turned on.

- Save your SMS messages to your SIM/USIM card by clicking **Menu > Copy to SIM**.
- Copy SMS messages saved on your SIM/USIM card to the Inbox by clicking **Menu > Copy to Phone**. Copying them to your phone results in duplicate messages in the Inbox folder when the SIM/USIM card is in use.
- The  icon next to a message indicates that it is saved on the SIM/USIM card.

## 6.3 MMS Messages

Creating and sending Multimedia Message Service (MMS) messages to your friends and family is fun and easy.

### To access MMS

- On the Home screen, click **Start > Messaging > SMS \ MMS**.

### To access MMS message folders

- Click **Start > Messaging > SMS \ MMS** then click **Menu > Folders**.

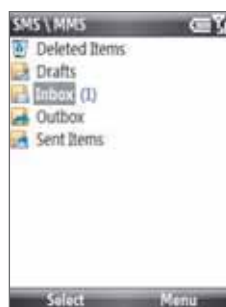

MMS Message Folders

### Edit MMS settings

When you purchase your phone, it is already preset with your wireless service provider's MMS server settings. If you accidentally lost the preset settings or you changed to another wireless service provider, follow the steps below to configure MMS settings.

### To configure MMS settings

1. Click **Start > Messaging > SMS \ MMS** then click **Menu > New > MMS** to open the MMS screen.
2. Click **Menu > Options > Message Options** to open the Preferences screen.
3. Select or clear the provided check boxes according to your needs.
4. On the Preferences screen, click **Menu > MMSC Settings** to access Multimedia Messaging Service Center (MMSC) settings.



5. Check if your phone is preset with MMS server settings.  
If there are no preset settings, click **Menu > New** on the MMSC Settings screen and enter the needed information you see on the screen. You can get the information from your wireless service provider:
6. Click **Done**. The MMS server settings will then be added as an entry on the MMSC Settings screen.



**Note** If you add several MMS service providers to the MMSC Settings screen, you can choose one as your default MMS provider. Select the MMS provider's name in the list, then click **Menu > Set as Default**.

### Create and send MMS messages

You can compose MMS messages in a combination of various slides, where each slide can consist of a photo, audio or video clip, and/or text.

- Notes**
- MMS is a charged service. In order to use MMS successfully, this has to be provisioned on your mobile account. Please contact the wireless service provider to have this provisioned as part of your calling plan.
  - Make sure the size of the MMS is within the limits of the wireless service provider while sending it to another mobile phone user or to an e-mail address.

#### To start composing an MMS message

1. Click **Start > Messaging > SMS \ MMS** then click **Menu > New > MMS**.
2. In **To**, enter the recipient's phone number or e-mail address.
3. In **Subject**, enter a subject for your message.
4. Click **Insert Picture/Video** to select a photo or video clip from the Select Media screen and insert it.



To capture a new photo, click the **Capture Image** icon (  ) or click **Menu > Capture Image**.

To record a new video, click the **Capture Video** icon (  ) or click **Menu > Capture Video**.

5. Click **Insert Text** to enter text for your MMS message.

To insert predefined text or emoticons, click **Menu > Insert My Text** or **Insert Emoticon**.

6. Click **Insert Audio** to insert an audio clip. Select an audio clip on the Select Audio screen.

To record a new audio clip, click **Menu > Capture Audio**.

7. Click **Send** to send the message.

**Tip** After inserting an MMS message element, press NAVIGATION right to add a new slide.

- Notes**
- To send a copy of this message to others, highlight the **To** field and use NAVIGATION up to display the **Cc** and **Bcc** fields.
  - To remove the photo, text, or audio, select the item and press the BACK key (  ).

## View and reply to MMS messages

### To receive MMS messages

- On any MMS message folder screen, click **Menu > Send/Receive**. By default, messages are automatically downloaded to your phone.

### To view an MMS message

You can view MMS messages in several ways.

- Press CENTER OK to view and play the message on your phone. Click **Pause** or **Menu > Stop** to pause or stop the playback of the message.
- Click **Menu > Content View** to see a list of files included in the message. To open a file, select it and click **Open**. To save a file, select it, and click **Save**, **Menu > Save Audio**, or **Menu > Save Photo**.
- View each slide included in the message by clicking **Menu > Next**.

**To reply to an MMS message**

- Click **Menu > Reply > Reply** to reply to the sender of the message, or click **Menu > Reply > Reply All** to reply to all persons listed in the To and CC boxes of the message. Click **Menu > Reply > Forward** to forward the message to someone else.

## 6.4 VoiceMail

**To record and send a voice message**

1. On the Home screen, click **Start > Messaging > SMS \ MMS**.

2. Click **Menu > New > VoiceMail**.

3. Enter the mobile phone number of one or more recipients, separating them with a semicolon (;).

To access phone numbers from Contacts, in **To**, click **Menu > Recipients > From Contacts** or **From Call History**. Select a contact from the list and press CENTER OK.

4. In **Subject**, enter a subject for your voice message.

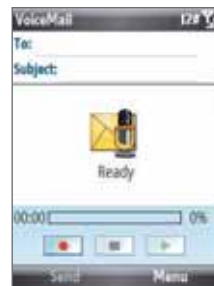

5. Click the Record icon (  ) to start recording your voicemail.

To stop recording, click the Stop icon (  ).

To play the voice message, click the Play icon (  ).

6. Click **Send**.

**Tip** To cancel the voicemail, click **Menu > Cancel Message**.

**To configure voicemail settings**

1. Click **Start > Messaging > SMS \ MMS** then click **Menu > New > VoiceMail** to open VoiceMail screen.
2. Click **Menu > Options > Message Options** to open the Preferences screen.
3. Select or clear the provided check boxes according to your needs.

## 6.5 Setting Up E-mail Accounts

### Types of E-mail Accounts

Before you can send and receive e-mail, you need to set up your e-mail account on your phone. You can set up the following types of e-mail accounts on your phone:

- Outlook e-mail that you synchronize with your PC or your company's Exchange Server
- Internet e-mail account that you have from an Internet Service Provider (ISP)
- Work account that you access using a VPN connection
- Windows Live Mail
- Other web-based e-mail accounts, such as Gmail, Yahoo! Mail, etc.

### Set up your phone to synchronize Outlook e-mail with the computer

If you have installed the synchronization software on your PC and created a partnership with your phone, then your phone is ready to send and receive Outlook e-mail. If you have not yet installed the synchronization software or created a partnership, follow the procedures in Chapter 3.

**Tip** To set up your company e-mail account so that you can access Outlook e-mail messages wirelessly, you must set up your phone to synchronize via an over-the-air connection with your company's Exchange Server. For more information about synchronizing with your company e-mail server, see Chapter 7.

### E-mail Setup Wizard

Windows Mobile's **E-mail Setup Wizard** lets you easily set up your personal and work e-mail accounts. You can add an e-mail account from an Internet Service Provider (ISP) or other e-mail provider as well as web-based accounts such as Gmail®, Yahoo!® Mail Plus, AOL®, etc.

**Note** For more information about setting up your company Outlook e-mail account, see Chapter 7.

### Set up a POP3/IMAP4 e-mail account

Set up a POP3 or IMAP4 e-mail account on your phone if you have an e-mail account from an Internet service provider (ISP), or a Web-based account such as Gmail, Yahoo! Mail Plus, etc. You can also add a work account that you access using a VPN server connection as a POP3/IMAP4 account.

1. On the Home screen, click **Start > Messaging > New E-mail Account**.
2. Enter your e-mail address, and select the **Try to get e-mail settings automatically from the Internet** check box.

By selecting the option, the phone attempts to download e-mail server settings so that you do not need to enter them manually.

3. Click **Next**.
4. After Auto Setup finishes, click **Next**.

If Auto Setup is unsuccessful, select **Internet e-mail** from the **Your e-mail provider** list on the next screen. You will be asked to enter e-mail server settings during the setup process. See "To specify e-mail server settings" for details.

5. Enter your name. You can also edit the **Account display name** field to specify the name of your ISP or e-mail provider. Click **Next**.
6. Enter your login name if it does not show automatically in the **User name** field. Also enter your password, and select the **Save password** check box. Click **Next**.
7. At this point, e-mail setup is complete. In the **Automatic Send/Receive** list, choose how frequent you want e-mail messages to be automatically sent and downloaded on your phone.

Click **Review all download settings** to select download options, set the e-mail format as HTML or plain text, and more. For more information, see "To customize download and format settings."

8. Click **Finish**.

**To specify e-mail server settings**

If Auto Setup is unsuccessful, contact your ISP or e-mail provider for the incoming mail server and outgoing mail server settings so you can enter them on your phone. Other options that you can select include the following:

- Select the **Outgoing server requires authentication** check box, if required by your provider.
- If the outgoing e-mail server requires a different user name and password for sending e-mail, clear the **Use the same user name and password for sending e-mail** check box. You will be prompted to enter these information.
- Click **Advanced Server Settings**, then select the **Require SSL** check boxes if your e-mail provider uses an SSL connection for more secured e-mail.

From the **Network connection** list, select the data connection that you use for connecting to the Internet.

**To customize download and format settings**

Before you click **Finish** when setting up your POP3 or IMAP4 e-mail account, you can click **Review all download settings** to choose download options, message format, and other settings. Click **Advanced Settings** for further options.

Options	Description
<b>Automatic Send/Receive</b>	You can select a time interval for connecting to the Internet automatically to send and receive messages.
<b>Download messages</b>	Set the number of days of messages that you want to be downloaded to your phone.
<b>Send/receive when I click Send</b>	By default, messages are immediately delivered when you click <b>Send</b> . If you prefer to save outgoing messages to the Outbox folder first, clear the check box. (In this case, you will need to manually send messages by clicking <b>Menu &gt; Send/Receive</b> ).
<b>Use automatic send/receive schedule when roaming</b>	This allows your phone to data roam when there is a set time interval for connecting to the Internet automatically. Since this may result in higher connection costs, you may want to leave the check box cleared.

Options	Description
<b>When deleting messages</b>	Choose whether to delete messages from the mail server when you delete them on your phone.
<b>Message format</b>	Select HTML or Plain Text.
<b>Message download limit</b>	Select the e-mail download size. If you have large volumes of e-mail, use a lower size or select to download headers only.

## 6.6 E-mail

After setting up e-mail accounts on your phone, you can start sending and receiving e-mail messages.

### Create and reply to e-mails

#### To compose and send an e-mail

1. Click **Start > Messaging** then select an e-mail account.
2. Click **Menu > New**.
3. Enter the e-mail address of one or more recipients, separating them with a semicolon. To access e-mail addresses stored in Contacts, in **To**, click **Menu > Add Recipient**. Select a contact from the list and press CENTER OK.
4. Enter a subject and compose your message. To quickly add common messages, click **Menu > My Text** and click a desired message.
5. Click **Send**.

#### Tips

- To set the priority, click **Menu > Message Options**.
- If you are working offline, e-mail messages are moved to the Outbox folder and will be sent the next time you connect.

#### To add an attachment to an e-mail

1. In the message that you are composing, click **Menu > Insert** and click the item you want to attach: **Picture**, **Voice Note**, or **File**.
2. Select the file you want to attach, or record a voice note.

### View and reply to e-mails

When in an e-mail account, press and hold **0** (zero) to open a shortcut list of often-used commands. Press and hold the shortcut key to execute the command.

### To filter the Inbox message list

Filter the e-mail messages in your Inbox to only display the e-mails that contain the sender or e-mail subject you are searching for.

Enter the sender name or e-mail subject you want to look for using the keypad or keyboard. As you press keys, the list narrows down to the conditions you set.

For example, pressing "S" then "A" narrows the list to only the e-mails that contain sender names and e-mail subjects that start with "SA."



### To read incoming messages

By default, only the first few kilobytes of a message are shown when you open and read an incoming message. To read the whole message, do one of the following:

- Scroll down to the end of the message and click **Get the rest of this message**; or
- Click **Menu > Download Message**.

### To download an attachment

In an open message with an attachment to download, click the attachment. If there is more than one attachment, click the other attachments to download them. You can directly open the file in the associated program after you download them by clicking the attachment again.

### To reply to or forward an e-mail

1. Open the message and click **Menu > Reply > Reply, Reply All, or Forward**.
2. Enter your response. To quickly add common messages, click **Menu > My Text** and choose a desired message.



**3. Click Send.**

- Tips**
- To see more header information, scroll up.
  - To always include the original message, from the list view, click **Menu > Tools > Options > Sending**, and select the **Include copy of original message when replying to e-mail** check box.
  - In the Outlook E-mail account, you will send less data if you do not edit the original message. This may reduce data transfer costs based on your rate plan.

**To view and reply to HTML e-mails**

You can receive, view and reply to HTML e-mails from any type of e-mail account. The HTML format is retained, without layout shifting or resizing.

**Note** HTML e-mail support in Outlook Mobile is available only if your company is using Microsoft Exchange Server 2007.

1. Set the message format to HTML. To find out how to set the message format, see "Customize e-mail settings".
2. Click **Start > Messaging**, select your e-mail account, and open an HTML e-mail that you received.
3. Click **Get the rest of this message** that's shown at the bottom of the message to download the whole message.
4. Scroll up (if needed) and click **Click to scroll right** to be able to scroll sideways and get a complete horizontal view of the message.
5. Click **Reply** or click **Menu > Reply** and choose whether to reply to the sender(s) or forward the message.
6. Enter your response and click **Send**.

**Tip** E-mail can contain hyperlinks to Web pages.

### Send and download e-mails

The manner in which you send and receive e-mails depends on the type of e-mail account you have.

#### To send and receive e-mail for an Outlook account

1. Click **Start > ActiveSync**.

2. Connect your phone to your PC.

Otherwise, connect wirelessly if you are synchronizing Outlook e-mail with your company e-mail server. For more information, see Chapter 7.

3. Synchronization automatically begins, and your phone sends and receives Outlook e-mail.

**Tip** You can also manually synchronize anytime by clicking **Sync** in ActiveSync or **Menu > Send/Receive** in Outlook Mobile.

#### To send and receive e-mail for a POP3/IMAP4 account

If you have an e-mail account with an ISP or a work account that you access using a VPN server connection, you send and receive messages through a remote e-mail server. Before sending and downloading messages, you first need to connect to the Internet or your corporate network.

1. Click **Start > Messaging** and click your POP3/IMAP4 e-mail account.
2. Click **Menu > Send/Receive**. The messages on your phone and e-mail server are synchronized: new messages are downloaded to the phone Inbox folder, messages in the phone Outbox folder are sent, and messages that have been deleted from the server are removed from the phone Inbox folder.

### Customize e-mail settings

#### To change the download size and format for Outlook e-mail

1. Disconnect your phone from the computer.
2. Click **Start > ActiveSync**.
3. Click **Menu > Options**, select **E-mail**, then click **Settings**.
4. On the E-mail Sync screen, set the **Download size limit** and **Message format**.
5. Close ActiveSync and reconnect your phone to the computer.

**To change the download size and format for POP3/IMAP4 e-mail**

1. On the POP3/IMAP4 e-mail message list, click **Menu > Tools > Options > Account Settings**.
2. Keep clicking **Next** until you reach the screen where the first item is **Message format**.
3. Configure the **Message format** and **Message download limit** settings.
4. Click **Finish**.

**To exclude your e-mail address when replying to all**

When you reply to all the recipients of an Outlook e-mail, your own e-mail address will also be added to the recipient list. Customize ActiveSync so that your e-mail address will be excluded from the recipient list.

1. In ActiveSync on your phone, click **Menu > Options**.
2. Select the **E-mail** information type and click **Settings**.
3. Click **Menu > Advanced**.
4. In the **My e-mail addresses** text box, enter your e-mail address.  
You can add multiple e-mail addresses here. If you want to enter more than one, separate the e-mail addresses with a semicolon.
5. Click **Done**.

100 Exchanging Messages and Using Outlook

# Chapter 7

## Working with Company E-mails and Meeting Appointments

**7.1 Synchronizing with Your Company E-mail Server**

**7.2 Working with Company E-mails**

**7.3 Managing Meeting Requests**

**7.4 Finding Contacts in the Company Directory**

**7.5 E-mail Security**



## 7.1 Synchronizing with Your Company E-mail Server

Synchronize your phone with your company's Microsoft Exchange Server to keep you connected with your e-mails, contacts, calendar, and other information.

### Set up a company e-mail server connection

Use your phone to access your company e-mails by setting up an Exchange Server connection. You can get the company e-mail server information from your network administrator:

1. Click **Start > Messaging > New E-mail Account**.
2. Enter your e-mail address. Clear the **Try to get e-mail settings automatically from the Internet** check box, then click **Next**.
3. In **Your e-mail provider**, select **Exchange server** and click **Next**.
4. On the screen that follows, click **Next**.
5. In **Server address**, enter the Exchange Server name, and click **Next**.
6. Enter your user name, password, and domain, and click **Next**.
7. Select the check boxes for the types of information items that you want to synchronize with the Exchange Server.
8. To change synchronization settings of an information type, for example, e-mail, select information type, and click **Menu > Settings**.
9. Click **Finish**.

- Tips**
- To change the rules for resolving synchronization conflicts, click **Menu > Advanced**.
  - To change Exchange Server settings, open ActiveSync on your phone and click **Menu > Configure Server**.

**Note** If you synchronized e-mails with your PC before, open ActiveSync on your phone and click **Menu > Add Server Source** to set up an Exchange Server connection. When you are prompted to select information types for synchronization, you need to clear the **E-mail** check box under the Windows PC item first before you can select the **E-mail** check box under Exchange Server.

### Start synchronization

Before you start synchronizing with the Exchange Server, make sure your phone has been set up with a data connection to the Internet so that you can synchronize wirelessly. See Chapter 8 for details.

After you finish setting up an Exchange Server connection, your phone automatically starts synchronization. You can manually start synchronization anytime by clicking **Sync** in ActiveSync.

**Note** If you connect your phone to your office computer via a USB or Bluetooth connection, you can use this connection to the PC to “pass through” to the network and download Outlook e-mails and other information to your phone.

## 7.2 Working with Company E-mails

Your phone gives you instant access to your company e-mails and lets you manage your messages easier. Messaging features such as Direct Push, Fetch Mail, and Filtering messages are just some of the tools you can use to manage your e-mails.

**Note** Some messaging features depend on the Microsoft Exchange Server version used. Please check with your network administrator for the availability of Exchange Server features.



### Automatic synchronization through Direct Push

Direct Push technology (push e-mail feature) enables you to receive new e-mails on your phone as soon as they arrive in your Inbox on the Exchange Server. With this feature, items such as contacts, calendar and tasks are also immediately updated onto your phone when these items have been changed or new entries have been added on the Exchange Server. To make Direct Push work, you need to have a GPRS connection on your phone.

You need to perform a full synchronization between your phone and the Exchange Server first before Direct Push can be enabled.

**Requirement** The Direct Push feature works for your phone only if your company is using **Microsoft Exchange Server 2003 Service Pack 2 (SP2) with Exchange ActiveSync** or higher version.

#### To enable Direct Push via Comm Manager

1. Click **Start > Comm Manager**.
2. On the Comm Manager screen, click the **Microsoft Direct Push** button. The button  will turn to , which indicates that you will receive e-mails as they arrive.

When the button is in the  state, you need to manually retrieve your e-mails.

#### To enable Direct Push via ActiveSync

1. In ActiveSync on your phone, click **Menu > Schedule**.
2. Select **As items arrive** in the **Peak times** and **Off-peak times** boxes.



**Note** When both the GPRS and Wi-Fi connections are turned on at the same time, the Direct Push feature will always opt for GPRS, for which you could be charged as per your network operator's service plan.

#### Scheduled synchronization

If you do not want to use Direct Push, you can set a regular schedule for synchronizing Outlook e-mail and information.

1. In ActiveSync on your phone, click **Menu > Schedule**.
2. Select a shorter time interval in the **Peak times** box for you to be able to receive e-mails more frequently.
3. Select a longer interval in the **Off-peak times** box.

**Tip** Click **Menu > Peak Times** to set the peak and off-peak times.



### Instant download through Fetch Mail

Fetch Mail downloads an entire e-mail immediately without the need for you to perform a full Send/Receive action.

**Requirement** Fetch Mail works for your phone only if your company is using **Microsoft Exchange Server 2007** or higher.

1. Click **Start > Messaging > Outlook E-mail**.
2. Click an e-mail message to open it.
3. By default, only the first few kilobytes of the message is shown. To download the whole e-mail, scroll to the bottom of the message then click **Get the rest of this message**.
4. A "Downloading message" status appears. Wait for the remainder of the message body to be downloaded.

**Tip** For information about changing e-mail sync options such as the initial download size limit for e-mail, see "Customize e-mail settings" in Chapter 6.

### Search for e-mails on the Exchange Server

You can access messages that are not available on your phone by searching your Microsoft Exchange Server mailbox. The search results will be downloaded and displayed in a Search Results folder.

**Requirement** Your company must be using **Microsoft Exchange Server 2007** or higher.

1. Click **Start > Messaging > Outlook E-mail**.
2. Click **Menu > Tools > Search Server**.
3. In the **Look for** text box, enter the search keyword.
4. Choose the **Date range** of messages to search from and where to search in **Look in**.
5. Click **Search**.



### Flag your messages

Flags serve as a reminder to yourself to follow-up on important issues or requests that are indicated in the messages.

**Requirement** Flags are enabled only if e-mails are synchronized with **Microsoft Exchange Server 2007** or higher. Flags are disabled or hidden if e-mails are synchronized with earlier versions of Microsoft Exchange Server.

#### To flag or unflag a message

1. Click **Start > Messaging > Outlook E-mail**.
2. Select a message, or open a message.
3. Click **Menu > Follow Up** and select one of the following options:

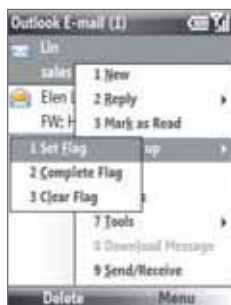

- **Set Flag.** Mark the message with a red flag to indicate that it needs follow up.
- **Complete Flag.** Mark the message with a check mark to indicate that the issue or request in the e-mail is already completed.
- **Clear Flag.** Remove the flag to unmark the message.

**Note** E-mail message reminders are displayed on your phone if the messages are flagged with reminders and synchronized from the Exchange Server.

### Out-of-office auto-reply

Outlook Mobile allows you to retrieve and change your out-of-office status. Just like desktop Outlook E-mail, Outlook Mobile automatically sends an auto-reply message when you're not available.

**Requirement** Your company must be using **Microsoft Exchange Server 2007** or higher.

**To send out-of-office auto-reply messages**

1. Click **Start > Messaging > Outlook E-mail**.
2. Click **Menu > Tools > Out of Office**.
3. From the **I am currently** list, select **Out of the Office**.
4. Enter your auto-reply message then click **Done**.

**View SharePoint documents**

When you receive an HTML e-mail containing a link to a SharePoint document, you can click the link to access and view the document on your phone.

**Note** You need to setting VPN connection first. If you do not set up the VPN connection in advance, you will not be able to connect to Intranet and view the document.

**Requirement** Your company must be using **Microsoft Exchange Server 2007** or higher.

## 7.3 Managing Meeting Requests

When you schedule and send meeting requests from your phone, you can invite attendees to your meeting and check their status to know their availability.

When you receive a meeting request, you can reply by accepting or declining the request. The meeting request also clearly indicates whether or not there are conflicting or adjacent meetings.

**Requirement** Your company must be using **Microsoft Exchange Server 2007** or higher.

**To check the status of invited attendees**

1. Click **Start > Calendar**.
2. Follow the procedure in "To send a meeting request" in Chapter 5 to invite required and optional attendees and send a meeting request.
3. Wait for the attendees to respond. When their responses are sent back to you, your calendar is updated as well.

4. To check the status of the attendees who responded, click **Start > Calendar** and then click the scheduled meeting.
5. In the meeting details, click **Attendees**.

**To reply to a meeting request**

1. When there's an incoming e-mail with a meeting request, a notification message will be displayed on your phone's Home screen. Scroll to **Outlook e-mail** and click it.
2. In the Outlook message list, click the e-mail to open it.
3. Click **Accept** to reply and accept the meeting request, or click **Menu > Decline** if you cannot attend the meeting.

- Tips**
- Before responding, you can check your availability during the time of the requested meeting by clicking **View your calendar**.
  - If the time of the meeting conflicts with your other appointments, a "Scheduling Conflict" status appears on top of the e-mail.
4. Choose whether or not to edit the response e-mail before sending and then click **OK**:

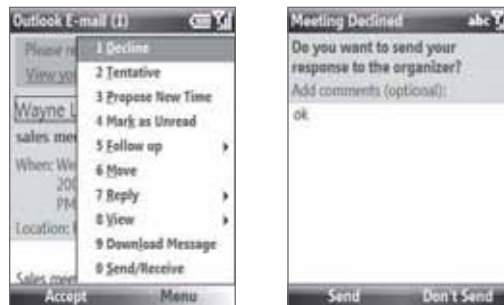

5. If you accepted the meeting request, it will automatically be added as an appointment in Calendar on your phone.

## 7.4 Finding Contacts in the Company Directory

In addition to having contacts on your phone, you can access contact information from your organization's Company Directory.

**Requirement** Access to the Company Directory is available only if your organization is running **Microsoft Exchange Server 2003 SP2** or higher, and you have completed your first synchronization with the Exchange Server.

1. Synchronize with Exchange Server if you have never done so.
2. Do any of the following:
  - In Contacts, click **Menu > Company Directory**.
  - In a new e-mail, click the **To** box and then click **Company Directory** at the top of the list or click **Menu > Company Directory**.



In Contacts



In a new e-mail

- In a new meeting request using Calendar, scroll to **Attendees** and click **No attendees > Add Required Attendee** or **Add Optional Attendee** and then click **Company Directory** at the top of the list.

3. Enter the part or full contact name and click **Search**. In the search results list, click a contact to select it.

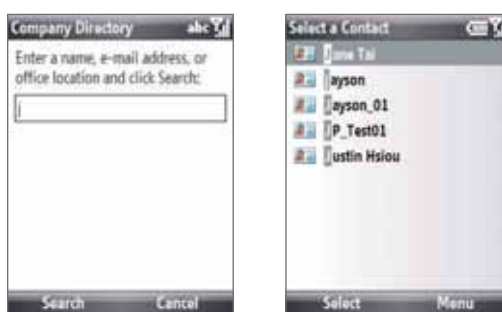

- Notes**
- You can save a contact from the Company Directory to your phone by selecting the contact and then clicking **Menu > Save to Contacts**.
  - You can search on the following information as long as that information is included in your organization's Company Directory: First name, Last name, E-mail name, Display name, E-mail address, or Office location.

## 7.5 E-mail Security

Windows Mobile on your phone protects your Outlook e-mails through Secure/Multipurpose Internet Mail Extension (S/MIME), which allows you to digitally sign and encrypt your messages.

**Requirement** S/MIME encryption and digital signatures for Windows Mobile-based phones are available only with **Exchange Server 2003 SP2** or a later version that supports S/MIME. If you are not using one of these products, or have not yet synchronized, these options are unavailable.

**Note** You can encrypt a message with or without a certificate. However, to decrypt and read an encrypted message, you need a valid certificate.

**To individually sign and encrypt a new message**

1. Click **Start > Messaging > Outlook E-mail**.
2. Click **Menu > New** to create a new message.
3. Click **Menu > Message Options**.
4. From the **Security** list, select whether to encrypt only, sign the message only, or do both.
5. Click **Done**.

**To verify the digital signature on a signed message you receive**

1. Open the Outlook e-mail message that has been digitally signed.
2. At the top of the message, click **View signature status**.
3. Click **Menu > Check Certificate**.

To view the details of the certificate in the message, click **Menu > View Certificate**.

**Note** There are several reasons why a digital signature may not be valid. For example, the sender's certificate may have expired, it may have been revoked by the certificate authority, or the server that verifies the certificate is unavailable. Contact the sender to report the problem.

**To digitally sign and encrypt all messages**

You can set up ActiveSync to digitally sign and encrypt all outgoing messages. You must obtain a valid certificate to sign and encrypt e-mail messages successfully.

1. Click **Start > ActiveSync**.
2. Click **Menu > Options**.
3. Select the **E-mail** information type, and click **Settings**. On the E-mail Sync Options screen, click **Menu > Advanced**.

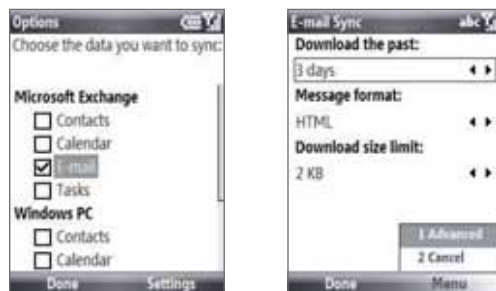

4. Select **Encrypt messages** to protect your e-mails from being viewed except by the intended recipients. Select **Sign messages** so that recipients are certain that e-mails are sent by you and have not been altered.
5. Click **Menu > Choose Certificate** to select a certificate for signing or encrypting outgoing e-mail messages.

### Set permissions on an e-mail message

Another way of protecting your e-mail messages is to send messages with restricted permissions using Information Rights Management (IRM).

**Requirement** This works only with a Microsoft Outlook e-mail account and if your company is using RMS Server SP1.

1. Click **Start > Messaging > Outlook E-mail**.
2. Create a message, then click **Menu > Message Options**.
3. In **Permissions**, do one of the following:
  - To allow anyone to read the message, select **Unrestricted Access**.
  - To prevent the message from being forwarded, printed, or copied, select **Do Not Forward**.
4. Click **Done**.

**Tip** An IRM-protected message received on your phone can only be replied to or forwarded if the message permits it.



# Chapter 8

## Getting Connected

**8.1 Comm Manager**

**8.2 Connecting to the Internet**

**8.3 Internet Explorer Mobile**

**8.4 Internet Sharing**

**8.5 Bluetooth**

**8.6 Windows Live™**

**8.7 Windows Live Messenger**

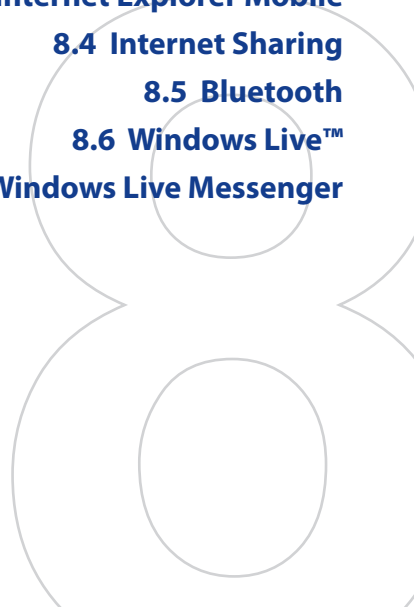

## 8.1 Comm Manager

Comm Manager acts like a central switch that lets you enable or disable phone features as well as manage your data connections easily.

### To open Comm Manager:

- Click **Start > Comm Manager**.



- 1 Click to toggle between turning on or off Flight mode. Turning on Flight mode turns off the phone, Bluetooth and WLAN functions.
- 2 Click to enabling or disable the phone. Click **Settings > Phone** to access phone settings.
- 3 Click to toggle between turning on or off Bluetooth. See "Bluetooth" for details. Click **Settings > Bluetooth** to configure Bluetooth on your phone.
- 4 Click to toggle between turning on or off Wi-Fi. Click **Settings > WLAN Settings** to configure Wi-Fi on your phone. See "Wi-Fi" for details.
- 5 Click to toggle between automatically receiving (as items arrive) or manually retrieving Outlook e-mails. See Chapter 7 for details.
- 6 Click to stop active data services (e.g. GPRS). You cannot reconnect data services in Comm Manager.
- 7 Click to turn on the phone's ringer or set it to vibration/mute mode.
- 8 Click to open ActiveSync so you can synchronize the phone and computer. For more information regarding ActiveSync, see Chapter 3.

## 8.2 Connecting to the Internet

### Ways of Connecting to the Internet

Your phone's networking capabilities allow you to access the Internet or your corporate network at work through wireless and conventional connections.

You can connect to the Internet by using one of the following:

- Wi-Fi
- GPRS/3G
- Dial-up

**Note** You can also add and set up the following connections:

- **VPN:** A VPN connection is used to access your corporate network by using an existing Internet connection.
- **Proxy:** A Proxy connection is used to access the Internet using an existing connection to your corporate or WAP network.

### Wi-Fi

Wi-Fi provides wireless Internet access over distances of up to 100 meters.

**Note** The availability and range of your phone's Wi-Fi signal depends on the number, infrastructure, and other objects through which the signal passes.

#### To connect to an existing Wi-Fi network

1. On the Home screen, click **Start > Comm Manager** and click the **WLAN** icon. The WLAN icon is then highlighted to indicate that WLAN is turned on.
2. After a few seconds, a message asks you if you want to see the list of available networks, click **Yes**.
3. In **Select network**, choose the WLAN network to connect to.
4. In **Network type**, select **Internet** and click **Connect**.

If you are connecting to a security-enabled network, you will be asked to enter the **WEP Key**. Enter the **WEP Key** and click **Done**.

You can check the Wi-Fi icon on the Title bar of the screen to see if you are connected to the Wi-Fi network. To see the status icons, please see "Status Indicators" in Chapter 1.

- Notes**
- Wi-Fi connects to the default network that is available on your phone. However, GPRS starts by default if your phone does not detect any Wi-Fi signal.
  - In Comm Manager, click **Settings > WLAN Settings > Connection Status** to check the current connection status and signal quality of each Wi-Fi channel.

#### **To increase security on the Wi-Fi network**

The LEAP (Lightweight Extensible Authentication Protocol) feature of Comm Manager helps increase security on your phone, and ensures that nobody is able to access your network without your permission.

1. On the WLAN Settings screen, select **LEAP**.
2. Click **Menu > New**.
3. Enter the **SSID** (Service Set Identifier). You can obtain this information from your wireless service provider.
4. Enter the user name, password, and domain.
5. Select an **Authentication Type**.

By default, the **Authentication Type** for your phone is **Open System** authentication.

- Notes**
- By default, the LEAP screen displays data that you entered previously. However, you can modify or delete the data as required by clicking **Menu > Modify** or **Menu > Delete** on the LEAP screen.
  - For LEAP to work correctly, the receiving phone (your phone) must be set with the same SSID, user name, and password as the access point.

#### **GPRS/3G**

You can use GPRS/3G to connect to the Internet or to send and receive MMS on your phone. When you use GPRS/3G, you will be billed per KB (Kilobyte) when sending or receiving information.

If GPRS settings are not preset on your phone, obtain the **Access point name** from your wireless service provider. Also, check with your wireless service provider if a user name and password are required.

- Note** Check with your service provider how much it charges for its GPRS service.

**To set up a new GPRS connection**

1. On the Home screen, click **Start > Settings > Connections > GPRS > New**.
2. In **Description**, enter a name for the connection.
3. In **Connects to**, select **The Internet**.
4. Enter the name of the GPRS **Access point** of your wireless service provider.
5. Enter the appropriate information in the remaining fields, if required by your wireless service provider.
6. Click **Done**.

**Dial-up**

When you use your phone to dial up to your ISP and connect to the Internet or to your corporate network, you will be billed by the number of minutes that you use.

**To set up a dial-up connection for browsing the Internet**

1. On the Home screen, click **Start > Settings > Connections > Dial-up > New**.
2. In **Description**, enter a name for the connection.
3. In **Connects to**, select **The Internet**.
4. Enter the appropriate information in the remaining fields.
5. Click **Done**.

**To set up a dial-up connection to your corporate network**

1. On the Home screen, click **Start > Settings > Connections > Dial-up > New**.
2. In **Description**, enter a name for the connection.
3. In **Connects to**, select **Work**.
4. Enter the appropriate information in the remaining fields.
5. Click **Done**.

#### **Advanced options**

From the Connections screen, you can access advanced options to specify the service provider, the number of redial attempts, the amount of idle time to wait before disconnecting, and so on.

1. On the Home screen, click **Start > Settings > Connections > Menu > Advanced**.
2. Select a network service provider for each connection type. You can choose **Automatic** to allow the phone to set a service provider for each connection by default.
3. Click **Menu > Options**.
4. Choose the appropriate information in the remaining fields.
5. Click **Done**.

#### **Add a URL exception**

Some URLs for Web pages on your company intranet may use periods, for example: intranet.companyname.com. To view these pages in Internet Explorer Mobile, you must create a URL exception.

1. On the Home screen, click **Start > Settings > Connections > Menu > Advanced**.
2. Click **Menu > Work URL Exceptions > Menu > Add**.
3. In **URL Pattern**, enter the URL name. To add multiple URLs, use a semicolon (;).
4. Click **Done**.

**Note** You do not need to create URL exceptions for Internet URLs.

## 8.3 Internet Explorer Mobile

Internet Explorer Mobile is a full-featured Internet browser, optimized for use on your phone.

### To open Internet Explorer

- On the Home screen, click **Start** > **Internet Explorer**.

### Browsing the Web

1. In Internet Explorer, click **Menu** > **Address Bar**.
2. Enter the address and click **Go**.
3. Use the NAVIGATION CONTROL to browse the Web page. Press CENTER OK when a link is highlighted to access it.

While browsing the Web, click **Menu** to open a list of options that will let you change the view, save Favorites, and set Internet Explorer Mobile preferences, and more.

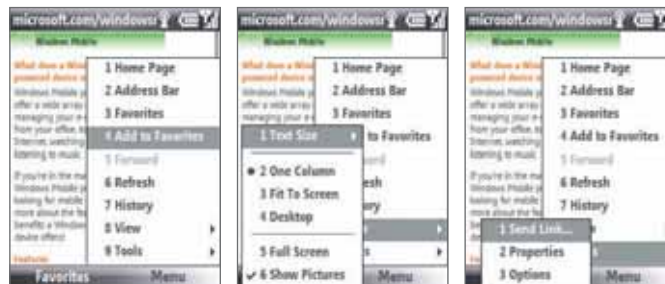

Click **Menu** > **Add to Favorites** to save the current Web page in your Favorites folder. Click **Favorites** to access your Favorites folder.

Click **Menu** > **View** and then select the text size and type of view you want to use while browsing a Web page.

Click **Menu** > **Tools** to let you send the link via e-mail, view the page's properties, or set Internet Explorer Mobile preferences.

For more information about Internet Explorer Mobile, please go to <http://www.microsoft.com/windowsmobile/help/smartphone/browseinternet.aspx>

## 8.4 Internet Sharing

With Internet Sharing, you can use your phone as an external modem for another device such as a PDA or notebook computer.

- Notes**
- Make sure your phone has a SIM/USIM card installed, and you have set up a GPRS or phone dial-up modem connection on your phone. If your phone has not been set up with a data connection yet, click **Menu > Connection Settings** on the Internet Sharing screen. For more information about setting up a GPRS connection, see "GPRS/3G". For more information about setting up a phone dial-up connection, see "Dial-up".
  - Before using Internet Sharing, disable ActiveSync on your computer. To disable ActiveSync, open ActiveSync then click **File > Connection Settings** and clear **Allow USB Connections**.

### Set up the phone as a modem

#### To set up the phone as a USB modem

1. On your phone, click **Start > Internet Sharing**.
2. In the **PC Connection** list, select **USB**.
3. In the **Network Connection** list, select the name of connection that your phone uses to connect to the Internet.
4. Plug in the USB cable between your phone and the computer.
5. Click **Connect**.

#### To end the Internet connection

- On the Internet Sharing screen, click **Disconnect**.

#### To set up the phone as a Bluetooth modem

You can connect your phone to a computer through Bluetooth and use the phone as a modem for the computer.

To learn how to set up the phone as a Bluetooth modem, see "Use the phone as a Bluetooth modem" in this chapter.



## 8.5 Bluetooth

Bluetooth is a short-range wireless communications technology. Phones with Bluetooth capabilities can exchange information within a distance of about 10 meters without requiring a physical connection.

### Bluetooth modes

Bluetooth on your phone operates in three different modes:

1. **On.** Bluetooth is turned on. Your phone can detect other Bluetooth-enabled devices, but not vice versa.
2. **Off.** Bluetooth is turned off. In this mode, you can neither send nor receive information using Bluetooth.
3. **Visible.** Bluetooth is turned on, and all other Bluetooth-enabled devices within range can detect your phone.

**Note** By default, Bluetooth is turned off. If you turn it on, and then turn off your phone, Bluetooth also turns off. When you turn on your phone again, Bluetooth automatically turns on.

### To turn on or off Bluetooth on your phone

You can enable Bluetooth by clicking the Bluetooth button in the Comm Manager. You can also do the following:

1. On the Home screen, click **Start > Settings > Connections > Bluetooth**.
2. Click **Bluetooth > Menu > Turn On Bluetooth**.
3. To turn off Bluetooth capabilities on your phone, click **Bluetooth > Menu > Turn Off Bluetooth**.

### To make your phone visible

1. On the Home screen, click **Start > Settings > Connections > Bluetooth**.
2. Click **Bluetooth > Menu > Turn On Visibility**.

**Tip** Enter a Bluetooth phone name for your phone. This will be the phone name that will be shown on another Bluetooth-enabled device when it searches and detects your phone. To enter a name, on the Bluetooth screen, click **Security** and enter a **Device name**.

### Bluetooth partnerships

A Bluetooth partnership is a relationship that you create between your phone and another Bluetooth-enabled device in order to exchange information in a secure manner.

#### To create a Bluetooth partnership

1. On the Home screen, click **Start** > **Settings** > **Connections** > **Bluetooth**.
2. Click **Bluetooth** > **Add new device**.  
Your phone searches for other Bluetooth-enabled devices and lists them.
3. Select the desired device name in the list and click **Next**.
4. Enter a passcode (1 up to 16 characters) to establish a secure connection, then click **Next**.
5. Wait for the paired device to accept the partnership:
6. On your phone, a message will appear, indicating that your phone has connected with the paired device. Click **OK**.
7. The name of the paired device is then displayed. You may edit and enter a new name for that device, then click **Next**.
8. Select the check boxes of services that you want to use from the paired device and click **Done**.

#### To accept a Bluetooth partnership

1. Ensure that Bluetooth is turned on and in visible mode.
2. Click **Yes** when prompted to establish a partnership with the other device.
3. Enter a passcode (the same passcode that is entered on the device requesting the partnership) to establish a secure connection.
4. Click **Next**.
5. A message will appear, indicating that your phone has connected with the paired device. Click **OK**.
6. The name of the paired device is then displayed. You may edit and enter a new name for that device, then click **Next**.

7. Select the check boxes of services that you want to use from the paired device.
8. Click **Done**. You can now exchange information with the other device.

#### **To change the display name of a Bluetooth device**

1. On the Home screen, click **Start > Settings > Connections > Bluetooth**.
2. Click **Bluetooth** and then on the screen, select a Bluetooth device.
3. Click **Menu > Edit**.
4. Enter a new display name for the Bluetooth device, then click **Next**.
5. Click **Done**.

#### **To delete a Bluetooth partnership**

1. On the Home screen, click **Start > Settings > Connections > Bluetooth**.
2. Click **Bluetooth** and then on the screen, select a Bluetooth device.
3. Click **Menu > Delete**, and then click **Yes** in the confirmation screen.
4. Click **Done**.

#### **Connect a Bluetooth hands-free or stereo headset**

For hands-free phone conversations or to listen to music, you can use a Bluetooth hands-free or stereo headset.

**Note** You need a Bluetooth stereo headset to listen to music.

#### **To connect a Bluetooth hands-free or stereo headset**

1. Make sure that both your phone and the Bluetooth headset are turned on and within close range, and that the headset is visible. Refer to the manufacturer's documentation to find out how to set the headset in visible mode.
2. On the Home screen, click **Start > Settings > Connections > Bluetooth**.
3. Click **Bluetooth > Add new device**. Your phone searches for other Bluetooth-enabled devices and displays them in the list.

124 Getting Connected

4. Select the name of the headset, and click **Next**.
5. In **Passcode**, enter the alphanumeric passcode for the Bluetooth headset, then click **Next**. The passcode is usually "0000".

A message will appear saying that your phone has connected to the headset, click **OK**.

6. Enter the display name for the headset and click **Next**.
7. Select the check boxes for the **Wireless Stereo** (if available) and **Hands Free** services, and click **Done**.



**Note** If the Bluetooth stereo headset becomes disconnected, turn the headset on and repeat steps 1 to 2 above. Select the stereo headset and click **Menu > Set as Wireless Stereo**.



## Beam information using Bluetooth

You can beam information, such as contacts, calendar items, and tasks, as well as files from your phone to your computer or to another Bluetooth-enabled device.

- Notes**
- If your computer does not have built-in Bluetooth capabilities, you need to connect and use a Bluetooth adapter or dongle on your computer.
  - Before beaming items to your computer, open Bluetooth Configuration or Bluetooth Settings in the Control Panel and check if there's an option for setting a location for saving beamed items.

### To beam information from your phone to a computer

1. Set Bluetooth on your phone to visible mode. For information about this, see "To make your phone visible".
2. Next, set Bluetooth on your computer to visible mode, create a Bluetooth partnership, then enable your computer to receive Bluetooth beams.

If your computer has Windows Vista or Windows XP SP2 and your computer's Bluetooth adapter is supported by your Windows version, do the following steps:

- a. On your computer, open **Bluetooth Devices** from the Control Panel then click the **Options** tab.
- b. For Windows Vista, select **Allow Bluetooth devices to find this computer**; or  
For Windows XP, select **Turn discovery on** and **Allow Bluetooth devices to connect to this computer**.
- c. Create a Bluetooth partnership between your phone and computer. For information about creating a partnership, see "Bluetooth partnerships".
- d. In the **Options** tab of **Bluetooth Devices**, select **Show the Bluetooth icon in the notification area**.
- e. To enable your computer to receive Bluetooth beams, right-click the Bluetooth icon at the bottom-right of your computer screen and select **Receive a File**.

3. Now you are ready to beam. On your phone, select an item to beam. The item can be an appointment in your calendar, a task, a contact card, or a file.
  - Calendar appointment: Click **Menu > Beam Appointment**.
  - Task: Click **Menu > Beam Task**.
  - Contact: Click **Menu > Send Contact > Beam**.
  - File: Click **Menu > Beam**.
4. Select the device name to which you want to beam to.
5. Click **Beam**.
6. If you beamed a calendar, task, or contact item to your computer and it is not automatically added to Outlook, click **File > Import and Export** to import it to Microsoft Outlook on your computer.

To beam information to a Bluetooth-enabled device such as another phone, create a Bluetooth partnership then perform steps 3 to 6 in the above procedure.

**Note** Not all file types can be sent via Bluetooth.

**Tip** The default folder on your computer where beamed items are stored may be  
**Windows XP:** C:\Documents and Settings\your\_username\My Documents  
**Windows Vista:** C:\users\your\_username\My Documents.

### Bluetooth Explorer and Bluetooth file sharing

Bluetooth Explorer searches for other Bluetooth devices that have file sharing enabled and lets you access their Bluetooth shared folder. You can copy files from and to their shared folder, and create subfolders in it. When you enable Bluetooth file sharing on your device, other Bluetooth-enabled devices will also be able to access your Bluetooth shared folder.

#### To enable Bluetooth Explorer and Bluetooth file sharing on your phone

1. Click **Start > Settings > Connections > Bluetooth > FTP**.
2. Select the **Enable Bluetooth Explorer** check box. This makes the **/Bluetooth** phone folder visible in File Explorer.
3. Select the **Enable File Sharing** check box. Click **Browse** to change the folder to share.

**To use Bluetooth Explorer**

1. Bluetooth Explorer is integrated with the File Explorer program. You can open it by clicking **Start > Bluetooth Explorer** or by clicking the **Bluetooth** folder under the My Device folder in File Explorer.
2. Bluetooth Explorer then scans for other Bluetooth-enabled devices. From the list, select a Bluetooth device you want to connect to. You may need to enter a passcode in order for you to connect to the device.
3. If there are files contained in the Bluetooth shared folder on the other device, you will be able to see them on the Bluetooth Explorer screen. Select a file and click **Menu > Edit** and choose to cut or copy the files.
4. Click **Up** twice.
5. Navigate to the folder where you want to paste the files on your device, then click **Menu > Edit > Paste**.

**Use the phone as a Bluetooth modem**

You can connect your phone to a notebook or desktop computer through Bluetooth and use the phone as a modem for the computer.

For the computer to use the Internet connection of your phone, activate Internet Sharing on your phone, then set up a Bluetooth Personal Area Network (PAN) between the computer and your phone.

1. On your phone, turn on Bluetooth and set it to visible mode.
2. Initiate a Bluetooth partnership from your phone by following the steps in "To create a Bluetooth partnership."
3. Click **Start > Internet Sharing**.
4. Select **Bluetooth PAN** as the **PC Connection**.
5. From the **Network Connection** list, select the name of the connection that your phone uses to connect to the Internet.
6. Click **Connect**.

7. On your computer, set up a Bluetooth Personal Area Network (PAN) with your phone:
  - **For Windows XP**
    - a. Click **Start > Control Panel > Network Connections**.
    - b. Under **Personal Area Network**, click the **Bluetooth Network Connection** icon.
    - c. Under **Network Tasks**, click **View Bluetooth network devices**.
    - d. In the Bluetooth Personal Area Network Devices dialog box, select your phone, then click **Connect**.
  - **For Windows Vista**
    - a. Click **Start > Control Panel > Network and Sharing Center**.
    - b. Click **Manage network connections** and then under **Personal Area Network**, double-click **Bluetooth Network Connection**.
    - c. In the Bluetooth Personal Area Network Devices dialog box, select your phone, then click **Connect**.
8. On the Internet Sharing screen on your phone, check if the connected status is displayed, which indicates that your computer has been successfully connected to the Internet using your phone as a Bluetooth modem.

### Print files via Bluetooth

Connect your device to a Bluetooth printer to print contact information, appointment details, messages, and other file types.

Before you start printing, make sure to turn on the Bluetooth printer and to turn on Bluetooth on your phone. To turn on Bluetooth, select **Start > Comm Manager** and then select the Bluetooth button.

**Note** You can print files in the \*.txt, \*.jpg, \*.xhtml, \*.vcf, and \*.vcs file formats.

### To print contact information

1. Click **Start > Contacts** and then select the contact whose information you want to print.
2. Click **Menu > Print via Bluetooth**.



3. Click **Menu > Search Devices**. Your phone starts to search for Bluetooth devices.
4. Select the Bluetooth printer and then click **Menu > Send File**.
5. Set the printing options you want and then click **Print**.

**To print a calendar appointment**

1. Click **Start > Calendar** and then select the appointment whose details you want to print.
2. Follow steps 2 through 5 in the "To print contact information" procedure.

**To print a message**

1. Click **Start > Messaging** and then select the messaging account where the message you want to print is located.
2. Select the message you want to print.
3. Follow steps 2 through 5 in the "To print contact information" procedure.

**To print a JPEG file**

1. In **Pictures & Videos**, select the JPEG file and then click **Menu > Print via Bluetooth**.
2. Follow steps 3 through 5 in the "To print contact information" procedure.

## 8.6 Windows Live™

**Windows Live™** gives you full Internet experience on your phone. It helps you to find information, pursue your interests, and get in touch with friends and family on the Internet easier.

Windows Live offers the following key features:

- **Live Search Bar**, which lets you search for information on the Web.
- **Live Messenger**, the next generation of MSN Messenger Mobile.
- **Live Mail**, the next generation of Hotmail.
- **Live Search**, which lets you find locations, browse maps, and check for directions.
- **Live Contacts**, address book for storing Live Mail, Live Messaging, and Hotmail contacts.

### Set up Windows Live

The first time you use Windows Live, sign in by using your Windows Live ID, which is your Windows Live Mail or Hotmail address, and password.

#### To set up Windows Live for the first time

1. Click **Start > Windows Live**.
2. Click **Sign in to Windows Live**.
3. On the next screen, click the links to read the Windows Live Term of Use and the Microsoft Privacy Statement. After reviewing it, click **Accept**.
4. Enter your Windows Live Mail or Hotmail address and password, then click **Next**.

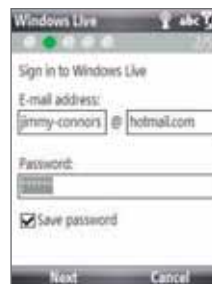

5. Choose whether or not to show Windows Live's search bar and applications on the Home screen then click **Next**.
6. Choose what information you want to synchronize online with your phone.

If you select **Store Windows Live contacts in your mobile phone's contact list**, your online contacts will be added to the contact list and to Windows Live Messenger Mobile on your phone.

If you select **Sync e-mail**, your Windows Live Mail or Hotmail inbox messages will be downloaded to your phone.

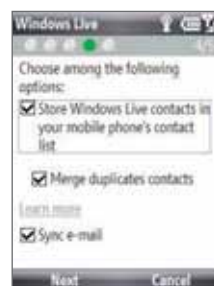

7. Click **Next**.
8. After synchronization is complete, click **Done**.

### The Windows Live interface

On the main interface of Windows Live, you will see a search bar, navigation bar, and an area where you can customize to show your picture.

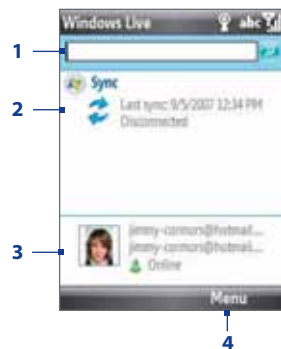

- 1 Windows Live Search bar.
- 2 Press NAVIGATION left or right to switch among Live Mail, Messenger, and Sync status. Click to open/activate the selected Windows Live component.
- 3 Click to access Windows Live Messenger settings.
- 4 Click **Menu** to access and change settings.

## 132 Getting Connected

If you chose to display the search bar and Windows Live applications on the Home screen when you were setting up Windows Live, you will see them on the Home screen:

Search bar and  
Windows Live applications



To show or hide them, open Windows Live and click **Menu > Options > Home screen options**.

## 8.7 Windows Live Messenger

**Live Messenger** lets you send and receive instant messages online. With this mobile version of Windows Live Messenger, you enjoy many of the same cool features that you get from the desktop version, which include the following:

- Instant messaging via text and voice
- Multiple conversations
- Add emoticons
- Contact list with presence
- Send and receive files including photos
- Change status/display name
- View contacts by online status, groups, and more
- Send messages even when a contact is offline

**Note** Before you can use Live Messenger, your phone must be connected to the Internet. For information about setting up an Internet connection, see "Ways of Connecting to the Internet" in this chapter.

## Launch the messenger and sign in

### To open Live Messenger

Do one of the following:

- On the Home screen, click **Start > Messenger**.
- On Windows Live of the Home screen, press NAVIGATION left or right until you see **Messenger**, then press CENTER OK.

### To sign in and out

1. To sign in, click **Sign in** on the messenger screen.
2. If this is your first time to sign in, a message appears to inform you that your messenger contacts will be added to the contact list on your phone. Click **OK** to add them.

Signing in may take several minutes, depending on your connection speed.

3. To sign out, click **Menu > Sign Out**. Your status changes to **Offline**.

## Add Windows Live contacts

You can add new Windows Live contacts in Live Messenger or in Contacts.

### To add a Windows Live contact in Live Messenger

1. Click **Menu > Add new contact**.
2. Enter the e-mail address of the contact then click **OK**.

### To add a Windows Live contact in Contacts

1. On the Home screen, click **Start > Contacts**.
2. Click **New** then click **Windows Live**.
3. In the **IM** box, enter the e-mail address of the contact, which can be a Windows Live ID or any other e-mail address.
4. Click **Done**.
5. Follow the remaining instructions to add the new contact to your Windows Live contact list.

**Tip** You can fill in other information about the contact, if desired. This is not absolutely necessary if you intend to communicate with the contact only through Windows Live Messenger or Live Mail.

**To delete a contact**

1. In the messenger, select the contact and click **Menu > Contact options > Remove contact**.
2. Choose whether to block the contact.
3. Choose whether to delete the contact from your phone's contact list.
4. Click **OK**.

**Send instant messages**

You can send instant messages with emoticons, and even talk by sending a voice clip. While chatting, you can send and receive files directly on a message window. You can also start conversations with several contacts and switch between their message screens, or you can invite participants to join in a conversation.

**To start and end conversations**

1. In the contact list, select a contact then click **Send IM** to open a message screen.
2. Send an instant message. See "To send an instant message with emoticon" for details.
3. To start a conversation with another contact, press NAVIGATION left or right to go back to the contact list, then select another contact and click **Send IM** again. Another message screen opens.
4. To switch from one message screen to another, press NAVIGATION left or right to the display picture of the contact whom you want to talk to.



Pictures of contacts with whom you're talking to

5. To end a conversation with the current contact, click **Menu > End conversation**.
6. To end all active conversations, click **Menu > End all conversations**.

#### To send an instant message with emoticon

1. Select a contact and start a conversation.
2. Enter your text message in the text entry area of the message screen.
3. To add an emoticon, click **Menu > Add emoticon** then select an icon from the list of emoticons.
4. Click **Send**.

- Tips**
- To send a file, click **Menu > Send**. You can choose to send a picture, voice clip or any file.
  - To invite one or more contacts to the conversation, click **Menu > Options > Add participant**.

#### To send a voice message

1. Select a contact and start a conversation.
2. Click **Voice clip** then start talking.
3. After you have spoken a message, click **Send**.

#### Personalize the messenger

While on the contacts list, you can do the following:

- Click **Menu > Change status** to set your current status (such as Busy, Out to lunch, etc.) so that your contacts know whether you are available or not.
- Click **Menu > Change appearance** to change your display name, add a personal message, and add your picture.
- Click **Menu > Sort by** to organize contacts by online status, groups, name, or e-mail address. You can also hide offline contacts from the contact list.
- Click **Options** to see more settings.

136 Getting Connected



# Chapter 9

## Experiencing Multimedia

**9.1 Camera**

**9.2 Pictures & Videos**

**9.3 Windows Media Player Mobile**

**9.4 Streaming Media**

**9.5 Audio Manager**

**9.6 MP3 Trimmer**

**9.7 Using Audio Booster**

**9.8 Flash Lite Player**

**9.9 Java**



## 9.1 Camera

Taking photos and shooting video clips are easy with your phone's built-in camera.

Your phone has two built-in cameras:

- **Main camera:** A rear 2 megapixel camera for capturing high resolution pictures and video clips with audio.
- **Second camera:** A front camera for video calls and self-portrait shooting.

### To open Camera

Do any of the following:

- Press the CAMERA button on the right side of the phone.
- On the Home screen, click **Start > Camera** or **Video Recorder**.

### To exit Camera

- Press END (  ).

**Note** Pressing END (  ) simply "minimizes" the Camera program, it is still running in the background. To close the Camera program, go to Task Manager.

### Install the storage card

If you have a microSD card inserted, or if you insert a microSD card while you are using the camera, you will be prompted to choose whether to save your pictures on the microSD card or the phone. Select the location for storing pictures and videos taken with the camera and click **OK**. Select the **Don't show again** check box to prevent this message from appearing the next time you insert a storage card.

### Take a photo or capture a video clip

Aim the camera at the subject and then press CENTER OK to take the shot. When capturing video, press CENTER OK to start recording; press it again to stop.







## Capture modes

### To change the capture mode

- On the Camera screen, press NAVIGATION right or left to change the capture mode.

The Camera program lets you capture pictures and video clips by using various built-in modes. The title bar displays the active capture mode.

The available capture modes are as follows:

Icon	Capture mode	Function
	<b>Photo</b>	Captures standard still images.
	<b>Video</b>	Captures video clips, with or without audio.
	<b>MMS Video</b>	Captures video clips suitable for sending via MMS.
	<b>Contacts Picture</b>	Captures a still image suitable for assigning as an identification photo to a contact.
	<b>Picture Theme</b>	Captures still images and places them within frames.
	<b>Panorama</b>	Captures a sequence of still images continuously in one direction, and stitches the images together to create a panoramic view of a scenery.
	<b>Sports</b>	Captures a sequence of still images (3 or 5 frames) automatically for a short duration at a defined frequency.

Using the above capture modes, the camera captures files in the following formats:

Capture type	Format
Still Image	JPEG
Video / MMS Video	MPEG-4 (.mp4) H.263 baseline (.3gp)

### Camera mode icons and indicators

**Note** The camera icons and indicators disappear after a few seconds if there is no user interaction. Press the NAVIGATION CONTROL's direction keys, the Keypad's keys, or the left/right SOFT KEYS to redisplay the icons indicators.

#### The Camera [Photo] screen



- 1 Indicates the current capture mode.
- 2 Depending on the capture mode, this shows the remaining, available shots of pictures that you can take or remaining duration that can be recorded. While recording video, this shows the recorded duration.
- 3 Indicates the current zoom ratio. Use NAVIGATION up or down to increase or decrease the zoom level.
- 4 Click to open the Camera settings menu.
- 5 Click to view the picture or video in Pictures & Videos.

#### The Camera [Video] screen



- 6 The Recording Status indicator **REC** blinks while video recording is in progress.

**The Camera [Picture Theme] screen**

- 7 Displays the current and total number of photos that can be taken using the selected template.



**Use zooming**



Before capturing a still image or a video clip, you can first zoom in to make the object in focus move closer, and you can zoom out to make the object move farther away. In all capture modes, press NAVIGATION up on your phone to zoom in, NAVIGATION down to zoom out.

The camera zoom range for a picture or video depends on the capture mode and capture size. Also, please note the capture sizes available for certain capture formats also vary from one capture mode to another.

**The Review screen**

After capturing a photo or video, you will be presented with options that you can do with the captured media file.

Icon	Function
	Click to go back to Camera screen.
	Click to delete the captured image or video clip.
	Click to send the captured image or video clip to someone via e-mail or MMS.

Icon	Function
	Click to switch to Pictures & Videos to show the still image, or switch to Windows Media Player to play back the video clip.
	(For Contacts Picture mode only) Click to associate the photo to a selected contact.

**Note** After you have taken photos in **Sports** mode, the total number of consecutive shots is shown at the lower right corner of the Review screen. Press NAVIGATION up or down to browse through the sequence of photos.

## Customize Camera settings

### Quick Settings Menu

Click  on the Camera screen to open the Quick Settings Menu where you can activate self-timer, change the ambience, customize capture settings, and more.

Use the NAVIGATION CONTROL to go through the available settings.

The following provides a list of the general options in the menu.

- **Self-timer.** Select the Self-timer option for capturing images: **Off**, **2 seconds**, or **10 seconds**. Selecting **2 seconds** or **10 seconds** delays the capturing by the specified time after you press CENTER OK.
- **Brightness.** Adjust the brightness from **-2** to **+2** (increments of 0.5).
- **Camera.** Choose whether to use the Main camera or the Second camera when taking pictures or shooting videos. There are three modes you can choose from:

**Main Camera** : 2 megapixel camera at the back panel of the phone, is used for taking standard pictures and videos.

**Second Camera** : Camera at the upper right corner of the front panel of the phone, used for shooting self-portrait pictures and videos.

**Main Camera (Flip)** : Used for taking self-portrait pictures and videos without mirroring. If there is text on your self-portrait shot (for example, if you're wearing a shirt with text), the text appears inverted on the captured image/video in Second Camera mode. Use Second Camera (Flip) mode to invert your self-portrait so that the text is readable on the captured image/video.

- **Resolution.** Choose the resolution to use. The resolution options depend upon which camera mode you are using.
- **White Balance.** Specify the white balance setting such as Auto (☀️), Daylight (🌞), Night (🌙), Incandescent (💡), and Fluorescent (💡) to suit the lighting environment.
- **Template** (Picture Theme mode only). Allows you to toggle between one of five templates to use for Picture Theme mode.
- **Settings.** Access more advanced settings that lets you customize the Camera or Video Recorder functions. You can customize settings, such as the capture format, camera shutter sound, flicker adjustment, recording limit, and more. Refer to the next two sections for details.

### Capture Settings

On the Quick Settings Menu screen, click  and select the **Capture Settings** tab. The following describes each option.

Option	Allows you to
<b>Effect</b>	Choose a special effect such as Grayscale, Sepia, Cool, or Negative to apply to your photos or video clips. <b>Note:</b> White Balance cannot be applied if an Effect has already been applied.
<b>Quality</b>	Select the JPEG image quality level for all captured still images. You can choose from Basic, Normal, Fine, and Super Fine. This option is available in all modes except Video and MMS Video.
<b>Metering Mode</b>	Select a metering mode to allow the camera to measure the amount of light in the center and around the image and calculate the best-fit exposure value before capturing. Choose either <b>Center Area</b> to measure light using the center area of the image or <b>Average</b> to measure light using the area all around the image.
<b>Time Stamp</b>	(Photo and Sports modes only) Choose whether or not to include the shooting date and time on captured photos.
<b>Storage</b>	Select where you want to save your files. You can either save the files to the main memory or to a storage card.
<b>Capture Speed</b>	(Sports mode only) This determines the interval between shots. <b>Fast</b> captures consecutive shots at the shortest interval.

Option	Allows you to
<b>Snapshots</b>	(Sports mode only) Select the number of consecutive shots to capture.
<b>Template</b>	(Picture Theme mode only) Enables you to select one of five Templates.
<b>Direction</b>	(Panorama mode only) Choose in what direction images will be stitched in a panorama.
<b>Stitch Count</b>	(Panorama mode only) Select the desired number of snapshots to be taken and stitched into a panorama.

### Advanced settings

On the Quick Settings Menu screen, click  and select the **Advanced** tab. The following describes each option.

Option	Allows you to
<b>Capture Format</b>	Select the desired file format, JPEG (still picture) or MPEG4/HT63 (video).
<b>Shutter Sound</b>	Choose whether or not you want the camera to make a shutter sound when you take photos or record video clips.
<b>Keep Backlight</b>	Choose whether to turn the backlight on or off while using the camera. This overrides your phone backlight settings while you are using the camera.
<b>Review Duration</b>	Set a time length for displaying the captured image or video on the Review screen before automatically saving it and returning to the live Camera screen. Select <b>No Limit</b> to allow the picture to be displayed until you choose to take another action. Select <b>No Review</b> to immediately return to the live Camera screen after capturing.
<b>Record with Audio</b>	Select <b>On</b> to record audio while capturing video clips. This is selected <b>On</b> by default. If you select <b>Off</b> and then capture a video clip, it will have no audio.
<b>Flicker Adjustment</b>	When taking indoor shots, flicker on the camera screen may be caused by interference from fluorescent lighting. To reduce flicker, change the flicker adjustment setting to <b>Auto</b> or to the proper frequency ( <b>50Hz</b> or <b>60Hz</b> ) of the country where your phone is being used.



Option	Allows you to
<b>Prefix</b>	<p>Enables you to set a prefix to image or video filenames. When Default is selected as the prefix, the filename of each new captured file is set to "IMAGE" or "VIDEO" followed by a sequential number, for example: IMAGE_001.jpg. You may also choose to prefix filenames using either the current <b>Date</b> or <b>Date &amp; Time</b>.</p> <p><b>Note:</b> If you set the Camera to save captured photos to a storage card, the prefix cannot be selected. Captured photos will be named using the DCIM (Digital Camera Images) naming standard.</p>
<b>Counter</b>	Select <b>Reset</b> to reset the naming counter to 1.
<b>Template Folder</b>	(Picture Theme mode only). By default, templates are stored in the \My Documents\Templates folder on the phone's main memory. If you transferred some templates to a storage card (using File Explorer), set this option to <b>Main + Card</b> to specify that templates are located in both the main memory and the storage card.
<b>Show Reminder</b>	(Contacts Picture mode only) Select <b>On</b> to be prompted to set the picture to a contact after taking a contact picture. Select <b>Off</b> to disable the prompt.
<b>Recording Limit</b>	Specify the maximum time or file size for recording video clips.
<b>Image Properties</b>	This option allows you to adjust the camera display properties, such as <b>Contrast</b> , <b>Saturation</b> , <b>Hue</b> , and <b>Sharpness</b> . Adjust each item with the NAVIGATION right and left buttons. Switch between items with the NAVIGATION up and down buttons. Click <b>OK</b> when you are finished.
<b>About</b>	Displays the Camera's firmware information.

## 9.2 Pictures & Videos

The Pictures & Videos program allows you to view and manage media files on your phone.

### To copy a picture or video clip to your phone

You can copy pictures and video files from your PC to the My Pictures folder on your phone, and then view them on your phone.

For more information about copying files from your PC to your phone, see Windows Mobile Device Center or ActiveSync Help on your PC.

**Note** You can also copy pictures and video files from your PC to your phone using a memory card. Insert the memory card into the memory card slot on your phone, and then copy them from your PC to the folder you created on the memory card.

### To view media files

1. On the Home screen, click **Start > Pictures & Videos**.
2. Select a media file and click **View** or **Play** (if video file) to view or play back the file.



This icon  indicates that the file is a GIF animation file. Click **View** to play back the file.

This icon  indicates that the file is a video file. Click **Play** to playback the file in Windows Media Player Mobile.

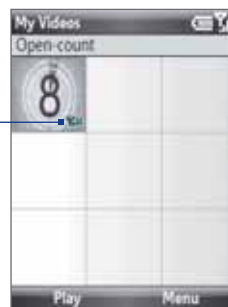

**Note** If you cannot find the media file in the default My Pictures folder, click **Menu** > **Folders** > **My Device** to go to other folders.

### Pictures & Videos menu

Select a media file onscreen and click **Menu** to open a list of options that you can do with the selected media file.

You can choose to send the selected media file via one of your messaging accounts, beam it to another device, play the pictures as a slide show, send the picture to your Windows Live MySpace account, and more.

Click **Options** to customize picture settings and slide show playback preferences.

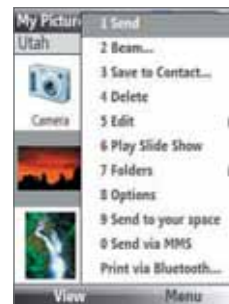

**Note** The available menu options depend on the selected media file.

When viewing a picture file, click **Menu** > **Use as Home Screen** to set the picture as your Home Screen background. You can also do minor touch ups to the picture such as rotate and crop by clicking **Menu** > **Edit**.

### 9.3 Windows Media Player Mobile

You can use Microsoft® Windows Media® Player Mobile for Smartphone to play digital audio and video files that are stored on your phone or on a network, such as on a Web site.

To open Windows Media Player Mobile, click **Start > Windows Media**.



#### About the controls

By default, these hardware buttons are assigned to Windows Media Player Mobile functions.

**Tip** To change the assigned hardware buttons, on the Playback screen, click **Menu > Options > Buttons**.

To	Press
Play or pause	CENTER OK
Skip to a previous file	NAVIGATION left
Skip to the next file	NAVIGATION right
Increase the volume	NAVIGATION up
Decrease the volume	NAVIGATION down
Turn the sound on or off quickly (mute)	#
Switch to full screen during video playback	0
Change rating	*
Fast-forward a file	NAVIGATION right (hold)
Rewind a file	NAVIGATION left (hold)

### About the screens and menus

Windows Media Player Mobile has three primary screens:



#### Playback screen

The default screen that displays the playback controls and the video window.

#### Now Playing screen

This special playlist indicates the current file being played and files that are queued up to play next.

#### Library screen

The screen that lets you quickly find your audio files, video files, and playlists.

Click **Menu** to open a list of options that you can do in a particular screen. The commands on this menu vary, depending upon which screen you are viewing.

### About licenses and protected files

Some media files have associated licenses that protect them from being unlawfully distributed or shared.

If you want to copy a protected file from your PC to your phone, use the Windows Media Player on your PC to synchronize the file to your phone. This will ensure that the license is copied along with the protected file. For more information about synchronizing files to your phone and other mobile devices, see the Windows Media Player Help.

**Note** You can view the protection status for a file by checking its file properties (**Menu > Properties**).

### Copy files to your phone

Use the **Sync** feature in Windows Media Player on your PC to synchronize (copy) digital media files from your PC to your phone. Using **Sync** ensures that protected files and album art (for skins) are copied to your phone correctly.

#### To synchronize content to your phone automatically

1. On your PC, start Windows Media Player and then connect your phone to your PC.
2. In the Device Setup Wizard, type a name for the phone and click **Finish**.
3. On the leftmost pane, right-click your phone and select **Set Up Sync**.
4. On the Device Setup dialog box, select the **Sync this device automatically** and then select the playlist(s) that you want to sync between the PC and your phone.
5. Click **Finish**.

**Note** You can also sync your storage card if you have one installed on your phone. To sync, right-click **Storage Card**.

The files begin synchronizing to your phone. The next time you connect your phone to your PC while Windows Media Player is running, synchronization will start automatically.

#### To synchronize and copy content manually to your phone

1. If you have not set up synchronization between your phone and PC, follow steps 1 to 3 in "To synchronize content to your phone automatically."
2. Click the **Sync** tab on the Windows Media Player. Select a Playlist or a Library on the left panel of the Windows Media Player.
3. From the content list, drag files you want to sync to your phone to the right panel of the Windows Media Player.
4. Click **Start Sync** to start copying files to your phone.

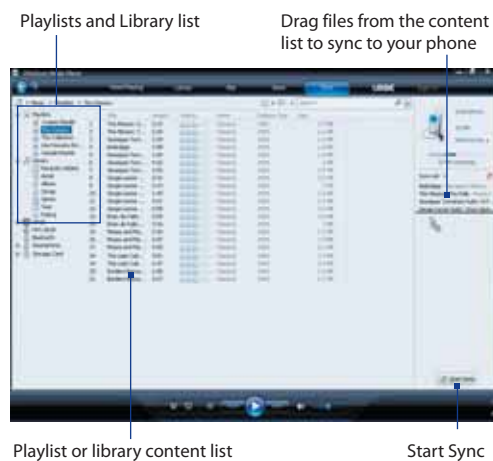

- Notes**
- Always use Windows Media Player 11 on your PC to synchronize (copy) files to your phone.
  - Audio files copy faster if Windows Media Player is configured to automatically set the quality level for audio files copied to your phone. For more information, see the Windows Media Player Help.

## Play media

### To play media on your phone

Use the library to find and play songs, videos, and playlists that are stored on your phone or storage card.

1. If you are not on the Library screen, click **Menu > Library**.
2. If necessary, on the Library screen, click **Menu > Library**, and then select the library that you want to use.
3. In most cases, Windows Media Player Mobile automatically updates the library. However, you can manually update the library to ensure that it contains new files that you recently copied to your phone or storage card. Click **Menu > Update Library** to manually update the library list.

4. Select a category (for example, **My Music** or **My Playlists**), select the item that you want to play (such as a song, album, or artist name), and then click **Play**.

**Note** To play a file that is stored on your phone but is not in a library, on the Library screen, click **Menu** > **Open File**. Select the item that you want to play (such as a file or a folder), and click **Play**.

### Troubleshooting

For more information, see the Troubleshooting Windows Media Player Mobile page at the Microsoft Web site (<http://www.microsoft.com/windows/windowsmedia/player/windowsmobile/troubleshooting.aspx>).

## 9.4 Streaming Media

The Streaming Media program allows you to stream live broadcasts or on-demand media content from the Web. You do not have to wait until the entire media content is completely downloaded before watching the video or hearing the sound. The media is sent in a continuous stream to your phone and is played as it arrives, along with the audio.



1. **Stop.** Press NAVIGATION left to stop playback.
2. **Play/Pause.** Press CENTER OK to play/pause playback.
3. **Volume.** Press NAVIGATION up/down to increase/decrease volume. Press NAVIGATION right to mute/unmute the audio.



The Streaming Media program allows you to play 3GP and MPEG-4 files. It also supports playback of SDP (Session Description Protocol) files. An SDP file is a text file that contains the format, broadcast times, media content, and other information about a live broadcast, or it may contain a playlist and links to prerecorded media files if you are viewing on-demand streaming media.

#### To access streaming content via Internet Explorer

In Internet Explorer, you can open a Web page containing http links to streaming media content and play the content in the Streaming Media program.

1. On the Home screen, click **Start > Internet Explorer**.
2. Click **Menu > Address Bar**. In the address bar, enter the URL address of the Web page that contains the http link to the desired **\*.3gp**, **\*.mp4**, or **\*.sdp** file.
3. On the Web page, select the RTSP link and press CENTER OK.
4. Streaming Media then automatically opens and starts playing the file. During playback, use the button controls to play/pause the video and adjust the sound volume.

**Tip** Click **Menu > Zoom > Zoom In** to zoom in on the video.

#### To stream media files directly on the Streaming Media Player

Streaming Media only supports RTSP links when you stream **\*.3gp** and **\*.mp4** files directly on the program.

**Note** Before you launch the Streaming Media program, make sure that you are connected to the Internet.

1. On the Home screen, click **Start > Streaming Media**.
2. From the program, click **Connect**.
3. Enter the URL for the Web site (rtsp://) and the file name.
4. Click **Go**.
5. Streaming Media then starts playing the file. During playback, use the button controls to play/pause and adjust the sound volume.

#### To view streaming video file information

You can view the properties and general information of a streaming video clip, such as file format, audio codec, dimension, frames, and duration of the video.

- Click **Menu > Properties** from the program.

#### To configure streaming video connection settings

Click **Menu > Options** to configure the following settings:

- **Connect via.** Choose whether you want to connect to the Internet or corporate network (intranet) to locate a streaming video clip.
- **UDP port range.** Specify a range of port numbers to use for streaming.
- **Media buffer.** Specify the memory space (in terms of duration) to allot for storing video and audio data while streaming media.

## 9.5 Audio Manager

Audio Manager is a music browser and player in one. It gives you access to all the music files on your phone, and allows you to easily browse for the music that you want to play by organizing music into categories.

#### To open Audio Manager

- Click **Start > Audio Manager**.

- Notes**
- Audio Manager searches for all music files stored on your phone memory and storage card that have the following audio formats: MP3, WMA, AAC, and AAC+.
  - Music files are categorized under **Artists, Album, Genre**, etc. if such metadata are found in the files.

## Library

On the Audio Manager's **Library** screen, an arrow that appears in an item indicates that there is a submenu available. Use the NAVIGATION CONTROL to go through the items and press CENTER OK to open the submenu.

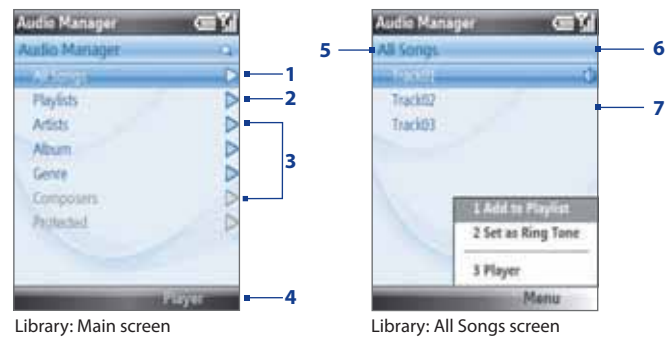

Library: Main screen

Library: All Songs screen

No.	Description
1	Open the <b>All Songs</b> submenu where you can browse music files by file name or song title.
2	Open the <b>Playlists</b> submenu where you can create playlists and play them back.
3	Open a submenu where you can browse music files by the selected category.
4	Switch to the Music Player screen. (Music Player does not automatically start playback. Press CENTER OK to start playback.)
5	Shows the current submenu name.
6	Shows a <b>Search</b> icon when the music database in Audio Manager is being updated. This occurs when music files have been added, renamed, or removed on the phone memory or storage card.
7	Shows the song titles or file names of music files when you are in the <b>All Songs</b> submenu. Use the NAVIGATION CONTROL to select a music file and play it in the Music Player. Shows more submenus when you are in one of the category screens, such as <b>Artists</b> , <b>Album</b> , etc. Press CENTER OK to open a submenu.

**Tip** Press NAVIGATION left or the BACK key (←) to go back to the upper-level menu.

When you press CENTER OK on a category on the Library's Main screen, you will see more submenus which may have deeper levels of menus. For example, when you select **Artists**, another level of submenu will be listed showing artist names. Just keep opening the submenus until you reach the level where song titles can be selected for playback.

Music files that are protected by Digital Rights Management (DRM) will be listed under the **Protected** category. A lock icon shown before song titles indicates that the music files are protected. A cross-marked lock icon shown before song titles indicates that the rights for the music files have expired, and you will not be able to play them.





**Note** When you exit Audio Manager and open it again, it will display the last submenu that you were in. Press NAVIGATION left until you reach the Library's Main screen.

### Music Player

Music Player is integrated with Audio Manager, and lets you play back music files. After selecting a song in the Library, Music Player opens and automatically plays it.

**Note** If the last screen you were in was the Music Player when you closed Audio Manager, next time you launch Audio Manager, it will open Music Player directly. To switch back to the Library, click **Library**.



Control	Does this
Press CENTER OK	Play/Pause the song.
	Shows the playback time. Click <b>Menu &gt; Time Display</b> to choose the display format for the playback time ( <b>Elapsed</b> time or <b>Remaining</b> time).
Press and hold <b>1</b>	Move backward in a song.
Press and hold <b>3</b>	Move forward in a song.
Press NAVIGATION left/right	Go to the previous/next song.
Press <b>8</b>	 Mute/Unmute.
Press NAVIGATION up/down	 Increase/Decrease the volume.
Press <b>4</b>	 Shuffle songs during playback.
Press <b>7</b>	 Loop songs during playback.
<b>Library</b>	Return to the Library screen.
<b>Menu</b>	Open a menu where you can choose to add the current song to a playlist, set the playback mode, set the song as ring tone, and more.

## Playlists

A playlist is a list of music files that play in a sequential order. The Playlists screen shows the current playlists that are found on the phone memory and storage card.

There are two types of playlists that will be shown on the Playlist screen:

- **Windows Media Player playlists.** These are playlists that are in Windows Media Player Mobile's Library (which is synchronized with Windows Media Player on your computer), and they are indicated by the Windows Media Player icon (). They can be played in Audio Manager's Music Player but cannot be edited.
- **Custom playlists.** These are playlists that are created in Audio Manager and can be edited.

- Notes**
- Audio Manager searches for playlists in the following locations:  
**Phone:** \Playlists\Application Data\HTC\AudioManager\playlists  
**Storage card:** \Storage Card\Playlist
  - If a Windows Media Player playlist contains a combination of music, video and image files, Audio Manager accesses the music files only and filters out the other media types.

#### To create a playlist

1. On the Library's Main screen, select **Playlists** and press CENTER OK.
2. On the Playlists screen, click **Menu > New**.
3. Enter a **Playlist name** then click **OK**.
4. On the Playlists screen, select the playlist you have just created and then click **Edit**.
5. Click **Menu > Add**.
6. Select the songs you want to add to the playlist by pressing CENTER OK, or click **Menu > Select All** to choose all the songs.
7. Click **OK** thrice to return to the Playlists screen.

#### Set music as ring tone

Audio Manager allows you to select your favorite music and set it as a ring tone for your phone.

1. Use the NAVIGATION CONTROL to select a song in the Library, or select a song to play it in Music Player.
2. Click **Menu > Set as Ring Tone**.
3. Select **Set as Default Ring Tone** and press CENTER OK.
4. A confirmation message is then displayed. Click **OK**.

**Note** If the selected song is in MP3 format, you can trim it first to make it shorter. Click **Trim** to open the MP3 Trimmer and trim the song. For more information about trimming, see "MP3 Trimmer."

**Tip** If you only want to save the song to the ring tone folder for future use, select **Save to Ring Tone Folder**. Later on, you can click **Start > Settings > Sounds** to set it as your ring tone.

## 9.6 MP3 Trimmer

Use MP3 Trimmer to trim MP3 files. You can choose to save it as a new file or set it as a ring tone.

### To open MP3 Trimmer

- Click **Start > MP3 Trimmer**.



This control	Does this
<b>1 Title</b>	Shows the name for the song.
<b>2 Duration</b>	Shows the length of the song after trimming.
<b>3 Time</b>	Shows the playback time when the song is played.
<b>4 Play/Stop</b>	Press CENTER OK to toggle between playing and stopping playback.
<b>5 Mark in/Mark out</b>	Allows precise marking of the start and end times of the song that will be used for the file.
<b>6 Mark in/Mark out points</b>	Shows the current mark in (start) and mark out (end) points of the song. The song will be trimmed based on these points.
<b>7 OK</b>	Click to confirm trimming the file.
<b>8 Cancel</b>	Click to exit MP3 Trimmer without trimming the file.

**To trim the MP3 file**

1. In the Trim screen, use the NAVIGATION CONTROL to select **Mark in**.
2. Use NAVIGATION left/right to set the Mark in point. After you set the Mark in point, the song will play back starting from the Mark in point. Use NAVIGATION left/right to adjust the Mark in point if needed.



3. Use the NAVIGATION CONTROL to select **Mark out** and then use NAVIGATION left/right to set the Mark out point. After you set the Mark out point, the song will play back starting from 5 seconds before the Mark out point. Use NAVIGATION left/right to adjust the Mark out point if needed.



4. Use the NAVIGATION CONTROL to select **Play**. Press CENTER OK to play back the trimmed song. While playing, you can use NAVIGATION left/right to go backward or forward through a song.
5. Click **Menu** and select to whether set the file as the default ring tone, save the file to the ring tone folder, or save it using another file name.

## 9.7 Using Audio Booster

Audio Booster enhances your music experience by providing you with controls for adjusting sound settings when listening to music. You can add and adjust 3D sound, treble and bass effects. Audio Booster even has an equalizer with presets as well as a control panel for fine tuning sound.

**To open Audio Booster**

- Click **Start > Audio Booster**.



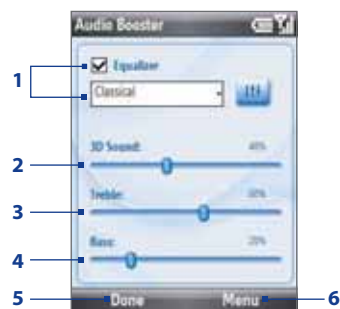

This control	Does this
1 <b>Equalizer</b>	Enables or disables the equalizer. Select the check box to enable the equalizer and to fine tune its settings, if desired. See "Equalizer" for more information.
2 <b>3D Sound</b>	Adds a three-dimensional effect to sound. Click the slider and use NAVIGATION right or left to increase or decrease the effect. To disable the 3D effect, adjust the setting to 0%.
3 <b>Treble</b>	Adds a treble effect to increase the high tones in sound. Click the slider and use NAVIGATION right or left to increase or decrease the effect. To disable the treble effect, adjust the setting to 0%.
4 <b>Bass</b>	Adds a bass effect to increase the low tones in sound. Click the slider and use NAVIGATION right or left to increase or decrease the effect. To disable the bass effect, adjust the setting to 0%.
5 <b>Done</b>	Click to apply the modified settings.
6 <b>Menu</b>	<ul style="list-style-type: none"> <li>Click <b>Menu &gt; Cancel</b> to exit Audio Booster without applying the modified settings:</li> <li>Click <b>Menu &gt; Reset</b> to change back to the default settings.</li> </ul>

## Equalizer

The Equalizer optimizes sound for a better listening experience. It provides preset moods, such as hip hop, jazz, rock, etc., and several enhancement presets that suit different types of music. It also has a 10-band graphic equalizer that lets you adjust the loudness of sound by frequency.

### To apply a preset

1. Select the Equalizer check box to enable the equalizer.
2. Select a desired preset from the dropdown menu.



### To create a custom equalizer preset

1. Select the **Equalizer** check box to enable the equalizer.
2. Click .
3. Adjust the frequency bands to your desired values by clicking a slider and using NAVIGATION up and down to drag the equalizer controls. The selected values are indicated on top of the sliders.
4. Save your equalizer settings as a preset by clicking **Menu > Save as Preset**.
5. Enter a preset name then click **Done**. The preset is added to the list box.



### To delete a custom equalizer preset

1. Select the **Equalizer** check box then click .
2. Click the list box then select the preset you want to delete.
3. Click **Menu > Delete Preset**.

**Note** You can only delete custom equalizer presets. Equalizer presets that are preinstalled cannot be deleted.

## 9.8 Flash Lite Player

**Flash Lite Player** lets you play back Flash Lite™ animation files, games, and other types of Flash Lite files on your device.



**Note** Flash Lite Player only supports playback of Flash Lite (not Flash) files.

### To open a Flash Lite File

1. On the Home screen, click **Start > Flash Lite Player**.
2. Click **Open** and locate the Flash Lite file you want to open.
3. Click the file to open it.

### To open a recently played back file

On the Flash Lite Player screen, click **Menu > Recent Files**. Select the file you want to open and click **Open**.

### To adjust the playback resolution

On the Flash Lite Player screen, click **Menu > Quality** and then select a quality setting.

### To view a file in full screen

Depending on the file, Flash Lite Player may expand the file to fill the whole screen or hide the title and bottom bars.

- On the Flash Lite Player screen, click **Menu > Full Screen**.

**Note** When in full screen mode, you can revert to normal view mode by pressing the right SOFT KEY and then clicking **Full Screen** on the shortcut menu.

## 9.9 Java

MIDlets are Java™-based applications that can run on mobile phones. Your phone supports Java 2 Edition, J2ME™. Java allows you to download Java-based applications, such as games and tools that are specifically designed for mobile phones. Java gives you the flexibility of installing and managing additional J2ME applications from the Internet.

### Install and run MIDlets/MIDlet suite

#### To install MIDlets from the Internet

1. On the Home screen, click **Start > Java**.
2. Click **Menu > Install > Browser** to open Internet Explorer Mobile.
3. Locate the MIDlet/MIDlet suite while connected to the Internet.
4. Select the MIDlet/MIDlet suite to download.
5. To start installing the MIDlet/MIDlet suite, click **Yes**.
6. Click **Done** to confirm the installation.

- Notes**
- You can cancel the installation at any time.
  - Downloaded MIDlets will be automatically saved in the My Documents folder.

#### To install MIDlets from a PC

You can install the MIDlets/MIDlet suites on your phone from a PC using the USB sync cable, or Bluetooth. MIDlets copied to your phone using Bluetooth or email attachments are automatically saved in the My Documents folder.

#### To install MIDlets from a local folder

1. On the Home screen, click **Start > Java**.
2. Click **Menu > Install > Local Files** to install the MIDlets currently saved in the My MIDlets folder.
3. Select the MIDlet/MIDlet suite from the list by using the NAVIGATION CONTROL.
4. Click **Install**.

You may be prompted to confirm installation of an untrusted MIDlet. Click **Yes** to install the MIDlet or **No** to cancel.

5. After selecting **Yes**, you are prompted to select a folder to install the MIDlet in.
6. Click **OK** to select the default folder or click **Menu > New Folder** to choose a different location.
7. The MIDlet/MIDlet suite is installed.

**To run MIDlets/MIDlet suites on your phone**

1. On the Home screen, click **Start > Java**.
2. Select a MIDlet from the list using the NAVIGATION CONTROL.
3. Press CENTER OK or click **Launch** to run the MIDlet.

**Manage MIDlets/MIDlet suite**

You can organize the MIDlets/MIDlet suites into folders. You can also uninstall, move or rename MIDlets/MIDlet suites.

**To uninstall a MIDlet**

Before you uninstall a MIDlet/MIDlet suite, make sure that it is not running.

1. On the Java Apps screen, select the MIDlet/MIDlet suite using the NAVIGATION CONTROL.
2. Click **Menu > Actions > Uninstall**.
3. Click **OK** to confirm.

**Note** On the Java screen, click **Menu > Uninstall All** to uninstall all MIDlets.

**To update a MIDlet/MIDlet suite**

Java will search for updates for the selected MIDlet/MIDlet suite where it was installed from before.

1. On the Java Apps screen, select the MIDlet/MIDlet suite using the NAVIGATION CONTROL.
2. Click **Menu > Actions > Update**. Java then searches for updates.
3. Click **Yes** or **No** depending on the update scenario.

**To change the display name of a MIDlet or folder**

1. On the Java Apps screen, select the MIDlet/MIDlet suite using the NAVIGATION CONTROL.
2. Click **Menu > Actions > Rename**.
3. Enter a new name for the MIDlet then click **Save**.

**To move a MIDlet or folder to another location**

1. On the Java Apps screen, select the MIDlet/MIDlet suite using the NAVIGATION CONTROL.
2. Click **Menu > Actions > Move**.
3. Click the location where you want to move the MIDlet or folder to then click **OK**.

**Tip** Click **Menu > New Folder** to create a new folder.

**To view protection information of a MIDlet**

If the MIDlet/MIDlet suite is protected by DRM (Digital Rights Management), there are some restrictions on how you can use the MIDlet/MIDlet suite. DRM is a technology used by publishers to control access to digital data.

1. On the Java Apps screen, select the MIDlet/MIDlet suite using the NAVIGATION CONTROL.
2. Click **Menu > Actions > Protection**.
3. Choose the information you want to view and click **Select**.

# Chapter 10

## Using Other Applications

**10.1 Microsoft® Office Mobile**

**10.2 Microsoft® Office Word Mobile**

**10.3 Microsoft® Office Excel® Mobile**

**10.4 Microsoft® Office PowerPoint® Mobile**

**10.5 Adobe® Reader® LE**

**10.6 Speed Dial**

**10.7 Voice Speed Dial**

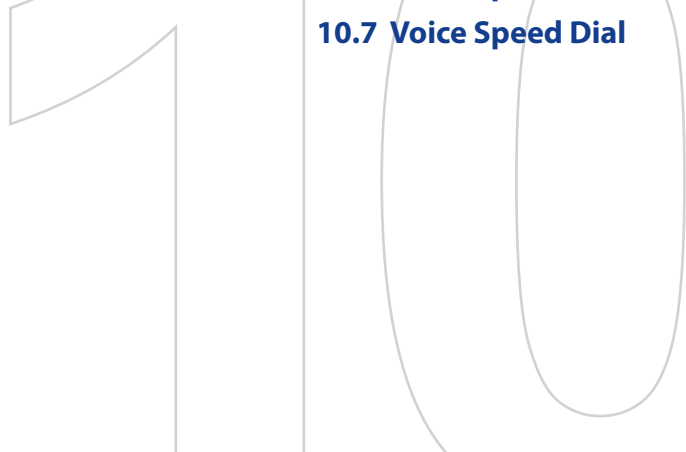

## 10.1 Microsoft® Office Mobile

**Microsoft® Office Mobile** consists of three applications that let you view and edit Microsoft documents. These three applications are:

- **Microsoft® Office Word Mobile** lets you view and edit Microsoft Word documents and text files.
- **Microsoft® Office Excel® Mobile** lets you view and edit Microsoft Excel worksheets.
- **Microsoft® Office PowerPoint® Mobile** lets you view Microsoft PowerPoint slides.

To learn how to copy files, see “Managing and Backing Up Files” in Chapter 4.

## 10.2 Microsoft® Office Word Mobile

Microsoft® Office Word Mobile gives you editing and viewing capabilities for your Word documents and text files.

### To open Word Mobile

- On the Home screen, click **Start > Office Mobile > Word Mobile**.

**Note** Word Mobile does not fully support some features of Microsoft Word. Some data and formatting may be lost when you save the document on your phone.

### View documents

#### To open a document

1. In Word Mobile, click **Menu** and choose the location where the **\*.doc**, **\*.rtf**, or **\*.txt** file is saved.
2. Locate the file you want to open and click **Select**.

**Note** You can only open one document at a time. You must close the opened document first before you can open another document.



#### To change the zoom ratio

Click **View** and then on the menu, select the zoom ratio to use.

Click **View > Wrap to Window** to adjust the text flow so that the text wraps based on the screen size. This way, you do not need to scroll right to read long paragraphs or sentences.

**Note** Text in tables cannot be wrapped.

#### To change scrolling preference

- Click **Menu > Scroll Up/Down** and then select **By Page** or **By Line**.

#### To find a word in a document

1. Click **Menu > Find**.
2. Type in the word you want to find in **Find What**. Select **Match case** and/or **Whole words** only if needed.
3. Click **Find**.

#### To close the document

- Click **Menu > Close File**.

#### Edit and send documents

In order to edit Word documents or text files, you need to switch to Edit mode. To switch to Edit mode, click **Menu > Edit**.

#### To type words into the document

1. In the document, use the NAVIGATION CONTROL to position the cursor where you want to insert the text.
2. Type in the text using the QWERTY keyboard.

- Tips**
- Click **Menu > Format** to change the font format. You can use **Bold**, **Italic**, **Underline**, and **Highlight**.
  - If you are using a formatting style and you want to revert to no formatting style, click **Menu > Format** and select the formatting style you are using from the menu.

**To save the document**

1. Click **Menu > File > Save As**.
2. Type in the **Name** you want to use for the edited document and select the **Location** where you want to save the document.
3. Click **Save**.

**To send the document through e-mail**

1. Click **Menu > File > Send**.
2. In the Messaging screen, select the e-mail account you want to use to send the document and click **Select**.
3. In the e-mail, the file is automatically appended as an attachment.
4. Enter the recipient name and click **Send**.

## 10.3 Microsoft® Office Excel® Mobile

Microsoft® Office Excel® Mobile gives you editing and viewing capabilities for your Excel worksheets.

**To open Excel Mobile**

- Click **Start > Office Mobile > Excel Mobile**.

**Note** Excel Mobile does not fully support some features such as Microsoft Excel. Some data and formatting may be lost when you save the workbook on your phone.

**View worksheets**

**To open a file**

1. In Excel Mobile, click **Menu** and choose the location where the **\*.xls** file is saved.
2. Locate the file you want to open and click **Select**.

**Note** You can only open one worksheet at a time. You must close the opened worksheet first before you can open another worksheet.

By default, the worksheet opens in Full Screen mode, to change the view mode, press the left SOFT KEY (to show the **View** menu) and click **View > Full Screen**.

#### To view the contents of a cell

There are times that the text in a cell cannot be fully displayed onscreen. To view the text in the cell in its entirety, select the cell and then click **View > Cell Text**.

#### To use Freeze Pane

1. Select the cell that is after and below the row and column you want to freeze.

For example, if you want to freeze **column E** and **row 4**, you should select cell **F5**.

2. Click **View > Freeze Panes**. To unfreeze the panes, click **View > Unfreeze Panes**.

#### To change the zoom ratio

- Click **View > Zoom** and then select the zoom ratio to use.

#### To switch to another worksheet

If your Excel file has multiple worksheets, you can go to a different worksheet by clicking **View > Sheet** and then select the worksheet you want to view.

#### Edit and send worksheets

In order to edit Excel worksheets, you need to switch to Edit mode. To switch to Edit mode, click **Menu > Edit**.

#### To edit the cell text

1. Select the cell whose text you want to edit and then press CENTER OK or click **Menu > Edit > Cell Text**.
2. Type in the text and click **Done**.

#### To delete the cell content

- Select the cell whose content you want to delete and click **Menu > Edit > Clear Cell**.

**Tip** You can select multiple cells by clicking **Menu > Select** and then choosing what to select in the worksheet.

#### To edit the cell range of a defined name

If your worksheet contains defined names created in Microsoft Excel on the PC, you can edit the cell range of the defined name.

1. Click **Menu > Edit > Define Name**.
2. In **Range Name**, select the name whose cell range you want to change.
3. In **Refers to**, type in the new cell range.
4. Click **Done**.

#### To delete cells

- Select the cell you want to delete and click **Menu > Edit > Delete Cells**.

**Tip** You can select multiple cells to delete by clicking **Menu > Select** and then choosing what to select in the worksheet.

#### To copy and paste cell contents

1. Select the cell(s) you want to copy and then click **Menu > Edit > Copy**.
2. Select the cell(s) where you want to copy the cell contents to and click **Menu > Edit > Paste**.

#### To insert a row or column

Select the cell where you want to insert a row or column and then click **Menu > Insert > Row** or **Column**. If you insert a row, the row will be inserted above the selected cell; if you insert a column, the column will be inserted at the left of the selected cell.

**Tip** You can also shift the contents of a row or column. To shift, select the cell you want to shift and click **Menu > Insert > Shift Right** or **Shift Down**.

#### To go to a cell

- Click **Menu > Tools > Go To** and then enter the Cell reference or name. Click **OK**.

**Tip** You can also sort and find text in the worksheet by clicking **Menu > Tools > Sort** or **Find**.

**To undo and redo an action**

- Click **Menu > Undo [Action]** or **Redo [Action]**.

**To save the worksheet**

1. Click **Menu > File > Save As**.
2. Type in the **Name** you want to use for the edited worksheet and select the **Location** where you want to save the worksheet.
3. Click **Save**.

**To send the document through e-mail**

1. Click **Menu > File > Send**.
2. In the Messaging screen, select the e-mail account you want to use to send the worksheet.
3. In the e-mail, the file is automatically appended as an attachment.
4. Enter the recipient name and click **Send**.

## 10.4 Microsoft® Office PowerPoint® Mobile

Microsoft® Office PowerPoint® Mobile gives viewing capabilities for your PowerPoint presentations.

**To open PowerPoint Mobile**

- Click **Start > Office Mobile > PowerPoint Mobile**.

**To open a file**

1. In PowerPoint Mobile, click **Menu** and choose the location where the \*.ppt file is saved.
2. Locate the file you want to open and click **Select**.

**To go through the slides of the presentation**

Press NAVIGATION right to go forward in the presentation; press NAVIGATION left to go back to the previous action or slide of the presentation.

You can also go to a particular slide in your presentation by pressing the right SOFT KEY (to show the **Menu**) and clicking **Menu > Go to Slide** then choosing the slide to go to.

## 174 Using Other Applications

### To view a custom show

You can view custom shows that you created on Microsoft PowerPoint on your phone.

1. Press the right SOFT KEY to show **Menu**.
2. Click **Menu > Custom Show** and then select the custom show you want to view on the list.

### To set PowerPoint Mobile preferences

1. Press the right SOFT KEY to show **Menu**.
2. Click **Menu > Options**.
3. Set the **Orientation** and **Playback options** and click **Done**.

### To show links in a slide

On your phone, you can show and activate hyperlinks in slides that you created on Microsoft PowerPoint.

1. Press the right SOFT KEY to show **Menu**.
2. Click **Menu > Show Links**.
3. Press CENTER OK to activate the hyperlink. If there is more than one hyperlink on the slide, use NAVIGATION CONTROL to select the hyperlink you want to activate.

### To end the presentation

- Press the left/right SOFT KEY (to show **End**) and then click **End**.

## 10.5 Adobe® Reader® LE

**Adobe® Reader® LE** lets you view Portable Document Format (PDF) files.

When you open a password-protected PDF file, you will be prompted to enter the password before the file can be opened.

### To open a PDF file on your phone

1. Click **Start > Adobe Reader LE**.
2. Click **Open**.
3. Browse to a folder and click the PDF file you want to open.

**Note** To open another PDF file, click **Open > Menu > Browse For File**. You can also open a PDF file from File Explorer by clicking it.

### To navigate through a PDF file

You can do any of the following:

- Use the **NAVIGATION CONTROL** to scroll through the pages.
- Click **Menu > Go To** and select an option to go to a specific page in the PDF file.

While reading a PDF file, click **Menu** to open a list of options that lets you zoom in, directly go to a bookmark, find text in the file, and more.



## 10.6 Speed Dial

You can create speed dial entries for frequently-called numbers or frequently-accessed items so you can dial a number or access an item by pressing a single key.

### To create a speed dial entry for a contact

1. On the Home screen, click **Start > Contacts**.
2. Select a contact.
3. Press CENTER OK to view the contact details.
4. Select the desired phone number and click **Menu > Add to Speed Dial**.
5. Enter appropriate details in **Name**, **Value**, and **Keypad assignment**.
6. Click **Done**. To quit at any time during this process, click **Menu > Cancel**.

### To create a speed dial entry for an item

1. On the Home screen, click **Start** then choose (just highlight) the item you want.
2. Click **Menu > Add Speed Dial**.
3. Enter details in **Name**, **Value**, and **Keypad assignment**.
4. Click **Done**. To quit at any time during this process, click **Menu > Cancel**.

**Note** The first speed dial location is generally reserved for your voicemail. Speed Dial uses the next available location by default. If you want to place a number in a location that is already used, the new number replaces the existing number.

### To retrieve a voicemail message

- On the Home screen, press and hold **1** to access your voice mailbox, and follow the prompts to retrieve your messages.



**To make a call or launch a program using Speed Dial**

- If you have assigned a speed dial (for example, the second location) to a contact or a program in Speed Dial, you can simply press and hold the 2 key on the phone keypad to dial the contact's number or open the program.

**To delete a speed dial entry**

1. On the Home screen, click **Start > Speed Dial**.
2. Select the desired entry and click **Menu > Delete**.

## 10.7 Voice Speed Dial

You can record a voice tag for a phone number, e-mail address, or Web page address that is stored on your phone. Then, when you say the voice tag using Voice Speed Dial, your phone automatically dials the associated phone number, opens an e-mail message using the associated address, or goes to the associated Web page.

**To create a voice tag for a phone number, e-mail address, or URL in Contacts**

1. On the Home screen, click **Start > Contacts**.
2. Select the desired contact, and press CENTER OK to open the contact card.
3. Select the item to which you want to assign a voice tag.
4. Click **Menu > Add Voice Tag**.
5. After a "beep" sound, begin recording the voice tag (preferably one easy-to-recognize word).
6. When the voice tag is successfully trained, the phone will play back the voice tag. Click **OK**.
7. Enter appropriate details in **Name**, **Value**, and **Keypad assignment**.
8. Click **Done** to save the new voice tag. To quit at any time during this process, click **Menu > Cancel**.

**To create a voice tag for a program**

To create a voice tag for a program, for example, Camera, do the following:

1. On the Home screen, click **Start > Camera**. (Do not press CENTER OK when Camera is selected.)
2. Click **Menu > Add Voice Tag**.
3. After the message/beep, say "Camera."
4. When the voice tag is successfully trained, the phone will play back the voice tag. Click **OK**.
5. Enter appropriate details in **Name**, **Value**, and **Keypad assignment**. Click **Done** to save the new voice tag. To quit at any time during this process, click **Menu > Cancel**.

**To make a call or launch a program using the voice tag**

1. Press and hold the **Volume Up** button (Voice Tag) on the left side of the phone.
2. After a "beep" sound, say the recorded voice tag that you have assigned to the phone number you want to call or the program you want to launch. The phone plays back the voice tag and then dials the number or launches the associated program.

**Tip** If the phone cannot recognize your voice tag, please try again and speak clearly and reduce the surrounding noise.

**To delete and play voice tags**

1. On the Home screen, click **Start > Speed Dial**.
2. Click the desired voice tag from the list.
3. Do any of the following:
  - To play back an existing voice tag at any time, click **Menu > Play Voice Tag**.
  - To delete the voice tag, click **Menu > Delete Voice Tag**.

# Appendix

**A.1 Regulatory Notices**

**A.2 Specifications**

## A.1 Regulatory Notices

### Regulatory Agency Identifications

For regulatory identification purposes, your product is assigned a model number of WING200.

To ensure continued reliable and safe operation of your device, use only the accessories listed below with your WING200.

The Battery Pack has been assigned a model number of LIBR160 & WING160.

This product is intended for use with a certified Class 2 Limited Power Source, rated 5 Volts DC, maximum 1 Amp power supply unit.

### European Union Notice

Products with CE marking comply with the R&TTE Directive (99/5/EC), the EMC Directive (89/336/EEC), and the Low Voltage Directive (73/23/EEC) issued by the Commission of the European Community.

Compliance with these directives implies conformity to the following European Norms (in parentheses are the equivalent international standards).

- **EN 60950-1 (IEC 60950-1)**  
Safety of Information Technology Equipment.
- **ETSI EN 301 511**  
Global system for mobile communications (GSM); Harmonized EN for mobile stations in the GSM 900 and GSM 1800 bands, covering essential requirements of article 3.2 of the R&TTE directive (1995/5/EC).
- **ETSI EN 301 489-1**  
Electromagnetic compatibility and Radio spectrum Matters (ERM); ElectroMagnetic Compatibility (EMC) standard for radio equipment and services; Part 1: Common technical requirements.
- **ETSI EN 301 489-7**  
Electromagnetic compatibility and Radio spectrum Matters (ERM); ElectroMagnetic Compatibility (EMC) standard for radio equipment and services; Part 7: Specific conditions for mobile and portable radio and ancillary equipment of digital cellular radio telecommunications systems (GSM and DCS).

- **ETSI EN 301 489-17**  
Electromagnetic compatibility and Radio spectrum Matters (ERM); ElectroMagnetic Compatibility (EMC) standard for radio equipment and services; Part 17: Specific conditions for 2.4 GHz wideband transmission systems and 5 GHz high performance RLAN equipment.
- **EN 301 489-24**  
Electromagnetic compatibility and radio spectrum matters (ERM); Electromagnetic compatibility (EMC) standard for radio equipment and services; Part 24: Specific conditions for IMT-2000 CDMA direct spread (UTRA) for mobile and portable (UE) radio and ancillary equipment.
- **EN 301 908**  
Electromagnetic compatibility and radio spectrum matters (ERM); Base stations (BS) and user equipment (UE) for IMT-2000 third generation cellular networks.
- **ETSI EN 300 328**  
Electromagnetic compatibility and Radio spectrum Matters (ERM); Wideband Transmission systems; data transmission equipment operating in the 2.4 GHz ISM band and using spread spectrum modulation techniques.
- **EN 50360:2001**  
Product standard to demonstrate the compliance of mobile phones with the basic restrictions related to human exposure to electromagnetic fields (300 MHz - 3 GHz).
- **EN 50371:2002**  
Generic standard to demonstrate the compliance of low power electronic and electrical apparatus with the basic restrictions related to human exposure to electromagnetic fields (10 MHz - 300 GHz)  
- General public.



This equipment may be operated in:							
AT	BE	BG	CH	CY	CZ	DE	DK
EE	ES	FI	FR	GB	GR	HU	IE
IT	IS	LI	LT	LU	LV	MT	NL
NO	PL	PT	RO	SE	SI	SK	TR

### Federal Communications Commission Notice

This device complies with part 15 of the FCC Rules. Operation is subject to the following two conditions: (1) This device may not cause harmful interference, and (2) this device must accept any interference received, including interference that may cause undesired operation.

This equipment has been tested and found to comply with the limits for a Class B digital device, pursuant to Part 15 of the FCC Rules. These limits are designed to provide reasonable protection against harmful interference in a residential installation. This equipment generates, uses, and can radiate radio frequency energy and, if not installed and used in accordance with the instructions, may cause harmful interference to radio communications. However, there is no guarantee that interference will not occur in a particular installation. If this equipment does cause harmful interference to radio or TV reception, which can be determined by turning the equipment on and off, the user is encouraged to try to correct the interference by one or more of the following measures:

- Reorient or relocate the receiving antenna.
- Increase the separation between the equipment and receiver.
- Connect the equipment into an outlet on a circuit different from that to which the receiver is connected.
- Consult the dealer or an experienced radio or television technician for help.

### Modifications

The FCC requires the user to be notified that any changes or modifications made to the device that are not expressly approved by High Tech Computer Corporation may void the user's authority to operate the equipment.

**Safety precautions for RF exposure**

- Use only original manufacturer-approved accessories, or accessories that do not contain any metal.
- Use of non-original manufacturer-approved accessories may violate your local RF exposure guidelines and should be avoided.

**Exposure to Radio Frequency (RF) Signals**

Your device contains a radio transmitter and receiver. The radiated output power is far below the international radio frequency exposure limits. These limits are part of comprehensive guidelines and establish permitted levels of RF energy for the general population. The guidelines are based on the safety standards previously set by international standards bodies:

- American National Standards Institute (ANSI) IEEE. C95.1-1992
- National Council on Radiation Protection and Measurement (NCRP). Report 86. 1986
- International Commission on Non-Ionizing Radiation Protection (ICNIRP) 1996
- Ministry of Health (Canada), Safety Code 6. The standards include a substantial safety margin designed to assure the safety of all persons, regardless of age and health.

The exposure standard for wireless mobile phones employs a unit of measurement known as the Specific Absorption Rate, or SAR. The standard incorporates a substantial margin of safety to give additional protection for the public and to account for any variations in usage.

As with other mobile radio transmitting equipment, users are advised that for satisfactory operation of the equipment and for the safety of personnel, it is recommended that no part of the human body be allowed to come too close to the antenna during operation of the equipment.

Your device has an internal antenna. Use only the supplied integral antenna. Use of unauthorized or modified antennas may impair call quality and damage the phone, causing loss of performance and SAR levels exceeding the recommended limits as well as result in non-compliance with local regulatory requirements in your country.

To assure optimal phone performance and ensure human exposure to RF energy is within the guidelines set forth in the relevant standards; always use your device only in its normal-use position. Do not touch or hold the antenna area unnecessarily when placing or receiving a phone call. Contact with the antenna area may impair call quality and cause your device to operate at a higher power level than needed. Avoiding contact with the antenna area when the phone is IN USE optimizes the antenna performance and the battery life.

Tests for SAR are conducted using standard operating positions specified by the FCC with the phone transmitting at its highest certified power level in all tested frequency bands. Although the SAR is determined at the highest certified power level, the actual SAR level of the phone while operation can be well below the maximum value. This is because the phone is designed to operate at multiple power levels so as to use only the power required to reach the network. In general, the closer you are to a wireless base station antenna, the lower the power output. Before a phone model is available for sale to the public, it must be tested and certified to the FCC that it does not exceed the limit established by the government-adopted requirement for safe exposure. The tests are performed in positions and locations (for example, at the ear and worn on the body) as required by the FCC for each model. For body worn operation, this phone has been tested and meets FCC RF exposure guidelines when used with an accessory that contains no metal and that positions the handset a minimum of 1.5 cm from the body. When carrying the phone while it is on, use only the original manufacturer approved accessories. Use of other accessories may not ensure compliance with FCC RF exposure guidelines.

### **SAR Information**

- FCC: 1.06 W/kg @1g (Head)  
1.58 W/kg @1g (Body)
- CE: 0.823 W/kg @10g



## **Telecommunications & Internet Association (TIA) safety information**

### **Pacemakers**

The Health Industry Manufacturers Association recommends that a minimum separation of six inches be maintained between a handheld wireless phone and a pacemaker to avoid potential interference with the pacemaker. These recommendations are consistent with the independent research by and recommendations of Wireless Technology Research.

Persons with pacemakers:

- Should ALWAYS keep the phone more than six inches from their pacemaker when the phone is turned ON.
- Should not carry the phone in a breast pocket.
- Should use the ear opposite the pacemaker to minimize the potential for interference. If you have any reason to suspect that interference is taking place, turn your phone OFF immediately.

### **Hearing Aids**

Some digital wireless phones may interfere with some hearing aids. In the event of such interference, you may want to consult your service provider, or call the customer service line to discuss alternatives.

### **Other Medical Devices**

If you use any other personal medical device, consult the manufacturer of your device to determine if they are adequately shielded from external RF energy. Your physician may be able to assist you in obtaining this information.

Turn your phone OFF in health care facilities when any regulations posted in these areas instruct you to do so. Hospitals or health care facilities may be using equipment that could be sensitive to external RF energy.

### **Other tips and cautions**

- Avoid using your phone near metal structures (for example, the steel frame of a building).
- Avoid using your phone near strong electromagnetic sources, such as microwave ovens, sound speakers, TV and radio.
- Avoid using your phone after a dramatic change in temperature.

### **WEEE Notice**

The Directive on Waste Electrical and Electronic Equipment (WEEE), which entered into force as European law on 13th February 2003, resulted in a major change in the treatment of electrical equipment at end-of-life.

The purpose of this Directive is, as a first priority, the prevention of WEEE, and in addition, to promote the reuse, recycling and other forms of recovery of such wastes so as to reduce disposal.

The WEEE logo on the product or on its box indicates that this product must not be disposed of or dumped with your other household waste. You are liable to dispose of all your electronic or electrical waste equipment by relocating over to the specified collection point for recycling of such hazardous waste. Isolated collection and proper recovery of your electronic and electrical waste equipment at the time of disposal will allow us to help conserving natural resources. Moreover, proper recycling of the electronic and electrical waste equipment will ensure safety of human health and environment. For more information about electronic and electrical waste equipment disposal, recovery, and collection points, please contact your local city centre, household waste disposal service, shop from where you purchased the equipment, or manufacturer of the equipment.



### **RoHS Compliance**

This product is in compliance with Directive 2002/95/EC of the European Parliament and of the Council of 27 January 2003, on the restriction of the use of certain hazardous substances in electrical and electronic equipment (RoHS) and its amendments.

## A.2 Specifications

System information	
<b>Processor/Chipset</b>	• Qualcomm® MSM 7200 400MHz
<b>Memory</b>	<ul style="list-style-type: none"> <li>• ROM-Nand Flash: 256 MB</li> <li>• RAM: 64 MB SDRAM</li> </ul> <p>Figures are the total ROM and RAM memory available for use and storage. Since the memory is shared by the Operating System, applications, and data, the actual available memory is less than what is written.</p>
<b>Operating system</b>	Microsoft® Windows Mobile® 6 Standard
Display	
<b>Type</b>	2.4" Transmissive LCD with white LED back light
<b>Resolution</b>	320 x 240 dots resolution at 65K Colors (Landscape view)
<b>Orientation</b>	Portrait and Landscape (Keyboard open)
HSDPA/UMTS/GSM/GPRS/EDGE Module	
<b>HSDPA/UMTS</b>	2100MHz
<b>GSM/GPRS/EDGE</b>	Tri-band (850, 1900, & 2100)
Camera module	
<b>Type</b>	Main camera: 2 Megapixels CMOS Second camera: VGA camera
<b>Resolution</b>	UXGA: 1200 x 1600; SXGA: 960 x 1024; VGA: 480 x 640; QVGA: 240 x 320; QQVGA: 120 x 160
<b>Digital Zoom</b>	Up to 8X
Connection	
<b>I/O port</b>	HTC ExtUSB™: an 11-pin mini-USB and audio jack in one (ExtUSB is a proprietary connection interface that is trademarked by HTC)
<b>Bluetooth</b>	V 2.0 with EDR, Class 2 transmit power
<b>Wi-Fi</b>	IEEE 802.11b/g compliant, Internal WLAN antenna

Audio	
<b>Microphone/speaker</b>	Built-in microphone and loud speaker (for hands-free support)
<b>Headphone</b>	MP3/AAC/AAC+/WMA/WAV/AMR codec
Physical	
<b>Dimension</b>	105.8 mm(L) x 51 mm(W) x 19.4 mm(T)
<b>Weight</b>	150g with battery pack
Controls and lights	
<b>Navigation</b>	5-way Navigation Pad/CENTER OK button
<b>Buttons</b>	<ul style="list-style-type: none"> <li>• Power on/off</li> <li>• Left and Right Softkeys</li> <li>• Home screen</li> <li>• Back</li> <li>• Talk (start call/answer call)</li> <li>• End call/Lock keypad</li> <li>• 36 keys QWERTY keyboard</li> <li>• 12 buttons keypad</li> <li>• Volume buttons</li> <li>• Camera</li> <li>• Comm manager</li> </ul>
<b>Lights</b>	<ul style="list-style-type: none"> <li>• Event notification</li> <li>• Charge status</li> <li>• GSM/GPRS signals</li> <li>• Bluetooth/Wi-Fi connection</li> </ul>
Expansion slot	
<b>microSD slot</b>	microSD™ memory card (SD 2.0 compatible)
Power supply	
<b>Battery</b>	1050 mAh Li-Ion Polymer removable, rechargeable battery
<b>Talk time*</b>	Up to 318 minutes (GSM); up to 210 minutes (UMTS)
<b>Standby*</b>	Up to 290 hours (GSM); up to 388 hours (UMTS)
<b>AC adapter</b>	<ul style="list-style-type: none"> <li>• AC input/frequency: 100 ~ 240 AC, 50/60Hz</li> <li>• DC output: 5V and 1A</li> </ul>

\* Subject to network and phone usage.

# Index

## A

- Accessibility settings
  - confirmation time out 65
  - in-call alert volume 65
  - multipress time out 65
  - system font size 65
- ActiveSync 56
  - overview 31
  - synchronize 57, 103
- Add and remove programs 66
- Add attachment to message 95
- Adobe Reader 31, 175
- Alarm 64
- Alarm settings 63
- Alerts 63
- Answer/end call 47
- Attachments 96
- Audio Manager 31, 154

## B

- Back up files 68
- Battery
  - battery information 38
  - battery management 65
  - low battery 39
- Beam via Bluetooth 125
- Bluetooth
  - beaming 125
  - Bluetooth modem 127
  - hands-free headset 123
  - modes 121
  - overview 121
  - partnerships 122
  - stereo headset 123
  - synchronize 59
  - visible 121

- Bluetooth Explorer 31, 126
- Browsing the Web 119

## C

- Calculator 31
- Calendar 32, 78
- Call History 32
- Camera 138
  - icons and indicators 140
  - overview 32
  - zoom 141
- Camera settings 142
- Capture formats 139
- Capture modes 139
- Check battery power 39
- Clear Storage 31
- Close running programs 67
- Comm Manager 32, 114
- Company Directory 109
- Compose MMS message 89
- Compose text message 87
- Conference call 48
- Confirmation time out 65
- Connecting to Wi-Fi Network 115
- Connect phone to Internet
  - Dial-up 117
  - Wi-Fi 115
- Connect phone to private network 117
- Contacts 32, 74
  - Beam contact information 76
  - Call a contact 75
  - Create a new contact 74
  - Find a contact 75
  - Send contact information via a text message 76

- Send contact information via MMS 76
- View and edit a contact 75

Contacts picture (capture mode) 139

Copy

- contacts to SIM/USIM card 77
- files between phone and PC 68
- media files from PC to phone 150
- pictures and videos 146
- SIM contacts to phone 77
- sound file to phone 64

Currency setting 62

Customize Home screen 62

## D

Date setting 62

Device lock 71

Dial-up connection 117

Digitally sign messages 111

Digital Rights Management (DRM) 149

Digital signature 111

Direct Push 103

## E

E-mail 95

- Outlook 92
- POP3/IMAP4 93
- security 110

Emergency call 49

Encrypt messages 111

Enter text and numbers 34

Error reporting 66

Event notification 63

Exchange Server 103

Exclude e-mail address when replying to all 99

## F

Fetch Mail 105

File Explorer 32, 68

Filter e-mail 96

Find contacts online 109

Flag your messages 106

Flight mode 114

Font size (display) 65

Forward message 96

## G

Games 32

GPRS 116

## H

Home screen

- change background 62
- customize 62
- overview 24, 62

## I

IMAP4 93

In-call alert volume 65

Insert a long pause in dialing sequence 50

Insert pause in dialing sequence 50

Insert SIM/USIM Card 22

Install microSD Card 23

Install Microsoft ActiveSync 56

Install MIDlets

- from Internet 164
- from PC 164
- locally 164

International call 49

192 Index

Internet 115  
Internet Explorer Mobile 32, 119  
Internet Sharing 32, 120

## L

Language/locale setting 62  
LED indicator lights 20, 31  
Licensed and protected media 149  
Lock  
- keyboard 70  
- phone 71

## M

Make call  
- from Call History 44  
- from Contacts 44  
- from Home Screen 43  
- from Speed Dial 45  
Managing Meeting Requests 107  
Memory 67  
Messaging 32, 86  
Messenger 32  
microSD Card 23  
Microsoft ActiveSync 56  
Microsoft Windows Mobile Device  
Center 55  
MMS  
- access MMS 88  
- create and send 89  
- MMS settings 88  
MMS video (capture mode) 139  
Modem  
- Bluetooth modem 127  
- USB modem 120  
MP3 Trimmer 32, 159

Multipress mode 35  
Music Player 156  
Mute call 49

## N

Number format 62  
Numeric mode 36

## O

Operating system version 66  
Out-of-office 106  
Outlook e-mail 92  
Owner information 65

## P

Parts and accessories 16  
Pause in dialing sequence 50  
PDF 175  
Personal information 65  
Phone program 41  
Phone specification 66  
Photo (capture mode) 139  
Pictures & Videos 32, 146  
Picture theme (capture mode) 139  
PIN 42, 70  
Playlists (Audio Manager)  
157  
Play media 151  
POP3 93  
Power management 65  
Profile 63  
Programs 31  
- ActiveSync 31  
- Adobe Reader 31



- Audio Manager 31, 154
- Bluetooth Explorer 31
- Calculator 31
- Calendar 32, 78
- Call History 32
- Camera 32
- Clear Storage 31
- Comm Manager 32
- Contacts 32, 74
- File Explorer 68
- Games 32
- Internet Explorer 32
- Internet Sharing 32, 120
- Messaging 32, 86
- Messenger 32
- MP3 Trimmer 32
- Phone 41
- Pictures & Videos 32, 146
- Quick Notes 33
- SAPSettings 33
- SIM Manager 31, 77
- Speed Dial 33, 176
- Tasks 33, 81
- Task Manager 33, 67
- Video Recorder 33
- Voice Notes 33, 82
- Windows Live 33
- Windows Live Mobile 130
- Windows Media Player Mobile 33, 148

Put call on hold 48

## Q

- Quick List 34
- Quick Notes 33, 82
- QWERTY Keyboard 37

## R

- Receive
  - call 47
  - MMS message 90
- Regional settings 62
- Reply message 96, 99
- Reset phone 72
- Restart phone 71
- Review screen 141
- Ring tone 42, 83, 158

## S

- SAPSettings 33, 51
- Search for e-mails on the Exchange Server 105
- Secure/Multipurpose Internet Mail Extension (S/MIME) 110
- Securing Wi-Fi Connection 116
- Send
  - email/SMS message 95
  - MMS message 89
- Send and download e-mails 98
- Send appointments 80
- Send messages 95
- Settings 33
- Setting Up E-mail Accounts 92
- Set music as ring tone 158
- Set up ActiveSync on PC 56
- Set up Home screen 62
- SharePoint documents 107
- Share contact information 76
- SIM Access Profile (SAP) 51
- SIM Manager
  - copy contacts to SIM/USIM card 77
  - copy SIM contacts to phone 77

194 Index

- create SIM contact 77
  - Sounds 63
  - Speakerphone 49
  - Speed Dial 33, 45, 176
  - Sports (capture mode) 139
  - Start menu 30
  - Stop programs 67
  - Synchronize
    - ActiveSync 57
    - change information types 57
    - music and video 60
    - schedule synchronization with Exchange Server 103
    - via Bluetooth 59
    - Windows Media Player 60
  - System font size 65
- T**
- T9 mode 35
  - Tasks 33, 81
  - Task Manager 33, 67
  - Time setting 62
  - Turning On and Off the Phone 23
- V**
- Verify digital signature 111
  - Video (capture mode) 139
  - Video Call 45
  - Video Recorder 33
  - Viewing media files 146
  - View and reply to MMS messages 90
  - View your appointments 79
  - Visible (Bluetooth) 121
  - Voice Notes 33, 82

- Voice Tag 177
  - create voice tag for phone number, e-mail address, or URL in Contacts 177
  - create voice tag for program 178
  - edit, delete, and play voice tags 178

**W**

- Web browser 119
- Wi-Fi 115
- Windows Live 33
- Windows Live Messenger 132
- Windows Media Player
  - file formats 148
  - menus 149
  - overview 33
  - troubleshooting 152
- Windows Mobile Device Center 55
- Windows Mobile software version 66

**Z**

- Zoom 141