

# htc EVO™ 4G LTE

## User Guide



# Table of Contents

---

Get Started .....	1
Your Phone at a Glance .....	1
Charge Your Phone.....	3
Activate Your Phone.....	4
Complete the Setup Application.....	5
Set Up Voicemail.....	5
Sprint Account Information and Help .....	6
Sprint Account Passwords .....	6
Manage Your Account.....	7
Sprint Support Services .....	7
Phone Basics.....	9
Your Phone's Layout .....	10
Turn Your Phone On and Off.....	12
Turn Your Screen On and Off.....	13
Your Phone's Lock Screen .....	14
Unlock the Screen.....	14
Customize the Lock Screen .....	15
Touchscreen Navigation.....	15
Your Home Screen.....	18
Home Screen Basics .....	19
Extended Screens.....	20
Customize the Home Screen .....	21
Launch Bar, Apps, and Folders.....	22
Status and Notifications .....	24
Status Bar .....	24
Notifications Panel .....	27
Notification LED .....	27
Enter Text.....	28
HTC Sense Input Keyboard .....	28
Enter Text by Speaking.....	31

Swype Keyboard.....	31
Tips for Editing Text.....	33
Phone Calls .....	36
Make Phone Calls .....	36
Call Using the Phone Dialer .....	36
Call From Call History .....	37
Call From People .....	38
Call Using a Speed Dial Number.....	38
Call a Number in a Text Message or Email Message.....	38
Call Emergency Numbers .....	38
Receive Phone Calls .....	39
Visual Voicemail .....	40
Set Up Visual Voicemail.....	40
Review Visual Voicemail .....	41
Learn More About Visual Voicemail .....	41
Voicemail (Traditional).....	42
Set Up Voicemail .....	42
Voicemail Notification.....	42
Retrieve Your Voicemail Messages.....	43
Phone Call Options.....	43
Caller ID.....	43
Call Waiting.....	44
3-way Calling .....	44
Call Forwarding.....	44
In-call Options.....	45
Internet Calls .....	45
Add an Internet Calling Account.....	45
Make an Internet Call .....	46
Set Up Speed Dialing .....	46
Call History .....	46
View Call History.....	47
Save a Number From Call History.....	47
Prepend a Number From Call History .....	48

Erase Call History .....	48
Settings.....	49
Wireless & Networks Settings.....	49
Airplane Mode.....	50
Wi-Fi .....	50
Bluetooth.....	50
Mobile Network .....	50
More Wireless & Network Settings.....	50
Personalization Settings .....	51
Scene .....	51
Change the Home Screen Wallpaper.....	52
Change the Default Ringtone .....	52
Sound Set.....	52
Application Tabs .....	53
Change the Lock Screen Style.....	54
Accounts & Sync .....	54
Add Your Social Networks, Email Accounts, and More .....	54
Add One or More Google Accounts.....	55
Manage Your Online Accounts.....	55
Location & Security Settings.....	56
Location .....	56
Security-Screen Lock.....	57
Display Settings.....	58
Auto-rotate Screen.....	58
Animation.....	59
Text Size.....	59
Brightness.....	59
Screen Timeout.....	59
Keep the Screen On While Charging .....	59
Change the Wallpaper .....	60
Calibrate the Screen .....	60
Sound Settings.....	60
General Sound Settings.....	60

Incoming Calls .....	62
Notifications .....	62
System.....	62
Call Settings .....	63
Voicemail Settings .....	63
Other Call Settings.....	63
Internet Call Settings.....	64
Applications Settings .....	64
Allow Installation of Third-Party Programs.....	64
Clear Application Cache and Data .....	64
Select the App to Open Data Items .....	65
Stop Applications Using Task Manager.....	65
Storage Settings.....	65
Where Applications, Data, and Files are Stored.....	65
Encrypt Data on Your Phone.....	66
Reset Your Phone.....	66
Power & Data Management Settings.....	67
Adjust the Screen Brightness and Screen On-Time .....	67
Manage Your Phone’s Wireless Functions.....	68
Set the Email Synchronization Schedule.....	68
Close Applications Not In Use.....	68
Language & Keyboard Settings .....	69
Language Settings .....	69
Keyboard Settings.....	69
Date & Time Settings.....	69
Connect to PC Settings .....	69
System Updates .....	70
About Your Phone .....	70
People .....	71
Getting Contacts Into Your Phone .....	71
Transfer Contacts from Your Old Phone .....	72
Your People List.....	72
Your People App Profile .....	73

Set Up Your Profile .....	73
Your Profile .....	74
Add Entries to People App.....	74
Add a New People Entry .....	74
Find People You Know on Social Networks .....	75
Import or Copy Contacts .....	75
Merge Entries in People .....	76
Accept Contact Link Suggestions.....	76
Manually Merge Entries .....	76
Break the Link.....	77
Contact Information and Conversations.....	77
Manage People Entries .....	77
Edit a People Entry .....	78
Delete an Entry .....	78
Delete Multiple Entries .....	78
Contact Groups .....	78
Create a Group .....	78
Edit a Contact Group .....	79
Send a Message or Email to a Group .....	79
Rearrange Your Contact Groups.....	79
Delete Groups.....	80
Use People Widgets .....	80
Add a People Widget .....	80
Set the Default Communication Method.....	80
Get in Touch with a Contact.....	81
Send Contact Information.....	81
Back Up and Restore Your Contacts.....	81
Accounts and Messaging .....	83
Gmail.....	83
Create a Google Account.....	83
Sign In to Your Google Account .....	84
View Your Gmail Inbox.....	84
Send a New Gmail Message.....	85

Reply To or Forward an Email Message .....	86
Get Help with Gmail .....	86
Email .....	86
Add a POP3 or IMAP Email Account.....	87
Add an Exchange ActiveSync Account .....	87
Check Your Mail Inbox .....	88
Send an Email Message .....	89
Save an Email Message in Tasks .....	90
Print Your Email Messages .....	90
Search Email Messages .....	91
Work with Exchange ActiveSync Email .....	91
Manage Email Messages .....	93
Sync Email Less Frequently.....	93
Change the Email Account Settings .....	94
Delete an Email Account.....	95
Add the Mail Widget.....	95
Text Messaging and MMS .....	95
Send a Text Message (SMS) .....	96
Send a Multimedia Message (MMS) .....	97
Save and Resume Composing a Draft Message.....	99
Check Your Messages .....	99
Manage Message Conversations.....	101
Back Up and Restore Your Text Messages.....	102
Text and Multimedia Message Options .....	103
Add the Messages Widget .....	105
Social Networking Accounts .....	105
Facebook .....	106
Twitter for HTC Sense.....	106
Friend Stream .....	106
Google+ .....	109
YouTube .....	109
Google Talk .....	111
Applications and Entertainment.....	113

Google Play.....	113
Find and Install an Application .....	113
Uninstall an Application.....	114
Create a Google Wallet Account.....	114
Get Help with Google Play .....	114
Navigation .....	114
HTC Car .....	115
Google Maps .....	117
Google Latitude.....	121
Telenav GPS Navigation.....	121
Music.....	122
Browse for Music .....	122
Listen to Music.....	123
Make Your Music Sound Better.....	124
Find Music Videos on YouTube .....	124
Update Album Covers .....	124
Playlists .....	125
Music and Ringtones .....	126
Share Music Using Bluetooth.....	127
Use the Music Widget .....	127
FM Radio .....	127
Sprint TV & Movies.....	129
NASCAR Sprint Cup Mobile .....	130
HTC Watch.....	131
Create or Sign In to Your HTC Watch Account .....	132
Rent or Buy a Video with HTC Watch .....	132
Manage Your HTC Watch Downloads.....	132
Change the HTC Watch Settings .....	133
Check What's Linked to Your HTC Watch Account.....	133
Delete Your HTC Watch Account.....	133
HTC Watch FAQs .....	133
Web and Data.....	134
Data Services – Sprint 4G LTE and Sprint 3G Networks .....	134



Your User Name .....	135
Launch a Web Connection .....	135
Data Connection Status and Indicators .....	135
Turn the Data Connection On or Off.....	136
Switch to CDMA Mode to Save Battery Power .....	136
Enable Data Roaming .....	136
Data Services FAQs .....	136
Wi-Fi.....	138
Turn Wi-Fi On and Connect to a Wireless Network .....	138
Check the Wireless Network Status .....	138
Connect to a Different Wi-Fi Network .....	139
Add the Wi-Fi Widget .....	139
Virtual Private Networks (VPN).....	139
Add a VPN Connection .....	140
Connect to a VPN .....	140
Disconnect From a VPN.....	140
Browse the Web .....	140
Open the Browser .....	141
Private Browsing .....	142
Add and Manage Your Bookmarks.....	142
Save Web Content For Later.....	143
Browsing History .....	144
Download File and Apps from the Web .....	144
Set Browser Options .....	145
Copy Text, Look Up Information, and Share .....	146
Sprint Hotspot.....	148
Set Up Sprint Hotspot .....	148
Connect Your Computer to Sprint Hotspot .....	148
Manage Sprint Hotspot .....	149
Turn Off Sprint Hotspot .....	150
Add the Sprint Hotspot Widget .....	150
Connect to a Computer .....	150
Use Your Phone as a Modem .....	151

Connect Your Phone to the Internet Through a Computer (Internet Pass-through) .....	151
Camera and Video .....	152
Using the Camera .....	152
Launch the Camera .....	152
Take a Photo .....	154
Record a Video .....	154
Camera Scenes .....	155
Change Camera and Video Settings .....	156
Access Photos and Videos .....	157
View Photos and Videos .....	157
Start a Photo Slideshow .....	158
Watch Videos .....	158
Edit Your Photos and Videos .....	158
View Photos in Your Social Networks .....	161
Print Your Photos .....	161
Share Your Photos and Videos .....	162
Wireless Display .....	164
Movie Editor .....	165
Create a Slideshow with Movie Editor .....	166
Change the Soundtrack .....	166
Share Your Slideshow From Gallery .....	166
Tools and Calendar .....	168
Calendar .....	168
Create an Event .....	169
View the Calendar .....	169
Manage Calendar Events .....	170
Accept or Decline a Meeting Invitation .....	171
Set Reminders for Your Events .....	171
Event Alerts .....	172
Show or Hide Calendars and Tasks .....	172
Change Calendar Settings .....	172
About the Calendar Widget .....	172
Calculator .....	172

Clock & Alarm.....	173
HTC Clock Widget .....	173
Open the Clock Application .....	173
World Clock .....	174
Alarm Clock .....	174
Stocks .....	175
Weather.....	176
Tasks.....	177
Create a Task .....	178
Link a Task to a Contact .....	178
Link a Task to a Location .....	178
Manage Tasks .....	179
View the Unified Task List.....	179
Create a Task List.....	180
Manage Task Lists.....	180
Back Up or Restore Tasks .....	180
Change Tasks Settings .....	180
Online Storage .....	181
Dropbox .....	181
SkyDrive .....	185
HTC Sync Manager.....	187
Install HTC Sync Manager .....	188
Get Started with HTC Sync Manager .....	188
Import More Media to the Library .....	189
Add New Media to Your Library Automatically .....	190
Check for New Software Updates .....	190
HTC Sync Manager Supported File Formats.....	190
Play Music in HTC Sync Manager.....	191
Create a Playlist in HTC Sync Manager .....	191
View Photos and Videos in HTC Sync Manager.....	191
Set Up HTC Sync Manager to Recognize Your Phone.....	192
Set Up Your Phone to Sync with your Computer.....	193
Syncing Your Phone and Your Computer.....	195

Ripping Music from a CD with HTC Sync Manager .....	195
Voice Recorder.....	196
Record Your Voice .....	196
Set a Voice Clip as a Ringtone.....	196
Bluetooth and NFC .....	196
Turn Bluetooth On or Off.....	197
Change the Phone Name.....	197
Connect a Bluetooth Headset or Car Kit .....	197
Reconnect a Headset or Car Kit.....	198
Disconnect or Unpair From a Bluetooth Device.....	198
Send Information Using Bluetooth.....	199
Where Sent Information is Saved.....	200
Receive Information Using Bluetooth .....	200
Use Bluetooth FTP Server .....	201
Share Content with Android Beam .....	201
microSD Card.....	202
Insert the microSD Card.....	203
Remove the microSD Card .....	203
Check the microSD Card Memory.....	204
Erase the microSD Card .....	204
Unmount the microSD Card .....	204
Copy Files to or from the microSD Card.....	205
Update Your Phone .....	205
Update Your Phone Firmware.....	205
Update the Operating System.....	207
Update Your Profile.....	207
Update Your PRL.....	207
Index.....	208

# *Get Started*

---

This section gives you all the information you need to set up your phone and Sprint service the first time.

[Your Phone at a Glance](#)

[Charge Your Phone](#)

[Activate Your Phone](#)

[Complete the Setup Application](#)

[Set Up Voicemail](#)

[Sprint Account Information and Help](#)

## *Your Phone at a Glance*

The following illustrations outline your phone's primary external features, keys, and buttons.

Front panel

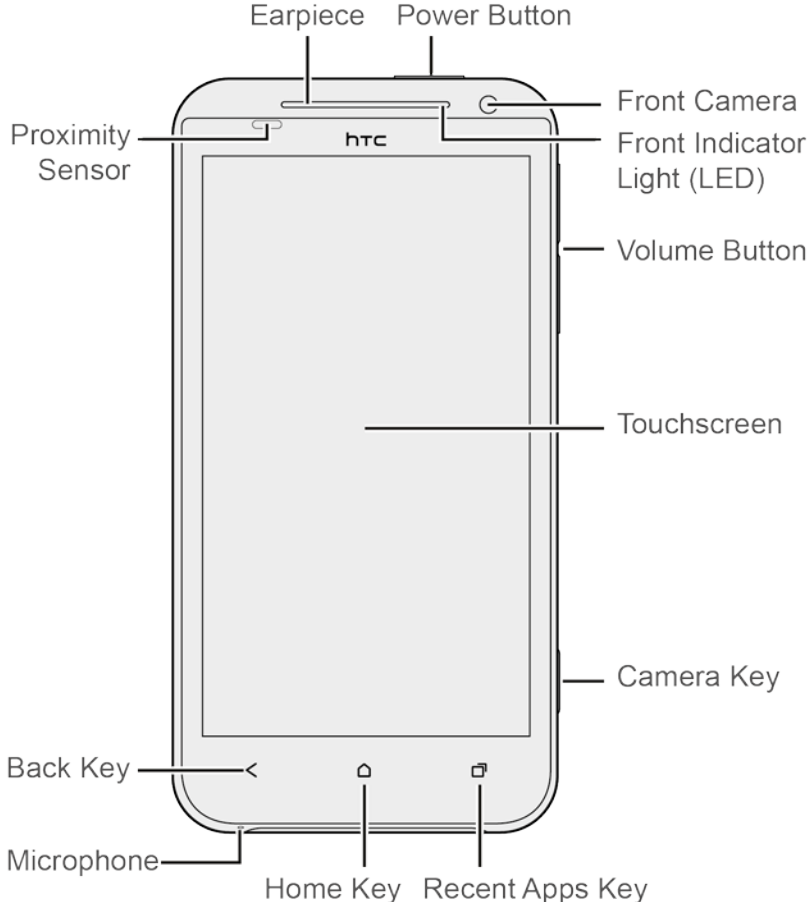

## Back panel

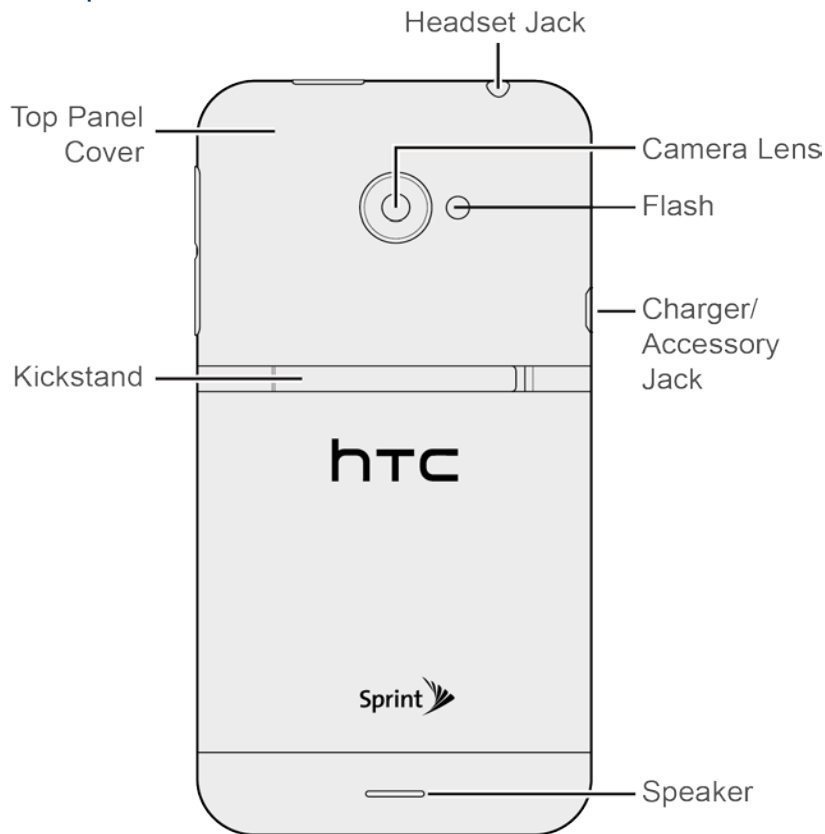

## FCC ID

Remove the back cover to check the phone's FCC ID.

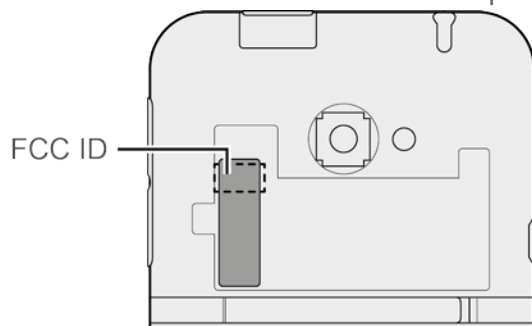

## Charge Your Phone

Your phone comes with a non-removable battery. You must first charge the battery to begin setting up your phone.

1. Plug one end of the USB cable to the AC adapter.

2. Plug the other end of the USB cable into the charger/accessory jack on the upper right side of your phone.



3. Plug the AC adapter into an electrical outlet. Fully charging a battery may take up to three hours.

**Note:** Your phone's battery should have enough charge for the phone to turn on and find a signal, run the setup application, set up voicemail, and make a call. You should fully charge the battery as soon as possible.

4. Press and hold  to turn the phone on.

If your phone is activated, it will turn on, search for service, and begin the setup application. If your phone is not yet activated, see [Activate Your Phone](#) for more information.

## Activate Your Phone

Depending on your account or how and where you purchased your phone, it may be ready to use or you may need to activate it on your Sprint account.

- If you purchased your phone at a Sprint Store, it is probably activated and ready to use.
- If you received your phone in the mail and it is for a new Sprint account or a new line of service, it is designed to activate automatically.
- When you turn the phone on for the first time, you should see a **Hands Free Activation** screen, which may be followed by a **PRL Update** screen and a **Firmware Update** screen. Follow the onscreen instructions to continue.
- If you received your phone in the mail and you are activating a new phone for an existing number on your account (you're swapping phones), you can activate on your computer online or directly on your phone.
  - **Activate on your computer:**
    - Go to [sprint.com/activate](http://sprint.com/activate) and complete the online instructions to activate your phone.
  - **Activate on your phone:**
    - Turn on your new phone. (Make sure the old one is turned off.) Your phone will automatically attempt Hands-Free Activation.
    - Touch **Activate** to override auto-activation and start the manual activation wizard.



- Follow the onscreen prompts to complete the activation process.
- To confirm activation, make a phone call. If your phone is still not activated or you do not have access to the Internet, contact Sprint Customer Service at **1-888-211-4727** for assistance.

**Tip:** Do not press  while the phone is being activated. Pressing  cancels the activation process.

**Note:** If you are having any difficulty with activation, contact Sprint Customer Service by calling 1-888-211-4727 from any other phone.

## Complete the Setup Application





Once your phone has been turned on and activated, you will then be guided to the setup process. Touch **Next** or **Skip** to skip any of the screens.

- **Scheduled sync.** Select manual or automatic synchronization of information. For more information, see [Accounts & Sync](#).
- **Set up Wi-Fi network.** Connect to a Wi-Fi network. For more information, see [Wi-Fi](#).
- **Get an HTC Account.** Create a new or sign in to your existing HTC Account. Sign in with your HTC Account to easily access HTC features, services, and content.
- **Tell HTC.** Choose whether to allow HTC to collect anonymous data in the background about how you use your phone.
- **Use Google location.** Turn on Google location services. For more information, see [Location](#).
- **Set up your Dropbox account.** Create a new or sign in to your Dropbox account and enjoy a free 25GB Dropbox space. See [Dropbox](#) for more information.
- **Set up accounts.** Set up your email and social network accounts including Google, Exchange ActiveSync, Mail, Dropbox, Evernote for HTC Sense, Facebook, Flickr, Microsoft Hotmail, SkyDrive for HTC Sense, and HTC Watch. For more information, see [Accounts & Sync](#).
- **Transfer my stuff.** Transfer information from your old phone. You can do this at a later time. For more information, see [Transfer Contacts from Your Old Phone](#).

**Note:** You do not need to sign up for a Google Account to use your phone. However, to download applications from Google Play or chat in Google Talk, you must link your phone to a Google Account.

## Set Up Voicemail

Your phone automatically transfers all unanswered calls to your voicemail, even if your phone is in use or turned off. You should set up your Sprint Voicemail and personal greeting as soon as your phone is activated. Always use a password to protect against unauthorized access.

1. Touch  > . (If your screen is locked, press  to turn on the display and then drag the ring up to unlock the screen.)
2. Touch and hold  to dial your voicemail number.
3. Follow the system prompts to:
  - Create your password.
  - Record your name announcement.
  - Record your greeting.

**Note:** **Voicemail Password** – Sprint strongly recommends that you create a password when setting up your voicemail to protect against unauthorized access. Without a password, anyone who has access to your phone is able to access your voicemail messages.

## *Sprint Account Information and Help*

Find out about account passwords and information about managing your account and finding help.

[Sprint Account Passwords](#)

[Manage Your Account](#)

[Sprint Support Services](#)

### *Sprint Account Passwords*

As a Sprint customer, you enjoy unlimited access to your personal account information, your voicemail account, and your data services account. To ensure that no one else has access to your information, you will need to create passwords to protect your privacy.

#### **Account User Name and Password**

If you are the account owner, you will create an account user name and password when you sign on to [sprint.com](#). (Click **Sign in/Sign up** and then click **Sign up now!** to get started.) If you are not the account owner (if someone else receives the bill for your Sprint service), you can get a sub-account password at [sprint.com](#).

#### **Voicemail Password**

You'll create your voicemail password when you set up your voicemail. See [Set Up Voicemail](#) for more information on your voicemail password.

#### **Data Services Password**

With your Sprint phone, you may elect to set up an optional data services password to control access and authorize Premium Service purchases.

For more information, or to change your passwords, sign on to [sprint.com](http://sprint.com) or call Sprint Customer Service at **1-888-211-4727**.











## *Manage Your Account*

Manage your Sprint account from your computer, your Sprint phone, or any other phone.

### **Online: [sprint.com](http://sprint.com)**

- Access your account information.
- Check your minutes used (depending on your Sprint service plan).
- View and pay your bill.
- Enroll in Sprint online billing and automatic payment.
- Purchase accessories.
- Shop for the latest Sprint phones.
- View available Sprint service plans and options.
- Learn more about data services and other products like games, ringtones, screen savers, and more.

### **From Your Sprint Phone**

1. Touch  > .
2. Do any of the following:
  - Touch    to check minute usage and account balance.
  - Touch    to make a payment.
  - Touch    to access a summary of your service plan or get answers to other questions.

### **From Any Other Phone**

- Sprint Customer Service: **1-888-211-4727**.
- Business Customer Service: **1-888-788-4727**.

## *Sprint Support Services*

Sprint 411 and Sprint Operator Services let you easily access information and calling assistance from your Sprint phone.

### **Sprint 411**





Sprint 411 gives you access to a variety of services and information, including residential, business, and government listings; movie listings or showtimes; driving directions, restaurant reservations, and major local event information. You can get up to three pieces of information per call, and the operator can automatically connect your call at no additional charge.

There is a per-call charge to use Sprint 411, and you will be billed for airtime.

- ▶ Touch  > , and then touch    .

## Sprint Operator Services

Sprint Operator Services provides assistance when you place collect calls or when you place calls billed to a local telephone calling card or third party.

- ▶ Touch  > , and then touch  .

For more information or to see the latest in products and services, visit us online at [sprint.com](http://sprint.com).

# *Phone Basics*

---

Your phone is packed with features that simplify your life and expand your ability to stay connected to the people and information that are important to you. The topics in this section will introduce the basic functions and features of your phone.

[Your Phone's Layout](#)

[Turn Your Phone On and Off](#)

[Turn Your Screen On and Off](#)

[Touchscreen Navigation](#)

[Your Home Screen](#)

[Status and Notifications](#)

[Enter Text](#)

# Your Phone's Layout

The illustrations below outline your phone's basic layout.

## Front panel

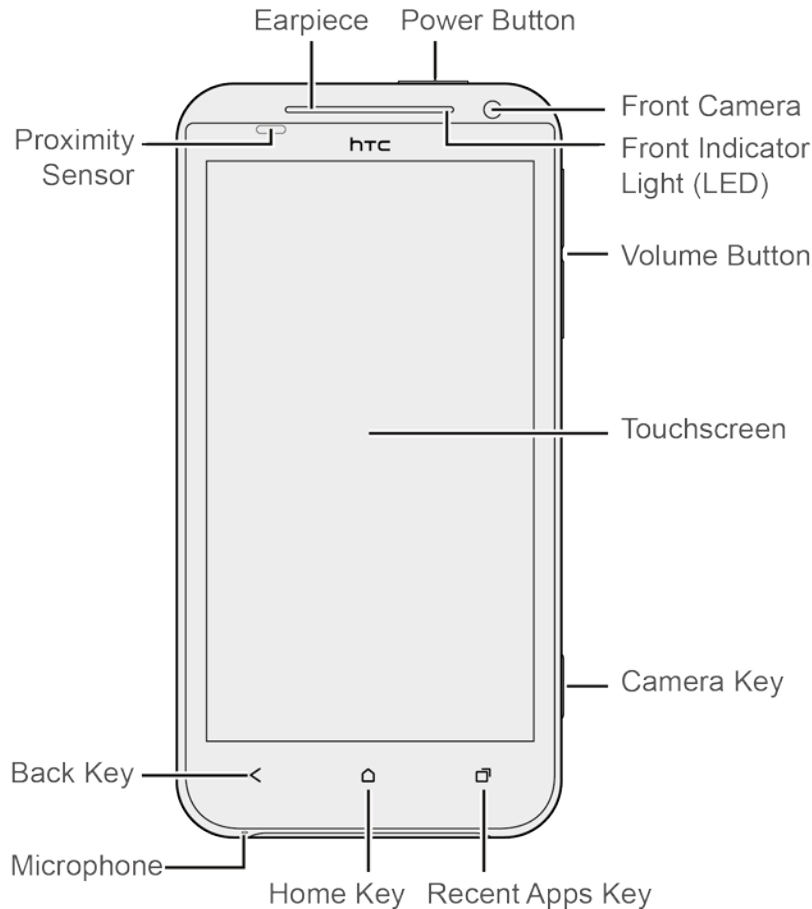

- **Power Button** lets you turn the phone on or off, turn the screen on or off, restart the phone, or switch your phone to airplane mode.
- **Earpiece** lets you hear the caller and automated prompts.
- **Proximity sensor** automatically switches the display screen off when you hold the phone near your face during a call. When activated, the proximity sensor does not affect the phone's 3G, 4G, or Wi-Fi connection.

**Important:** If you want to use a screen protector, please don't cover and block the proximity sensor. You can purchase the dedicated screen protector for your phone that already has a small opening for the sensor.

- **Back Key** lets you return to the previous screen, or close a dialog box, options menu, the Notifications panel, or onscreen keyboard.
- **Microphone** allows other callers to hear you clearly when you are speaking to them.

- **Home Key** lets you display the main Home screen. When in standby mode, touch and hold to open the recently used applications window.
- **Recent Apps Key** lets you select and return to recently opened apps.
- **Camera Key** opens the Camera app.
- **Touchscreen** lets you view and control all the features of your phone.
- **Volume Button** allows you to adjust the ringer or media volume or adjust the voice volume during a call.
- **Front Indicator Light (LED)** shows your phone's status or pending notifications at a glance.
- **Front Camera** allows you to take photos and videos or start a video call.

### Back panel

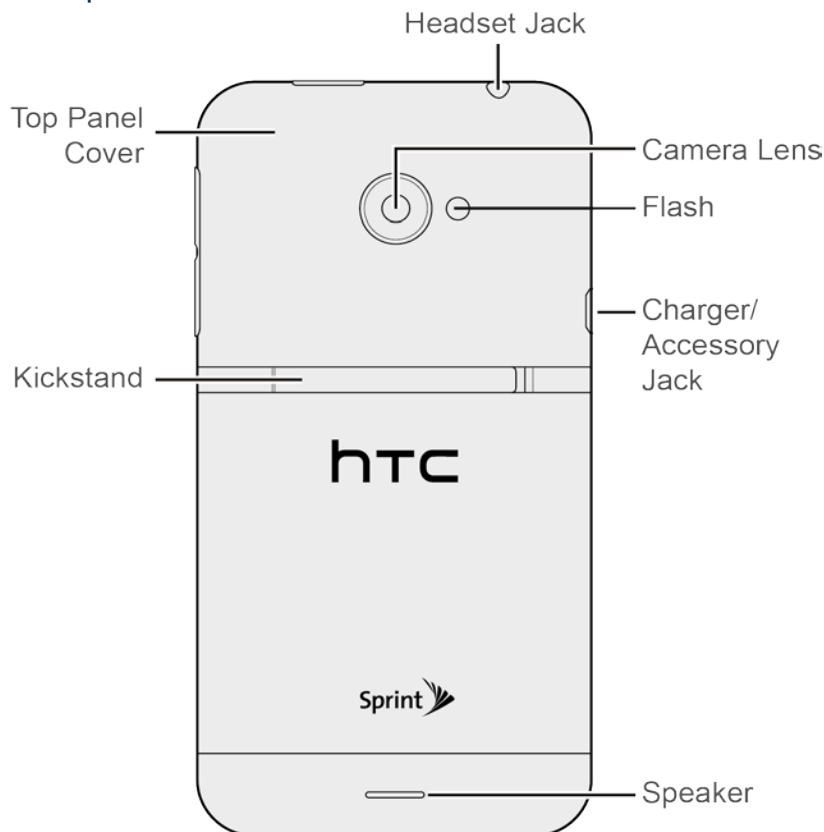

- **Top Panel Cover** covers the microSD card slot.
- **Kickstand** holds the phone sideways on a desk top so you can view photos and videos hands-free.
- **Speaker** lets you hear the different ringers and sounds. The speaker also lets you hear the caller's voice in speakerphone mode.

- **Charger/Accessory Jack** allows you to connect the phone charger or the USB cable (included).

**CAUTION!** Inserting an accessory into the incorrect jack may damage the phone.

- **Flash** helps illuminate subjects in low-light environments when the camera is focusing and capturing a photo or video.
- **Camera Lens** lets you take pictures and videos.
- **3.5 mm Headset Jack** allows you to plug in either a stereo headset or an optional headset for convenient, hands-free conversations.

**CAUTION!** Inserting an accessory into the incorrect jack may damage the phone.

## Kickstand

Enjoy your photos and videos hands-free with the kickstand. Just flip the kickstand and then place the phone on a level and stable surface.

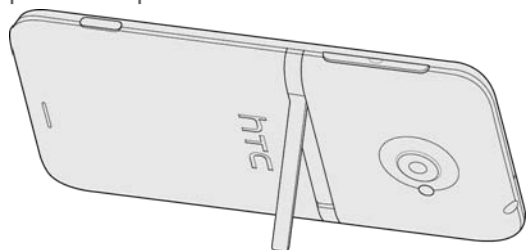

When you need to charge the phone, such as when you're in the middle of a full-length movie, you can turn your phone to access the charger/accessory jack.

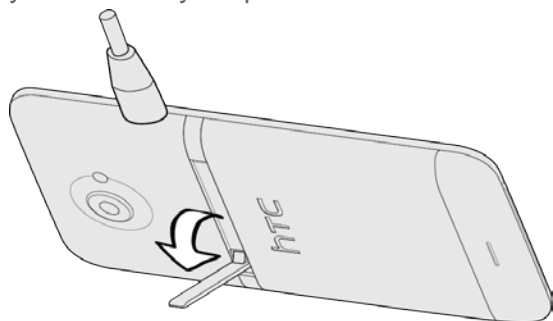

**CAUTION!** When you're using the kickstand and charging the phone battery at the same time, do not apply excessive force on top of the phone to prevent the kickstand from retracting.

## Turn Your Phone On and Off

The instructions below explain how to turn your phone on and off, or how to restart the phone.



### Turn Your Phone On

- ▶ Press and hold .



## Turn Your Phone Off

1. Press and hold  to open the Power options menu.

**Note:** When the screen is locked and you press , it will only turn off the screen and not the phone. You will need to unlock the screen first before you press and hold  to turn the phone off. See [Turn Your Screen On and Off](#) for details.

2. Touch **Power off** to turn the phone off.

## Restart Your Phone

Restarting the phone will close all running apps and will clear all temporary files in the phone's memory. Make sure to save your work before restarting the phone.



1. Press and hold  for about two seconds.
2. On the Power options menu, touch **Restart**.
3. In the Restart phone confirmation box, touch **Restart**.

**Note:** If the phone hangs and the touchscreen does not respond, press and hold  for about 10 seconds to restart the phone.

## Turn Your Screen On and Off

Your phone allows you to quickly turn the screen off when not in use and to turn it back on and unlock it when you need it.

### Turn the Screen Off When Not in Use

- ▶ To quickly turn the screen off, press . Pressing  again or receiving an incoming call will turn on your phone screen and show the lock screen.

To save battery power, the phone automatically turns off the screen after a certain period of time when you leave it idle. You will still be able to receive messages and calls while the phone's screen is off.

**Note:** For information on how to adjust the time before the screen turns off, see [Screen Timeout](#).

### Turn the Screen On and Unlock It

Below are steps for how to unlock your phone's screen.

1. To turn the screen on, press .
2. Flick the ring up to unlock the screen.

# Your Phone's Lock Screen

Aside from protecting the phone's screen from unwanted touches and presses, the lock screen also displays important information, updates, and messages at a glance, and provides shortcut icons to your favorite applications.

[Unlock the Screen](#)

[Customize the Lock Screen](#)

## Unlock the Screen

Unlock the screen to receive an incoming call or to access your phone.

1. When the screen is off, press  to show the lock screen.
2. Do any of the following:
  - Flick the ring up to unlock the screen. When you have an incoming call, flicking the ring up answers the call.
  - Drag a shortcut icon, a photo, or a message to the ring to unlock the screen and launch the related application.

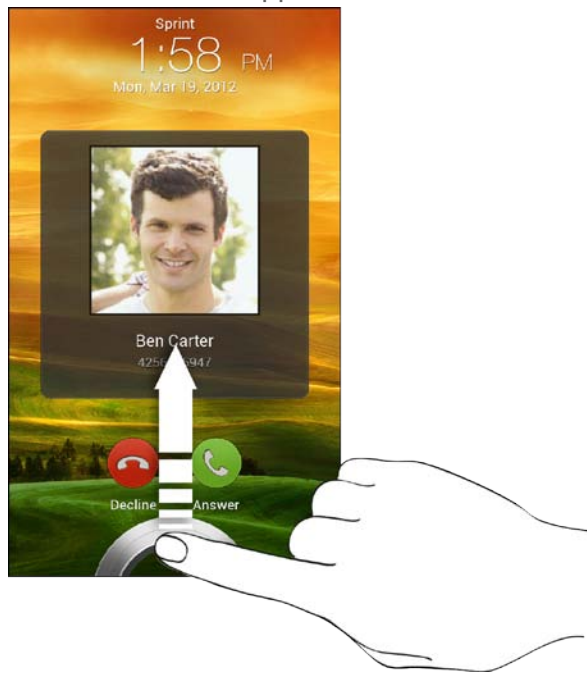

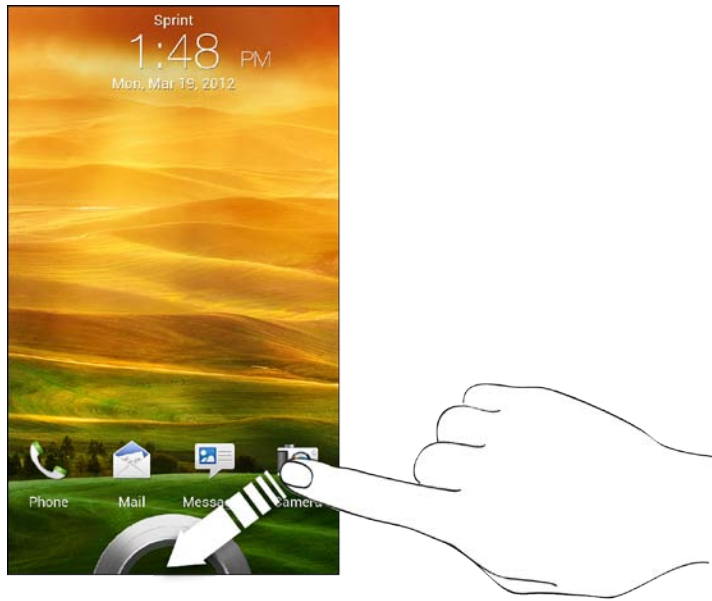

**Note:** If you have set up a screen lock, you will be prompted to draw the pattern or enter the password or PIN. See [Security-Screen Lock](#).

## *Customize the Lock Screen*

You can customize the lock screen style and change the shortcuts that appear on the lock screen.

1. Slide down the Notifications panel, and then touch  > **Personalize**.
2. On the Display tab, touch **Lock screen style**.
3. Slide your finger left or right to choose a lock screen style.
4. Touch the lock screen style to see a preview. If you want to further customize it, touch **Settings**.
5. Touch **Apply**.

**Tip:** The shortcuts on the lock screen are the same apps as the ones on your Home screen's launch bar. To change them, you'll have to replace the apps on the launch bar.

## *Touchscreen Navigation*

Your phone's touchscreen lets you control actions through a variety of touch gestures.

## Touch

When you want to type using the onscreen keyboard, select items onscreen such as application and settings icons, or press onscreen buttons, simply touch them with your finger.

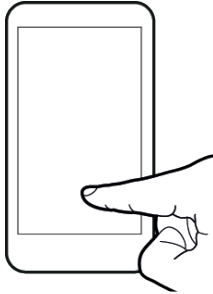

## Touch and Hold

To open the available options for an item (for example, a contact or link in a Web page), touch and hold the item.

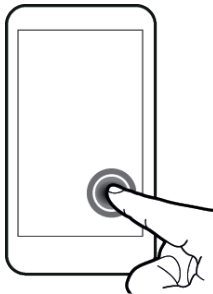

## Swipe or Slide

To swipe or slide means to quickly drag your finger vertically or horizontally across the screen.

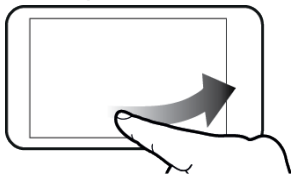

## Drag

To drag, press and hold your finger with some pressure before you start to move your finger. While dragging, do not release your finger until you have reached the target position.

## Flick

Flicking the screen is similar to swiping, except that you need to swipe your finger in light, quick strokes. This finger gesture is always in a vertical direction, such as when flicking the contacts

or message list.

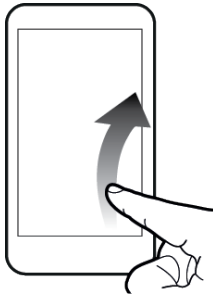

## Rotate

For most screens, you can automatically change the screen orientation from portrait to landscape by turning the phone sideways. When entering text, you can turn the phone sideways to bring up a bigger keyboard. See [HTC Sense Input Keyboard](#) for more details.

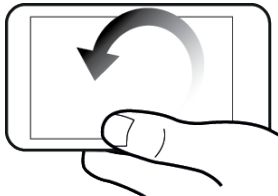

**Note:** The **Auto-rotate screen** option in  (**Settings**) > **Display & gestures** needs to be selected for the screen orientation to automatically change.

## Pinch and Spread

“Pinch” the screen using your thumb and forefinger to zoom out, or “spread” the screen to zoom in when viewing a picture or a Web page. (Move fingers inward to zoom out and outward to zoom in.)

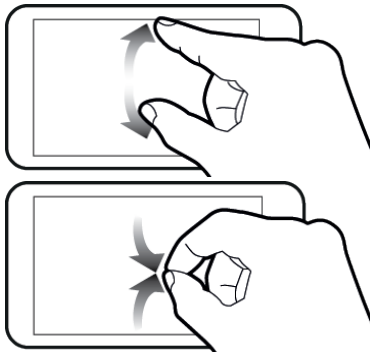

## Two-finger Scrolling

In some applications that have sorting, like Mail or People, you can use two fingers to scroll the screen. The screen displays the sorting order, and you can easily scroll to the information you

want.

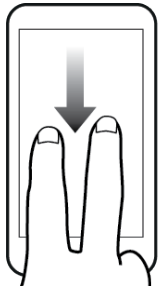

## Press and Flick

On the Home screen, you can easily move a widget or icon from one screen to another. Press and hold the widget or icon with one finger, and flick the screen to the new location with another finger.

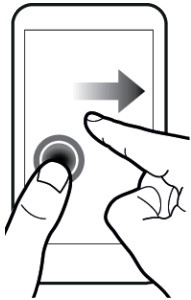

## *Your Home Screen*

The Home screen is the starting point for your phone's applications, functions, and menus. You can customize your Home screen by adding application icons, shortcuts, folders, widgets, and more. Your Home screen extends beyond the initial screen. Swipe the screen left or right to display additional screens.



## Home Screen Basics

### Extended Screens

### Customize the Home Screen

### Launch Bar, Apps, and Folders

## *Home Screen Basics*

Your phone allows you to rearrange the order of your home screens and even remove extended screens at any time.

### Rearrange the Home Screen

Reorder your extended screens in any way that fits how you use them. For example, move the screens with frequently used widgets, shortcuts, and folders closer to the Home screen.

1. Pinch the Home screen to display thumbnail images of all the screens.

**Note:** The main Home screen is indicated by the Home icon (  ).

2. Touch and hold the thumbnail of the screen you want to move. Your phone vibrates. Don't lift your finger just yet.
3. Drag the thumbnail to its new position, and then lift your finger.



## Remove a Home Screen Panel

Remove any unwanted screens to make your phone less cluttered.

1. Pinch the Home screen to display thumbnail images of all the screens.
2. Touch and hold the thumbnail of the screen you want to remove. Your phone vibrates. Don't lift your finger just yet.
3. Drag the thumbnail to **Remove** at the top of the screen.

**Note:** You can add back a Home screen panel.

## Extended Screens

In addition to the Home screen, your phone has six extended Home screens to provide more space for adding icons, widgets, and more. Touch  and then drag across the screen to move from the Home screen to an extended screen.



- You cannot add more screens.
- While on an extended screen, touch  to return to the Home screen.

## Go Directly to a Particular Screen

1. From any Home screen panel, pinch the screen to display thumbnail images of all screens.

**Tip:** On the Home screen, you can touch  to display the thumbnail images of all screens.

2. Touch the screen you want to open, and you'll be taken there.



## Customize the Home Screen

Learn how to add, move, or remove items from the Home screen.

### Add Widgets on Your Home Screen

Widgets put at-a-glance important information and media content up front on your Home screen. Some widgets are already added to your Home screen for your convenience. You can add more from the available selections of widgets.

1. Touch and hold on an empty space on your Home screen.
2. On the Widgets tab, you can:
  - Slide left or right to browse through the complete set of widgets.
  - Touch  to search for specific widgets.
  - Touch **All Widgets** to choose from a selection menu.

**Tip:** Some widgets are available in different styles and sizes.

3. Drag a widget to a Home screen thumbnail where you want to add it.

You can also add widgets that allow you to quickly switch on or off certain settings such as Wi-Fi and Bluetooth. Touch **All Widgets** > **Settings**, and then touch the widget that you want.

### Add Apps and Other Shortcuts on Your Home Screen

Place apps you often use on your Home screen. You can also add shortcuts to frequently used settings, bookmarked Web pages, and more.

1. Touch and hold on an empty space on your Home screen.
2. On the Apps or Shortcuts tab, drag an app or a shortcut to a Home screen thumbnail where you want to add it.

## Move, Remove, or Edit Items on Your Home Screen or Extended Screens

1. Touch and hold the item you want to move, remove, or edit.



2. Do one of the following:
  - To move the item, drag it to a new area and then release it.
  - To remove the item, drag it to the **Remove** button and then release it.
  - You can change the settings of some of the widgets (for example, you can change the city that is displayed on the weather clock widget). To edit a widget, drag it to the **Edit** button, and then follow screen instructions.

## *Launch Bar, Apps, and Folders*

From your Home screen, you can customize your phone's launch bar, group apps into custom folders, and easily access recently used apps.

### Customize the Launch Bar

The launch bar on your Home screen gives you one-touch access to commonly used apps. You can replace the apps on the launch bar with other apps that you often use.

**Tip:** The apps or shortcuts you see on the lock screen are the same as the ones in the launch bar.

1. Touch and hold the app you want to replace, and then drag it out of the launch bar.



2. Touch  to go to the All apps screen.
3. Touch and hold an app, and then drag it to the empty slot on the launch bar.

You can also place shortcuts to settings or information on the launch bar. Add a shortcut first to the Home screen, and then drag it to the launch bar.

## Group Apps in a Folder

Find your apps even easier by grouping them into folders.

1. Touch and hold an app, and then drag it over to another app to automatically create a folder.

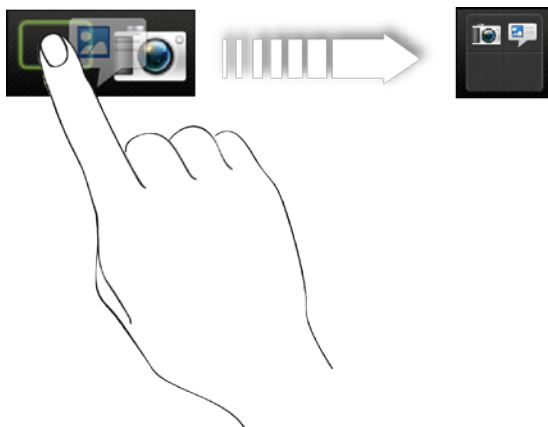

2. Touch the folder to open it.

3. Touch **+**, and then select one or more apps that you want to add to the folder.
4. Touch **Add**.

## Switch to Recent Apps

Use the Recent Apps key to view your recently opened apps.

1. Touch .
2. Slide your finger left or right to see recently-opened apps.



3. Touch an app to open it.

## *Status and Notifications*

The status bar and notification panel make it easy to see your phone's connection, alert you of new messages, and much more.

### Status Bar

### Notifications Panel

### Notification LED

## *Status Bar*

The status bar at the top of the Home screen provides phone and service status information on the right side and notification alerts on the left. To view notification alerts, touch and hold the status bar and drag it down.

## Status Icons



























Icon	Description
	Signal strength (More bars = stronger signal)
	No service
	Phone is “roaming” off the Nationwide Sprint Network
	Connected to a Wi-Fi network
	Sprint 4G LTE Network is available
	Sprint 4G LTE Network available and active (with icon animation)
	Sprint 3G Network is available
	Sprint 3G Network available and active (with icon animation)
	Sprint 3G Network is currently unavailable
	Phone’s location feature is on and available for location-based services such as GPS navigation
	Phone’s location feature off and your location is available only for 911
	Phone microphone muted
	Phone speaker muted
	Vibrate mode
	Shows current battery charge level (icon shown is fully charged)
	Bluetooth on
	Connected to Bluetooth phone
	Airplane mode
	Alarm set
	Speakerphone on
	Wired microphone headset connected

	Wired headset connected
---	-------------------------

## Notification Icons



Icon	Description
	New text or multimedia message
	New voicemail
	New Gmail message
	New Microsoft Exchange ActiveSync or POP3/IMAP email message
	Problem with text or multimedia message delivery
	New instant message from Google Talk
	Upcoming event
	Music is playing
	General notification (for example, sync error)
	Wi-Fi is on and wireless networks are available
	Sprint Hotspot is on
	Data synchronizing – connected to HTC Sync
	New location detected
	More (undisplayed) notifications
	Missed call
	Call in progress
	FM Radio app in use
	Matched contacts suggestion
	Uploading data (animated)
	Downloading data (animated)
	Waiting to upload
	Content downloaded
	Phone connected to computer via USB cable

	Storage card is blank
	Downloaded Google Play app installed successfully

## Notifications Panel

When you get a new notification, you can open the Notifications panel to see the message, reminder, or event notification. The Notifications panel lets you quickly switch between recently opened apps, and also lets you easily turn on settings such as 4G, Wi-Fi, and Bluetooth.

### Open the Notifications Panel

To open the Notifications panel, touch and hold the status bar, and then slide your finger downward. If you have several notifications, you can scroll down the screen to view more notifications.

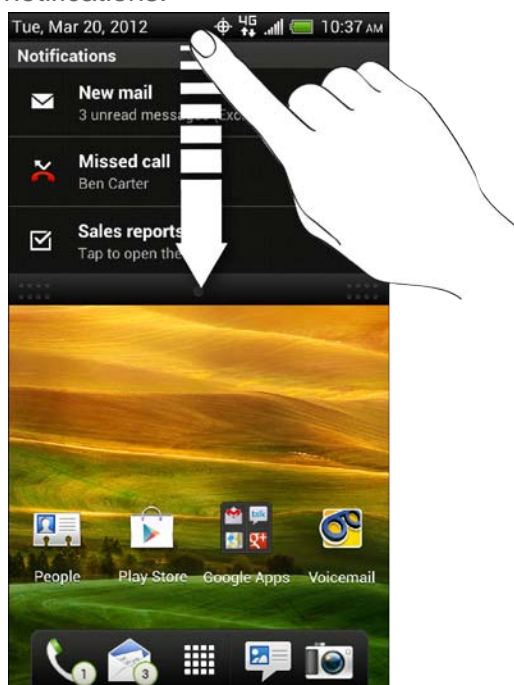

### Close the Notifications Panel

Touch and hold the bottom bar of the Notifications panel, and then drag it up the screen. Or just touch .

## Notification LED

The Notification LED located near the right end of the earpiece provides information on the phone status or pending notifications.

LED Status	Indication
Solid green	Battery is fully charged (when the phone is connected to the AC)

	adapter or a computer).
Solid red	Battery is charging.
Flashing red	Battery is low. (Power is below 14%.)
Flashing green	You have a pending notification (for example, a new message or a missed call).

**Note:** The indicators are listed in order of priority. For example, if your phone is connected to the AC adapter and the battery is charging, the LED will be solid red and will not switch to a flashing green light even if there is a pending notification.

## Enter Text

You can type on your phone using one of the available touchscreen keyboards.

### HTC Sense Input Keyboard

#### Enter Text by Speaking

#### Swype Keyboard

#### Tips for Editing Text

## HTC Sense Input Keyboard

When you start a program or select a box that requires entry of text or numbers, the HTC Sense input keyboard becomes available. You can choose from three keyboard layouts: **Standard**, **Phone**, and **Compact**.

### Change the Keyboard Layout









You can choose from three different keyboard layouts to suit your typing style. To change the keyboard layout, do the following:

1. Open the Notifications panel, and then touch  > **Language & keyboard** > **HTC Sense Input** > **Advanced settings**.
2. Touch **Keyboard types**, and then select from the following keyboard types:
  - **Standard.** This layout is similar to a desktop computer keyboard. This is the default keyboard layout.
  - **Phone.** This layout resembles a traditional wireless phone keypad.
  - **Compact.** This layout features two letters on each key. The keys are slightly larger than on the standard layout.

### Enter Text Using the Touch Input Keyboard

Use the following keys while entering text using the onscreen keyboard:



Key	Description
	Touch and hold keys with gray characters at the top to enter numbers, symbols, or accented letters. The gray character displayed on the key is the character that will be inserted when you touch and hold that key. Some keys have multiple characters or accents associated with them.
	<b>Shift</b> key. Touch to capitalize the next letter you enter. Touch twice to turn on caps lock.
	<b>Numeric</b> key. Touch to switch to the numeric and symbol keyboard.
	<b>Alphabet</b> key. While in numeric or symbol keyboard, touch to switch to the alphabetic keyboard
	<b>Enter</b> key. Touch to create a new line.
	<b>Backspace</b> key. Touch to delete the previous character. Touch and hold to delete multiple characters
	<b>Voice input</b> key. Touch to speak the words you want to type. See <a href="#">Enter Text by Speaking</a> .
	Touch to hide the touch input keyboard.
	Touch to toggle between <b>Multitap</b> and <b>XT9</b> predictive modes when using the Compact or Phone layout. See <a href="#">Predictive Text</a> .

## Change to Landscape Keyboard

When entering text, you can choose to use the landscape orientation of the touch input keyboard by turning the phone sideways. This pops up a larger Standard keyboard that lets you type easily using two thumbs.

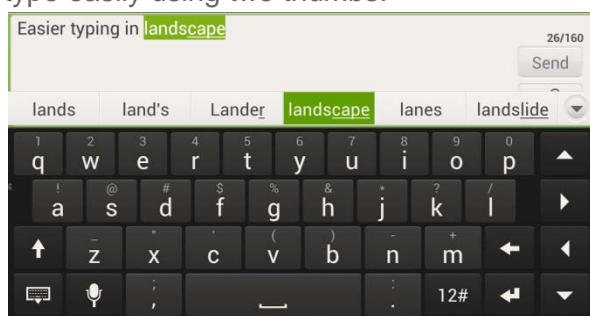

**Note:** The landscape keyboard is not supported in all applications.

## Adjust the Touch Input Settings

1. Open the Notifications panel, and then touch  > **Language & keyboard** > **HTC Sense Input**.
2. Change the following settings:

- **International keyboard** lets you add or remove languages from the touch input language list.
- Enable or disable keyboard settings including sound and vibration feedback, trace keyboard, and toggle among keyboard types.
- **Chinese input settings** lets you set options when entering text in Chinese.
  - **Pinyin:** Choose Traditional Chinese or Simplified Chinese in Output characters. In Simplified Chinese, you can enable Fuzzy Pinyin Pairs.
  - **Stroke:** Choose Traditional Chinese or Simplified Chinese in Output characters.
  - **Handwriting:** Write Chinese characters directly on the screen. You can set the output character, pen color, and more.
- **Advanced settings**
  - **Keyboard types** lets you select the keyboard layout to use. You can choose from Standard, Phone, or Compact.
  - **Bilingual prediction** lets you activate word prediction for a second language.
  - **Trace color** lets you select the color to use when using the Trace keyboard.
- **Advanced settings: Prediction preference**
  - **Word prediction:** Enable the word prediction feature.
  - **Spell correction:** Correct typographical errors by selecting from a list of possible words based on the keys you have touched as well as neighboring keys.
- **Advanced settings: Phone & compact**
  - **Spell correction:** Correct typographical errors by selecting from a list of possible words that reflect the characters of the keys you have touched as well as characters of nearby keys.
  - **Word completion:** Select from a list of possible combinations based on the characters that appear on the keys that you touched.
- **Advanced settings: Finger touch calibration**
  - **Calibration tool:** Lets you recalibrate the keyboard if you feel that the keys are not responding accurately to your touches.
  - **Reset calibration:** Reset the calibration back to factory default.
- **Personal dictionary** lets you add, edit, or remove words in the predictive text dictionary. For more information, see [Add a Word to the Predictive Text Dictionary](#) and [Edit or Delete a Word in Your Personal Dictionary](#).
- **Tutorial** lets you go through tutorials to learn how to use the touch input keyboard features.

## Enter Text by Speaking

Try speaking the words to enter them in most text fields that let you use the touch input keyboard.

**Important:** First make sure to select the language you'll be using in the **Language & keyboard** settings.

Since your phone uses Google's speech-recognition service, you need to be connected to the Internet to enter text by speaking.

1. Touch  on the keyboard. Your phone then cues you to speak.
2. Tell your phone what you want to be typed in.

## Set the Voice Input Language

Select a language you want your phone to recognize.

1. Open the Notifications panel, and then touch  > **Language & keyboard** > **Google voice typing**.
2. Touch **Select input language**.
3. Clear the **Automatic** option, and then select the language you want.

## Swype Keyboard

Enter text by sliding on or touching the keys on the Swype<sup>®</sup> keyboard, or by speaking.

### Switch to the Swype Keyboard

By default, your phone uses the touch input keyboard for text input. You can change the input method to the Swype keyboard.

1. Start an app that requires text or numbers.
2. Open the Notifications panel, and then touch **Select input method** > **Swype**.

### Enter Text Using Swype

Slide your finger on the Swype keyboard to enter text.

1. Start an app or select a text field that requires text or numbers.
2. Briefly press and hold the first letter of the word you want to enter, and then slide your finger to the other letters of the word.
3. When you've reached the last letter, lift your finger.  
For example, to enter the word "the", press and hold **t**, and then slide your finger to **h**









and e.



**Note:** If you've entered a word that Swype doesn't recognize, word suggestions appear at the top of the keyboard. Touch a word to enter it to your text.

### Enter Text by Typing on the Swype Keyboard

Instead of using Swype, you can enter text by touching these keys on the Swype keyboard:

Key	Description
	Press and hold keys with characters at the top to enter numbers, symbols, or accented letters. The gray character displayed on the key is the character that will be inserted when you press and hold that key. Some keys have multiple characters or accents associated with them.
	Shift key. Touch to enter an uppercase letter. Touch twice to turn on caps lock.
	Touch to switch to the numeric and symbol keyboard.
	Enter key. Touch to create a new line.
	Backspace key. Touch to delete the previous character.
	Language key. Touch to change the keyboard language.
	Touch to enter words by speaking.
	Swype key. Touch to view a tutorial on how to use Swype, see tips, and get help.

### Adjust the Swype Keyboard Settings

There are many options to choose from with Swype keyboard settings.

- ▶ While using the Swype keyboard, touch and hold .
  - **Select Input Method.** Lets you return to using the touch input keyboard.
  - **How to Swype.** View the Swype help file and tutorial.
  - **Personal dictionary.** Manage your personal dictionary.

- **Preferences.** Change the keyboard language and enable or disable audio feedback, vibrate on keypress, or tip indicator.
- **Language Options.** Set and activate the language to use when using Swype.

## *Tips for Editing Text*

Your phone gives you many options to make entering text easier, including copying, cutting, and pasting text, using voice-to-text input, customizing the user dictionary, using predictive text, and more.

### Using Predictive Text

The onscreen keyboard has predictive text to help you type quickly and accurately. Predictive text input is enabled by default, and word suggestions are displayed as you type.

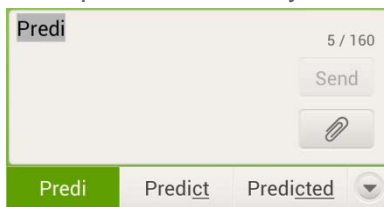

To enter a word in predictive mode, do any of the following:

- If you see the word you want highlighted, you can simply touch the space bar to insert the word into your text.
- If you see the word you want shown in the suggestions before you have finished typing the entire word, touch the word to insert it into your text.
- If an arrow is shown to the right of the suggestion list, touch the arrow to see more suggestions.

### Add a Word to the Predictive Text Dictionary

Your phone comes with a list of words that it references for predictive text suggestions. Sometimes you may need to add a word to the predictive text dictionary, for example a name or a specialized technical word.



While entering text using the Standard keyboard layout, if you touch any word on the suggestion list, it is automatically added to the predictive text dictionary if it was not in the dictionary already.

To manually add a word to the predictive text dictionary:

1. Open the Notifications panel, and then touch > **Language & keyboard** > **HTC Sense Input** > **Personal dictionary**.
2. Touch **Edit personal dictionary**, and then touch .
3. Enter the word to add, and then touch **OK**.

## Edit or Delete a Word in Your Personal Dictionary

You can edit or remove words that you previously added to the predictive text dictionary.

1. Open the Notifications panel, and then touch  > **Language & keyboard** > **HTC Sense Input** > **Personal dictionary**.
2. Touch **Edit personal dictionary**.
3. Do one of the following:
  - To edit a word, touch the word, enter your changes, and then touch **OK**.
  - To delete a word, touch  > **Delete**, and then touch  to the right of the word.
  - Touch **Delete**.

## Back up Your Personal Dictionary to Your Storage Card

You can use your microSD storage card to back up the new words you've added to your personal dictionary.

1. Open the Notifications panel, and then touch  > **Language & keyboard** > **HTC Sense Input** > **Personal dictionary**.
2. Touch **Sync personal dictionary** > **Copy to storage card**.
3. When prompted, touch **OK**.

## Restore Your Personal Dictionary from Your Storage Card

You can restore your personal dictionary stored on your microSD storage.

1. Open the Notifications panel, and then touch  > **Language & keyboard** > **HTC Sense Input** > **Personal dictionary**.
2. Touch **Personal dictionary** > **Sync personal dictionary** > **Restore from storage card**.
3. When prompted, touch **OK**.

## Select Text

Highlight the text that you want to copy or cut.

1. Touch and hold a part of the text that you want to copy.
2. Drag the text markers to the start and end of the text that you want to select. Or touch **Select all** to select everything in the text field.

## Copy and Paste Text

1. After you have selected the text you want to copy, touch **Copy** or **Cut**. The selected text is then copied to the clipboard.

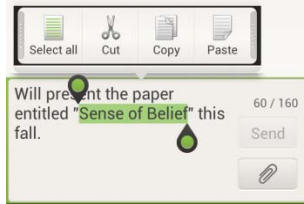

2. Touch and hold a text field in the same or other app.
3. Touch or touch and hold the position where you want to paste the text, and then touch **Paste**.

# Phone Calls

---

With the Nationwide Sprint Network and your phone's phone, you can enjoy clear calling across the country.

[Make Phone Calls](#)

[Receive Phone Calls](#)

[Visual Voicemail](#)

[Voicemail \(Traditional\)](#)

[Phone Call Options](#)

[Internet Calls](#)

[Set Up Speed Dialing](#)

[Call History](#)

## *Make Phone Calls*

There are several convenient ways to place calls from your phone.

[Call Using the Phone Dialer](#)

[Call From Call History](#)

[Call From People](#)

[Call Using a Speed Dial Number](#)

[Call a Number in a Text Message or Email Message](#)

[Call Emergency Numbers](#)

## *Call Using the Phone Dialer*



The most “traditional” way to place a call is by using the phone's dialer screen.

1. Touch  >  to display the phone's dialer screen.

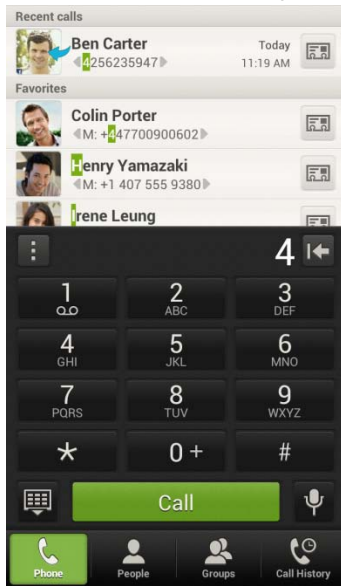

2. Touch the number keys on the Phone keypad to enter the phone number.





3. As you enter digits, Smart Dial searches for contacts that match. If you see the number you want to dial, touch it to place the call immediately without entering the rest of the number.
4. If you enter an incorrect digit, touch  to erase it. To erase the entire number, touch and hold .

**Tip:** Touch  to close the Phone keypad and to see if there are more matching numbers or contacts. To browse through the filtered list, flick through the list or slide your finger up or down the list slowly.

5. Touch **Call** to call the number.
6. To end the call, touch **End call**.

## Call From Call History

You can directly call numbers stored in your Call history.



1. Touch  > .
2. Touch the **Call History** tab.
3. Touch an entry on the Call history list to place a call to that entry.

**Note:** You cannot make calls from Call history to entries identified as **No ID** or **Restricted**.

**Tip:** Touch and hold an entry in the Call history list to open the options menu where you can select to view the contact information (if number is stored in People), edit the number before you redial, send a text message, or delete the entry from the Call history list and more.

## Call From People



Call your contacts from the People application.

1. Touch  >  > **People**.
2. Touch the contact you want to call to open the Contact details screen.
3. Touch **Call [number type]** to place a call.

For additional information, see [People](#).

## Call Using a Speed Dial Number

Speed dial numbers let you dial numbers by touching and holding a single number on the Phone keypad. See [Set Up Speed Dialing](#) for information on assigning speed dial numbers.

1. Touch  >  to display the phone dialer's screen.
2. Touch and hold the speed dial key on the Phone keypad. The display confirms that you have dialed the number when it shows "Dialing" on the upper right side of the screen.

## Call a Number in a Text Message or Email Message

While viewing a text message or email message, you can place a call to a number that is in the body of the message.





1. While viewing a text or email message, touch the phone number in the message.
2. Touch **Call**. Your phone then dials the phone number.

For additional information, see [Text Messaging and MMS](#) and [Email](#).





## Call Emergency Numbers

You can place calls to 911 even if the phone's screen is locked or your account is restricted.

To call the 911 emergency number when the phone's screen is locked with a screen lock:

1. Unlock the screen. For more information, see [Turn Your Screen On and Off](#).
2. Touch **Emergency call** on the screen.
3. Touch    .

To call the 911 emergency number normally or when your account is restricted:

1. Unlock the screen. For more information, see [Turn Your Screen On and Off](#).
2. Touch  on the Home screen.
3. Touch    .

## Enhanced 911 (E911) Information

This phone features an embedded Global Positioning System (GPS) chip necessary for utilizing E911 emergency location services where available.

When you place an emergency 911 call, the GPS feature of your phone seeks information to calculate your approximate location. Depending on several variables, including availability and access to satellite signals, it may take up to 30 seconds or more to determine and report your approximate location.

**Important:** **Always report your location to the 911 operator when placing an emergency call.** Some designated emergency call takers, known as Public Safety Answering Points (PSAPs), may not be equipped to receive GPS location information from your phone.

## Receive Phone Calls

When you receive a phone call from a contact, the Incoming call screen appears and displays the caller ID icon, name, and phone number of the calling party. When you receive a phone call from someone who is not stored in People, only the default caller ID icon and phone number appear on the Incoming call screen.

**Note:** If your phone is turned off, all calls automatically go to voicemail.

### Answer an Incoming Call

- If the display is on, touch **Answer**.
- If the display is off, the display will come on with the Lock screen. To answer the call, flick the ring up, or touch and hold the **Answer** button and then drag it to the ring.



### Mute the Ringing Sound

To mute the ringer without rejecting the call, you can do any of the following:

- Press the volume button.
- Briefly press the Power button (.
- Place the phone face down on a level surface. (You can do this even on the Lock screen.)

### Use the Quiet Ring on Pickup Feature

Your phone automatically reduces the ringer volume when you pick up the phone to answer calls.

1. Open the Notifications panel, and then touch  > **Sound**.
2. Make sure to select the **Quiet ring on pickup** option.
3. Touch .

## Reject an Incoming Call

- If the display is locked when you get a call, drag the **Decline** button to the Lock screen ring. Then drag to the ring the **Remind me** icon to create a task or the **Send message** icon to send a text message to the caller.
- If the display is on when you get a call, touch **Decline**.
- If the display is off, the display will come on with the Lock screen. Touch and hold the **Decline** button and then drag it to the ring to reject and send the call to your voicemail.

## Visual Voicemail

Visual Voicemail gives you a quick and easy way to access your voicemail. Now you can find exactly the message you are looking for without having to listen to every voicemail message first. This new feature periodically goes out to your voicemail, and gathers the caller information from all of the current voicemails. It then populates a list with the caller name and number, along with the length of time and priority level of the voicemail message.

[Set Up Visual Voicemail](#)



[Review Visual Voicemail](#)

[Learn More About Visual Voicemail](#)

## Set Up Visual Voicemail

Your phone automatically transfers all unanswered calls to your voicemail, even if your phone is in use or turned off. You should set up your Sprint voicemail and personal greeting as soon as your phone is activated.

**Note:** To set up your traditional voicemail box, see [Set Up Voicemail](#).

1. Touch  >  > **Voicemail**.
2. Touch **Personalize now** and follow the voice prompts to:
3. Create a password (part of standard voicemail).
4. Record your name announcement.
5. Record your greeting.
6. When prompted to enter information, use the onscreen dialpad to enter your numeric responses.

**Important:** **Voicemail Password** – Sprint strongly recommends that you create a password when setting up your voicemail to protect against unauthorized access. Without a password, anyone who has access to your phone is able to access your voicemail messages.

7. Once you have completed the setup process, return to the voicemail page (see step 1).

8. Touch the **Welcome to Voicemail** message on the screen to play a brief explanation of the voicemail services.

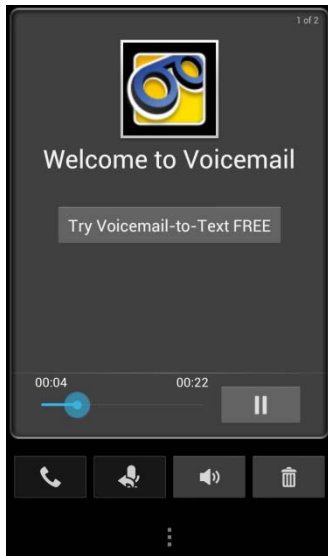

## *Review Visual Voicemail*

Visual Voicemail lets you easily access and select which messages you want to review.

- Touch > > **Voicemail**.
- Touch a message to review it. The following is a description of the features available while reviewing a voicemail message.
- Touch > **Lock** to prevent the message from accidentally being deleted.
- **Timeline** provides a visual timeline for the current message. Touch and drag this bar to scrub through the message to different points.
- Touch to pause the playback, or touch to resume.
- Touch to call the person who left the voicemail message.
- Touch to reply to the message. You can then record a reply and tag the reply message for both **Urgency** and **Privacy**. Touch **Send** to deliver the new message.
- Touch to turn the speakerphone on or off during playback. If the speakerphone feature was enabled within the Voicemail Settings menu, the speakerphone will always be automatically enabled during voicemail playback.
- Touch to delete the current voicemail message. Touch **OK** to confirm the deletion.

## *Learn More About Visual Voicemail*

Check the Visual Voicemail help to learn more about this application.

1. Touch > > **Voicemail**.
2. Touch > **Settings** > **Help**.

## Voicemail (Traditional)

In addition to [Visual Voicemail](#), your phone and Sprint service always offer traditional voicemail service accessed through the Phone application.



### Set Up Voicemail

#### Voicemail Notification

#### Retrieve Your Voicemail Messages

## Set Up Voicemail

Your phone automatically transfers all unanswered calls to your voicemail, even if your phone is in use or turned off. You should set up your Sprint Voicemail and personal greeting as soon as your phone is activated. Always use a password to protect against unauthorized access.

1. Touch  > .
2. Touch and hold  to dial your voicemail number.
3. Follow the system prompts to:
  - Create your password.
  - Record your name announcement.
  - Record your greeting.

**Important:** **Voicemail Password** – Sprint strongly recommends that you create a password when setting up your voicemail to protect against unauthorized access. Without a password, anyone who has access to your phone is able to access your voicemail messages.

## Voicemail Notification

There are several ways your phone alerts you to a new message.

- By sounding the assigned ringer type.
- By displaying  within the Notifications area of the Status bar when a single new unheard voicemail message is received.
- By flashing the front indicator light (LED), if enabled.



**Note:** When you are roaming off the Nationwide Sprint Network, you may not receive notification of new voicemail messages. Sprint recommends that you periodically check your voicemail by dialing 1 + area code + your wireless phone number. When your voicemail answers, press  and enter your password. Roaming rates apply when you access voicemail while roaming off the Nationwide Sprint Network.

Your phone accepts messages even when it is turned off. However, your phone notifies you of new messages only when it is turned on and you are in a Sprint service area.

## Retrieve Your Voicemail Messages

You can review your messages directly from your wireless phone (using either traditional voicemail or Visual Voicemail) or from any other touch-tone phone.

### Use Traditional Voicemail to Access Your Messages

1. Touch  > .
2. Touch and hold  to dial your voicemail number.
3. Follow the voice prompts to listen to and manage your voicemail messages.

### Use Another Phone to Access Your Messages

1. Dial your wireless phone number.
2. When your voicemail answers, press the asterisk key (\*) on the phone.
3. Enter your password.

**Tip:** When you call voicemail from another phone, you first hear the header information (date, time, and sender information) for the message. To skip directly to the message, touch  during the header.

**Note:** You are charged for airtime minutes when you are accessing your voicemail from your wireless phone.

## Phone Call Options

Your phone provides many useful features and options to help you make the most of your calling experience.

[Caller ID](#)

[Call Waiting](#)





[3-way Calling](#)

[Call Forwarding](#)

[In-call Options](#)

### Caller ID

Caller ID identifies a caller before you answer the phone by displaying the number of the incoming call. If you do not want your number displayed when you make a call, follow these steps.

1. Touch  > .
2. Touch   .
3. Enter a phone number.

4. Touch .

To permanently block your number, call Sprint Customer Service.

## Call Waiting



When you're on a call, Call Waiting alerts you to incoming calls by sounding two beeps. Your phone's screen informs you that another call is coming in and displays the caller's phone number (if it is available and you are in digital mode).

To respond to an incoming call while you're on a call:

- ▶ Touch  > **Flash**. (This puts the first caller on hold and answers the second call.)





To switch back to the first caller:

- ▶ Touch  > **Flash** again.

**Note:** For those calls where you don't want to be interrupted, you can temporarily disable Call Waiting by touching    before placing your call. Call Waiting is automatically reactivated once you end the call.

## 3-way Calling

With 3-Way Calling, you can talk to two people at the same time. When using this feature, the normal airtime rates will be charged for each of the two calls.

1. Touch  > .
2. Dial a number and touch .
3. Once you have established the connection, touch  > **Add call**, and dial the second number. (This puts the first caller on hold and dials the second number.)
4. When you're connected to the second party, touch .

If one of the people you called hangs up during your call, you and the remaining caller stay connected. If you initiated the call and are the first to hang up, all callers are disconnected.

To end the three-way call, touch **End call**.

## Call Forwarding





Call Forwarding lets you forward all your incoming calls to another phone number – even when your phone is turned off. You can continue to make calls from your phone when you have activated Call Forwarding.

**Note:** You are charged a higher rate for calls you have forwarded.







To activate Call Forwarding:

1. Touch  > .



2. Touch   .
3. Enter the area code and phone number to which you want your calls forwarded.
4. Touch . (You will hear a tone to confirm the activation of Call Forwarding.)

To deactivate Call Forwarding:



1. Touch  > .
2. Touch    .
3. Touch . (You will see a message and hear a tone to confirm the deactivation.)

## *In-call Options*

Touching  during a call displays a list of available in-call features.

- **Add call** to initiate a three-way call.
- **Flash** to accept another incoming call and put the first caller on hold. Touch **Flash** again to talk to the first caller.
- **People** to display your contacts list.
- **Contact card** to display the caller's contact information.

**Note:** When the phone is completing a call, only the **People** and **Flash** are available.

You can also touch  to mute the microphone. Touch the button again to unmute. To turn the speakerphone on or off, touch . You can adjust the speaker volume by pressing the volume button.

**Warning:** Because of higher volume levels, do not place the phone near your ear during speakerphone use.

## *Internet Calls*

When you're connected to a Wi-Fi network, you can make and receive calls through an Internet calling account.

[Add an Internet Calling Account](#)

[Make an Internet Call](#)

**Note:** Before you add an Internet calling account, make sure that you've registered with an Internet calling service that supports voice calls over Session Initiation Protocol (SIP). Internet calls to phone numbers may incur additional fees.

### *Add an Internet Calling Account*

You must add an Internet calling account before you can make Internet calls.

1. Open the Notifications panel, and then touch  > **Call**.

2. Under Internet call settings, touch **Accounts**.
3. Touch **Add account**.
4. Enter your account details.
5. Touch  > **Save**.
6. To set your phone to receive Internet calls on your added account, touch the **Receive incoming calls** check button.

## *Make an Internet Call*



Make an Internet call to either your contact's Internet calling account or phone number.

- **Internet calling account**
  - In People, touch a contact who has an Internet calling account, and then touch **Internet call**.
  - In Call History, touch an Internet call log.
- **Phone number**. First, enable Internet calling for your outgoing calls. Open the Notifications panel, and then touch  > **Call**. Touch **Use Internet calling**, and then select either **For all calls when data network is available** or **Ask for each call**.

## *Set Up Speed Dialing*

Your phone can store up to nine phone numbers in speed dial locations.

To assign a speed dial number to a contact:

1. Touch  >  > **People**, and then touch a contact.
2. Touch  > **Set speed dial**.
3. Touch the **Not assigned** button under **Number** to select the contact's number that you want to assign to the speed dial key.
4. Touch the **Not assigned** button under **Location** and then select a speed dial location.
5. Touch **Save**.

**Note:** If you assign a number to an already assigned speed dial location, the new phone number will automatically replace the previous speed dial assignment.

## *Call History*

Call history lists all recent incoming, outgoing, and missed calls. Call history makes redialing a number fast and easy. It is continually updated as your phone automatically adds new numbers to the beginning of the list.

**Note:** Call history records only calls that occur while the phone is turned on. If a call is received while your phone is turned off, it will not be included in History.

[View Call History](#)

[Save a Number From Call History](#)

[Prepend a Number From Call History](#)

[Erase Call History](#)

## *View Call History*



Access your Call history to quickly call someone back or see who you have talked to recently.

1. Touch  >  > **Call History** tab.

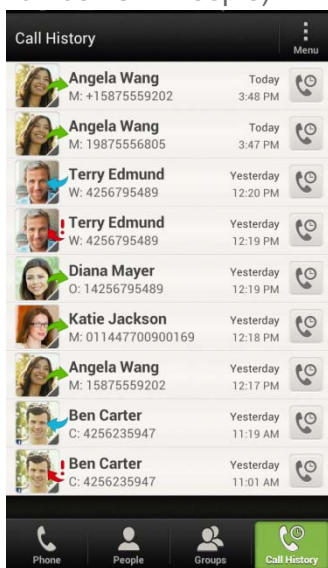
Each entry contains the phone number (if it is available) and the contact name (if the number is in People).





2. Do any of the following on the **Call History** tab:

- Touch a name or number in the list to call. See [Call From Call History](#).
- Touch and hold a name or number in the list to display the options menu.
- Touch  to check the only the Call history of a particular contact.
- Touch  > **View** to display only a particular type of call such as missed calls or outgoing calls.

## *Save a Number From Call History*

If the phone number of a person who called is not in People, you can choose to save the number after you hang up.

1. Touch  >  > **Call History** tab.
2. Touch and hold the received call, and then touch **Save to People** on the options menu.

3. Touch **Create new contact**.

The phone number is automatically added to the **Mobile** box in the Phone section. Enter the name and other contact information.

**Tip:** To store the number as another type (for example, home number), touch the **Mobile** button.



4. Touch **Save**.

After you have saved the number, your phone displays the new contact. (See [Your People List](#).)

**Note:** You cannot save phone numbers already in People or from calls identified as **No ID** or **Restricted**.



## *Prepend a Number From Call History*

If you need to make a call from the Call history and you are outside your local area code, you can add the appropriate prefix by prepending the number.

1. Touch  >  > **Call History** tab.
2. Touch and hold the entry you want to call and touch **Edit number before calling**.
3. Enter the prefix and touch **Call** to call the number.

## *Erase Call History*

If the Call history becomes long, you can delete an entry or the entire Call history list.

1. Touch  >  > **Call History** tab.
2. Do either of the following:
  - To delete a Call history entry, touch and hold the entry, and then touch **Delete from call history**.
  - To erase the entire Call history list, touch  > **Remove call history** > **Select all** > **Delete**.

# Settings

---

Wireless & Networks Settings

Personalization Settings

Accounts & Sync

Location & Security Settings

Display Settings

Sound Settings

Call Settings

Applications Settings

Storage Settings

Power & Data Management Settings

Language & Keyboard Settings

Date & Time Settings

Connect to PC Settings

System Updates

About Your Phone

## *Wireless & Networks Settings*

This group of settings lets you control your phone's wireless network settings (3G and 4G LTE), Wi-Fi settings, Bluetooth, roaming, and more.

Airplane Mode

Wi-Fi

Bluetooth



Mobile Network

More Wireless & Network Settings



## Airplane Mode

Airplane Mode allows you to use many of your phone's features, such as Gallery, Camera, and Music, when you are on an airplane or in any other area where making or receiving calls or data is prohibited. When you set your phone to Airplane Mode, it cannot send or receive any calls or access online information.

To quickly turn Airplane Mode on or off:

- ▶ Press and hold , and then touch **Airplane mode** in Power options. While in Airplane Mode, the status bar will display .

To turn Airplane Mode on or off in Settings:

1. Open the Notifications panel, and then touch .
2. Touch the Off/On switch next to the **Airplane mode** option. While in Airplane Mode, the status bar will display .

## Wi-Fi

Your phone lets you take advantage of Wi-Fi hotspots for high-speed data access using available computer networks. For details on your phone's Wi-Fi features and settings, see [Wi-Fi](#).

## Bluetooth

Your phone's Bluetooth capabilities let you use wireless headsets, send and receive pictures and files, and more. For details on your phone's Bluetooth settings, see [Bluetooth](#).

## Mobile Network

This menu lets you turn your data connection on or off, set options when you're roaming, and more. For details on mobile networks, see [Data Services – Sprint 4G LTE and Sprint 3G Networks](#).

## More Wireless & Network Settings

Additional options that let you view your data usage and set up Media Link HD, VPN, Sprint Hotspot & tethering, NFC, Internet pass-through, and Wi-Fi direct.

- **Media Link HD.** Configure settings for optional Media Link HD connection to an HDTV. See [Wireless Display](#).
- **VPN.** Configure your Virtual Private Network (VPN) settings so you can connect to your company's intranet sites. See [Virtual Private Networks \(VPN\)](#).
- **Sprint Hotspot & tethering.** Share your phone's data connection with other computers and devices. See [Sprint Hotspot](#).
- **NFC.** Share information wirelessly with other NFC-enabled device. See [Bluetooth and NFC](#).

- **Internet pass-through.** When you're travelling and don't have data connection on your phone, connect your phone to your computer and use this option to use your computer's data connection. See [Connect Your Phone to the Internet Through a Computer \(Internet Pass-through\)](#).
- **Wi-Fi direct.** Directly connect and share information with other devices using Wi-Fi.

## Personalization Settings

### Scene

[Change the Home Screen Wallpaper](#)

[Change the Default Ringtone](#)

[Sound Set](#)

[Application Tabs](#)

[Change the Lock Screen Style](#)

Use the Personalize menu to customize your phone's display, select a new Scene, add items to the Home screen, or change the sound settings.

### Scene



Customize your phone's Home and extended screens' appearance by selecting a scene to reflect your lifestyle. Scenes are preset screen layouts that you can quickly apply.

#### Select a Scene

1. Open the Notifications panel, and then touch  > **Personalize**.
2. On the Display tab, touch **Scene**.
3. Slide your finger on the screen from right to left to select the scene you want.
4. Touch **Apply**.

#### Create a Scene



You'll start with an empty Home screen when you create a new scene.

1. Open the Notifications panel, and then touch  > **Personalize**.
2. On the Display tab, touch **Scene**.
3. Touch  > **New**. Slide your finger on the screen from right to left to select the scene you want.
4. Enter a new scene name, and then touch **Done**.
5. Personalize the scene by adding widgets and apps, changing the wallpaper, and more. All of your changes will be automatically saved to this scene.

## Rename a Scene

1. Open the Notifications panel, and then touch  > **Personalize**.
2. On the Display tab, touch **Scene**.
3. Slide your finger on the screen from right to left to select the scene you want to rename.
4. Touch and hold a scene thumbnail, and then touch **Rename**.
5. Enter a new name for the selected scene, and then touch **Done**.

## Delete a Scene

1. Open the Notifications panel, and then touch  > **Personalize**.
2. On the Display tab, touch **Scene**.
3. Touch  > **Delete**.
4. Slide your finger on the screen from right to left to browse through the scenes, and then touch one or more scenes you want to delete.
5. Touch **Delete**.

## *Change the Home Screen Wallpaper*

See [Change the Wallpaper](#) for details.

## *Change the Default Ringtone*



See [Phone Ringtone](#) for details.

## *Sound Set*

Each sound set gives you a different combination of sounds for your ringtone and notifications such as incoming messages, email, calendar event reminders, and more. By switching between sound sets, you can instantly make your phone ring or alert you with fun sounds when you're out with friends or change to subtle sounds while you're at work.

### Apply a Preset Sound Set



You can apply the preset sound set or the one that you've created.

1. Open the Notifications panel, and then touch  > **Personalize**.
2. On the Sound tab, touch **Sound set**.
3. Touch a sound set name you want to use.
4. You can touch  to hear samples of the ringtone, notification sounds, and alarm for that sound set.
5. Touch **Apply**.



## Create a Sound Set

Create your own sound set with your favorite ringtone and notification sound.

1. Open the Notifications panel, and then touch  > **Personalize**.
2. On the Sound tab, touch **Sound set**.
3. Touch .
4. Enter a new sound set name, and then touch **Done**.

The newly created sound set is then added to the list of sound sets. You can assign different tones to the sound set to your preference.

## Change Your Ringtone, Notifications, and Sounds



Further customize your created sound set by changing the ringtone, notifications, and sounds.

1. Open the Notifications panel, and then touch  > **Personalize**.
2. On the Sound tab, touch **Sound set**.
3. Select a sound set you want to customize, or create a new one, and then touch **Apply**.
4. Change the ringtone, notification sound, and alarm from the Personalize screen.  
Go to the Messages, Mail, and Calendar apps to choose sounds for new messages, email, and calendar reminders respectively.

Your phone automatically saves your choices to the current sound set.

## Delete a Sound Set

You can delete sound sets that you don't use.

1. Open the Notifications panel, and then touch  > **Personalize**.
2. On the Sound tab, touch **Sound set**.
3. Touch .
4. Select one or more sound sets you want to delete, and then touch **Delete**.

## *Application Tabs*

You can rearrange the tabs at the bottom of some apps to prioritize the types of information you frequently use. You can also add or remove tabs.

1. Open an app that has the usual tabs at the bottom of its screen.
2. Touch and hold the current tab until the screen changes and shows a message about rearranging tabs.
3. If you don't see any tabs on the app, touch  > **Edit tabs**.

4. You can:
  - Change the order of the tabs. Touch and hold a tab, and then drag it to its new position.
  - Drag a tab into or out of the bottom row to add or remove it.
  - When you're done, touch .

## *Change the Lock Screen Style*

Choose from our selection of lock screens. Some lock screens are customizable.

1. Open the Notifications panel, and then touch  > **Personalize**.
2. On the Display tab, touch **Lock screen style**.
3. Slide your finger left or right to choose a lock screen style.
4. Touch the lock screen style to see a preview. If you want to further customize it, touch **Settings**.
5. Touch **Apply**.

The shortcuts on the lock screen are the same apps as the ones on your Home screen's launch bar. To change them, you'll have to replace the apps on the launch bar.

## *Accounts & Sync*

The Accounts & sync settings menu lets you add and manage all your email, social networking, and picture and video sharing accounts.



[Add Your Social Networks, Email Accounts, and More](#)

[Add One or More Google Accounts](#)

[Manage Your Online Accounts](#)

### *Add Your Social Networks, Email Accounts, and More*



Add your favorite social networks, email accounts, and online storages on your phone so you are connected anywhere you go.

1. Open the Notifications panel, and then touch  > **Accounts & sync**.
2. Touch .
3. Touch an account type. You can set up these accounts on your phone: Dropbox, Evernote for HTC Sense, Exchange ActiveSync, Facebook, Flickr, Google, HTC Account, Mail, Microsoft Hotmail, Skydrive for HTC Sense, and Watch.
4. Enter your account information and follow screen instructions to proceed. Depending on the account type, you may need to enter an email address or user

address, password, domain name, or other information. For Exchange ActiveSync accounts, contact your server administrator to determine what information you will need.

## *Add One or More Google Accounts*

Sign in to your Google Account to see your Gmail, contacts, and calendars, and to use Google apps on your phone.

1. Open the Notifications panel, and then touch  > **Accounts & sync**.
2. Touch  > **Google**.
3. Follow the onscreen instructions to sign in to an account or create a new account.

**Tip:** If you added more than one Google Account, apps such as Gmail can allow you to switch between your accounts. Your phone can only back up settings (such as bookmarks and your Wi-Fi password) to the first Google Account that you added.

## *Forgot Your Google Account Password?*

If you have forgotten your Google Account password, you can try to recover it by going to the Google website.



1. On your phone or on your computer, open your web browser
2. Go to [www.google.com/accounts/recovery](http://www.google.com/accounts/recovery).
3. Enter the email address or username that you use to sign in to your Google Account.
4. Click **Submit**.
5. Follow the instructions on the screen to reset your password.

## *Manage Your Online Accounts*

Manage the online accounts you have associated with your phone.

### **Remove an Account**



You can remove an account to delete all information associated with it from your phone. Removing an account does not delete information from the online service itself.

1. Open the Notifications panel, and then touch  > **Accounts & sync**.
2. Touch the account that you want to remove.
3. Touch .

### **Sync All Your Accounts Automatically**

1. Open the Notifications panel, and then touch  > **Accounts & sync**.
2. Touch the **Auto-sync** On/Off switch to turn automatic sync on or off.

## Sync an Account Manually

1. Open the Notifications panel, and then touch  > **Accounts & sync**.
2. Touch the account you want to sync.
3. Touch .

## Change Synced Data or Settings for an Account

1. Open the Notifications panel, and then touch  > **Accounts & sync**.
2. Touch the account that you want to update.
3. Touch the item you want to sync or edit.

# Location & Security Settings

Your Location settings menu lets you select how your phone determines its location (using the wireless network, GPS satellites, both, or neither). The Security settings menu let you set phone security, lock codes, passwords, administrator settings, and more.

## Location

### Security-Screen Lock



## Location



Your phone is equipped with a Location setting for use in connection with location-based services.

The Location feature allows the network to detect your position. Turning Location setting **OFF** will hide your location from everyone except 911.

**Note:** Turning on **Location setting** will allow the network to detect your position using GPS technology, making some Sprint applications and services easier to use. Turning off **Location setting** will disable the GPS location function for all purposes except 911, but will not hide your general location based on the cell site serving your call. No application or service may use your location without your request or permission. GPS-enhanced 911 is not available in all areas.

To enable your phone's Location setting feature:

1. Open the Notifications panel, and then touch  > **Location** > **Location setting**.
2. Read the disclaimer and then touch **ON**.
3. Touch .

When you turn the Location setting feature on, the phone displays the  icon on the status bar. When you turn Location setting off, the phone displays the  icon.

## Security-Screen Lock

You can increase the security of your phone by creating a screen lock. When enabled, you have to draw the correct unlock pattern on the screen, enter the correct PIN, or enter the correct password to unlock the phone's control keys, buttons, and touchscreen. You can also use face recognition to lock your screen.

### Use Face Unlock

1. Open the Notifications panel, and then touch  > **Security**.
2. Touch **Screen lock** > **Face Unlock**.
3. Touch **Continue** and follow the screen instructions.
4. Choose a backup lock to use in case the phone doesn't recognize you.
5. Touch **OK**.
6. Touch **Lock phone after**, and then specify the idle time before the screen is locked.

**Tip:** You can also touch **Improve face matching** in the Security screen to train your phone to recognize your face in different situations, such as when you're wearing glasses or sporting a beard.

### Use a Screen Unlock Pattern

1. Open the Notifications panel, and then touch  > **Security**.
2. Touch **Screen lock** > **Pattern**.
3. Draw the screen unlock pattern by connecting at least four dots in a vertical, horizontal, or diagonal direction. Lift your finger from the screen when finished.
4. The phone records the pattern. Touch **Continue**.
5. When prompted, draw the screen unlock pattern again, and then touch **Confirm**.

If you fail to draw the correct unlock pattern on the screen after five attempts, you will be prompted to wait for 30 seconds before you can try again.

**Note:** To change your unlock screen pattern, open the Notifications panel, and then touch  > **Security** > **Screen lock**. Draw your current screen unlock pattern and then touch **Pattern**.

### Use a Screen Unlock PIN

1. Open the Notifications panel, and then touch  > **Security**.
2. Touch **Screen lock** > **PIN**.
3. Enter a PIN and touch **Continue**.
4. Enter your PIN again to confirm and touch **OK**.

If you fail to enter the correct PIN after five attempts, you will be prompted to wait for 30 seconds before you can try again.

### Use a Screen Unlock Password

1. Open the Notifications panel, and then touch  > **Security**.
2. Touch **Screen lock** > **Password**.
3. Enter a password and touch **Continue**.
4. Enter your password again to confirm and touch **OK**.

If you fail to enter the correct password after five attempts, you will be prompted to wait for 30 seconds before you can try again.

### Disable the Screen Lock

1. Open the Notifications panel, and then touch  > **Security** > **Screen lock**.
2. Draw your unlock screen pattern, enter your PIN, or enter your password, and then touch **Continue**. If you fail to enter the correct password after five attempts, you will be prompted to wait for 30 seconds before you can try again.
3. Touch **None**.

## *Display Settings*

Adjusting your phone's display settings not only helps you see what you want, it can also help increase battery life.

[Auto-rotate Screen](#)

[Animation](#)

[Text Size](#)

[Brightness](#)

[Screen Timeout](#)

[Keep the Screen On While Charging](#)

[Change the Wallpaper](#)

[Calibrate the Screen](#)

### *Auto-rotate Screen*

By default, the screen orientation automatically changes when the phone is rotated. To disable automatic screen orientation:

1. Open the Notifications panel, and then touch  > **Display & gestures**.

2. Clear the **Auto-rotate screen** option and touch .

**Note:** Not all application screens support automatic rotation. The screen orientation automatically changes to landscape mode when you turn the phone sideways.

## Animation

You can enable or disable screen animations.

1. Open the Notifications panel, and then touch  > **Display & gestures**.
2. Select or clear the **Animation** option.

## Text Size

You can adjust the text size for your viewing comfort.

1. Open the Notifications panel, and then touch  > **Display & gestures**.
2. Touch **Font size** and then select the font size.

## Brightness

By default, the screen brightness automatically adjusts depending on the surrounding lighting conditions.

To manually adjust screen brightness:

1. Open the Notifications panel, and then touch  > **Display & gestures**.
2. Touch **Brightness**, and then clear the **Automatic brightness** option.
3. Drag the slider to adjust the brightness.
4. Touch **OK**.

## Screen Timeout

After a period of inactivity, the phone screen turns off to conserve battery power. You can set the idle time before the screen turns off.



1. Open the Notifications panel, and then touch  > **Display & gestures**.
2. Touch **Sleep**, and then touch the time before the screen turns off.

**Note:** Extended screen timeout periods reduce the battery's talk and standby times.

**Tip:** To turn off and lock the screen quickly, press .

## Keep the Screen On While Charging

You can keep the screen on while you charge the phone.

1. Open the Notifications panel, and then touch  > **Display & gestures**.
2. Select the **Stay awake** option and touch .

**Note:** Extended screen timeout periods reduce the battery's talk and standby times.

**Tip:** To turn off and lock the screen quickly, press .

## *Change the Wallpaper*

Changing the phone's display screen wallpaper with a preset wallpaper or your favorite photo is a quick and easy way to change the feel of your phone and give it a fresh look. Browse the collection of wallpapers included in your phone or choose from photos that you have taken with the camera. You can also change to an animated wallpaper.

1. Open the Notifications panel, and then touch  > **Personalize** > **Wallpaper**.
2. Select from the following:
  - **HTC wallpapers** to use a preset image.
  - **Live wallpapers** to choose from preset animated wallpapers.
  - **Gallery** to use a picture that you have captured using the camera or copied to your phone as wallpaper. You can crop the picture before setting it as wallpaper.
3. Touch **Save** or **Apply**.

## *Calibrate the Screen*

Recalibrate the screen if you feel that the screen orientation does not respond properly to the way you hold the phone.

1. Open the Notifications panel, and then touch  > **Display & gestures** > **G-Sensor calibration**.
2. Place the phone on a flat surface, and then touch **Calibrate**.
3. After the recalibration process, touch **OK**.

## *Sound Settings*

The Sound settings menu lets you control your phone's audio, from ringtones and alerts to touch tones and notifications.

[General Sound Settings](#)

[Incoming Calls](#)

[Notifications](#)

[System](#)

### *General Sound Settings*

Use the following settings for such features as silent mode, vibrate, and overall phone volume.



## Silent Mode

The Silent mode option allows you to mute all sounds without turning your phone off.

To activate Silent mode:

- ▶ Press the volume down button in standby mode until you see the image below on the screen.

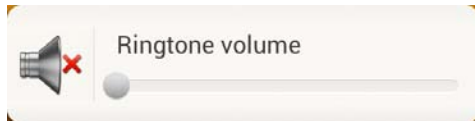

The Silent mode icon (  ) appears on the status bar.

To deactivate Silent mode:

- ▶ Press the volume up button repeatedly to select a volume level.

## Vibrate

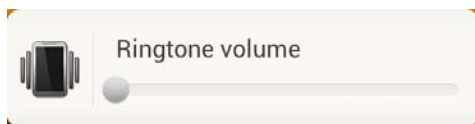

To set your phone to vibrate instead of making any sounds, follow the steps below.

- ▶ Press the volume down button in standby mode until you see the image below on the screen.



The phone vibrates and the vibrate mode icon (  ) appears on the status bar.

To set your phone to always vibrate in addition to any ringer settings:

1. Open the Notifications panel, and then touch  > **Sound**.
2. Select the **Vibrate** check button.
3. Touch .

## Volume

You can separately adjust your phone's multimedia, ringtone and notifications, and alarm volumes.

1. Open the Notifications panel, and then touch  > **Sound** > **Volumes**.
2. Drag the volume sliders on the screen to adjust the media, ringtone and notifications, and alarm, volumes.
3. Touch **OK**.

**Note:** You can adjust the ringer volume in standby mode (or the earpiece volume during a call) by pressing the volume up or down button.

## Incoming Calls

You can select and assign ringtones for your incoming calls.

### Phone Ringtone

Select a default ringtone for incoming calls. Your phone provides a variety of ringtones that you can set as the default ringtone of your phone.

1. Open the Notifications panel, and then touch  > **Sound** > **Phone ringtone**.
2. Touch the ringtone you want to use, and then touch **Apply**. The ringtone briefly plays when selected.

**Note:** You can use \*.wav, \*.mid, \*.mp3, \*.wma, or other types of sound files that you have downloaded from the Internet or copied from your computer as ringtones.

### Other Incoming Call Options

You can choose to enable or disable the following incoming call features:

- **Quiet ring on pickup.** See [Use the Quiet Ring on Pickup Feature](#).
- **Pocket mode.** When selected, the phone rings louder when it's inside your bag or pocket.
- **Flip for speaker.** During a call, you can activate the speakerphone by flipping the phone over.

## Notifications

Use the settings menus to assign specific ringtones for notifications.

### Notification Ringtone

Your phone provides a variety of sounds that you can set as the default sound for notifications.

1. Open the Notifications panel, and then touch  > **Sound** > **Notification sound**.
2. Touch the sound you want to use, and then touch **Apply**. The sound plays when selected.

## System

The System settings menu lets you select whether you hear tones when touching numbers on the dialpad, selecting onscreen options, and more.

- **Dial pad touch tones:** Select the short tones to use.
- **Touch sounds:** Play sounds when making an onscreen selection.
- **Screen lock sounds:** Play sounds when locking or unlocking the screen.
- **Vibrate feedback:** Vibrate when touching soft keys and during certain other instances.

- **Emergency tone:** Set behavior when an emergency call is placed.

## Call Settings

Your phone's Call Settings menu lets you configure your voicemail options and a number of other settings for the phone application.

[Voicemail Settings](#)

[Other Call Settings](#)

[Internet Call Settings](#)

### Voicemail Settings

See [Set Up Voicemail](#).





### Other Call Settings

Use these options to adjust several call settings, such as teletypewriter and DDTM.

#### TTY Mode

A TTY (teletypewriter, also known as a TDD or Text Telephone) is a telecommunications phone that allows people who are deaf, hard of hearing, or who have speech or language disabilities, to communicate by telephone.

Your phone is compatible with select TTY phones. Please check with the manufacturer of your TTY phone to ensure that it supports digital wireless transmission. Your phone and TTY phone will connect using a special cable that plugs into your phone's headset jack. If this cable was not provided with your TTY phone, contact your TTY phone manufacturer to purchase the connector cable.

When establishing your Sprint service, please call Sprint Customer Service using the state Telecommunications Relay Service (TRS) by first dialing    . Then provide the state TRS with this number: **866-727-4889**.

To turn TTY Mode on or off:

1. Open the Notifications panel, and then touch  > **Call** > **TTY mode**.
2. Touch **TTY Full**, **TTY HCO**, or **TTY VCO**. Touch **TTY Off** to turn TTY mode off.

**Note:** When enabled, TTY mode may impair the audio quality of non-TTY phones connected to the headset jack.

**Warning:** **911 Emergency Calling**  
Sprint recommends that TTY users make emergency calls by other means, including Telecommunications Relay Services (TRS), analog cellular, and landline communications. Wireless TTY calls to 911 may be corrupted when received by public safety answering points (PSAPs), rendering some

communications unintelligible. The problem encountered appears related to TTY equipment or software used by PSAPs. This matter has been brought to the attention of the FCC, and the wireless industry and the PSAP community are currently working to resolve this.

## DDTM Mode

Select this option if you want to direct all calls to your voicemail when you are using data connection. See [Data Services FAQs](#).

## *Internet Call Settings*

See [Internet Calls](#).

## *Applications Settings*

This menu lets you control your application settings, including allowing installation of non-Google Play applications and removing applications.

[Allow Installation of Third-Party Programs](#)

[Clear Application Cache and Data](#)

[Select the App to Open Data Items](#)

[Stop Applications Using Task Manager](#)

## *Allow Installation of Third-Party Programs*

By default, you can install only programs and games downloaded from Google Play.

To install third-party programs on the phone:

- ▶ Open the Notifications panel, and then touch  > **Security**. Select the **Unknown sources** option.

To uninstall third-party programs on the phone:

1. Open the Notifications panel, and then touch  > **Apps**.
2. Touch the **Downloaded**, **On phone storage**, **Running**, or **All** tab, and then touch the application you want to uninstall.
3. On the App info screen, touch **Uninstall**.

**Note:** You cannot uninstall programs that are preinstalled on the phone.

## *Clear Application Cache and Data*

Free up storage space and phone memory by deleting application cache and data.

1. Open the Notifications panel, and then touch  > **Apps**.

2. Touch the **Downloaded**, **On phone storage**, **Running**, or **All** tab, and then touch the application whose cache or data you want to delete.

**Tip:** Touch  to sort the apps list.

3. In the App info screen, touch **Clear data** or **Clear cache**.



## Select the App to Open Data Items

You can set which app opens when you tap an item such as a phone number or email address while reading a message, viewing a Web page, and more.

1. Open the Notifications panel, and then touch  > **App associations**.
2. For each item type, select the app you want to open.

## Stop Applications Using Task Manager

Use Task Manager to free up memory by stopping running applications that you're not currently using.

1. Touch  >  > **Task Manager**.
2. In the All applications list, touch  to the right of the application name to stop it.

## Storage Settings

The storage settings menu lets you reset your phone and manage the phone storage and microSD card.

[Where Applications, Data, and Files are Stored](#)

[Encrypt Data on Your Phone](#)

[Reset Your Phone](#)

### Where Applications, Data, and Files are Stored

Your phone uses these storage types.

- **Apps and data storage.** Apps are installed to this storage, labeled as **Internal storage** in your phone settings. It also stores data such as your text messages, contacts you created or synchronized to your phone, account settings, and more. This storage is managed and carefully guarded by your phone since it contains your private information. When you connect your phone to your computer, this storage is not accessible from your computer.  
Storage contents will be erased when you do a factory reset. Make sure to back up your data before starting a factory reset.
- **File storage.** This is another built-in storage, labeled as **Phone storage** in your phone settings. This is where you can store your files. When you connect the phone to your computer and you selected Media sync mode, this storage is accessible and you can

copy files between them. When you do a factory reset, you can choose whether to keep or erase the storage contents.

- **Storage card.** If you installed a microSD card, you can store your files such as photos, music, and videos to this removable storage. When you connect your phone to your computer, this storage is accessible and you can copy files between them. See [microSD Card](#) for more information.

**Note:** The default storage for your files, whether it's the Phone storage or your storage card, may vary from app to app. Some apps allow you to set the default storage.

## *Encrypt Data on Your Phone*

You can encrypt data such as your online accounts, settings, music files and other media. After encryption, you will need to enter the screen lock PIN or password to turn on your phone and access the data.

**Important:** Set a lock screen PIN or password before encrypting your data.

Fully charge the battery and keep your phone connected to the power adapter during encryption. The encryption process takes about an hour.

You cannot undo encryption. If you want to return to an unencrypted phone, you must perform a factory reset.

1. Open the Notifications panel, and then touch  > **Storage**.
2. Select the encryption option for the type of storage you want to encrypt.
3. Touch **Encrypt**.
4. Enter the lock screen PIN or password.
5. Touch **Next**.
6. Touch **Encrypt**.

Encryption starts and the progress is displayed. The phone may restart a few times.

When the encryption process is complete, enter your PIN or password.

## *Reset Your Phone*

Resetting the phone deletes all data and resets the phone back to its initial state — the state before you turned on the phone for the first time. These items will be deleted when you reset the phone.

- Your Google Account
- All other email and social networking accounts
- System and application data and settings
- Downloaded applications



**Important:** Make sure to back up important data you have on the phone or your microSD card before you perform a reset.

## Reset Your Phone via Settings

1. Open the Notifications panel, and then touch  > **Storage** > **Factory data reset**.
2. Do any of the following:
  - If you want to erase all data on the phone storage, select **Erase all data**.
  - If you want to erase all data in the installed microSD card, select **Erase storage card**.
3. Touch **Reset phone**.
4. Touch **Erase everything**. Your phone will power down and reset itself, which may take up to 10 minutes.

Once the phone has reset, it will run through the Hands Free Activation and update processes again. When finished, you will see the Welcome screen and Setup application. See [Complete the Setup Application](#) to start over.

## Reset Your Phone Using the Phone Keys

1. With the phone turned off, press and hold the volume down button, and then press .
2. When the phone's display turns on, release the power and volume buttons.
3. Use the volume button to select **FACTORY RESET**, and then press . All data on your phone will be deleted.

# Power & Data Management Settings

Save battery power by adjusting the screen brightness or by controlling your phone's wireless function and data delivery.

[Adjust the Screen Brightness and Screen On-Time](#)

[Manage Your Phone's Wireless Functions](#)



[Set the Email Synchronization Schedule](#)

[Close Applications Not In Use](#)

## Adjust the Screen Brightness and Screen On-Time

You can reduce screen brightness or set a shorter sleep timeout to save battery power.

- Open the Notifications panel, and then touch  > **Display & gestures** > **Brightness**, and then modify the backlight setting as desired. See [Brightness](#).

- Add the **Power Dashboard** widget to the home screen to easily adjust the screen brightness. Touch and hold a blank space on a Home screen and on the Widgets tab, touch **All Widgets > Settings > Power Dashboard**.
- Decrease the time before the screen turns off when the phone is idle. Open the Notifications panel, and then touch  > **Display & gestures > Sleep**, and then select a timeout value. See [Screen Timeout](#).
- To turn off the screen, press . The phone will continue to function.

## *Manage Your Phone's Wireless Functions*

To save battery life, you can disable the 4G LTE, Bluetooth, GPS, Sprint Hotspot, and Wi-Fi functions of the phone when not in use.

To change wireless settings:

- ▶ Open the Notifications panel, and then touch . Turn off any wireless functions (for example, **Bluetooth** or **Wi-Fi**) that are not in use.

To change GPS settings:





- ▶ Open the Notifications panel, and then touch  > **Location**. Disable the GPS by clearing the **GPS satellites** check button.

To add a wireless function widget to your Home screen:

- ▶ Touch and hold a blank space on a Home screen and on the Widgets tab, touch the **4G**, **Bluetooth**, **GPS**, or **Wi-Fi** widget to add it on the Home screen.

## *Set the Email Synchronization Schedule*

If you use the phone to send and receive email, you can set your email account to download email more or less frequently as desired. The more frequently your phone checks for new messages, the more quickly the battery will run down.

1. Touch  >  > **Mail**.
2. If you have set up multiple email accounts on your phone, switch to the email account that you want to edit by touching .
3. In the inbox, touch  > **Settings > Sync, Send & Receive**.
4. In the **Sync schedule** section, touch **Peak time** or **Off-peak sync**, and then select an email download frequency.

## *Close Applications Not In Use*

You can also close applications that are not in use to conserve battery power.

1. Open the Notifications panel, and then touch  > **Apps**.
2. Touch the **Running** tab, and then touch the application you would like to close.



3. Touch **Stop**.

## *Language & Keyboard Settings*



Your phone's Language & keyboard settings let you select a language for the phone's screens and menus, as well as manage a personal user dictionary. The Language & keyboard settings let you select a preferred input method, control keyboard settings, and more.

[Language Settings](#)

[Keyboard Settings](#)

### *Language Settings*

Changing the language adjusts the keyboard layout, date and time formatting, and more.

1. Open the Notifications panel, and then touch  > **Language & keyboard**.
2. Touch **System language**.
3. Touch the language you want to use, and then touch  to apply the language.

### *Keyboard Settings*

For details on the onscreen keyboard, see [Enter Text](#).

## *Date & Time Settings*

By default, your phone automatically uses the network-provided date, time zone, and time. However, you can set the date, time zone, and time manually if you need to.

1. Open the Notifications panel, and then touch  > **Date & time**.
2. Clear the **Automatic date & time** and Automatic time zone check buttons.
3. Touch **Set date**. In the Change date window, scroll the date wheel to change the date. Touch **OK** when finished.
4. Touch **Set time**. In the time window, scroll the time wheel to adjust the time. Touch **OK** when finished.
5. Touch **Select time zone**, and then select the time zone in the list. Scroll down the list to view more time zones.
6. Select the **Use 24-hour format** check box to toggle between using a 12-hour or 24-hour time format.
7. Touch **Select date format**, and then select how you want dates to display on your phone. The selected date format also applies to the date displayed in the Alarm Clock.

## *Connect to PC Settings*

See [Connect to a Computer](#) for more information.

## System Updates

From time to time, system software updates for your phone may be available. Your phone can automatically check and notify you if an update is available. You can download and install the update to your phone. Depending on the type of update, the update may erase all your personal data and customized settings, and it could also remove any programs you have installed. Make sure that you have backed up the information and files you want to keep.

**Note:** Checking and downloading system software updates may incur additional data transfer fees.

### Check for System Software Updates Manually

1. Open the Notifications panel, and then touch  > **Software update**.
2. On the Software update screen, touch **Check new**.

## About Your Phone

The About menu lets you access important phone information and view legal and safety information.

# People

---

In People, you can easily manage your communications with contacts through phone, messaging, email, and social networks. And, if you have the same contacts from different sources, you can merge their contact information so you won't have duplicate entries.

## [Getting Contacts Into Your Phone](#)

[Your People List](#)

[Your People App Profile](#)

[Add Entries to People App](#)

[Merge Entries in People](#)

[Contact Information and Conversations](#)

[Manage People Entries](#)

[Contact Groups](#)

[Use People Widgets](#)

[Send Contact Information](#)

[Back Up and Restore Your Contacts](#)

## *Getting Contacts Into Your Phone*



There are several ways you can add contacts to your phone.

- **HTC Sync Manager.** Sync the contacts from your old phone to your computer, and then use HTC Sync Manager to sync your phone with your computer's Microsoft® Outlook®, Outlook Express or Windows® Contacts. For more information, see [HTC Sync Manager](#).
- **Gmail™.** Google contacts are imported to your phone after you sign in to your Google Account. You can also create more Google contacts right from your phone. For more information, see [Gmail](#).
- **Facebook.** Log in to your Facebook account to import your Facebook friends' contact information.
- **Phone contacts.** You can choose to create and store contacts directly in your phone or transfer existing ones from your old phone. For more information, see [Add a New People Entry](#) and [Transfer Contacts from Your Old Phone](#).



- **Microsoft Exchange ActiveSync®**. Your phone syncs your work contacts from the Microsoft Exchange ActiveSync Server in your workplace. For more information, see [Email](#).

## Transfer Contacts from Your Old Phone

Easily transfer contacts from your old phone to your new phone through Bluetooth. Depending on your old phone's model, you may also transfer other types of data such as calendar events and text messages to your new phone.

1. Touch  >  > **Transfer**.
2. Touch **Next** and then choose your old phone's name and model.
3. On your old phone, turn Bluetooth on and set it to discoverable mode.
4. On your new phone, touch **Next** to continue. Your phone automatically turns Bluetooth on and searches for Bluetooth phones.
5. From the phone list, choose your old phone and then touch **Next**. Your new phone then tries to pair with your old phone. You'll see a security passkey on the screen.
6. On your old phone, enter this passkey or simply confirm it.
7. Select the Contacts check box (and other supported types of data you want to import), and then touch **Next**.
8. When your new phone finishes importing data, touch **Done**.

## Your People List

The People app lists all contacts stored on your phone and from the online accounts you're logged in to. Touch  >  > **People**.

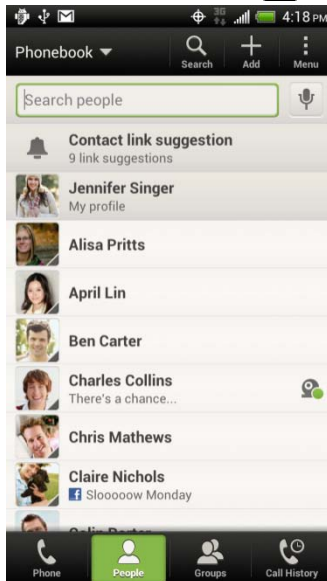

You can:

- View your profile and edit your contact information.
- Create, edit, or find contacts.
- See status updates.
- Touch a name to see that contact's stored information.
- See a notification icon when a contact has sent you new messages or when it's the contact's birthday.

Check out who's online in Google Talk™. Online status icons are displayed if you're signed in to Google Talk.

## Filter Your People List

Choose which account contacts to show.

1. On the People tab, touch ▼ on the top bar.
2. Select the online accounts that contain the contacts you want to display.
3. Touch <.

**Tip:** To set your contact sorting options, touch ≡ > **Settings**.

## Set Contact Search Options

In addition to searching contacts by name, you can also search by other criteria such as by their group name or company.

1. On the People tab, touch ≡ > **Settings**.
2. Touch **Search contacts by**, and then choose the types of criteria to search for.

## *Your People App Profile*

Your profile stores your personal contact information in an easy-to-access location.

### Set Up Your Profile

#### Your Profile

## *Set Up Your Profile*

Store your personal contact information to easily send it to other people.

1. Touch 🏠 > ≡ > **People** > **My profile**.
2. Touch **Edit my contact card**.
3. Enter or edit your name and contact details.
4. Touch 📷 (or the current photo) to change your contact photo.

5. Touch **Save**.

## Your Profile

When you touch **My profile**, you'll see the following tabs.

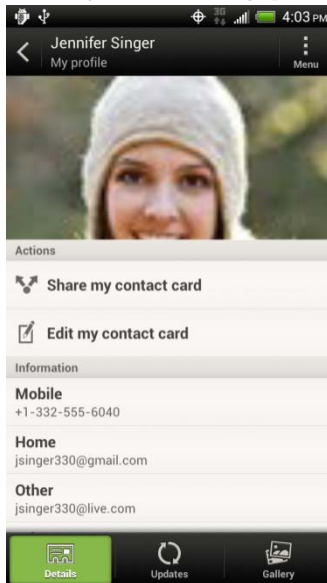

- **Details.** Shows your contact details. You'll also see your most recent posts in social networks (if you're signed in to social networks.) You can also edit your profile or share it with others.
- **Updates.** Shows the updates that you've posted in your social networks.
- **Gallery.** Shows your social network albums and photos.

## Add Entries to People App

You can add new contacts to the People app or add existing ones from your social network or Exchange ActiveSync accounts.



[Add a New People Entry](#)

[Find People You Know on Social Networks](#)

[Import or Copy Contacts](#)

### Add a New People Entry

Start adding your contacts on your phone. If you've set up an email account on your phone, you can sync your new contacts with that account.

1. Touch  >  > **People**.
2. Touch **+**.
3. Touch **Name** field, and then enter the contact name.

**Note:** Touch  if you want to separately enter the contact's first, middle, and last name. Depending on the contact type, you may also be able to add a name prefix (such as Dr.) or a name suffix (such as Ph.D).

4. Select the **Contact type**. This determines which account the contact will sync with.
5. Enter the contact information in the fields provided.
6. Touch **Save**.

**Tip:** **ICE - In Case of Emergency**

To make it easier for emergency personnel to identify important contacts, you can list your local emergency contacts under “ICE” in your phone’s People list. For example, if your mother is your primary emergency contact, list her as “ICE-Mom” in your Contacts. To list more than one emergency contact, use “ICE1-\_\_\_,” “ICE2-\_\_\_,” etc.

## *Find People You Know on Social Networks*

Your phone automatically searches for your phone contacts on different social networks you’re signed into. Based on matching email addresses and contact details, you can send requests to your contacts to join your social network.

To turn this feature on or off, touch  > **Settings** on the People tab, and then select or clear the **Find people you know** option.

**Tip:** To manually refresh the list of people suggestions, touch  > **Manage contacts > Linked contacts**. On the Notifications tab, touch  > **Refresh**.

## Send Social Network Requests to Your Contacts

1. Touch the **People you know** notification (when it’s available on the People tab).
2. Select the people to follow or send friend requests using the social networks you’re signed into.

## *Import or Copy Contacts*

It’s easy to import or copy contacts from your online accounts and save them directly to your phone.

### Import a Contact from an Exchange ActiveSync Account

1. On the People tab, enter the contact’s name or email address in the search box.
2. Touch **Search contacts in your Company Directory**.
3. Touch the name of the contact you want copied to your phone.
4. Touch  to save the contact to your Exchange ActiveSync account.

### Copy Contacts from One Account to Another

1. On the People tab, touch  > **Manage contacts**.

2. Touch **Copy contacts**, and then choose a contact type or online account to copy from.

**Note:** Contacts from your social network accounts may not be copied.

3. Select a contact type or account you want to save to.

## Merge Entries in People

If you have the same contacts on your phone, Google Account, and social network accounts such as Facebook and Twitter, your phone will try to combine them automatically or let you decide which contacts to combine. Combining the same contacts avoids duplicated entries in your contacts list.

### Accept Contact Link Suggestions

#### Manually Merge Entries

#### Break the Link

## Accept Contact Link Suggestions

When your phone finds contacts that can be merged, you'll see a link notification when you open the People app.

1. On the People tab, touch the **Contact link suggestion** notification when available. You'll see a list of suggested contacts to merge.
2. Select the contacts you want to merge.

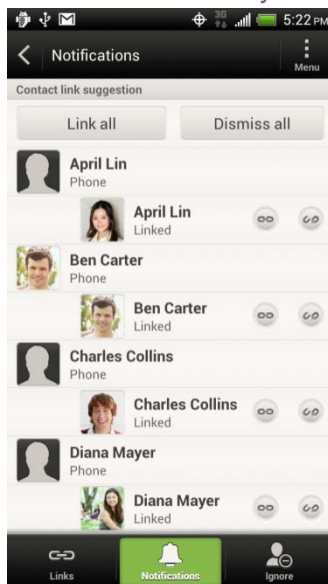



**Note:** If you don't want to receive contact link suggestions, on the People tab, touch **Settings**. Clear the **Suggest contact link** option.

## Manually Merge Entries



You can merge your entries manually and choose the accounts to link the contact.



1. On the People tab, touch the name of the contact (not the icon or photo) you want to link.
2. Touch .
3. You can:
  - Under Suggest links, touch  to link the contact to an account.
  - Under Add contact, touch one of the options to link to another contact.

## *Break the Link*

When contact information has changed, you can choose to break the contact's link from another account

1. On the People tab, touch the name of the contact (not the icon or photo) whose link you want to break.
2. Touch .
3. Under the Linked contacts section, touch  beside an account to break the link.

## *Contact Information and Conversations*

When you touch a contact on the People tab, the Contact details screen opens.

The Contact details screen has the following tabs:

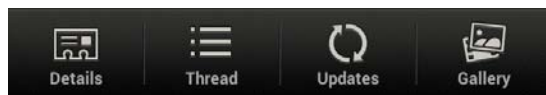

- **Details.** Shows the information you've stored for the contact. Get in touch with the contact by touching an option.
- **Thread.** Shows SMS messages and emails you've received from the contact. It also lists all your incoming, outgoing, and missed calls to and from the contact.
- **Updates.** Shows the contact's updates and events from social network accounts. If you see a notification of the contact's birthday under the Events section, you can touch the notification and choose how you want to greet your contact.
- **Gallery.** Shows the linked contact's albums and photos.

## *Manage People Entries*

Make sure your contacts' information are up to date. You can edit or delete an entry in People.

[Edit a People Entry](#)

[Delete an Entry](#)

[Delete Multiple Entries](#)

## *Edit a People Entry*

You can add another phone number, email address, or assign a photo to a contact in People.

**Note:** Facebook and Twitter™ contacts cannot be edited.

1. On the People tab, touch and hold the contact, and then touch **Edit contact**.
2. Enter the new information.
3. Touch **Save**.

## *Delete an Entry*

Follow these steps to delete an entry in your contacts list.

1. On the People tab, touch and hold the contact, and then touch **Delete contact**.
2. Touch **OK** to confirm.

## *Delete Multiple Entries*

Clean up your contacts list by deleting entries that you no longer need.

1. On the People tab, touch  > **Delete contacts**.
2. Select the entries you want to delete, and then touch **Delete**.
3. Touch **OK** to confirm.

## *Contact Groups*

Assign contacts to groups so you can easily send a message or email to a whole group. You can also sync groups on your phone with the groups in your Google Account, accessible via your computer's web browser. We've also added the Frequent group as a special group type that automatically stores the contacts you dial or get calls from the most.

[Create a Group](#)

[Edit a Contact Group](#)

[Send a Message or Email to a Group](#)



[Rearrange Your Contact Groups](#)

[Delete Groups](#)

## *Create a Group*







Create a group for your sporting buddies or family members so you can easily send them a message or email.

1. Touch  >  > **People**.

2. On the Groups tab, touch .
3. Enter a name for the group.
4. Touch  to select a photo for the group.
5. Touch  > **Add contact to group**.
6. Select the contacts you want to add, and then touch **Save**.
7. When your group is complete, touch **Save**.

## *Edit a Contact Group*



You have full control of your groups. Change the group name, photo, or add and remove group members from the People app.

1. Touch  >  > **People**.
2. On the Groups tab, touch and hold the group, and then touch **Edit group**.
3. You can:
  - Touch the group name to change the name. You can only change the name for groups that you have created.
  - Touch  to change or remove the group photo.
  - Touch  > **Add contact to group** to add more members.
  - To rearrange the group members, touch and hold  at the end of the contact's name, and then drag it to its new position.
  - Touch  beside a contact to remove from the group.
4. Touch **Save**.

## *Send a Message or Email to a Group*

Easily send a message or email to all members of the group.



**Note:** You will be charged for each text message sent. For example, if you send a message to a group of five people, you will be charged for five messages.

1. Touch  >  > **People**.
2. On the Groups tab, touch the group you want to send a message or email to.
3. Go to the Group action tab.
4. Choose if you want to send a text message or email.

## *Rearrange Your Contact Groups*

Put your favorite group at the top of the groups' list.

1. Touch  >  > **People**.

2. On the Groups tab, touch  > **Edit groups**.
3. Touch and hold  at the end of the group to move, and then drag it to its new position.
4. Touch **Save**.

## *Delete Groups*

You can only delete groups that you have created.

On the Groups tab, you can:

- Touch and hold a group you want to delete, and then touch **Delete group**.
- Touch  > **Edit groups** to choose several contact groups to remove.

## *Use People Widgets*

Stay close with the people that matter by adding a people widget for each of your groups and setting the default communication method when you touch the contact from the widget.

[Add a People Widget](#)

[Set the Default Communication Method](#)

[Get in Touch with a Contact](#)

### *Add a People Widget*

Select from several People widget styles that you can add to your Home screen.

1. Touch and hold on an empty space on your Home screen.
2. On the Widgets tab, touch **All Widgets > People**.
3. Choose the widget style, and then drag it to a Home screen thumbnail where you want to add it.
4. Select the group you want to add as a widget.
5. Repeat the above steps to add another People widget.

### *Set the Default Communication Method*

Choose the communication action (for example, call or send a message) when you touch a contact's photo on the People widget.

1. On the Home screen, go to the People widget.
2. Touch a contact's photo on the widget.
3. Touch the communication method you want for the contact.
4. If you need to change the default communication method, touch the contact's name (not the photo), and then touch **Set default action**.



## Get in Touch with a Contact

Use the People widget to get in touch with a contact faster.



1. On the Home screen, go to the People widget.
2. Touch a contact's photo (not the name) on the widget. The default communication method you've set for this contact will be performed.

## Send Contact Information

Quickly share your contact card or People entries on your phone.



1. Touch  >  > **People**.
2. Do any of the following:
  - To send someone's contact information, touch and hold the name of the contact (not the icon or photo), and then touch **Send contact as vCard**.
  - To send your contact information, touch and hold **My profile**, and then touch **Send my profile**.
3. Select how you want to send the vCard.
4. Select the type of information you want to send.
5. Touch **Send**.

### Send Multiple People Entries

1. Touch  >  > **People**.
2. Touch  > **Send contacts**.
3. Select the contacts whose contact information you want to share
4. Touch **Send**.
5. Select how you want to send the contact cards.

### Share All Visible Contacts



You can share all entries that appear in your contacts list, regardless of the online account that your contacts sync with.

1. Touch  >  > **People**.
2. Touch  > **Manage contacts** > **Import/Export contacts** > **Share visible contacts**.
3. Select how you want to send your contacts.

## Back Up and Restore Your Contacts



Make sure you don't lose your contacts by backing them up in your phone's storage.

## Back Up Contacts

1. Touch  >  > **People**.
2. Touch  > **Manage contacts**.
3. Touch **Import/Export contacts** > **Export to phone storage**.
4. Select an account or type of contacts to export, and then touch **OK**.

## Restore Contacts

**Note:** You can only restore contacts that were backed up using the **Export to phone storage** feature.

1. Touch  >  > **People**.
2. Touch  > **Manage contacts**.
3. Touch **Import/Export contacts** > **Import from phone storage**.
4. If you have more than one account set up, touch the type for the imported contacts.

# Accounts and Messaging

---

With Sprint service and your phone's messaging capabilities, you have the opportunity to share information through many different channels and accounts.

[Gmail](#)

[Email](#)

[Text Messaging and MMS](#)

[Social Networking Accounts](#)

## *Gmail*

You will need a Google Account to access several phone features such as Gmail, Google Maps, Google Talk, and Google Play. Before you are able to access Google applications, you must enter your account information. These applications sync between your phone and your online Google Account.

[Create a Google Account](#)

[Sign In to Your Google Account](#)

[View Your Gmail Inbox](#)

[Send a New Gmail Message](#)

[Reply To or Forward an Email Message](#)

[Get Help with Gmail](#)

## *Create a Google Account*

If you do not already have a Google Account, you can create one online or using your phone.

**Note:** You can also create and sign into your Google/Gmail Account through your phone's Setup application.



Although you need a Gmail account to use certain features of your phone, such as Google Play, you do not need to use Gmail as the default account for your phone.

### Create a Google Account Online

1. From a computer, launch a Web browser and navigate to [google.com](http://google.com).
2. On the main page, click **Sign-in > Sign Up**.
3. Follow the onscreen prompts to create your free account.

4. Look for an email from Google in the email box you provided, and respond to the email to confirm and activate your new account.

## Create a Google Account Using Your Phone



1. Open the Notifications panel, and then touch  > **Accounts & sync**.
2. Touch  > **Google > New**.
3. Enter your **First name**, **Last name**, and then touch **Next**.
4. Enter your desired email address, and then touch **Next**.
5. When prompted, enter and re-enter a password, and touch **Next**.
6. Enter a secondary email address to help you recover your password if you ever lose it and then select a security question. Touch **Next**.

**Note:** When setting up a new Google Account, either on your phone or online, you will be prompted to add a secondary email address. Enter a second Gmail address or any other email address from which you currently send and receive email. This address is used to authenticate your account should you ever encounter problems or forget your password. It is strongly encouraged for Android users so you can regain access to Google services and purchases on your phone.

7. Select whether you want to join Google+ or touch **Not now** to proceed.
8. Read the Google Terms of Service, and then touch **I accept**.
9. Enter the characters shown, and then touch **Next**.
10. After your phone connects with the Google servers, select the items you would like to sync with your phone, and then touch **Next**. Your phone will synchronize the selected items.

## Sign In to Your Google Account



If you have a Google Account but have not yet signed in with your phone, follow these instructions to sign in to your Google Account.

1. Open the Notifications panel, and then touch  > **Accounts & sync**.
2. Touch  > **Google > Existing**.
3. Touch **Next**.
4. Enter your Gmail username and password, and then touch **Sign in**.
5. After your phone connects with the Google servers, select the items you would like to sync with your phone and then touch **Next**.

## View Your Gmail Inbox

All your received emails are delivered to your Inbox.



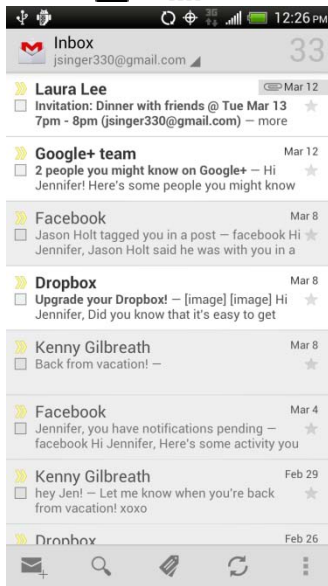

1. Touch  >  > **Gmail**. Your Gmail inbox then opens.





2. You can do the following on your Gmail Inbox:
  - **Archive, delete or label multiple conversations.** Touch the check box before the email or conversation. Then touch the onscreen buttons at the bottom to choose what to do with the selected messages or conversations.
  - **Display drafts, sent messages, and other labels.** Touch **Inbox** at the top left of the screen, and then touch another label (such as **Sent**, **Drafts**, or your created label) to view its messages and conversations.
  - **Switch to your other Gmail Account.** Touch the current account at the top right of the screen, and then touch another account you want to switch to.
  - **Refresh the Inbox.** Touch .



## Send a New Gmail Message

Create and send an email message from your Gmail Account.

1. Touch  >  > **Gmail**.
2. In the inbox of the Gmail account you want to use, touch .
3. Fill in one or more recipients.





**Note:** If you want to send a carbon copy (Cc) or a blind carbon copy (Bcc) of the email to other recipients, touch  > **Add Cc/Bcc**.

1. Enter the email subject, and then compose your email.
2. If you want to attach a photo or video, touch  > **Attach file**.
3. Touch  to send.

**Note:** While composing the message, touch  > **Save draft** to save it as a draft. Or touch  to discard the message.

## *Reply To or Forward an Email Message*

Use your Gmail Account to reply to or forward email messages.

1. Touch  >  > **Gmail**.
2. Touch the email message or conversation.
3. To reply to the sender, touch . Or, touch  and choose whether to **Reply all** or **Forward**.
4. Do one of the following:
  - If you selected **Reply** or **Reply all**, enter your reply message.
  - If you selected **Forward**, specify the message recipients.

**Note:** Touch **Respond inline** if you want to interleave your new message with the received email. However, this removes any attachments or formatting in the original email.

5. Touch  to send.

## *Get Help with Gmail*

To find out more about using Gmail, in the Gmail inbox, touch  > **Help**.

## *Email*

Use the Mail application to send and receive email from your webmail or other accounts, using POP3 or IMAP. You can also access your Exchange ActiveSync email and other features on your phone. Mail allows you to stay connected 24 hours a day anywhere on the Nationwide Sprint Network.

[Add a POP3 or IMAP Email Account](#)

[Add an Exchange ActiveSync Account](#)

[Check Your Mail Inbox](#)

[Send an Email Message](#)

[Save an Email Message in Tasks](#)

[Print Your Email Messages](#)

[Search Email Messages](#)

[Work with Exchange ActiveSync Email](#)

[Manage Email Messages](#)

[Sync Email Less Frequently](#)



[Change the Email Account Settings](#)

[Delete an Email Account](#)

[Add the Mail Widget](#)

## *Add a POP3 or IMAP Email Account*

You can add a POP3 or IMAP email account on your phone and access it using the Mail app.



1. Touch  >  > **Mail**.
2. Do one of the following:
  - If this is your first time to add an email account in Mail, touch **Other (POP3/IMAP)** on the Choose a mail provider screen.
  - If you have already added an email account in Mail, touch  > **New account** > **Other (POP3/IMAP)**.
3. Enter the email address and password for the email account, and then touch **Next**.

**Important:** If you're asked to enter more email settings, ask your email service provider for assistance.

4. Enter the account name and your name, and then touch **Finish setup**.

## *Add an Exchange ActiveSync Account*

If you synchronize your phone with your Exchange ActiveSync account, you can read, manage, and send email in the same easy way as with a POP3/IMAP account. However, you can also access some powerful Exchange features. You can add up to 15 Microsoft Exchange ActiveSync accounts on your phone. You can sync with Microsoft Exchange Server 2003 Service Pack (SP2) or later.

1. Touch  >  > **Mail**.
2. Do one of the following:
  - If this is your first time to add an email account in Mail, touch **Microsoft Exchange ActiveSync** on the Choose a mail provider screen.
  - If you have already added an email account in Mail, touch  > **New account** > **Microsoft Exchange ActiveSync**.
3. Enter the Exchange ActiveSync account details, and then touch **Next**.



**Note:** If your corporate Exchange Server does not support auto-detect, you'll need to enter your Exchange Server settings. Ask your Exchange Server administrator for details.

4. Select the sync options you want and then touch **Next**.
5. Enter the account name, and then touch **Finish setup**.

## Check Your Mail Inbox

When you open the Mail application, it displays the inbox of one of your email accounts that you've set up on your phone.

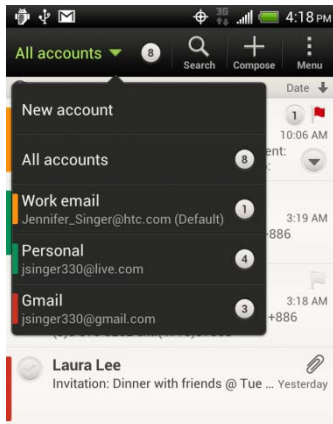

### Switch Between Email Accounts

1. Touch  >  > **Mail**.
2. Touch the bar that shows the current email account, and then touch another account.



### View Email Messages From All Your Email Accounts





You can view email messages from all your accounts just in one place without having to switch to different accounts.

1. Touch  >  > **Mail**.
2. Touch the bar that shows the current email account, and then touch **All accounts**.  
Email messages are color coded so you can easily distinguish which email accounts they belong to.

**Note:** Up to 15 email accounts can be shown in the unified inbox.



### Refresh an Email Account

Whatever your automatic synchronization settings are, you can also synchronize your sent and received email messages manually at any time.

1. Touch  >  > **Mail**.
2. Do any of the following:
  - While in the account you want to synchronize, touch  > **Refresh**.
  - If you have several email accounts, you can refresh them all at the same time. Go to the unified inbox first and touch  > **Refresh**.

## Sort Email Messages



You can sort email messages by date received, priority, subject, sender, or size.

1. Touch  >  > **Mail**.
2. Touch  > **Sort**, and select from the sorting options.

**Tip:** To quickly scroll through the message list based on the sorting option you've selected, touch and hold two fingers on any email message, and then drag upward or downward.

## Send an Email Message

Send an email message to your contacts using an email account in Mail.



1. Touch  >  > **Mail**.
2. Switch to the email account that you want to use.
3. Touch .
4. Fill in one or more recipients.

**Tip:** If you want to send a carbon copy (Cc) or a blind carbon copy (Bcc) of the email to other recipients, touch  > **Show Cc/Bcc**.



5. Enter the subject, and then compose your message.
6. Do any of the following:
  - Add an attachment. Touch **Attach** and then choose what you want to attach.
  - Set the priority for an important message. Touch  > **Set priority**.
7. Touch **Send**, or to send it later, touch **Save as draft**.

**Note:** If there's no Wi-Fi or data connection available or Airplane mode is on when you send your email, the email is saved to the Outbox folder. Once there's Wi-Fi or data connection available, the saved email will be sent automatically next time your phone syncs.

## Resume a Draft Email Message

1. Touch  >  > **Mail**.
2. In an email account inbox, touch  > **Folder** > **Drafts**.
3. Touch the message.
4. When you finish editing the message, touch **Send**.

## Read and Reply to an Email Message

1. Touch  >  > **Mail**.
2. Switch to the email account that you want to use.

3. In the email account inbox, touch the email you want to read.





**Note:** If you want to read a particular message inside an email conversation, touch ▼ to expand the conversation, and then touch the email message.

4. Touch **Reply** or **Reply All**.
5. Touch  for more actions for the email.

## Find Unread Email Messages



Unread email messages display in bold in your inbox. If you're viewing the unified inbox of all your email accounts, color bars also appear next to unread email messages. The color bars also indicate the email account from where the email message is received.

To group all unread email messages, add the Unread tab to your inbox.

1. Touch  >  > **Mail**.
2. Switch to the email account you want to use.
3. In the inbox, touch  > **Edit tabs**.
4. Touch and hold **Unread**, and then drag it to the bottom row to add.
5. Touch  and touch the Unread tab.

## Save an Email Message in Tasks

Save an email message in your Tasks list so you can remind yourself when to reply.



1. Touch  >  > **Mail**.
2. In an email account inbox, touch and hold the email message, and then touch **Save as task**.
3. On the New task screen, enter the task details, and then touch **Save**.

## Print Your Email Messages

Do you need to print your email? Not a problem. Connect your phone to a supported printer and start printing out your email messages.

**Note:** Both printer and your phone must be turned on and connected to the same local network. To learn how to connect the phone to the local wireless network, see [Turn Wi-Fi On and Connect to a Wireless Network](#). To learn how to connect the printer to the local network, refer to your printer user guide.

The local network must not be behind a firewall.

1. Touch  >  > **Mail**.
2. Switch to the email account that you want to use.
3. On the email inbox, touch the email you want to print.

4. Touch  > **Print**.
5. If the printer appears on the list, touch it. Otherwise, touch **Scan for printers** or **Add printer** and then follow the onscreen instructions to add the printer to the list.
6. In the Print preview screen, you can select which pages to print, set the number of copies, or select to fit the email messages on the page.





**Tip:** Touch **Advanced** to set the page size, print layout, and page orientation, and whether you want to print in color or black-and-white.

7. Touch **Print**.

**Tip:** You can check the printing progress by opening the Notifications panel, and then touching the item you're printing.



## Search Email Messages

If you have a long list of email messages on your inbox, you can easily search for that important email.

1. Touch  >  > **Mail**.
2. Touch .
3. If you want to refine or filter your search, touch , check the search options, and then touch **OK**. For example, you can focus the search on a part of an email or filter email messages that have attachments or tagged as high priority.
4. In the search box, enter the words you want to search for.
5. Touch a result to open the email message.

## Search Emails From a Contact

Do you remember the sender, but can't find that particular email?

1. Touch  >  > **Mail**.
2. Switch to the email account you want to use.
3. Touch and hold an email message from a contact.
4. Touch **Search the mail from the sender**. A list of email messages from that contact appears.

## Work with Exchange ActiveSync Email

If you sync your phone with your work Exchange ActiveSync account, you can read, reply, send, and manage email in the same easy way as with a POP3/IMAP account. In addition, you can also use some powerful Exchange features.

## Flag Email Messages

1. Touch  >  > **Mail**.

2. Switch to your Exchange ActiveSync email account.
3. While viewing your Exchange ActiveSync email inbox, touch the white flag icon (🚩) that appears on the right of an email message or conversation. The icon turns red (🚩) after you flagged the email or conversation.

**Tip:** To flag an email message inside a conversation, touch ▼ to expand the conversation, and then touch the flag icon of the email message.

## Set Your Out of Office Status

You can set your Out of Office status and auto-reply message right from your phone.

1. Touch 🏠 > ☰ > **Mail**.
2. Switch to your Exchange ActiveSync email account.
3. Touch ☰ > **Out of the office**.
4. Touch your current office status, and then select **Out of the office**.
5. Set the dates and times for the period when you will be out of the office.

Start:  
Tue, May 1, 2012 2:53 PM

End:  
Sun, May 6, 2012 2:53 PM

Steering our Chicago business from May 1 to 6.  
For account-related inquiries, contact Ben  
Carter @ 913 999 0000. Thank you.

Send auto reply message to external  
recipient

I'm on business travel until May 6. If you need  
to contact me, you may call at 913 888 0000.  
Thank you!

6. Enter the auto-reply message.
7. If you want a different auto-reply message for recipients outside your organization, select the **Send auto reply message to external recipient** option, and then enter the auto-reply message in the box that appears.
8. Touch **Save**.

## Send a Meeting Request



1. Touch 🏠 > ☰ > **Mail**.
2. Switch to your Exchange ActiveSync email account.
3. Touch ☰ > **New meeting invitation**.
4. Enter the meeting details, and then touch **Save**.



## Manage Email Messages

Your email inbox provides management options for sorting and deleting your email messages.



### Move Email Messages to Another Folder

1. Touch  >  > **Mail**.
2. Switch to the email account that you want to use.
3. Select the email messages you want to move.

**Tip:** To select all, select one email message first, and then touch  > **Select all**.

4. Touch **Move to**, and then select a folder.

### Delete Email Messages

1. Touch  >  > **Mail**.
2. Switch to the email account that you want to use.
3. Touch the check buttons of email messages you want to delete.

**Tip:** To select all, select one email message first, and then touch  > **Select all**.





4. Touch **Delete**.

### Switch to Other Mail Folders

1. Touch  >  > **Mail**.
2. In an email account inbox, touch  > **Folder**.
3. Touch the mail folder that contains the email messages you want to view.

## Sync Email Less Frequently



When you don't need to sync email frequently, such as when you're watching video or driving, use Smart Sync to automatically extend the time before your phone syncs your email account. Smart Sync helps you save battery power.

1. Touch  >  > **Mail**.
2. Switch to the email account where you want to use Smart Sync.
3. Touch  > **Settings** > **Sync, Send & Receive**.
4. Touch **Peak time sync** > **Smart Sync**.
5. Touch **Off-peak sync** > **Smart Sync**.
6. Touch .

Smart Sync then extends the email synchronization time after each auto sync time passes and you don't open the Mail app. To sync your email at any time, open the Mail app and check your inbox.

## Change the Email Account Settings



Change your email account settings such as the email account name and password, signature, sync schedule, and more.

1. Touch  >  > **Mail**.
2. Switch to the email account that you want to change.
3. Touch  > **Settings**, and choose from these options:
  - **Account settings:** Change the email account settings such as the name, email address, password, and description.
  - **General settings**
    - **Mail body font size:** Set the font size when reading email messages.
    - **Use signature:** Select to append a signature to your outgoing email messages.
    - **Signature:** Set the signature for outgoing email messages.
    - **Set as default account:** Select to use the current email account as the default account to send email messages.
    - **Attachment cache:** Select where to save email attachments.
    - **Ask before deleting:** Select to display a confirmation box when deleting email messages.
    - **Portrait body preview:** Set the number of lines of text to display for email messages in the inbox.
    - **Show threaded view:** Select to group messages and related replies into threads.
  - **Sync, Send & Receive**
    - **Peak time sync:** Set the synchronization schedule during your set peak time.
    - **Peak time:** Set the time when you receive the most number of email messages.
    - **Off-peak sync:** Set the synchronization schedule during your set off-peak time.
    - **Download past mail:** Set how many days to download past email messages.
    - **Refresh on open:** Select to automatically download email messages when you open an email folder.
    - **Folder to sync:** Select the folder to synchronize whenever you launch Mail.
    - **Mail size limit:** Set the maximum email file size for incoming messages.
    - **Message format:** Set email messages to display in HTML or plain text format.
    - **Include file attachment:** Set the size of email attachments that will be automatically downloaded with email messages.

- **Reply with original text:** Select to reply email messages with the original receive email.
  - **Always bcc me:** Select to always send yourself a copy of all email messages that you send.
  - **Notification settings**
    - **Email notifications:** Select to turn on email notifications on your phone.
    - **Notification sound:** Set the phone to play a sound when a new email message arrives.
    - **Notification vibrate:** Set the phone to vibrate when a new email message arrives.
  - **Delete account:** Touch to delete an email account.
4. Touch < to save your changes.

## Delete an Email Account

Delete an email account from your phone if you want to discontinue using that account.

1. Touch  >  > **Mail**.
2. Switch to the email account that you want to delete.
3. Touch  > **Settings** > **Delete account**.

## Add the Mail Widget

Add the Mail widget to view your POP3/IMAP or Exchange ActiveSync email messages on the Home screen. To learn how to add widgets, see [Customize the Home Screen](#).

## Text Messaging and MMS

Keep in touch with important people in your life. Use the Messages app to compose and send text and multimedia messages. On the All messages screen, your sent and received messages are neatly grouped into conversations, by contact name or phone number.

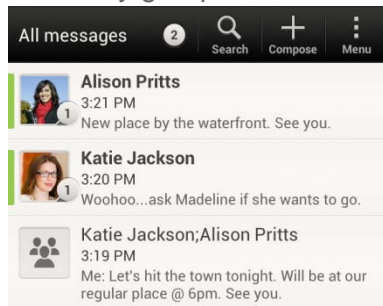

See your service plan for applicable charges for messaging.

### [Send a Text Message \(SMS\)](#)

[Send a Multimedia Message \(MMS\)](#)

[Save and Resume Composing a Draft Message](#)

[Check Your Messages](#)

[Manage Message Conversations](#)



[Back Up and Restore Your Text Messages](#)

[Text and Multimedia Message Options](#)

[Add the Messages Widget](#)

## ***Send a Text Message (SMS)***

Quickly compose and send text messages on your phone.

1. Touch  >  > **Messages**.
2. Touch .
3. Enter a contact name or mobile number in the **To** field.

**Tip:** Sending the message to a group of friends? Touch , and then select the contacts to whom you want to send the message. You can also select contact groups as recipients. When you have selected all the message recipients, touch **Done**.

4. Touch the “Add text” box and then start composing your message.

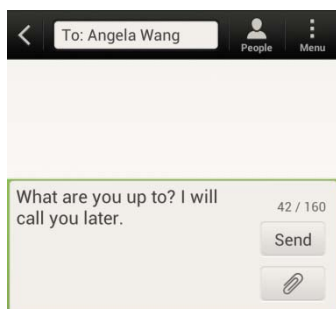







**Note:** A counter appears at the top of the **Send** button to tell you how many characters you have entered and how many characters are left. Once you go over the 160-character limit, a new message is created but automatically joined into one when received.

Your text message automatically becomes a multimedia message if you enter an email address as the recipient, add a message subject, attach an item, or compose a very long message.

5. Touch **Send**, or touch  to save the message as a draft.



## **Use Preset Messages**

Preset messages make it easy to compose text messages.



1. Touch  >  > **Messages**.
2. Touch .
3. Enter a contact name or mobile number in the **To** field.
4. Touch the “Add text” box, and then touch  > **Quick text**. You will see the list of preset messages.
5. Do any of the following:
  - Touch a preset message to enter it to your text message.
  - To add a new preset message, touch  > **Add**. Enter your message and touch **OK**.
  - To edit a preset message, touch  > **Edit**. Touch the message you want to edit, edit the message, and then touch **OK**.
  - To delete preset messages, touch  > **Delete**. Touch the messages you want to delete, and then touch **Delete**.

## *Send a Multimedia Message (MMS)*

When you need to add a little more to a text message, you can send a multimedia message (MMS) with pictures, voice recordings, audio or video files, contact cards (vCard), or appointments (vCalendar).

1. Touch  >  > **Messages**.
2. Touch .
3. Enter a contact name or mobile number in the **To** field.

**Tip:** Sending the message to a group of friends? Touch , and then select the contacts to whom you want to send the message. You can also select contact groups as recipients. When you have selected all the message recipients, touch **Done**.

4. To add a subject line, touch  > **Add subject** to add a subject line to your message.
5. Touch the “Add text” box, and then start composing your message.
6. Touch  and then select the type of attachment:
  - **Picture**. Select **Camera** to take a photo and attach it, or **Gallery** to attach a photo from your storage card.
  - **Video**. Select **Camcorder** to capture a video and attach it, or **Videos** to attach a video from your storage card.
  - **Audio**. Select **Voice Recorder** to make a voice recording and attach it, or **Music & sounds** to attach a music file or voice recording from your storage card.
  - **App recommendation**. Choose an app you’ve installed from Google Play Store that you want to share with others. The URL from which the app can be downloaded will be inserted to your message.

- **Location.** Add your current location (requires GPS to be turned on), or a location you pick on a map to your message. See [Google Maps](#).
  - **Contact (vCard).** Select a contact from your phone, and then select which contact information you want to attach.
  - **Appointment (vCalendar).** Select the calendar event you want to attach.
7. To see options for replacing or reviewing your attachment, touch . You can also touch > **Discard** to start over.
  8. Touch **Send**, or touch to save message as a draft.

## Create a Slideshow

You can create an MMS message with multiple slides, each containing a photo, video, or audio, and text.



1. Touch > > **Messages**.
2. Touch .
3. Enter a contact name or mobile number in the **To** field.

**Tip:** Sending the message to a group of friends? Touch , and then select the contacts to whom you want to send the message. You can also select contact groups as recipients. When you have selected all the message recipients, touch **Done**.

4. To add a subject line, touch > **Add subject**.
5. Touch the “Add text” box, and then start composing your message.
6. Touch and then attach a photo, video, or audio in the multimedia message you’re composing
7. Touch > **Slide**.
8. Choose where you want to insert the next slide.
9. Right after adding a slide, do any of the following:
  - Touch , and then choose to add a photo or a video.
  - Touch > **Audio** to add music or a voice recording to a slide.
  - Touch **Add text**, and then enter your caption.
  - Touch to see options for replacing, viewing or removing your attachment.
  - Touch > **Preview**. Touch once on the preview screen to see playback controls.
10. When finished, touch **Send**, or touch to save the message as a draft.

## Save and Resume Composing a Draft Message

While composing a text or multimedia message, touch  to automatically save your message as a draft. You can resume composing a draft message.



1. Touch  >  > **Messages**.
2. On the All messages screen, touch  > **Drafts**.
3. Touch the message, and then resume editing it.
4. Touch **Send**.

## Check Your Messages

Depending on your notification settings, the phone plays a ringtone, vibrates, or displays the message briefly in the status bar when you receive a new text or multimedia message. To change the notification for new text and multimedia messages, see [Text and Multimedia Message Options](#).



A new message icon (  ) also appears in the status bar.

1. To open and read the message, you can:
  - Open the Notifications panel, and then touch the new message to open and read it.
  - Touch  >  > **Messages**, and then touch the message.
2. While reading the message, you can:
  - **Reply with a text message.** Touch the “Add text” box, enter your reply message, and then touch **Send**.
  - **Reply with a multimedia message.** Touch the “Add text” box, enter your reply message, touch  to choose an attachment for your message, and then touch **Send**.
  - **Call or save a phone number contained in the message.** Touch the phone number, and then choose whether to dial the number or add it to your contacts.
  - **Open a link in the message.** Touch the link to open it in the Web browser.
  - **Send to or save an email address contained in the message.** Touch the email address. Then choose whether to send an email, send a multimedia message, or save the email address to your contacts.

- **Forward a message.** Touch the message (do not touch a link or a phone number) to open the options menu, and then touch **Forward**.
- **Check message details.** Touch the message (do not touch a link or a phone number) to open the options menu, and then touch **View message details**.

## View and Save an Attachment from a Multimedia Message



If you are concerned about the size of your data downloads, check the multimedia message size first before you download it.

**Note:** When **Auto-retrieve** in MMS settings is disabled, only the message header is downloaded. To download the entire message, touch the **Download** button at the right side of the message. For details, see [Text and Multimedia Message Options](#).

- If there's a media attachment such as a photo or video in a received message, touch it to view the content.
- To save the attachment, touch and hold the multimedia message, and then choose to save the type of attachment from the options menu.
- If the attachment is a contact (vCard), touch it to view the contact information, and then touch **Save** to add to your contacts.
- If the attachment is an appointment or event (vCalendar), touch it to choose the calendar where to save it, and then touch **Import**.



## Save a Text Message as a Task

Save a text message in your Tasks list so you can remind yourself when to reply.

1. Touch  >  > **Messages**.
2. On the All messages screen, touch a contact (or phone number) to display the exchange of messages with that contact.
3. Touch the message you want to save, and then touch **Save as task**.
4. Enter a task title and other details.
5. Touch **Save**.

## Reply to an Alternate Contact Phone Number

When a contact has multiple phone numbers stored on your phone, you'll see the particular phone number used below the contact's name. Keep in mind that your response will be sent to the phone number of the latest message you've received from this contact.

1. Touch  >  > **Messages**.
2. On the All messages screen, touch a contact (or phone number) to display the exchange of messages with that contact.



3. Touch ▼, and then select another phone number of this contact.

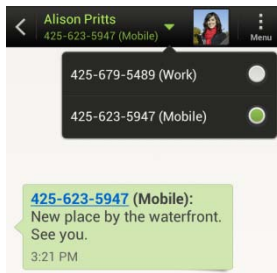



4. Touch the “Add text” box, and then enter your reply message.
5. Touch **Send**.

## Manage Message Conversations



Text and multimedia messages that are sent to and received from a contact (or a number) are grouped into conversations or message threads in the All messages screen. Threaded text or multimedia messages let you see exchanged messages (similar to a chat program) with a contact on the screen.

### Protect a Message from Deletion

You can lock a message so that it will not be deleted even if you delete the other messages in the conversation.

1. Touch  >  > **Messages**.
2. On the All messages screen, touch a contact (or phone number) to display the exchange of messages with that contact.
3. Touch the message (not a link or a phone number) that you want to lock, and then touch **Lock message**. A lock icon  is displayed at the lower right of the message.

### Delete a Single Message

1. Touch  >  > **Messages**.
2. On the All messages screen, touch a contact (or phone number) to display the exchange of messages with that contact.
3. Touch the message (not a link or a phone number) that you want to delete.
4. If the message is locked, touch **Unlock message** on the options menu, and then touch the message again to display the options menu.
5. Touch **Delete message** on the options menu.
6. When prompted to confirm, touch **OK**.

### Delete Several Messages Within a Conversation



1. Touch  >  > **Messages**.

2. On the All messages screen, touch a contact (or phone number) to display the exchange of messages with that contact.
3. Touch  > **Delete** > **Delete by selection**.



**Note:** You can also touch **Delete by phone number** if the contact used multiple phone numbers throughout the conversation and you want to delete the messages sent from a particular number.

4. Select the messages you want to delete, and then touch **Delete**.

## Delete a Conversation

1. Touch  >  > **Messages**.
2. Do any of the following:
  - On the All messages screen, touch and hold a contact (or phone number) whose messages you want to delete, and then touch **Delete**.
  - While looking at the exchange of messages in a conversation, touch  > **Delete** > **Delete thread**. Any locked messages in the conversation thread will not be deleted unless you select the **Delete locked messages** check box.
3. When prompted to confirm, touch **OK** to delete the entire thread.



## Delete Several Conversations

1. Touch  >  > **Messages**.
2. On the All messages screen, touch  > **Delete**.
3. Select the conversation threads you want to delete.
4. Touch **Delete**. Any locked messages will not be deleted.

## *Back Up and Restore Your Text Messages*



Back up important text messages to your phone's storage or to your email account.

### Back Up Text Messages

1. Touch  >  > **Messages**.
2. On the All messages screen, touch  > **Back up SMS** > **Back up SMS**.
3. Enter a name for your backup file, and then touch OK.

### Back Up Text Messages Using Mail

**Important:** You need to set up your email account in Mail.



1. Touch  >  > **Messages**.
2. On the All messages screen, touch  > **Back up SMS** > **Back up SMS via mail**.  
The Mail application's compose screen opens, with the backup file attached.

3. Enter your email address.
4. Compose your email message, and then touch **Send**.

To restore your text messages on your phone, open the email message with the backup file attachment from the Mail application. Touch the attachment to open the Restore SMS screen and then touch the backup file to restore your text messages.



## Restore Text Messages

You can only restore text messages that were exported using the Back up SMS feature.

1. Touch  >  > **Messages**.
2. On the All messages screen, touch  > **Back up SMS** > **Restore SMS**.
3. Touch the backup file to import.
4. Touch **OK**.

## *Text and Multimedia Message Options*

You can set how your phone notifies you when you receive a new text or multimedia message, or set other messaging options.

1. Touch  >  > **Messages**.
2. On the All messages screen, touch  > **Settings**. You can set the following options:
  - **Notifications: Received messages**
    - **Received notification:** Select this option if you want to receive a notification in the status bar when a new text or multimedia message arrives.
    - **Play notification sound:** If you want the phone to ring when a new message arrives, select this option.
    - **Notification sound:** Select a ringtone that is specific to new text and multimedia messages. Note that the ringtone briefly plays when selected.
    - **Vibrate:** Select this option if you want the phone to vibrate when a new text or multimedia message arrives.
    - **Notification preview:** Select to display the sender and message preview on the lock screen and status bar.
  - **Notifications: Sent messages**
    - **Sent notification:** Select this option if you want to receive a notification in the status bar when a message is sent successfully.
    - **Failure notification:** Select this option if you want to receive a notification in the status bar when a message is not sent successfully.

- **Play notification sound:** If you want the phone to ring when a sent or failure notification is received, select this option.
- **Notification sound:** Select a ringtone that is specific to sent or failure notifications. Note that the ringtone briefly plays when selected.
- **Vibrate:** Select this option if you want the phone to vibrate when a new text or multimedia message arrives.
- **Display message on screen:** Set your phone to show pop-up notifications (not just in the status bar) when your messages are sent successfully or not. You can also select **None** to disable this option.
- **Text messages (SMS) Settings**
  - **SMS characters:** Select this option to correctly display special accented characters in SMS messages.
- **Multimedia messages (MMS) Settings**
  - **Auto-retrieve:** Select this option to automatically retrieve all your multimedia messages completely. When selected, the multimedia message header plus the message body and attachments will automatically download to your phone. If you clear this check box, only the multimedia message header will be retrieved and shown in your All messages screen.
  - **Roaming auto-retrieve:** Automatically retrieve all your messages completely when roaming. This may incur significant phone charges.
  - **Maximum message size:** Set the maximum file size of a multimedia message. The multimedia message will not be sent out if it exceeds the file size set here.
  - **Attachment storage:** Select the storage where you want to save multimedia message attachments.
  - **Connection settings:** View various connection settings such as the connection name and server address.
- **General: Recipient list settings**
  - **Show sent message history:** Include the sent message history when searching for a message recipient.
  - **Show call history:** Include the Call history when searching for a message recipient.
  - **Show email address:** Include email addresses when searching for a message recipient.
- **General: Message preview**
  - **Message preview:** Set the number of lines of text to appear in the conversation on the All messages screen.
- **General: Storage settings**

- **Delete old messages:** Automatically delete older messages, except for locked messages, when the set limits are reached.
- **Text message limit:** Choose the maximum number of text messages to store in each conversation thread. (This does not include locked messages.)
- **Multimedia message limit:** Choose the maximum number of MMS messages to store in each conversation thread. (This does not include locked messages.)
- **General: Signature**
  - **Use signature:** Select this option to add a signature to all your outgoing text and multimedia messages.
  - **Signature:** Touch to compose your own signature.
- **General: Message forwarding**

**Note:** Forwarding service may incur additional charges. Contact Sprint for details.

- **Forward to phone number:** Lets you forward text and multimedia messages to another phone.
- **Forward to email address:** Lets you forward text and multimedia messages to an email address.
- **Emergency alerts**
  - Set up how you want your phone to receive emergency alerts.

## *Add the Messages Widget*

Add the Messages widget so you can read your messages right on the Home screen. To learn how to add widgets, see [Customize the Home Screen](#).

## *Social Networking Accounts*

Stay in touch on the go with all your social networking accounts. Post updates on Facebook, and Twitter, chat on Google Talk, see what everyone's talking about from YouTube, and more.

[Facebook](#)

[Twitter for HTC Sense](#)

[Friend Stream](#)

[Google+](#)

[YouTube](#)

[Google Talk](#)

## Facebook

Signing in to your Facebook account from the Accounts & sync settings or the Facebook app automatically signs you in to Facebook for HTC Sense. Also, you may need to authorize Facebook for HTC Sense to connect to your Facebook account.

With Facebook, you can:

- See your Facebook contacts and their status updates in People.
- See Facebook photos in Gallery.
- Check your friends' Facebook status updates in Friend Stream.

## Twitter for HTC Sense

When you're signed in to Twitter for HTC Sense, you can see your Twitter contacts and their latest tweets in People. You can also send tweets and check your friends' tweets in Friend Stream.

**Note:** If you have the Twitter app (preinstalled or downloaded from Google Play), signing in to Twitter for HTC Sense does not sign you in to the Twitter app and vice versa. If you want to use the same Twitter account for both, you'll have to sign in to both using the same login info.

## Friend Stream

With Friend Stream, you can share and get updates from friends in popular social networks in a single feed.

### Add the Friend Stream Widget

1. Touch and hold on an empty space on your Home screen.
2. On the Widgets tab, touch **All Widgets > Friend Stream**.
3. Touch the Friend Stream widget style you like and it gets added to the Home screen you've selected.

### Get Started with Friend Stream

1. From the Home screen, navigate to the Friend Stream widget and touch **>**.
2. Touch someone's status update to:
  - Write a comment.
  - Look at their album photos.
  - View the tweet. If there's a Web link shared, you'll also see the posted Web page right below the tweet.
3. Touch someone's photo or name to:
  - Check the person's profile details.

- Check the person's posted tweets.
- 4. Touch ▼ to display posts from a particular social network.
- 5. Slide to the other tabs to see more options. You can touch ≡ > **Edit tabs** to customize the Friend Stream tabs.

## Update Your Status

You can use Friend Stream to update your status on one or on all social network accounts you are signed in to.

1. From the Home screen, navigate to the Friend Stream widget and touch >.
2. Touch +.
3. Enter your status update.
4. If you do not want to send the status update to all your social network accounts, touch ≡, and then clear the social networks to exclude.
5. Touch **Done**.
6. Touch 📎 and then choose what you want to attach to your tweet or status update.
7. Touch **Post**.

## Post a Message on a Friend's Facebook Wall

1. From the Home screen, navigate to the Friend Stream widget and touch >.
2. Touch ▼ > **Facebook**.
3. Touch + > **My wall**.
4. Touch a friend from the list.
5. Enter your message.
6. Touch **Post**.



## Comment on and Like Facebook Posts

Touch someone's status update on the All tab, and do any of the following:





- Touch a photo or the album name shown in the status update to view and comment on the album photos using the Gallery app.
- Touch **Like** to like the person's status update.
- Touch the text box, and then enter what you think about the person's status update.

## Check In to a Place





Let your Facebook friends know where you are by checking in to a place. In order to find your location, you need to enable location sources in ⚙️ (**Settings**) > **Location**.

1. From the Home screen, navigate to the Friend Stream widget and touch .
2. Go to the Locations tab, and then touch .
3. Touch a place from the list.
4. Touch **Check in**.
5. Add your status message and even tag the friends you're with.
6. Touch **Check in**.



### Tweet in Friend Stream

1. From the Home screen, navigate to the Friend Stream widget and touch .
2. Touch  > **Twitter for HTC Sense**.
3. Touch .
4. Enter your tweet.
5. Touch  or  to add a picture or your current location to your tweet.
6. Touch **Post**.

### Search for Twitter Users to Follow

1. From the Home screen, navigate to the Friend Stream widget and touch .
2. Touch  > **Twitter for HTC Sense**.
3. On any of the tabs, touch .
4. Enter a Twitter name in the search box.
5. Touch .
6. In the search results, touch the Twitter user you want to follow.
7. Touch  > **Follow**.

To unfollow a Twitter user:

1. From the Home screen, navigate to the Friend Stream widget and touch .
2. Touch  > **Twitter for HTC Sense**.
3. On the All tweets tab, touch the Twitter user you want to stop following.
4. Touch  > **Unfollow**.

### Send a Direct Message

You can only send a direct message (DM) to someone who is following you.

1. From the Home screen, navigate to the Friend Stream widget and touch .



2. Touch ▼ > **Twitter for HTC Sense**.
3. On the DMs tab, touch +.
4. Enter the name of a Twitter user in the **To** field.
5. Enter your message, and then touch **Post**.



You can also send a direct message when you touch and hold a tweet of the person you want to send the direct message to, and then touch **Send direct message** on the options menu.

### Reply To or Retweet a Tweet

1. From the Home screen, navigate to the Friend Stream widget and touch >.
2. Touch ▼ > **Twitter for HTC Sense**.
3. On the All tweets tab, touch and hold the tweet you want to reply to or retweet.
4. Touch **Reply** or **Retweet**.
5. Enter your reply or add a personal note to the tweet.
6. Touch **Post**.

## Google+

With Google+ you can check your friends' updates, post updates of your own, and chat with friends in your Google+ circles.



- To open Google+, touch  >  > **Google+**.
- To learn what you can do and get help in Google+, touch  > **Help**.

## YouTube

YouTube is an online video streaming service that allows you to view and upload videos.

**Note:** You do not need a YouTube account to browse and view videos. However, to use all the features of YouTube (such as sharing a video you've captured), you must create a YouTube account from your computer and sign in to that account from your phone.

### Watch Videos in YouTube

1. Touch  >  > **YouTube**. (You may need to scroll right the screen to see the icon.)
2. Scroll through the list of videos, and then touch a video to watch it.
3. While watching a video, you can:

- Touch the video screen to pause, resume playback, or drag the slider to jump to a different part of the video.





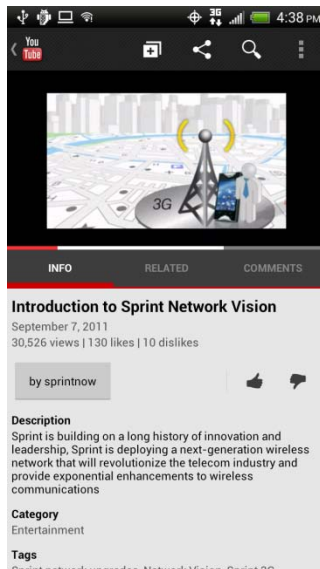

- Touch a tab to learn more about the video, see related videos, or check out what other viewers think. You can also slide your finger across the tabs to see if there are more items available.





4. Touch the YouTube icon to return to the main screen.

## Search for Videos



1. Touch  >  > **YouTube**.
2. Touch .
3. Enter a search keyword, and then touch  on the onscreen keyboard.
4. Scroll through the results and touch a video to watch it.

**Tip:** You also have the option to show results that were just recently posted. Touch **All time**, and then select a time period you want.







### Clear the Search History

1. Touch  >  > **YouTube**.
2. Touch  > **Settings**.
3. Touch **Search settings** > **Clear search history**.

### Share a Video Link

1. Touch  >  > **YouTube**.
2. Touch a video or search for a video and then touch it.
3. Touch .
4. Choose how you want to share the video link from the available options.

### Capture and Share Videos on YouTube

1. Touch  >  > **YouTube**.
2. On the YouTube main screen, touch .
3. Touch  to start capturing video.
4. When you're finished capturing, touch , and then touch .
5. If you've set up multiple Google Accounts on your phone, you'll be asked which account you would like to use.
6. Enter a title and description for your video, set the privacy level, and add tags or location information.
7. Touch **Upload**.



## Google Talk

Google Talk is Google's instant messaging program. It lets you communicate with other people that also use Google Talk. If you signed in to your Google Account when you first set up your phone, you are already signed in to Google Talk.

### Start a Chat

1. Touch  >  > **Talk**. The Friends list appears.

**Tip:** The Friends list is where you add and manage your friends in Google Talk.

2. Touch a friend in the Friends list.
3. Enter your message, and then touch  to send.
4. While chatting, touch  for more options.

## Get Help About Google Talk

1. Touch  >  > **Talk**.
2. Touch  > **Help**.

# Applications and Entertainment

---

[Google Play](#)

[Navigation](#)

[Music](#)

[Sprint TV & Movies](#)

[NASCAR Sprint Cup Mobile](#)

[HTC Watch](#)

## Google Play

Google Play is the place to go to find new apps for your phone. Choose from a wide variety of free and paid apps ranging from productivity apps, entertainment, to games. When you find an app you want, you can easily download and install it on your phone.

**Note:** A Google Wallet™ payment service is required to purchase a paid app. You will be asked to confirm method of payment when you purchase an app.

**Important:** Sprint's policies often do not apply to third-party applications. Third-party applications may access your personal information or require Sprint to disclose your customer information to the third-party application provider. To find out how a third-party application will collect, access, use, or disclose your personal information, check the application provider's policies, which can usually be found on their website. If you aren't comfortable with the third-party application's policies, don't use the application.

[Find and Install an Application](#)



[Uninstall an Application](#)

[Create a Google Wallet Account](#)

[Get Help with Google Play](#)

## Find and Install an Application

When you install apps from Google Play and use them on your phone, they may require access to your personal information (such as your location, contact data, and more) or access to certain functions or settings of your phone. Download and install only apps that you trust.

1. Touch  >  > **Play Store**.
2. When you open Google Play for the first time, the Terms of Service window will appear. Touch **Accept** to continue.



3. Browse or search for an app.
4. When you find the app that you like, touch it and read its description and user reviews.
5. To download or purchase the app, touch **Download** (for free apps) or the price button (for paid apps).
6. Touch **Accept & download** or **Accept & buy**.

To open the app, touch  > . On the All apps screen, touch the app.

## *Uninstall an Application*

You can uninstall any application that you have downloaded and installed from Google Play.

**Note:** You can uninstall an app for a refund within a limited time after your purchase. To know more about the refund policy for paid apps, please visit the Google Play help site ([market.android.com/support](http://market.android.com/support)).

1. Touch  >  > **Play Store**.
2. Touch  > **My Apps**.
3. Touch the application you want to uninstall, and then touch **Uninstall**.
4. When prompted, touch **OK**.

## *Create a Google Wallet Account*

You must have a Google Wallet account associated with your Google Account to purchase items from Google Play.

- ▶ Do one of the following:
  - On your computer, go to [google.com/wallet](http://google.com/wallet) to create a Google Wallet account.
  - The first time you use your phone to buy an item from Google Play, you're prompted to enter your billing information to set up a Google Wallet account.

**Warning:** When you've used Google Wallet once to purchase an application from Google Play, the phone remembers your password, so you don't need to enter it the next time. For this reason, you should secure your phone to prevent others from using it without your permission. (For more information, see [Security](#).)

## *Get Help with Google Play*

If you need help or have questions about Google Play, touch  > **Help** while in the Google Play Store app. The Web browser will take you to the Google Play help site.

## *Navigation*

Your phone offers a number of location-based navigation programs to help you figure out where you are and get you where you're going.

[HTC Car](#)

[Google Maps](#)

[Google Latitude](#)

[Telenav GPS Navigation](#)

## HTC Car

While you drive, you can easily use your phone to reach your destination, keep you entertained, and help you stay in touch with people that matters to you. Get easy access to music, maps, navigation, and phone calls with HTC Car.

HTC Car instantly launches when you mount your phone in the HTC Car Kit or connect to your specified Bluetooth phone.



- Swipe left or right to go to the other panels such as **Music** or **Phone**.
- Touch a shortcut to do something right away. For example, touching **Music** immediately plays the last song you were listening to.
- When you navigated away from the main panel, return to the main panel by touching .

### Play Music in HTC Car

1. On the HTC Car main panel, swipe left until the Music panel displays.
2. Slide up from the bottom of the screen. You can then browse music by category or search your collection.
3. Touch an album, song, or playlist to listen to it.
4. Next time you want to play the same music, you can:
  - Touch **Music** on the main panel.

- Swipe back to the Music panel and touch any of the recent albums.

**Tip:** When your phone is connected to a Bluetooth media phone, you can change the sound profile. On the Now playing screen, touch  and then touch the profile you want.

## Listen to Internet Radio in HTC Car

HTC Car provides access to Internet radio stations for your listening pleasure.

1. On the HTC Car main panel, swipe left until the Internet Radio panel displays.
2. Slide up from the bottom of the screen, and:
  - Browse for available stations by category.
  - Touch  to enter and search for stations by keyword such as artist name or topic.
3. Touch a station to start listening to it.
4. Next time you want to tune into the same station, you can:
  - Touch **Internet Radio** on the main panel.
  - Swipe back to the Internet Radio panel and touch any of the recent stations.

## Find Your Location with HTC Car

HTC Car helps you to find your way to where you want to go. Easily access maps and find out your current location. Find nearby attractions on your weekends. HTC Car gives you the information you need so you won't get lost.

To find out your current location:

1. On the HTC Car main panel, swipe right until the Navigation panel displays.
2. Touch  to see the map.
3. Zoom and move around the map.

To explore what's near your current location:



1. On the HTC Car main panel, swipe right until the Navigation panel displays.
2. Touch .
3. Touch a location category or enter your own search.

## Get Directions in HTC Car

By default, HTC Car uses Google Maps™ as the navigation application.

1. On the HTC Car main panel, swipe right until the Navigation panel displays.
2. You can:
  - Search for a new place: Touch .



- Look up a previously searched place: Touch .
  - Get directions for an upcoming event in Calendar: Touch .
3. Touch an item to see the beginning and end points on the map.
  4. Touch **Start navigation** to get the directions.

## Stay Connected with HTC Car

Just because you're driving doesn't mean you have to be isolated from the rest of the world. With HTC Car, you can take calls, make calls, and get notifications.

To answer or reject an incoming call:

- ▶ Swipe right to answer.
- ▶ Swipe left to decline.

To make phone calls:

1. On the main panel, touch **Phone**.
2. Do any of the following:
  - Dial the number, and then touch **Call**.
  - Flick your finger on the phonebook, and then touch a contact to call.

## Change the HTC Car Settings

Choose your default Bluetooth accessories, set HTC Car to launch automatically, and more. On the main panel, touch the status icons below the clock.

## Close HTC Car

- When your phone detects that the HTC Car Kit or the specified Bluetooth phone is no longer connected, HTC Car will automatically exit.
- From the HTC Car main panel, touch  and then touch **OK**.

## Google Maps







Google Maps lets you track your current location, view real-time traffic situations, and receive detailed directions to your destination. It also provides a search tool where you can locate places of interest or an address on a map, or view locations at street level.

**Note:** To find your location with Google Maps, you need to enable location sources. To learn how, see [Location Settings](#).

The Google Maps application does not cover every country or city.





## Get Around Maps

When you open Google Maps, you can easily find your location on the map or check out nearby places by panning and zooming in and out on the map.

1. Touch  >  > **Maps**.
2. Touch  to show your current location. The blue arrow  or dot  shows your location on the map.
3. Touch  to turn Compass mode on or off. In Compass mode, the map changes to an angled view and automatically orients itself depending on the direction you're facing.

## Search for a Location

In Google Maps, you can search for a location, such as an address or a type of business or establishment (for example, museums).

1. Touch  >  > **Maps**.
2. Touch .
3. Enter the place you want to search in the search box.
4. Touch  to search for the location you entered or touch a suggested search item. The search results are displayed as markers on the map.
5. Do either of the following:
  - Touch a marker () to see if that is what you're looking for, and then touch the balloon if it is.
  - Touch **Results list**, and then touch the location. Details about the selected location display on the screen.

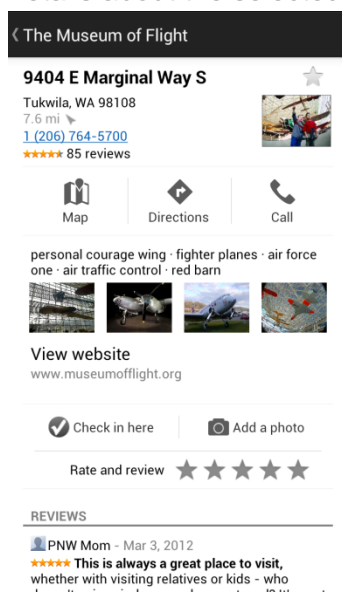

6. Touch the onscreen buttons to view the location on a map, get directions, view the location in Street View (if available), and more. Scroll down the screen to view more options.



### Check the Location Details

1. Touch and hold a location on the map. A balloon opens over the location, with the name of the location, a part of the address, and a thumbnail from Street View (if available).
2. Touch the balloon to see more information. You can get directions to the location, check for nearby places of interest, and more.

### Search a Place of Interest Near You





Use Places to find places of interest near your current location. Places uses Google Maps to search common places that you would want to find, such as the nearest gas station or ATM kiosk.

**Note:** Before you use Places, you need to enable location sources. See [Location Settings](#) to learn how.

1. Touch  >  > **Places**.
2. Touch the type of place you want to search.
3. Do any of the following:
  - When one or two places of interest are found, the search results are displayed as markers on the map. You can touch the marker, and then touch the balloon to view more information about the place.
  - When several places are found, the search results display in a list. Touch a place to view more information about the place.

### Adding a Place to Search



In Places, you can add other places of interest that you frequently search for, such as a church or a pizza restaurant.

1. Touch  >  > **Places**.
2. Touch  > **Add a search**.
3. Enter the place you want to add to Places' search items, and then touch . The place is added as a button on the Places screen.

### Get Directions

Get detailed directions to your destination. Google Maps can provide directions for travel by foot, public transportation, or car.

1. Touch  >  > **Maps**.

2. While viewing a map, touch .
3. Do any of the following:
  - Use your current location as the starting point, or enter a location from where to start in the first text box. Then enter your destination in the second text box.
  - Touch  to select an address from your contacts or a point that you touch on a map.

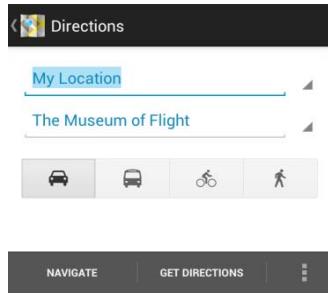

**Note:** If the place you've set as your destination has several locations available, select which one to go to.

4. Choose how you want to get to your destination by touching the car, public transit, bicycle, or walk button.
5. Touch **Get directions**.
6. Touch **Directions list** to view the directions. You can also touch the arrow buttons on the map to follow the directions.

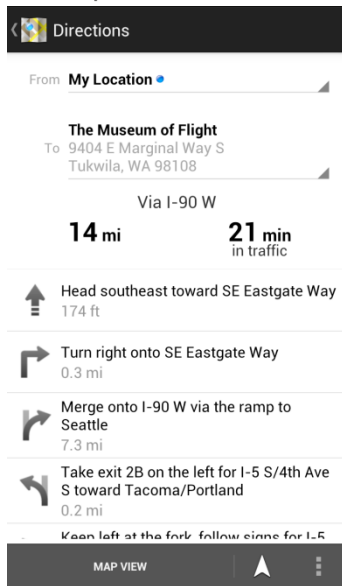

When you're finished viewing or following the directions, touch  to reset the map. Your destination is automatically saved in the Google Maps history.

## Clear the Map

After you've searched on a map or got directions, you can clear any markers you may have drawn on it.

- ▶ Touch  > **Clear Map**.

## Get Help with Google Maps









Get help and more information about Maps. Touch  > **Help**. The Web browser opens and takes you to the Google Maps help site.

## Google Latitude

Google Latitude<sup>®</sup> user location service lets you and your friends share locations and status messages with each other. It also lets you send text and email messages, make phone calls, and get directions to your friends' locations.

Your location is not shared automatically. You must join Latitude, and then invite your friends to view your location or accept their invitations. Only friends that you have explicitly invited or accepted can see your location.

## Open and Join Latitude

1. Touch  >  > **Maps**.
2. While viewing a map, touch  > **Join Latitude**.
3. After you've joined Latitude and closed the application, do one of the following to open it:
  - Touch  >  > **Latitude**.
  - Touch  >  > **Maps**, and then touch  > **Latitude**.

## Get Help with Latitude

Get help and more information about Maps and Latitude. Touch  > **Help**. The Web browser opens and takes you to the Google Maps help site.



## Telenav GPS Navigation

TeleNav GPS Navigator™ gives you turn-by-turn directions onscreen and over the speakerphone.

**Note:** Depending on your service plan, TeleNav GPS Navigator may require a monthly subscription. Contact Sprint for information and pricing.



## Register TeleNav GPS Navigator

Before you can use TeleNav GPS Navigator, your phone and service must be registered.

1. Touch  >  > **Sprint Zone** > **Sprint Suggests**.
2. Touch **TeleNav GPS Navigator** to download and install the app.
3. Follow the onscreen instructions to install and register your phone.

## Use TeleNav GPS Navigator

With Telenav GPS Navigator, you can drive to a location, search what's nearby, check the traffic and more.

1. Touch  >  > **TeleNav GPS Navigator**.
2. Select an option and follow the onscreen instructions to get directions, view maps, or access additional services and options.
  - **Drive To** lets you enter an address (by either speaking it or by entering it on the keypad) or select from categories such as My Favorites, Recent Places, or Businesses to search for turn-by-turn directions.
  - **Maps** lets you view maps and get traffic information for your current location or for any other location (same categories as Drive To).
  - **Places** provides a categorized list of locations such as Gas Stations, Grocery Stores, and Hospitals to help find local businesses and services.
  - **Extras** provides ways to customize your TeleNav GPS app.

## Music

Your phone lets you discover, download, and listen to your favorite music through a variety of applications.

**Note:** You need to copy music files to your storage card first to use the Music application to play music. To find out how to copy files to the storage card, see [microSD Card](#).

[Browse for Music](#)

[Listen to Music](#)

[Make Your Music Sound Better](#)

[Find Music Videos on YouTube](#)

[Update Album Covers](#)

[Playlists](#)

[Music and Ringtones](#)



[Share Music Using Bluetooth](#)

[Use the Music Widget](#)

[FM Radio](#)

## Browse for Music

You'll find music on your phone grouped into categories for easy search and play.





1. Touch  >  > **Music** > **My phone**.
2. Touch  to browse a category, such as **Artists** or **Albums**.

## *Listen to Music*

Enjoy your favorite songs on your phone using the Music application.

1. While browsing your Music library, touch a song to play it.
2. Touch the onscreen icons to control music playback, repeat songs and more.



- Touch and drag your finger across the progress bar  to jump to any part of the song.
- Touch  to show options for adding the song to a playlist, sharing the song, and more.
- Touch  to turn shuffle on or off. (Shuffle is off when button is gray.)
- Touch  to cycle through the repeat modes: repeat all songs, repeat current song, and don't repeat.

**Note:** Press the volume up or down button to adjust the playback volume.

## Play Music from the Lock Screen

When you are playing music and the screen turns off, you can control the music playback right from the lock screen when you wake up the phone by pressing .

If you don't see the playback controls on the Lock screen, swipe your finger from left to right on the screen.



**Note:** You can also pause music playback right from the Notifications panel.





## *Make Your Music Sound Better*

When you plug in your headset, you can choose to enjoy your music with a variety of enhanced sound profiles.

1. Open the Notifications panel, and then touch .
2. Touch **Sound > Sound enhancer**.
3. Select a sound profile. The sound profile will be immediately applied.

## *Find Music Videos on YouTube*

You can find music videos of the song you're listening to on YouTube.

1. Touch  >  > **Music > My phone**.
2. Touch  to browse for a song, and then touch it to play.
3. Touch  > **Search > YouTube**.

## *Update Album Covers*

You can update an album cover, if available.

1. While you're playing music, touch  > **Update album art**.
2. Choose whether to automatically or manually update all album covers or update just the current song on the Now playing screen.





## Playlists

Personalize your music experience by creating music playlists. Make a playlist containing just your favorite songs or create one to match your mood for the day.

### Create Playlists

You can make as many playlists as you like on your phone.



1. Touch  >  > **Music** > **My phone**.
2. Start playing a song that you want to add to a new playlist.
3. Touch  > **Add to playlist**.

**Note:** If you don't have any playlists, you will be asked to enter a new playlist name.

1. On the Select playlist screen, touch .
2. Enter a playlist name.
3. Touch **Save**.

**Tip:** You can also add additional songs while creating a new playlist. Touch  > **Add songs** to add more songs.





### Play the Songs in a Playlist



1. Touch  >  > **Music** > **My phone**.
2. Touch  > **Playlists**.
3. Touch a playlist, and then touch the first song you want to play first.

When you touch a song in the list to play it, the Now playing screen is updated with the songs from your playlist.

### Manage Your Playlists

After creating a playlist, you can add more songs to it, rearrange their order, and more.

1. Touch  >  > **Music** > **My phone**.
2. Touch  > **Playlists**, and then touch the playlist you want to edit.
3. Touch  > **Edit playlist**.



To	Do this
Add songs	Touch  > <b>Add songs</b> >  to choose a category, and then browse for songs. Select the check buttons of songs you want to add to the playlist and then touch <b>Add</b> .
Rearrange songs	Touch and hold  at the end of the song title you want to move. When the row is highlighted, drag it to its new position, and then release.

Delete songs	Select the check buttons next to the songs you want to remove from the playlist.
Change playlist name	Enter a new name for the playlist in the title text box.

4. Touch **Save**.

## Delete Your Playlists

Follow these steps to delete playlists that you no longer use.



1. Touch  >  > **Music** > **My phone**.
2. Touch  > **Playlists**.
3. Touch and hold the playlist you want to delete, and then touch **Delete playlist**.

## Music and Ringtones

You can set your favorite song as ringtone or trim it first and then set it as your phone ringtone.



### Set a Song as a Ringtone

You can select a song from the Music application's Library and set it as your phone's ringtone or as a ringtone for a favorite contact.

1. Touch  >  > **Music** > **My phone**.
2. Select the song that you want to use as ringtone, and then play it back.
3. On the Now playing screen, touch  > **Set as ringtone**.
4. Touch **Phone ringtone** or **Contact ringtone**. If you select **Contact ringtone**, choose the contacts you want to associate the ringtone with.

### Trim an MP3

Use the Music app's ringtone trimmer if you want to set only a part of the song as ringtone.

1. Touch  >  > **Music** > **My phone**.
2. On the Now playing screen, touch  > **Set as ringtone** > **Trim the ringtone**.
3. Drag the trim sliders to the part where you want the ringtone to begin and end. For a more precise trimming, touch the left or right arrow buttons. Time markers indicate

where you are on the song.

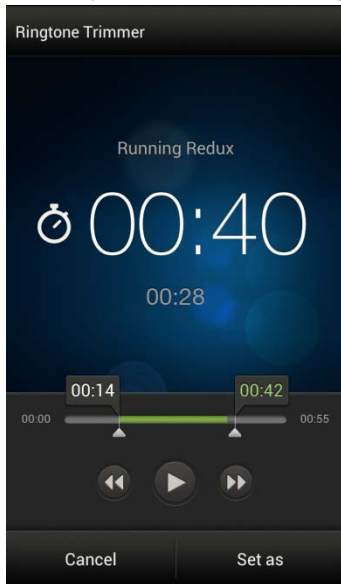



4. After you've finished trimming, touch **Set as**.
5. Select whether to set the trimmed song as your **Phone ringtone** or **Contact ringtone**.

**Tip:** To check if the song was added as a ringtone, open the Notifications panel and then touch  > **Sound** > **Phone ringtone**. The song should be in the ringtone list and selected.

## *Share Music Using Bluetooth*

Select a song from the Music library and use Bluetooth to send it to another phone or your computer.

1. Touch  >  > **Music** > **My phone**.
2. Select the song that you want to send, and then play it back.
3. On the Now playing screen, touch  > **Share** > **Share file** > **Bluetooth**.

You'll be asked to turn on Bluetooth on your phone and connect to the receiving Bluetooth phone so the music can be sent. For more information, see [Turn Bluetooth On or Off](#).

## *Use the Music Widget*

You can use the Music widget to play music right from your Home screen. To find out how you can add this widget to your Home screen, see [Customize the Home Screen](#).

## *FM Radio*

Tune in and listen to your favorite radio stations on your phone.

**Note:** You need to connect a wired headset to the audio jack of your phone to use FM Radio. FM Radio uses the stereo headset as the FM radio antenna. The wired headset is not included with your phone. It must be purchased separately.





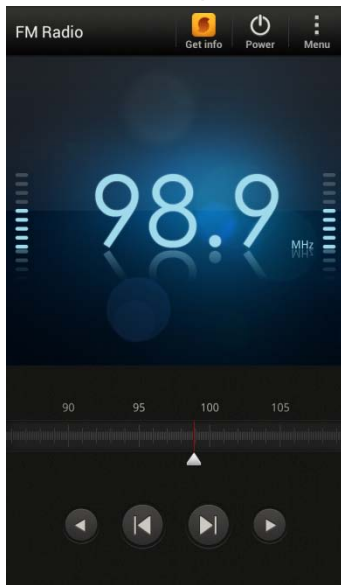

- ▶ Touch  >  > **FM Radio**.

The first time you launch FM Radio, it automatically scans for available FM stations, saves them as presets, and plays the first FM station found.





## Tuning In to an FM Station

There are several things you can do while you're on the FM radio screen.

- Touch  > **Presets** to view the All presets list, and then select a station you want to listen to.
- Touch  to go to the previous available FM station, or  to go to the next available FM station.
- Drag the slider to tune in to a frequency on the FM band.
- Touch  to fine-tune the radio frequency by -0.1 MHz, or touch  to fine-tune the radio frequency by +0.1 MHz.
- Touch  > **Add** to add a preset name for the current station you are tuned into.
- Touch  to repeat scanning and saving of FM stations, mute the sound, and more.
- Press the volume buttons on the side of the phone to adjust the volume.

## Close or Turn Off FM Radio

You can choose to continue listening to the radio while using your phone or turn off FM Radio completely.



- ▶ Touch  to continue listening to the radio while using other apps.
- ▶ To turn off the FM Radio app completely, touch .

# Sprint TV & Movies

The Sprint TV & Movies application offers a wide variety of accessible channels and movies. Subscription options include comprehensive basic packages as well as a full menu of “a la carte” channels and movies. Since available categories and content are subject to change, visit <http://sprintchannels.mobitv.com> for updated information on channels and pricing.

**Note:** You must turn off Wi-Fi before you can view Sprint TV & Movies. If you launch Sprint TV & Movies and have Wi-Fi enabled, a message will appear onscreen asking you if you want to turn off Wi-Fi.

## Watch TV and Movies

1. Touch  >  > **Sprint Zone** > **Sprint Suggests**.
2. Find and touch **Sprint TV & Movies** to download and install the app.
3. On the Sprint TV & Movies home screen, do one of the following:



- Slide your finger left or right on the screen to browse through featured shows, channels, and movies. Touch an item to view more information.
- Touch an icon on the Live Channels section at the bottom of the screen to start viewing live TV. You can also touch the **Live TV** tab at the top of the screen to select from available channels.
- Touch **On Demand** to select from a list of TV shows arranged conveniently into categories.
- Touch **Movies** to select from a list of movies that you can stream on your phone.



- Touch **Shop** to view available channel packages and to order subscriptions.

**Note:** The first time you access a channel, the system will prompt you to purchase access (unless the channel doesn't have a monthly fee). Select **Subscribe** to purchase access, or select **Preview** to view a preview of the selected channel.

4. Touch the live TV, on-demand show, or movie that you've selected. The clip will automatically load and begin playing.
5. While watching a clip, touch the screen to surf to a different channel. The Live Channels list at the bottom of the screen will tell you the channel you're watching as well as other channels that you have access to. Slide your finger on the screen to scroll through the channels. Once you find a channel, show, or movie that you want to watch, scroll to it and then touch it.

## NASCAR Sprint Cup Mobile

Now you have the ability to get every bit of NASCAR coverage, news, and stats right on your phone.

1. Touch  >  > Sprint Zone > Sprint Suggests.
  2. Find and touch **NASCAR** to download and install on your phone.
  3. After installing, open the NASCAR app and follow the onscreen instructions until you reach the main NASCAR Sprint Cup Mobile page.
  4. Touch your favorite driver.
- The main NASCAR homepage lets you view your favorite driver stats on a current race, view special NASCAR promotions and other NASCAR-specific multimedia content.



5. Touch an onscreen option to activate features that include:
  - **Race Recap** provides overviews of the current races, pictures, commentary, additional photos, and race stats.

- **SPEED** displays a list of selectable multimedia video clips from the SPEED channel that are specific to NASCAR.
- **My Driver** to customize your NASCAR experience by following specific drivers. Information includes driver-specific stats and NASCAR RSS feeds. You can also get additional stats, review other driver info, or change drivers.
- **Stats & Schedule** lets you track race information such as: NSCS Recap, NNS Recap, Point Standings, Season Stats, and Schedule.
- **Miss Sprint Cup** is your insider to NASCAR by providing news, information, blogs and twitter updates to the goings-on within NASCAR.
- **Videos** displays a list of selectable multimedia content. Other features include streaming multimedia content from NASCAR radio stations or other racing radio shows.
- **News & Alerts** provides you with quick access to NASCAR-specific news, photos, and driver stats. You can also customize alerts for new information such as ALL NASCAR News, Sprint Cup News, etc.

## *HTC Watch*

With our HTC Watch online video service, shop for your favorite movies or TV series and enjoy watching them.

You can:

- Rent or purchase movies and TV shows. You'll need to create your HTC Watch account first.
- Preview trailers before purchasing your movies.
- Recommend a movie or TV show to your family and friends.
- Watch your purchased videos on up to five HTC phones that have access to HTC Watch using your same account.

[Create or Sign In to Your HTC Watch Account](#)

[Rent or Buy a Video with HTC Watch](#)

[Manage Your HTC Watch Downloads](#)

[Change the HTC Watch Settings](#)



[Check What's Linked to Your HTC Watch Account](#)

[Delete Your HTC Watch Account](#)

[HTC Watch FAQs](#)

## Create or Sign In to Your HTC Watch Account

Create an HTC Watch account or sign in if you have an existing one so you can start renting or buying movies and shows from the HTC Watch store.





1. Touch  >  > **Watch**.
2. Touch  > **Settings** > **Account**.
3. Create a new HTC Watch account, or directly sign in if you already have one.

**Tip:** You can also go to  (**Settings**) > **Accounts & sync** to create your HTC Watch account.

## Rent or Buy a Video with HTC Watch

You can choose to rent a video and watch it on your free time or buy a video and keep it for life.

**Important:** Make sure to use a credit card that's registered in the same region as the one associated to your HTC Watch account.

1. Touch  >  > **Watch**
2. Browse our video store, or touch  to search for a title.
3. While browsing the video selections, you can:
  - Watch the trailer, if available. Touch  to play it.
  - Recommend the video by sharing its link. Touch  > **Share** and then choose how you want to share.
  - Touch the price button to rent or purchase the video.
4. If this is your first time to rent or purchase, add your credit card details and billing information.
5. Confirm your rental or purchase.

You can go to your library to check your downloads.

## Manage Your HTC Watch Downloads

Use the library to manage your downloads and see all of your purchases. You can also start watching a video as it's being downloaded.

Under My library on the HTC Watch main screen, you can:

- Touch the Downloading thumbnail to check the download progress.
- Touch **My movies** or **My TV shows** to see a complete list of videos you've purchased or rented.

While a video is being downloaded, you can touch the video to start watching it. You can also pause a download, resume it, or redownload a video.



## *Change the HTC Watch Settings*

In the HTC Watch app, touch  > **Settings**. You can modify your account settings, edit or remove your credit card info, and more.

## *Check What's Linked to Your HTC Watch Account*



When you download movies or TV shows from the video store, your HTC phone will automatically be added to your HTC Watch account. If you own more than one HTC phone that has access to HTC Watch, you can download and watch videos on up to five phones. You can check what HTC phones are linked to your HTC Watch account.

1. In the HTC Watch app, touch  > **Settings**.
2. Touch **Phone management**.

You can unlink and remove an HTC phone from your account.

## *Delete Your HTC Watch Account*

If you want to discontinue using HTC Watch, you can delete your HTC Watch account.

1. In the HTC Watch app, touch  > **Settings**.
2. Touch **Account** > .

## *HTC Watch FAQs*

### **Why am I asked to sign in again to my account?**

Whenever a time interval (about 20 minutes) has passed, you'll be asked to sign in again to your HTC Watch account before you can continue to rent or purchase videos or access some settings. This is a safety precaution to check your identity and to ensure that you acknowledge that it is your account.

### **How long is a video rental?**

Depending on the studio's terms and the country where you downloaded the video, the rental period can be 24 or 48 hours, starting from the first viewing.

If you're not immediately watching the video, you have up to 30 days before the rental expires.

### **Why won't HTC Watch allow me to remove a phone and add a new one?**

You can only remove an HTC phone once every 120 days.

# Web and Data

---

This section addresses your phone's data connections, the built-in Web browser, and connections to your computer. Additional data-related features can be found in [Accounts and Messaging](#), [Applications and Entertainment](#), and [Tools and Calendar](#).

[Data Services – Sprint 4G LTE and Sprint 3G Networks](#)

[Wi-Fi](#)

[Virtual Private Networks \(VPN\)](#)

[Browse the Web](#)

[Sprint Hotspot](#)

[Connect to a Computer](#)

## *Data Services – Sprint 4G LTE and Sprint 3G Networks*

With your Sprint service, you are ready to start enjoying the advantages of data services. This section will help you learn the basics of using your data services, including managing your user name, launching a data connection, and navigating the Web with your phone.

When you turn on phone for the first time, it is automatically set up to use the Sprint 4G LTE (if available in your area) or the Sprint 3G Network for data connection.

**Important:** Certain data services requests may require additional time to process. While your phone is loading the requested service, the touchscreen may appear unresponsive when in fact they are functioning properly. Allow the phone some time to process your data usage request.

[Your User Name](#)

[Launch a Web Connection](#)

[Data Connection Status and Indicators](#)

[Turn the Data Connection On or Off](#)

[Switch to CDMA Mode to Save Battery Power](#)

[Enable Data Roaming](#)

[Data Services FAQs](#)

## Your User Name

When you buy your phone and sign up for service, you're automatically assigned a user name, which is typically based on your name and a number, followed by "@sprintpcs.com." (For example, the third John Smith to sign up for Sprint data services might have [jsmith003@sprintpcs.com](mailto:jsmith003@sprintpcs.com) as his user name.)

When you use data services, your user name is submitted to identify you to the Nationwide Sprint Network. Your user name is automatically programmed into your phone. You don't have to enter it.





## Update Your User Name

If you choose to change your user name and select a new one online, or make any changes to your services, you must then update the profile on your phone.

1. Open the Notifications panel, and then touch  > **System updates**.
2. Touch **Update profile**.





## Launch a Web Connection

Launching a Web connection is as simple as opening the browser on your phone.

- Touch  >  > **Internet**. Your data connection starts and you see the home page. You can change the default home page. See [Set Browser Options](#).
- Touch  >  > **Mail** or **Messages**. Open a message with a Web page link and then touch it.

## Data Connection Status and Indicators

Your phone displays the current status of your data connection through indicators at the top of the screen. The following symbols are used:

-  Your phone is connected to the Sprint 4G LTE Network. When the arrows are white, your phone is transferring data (for example, when you are opening a Web page). When the arrows are gray , your phone is connected to the network but is not currently transferring data (for example, when you are viewing a Web page that is completely open). In either state, you can receive incoming calls.
-  Your phone is connected to the Sprint 3G Network. When the arrows are white, your phone is transferring data (for example, when you are opening a Web page). When the arrows are gray , your phone is connected to the network but is not currently transferring data (for example, when you are viewing a Web page that is completely open). In either state, you can receive incoming calls.

If you do not see an indicator, your phone does not have a current data connection. To launch a connection, see [Launch a Web Connection](#).

## Turn the Data Connection On or Off

Turn your data connection off to optimize the phone's battery life. It can also save money on data charges. However, when your data connection is turned off, you may not always receive automatic updates to your email, social network accounts, and other synchronized information.

1. Open the Notifications panel, and then touch .
2. Touch the Off/On switch next to **Mobile network** to turn data connection on or off.

## Add the Data Connection Widget

Add the Data connection widget to the Home screen to make it faster for you to turn the phone's data connection on or off.

1. Touch and hold on an empty space on your Home screen.
2. On the Widgets tab, touch **All Widgets** > **Mobile network**.
3. Drag the widget to a Home screen thumbnail where you want to add it.

## Switch to CDMA Mode to Save Battery Power

If you don't need a fast data connection, you can switch your phone to use only the Sprint 3G Network. This saves battery power.

1. Open the Notifications panel, and then touch  > **Mobile network**.
2. Touch **Network mode** > **CDMA only**.

## Enable Data Roaming

Connect to your Sprint's partner networks and access data services when you're out of Sprint's coverage area.

**Important:** Using data services will incur you additional charges. Call Sprint for data roaming rates before you use data roaming.

1. Open the Notifications panel, and then touch  > **Mobile network**.
2. Select the **Domestic Data** and **International Data** check buttons.
3. Make sure that the **Data roaming sound** option is selected if you'd like your phone to play a sound so you'll know when it's connecting to a roaming network.

## Data Services FAQs



### How will I know when my phone is ready for data service?

Your user name (for example, [bsmith01@sprintpcs.com](mailto:bsmith01@sprintpcs.com)) will be displayed when you access  (**Settings**) > **About** > **Phone identity** > **Current username**.

### How do I sign in for the first time?

You are automatically signed in to access data services when you turn on your phone.

### How do I know when my phone is connected to data services?

Your phone automatically connects when you use data service or an incoming message arrives. You will also see the  or  indicator.

### Can I make calls and use data services at the same time?

Depending on the current configuration of your phone, you may be able to make calls and use data services at the same time.

With DDTM mode off (default, configured in  [Settings] > Call):

- If you are using the Sprint 3G Network when a voice call comes in, data transmission is suspended and will automatically resume when you complete your voice call.
- If you are on a voice call, you will not be able to establish connection with the Sprint 3G Network.



With DDTM on (configured in  [Settings] > Call):

- You cannot use voice and data services simultaneously. If you receive a call while data service is active, your phone will forward the call to voicemail. You can place an outgoing call at any time, but it will interrupt any in-progress data session. Your phone will not automatically resume an interrupted data session.

With DDTM off or on:

- You can make or receive a voice call while you are connected to the Sprint 4G LTE Network. Incoming calls will not disrupt or suspend your data connection.

### When is my data connection active?

Your connection is active when data is being transferred. Outgoing calls are allowed; incoming calls go directly to voicemail. When active, the arrows on the  or  icon light up.

### When is my data connection dormant?

If your phone receives no data for ten seconds, the connection goes dormant. When the connection is dormant, you can make and receive voice calls. (The connection may become active again quickly.)

If your phone receives no data for an extended period of time, the connection will terminate.

### Can I sign out of data services?

You can sign out without turning off your phone; however, you will not be able to browse the Web or use other data services (unless you establish a Wi-Fi connection.) While signed out, you can still place or receive phone calls, check voicemail, and use other voice services. You may sign in again at any time. To sign out, open the Notifications panel, and touch the Off/On switch next to **Mobile network**.

## Wi-Fi

Wi-Fi provides wireless Internet access over distances of up to 300 feet. To use your phone's Wi-Fi, you need access to a wireless access point or "hotspot."

The availability and range of the Wi-Fi signal depends on a number of factors, including infrastructure and other objects through which the signal passes.

[Turn Wi-Fi On and Connect to a Wireless Network](#)

[Check the Wireless Network Status](#)

[Connect to a Different Wi-Fi Network](#)

[Add the Wi-Fi Widget](#)

### *Turn Wi-Fi On and Connect to a Wireless Network*

It's quick and easy to turn Wi-Fi on and connect to a wireless network.

1. Open the Notifications panel, and then touch .
2. Touch the Off/On switch next to **Wi-Fi**.
3. Touch **Wi-Fi**. The network names and security settings (**Open network** or **Secured with WEP**) of detected Wi-Fi networks are displayed.

**Note:** If the wireless network that you want is not listed, touch  > **Add network** to manually add it.

4. Touch the Wi-Fi network you want to connect to.

**Note:** If you selected a secured network, you'll be asked to enter the network key or password.

5. Touch **Connect**.

When your phone is connected to a wireless network, the Wi-Fi icon () appears in the status bar and tells you the approximate signal strength (number of bands that light up).

The next time your phone connects to a previously accessed secured wireless network, you will not be prompted to enter the WEP key again, unless you reset your phone to its factory default settings.

If **Network notification** in Wi-Fi settings is enabled, this icon () appears in the status bar whenever the phone detects an available wireless network within range.

### *Check the Wireless Network Status*

Check your phone's connection to the wireless network, the signal strength, security type, and more.

1. Open the Notifications panel, and then touch  > **Wi-Fi**.
2. Touch the wireless network that the phone is currently connected to. You will see a message box showing the Wi-Fi network name, status, speed, signal strength, and other details.

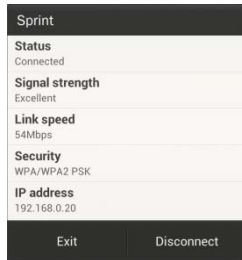

**Note:** If you want to remove wireless network settings from your phone, touch and hold the network name in the list of detected networks, and then touch **Forget network**. You need to enter the settings again if you want to connect to this wireless network.

## *Connect to a Different Wi-Fi Network*

Follow these steps if you want to connect to another wireless network within your phone's range.

1. Open the Notifications panel, and then touch  > **Wi-Fi**.
2. Touch **Wi-Fi**. The network names and security settings of detected Wi-Fi networks are displayed.

**Note:** To manually scan for available Wi-Fi networks, touch  > **Scan**.

3. Touch another Wi-Fi network to connect to it.

## *Add the Wi-Fi Widget*

Add the Wi-Fi widget to the Home screen to make it faster for you to turn Wi-Fi on or off.

1. Touch and hold on an empty space on your Home screen.
2. On the Widgets tab, touch **All Widgets** > **Wi-Fi**.
3. Drag the widget to a Home screen thumbnail where you want to add it.

## *Virtual Private Networks (VPN)*

Add virtual private networks (VPNs) so you can connect and access resources inside a secured local network, such as your corporate network. Depending on the type of VPN you're using at work, you may be asked to enter your login credentials and install security certificates before you can connect to your company's local network. You can get this information from your network administrator.

Also, your phone must first establish a Wi-Fi or data connection before you can start a VPN connection. For information about setting up and using these connections on your phone, see [Data Services – Sprint 4G LTE and Sprint 3G Networks](#) and [Wi-Fi](#).

## Add a VPN Connection

### Connect to a VPN

### Disconnect From a VPN

## Add a VPN Connection



You must first set a lock screen PIN or password before you can use credential storage and set up the VPN.

1. Open the Notifications panel, and then touch .
2. Under Wireless & networks, touch **More**.
3. Touch **VPN > Add VPN network**.
4. Enter the VPN settings and set them up according to the security details your network administrator gave you.
5. Touch **Save**.

The VPN is then added to the VPNs section of the VPN settings screen.

## Connect to a VPN

After you've added a VPN connection, you are now ready to connect and access that network.

1. Open the Notifications panel, and then touch .
2. Under Wireless & networks, touch **More > VPN**.
3. Touch the VPN that you want to connect to.
4. Enter your login credentials, and then touch **Connect**. When you are connected, the VPN connected icon  appears in the notification area of the status bar.

You can then open the Web browser to access resources such as intranet sites on your corporate network. For more information, see [Browse the Web](#).

## Disconnect From a VPN

Disconnect from the VPN when you're done accessing your intranet sites.

1. Open the Notifications panel, and then touch .
2. Touch the VPN connection to return to the VPN settings screen, and then touch the VPN connection to disconnect from it.

## Browse the Web

A fully-optimized Web browser with all the advanced features will let you enjoy Internet browsing on your phone.

### Open the Browser



[Private Browsing](#)

[Add and Manage Your Bookmarks](#)

[Save Web Content For Later](#)

[Browsing History](#)



[Download File and Apps from the Web](#)

[Set Browser Options](#)

[Copy Text, Look Up Information, and Share](#)

## *Open the Browser*

Open the browser and start surfing the Web.

1. Touch  >  > **Internet**.
2. Touch the URL box at the top of the screen.
3. Enter the website address. As you enter the address, matching website addresses will appear on the screen.
4. Enter your search keywords or a Web address.
5. On the Web page, you can:
  - Touch a link to open it, or touch and hold a link to see more options.
  - Touch an email address to send a message to the email address.

## Switch to Reading Mode

Want to read an article or blog without distractions? Reading mode removes menus, banners, and backgrounds from a Web page.

- ▶ While viewing an article, touch  (when it's available) to switch reading mode on or off.

## View the Full Version of a Website

- ▶ While viewing a webpage, touch  > **View desktop site**.

## Open or Switch Between Browser Tabs

Open multiple browser tabs to make it easier for you to switch from one Website to another.

1. While viewing a Web page, touch  > **Tabs**.
2. Do one of the following:
  - To open a new tab, touch **New tab**.

- To switch to another browser tab, slide your finger until the Web page you want to view appears. Touch a webpage to display it in full screen.

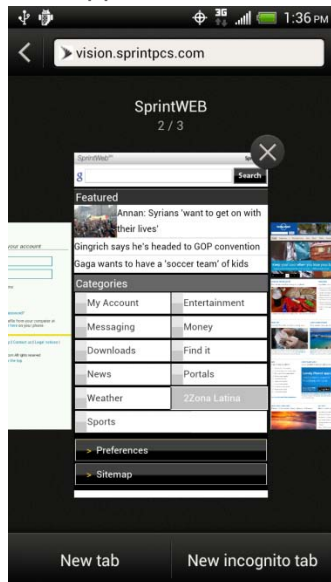

3. Touch to close a Web page.

## Private Browsing

You can use incognito tabs to browse the Web with more privacy. Browser cookies are not shared and deleted when you close all incognito tabs. Pages you view in incognito also won't appear in your browser history except for files you download.

1. From the browser screen, touch > **Tabs**.
2. Touch **New incognito tab**.



## Add and Manage Your Bookmarks

You can store as many bookmarks as you want on your phone. You can also access a convenient list of the sites you have visited, or quickly view the pages that you access most often.

### Bookmark a Web Page





1. Touch > > **Internet**.
2. While viewing a Web page, touch > **Add to** > **Bookmarks**.
3. Edit the bookmark name if needed.
4. To save the bookmark to a new folder, touch **Bookmarks**.
5. On the Add to screen, touch > **New folder**.
6. Enter a name for the Bookmark folder, and then touch **OK**.
7. Touch **Done**.

## Open a Bookmark

1. Touch  >  > **Internet**.
2. Touch  > **Bookmarks**.
3. On the Bookmarks tab, navigate to the bookmark you want to open, and then touch it.

**Tip:** If you have set up Google Chrome™ sync on your Google Account, touch  on the Bookmarks screen, and then select the Google Account to view for your synced bookmarks.

## Edit Your Bookmarks

1. Touch  >  > **Internet**.
2. Touch  > **Bookmarks**.
3. On the **Bookmarks** tab, touch  > **Edit**.
4. Touch  at the right of the bookmark you want to edit.
5. Enter your changes and touch **Done**.

## Syncing Your Bookmarks with Google Chrome

Create bookmarks from your computer's Google Chrome browser and sync them on your phone. For more information about Google Chrome, visit [support.google.com/chrome](https://support.google.com/chrome).

**Important:** Using your Google Chrome desktop browser, you need to sign in to your Google Account and set up Google Chrome sync.



Be sure that you are logged in to your Google Account every time you save Google Chrome bookmarks on your computer.

1. Open the Notifications panel, and then touch  > **Accounts & sync**.
2. Touch your Google Account.
3. Select the **Sync Internet** option.





## Save Web Content For Later

Save Web pages to read later, even without an Internet connection. Some video clips in Web pages (for example, embedded YouTube® videos) can also be added to the Watch list so you can quickly find and watch them during your free time.

**Note:** Only Web pages will be stored on your phone. You need to connect to the Internet when opening linked pages and video clips.

1. Touch  >  > **Internet**.
2. While viewing a Web page, touch  > **Add to**.
3. Touch **Reading list** or **Watch list**.





## View Items in Your Reading or Watch List

1. Touch  >  > **Internet**.
2. While viewing a Web page, touch  > **Bookmarks**.
3. On the **Saved** tab, do any of the following:
  - Under Reading list, touch a thumbnail of the Web page you want to open.
  - Under Watch list, touch a thumbnail of the video clip you want to open.
  - Touch  to see more options.



## *Browsing History*

The Browser stores your browsing history and Web pages that you frequently visit for easy access.



### View Your Browsing History

1. Touch  >  > **Internet**.
2. While viewing a Web page, touch  > **History**. You can also touch and hold .
3. On the History tab, touch a time period to see a list of Web pages you've visited.

### Clear Your Browsing History

1. Touch  >  > **Internet**.
2. While viewing a Web page, touch  > **History**.
3. On the History tab, touch  > **Clear all**.

### View a Page That You Often Visit

1. Touch  >  > **Internet**.
2. While viewing a Web page, touch  > **History**.
3. On the Most visited tab, navigate to the page you want to view, and then touch the page.



### Clear the List of Most Visited Pages

1. Touch  >  > **Internet**.
2. While viewing a Web page, touch  > **History**.
3. On the Most visited tab, touch  > **Clear all**.

## *Download File and Apps from the Web*



Do more than just browsing the Web. You can download Web files such as photos and apps, and then save them on your phone storage.

**Important:** You can download applications directly from your favorite websites. Applications downloaded from the Web can be from unknown sources. To protect your phone and personal data, we strongly recommend that you download and install only applications you trust.

1. Touch  >  > **Internet**.
2. Go to the website where you can download the file you want, and then do any of the following:
  - Follow the website's download instructions for apps.
  - Touch and hold an image or a web link, and then touch **Save link**.

**Note:** Before you can install the downloaded app, you need to set your phone to allow installation of third-party apps in  (**Settings**) > **Security** > **Unknown sources**.



## View Your Downloads

1. Touch  >  > **Downloads**.
2. Touch the file to open it.

## Set Browser Options



Customize the web browser to suit your browsing style. Set display, privacy, and security options when using the web browser. From the browser screen, touch  > **Settings**.

## Set Your Home Page

1. Touch  >  > **Internet**.
2. Touch  > **Settings** > **General** > **Set homepage**.
3. Select the home page you want to use.



## Show Content Compatible with Adobe Flash

Choose which Adobe<sup>®</sup> Flash<sup>®</sup> content you want to see on a webpage, and when you want to view it.

1. Touch  >  > **Internet**.
2. Touch  > **Settings**.
3. Touch **Advanced** > **Enable Flash and plug-ins** > **On demand**.

After selecting **On demand**, you can show the Adobe Flash content by touching  on the Web page.

## Find Text In a Web Page

1. Touch  >  > **Internet**.
2. While viewing a Web page, touch  > **Find on page**.

3. Enter the search item. As you enter characters, matching characters will be highlighted.
4. Touch the left or right arrow to go to the previous or next matching item.

## Copy Text, Look Up Information, and Share

Once you have selected text on a Web page, you have several options. You can:

- Copy it.
- Search for it on the Web.
- Share the text in a new email, text, or multimedia message or in your status update on a social network.

### Select Text

1. Touch  >  > **Internet**.
2. While viewing a Web page, touch and hold a word.

**Tip:** To select text in a link, touch and hold the link, and then touch **Select text**.

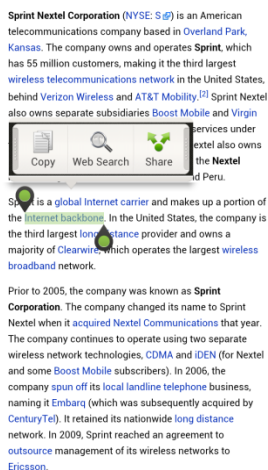

3. Drag the start and end markers to highlight the surrounding text you want to select. You can drag to increase or decrease the text selection area.
4. Touch an icon to copy, search, or share the selected text.



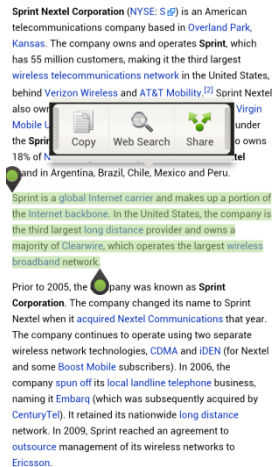

To select a larger block of text, you can drag these markers up or down.





## Copy and Paste Text

1. Touch  >  > **Internet**.
2. While viewing a Web page, touch and hold a word.
3. Drag the start and end markers to highlight the surrounding text you want to copy. You can drag to increase or decrease the text selection area.
4. Touch **Copy**. The selected text is then copied to the clipboard.
5. In a text box (for example while composing a message), touch and hold at the point where you want to paste the text.
6. Touch **Paste**.

## Search Text

1. Touch  >  > **Internet**.
2. While viewing a Web page, touch and hold a word.
3. Drag the start and end markers to highlight the surrounding text you want to search or translate. You can drag to increase or decrease the text selection area.
4. Touch **Web Search**.

## Paste Text in a New Message or Social Network Status Update

1. Touch  >  > **Internet**.
2. While viewing a Web page, touch and hold a word.
3. Drag the start and end markers to highlight the surrounding text you want to share. You can drag to increase or decrease the text selection area.
4. Touch **Share**.

5. Select an option to paste the selected text in a new email, text or multimedia message, or in your status update on a social network such as Twitter.

## *Sprint Hotspot*

Sprint Hotspot turns your phone into a Wi-Fi hotspot and shares your phone's data connection with as many as eight computers or mobile phones via Wi-Fi. When you open Sprint Hotspot, your phone creates a secured Wi-Fi network where you can connect your computer and other phones to access the Internet.

To use your phone as a Wi-Fi hotspot, make sure that your phone has an active data connection. For more information, see [Data Services – Sprint 4G LTE and Sprint 3G Networks](#).

**Note:** To connect to your phone's Wi-Fi network, you need a computer with built in Wi-Fi or a Wi-Fi adapter.

[Set Up Sprint Hotspot](#)

[Connect Your Computer to Sprint Hotspot](#)



[Manage Sprint Hotspot](#)

[Turn Off Sprint Hotspot](#)

[Add the Sprint Hotspot Widget](#)

## *Set Up Sprint Hotspot*

You must first set up Sprint Hotspot before you can connect other devices to your phone.

1. Touch  >  > **Sprint Hotspot**.
2. Touch **OK** on the introduction screen.
3. Enter a new name in the **Router name (SSID)** text box, or use the default router name.
4. Select a network security method from the **Security** list. If you selected **WEP**, **WPA (TKIP)**, or **WPA2 (AES)**, enter a network key (password) in the **Password** box.
5. Select the **Sprint Mobile Hotspot** check button at the top of the screen to turn on the wireless router.

When Sprint Hotspot is active and is ready to share its 4G LTE or 3G connection, the hotspot icon  appears in the status bar.

## *Connect Your Computer to Sprint Hotspot*

After setting up your phone as a wireless router, connect your computer to your phone's Sprint Hotspot and access the Internet.

### **Windows Vista or Windows 7 Computer**

1. Click **Start > Connect To**.



2. In the **Connect to a network** dialog box, select the Sprint Hotspot name (or SSID), and then click **Connect**.

**Note:** Your phone's wireless network may not show up in the list of available networks immediately. Wait for a moment and then refresh the list to see the wireless network.

3. Enter the network key (if any) that you used when setting up Sprint Hotspot, and then click **Connect**.
4. Click **Close**.

### Windows XP Computer



1. Click **Start > Connect To > Wireless Network Connection**.
2. In the **Choose a Wireless Network** dialog box, select the Sprint Hotspot name (or SSID), and then click **Connect**.

**Note:** Your phone's wireless network may not show up in the list of available networks immediately. Wait for a moment and then refresh the list to see the wireless network.

3. Enter the network key (if any) that you used when setting up Sprint Hotspot, and then click **Connect**.

## Manage Sprint Hotspot

You can set the number of computers or phones or allow only specific phones to connect and use Sprint Hotspot to connect to the Internet.

1. Touch  >  > **Sprint Hotspot**.
2. Touch **OK** on the introduction screen.
3. Touch **Manage users**, and then set the following options:
  - Select the **Allowed users only** check button if you want to allow only specific phones or computers to connect to Sprint Hotspot on your phone. When you select this option, this icon  appears in the status bar every time a new phone or computer attempts to connect to Sprint Hotspot. To allow connection, touch **Allow** on the Manage users screen.
  - **Max. connections:** Touch to set the maximum number of phones and computers that can connect to and use Sprint Hotspot.
  - **Allowed users:** Lists the MAC addresses of computers and phones that you have allowed connection to Sprint Hotspot on your phone.
  - **Block users:** Lists the MAC addresses of computers and phones that are not allowed to connect to Sprint Hotspot on your phone. Touch an entry to allow connection to Sprint Hotspot.
4. Touch **Done**.

5. Select the **Sprint Mobile Hotspot** check box at the top of the screen to turn on the wireless router with your new settings.

## *Turn Off Sprint Hotspot*

When you're done sharing your phone's data connection, turn off Sprint Hotspot to save battery power and data use.

1. Open the Notifications panel, and then touch  > **More** > **Sprint Hotspot & tethering**.
2. Clear the **Sprint Hotspot** check button.

## *Add the Sprint Hotspot Widget*

Add the Sprint Hotspot widget to the Home screen to make it faster for you to turn Sprint Hotspot on or off. To learn how to add widgets, see [Customize the Home Screen](#).

## *Connect to a Computer*

Whenever you connect your phone to a computer using the USB cable, the **Choose a connection type** screen opens and lets you choose the type of USB connection. Select one of the following choices, and then touch **Done**.

- **Charge only.** Select this option if you only want to charge the battery while connected to your computer.
- **HTC Sync Manager.** Select this option to sync media and your data such as contacts, calendar, bookmarks, and other information between your computer and your phone. See [HTC Sync Manager](#) for more information.
- **Disk drive.** If you installed a microSD card on your phone, select this mode when you want to copy files between the microSD card and your computer. When Disk drive mode is enabled while your phone is connected to the computer, you will not be able to use apps on your phone that need to access the microSD card. See [Copy Files to or from the microSD Card](#) for more information.
- **USB tethering.** When you do not have an Internet connection on your computer, you can select this mode to share the mobile data connection of your phone with your computer. See [Use Your Phone as a Modem](#) for more information.
- **Media sync.** Select this mode if you want to sync photos, videos, music, and other supported files between your phone and a multimedia app on your computer such as Windows Media® Player. When using Media sync mode, you can access the contents of the phone storage and the microSD card, if you installed one.
- **Internet pass through.** If you don't have a data plan or you don't have access to a Wi-Fi network, you can select this mode to share your computer's Internet connection with your phone. See [Connect Your Phone to the Internet Through a Computer \(Internet Pass-through\)](#) for more information.

## *Use Your Phone as a Modem*

Get online with your notebook or desktop computer at any time, using your phone's data connection.

1. Install HTC Sync Manager on your computer. To learn how, see [HTC Sync Manager](#).
2. Make sure that your phone has an active data connection. For more information, see [Data Services – Sprint 4G LTE and Sprint 3G Networks](#).
3. Connect the phone to the computer using the provided USB cable.
4. On the Connect to PC screen, select **USB tethering**, and then touch **Done**.

**Note:** When you are using your phone as a modem, the USB mass storage feature is disabled, and you will not be able to use HTC Sync Manager.

## *Connect Your Phone to the Internet Through a Computer (Internet Pass-through)*

If you don't have a data plan for your phone or you don't have access to a Wi-Fi network, you can still go online on your phone by using your computer's Internet connection.

1. Install HTC Sync Manager on your computer. To learn how, see [HTC Sync Manager](#).
2. Make sure your computer is connected to the Internet.

**Important:** Sprint recommends that you turn off your local network's firewall. Also, if your computer connects to the Internet via PPP (for example, dial-up, xDSL, or VPN), Internet Pass-through will only support TCP protocol.

3. Connect the phone to the computer using the provided USB cable.
4. On the Connect to PC screen, select **Internet pass-through**, and then touch **Done**.

# Camera and Video

---

You can use the camera or camcorder to take and share pictures and videos. Your phone comes with a 8.0 megapixel camera with an autofocus feature that lets you capture sharp pictures and videos.

[Using the Camera](#)

[Access Photos and Videos](#)

[Wireless Display](#)

[Movie Editor](#)

## *Using the Camera*

Whether traveling for business or fun, enjoy taking pictures and videos of your trip and encounters with your phone's camera.

[Launch the Camera](#)

[Take a Photo](#)

[Record a Video](#)

[Camera Scenes](#)

[Change Camera and Video Settings](#)

## *Launch the Camera*

Capture photos instantly, with no delay. Just directly launch the camera from the lock screen, even if your phone is password protected.

1. When your display is off, press .
2. Drag the Camera icon to the lock screen ring so you can start taking photos and videos right away.

**Tip:** From the Home screen, you can also touch the Camera icon or press the Camera key to launch it.

Use the controls on the Viewfinder screen to add effects, zoom in or out, and more.



**Note:** After using Camera (or if you temporarily leave the Viewfinder screen), you still need to unlock the phone if you have a screen lock.

## Zooming

- Before taking a photo or video, slide your finger on the zoom bar  to zoom in or out.
- When you're recording video, the zoom bar is always onscreen. You can freely zoom in or out while recording.

## Switch Between the Front and Main Camera

1. On the Viewfinder screen, touch .
2. Touch **Camera**.
3. Touch either **Front** or **Main**.

**Note:** Some camera features are not available when you're using the front camera, such as zooming and face detection.

## Add Effects

Use the available camera effects to make your photos look as if they've been taken through special lenses and filters. You can also apply certain effects to videos.

Choose an effect before taking a photo or video.

1. On the Viewfinder screen, touch .
2. Scroll through the available effects and touch one that you like.

**Tip:** When you choose certain photo effects such as depth of field, distortion, or vignette, drag the bar that appears on the screen to adjust the intensity of the effect.

## Set the Resolution

1. On the Viewfinder screen, touch .
2. Touch **Image resolution** or **Video quality**, and then choose a resolution.

## Select a Flash Mode

- ▶ On the Viewfinder screen, touch the flash icon to choose a flash mode.

When using Flash on or Auto flash mode, the camera intelligently sets the best flash brightness for your photo.

## Take a Photo

Whether it's moving or not, clearly capture any moment with your phone's camera.

1. Open Camera from the lock screen or Home screen.
2. Just point the camera on what you want to capture. The camera adjusts the focus automatically, and continuously refocuses as you move it.
3. When you're ready to take the shot, touch .

## Take Continuous Camera Shots



Do you want to take photos of moving subjects? Whether it's your kid's football game or a car race, you can capture the action.

1. On the Viewfinder screen, just touch and hold . The camera takes up to 20 consecutive shots of your subject.
2. After taking the shots, review your photos and delete the ones you don't want to keep.

**Tip:** Want to capture a lot more shots? Touch  > **Continuous shooting**, and then clear the **Limit to 20 frames** option.

## Record a Video

Capture high-definition video clips that you can later share or create into movies.

1. Open Camera from the lock screen or Home screen.
2. When you're ready to start recording, touch .
3. While recording, you can:
  - Freely zoom in or out.
  - Change focus to a different subject or area by just touching it on the Viewfinder screen.
  - Touch the flash icon to turn the flash on or off.
4. To stop recording, touch .

## Taking a Photo While Recording a Video

While you're recording video using the main camera, touch  to capture a still shot of your subject.

## Record Slow Motion Videos

Relive high speed action bit by bit and add a touch of suspense to your videos.

1. On the Viewfinder screen, touch **A**.
2. Touch **Slow motion video**.
3. Frame your subject on the Viewfinder screen.
4. Touch  to start recording.

## Improve Video Stability

Lessen shakes and blurs in your video, especially when you're following a moving subject.

1. On the Viewfinder screen, touch .
2. Touch **Video options > Video stabilization**.

## Camera Scenes

Scenes provide an easy way to override your camera's normal settings to suit your current lighting and environment. Use Auto and let the camera automatically determine optimal settings, or choose from a wide selection of scenes before you start taking photos.

## Improve Portrait Shots

If you'd like your family or friends to look their best in your photos, make sure to use the portrait scene. It smoothens the skin in your shots.

1. On the Viewfinder screen, touch **A**.
2. Touch **Portrait**.
3. When you're ready to take the photo, touch .

## Take a Group Shot

Finding it difficult to make everyone smile and have them look at the camera at the same time? With your phone, you get perfect group portraits with the most smiles and the fewest blinks.



1. On the Viewfinder screen, touch **A**.
2. Touch **Group portrait**.
3. When you're ready to take the photo, touch . The camera takes several shots and merges them into the best possible group photo.

## Take a Panoramic Photo

Whether it's the Golden Gate Bridge or the Eiffel Tower, you can capture anything wide or tall in a single photo.

1. On the Viewfinder screen, touch **A**.
2. Touch **Panorama**.

**Note:** Zoom and flash are disabled when you're in this mode.

3. When you're ready to take the first shot, touch . Directional arrows appear, prompting you to pan left or right in landscape view (or pan up or down in portrait view).
4. As you pan, a guide appears onscreen. Use this to frame the first portion of the scene you want to capture.
5. Continue moving your phone as smoothly as you can. The camera automatically captures five consecutive frames.
6. Touch  to stop capturing anytime.

The camera stitches the shots into a single photo.

## Use HDR

When shooting portraits against a bright background, use HDR to capture your subjects clearly. HDR brings out the details of both the highlights and shadows, even in high contrast lighting.

1. On the Viewfinder screen, touch **A**.
2. Touch **HDR**.
3. When you're ready to take the photo, touch .

The camera takes three shots at different exposure levels and combines them into one enhanced photo.

## Shoot in Low Light

Capture stunning images in dim light without using the flash.

1. On the Viewfinder screen, touch **A**.
2. Touch **Low light**.

**Note:** Flash is disabled when you're in this mode.

3. When you're ready to take the photo, touch .

To avoid getting blurry photos, maintain a steady grip on your phone. You can also improve your photo after taking the shot by applying special effects like auto enhance and high contrast.

## Change Camera and Video Settings

Change basic settings or an additional advanced settings menu is available for camera and video.

1. On the Viewfinder screen, touch .



2. As well as changing basic camera and video settings, you can also:
  - Change the review duration to set how long a captured photo or video will be displayed on the Review screen before the camera changes back to the Viewfinder screen.
  - Automatically take a shot when your subject smiles (photo mode only).
  - Geo-tag photos to store GPS location in your captured photos (photo mode only).
  - Set the ISO level. Higher ISO numbers are better for taking pictures in low light conditions (photo mode only).
  - Automatically upload photos to a social network (photo mode only). You can set the upload frequency, select the album to upload to, and set the privacy level.

## *Access Photos and Videos*

Reminisce on good times. Use Gallery to view all your photos and videos that are on your phone or your online albums. You can even:

- Add photo frames and apply effects.
- Trim your videos.
- Share to your social networks, photo sharing sites, and more.
- View your photos and videos on a big screen TV.

[View Photos and Videos](#)

[Start a Photo Slideshow](#)

[Watch Videos](#)

[Edit Your Photos and Videos](#)



[View Photos in Your Social Networks](#)

[Print Your Photos](#)

[Share Your Photos and Videos](#)

## *View Photos and Videos*



Enjoy photos and videos you've captured on your phone using the Gallery app.

1. Touch  >  > **Gallery**.
2. Touch a photo or video album to browse through the photos and videos of that album.
3. Touch a photo or video to view it in full screen.

**Note:** While viewing a photo in full screen, touch anywhere on the screen, and then touch **More > Show on map** to see the location where you took the photo. (**Show on map** is available when you've enabled Geo-tag photos in the Camera settings.)

## Start a Photo Slideshow



Share your photos in a slideshow complete with transition effects and even add background music.

1. Touch  >  > **Gallery**.
2. Touch a photo album.
3. Touch **Play**.

During the slideshow, touch the screen to show the controls. Touch  to set slideshow preferences.

## Watch Videos

Play back and share your video clips on the Gallery app.

1. Touch  >  > **Gallery**.
2. Touch a video album, and then touch a video.
3. Touch the onscreen controls to control the video playback, adjust the volume, capture an image during playback, and more.

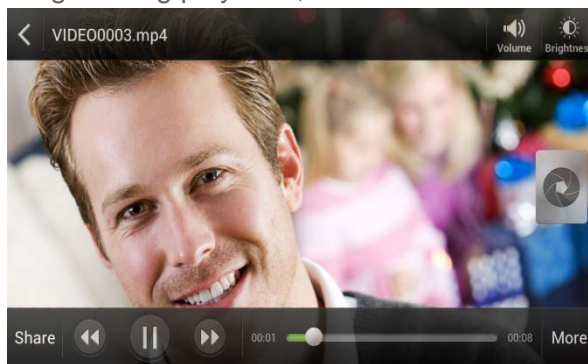

**Tip:** Touch **More > Select player** to share the video on your home network.



## Take a Photo While Watching a Video

- ▶ While you're watching a video in Gallery, touch  to capture a still shot.

## Edit Your Photos and Videos



Do basic editing tasks on your photos such as rotation and cropping. You can also enhance your photos by applying effects such as high contrast, vintage appearance, and more. You can also trim your captured videos.

## Rotate a Photo

1. Touch  >  > **Gallery**.
2. Touch a photo album.
3. Touch and hold the photo that you want to rotate, and then touch **Edit** > **Rotate left** or **Rotate right**.

**Tip:** You can also rotate a photo while you're viewing it in fullscreen. Touch the screen, and then touch **Edit** > **Rotate right** or **Rotate left**.

## Crop a Photo

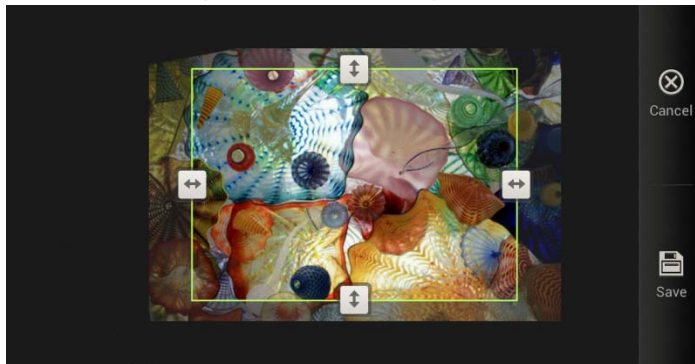

1. Touch  >  > **Gallery**.
2. Touch a photo album.
3. Touch and hold a photo, and then touch **Edit** > **Crop**. You'll see a crop box around the photo.



4. You can:
  - Drag the crop box over the part of the photo you want to crop.
  - Touch and hold the edge of the crop box. When directional arrows appear, drag your finger inward or outward to resize the crop box.
5. Touch **Save**.  
The cropped photo is saved as a copy. The original photo remains unedited.

**Tip:** You can also crop a photo while viewing it fullscreen. Touch the screen, and then touch **Edit** > **Crop**, and follow the instructions above.

## Add Effects

1. Touch  >  > **Gallery**.
2. Touch a photo album.
3. Touch and hold a photo, and then touch **Edit** > **Effects**.
4. Touch an effect to apply to the photo.
5. Touch **Save**.





The enhanced photo is saved as a copy. The original photo remains unedited.

**Tip:** You can also add an effect to a photo while viewing it fullscreen. Touch the screen, and then touch **Edit > Effects**, and follow the instructions above.

## Add Custom Photo Effects

Are the existing photo effects not exactly what you are looking for? You can make your own photo effects in Gallery.

**Note:** You can only add effects to photos that are stored in your phone.



1. Touch  >  > **Gallery**.
2. Touch a photo album and touch the photo you want to add effects to.
3. Touch **Edit > Effects >  > **. If you do not see any buttons on the screen, touch the screen once to show the buttons.
4. Touch a filter, and then drag the slider to get the effect you want.
5. While creating the custom effect, you can:
  - Add more than one filter to create a complex effect.
  - Rearrange filters to modify the effect. Touch and hold the filter you want to move, and then drag it to a new position.
  - Remove filters. Touch and hold the filter you want to remove, and then drag it to **Remove**.
6. Touch  to add a frame to your photo.
7. Touch **Done** to apply the effects to your photo.

**Tip:** To save your custom effects for future use, touch **Save Preset**.

8. Touch **Save** to save your photo as a new photo.

## Trim a Video

Remove unwanted scenes from a video you recorded on your phone.

1. Touch  >  > **Gallery**.
2. Touch a video album
3. Touch and hold the video you want to edit, and then touch **Trim**.
4. Drag the two trim sliders to the part where you want the video to begin and end.  
As you drag a slider, you'll see time markers and video frames. The one in the middle is

your start or end frame.

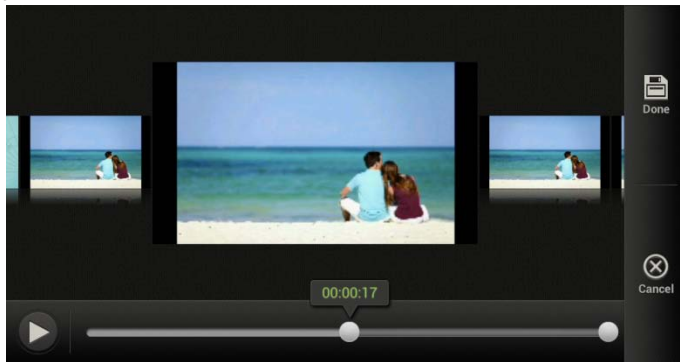

5. Touch **▶** to preview your video.
6. Touch **Done**.

The trimmed video is saved as a new file. The original video remains unedited.

## *View Photos in Your Social Networks*

Right in the Gallery application, check what you and your friends have uploaded to your social networks or photo sharing sites.

**Note:** Log on to your accounts before you start viewing online photos.

1. Touch **🏠** > **☰** > **Gallery**.
2. On the top bar, touch **▼**, and then touch a social network or photo sharing site.
3. Touch an account to start viewing photos in that account.

**Tip:** To comment on a photo, touch and hold a photo thumbnail, and then touch **Add comment**.

## *Print Your Photos*

Connect your phone to a supported printer and print out your photos.

**Note:** Both printer and your phone must be turned on and connected to the same local network. To learn how to connect the phone to the local wireless network, see [Turn Wi-Fi On and Connect to a Wireless Network](#). To learn how to connect the printer to the local network, refer to your printer user guide.

The local network must not be behind a firewall.

1. Touch **🏠** > **☰** > **Gallery**.
2. Touch a photo album.
3. Touch and hold the photo that you want to print, and then touch **Print**. Your phone automatically scans for the printer.
4. If the printer appears on the list, touch it. Otherwise, touch **Scan for printers** or **Add printer** and then follow onscreen instructions to add the printer to the list.

5. In the Print preview screen, you can set the number of copies or select to fit the photo on the page.
6. Touch **Advanced** to set the page size, print layout, and page orientation, and choose if you want to print in color or black-and-white.
7. Touch **Print**.

You can check the printing progress by opening the Notifications panel and then touching the item you're printing.

## Share Your Photos and Videos



Send photos and videos to your computer or to another phone via email, MMS or Bluetooth.

You can also use the Gallery application to share photos and videos straight to your social networks, or post videos on YouTube.

**Tip:** You can share a photo or video right after you've captured it.

### Send Photos or Videos by Email



You can send several photos, videos, or both in an email message. They are added as file attachments in your email.

1. Touch  >  > **Gallery**.
2. Touch the album that has the photos or videos you want to share.
3. Touch **Share**, and then touch **Gmail** or **Mail**.
4. Select the photos or videos you want to share, and then touch **Next**.
5. Compose your message, and then touch  (Gmail) or **Send** (Mail).

**Note:** If you selected **Mail** and you have multiple email accounts, the default email account will be used.

### Send a Photo or Video by MMS (Multimedia Messaging)



Although you can send several photos or videos in a multimedia message, it may be better to just send one at a time, especially if the files are large in size.

1. Touch  >  > **Gallery**.
2. Touch the album that contains the photos or videos you want to share.
3. Touch **Share** > **Messages**.
4. Touch the photo or video you want to send. The photo or video is automatically added into the multimedia message.
5. To add another photo or video to your slideshow attachment, touch  and then touch **Picture** or **Video**.

6. Compose your message, and then touch **Send**.

## Send Photos or Videos Using Bluetooth



Use Bluetooth to send photos and videos to another phone or to your computer.

1. Touch  >  > **Gallery**.
2. Touch the album that contains the photos or videos you want to share.
3. Touch **Share** > **Bluetooth**.
4. Select the photos or videos you want to share, and then touch **Next**.

You'll be asked to turn on Bluetooth and connect to the receiving Bluetooth phone so the files can be sent. For more information, see [Bluetooth](#).

## Share Photos and Videos on Facebook

You need to be logged in to your Facebook account to upload photos.



1. Touch  >  > **Gallery**.
2. Touch the album that contains the photos or videos you want to share.
3. Touch **Share** > **Facebook for HTC Sense**.
4. Select the photos you want to share, and then touch **Next**.
5. Select which album to upload to and set privacy settings for the uploaded photos or videos.

**Tip:** Touch **Add tag and description** to enter a caption on each photo or video or tag friends on your photos. If you're sharing several photos or videos, slide to the left to go to the next one. Remember to touch **Save** after you're done.

6. Touch **Done**

## Share Photos and Videos on Flickr

**Note:** Log in to your Flickr account before you upload photos and videos.



1. Touch  >  > **Gallery**.
2. Touch the album that contains the photos or videos you want to share.
3. Touch **Share** > **Flickr**.
4. Select the photos or videos you want to share and then touch **Next**.
5. Select which album to upload to and set privacy settings for the uploaded photos or videos.

**Tip:** Touch **Add tag and description** to enter a caption on each photo or video or tag friends on your photos. If you're sharing several photos or videos, slide to the left to go to the next one. Remember to touch **Save** after you're done.

6. Touch **Done**.



## Share Photos on Picasa

Sign in to your Google Account before you upload photos to Picasa™.

1. Touch  >  > **Gallery**.
2. Touch the album that contains the photos or videos you want to share.
3. Touch **Share** > **Picasa**.
4. Select the photos you want to share, and then touch **Next**.
5. Enter a caption for the photos you're uploading.
6. Select the online album where you want to upload the photos, or touch  to create a new album.
7. Touch **Upload**.

## Share Videos on YouTube

Upload your videos to YouTube and become an instant sensation.

1. Touch  >  > **Gallery**.
2. Touch a video album, and then touch **Share** > **YouTube**.
3. Select the photos you want to share, and then touch **Next**.
4. Touch the Google Account that you want to use, accept the Terms of Service, and then select which data connection to use to upload the videos.
5. Enter a title and description for the videos you're uploading.
6. Select a privacy option for the videos or tag them for easy searching.
7. Touch **Upload**.

## *Wireless Display*

Share photos, videos, and movies with your friends on a big screen. Simply connect your phone to your home network and instantly share your photos, videos, movies, and music on your



DLNA<sup>®</sup> compliant phones.

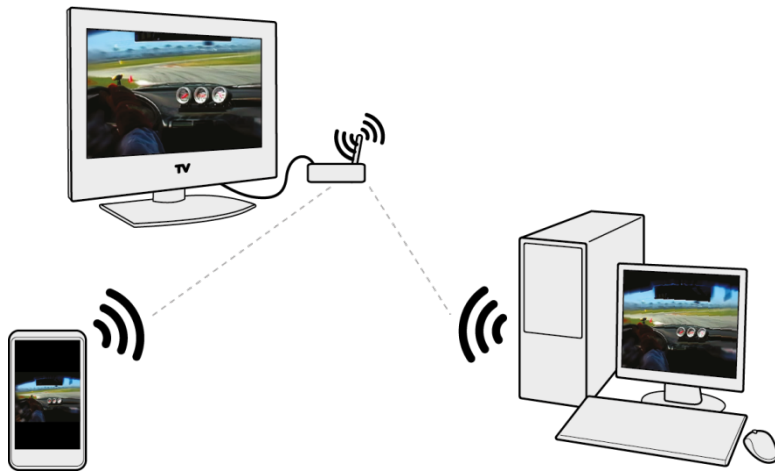

**Tip:** Don't have a DLNA setup at home? You can purchase HTC Media Link HD and hook it up to an HDMI display. Refer to the documentation that comes with HTC Media Link HD to find out how to set it up and use it with your phone.

**Note:** If you'll be using a DLNA compliant TV or audio system, refer to its documentation on how to connect it to your home network.

You'll need to use Media Link HD with HTC Watch™ to display movies and trailers on a big screen TV.

1. Connect your phone to your home network via Wi-Fi.
2. Open the Gallery, HTC Watch, or Music application.
3. Locate the media that you want to share, and then touch it.
4. Do one of the following:
  - While viewing photos or videos in Gallery, touch the screen to show the controls, and then touch **More > Select player**.
  - While playing music in Music, touch **⋮ > Select player**.
  - While playing a movie in HTC Watch, touch **⋮ > TV**.
5. Select the phone on your network where you want to play the media.
6. Once connected to the other phone, touch the onscreen controls to control playback, adjust the volume, and more.

**Note:** For more information about DLNA, visit [www.dlna.org](http://www.dlna.org).

## Movie Editor

Want a novel way to share your photos and videos? Movie Editor lets you make short theme-based slideshow movies complete with transitions and background music.



[Create a Slideshow with Movie Editor](#)

## Change the Soundtrack

### Share Your Slideshow From Gallery

## Create a Slideshow with Movie Editor

Create a slideshow movie from photos and videos stored on your phone.

1. Touch  >  > **Movie Editor** > **+**.
2. Enter a title for your slideshow.
3. Touch **Select a theme**. Themes include slide transitions, the default theme music, and the wallpaper. Touch **Done** after you've selected a theme.
4. Touch **+** to add photos and videos from Gallery. You can also insert photos and videos in front of an existing item. Just touch the photo or video you want to insert and touch **Next**.
5. Edit your slideshow:
  - Rearrange photos and videos. Touch and hold a photo or video and drag it to a new position.
  - Remove photos and videos. Touch the photo or video you want to remove and touch **Remove**.
  - Change the theme. Touch the theme name to choose another theme.
6. Preview the slideshow. Touch  to start viewing your slideshow.

**Tip:** If you want to change the background music, touch  while you're viewing the slideshow.

7. Touch  to save the movie.
8. Choose a resolution, and then choose where you want to save the slideshow.
9. Touch **OK**.

## Change the Soundtrack

Use your favorite song as background music for your slideshow movie.

1. While you preview the slideshow, touch .
2. Touch **Choose music track** to choose a song stored on your phone.

If you have videos in your slideshow, you can balance the volume levels of the audio in the videos with the soundtrack. Simply drag the volume slider to the level you want.

## Share Your Slideshow From Gallery

When your slideshow is ready, you can use the Gallery app to start sharing.

1. Touch  >  > **Gallery**.

2. Touch the Movie Editor album, and then touch **Share**.
3. Choose how you want to share your slideshow.
4. Select the slideshow, and then touch **Next**.
5. Follow screen instructions to upload the slideshow.

# *Tools and Calendar*

---

Learn how to use many of your phone's productivity-enhancing features.

[Calendar](#)

[Calculator](#)

[Clock & Alarm](#)

[Stocks](#)

[Weather](#)

[Tasks](#)

[Online Storage](#)

[HTC Sync Manager](#)

[Voice Recorder](#)

[Bluetooth and NFC](#)

[microSD Card](#)

[Update Your Phone](#)

## *Calendar*

Never miss an important date again. Use the Calendar app to schedule your events, meetings, and appointments.

You can set up your phone to stay in sync with calendars such as Google Calendar, Outlook Calendar, and Microsoft Exchange ActiveSync Calendar.

If you've signed in to your social network accounts, related calendar events will appear in Calendar.

[Create an Event](#)

[View the Calendar](#)

[Manage Calendar Events](#)

[Accept or Decline a Meeting Invitation](#)

[Set Reminders for Your Events](#)

[Event Alerts](#)





[Show or Hide Calendars and Tasks](#)

[Change Calendar Settings](#)

[About the Calendar Widget](#)



## *Create an Event*

You can create events that sync with your Google or Exchange ActiveSync calendars, as well as events that appear on your phone.

1. Touch  >  > **Calendar**.
2. On any Calendar view, touch .
3. Touch the calendar name to select the calendar to which you will add the event.
4. To invite people, touch  and choose who you want to invite.
5. Enter and set the event details.
6. Touch **Save**.

## *View the Calendar*

Select the Calendar view that suits your scheduling needs.

1. Touch  >  > **Calendar**.
2. Touch a Calendar tab.
3. Do any of the following:
  - In any Calendar view, return to the current date by touching **Today**.
  - Events in day, week, and agenda views are color coded to indicate which account or type of calendar they belong to. To find out what each color represents, touch .

**Note:** If you don't see a Calendar tab, touch  > **Edit tabs**, touch and hold a tab and then drag it to the bottom row.

## *Month View*

In month view, you will see markers on days that have events.

When in month view, you can:

- Touch a day to view the events for that day.
- Touch and hold a day to open an options menu from which you can also choose to create an event or switch to either day or agenda view.
- Slide your finger up or down the screen to view earlier or later months.

## Day and Agenda Views

Day view shows your events per day, whereas agenda view displays all your events in chronological order.

**Tip:** Touch a birthday, anniversary, or an all-day event to send a greeting or create a note for that event.

When in day view, you can:

- Touch and hold on a time slot to create a new event at that time.
- Slide left or right across the screen to view earlier or later days.
- See the day's weather, but only if it's within the seven-day forecast. You can touch the weather to change it to display another city.
- See the event time in another time zone. Touch  > **Dual time zone** > **Choose location**, and then enter the second location.

## Week View

Week view displays a chart of the events of one week.

When in week view, you can:



- Touch and hold on a time slot to create a new event at that time.
- Touch an event (shown as colored blocks) to view its details.
- Slide left or right across the screen to view earlier or later weeks.

## Manage Calendar Events

Your phone's Calendar is a convenient way to manage your events by allowing you to edit, erase, and share them.

### Edit an Event

You can edit events that you have created.

1. Touch  >  > **Calendar**.
2. While viewing an event, touch .

**Note:** If you're editing an event that repeats, you'll be asked whether you want to edit just that occurrence or all occurrences of that event.

3. Make your changes to the event.
4. Touch **Save**. Or touch **Send update** if you've invited people to the event.

### Erase Events



1. Touch  >  > **Calendar**.

2. Do any of the following:
  - While viewing an event, touch  > **Delete event**.
  - In day, agenda or week view, touch and hold an event and then touch **Delete** or **Delete event**.

If the event repeats, you'll be asked whether you want to delete just that occurrence or all occurrences from Calendar.

## Share an Event (vCalendar)



You can share a calendar event as a vCalendar using Bluetooth or by sending it as a file attachment with your email or message.

1. Touch  >  > **Calendar**.
2. Do one of the following:
  - While viewing an event, touch  > **Forward**.
  - In day, agenda or week view, touch and hold an event and then touch **Forward**.
3. Choose how you want to send the event.
4. Select your recipient(s) and touch **Send**.

## Accept or Decline a Meeting Invitation

Go to the Invites tab to see meeting invitations which you have not yet accepted or declined.

**Note:** You must set up an Exchange ActiveSync account to receive meeting invitations in Calendar.

1. Touch  >  > **Calendar**.
2. Touch the Invites tab and then touch a meeting invitation.
3. Accept, decline, or tentatively accept the invitation, or propose a new time.

**Tip:** Touch  to choose from more options, such as moving the invitation to a folder.

## Set Reminders for Your Events

Calendar makes it easy to remind yourself of important events.

1. While viewing a calendar event, touch **Reminder**.
2. Choose how far in advance you want to be reminded of the event.

**Tip:** You can set the default reminder time or choose an event reminder tone in the Calendar settings.





## Event Alerts

If you have set at least one reminder for an event, the upcoming event icon  will appear in the notifications area of the status bar to remind you of the upcoming event.

1. Open the Notifications panel.
2. Touch the event reminder notification.
3. Do one of the following:
  - Choose to snooze or dismiss all event reminders.
  - Touch  to keep the reminders pending in the notifications area of the status bar

## Show or Hide Calendars and Tasks

You have the option to show only the calendars that you frequently use. You can also show or hide tasks that you've created in your phone.

1. Touch  >  > **Calendar**.
2. Touch .
3. Select or clear the calendar you wish to show or hide, and then touch .

**Note:** Calendars are kept synchronized on your phone, even if they are hidden.

## Change Calendar Settings

You can change Calendar settings to specify how it displays events and how it notifies you of upcoming events.



1. Touch  >  > **Calendar**.
2. Touch  > **Settings**.

## About the Calendar Widget

You can add a Calendar widget to your Home screen. The widgets offer different calendar views. Touching a day or event on the widget brings you to the Calendar app.



## Calculator

Your phone comes with a built-in calculator.

1. Touch  >  > **Calculator**.
2. Enter numbers or formulas using the onscreen keys.
3. Do any of the following:
  - Turn your phone sideways to switch to a scientific calculator, and then enter numbers or formulas using the onscreen keys. The scientific calculator lets you



perform more complex calculations with square root, logarithmic, and trigonometric functions.

- Touch  to remove one digit at a time. Touch and hold  or touch **Clear** to delete the entire number.
- Touch  for the result.

## *Clock & Alarm*

Keep track of the time and set alarms easily with your phone's numerous clock and alarm options.

### HTC Clock Widget

#### Open the Clock Application

#### World Clock

#### Alarm Clock

### *HTC Clock Widget*

Use the HTC Clock widget to see your current date, time, and location. You can also use the Clock to show the time in another city.



### Change the Location on the Clock Widget



By default, the Clock widget displays your current weather. You can customize the Clock widget on your Home screen to show the weather of another location.

1. Touch and hold the Clock widget and then drag it to the **Edit** button.
2. Choose a city. If you don't see the city that you want, touch  to search for it and add it.
3. Touch **Done**.

**Tip:** You can add more than one Clock widget to the extended Home screen.

### *Open the Clock Application*



Get more from the Clock app than just the regular date and time. Use your phone as a world clock to see what time it is in cities across the globe. You can also set alarms or track your time using the stopwatch or timer.

To open the Clock app, touch  >  > **Clock**. Touch the tabs on the bottom row or slide your finger across the tabs to switch between the different functions.



## World Clock

Set your clock to the time zone of your home city and/or other cities around the world.

### Set Your Home City



1. Touch  >  > **Clock** > **World Clock** tab.
2. Touch  > **Home settings**.
3. Enter your home city's name.
4. Scroll through the list and touch your home city.

### Manually Set the Time Zone, Date, and Time





1. Touch  >  > **Clock** > **World Clock** tab.
2. Touch  > **Local time settings**.
3. Clear the **Automatic date & time** and **Automatic time zone** options and then set the time zone, date, and time as required.

For more information, see [Date & Time Settings](#).

### Add Cities to the World Clock Screen

1. Touch  >  > **Clock** > **World Clock** tab.
2. Touch .
3. Enter the city name you want to add.
4. Scroll through the list and touch the city that you want to add.

### Delete or Rearrange Cities on the World Clock List

1. Touch  >  > **Clock** > **World Clock** tab.
2. Touch .
3. Do one of the following:
  - To remove a city, touch  next to the city, and then touch **Delete**.
  - To rearrange the cities, touch and hold  next to the city you want to move, and then drag it to its new position.

## Alarm Clock

You can set up one or more alarms.



1. Touch  >  > **Clock** > **Alarms** tab.

2. Select the check button of an alarm and then touch that alarm.
3. Under Set alarm, drag your finger up or down to roll the time scroll wheels and set the alarm time.
4. If you want the alarm to recur, touch **Repeat** and set when you want the alarm to go off.
5. Touch **Done**.

**Tip:** To turn off an alarm, clear the check buttons of that alarm.



If you need to set more than three alarms, touch **+**.

## Delete an Alarm

1. Touch  >  > **Clock** > **Alarms** tab.
2. Touch .
3. Select the alarms you want to delete, and then touch **Delete**.



## Change Alarm Settings





If you've set one or more alarms, you can change their settings such as the alarm volume, how long to snooze the alarm, and more.

1. Touch  >  > **Clock** > **Alarms** tab.
2. Touch  > **Settings**, and then change any of the following:
  - **Alarm in silent mode** (this is selected by default): Allows the alarm to sound even when your phone is in silent mode. Clear this option if you want to silence the alarm when the volume is in silent mode.
  - **Alarm volume**: Set the volume level that you want for the alarm.
  - **Snooze duration**: Set how long to snooze between alarms.
  - **Side button behavior**: Determines what happens to the alarm when you press the volume buttons. You can set the buttons to snooze or dismiss the alarm, or disable the button. The side button works only when the phone's screen is not locked. While on the lock screen, you can snooze or dismiss the alarm by touching and holding the **Snooze** or **Dismiss** button and then dragging it inside the ring.





## Stocks

Use the Stocks application to get the latest stock updates for stock quotes and market indices you follow.

1. Touch  >  > **Stocks**.
2. In the Stocks main screen, do any of the following:
  - Touch an item to view from the list of stock quotes and market indices.

- Touch  to update the stock information.
  - Touch  > **Add** to add a stock quote or stock market index.
  - To change the stock list order, touch  > **Edit**. Touch and hold  at the end of the item you want to move, and then drag it to its new position.
3. When you've selected a particular stock quote or stock market index, you can:
- View an item's trade information as well as its price chart for a specific period.
  - Touch another date period to view an item's past trade information.



### Add a Stock Quote or Stock Market Index

1. Touch  >  > **Stocks**.
2. Touch  > **Add**.
3. Enter the stock quote or stock market index on the text field, and then touch .
4. Touch the stock quote or stock market index you want to add.

**Tip:** To delete an item, touch  > **Edit** while on the Stocks main screen. Select the items you want to delete, and then touch **Delete**.

## Weather

Use the Weather app and widget to check the current weather and weather forecasts for the next few days. In addition to your current location, you can view weather forecasts for other cities around the globe.

1. Touch  >  > **Weather**.  
The options for hourly and four-day forecasts are displayed.
2. While viewing forecasts, you can:
  - Swipe your finger up or down the screen to check the weather in other cities.
  - Touch  to update the weather information at any time.
  - Touch the screen to view weather information such as temperature, approximate time of sunset and others.

**Note:** Your settings in the Weather app also control the weather information that is shown in the Clock and Calendar.





### Add a City to the Weather Screen

Add more cities to the Weather screen so you can instantly check the weather forecasts in these cities. In addition to your current location, the Weather screen can display up to fifteen cities.



1. Touch  >  > **Weather**.

2. Touch **+**.
3. Enter the location you want to add.
4. Touch the city that you want.

### Change the Order of Cities on the Weather Screen

1. Touch  >  > **Weather**.
2. Touch  > **Edit**.
3. Touch and hold  at the end of the item you want to move, and then drag it to its new position.
4. Touch **Done**.

### Delete Cities from the Weather Screen

1. Touch  >  > **Weather**.
2. Touch  > **Edit**.
3. Select the cities you want to remove, and then touch **Done**.

## Tasks

Use the Tasks application to organize and track to do and task lists. You can save tasks on your phone or sync them with your Microsoft Exchange ActiveSync and Google Accounts. You can view these tasks in the Calendar application.

- ▶ To open the Tasks application, touch  >  > **Tasks**.
- ▶ To switch between task accounts, touch  and then touch another account.

[Create a Task](#)

[Link a Task to a Contact](#)

[Link a Task to a Location](#)

[Manage Tasks](#)

[View the Unified Task List](#)

[Create a Task List](#)



[Manage Task Lists](#)

[Back Up or Restore Tasks](#)

[Change Tasks Settings](#)

## Create a Task

Create detailed tasks to help organize your day.

1. Touch  >  > **Tasks**.
2. Enter the task name in the New task text box.

**Tip:** If you want to create a task and enter the details later, touch  after you've entered the task name.

3. Touch  and then enter the task details.
4. Touch **Save**.

## Link a Task to a Contact

Helping friends out on a project or event? Link a task to a contact in the People application so that when your friend calls, the task will appear on the screen. You can also filter tasks to show what tasks are associated to a specific contact.



**Note:** Only tasks under My Tasks can be linked to a contact.

1. Create a new task.
2. While entering the details of the task, touch the text box under People, and enter a name.
3. If you want to link the task to a contact in the People application, touch .
4. Select the contact, and then touch **Save**.
5. Fill in the rest of the details, and then touch **Save**.





## Link a Task to a Location

Link tasks to a location so that the next time you are in an area, you can check which errands you can do along the way.

**Note:** Only tasks under My Tasks can be linked to a location.





1. Create a new task.
2. While entering the details of the task, touch the text box under Location and enter a location.
3. To specify an area in the map, touch .
4. Move  to an area.
5. Touch **Done**.
6. Enter a name for the location.
7. Fill in the rest of the details, and then touch **Save**.

The task is plotted on a map with other tasks linked to locations.

- To view these tasks on a map, touch  on the Tasks main screen. Pan across the map until  (location indicator) appears. The location indicator shows how many tasks are linked to that location.
- To view the details of the task, touch .
- To view your location on the map, touch  > **Locate me**.

## Manage Tasks

The Tasks app comes with tools that let you mark delete, edit, and sort your tasks.

1. Touch  >  > **Tasks**.
2. Go to the list that contains the task.
3. In the list of tasks, you can:
  - **Mark a task complete.** Touch the check buttons next to the task. To view completed tasks, touch  > **Completed**.
  - **Sort tasks.** Touch  > **Sort**, and then select how you want to sort the tasks.
  - **Edit a task.** Touch and hold the task that you want to edit, and then touch **Edit**. Edit the task details, and then touch **Save**.
  - **Delete a task.** Touch and hold the task that you want to delete, and then touch **Delete**.
  - **Postpone a task.** Touch and hold an overdue task, and then touch **Postpone**. Select how long you want to postpone the task.
  - **Move a task to another list.** You can only move the task to another list that is under the same account. Touch and hold the task that you want to move, and then touch **Move to**. Select where you want the task to appear.

## View the Unified Task List

You can view and update a unified list of tasks. Tasks are color coded so you can easily distinguish which accounts they belong to.

1. Touch  >  > **Tasks**.
2. Touch  > **All accounts**.





**Tip:** If you want to view tasks that are stored in your phone, touch **My tasks**.

To filter tasks:

1. Go to the list that contains the tasks that you want to filter.
2. Touch .
3. From the list, choose how you want to filter the tasks.



## Create a Task List

Use a task list to group related tasks. You can create a list for personal errands or for work-related tasks.

1. Touch  >  > **Tasks**.
2. Touch  > **Lists**.
3. Touch , and then choose an account for the list.
4. Enter a name for the list, and then touch **OK**.





## Manage Task Lists

Organize your tasks better by managing your task lists.

1. Touch  >  > **Tasks**.
2. Touch  > **Lists**.
3. From here, you can:
  - **Show or hide tasks or lists.** To show all tasks, touch **All lists**. Touch a specific account and then touch the list that you want to show. Touch **All lists** under each account to show all the tasks under that account.
  - **Rename a list.** Touch an account, touch and hold the list that you want to rename, and touch **Rename**.
  - **Delete a list.** Touch an account, and then touch and hold the list that you want to delete. Touch **Delete**.





## Back Up or Restore Tasks

Back up important tasks to your phone's storage. You can also restore these tasks later.

1. Touch  >  > **Tasks**.
2. Touch  > **Lists**, and then to the list that contains the tasks you want to back up.
3. Touch  > **Import/Export**.
4. Touch **Export to phone storage** to back up your tasks, or touch **Import from phone storage** to restore tasks on your phone.

## Change Tasks Settings

Follow these instructions to change the Tasks app settings.

1. Touch  >  > **Tasks**.
2. Touch  > **Settings**.
3. Change the settings and touch .



## Online Storage

Enjoy the benefits of online storage by using cloud services like Dropbox and SkyDrive to store and share documents, photos, videos, etc. online.

[Dropbox](#)

[SkyDrive](#)

### Dropbox

With Dropbox integration on your phone, you'll always have access to your photos, videos, and documents anywhere, anytime. You can access, edit, or view them on your phone, your computer, and your other mobile phones where you have Dropbox access.

On your phone, set up your Dropbox account so you can:

- Enjoy an additional 23GB of free Dropbox storage for two years.
- Access your photos and videos that are stored in Dropbox right from Gallery.
- No more large attachments when sharing by email. Simply send a link to your Dropbox files.
- Access, edit, and save documents that are stored in Dropbox.
- Check your remaining Dropbox storage space anytime.
- Search for files. Just include Dropbox as one of the searchable items in Google Search.

### About the Additional Free Dropbox Storage Offer



The additional 23GB Dropbox storage is a special offer that's available on your phone and other HTC phones using Android™ with HTC Sense™ 4.0. This offer is available to both new and current Dropbox users.

- To get this additional Dropbox storage free for two years, please set up your Dropbox account from your HTC phone (and not from your computer or other non-HTC phones), and complete the getting started wizard on the Dropbox website ([www.dropbox.com/gc](http://www.dropbox.com/gc))
- If you're a new Dropbox user, setting up your Dropbox account from your HTC phone gives you 2GB default storage plus the additional 23GB storage space.
- This additional free storage is a one-time offer only. You're eligible to use this offer only on one HTC phone.
- You won't be able to use this offer again if you create or sign in to Dropbox with a different account.

### Set Up Your Dropbox Account

To get your additional 23GB of free Dropbox storage for two years, set up your Dropbox account from your HTC phone, and complete the getting started wizard on the Dropbox Web

page. Follow these steps if you have not set up your Dropbox account when you first turn on your phone.



1. Open the Notifications panel, and then touch  > **Accounts & sync**.
2. Touch  > **Dropbox**.
3. Follow the onscreen instructions to create or sign in to your account.
4. Using your computer's Web browser, go to [dropbox.com](https://dropbox.com), log in to your account, and complete the getting started guide.

**Tip:** From the Home screen, you can also touch  > **Dropbox** to use the Dropbox application to set up your account.

## Share Your Photos and Videos on Dropbox

Use Gallery to upload your photos and videos to Dropbox. You can then share the link to your Dropbox so that your friends can see your photos and videos.

To upload your photos and videos to Dropbox from the Gallery app:



1. Touch  >  > **Gallery**.
2. Touch the album that contains the photos or videos you want to share.
3. Touch **Share** > **Dropbox**.
4. Select the photos or videos you want to upload, and then touch **Next**.
5. Create or choose a folder in Dropbox, and then touch **Upload**.

**Tip:** To view your uploads right from Gallery, put them under the Photos folder in your Dropbox. Or under Photos, create a folder and upload them to this folder.

**Note:** Your new camera shots will be uploaded automatically if you turned on the Camera Upload feature when you set up your Dropbox account on your phone. If you didn't turn it on before, open the Dropbox app on your phone, and then touch  > **Settings** > **Turn on Camera Upload**. Select the data connection to use for uploading photos and videos, and then touch **Turn on**.

## View Uploaded Photos and Videos from Gallery

The Camera Uploads folder and subfolders under the Photos folder in your Dropbox can be accessed from Gallery. They will appear as albums.



1. Touch  >  > **Gallery**.
2. Touch  > **Dropbox**.
3. When you see a message that shows HTC Sense wants to access Dropbox, make sure you touch **Allow**.

**Note:** This message only appears the first time you access your Dropbox photos and videos from Gallery.

4. Touch an album to view the photos and videos in it.

## Share the Link to Your Photos and Videos in Dropbox



Share the link to your entire album of photos and videos that's in your Dropbox so other people can access it.

1. Touch  >  > **Gallery**.
2. Touch  > **Dropbox**.
3. Touch an album, and then touch **Share**.
4. Choose how you want to share the link to this album such as send it by email or post it to your social networks.

**Tip:** Use the Dropbox application if you want to share just a single photo or video. Touch  that appears next to the file, and then touch **Share**.

## Send Links to Dropbox Files by Email

No more attaching files to your email. Using the Mail application, you can easily include the links to your Dropbox files and send them in your email.

1. Touch  >  > **Mail**.
2. If you have several email accounts, switch to an email account you want to use.
3. Create a new email message and fill in your recipients, or reply to an email.
4. You can:
  - Touch **Attach** > **Document**, and then choose a document type.
  - Touch **Attach** > **File** if you want to choose any file type.
5. Touch **Dropbox**.
6. Open the folder that contains the files that you want, and then select the files you want to share.
7. Touch **Done**. You'll then see the links to your selected files added to your email message.
8. Touch **Send**.



## Keep Your Documents in Dropbox

You can open a document on your phone and save it to your Dropbox. You can also view or edit a document that's stored in your Dropbox.



1. Open a document, worksheet, or presentation attached to an email or downloaded from the Web.
2. While viewing the file, touch  > **File** > **Save as**.

3. Enter a new filename.
4. Touch **Location > Dropbox**.
5. Touch **Save**.

Your document will be saved to the Polaris Office folder in the root of your Dropbox folder.

**Tip:** To save the document to another Dropbox folder, touch  > **File > Share > Dropbox**. Select the Dropbox folder or touch  to create a new folder, and then touch **Upload**.

### Edit an Office Document in Dropbox

1. Touch  >  > **Dropbox**.
2. Open the folder that contains the document you want to view or edit.
3. Touch the document to open and view it.
4. To make changes, touch **Edit**.
5. After editing the document, touch  > **File**.
6. Save the document, or save it as a new file in Dropbox.

### Save a PDF to Dropbox

1. Open a PDF attached to an email or downloaded from the Web.
2. Touch  > **Save as**.
3. Enter a new filename.
4. Touch **Location > Dropbox**.
5. Touch **OK**.

Your document will be saved to the PDFViewer folder in the root of your Dropbox folder.

**Tip:** To save the PDF to another Dropbox folder, touch  > **File > Share > Dropbox**. Select the Dropbox folder or touch  to create a new folder, and then touch **Upload**.

### Check Your Dropbox Storage Space

You can check how much storage space you still have in your Dropbox before you upload more content.

**Important:** Before your Dropbox storage info appears in the phone settings, you need to access your Dropbox from an application first (such as Gallery) and allow HTC Sense to access your Dropbox.

1. Open the Notifications panel, and then touch  > **Storage**.
2. Under Online storage, you'll see your available Dropbox storage.

## Unlink Your Phone from Dropbox

If you lose your HTC phone, you can remotely unlink from your Dropbox account.

1. On your computer's Web browser, go to [dropbox.com](https://dropbox.com) and log in.
2. On the right-hand corner of any page on the Website, click **Account**. (Or click your account name, and then click **Settings**.)
3. Click the **My Computers** tab.
4. Click **Unlink** to the right of your Android phone.
5. Click the **My Apps** tab.
6. Click the **X** mark next to HTC Sense.

## SkyDrive



With SkyDrive® online storage, you can keep all your photos and documents in one place. You can access them anytime on your phone, your computer, and your other mobile phones where you have SkyDrive access.

You can:

- Use Gallery to upload your photos. You'll also be able to access your photos that are stored in your SkyDrive storage.
- No more large attachments when sharing by email. Simply send a link to your files that are stored in SkyDrive.
- Edit your Office documents or view your PDF documents that are stored in SkyDrive
- Save documents from your phone directly to your SkyDrive storage.



## Sign In to SkyDrive

To use SkyDrive as your online storage, sign in using your Windows Live® ID.

1. Open the Notifications panel, and then touch  > Accounts & sync.
2. Touch  > **SkyDrive for HTC Sense**.

Follow the onscreen instructions to sign in, or to create your Windows Live ID first if you don't have one yet.



## Upload Your Photos to SkyDrive from Gallery

1. Touch  >  > **Gallery** > **Albums**.
2. Touch the album that contains the photos that you want.
3. Touch **Share** > **SkyDrive for HTC Sense**.
4. Select one or more photos you want to upload, and then touch **Next**.

5. Select a folder in SkyDrive, and then touch **Done**.

## Send the Links to SkyDrive Files by Email

To share your files stored in SkyDrive by email, you don't need to download them and attach to your message. Using the Mail app, you can easily include the links to your SkyDrive files and send them in your email.

1. Touch  >  > **Mail**.
2. If you have several email accounts, switch to an email account you want to use.
3. Create a new email message and fill in your recipients, or reply to an email.
4. You can:
  - Touch **Attach** > **Document**, and then choose a document type.
  - Touch **Attach** > **File** if you want to choose any file type.
5. Touch **SkyDrive**.
6. Open the folder that contains the files that you want, and then select the files you want to share.
7. Touch **Done**. You'll then see the links to your selected files added to your email message.
8. Touch **Send**.

## Keep Your Documents in SkyDrive

You can open an Office document or PDF and save it to your SkyDrive online storage.

To save an Office document to SkyDrive:

1. Open a document, worksheet, or presentation attached to an email or downloaded from the Web.
2. Touch  > **File** > **Save as**.
3. Enter a new filename.
4. Touch **Location** > **SkyDrive**.
5. Touch **Save**.

**Tip:** After opening a document, you can also touch  > **File** > **Share** > **SkyDrive for HTC Sense** to upload the document to a SkyDrive folder.

To save a PDF to SkyDrive:

1. Open a PDF attached to an email or downloaded from the Web.
2. Touch  > **Save as**.
3. Enter a new filename.

4. Touch **Location** > **SkyDrive**.
5. Touch **OK**.

**Tip:** After opening a document, you can also touch **☰** > **Share** > **SkyDrive for HTC Sense** to upload the document to a SkyDrive folder.

## *HTC Sync Manager*

With HTC Sync Manager, enjoy the same rich media whether you're at your computer or on the move. Use it also to store your same contacts, important documents, and other data on both your phone and your computer.

HTC Sync Manager is the replacement for HTC Sync, and it provides a lot more features.

- Play music and videos using the built-in player. You can also play iTunes® and Windows Media® Player playlists.
- Manage your library of music, photos, and videos on your computer.
- Get music from your CDs to your computer.
- Sync photos, videos, music, playlists, and albums between your phone and your computer.
- Sync information such as contacts, calendar, documents, and web bookmarks between your phone and your computer.

This software works on both Windows and Mac®.

[Install HTC Sync Manager](#)

[Get Started with HTC Sync Manager](#)

[Import More Media to the Library](#)

[Add New Media to Your Library Automatically](#)

[Check for New Software Updates](#)

[HTC Sync Manager Supported File Formats](#)

[Play Music in HTC Sync Manager](#)

[Create a Playlist in HTC Sync Manager](#)

[View Photos and Videos in HTC Sync Manager](#)

[Set Up HTC Sync Manager to Recognize Your Phone](#)

[Set Up Your Phone to Sync with your Computer](#)

[Syncing Your Phone and Your Computer](#)

## Ripping Music from a CD with HTC Sync Manager

### *Install HTC Sync Manager*

Before you install, please visit our HTC website to check the system requirements for HTC Sync Manager.

**Important:** For trouble-free installation, first quit all running programs and temporarily exit from your anti-virus program before you start installing HTC Sync Manager.

You need to have administrator rights if you're installing HTC Sync Manager on Windows Vista® or later versions:

#### Install on a Windows Computer

1. Connect your phone to your computer using the supplied USB cable.
2. On the Choose a connection type screen of your HTC phone, select **HTC Sync Manager**, and then touch **Done**.
3. When you see the AutoPlay window appear on your computer screen, click **HTC Sync Manager**.  
If there's no HTC Sync Manager found on your computer, your Web browser will automatically open and take you to the HTC website.
4. Download the HTC Sync Manager installer to your computer.
5. Double-click the installer you've downloaded and follow the onscreen instructions to install HTC Sync Manager.

#### Install on a Mac Computer

1. Go to the [htc.com](http://htc.com) support page and download the HTC Sync Manager **dmg** file to your computer.
2. Double-click the dmg file you've downloaded.  
An icon representing the mounted dmg file is then created on your desktop.
3. Double-click the icon of the mounted dmg file.
4. When a window opens, drag the HTC Sync Manager software icon to the Applications folder or to another location in this window.

**Note:** After installing, it is recommended that you unmount the mounted dmg file. Just drag the icon representing the mounted image file to the Trash, or right-click the icon and click **Eject**.

Don't delete the dmg image file. Save it to a folder in case you need to reinstall HTC Sync Manager.

### *Get Started with HTC Sync Manager*



The first time you open HTC Sync Manager, the Getting Started window opens, allowing you to add media to your library.



1. Open the HTC Sync Manager.
2. When you see the Getting Started window, you can choose to:
  - **Automatically discover Media on My PC.** Automatically search for all music, photos, and videos on your computer and add them to your HTC Sync Manager library.
  - **Manually Import or Add Media from My PC.** Choose folders to import media files from. You can also import media files and playlists from other media applications.
3. If you chose to manually import media files, click **OK** to start importing them to your library.

## The HTC Sync Manager Main Screen

From the main screen, you can see your media libraries and play your media. You can also sync with your phone when it's connected, or rip music when there's a CD inserted on your computer.

- Click **Music** or **Gallery** to switch between these two libraries. While you're in one of these libraries, click to return to the previous screen.
- Play a music track or video. Use the controls at the bottom center of the screen to control the playback.
- Click  to change settings, check for software updates, and more.
- Clicking  opens a menu, showing a list of connected phones.
  - If your phone is connected to your computer, click it on the menu to set up how you want to sync media and data.
  - If you inserted a music CD, click the disc drive on the menu to rip music from the CD.

## Import More Media to the Library

To import more media to your HTC Sync Manager library, there are several easy ways you can do this.

- Click **Music** > **LIBRARY**, and then drag a folder (or any music file inside that folder) to the LIBRARY screen.
- Click **Gallery** > **ALBUMS**, and then drag a folder (or any photo or video file inside that folder) to the ALBUMS screen.
- Set up HTC Sync Manager to check for new music, photos, and videos from selected folders on your computer and import them to your library automatically.

**Note:** When you drag a folder or media file, the whole folder will be added as an album to the library. The folder path will also be added to the list of watched folders in the settings.

## Add New Media to Your Library Automatically

You can set HTC Sync Manager to automatically add media to your library whenever there are new music, photos, or videos on your computer. Simply add the folders to the Watched Folder in settings that you want HTC Sync Manager to check for new media.

1. From the main screen, click  > **Settings**.
2. In the Music library settings:
  - Click **Add** to choose folders that you want HTC Sync Manager to check for new music files.
  - Click **Import** to choose what other media applications on your computer (such as iTunes and Windows Media Player) you want to import music from.
  - Click **Import playlist** to get playlists from other media applications.
3. Click **Gallery library** > **Add** to choose folders that you want HTC Sync Manager to check for new photos or videos.
4. Click **Apply** to save your settings.
5. Click **OK**.

## Check for New Software Updates

Make sure that you have the latest HTC Sync Manager version.

1. Click  > **Check for updates**.
2. When an update is available, you can choose to download and install it immediately on your computer.

You'll need to close HTC Sync Manager when you're prompted, and then re-open the application after the installation is complete.

## HTC Sync Manager Supported File Formats

Here is a list of supported file formats.

Video formats and codecs	<ul style="list-style-type: none"><li>• 3GP and 3G2 (3rd Generation Partnership Project)</li><li>• MP4 (MPEG-4)</li></ul>
Audio formats and codecs	<ul style="list-style-type: none"><li>• AAC and M4A (Advanced Audio Coding)</li><li>• FLAC (Free Lossless Audio Codec)</li><li>• AAC and M4A (High Efficiency AAC v1 and v2)</li><li>• MP3 (MPEG-1 Audio Layer 3)</li><li>• WAV (Resource Interchange File Format)</li><li>• WMA (Windows Media Audio)</li></ul>
Image formats	<ul style="list-style-type: none"><li>• BMP</li></ul>

	<ul style="list-style-type: none"><li>• GIF</li><li>• JPEG and JPG</li><li>• PNG</li></ul>
--	--

**Note:** WMA and WAV formats are only supported in Windows.

## *Play Music in HTC Sync Manager*

Are you a music junkie with a big collection of digital music on your computer? Manage your music library and enjoy listening to your favorite songs from HTC Sync Manager.

1. In HTC Sync Manager, click **Music**. By default, you'll see the RECENT screen where recently added or played songs and albums are displayed.
2. To browse for your songs and albums, click **LIBRARY**, and then select an album to open.
3. Double-click a song to play it.
4. Use the playback controls at the bottom of the screen to pause, resume playback, repeat songs, and more.

**Tip:** At the bottom-left side of the screen, drag the progress bar slider  to jump to any part of the song.

**Note:** Switching to another screen will not stop music playback. You'll see the song title and album that's currently playing at the bottom of the screen.

## *Create a Playlist in HTC Sync Manager*

Enjoy your favorite songs for different occasions by creating a playlist.

1. From the Music library, click an album or song that you want to add to a new playlist.
2. Click **Add to playlist > New playlist**.
3. Enter a playlist name, and then click **OK**.
4. To add more songs to the playlist, hold down the CTRL key while clicking one or more albums or music tracks, click **Add to playlist**, and then select the playlist name.
5. When you're done adding songs, click **PLAYLIST**. Double-click the playlist thumbnail and start playing.

**Tip:** To send just a single playlist to your phone, right-click the playlist, click **Send to phone**, and then choose the phone name. (Be sure that your phone is connected to your computer.)

## *View Photos and Videos in HTC Sync Manager*

Browse through and view your computer's photos and videos that you've imported to the HTC Sync Manager Gallery.

1. In HTC Sync Manager, click **Gallery**. By default, you'll see the RECENT screen where recently added or viewed photos and videos are displayed.
2. Click **ALBUMS**, and then double-click an album to open it.
3. Click ▼ next to **Sort by** and choose how you want to arrange your photos and videos.
4. Double-click a photo or video to see a larger view.

**Tip:** To move several photos or videos to another album, mouse over and select the check button of each photo or video you want to move. Then click **Move to album**.

## Edit Your Photos

You can do basic photo edits such as cropping and rotating.

1. Open the album that contains the photos you want to edit.
2. Mouse over and select the check button of each photo you want to edit.
3. Click . A screen then opens, showing a thumbnail strip of all your selected photos.
4. On the thumbnail strip, click the first photo, and then choose what you want to do with the photo.
  - **See photo information.** Click **Detail** to see information such as resolution, file format, and more.
  - **Rotate.** Click **Rotate right** or **Rotate left**.
  - **Crop.** Click **Crop**, resize or drag the crop box to the part of the photo you want to crop. You can also click **Custom**, and then select a preset photo size. Click **Apply**.
5. Move to the next photo. You'll be asked to save your changes to the current photo.
6. Click **OK** to save and edit the next photo.

**Tip:** To send just one edited photo to your phone, click **Send to phone**, and then choose the phone name. (Be sure that your phone is connected to your computer.)

## Set Up HTC Sync Manager to Recognize Your Phone

Connect your phone to your computer with HTC Sync Manager and start syncing contacts, media and more.

1. Connect your phone to your computer using the USB cable that comes in the box.
2. When your phone prompts you to choose a type of USB connection, touch **HTC Sync Manager**, and then touch **Done**. Wait for HTC Sync Manager to recognize and connect to your phone.
3. If this is your first time to connect your phone to your computer, enter a phone name, choose the storage on your phone to sync with, and then click **Save**.

## Set Up Your Phone to Sync with your Computer

Set your phone to automatically sync content with your computer.

1. When you see your phone connected in HTC Sync Manager, click ▼ and then click your phone name.
2. On the Synchronize Settings screen, set up how you want to sync your media and data between your phone and your computer.

### Sync Music

You can set up HTC Sync Manager to sync music files and playlists between your phone and your computer.

1. On the Synchronize Settings screen, click  next to the Music item.
2. Click the **On** button.
3. You can choose the following options:
  - **Import new music from phone.** Select this option to import new music found on your phone to HTC Sync Manager. The music files will be copied to the folder specified in the Import settings.
  - **Sync music to phone.** Select this option to sync music from your computer to your phone. Select to sync **All Music** or only **Selected Playlists**.
4. In cases when there are conflicting playlists on your phone and your computer, choose which playlist you want to keep.
5. Click **Done** to save your music sync settings.

### Sync Photos and Videos

1. On the Synchronize Settings screen, click  next to the Gallery item.
2. Click the **On** button.
3. You can choose the following options:
  - **Copy phone photo and video.** Select this option to import new photos and videos from your phone to HTC Sync Manager. The photos and videos will be copied to the folder specified in the Import settings.
  - **Sync albums to phone.** Select this option to sync Gallery albums from HTC Sync Manager to your phone. Select to sync **All Albums** or only **Selected Albums**.
4. Click **Done** to save your sync settings.

### Sync Documents and Email Attachments

**Important:** To sync email attachments received on your phone to your computer, you must set up an Exchange ActiveSync or POP3/IMAP email account from the Mail application on your phone.

1. On the Synchronize Settings screen, click  next to the Calendar item.
2. Click the **On** button.
3. To sync email attachments received and stored on your phone, select **Copy all downloaded mail documents to PC**.
4. To choose folders on your computer that contain documents you want to sync with your phone, select **Sync PC documents from directory**, and then click **Add**.
5. Click **Done** to save your sync settings.

## Sync Your Contacts

Set up HTC Sync Manager to sync your phone with your Outlook, Outlook Express, or Windows Contacts. You can sync your phone with the following Outlook versions: Outlook XP, Outlook 2003, Outlook 2007, and Outlook 2010.

1. On the Synchronize Settings screen, click  next to the People item.
2. Click the **On** button.
3. Choose the application you want to sync your contacts from.
4. In cases when conflicting information is found on both your phone and your computer, select which contact data you want to keep.
5. Click **Done** to save your sync settings.

**Note:** Only the contact fields that are in the People application on your phone will be synced.

## Sync Your Calendar Events

Set up HTC Sync Manager to sync your phone with your Outlook Calendar or Windows Calendar on your computer. You can sync your phone with the following Outlook versions: Outlook XP, Outlook 2003, Outlook 2007, and Outlook 2010.

1. On the Synchronize Settings screen, click  next to the Calendar item.
2. Click the **On** button.
3. Select the application you want to sync calendar events from.
4. Choose from when you want to start syncing calendar events.
5. In cases when conflicting appointments are found on both your phone and your computer, select which data you want to keep.
6. Click **Done** to save your sync settings.

**Note:** Only the data fields that are in your phone's Calendar will be synced.

## Sync Your Web Bookmarks

1. Open the Web browser on your computer, create a favorites folder named **HTC bookmarks**. Make sure to save your favorite bookmarks in this folder to be able to sync them with your phone.
2. On the Synchronize Settings screen of HTC Sync Manager, click  next to the Bookmarks item.
3. Click the **On** button.
4. Choose which Web browser on your computer stores the bookmarks you want to sync with your phone.
5. Click **Done** to save your sync settings.

## Syncing Your Phone and Your Computer

**Important:** Before you start syncing, check and make sure your phone is connected to your computer and is recognized by HTC Sync Manager.

To avoid sync problems, be sure to close all browser windows before you start syncing Web bookmarks.

When conflicting bookmarks are found on both your phone and your computer, HTC Sync Manager keeps the information from your computer.



After you've finished setting up all the items you want to sync in HTC Sync Manager, click the Sync button on the Synchronize Settings screen to start syncing your phone and your computer.

## Ripping Music from a CD with HTC Sync Manager

With HTC Sync Manager, you can play and rip audio CDs. You can then sync music with your phone.

1. Insert an audio CD into your computer's CD drive.  
HTC Sync Manager prompts you that a new disc is inserted. Click **OK** to show the disc contents.

**Tip:** You can also click , and then select the name of the CD inserted.

2. From the list of music tracks available, click a music track that you want to rip.  
To select multiple files, hold down the CTRL key while clicking one or more music tracks.
3. Click **Import** to start ripping the audio files.
  - You'll see this icon  beside the music track when ripping is in progress or this icon  if the music track is in the queue.
  - When ripping music is complete, audio files are imported to your computer, and this icon  appears beside the selected tracks.

**Note:** To check where the ripped music tracks are saved, click  > **Settings** > **Rip CD**.

## Voice Recorder



Use Voice Recorder to capture information during lectures, interviews, or even to create your own audio log.

### Record Your Voice

#### Set a Voice Clip as a Ringtone

## Record Your Voice

Start creating voice memos on your phone.

1. Touch  >  > **Voice Recorder**.
2. Hold the microphone near the sound source.
3. Touch  to start recording a voice clip.

**Note:** Voice Recorder can run in the background while you do other things on your phone, except when you open other applications that also use audio functions.



4. Touch  to stop recording.
5. Type a name for the voice clip and touch **Save**.

To play back the voice clip, touch .

**Tip:** To show options for deleting or renaming the voice clip, touch .

## Set a Voice Clip as a Ringtone

You can use recorded voice as ringtone.

1. Touch  >  > **Voice Recorder**.
2. On the Voice Recorder screen, touch .
3. Touch and hold the voice clip you want to set as a ringtone, and then touch **Set as ringtone**.

## Bluetooth and NFC

Bluetooth is a short-range communications technology that allows you to connect wirelessly to a number of Bluetooth devices, such as headsets and hands-free car kits, and Bluetooth-enabled handhelds, computers, printers, and wireless phones. The Bluetooth communication range is usually approximately 30 feet.

Your phone is also equipped with near field communication (NFC) technology that allows you to send and receive information to and from an NFC-enabled device. Just place the phone's back panel closer to the other device to start exchanging information.

### Turn Bluetooth On or Off



[Change the Phone Name](#)

[Connect a Bluetooth Headset or Car Kit](#)

[Reconnect a Headset or Car Kit](#)

[Disconnect or Unpair From a Bluetooth Device](#)

[Send Information Using Bluetooth](#)

[Where Sent Information is Saved](#)

[Receive Information Using Bluetooth](#)

[Use Bluetooth FTP Server](#)

[Share Content with Android Beam](#)

## *Turn Bluetooth On or Off*



You can turn Bluetooth on or off via the phone settings.

1. Open the Notifications panel, and then touch .
2. Touch the **Bluetooth** On/Off switch to turn it on and off.

**Note:** Turn off Bluetooth when not in use to conserve battery power, or in places where using a wireless phone is prohibited, such as aboard an aircraft and in hospitals.

## *Change the Phone Name*

The phone name identifies your phone when using Bluetooth.

1. Open the Notifications panel, and then touch .
2. If Bluetooth is off, touch the **Bluetooth** On/Off switch to turn it on.
3. Touch **Bluetooth**. The Bluetooth screen opens.
4. Touch , and then touch **Rename phone**.
5. Enter the new name for your phone, and then touch **Rename**.

## *Connect a Bluetooth Headset or Car Kit*

You can listen to music over a Bluetooth stereo headset, or have hands-free conversations using a compatible Bluetooth headset or car kit.

**Important:** For you to listen to music with your headset or car kit, the headset or car kit must support the A2DP Bluetooth profile.

Before you connect your headset, you need to make it discoverable so your phone can find it. You can find out how to do this by referring to your headset manual.

1. Open the Notifications panel, and then touch .

2. If Bluetooth is off, touch the **Bluetooth** On/Off switch to turn it on
3. Touch **Bluetooth**. The Bluetooth screen opens.
4. If you don't see your headset listed, touch  > **Search for phones** to refresh the list.
5. When you see the name of your headset in the Available phones section, touch the name. Your phone then automatically tries to pair with the headset.
6. If automatic pairing fails, enter the passcode supplied with your headset.

The pairing and connection status is displayed below the hands-free headset or car kit name in the Bluetooth phones section. When the Bluetooth headset or car kit is connected to your phone, the Bluetooth connected icon  is displayed in the status bar.

## *Reconnect a Headset or Car Kit*

Normally, you can easily reconnect your headset by switching on Bluetooth on your phone, and then turning on the headset. However, you might have to connect manually if your headset has been used with another Bluetooth phone.

**Important:** Make sure that the headset is discoverable. Refer to the headset manual for details.

1. Open the Notifications panel, and then touch .
2. If Bluetooth is off, touch the **Bluetooth** On/Off switch to turn it on
3. Touch **Bluetooth**. The Bluetooth screen opens.
4. Touch the headset's name in the Paired phones section.
5. If prompted to enter a passcode, try 0000 or 1234, or consult the headset/car kit documentation to find the passcode.

If you still cannot reconnect to the headset or car kit, follow the instructions in [Disconnect or Unpair From a Bluetooth Device](#), and then follow the steps in [Connect a Bluetooth Headset or Car Kit](#).

## *Disconnect or Unpair From a Bluetooth Device*



If you do not need to use Bluetooth at any given point, you can disconnect and unpair your phone from a Bluetooth device.

### Disconnect a Bluetooth Device

1. Open the Notifications panel, and then touch .
2. Touch **Bluetooth**. The Bluetooth screen opens.
3. In the Paired phones section, touch the name of the phone to disconnect.
4. Touch **OK**.

**Note:** Touch the name of the phone to reconnect it.

## Unpair From a Bluetooth Device

1. Open the Notifications panel, and then touch .
2. If Bluetooth is off, touch the **Bluetooth** On/Off switch to turn it on.
3. Touch **Bluetooth**. The Bluetooth screen opens.
4. In the Paired phones section, touch  next to the phone to unpair.
5. Touch **Unpair**.







## Send Information Using Bluetooth

You can use Bluetooth to transfer information between your phone and another Bluetooth-enabled phone such as a phone or notebook computer. The first time you transfer information between your phone and another phone, you need to enter or confirm a security passcode. After that, your phone and the other phone are paired, and you will not need to exchange passcodes to transfer information in the future.

**Important:** Before you begin, set the receiving phone to discoverable mode. You may also need to set it to “Receive Beams” or “Receive Files.” Refer to the phone’s documentation for instructions on receiving information over Bluetooth.

You can send the following types of information, depending on the phone you are sending to:

1. On your phone, open the application that contains the information or file you want to send.
2. Follow the steps for the type of item you want to send:

Contact	<ol style="list-style-type: none"><li>1. In the People application, touch a contact to view the contact’s details.</li><li>2. Touch , and then touch <b>Send contact</b>.</li><li>3. Touch the down arrow icon, and then select <b>Bluetooth</b>.</li></ol>
Calendar appointment or event	In Day, Agenda, or Week view, touch and hold the event, and then touch <b>Forward &gt; Bluetooth</b> .
Photos or videos	<ol style="list-style-type: none"><li>1. In the Gallery application, choose an album.</li><li>2. Touch Share &gt; Bluetooth.</li></ol>
Captured photo or video	After capturing, on the Camera preview screen, touch  > <b>Bluetooth</b> . (Note that you must have first set a review duration in Camera settings.)
Music track	With the track displayed on the Music application’s Now playing screen, touch  > <b>Share &gt; Share file &gt; Bluetooth</b> .
Voice recording	On the main Voice Recorder screen, touch  > <b>Bluetooth</b> .
Browser	<ul style="list-style-type: none"><li>• On a webpage you want to share, touch  &gt; Share page &gt; Bluetooth.</li><li>• While viewing a Web page in Reading mode, touch  &gt;</li></ul>

	<b>Bluetooth.</b>
--	-------------------

3. Turn Bluetooth on and pair with the receiving phone, if you're asked to do so.
4. On the receiving phone, accept the file.

### *Where Sent Information is Saved*

When you send information from your phone using Bluetooth, the location where it's saved depends on the type of information and the receiving phone.

If you send a calendar event or contact, it is normally added directly to the corresponding application on the receiving phone. For example, if you send a calendar event to a compatible phone, the event is shown in that phone's calendar application.

If you send another file type to a Windows computer, it is normally saved in the Bluetooth Exchange folder within your personal document folders.

- On Windows XP, the path may be:  
C:\Documents and Settings\[your username]\My Documents\Bluetooth Exchange
- On Windows Vista, the path may be:  
C:\Users\[your username]\Documents
- On Windows 7, the path may be:  
C:\Users\[your username]\My Documents\Bluetooth Exchange Folder

If you send a file to another phone, the saved location may depend on the file type. For example, if you send an image file to another wireless phone, it may be saved in a folder named "Images."

### *Receive Information Using Bluetooth*

Your phone lets you receive various files with Bluetooth, including photos, music tracks, contact info, calendar events, and documents such as PDFs.

**Important:** Refer to the phone's documentation for instructions on sending information over Bluetooth.

1. Open the Notifications panel, and then touch .
2. If Bluetooth is off, touch the **Bluetooth** On/Off switch to turn it on.
3. Touch **Bluetooth**. The Bluetooth screen opens.
4. Touch your phone's Bluetooth name near the top of the screen to make your phone visible to nearby Bluetooth phones.
5. On the sending phone, send one or more files to your phone.
6. If asked, accept the pairing request on your phone and the receiving phone. Also, you may be prompted to enter the same passcode or confirm the auto-generated passcode on both phones.

You'll then get a Bluetooth authorization request.



7. Touch **Pair**.
8. When your phone receives a file transfer request notification, slide the Notifications panel down, touch the incoming file notification, and then touch **Accept**.
9. When a file is transferred, a download notification is displayed. Slide the Notifications panel down, and then touch the relevant notification.

When you open a received file, what happens next depends on the file type:

- Media files and documents are usually opened directly in a compatible application. For example, if you open a music track, it starts playing in the Music application.
- For a vCalendar file, select the calendar where you want to save the event, and then touch **Import**. The vCalendar is added to your Calendar events. (For more information, see [Calendar](#))
- For a vCard contact file, you can choose to import one, several, or all of those contacts to your contacts list.

## *Use Bluetooth FTP Server*

Bluetooth FTP Server allows other phones with Bluetooth FTP profiles to view, access, copy, and delete files from your phone's storage. To use Bluetooth FTP Server, you need to have a microSD card installed in your phone.

1. Open the Notifications panel, and then touch .
2. If Bluetooth is off, touch the **Bluetooth** On/Off switch to turn it on
3. Touch **Bluetooth**. The Bluetooth screen opens.
4. Touch  > **Advanced**, and then select the **FTP Server** check button.
5. Pair your phone with the other Bluetooth phone that you will allow access to your phone's storage. For more information about Bluetooth pairing, see [Connect a Bluetooth Headset or Car Kit](#).
6. When the other phone attempts to access your phone's storage, a Bluetooth Authorization Request appears on the screen. Touch **Accept**.

The contents of your phone's storage appear on the other phone's screen.

## *Share Content with Android Beam*

With built-in NFC (near field communication) on your phone, you can share content to someone's mobile phone in an instant. Beam a Web page you're viewing, contact information, and more by just holding your phone and the other phone back to back.

## NFC Antenna Location

Here is the location of the NFC antenna on your phone (dotted line). When exchanging information using NFC, make sure that the phone's back panel is very close to the other NFC device.

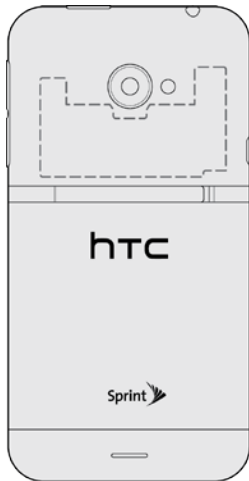

## Turn NFC and Android Beam On

1. Open the Notifications panel, and then touch .
2. Under Wireless & Networks, touch **More**.
3. Select the **NFC** option, and then touch **Android Beam**.
4. Touch the Android Beam **On/Off** switch.

## Beam Content

Make sure that both phones are unlocked and have NFC and Android Beam turned on.

1. While viewing the content that you want to share, hold your phone and the other phone back to back. When the phones connect, you'll hear a sound and both phones will vibrate slightly.
2. Touch the screen.

The shared content appears on the other phone's screen.

## *microSD Card*

You can purchase a microSD™ (Secure Digital) memory card and install it into your phone so you can store more images, videos, music, documents, and voice data.

**Important:** Make sure your battery is fully charged before using the microSD card. Your data may become damaged or unusable if the battery runs out while using the microSD card.

You can easily damage the microSD card by improper operation. Please be careful when inserting, removing, or handling the microSD card.

[Insert the microSD Card](#)

[Remove the microSD Card](#)

[Check the microSD Card Memory](#)

[Erase the microSD Card](#)

[Unmount the microSD Card](#)

[Copy Files to or from the microSD Card](#)

## ***Insert the microSD Card***

Here are the steps for inserting the microSD card.

1. Turn off the phone.
2. Lift the back cover from the notch at the top of the phone.

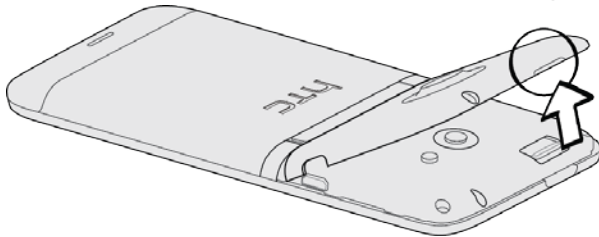

3. Insert the microSD card fully into the slot.

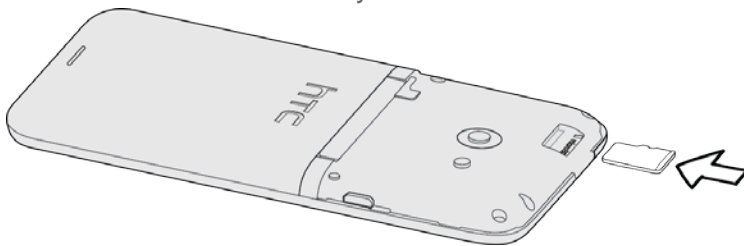

4. Replace the back cover.
5. Turn on the phone.

## ***Remove the microSD Card***

Here are the steps for removing the microSD card.

1. Turn off the phone.

2. Lift the back cover from the notch at the top of the phone.

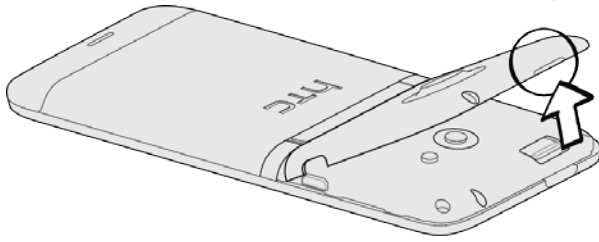

3. Gently pull the microSD card from the slot.

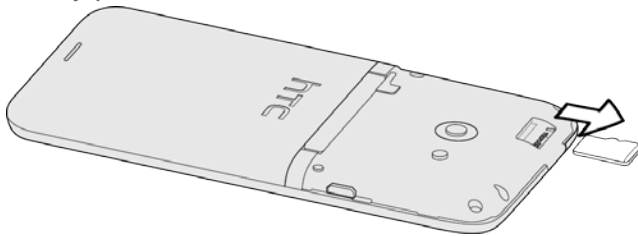

4. Replace the microSD card and the back cover.

## *Check the microSD Card Memory*

Determine how much space you have left on your microSD card by checking its memory.

- ▶ Open the Notifications panel, and then touch  > **Storage**.

The total and available memory space will be displayed.

## *Erase the microSD Card*

Erasing the microSD card permanently removes all files stored on it.

**Note:** When you erase the microSD card, the files **CANNOT** be retrieved. To prevent the loss of important data, please check the contents before you erase the card.

1. Open the Notifications panel, and then touch  > **Storage**.
2. Under Storage card, touch **Unmount SD card**.
3. Touch **Erase storage card** > **Erase storage card** > **Erase everything**.

## *Unmount the microSD Card*

When you need to remove the microSD card while the phone is on, you must first unmount the microSD card. This prevents corrupting the data stored on it or damaging the microSD card. Close all running applications on your phone and save any data before you unmount the microSD card.

1. Open the Notifications panel, and then touch  > **Storage**.
2. Under Storage card, touch **Unmount storage card**.
3. Remove the microSD card. See [Remove the microSD Card](#).



## *Copy Files to or from the microSD Card*

You can copy your music, photos, and other files to the storage card.

1. Connect your phone to your computer using the supplied USB cable.
2. On the Choose a connection type screen, select **Disk drive**, and then touch **Done**. On your computer, the storage card is recognized as a removable disk drive.
3. Navigate to the removable disk drive and open it.
4. Do one of the following:
  - Copy the files from the computer to the storage card's root folder.
  - Copy the files from the storage card to a folder in your computer.
5. After copying the files, unmount the removable disk drive (that is, your connected phone) as required by your computer's operating system to safely remove your phone.
6. Do one of the following:
  - Disconnect your phone from the computer.
  - If you want to keep your phone connected to the computer but want it to be able to access the storage card, open the Notifications panel, touch **Disk drive**, select an option except **Disk drive**, and then touch **Done**.

**Note:** The phone will not recognize the microSD card when it is connected to a computer as a disk drive. You will not be able to use some phone applications that need access to the microSD card.

## *Update Your Phone*

From time to time, updates may become available for your phone. You can download and apply updates through the  (**Settings**) > **System updates** menu.

[Update Your Phone Firmware](#)

[Update the Operating System](#)

[Update Your Profile](#)

[Update Your PRL](#)

## *Update Your Phone Firmware*

You can update your phone's software using the **Firmware update** option. Updating your phone firmware will erase all user data from your phone. You must back up all critical information before updating your phone firmware.

### **Back Up All Data Prior to Update**

To back up your Gmail information:

1. Open the Notifications panel, and then touch  > **Accounts & sync**.
2. Do any of the following:
  - Turn on the **Auto-sync** option. When **Auto-sync** is on, Gmail email, Calendar, and Contacts automatically synchronize whenever a change is made.
  - Touch **Google**, select the items you want to synchronize, and then touch **Sync now**.

To back up your Exchange ActiveSync information:



1. Open the Notifications panel, and then touch  > **Accounts & sync**.
2. Do either of the following:
  - Turn on the **Auto-sync** option. When **Auto-sync** is on, your Exchange ActiveSync email, contacts, and calendar automatically synchronize whenever a change is made.
  - Touch **Exchange ActiveSync**, select the items you want to synchronize, and then touch **Sync now**.

To back up stored text messages:

See [Back Up and Restore Your Text Messages](#).

To back up your Google applications:

Applications you've purchased from Google Play are reloaded remotely and can be re-installed after the update is applied. After the update, make sure that you add your Google Account on the phone.

1. Touch  >  > **Play Store**.
2. Touch  > **My Apps**.
3. Scroll through the list of previously downloaded Google applications and choose the one you wish to reinstall.
4. Follow onscreen instructions.

As an added precaution, to preserve any data on your microSD card, please remove it from your phone before you perform an update.

## Update Your Phone Firmware

Once you have backed up all your data, use the **Firmware update** option to update your phone firmware.

1. Open the Notifications panel, and then touch  > **System updates** > **Firmware update**. Your phone automatically searches, downloads, and installs any available updates.
2. Follow onscreen instructions.

## Confirm Your Current Phone Firmware

- ▶ Open the Notifications panel, and then touch  > **About** > **Software information**.

## *Update the Operating System*

This option allows you to update the phone's operating system (OS) via an over-the-air connection.

1. Open the Notifications panel, and then touch  > **System updates**.
2. Touch **HTC software update** > **Check now**.
3. Follow onscreen instructions to download and install any available updates.

## *Update Your Profile*

This option allows you to automatically update your online user profile information. If you choose to change your user name and select a new one online, you must then update the user name on your phone.

1. Open the Notifications panel, and then touch  > **System updates**.
2. Touch **Update profile** and follow onscreen instructions.

**Note:** If your data services or account syncing ever seems to go out unexpectedly, use this feature to reconnect with the network.

## *Update Your PRL*

This option allows you to automatically download and update the PRL (preferred roaming list).

1. Open the Notifications panel, and then touch  > **System updates**.
2. Touch **Update PRL** and follow onscreen instructions.

# Index

---

- 3G, 136
- 3-way Calling, 44
- 4G LTE, 136
- Accessory Jack, 12
- Account Passwords, 6
- Accounts, 84
  - Settings, 55
- Activation, 4
- Airplane Mode, 51
- Alarm Clock, 176
- Android Beam, 199, 204
- Android Market. See Google Play
- Answer a Call, 39
- Applications, 114
  - App Association, 66
  - Clear App Cache, 65
  - Install Third-Party Apps, 65
  - Settings, 65
  - Stop Running Apps, 66
- Auto-rotate Screen, 59
- Back Key, 10
- Battery
  - Settings, 68
- Battery Saving
  - CDMA Mode Only, 138
- Bluetooth, 199
  - Car Kit, 200
  - FTP Server, 204

- Headset, 200
- Phone Name, 200
- Receive Information, 203
- Reconnect Phone, 201
- Send Information, 202
- Send Music, 129
- Settings, 51
- Turn On or Off, 200
- Unpair Device, 201

Brightness, 60

Browser

- Find Text, 148
- Show Flash Content, 147

Calculator, 174

Calendar, 170

- Add the Widget, 174
- Create Event, 171
- Edit Events, 172
- Erase Events, 173
- Event Alerts, 174
- Manage Events, 172
- Settings, 174
- Share Events, 173
- Show or Hide, 174
- Views, 171

Call Forwarding, 45

Call History, 37, 47

- Make Call From, 37
- Prepend a Number, 48
- Save a Number, 48
- View, 47

- Call Log, 47
- Call Waiting, 44
- Caller ID, 44
- Camera, 154
  - Effects, 155
  - Front Camera, 11
  - Launching, 154
  - Lens, 12
  - Record Video, 156
  - Take a Photo, 156
  - Zooming, 155
- Camera Key, 11
- Car Kit, 200
- Charger/Accessory Jack, 12
- Clock, 175
- Cloud Services, 187, See Online Storage
- Data Services
  - 3G, 136
  - 4G LTE, 136
  - FAQs, 138
  - Password, 6
- Date & Time, 70
- DDTM Mode, 65
- Drag, 16
- Dropbox, 183, 184, 185
- Earpiece, 10
- Email
  - Account Settings, 95
  - Compose and Send, 90
  - Delete Accounts, 96
  - Delete Messages, 94

- Manage Email Messages, 94
- Move Messages, 94
- Print, 91
- Read and Reply, 90
- Refresh the Inbox, 89
- Sort Messages, 90
- Switch Folders, 94
- Email Message
  - Make Call From, 38
- Emergency Numbers, 38
- Enhanced 911 (E911), 39
- Enter Text, 28
- Event
  - Create, 171
- Exchange ActiveSync
  - Features, 92
  - Meeting Request, 93
  - Out of Office Reply, 93
  - Synchronization, 56
- Extended Home Screen, 20
- Facebook, 107
- Factory Data Reset, 67
- Flash, 12
- Flick, 16
- FM Radio, 129
  - Minimizing or Turning Off, 130
- Friend Stream, 107
- Gallery
  - Print Photos, 163
  - View Pictures and Videos, 159
- Gestures, 15

- Google Latitude, 122
- Google Play, 114
- Google Talk, 113
- Headset Jack, 12
- History
  - Erase, 48
- Home Key, 11
- Home Screen, 18
  - Customize, 21
  - Extended, 20
  - Move or Remove Items, 22
- HTC Sync Manager, 189
  - Add Media Automatically, 192
  - Check for Updates, 192
  - Create Playlist, 194
  - Get Started, 191
  - Import Media, 192
  - Install, 190
  - Play Music, 193
  - Recognize Your Phone, 195
  - Rip Music CD, 198
  - Supported File Formats, 193
  - Sync Settings with Phone, 195
  - Sync Your Phone, 197
  - View Photos & Videos, 194
- In-call Options, 45
- Incoming Call
  - Answer, 39
  - Reject, 40
- Incoming Calls
  - Ringtones, 63



- Internet Calls, 46
  - Add Account, 46
  - Make an Internet Call, 46
- Internet Pass-through, 153
- Keyboard
  - Touchscreen, 28
- Kickstand, 11
- Language, 70
- Location Settings, 57
- Lock Screen, 14
  - Unlock, 14, 15
- Mail
  - Mail Widget, 96
  - Sort Email Messages, 90
- Messaging, 84
- microSD Card, 205
  - Check Capacity, 207
  - Erase Contents, 207
  - Insert, 206
  - Remove, 206
  - Unmount, 207
  - USB Drive, 207
- MMS, 96
  - Check Messages, 100
  - Create Slideshow, 99
  - Send, 98
- Multimedia Messaging, 98
- NFC, 204
- Notification Icons, 26
- Notifications Panel, 27
- Online Storage, 183

## Onscreen Keyboard

Compact, 28

Entering Text, 29

Phone, 28

Standard, 28

## People

Add an Entry, 75

Delete an Entry, 79

Edit an Entry, 79

Friend Stream, 107

Make Call From, 38

My Profile, 74

Set Up My Profile, 74

## Phone, 36

Dialer, 36

## Phone Calls, 36

Emergency Numbers, 38

From Call History, 37

From Email Messages, 38

From People, 38

From Text Messages, 38

Make Calls, 36

Phone Dialpad, 36

Receive, 39

Use Speed Dial, 38

## Phone Layout (illustration), 10

## Phone Settings

Location Settings, 57

Sound Settings, 62

## Photo, 156

## Photos

- Gallery, 159
- Send, 164
- Share, 164
- View Pictures and Videos, 159

Pictures and Videos, 154

Pinch, 17

Playlists

- Creating, 127

Power Button, 10

Power Off, 13

Power On, 13

Power Saving

- Email Synchronization, 69, 70

Predictive Text, 33

- Add to Dictionary, 33
- Edit or Delete, 34

Preset Messages, 98

Press and Flick, 18

Print

- Email, 91

Printing

- Photos, 163

Proximity Sensor, 10

Quiet Ring on Pickup, 40

Recent Apps Key, 11

Reject Incoming Call, 40

Reset Phone, 67

Restart, 13

Restart Phone, 13

Roaming

- Data Roaming, 138

- Rotate, 17
- Scenes
  - Deleting, 53
  - Renaming, 53
- Screen Lock, 58
- Screen Timeout, 60
- Screen Unlock
  - Face Unlock, 58
  - Password, 59
  - Pattern, 58
  - PIN, 58
- Security Settings, 58
- Settings, 50
- SkyDrive, 187
- Sleep Mode, 14
- Slide, 16
- SMS, 96
  - Back Up Messages, 104
  - Check Messages, 100
  - Send, 97
- Sound
  - System, 63
- Sound Set, 53
  - Apply, 53
  - Change, 54
  - Create, 54
  - Delete, 54
- Speaker, 12
- Speed Dialing, 46
- Spread, 17
- Sprint 411, 7

- Sprint Hotspot, 150
  - Connect To, 150
  - Set Up, 150
  - Settings, 151
- Sprint Operator Services, 8
- Status Bar, 24
- Status Icons, 25
- Stocks, 177
- Swipe, 16
- Swype Keyboard, 31
- System Updates, 71
- Tasks, 179
  - Back Up Tasks, 182
  - Change Settings, 182
  - Create, 180
  - Create Task List, 182
  - Link a Location, 180
  - Link to Contact, 180
  - Manage Task List, 182
  - Manage Tasks, 181
  - Unified Task List, 181
- Tethering, 153
- Text
  - Copy, Paste, 35
  - Select, 34
- Text
  - Edit, 33
- Text Entry, 28
- Text Message
  - Make Call From, 38
- Text Messages, 96

- Tools, 170
- Top Panel Cover, 11
- Touch, 16
- Touch and Hold, 16
- Touchscreen, 11
  - Keyboard, 28
  - Navigation, 15
  - Swype Keyboard, 31
  - Turn Off, 13
  - Turn On, 13
- TTY Mode, 64
- Turn Phone Off, 13
- Turn Phone On, 13
- Two-finger Scrolling, 17
- Type Text, 28
- Update Phone, 208
  - Back Up Data, 208
  - Update Firmware, 208
  - Update Operating System, 210
  - Update Roaming List, 210
  - Update Your Profile, 210
- Upgrade, 208
- USB Drive, 207
- USB Tethering, 153
- User Name, 137
- Vibrate, 62
- Video, 156
- Videos, 154
  - Send, 164
  - Share, 164
- Virtual Private Networks (VPN), 141

- Visual Voicemail, 40
  - Review, 41
  - Set Up, 40
- Voice Memos, 198
- Voice Recorder, 198
- Voicemail, 42
  - Notification, 42
  - Password, 6
  - Retrieve messages, 43
  - Set up, 42
  - Settings, 64
  - Setup, 5
- Volume
  - Button, 11
- Wallpaper, 61
- Weather, 178
- Web, 136
- Web Browser, 143
  - Add Bookmarks, 144
  - Download Apps, 147
  - Private Browsing, 144
  - Read or Watch Later, 145
- Web Connection, 137
- Wi-Fi
  - Settings, 51
  - Turn On or Off, 140
  - Wi-Fi Connection, 140
- World Clock, 176
- Zoom, 17
- Zooming, 155