



HUAAPTEC

We Improve Your Mobile Signal

User's Manual

(F27/F23/F20-5S)

MADE IN HUAAPTEC

Table of content

Table of content.....	2
How it works.....	3
Package contents.....	3
Features.....	5
Booster's port description.....	5
LCD Introduce.....	6
Manual gain control (MGC).....	6
Install Hiboost Booster system.....	6
Before you install.....	6
Installation overview.....	7
1. Install Outdoor Antenna.....	8
2. Install Indoor Antenna.....	10
3. Install the signal booster.....	11
4. Booster Commissioning.....	11
Trouble Shooting.....	15
FCC RF Exposure Statement.....	15
Notice.....	15
Specifications.....	16

How it works

F27/F23/F20-5S are designed to help mobile users amplify weak signals of 2G, 3G and 4G. They are bi-directional amplifiers.

The donor antenna receives the signals from the cell tower, amplifies it, and transmits to the signal booster. Then the indoor antenna will receive the signal and retransmit it to your mobile device.

The signals produced by your phone are also amplified by the indoor antenna via the booster and donor antenna.

Package contents

No.	Name	Description	Quantity
1	Hiboost Industrial Booster		1
2	Adapter	12V/7A	1
3	Plastic Expansion bolt	Φ 8	5
4	Tapping Screw	M6*50	4
5	User Manual		1



F27/F23/F20-5S booster

Power supply12V/7A

*Outdoor and indoor antennas and cables are required for installation (purchased separately).

F27/F23/F20-5S Industrial boosters cannot transmit signals without an outside and inside antenna connected by a cable. F27/F23/F20-5S can install up to 15 indoor antennas, usually, we recommend install up to 8~10 indoor antennas. The detail number of antennas, length of cable or other accessories needed can vary according to the size and make of the structure, lack of signal strength, or where the structure resides. Or you can contact us or our reseller to find out what you need.

Multiple antenna installation Sample

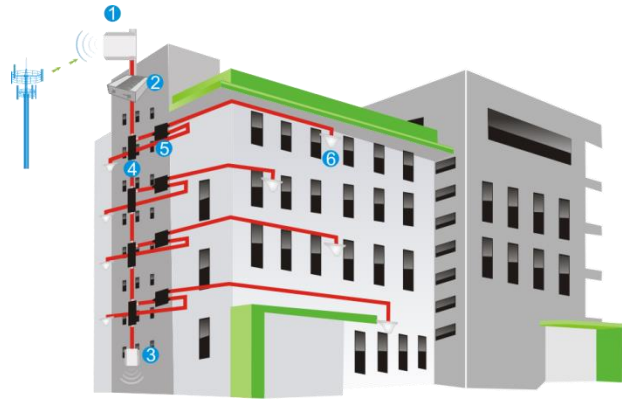

- 1.Outdoor Antenna 2. Booster 3.Indoor Panel Antenna
 4. Coupler 5. Splitter 6. Omni ceiling antenna

Optional antenna kits Recommended



RF cables (3D,5D,8D)

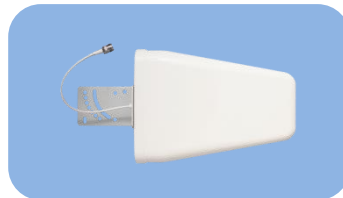

Wide Band Yagi antenna



Indoor panel antenna

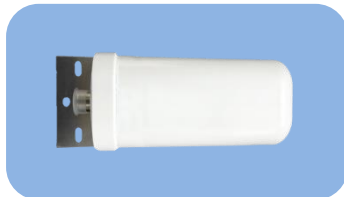

Outdoor ceiling mount dome antenna



Indoor panel antenna



Omni ceiling antenna



Whip antenna



Lightening protector



Coupler



Cavity Splitter (2,3,4 way)

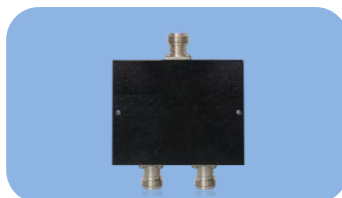

Wilkinson Splitter (2,3,4 way)

Features

- Embedded CPU, self-adaptive intelligent system to make booster system very easy to install and better performance is guaranteed under complex and constantly changing RF environment.
- ISO: Intelligent isolation processing to avoid self-oscillation, quite wide adjusting range to stabilize the signal strength/quality for clearer voice/ higher data speed and avoid interference to mobile network
- ALC: Intelligent ALC, quite wide adjusting range to improve the signal quality for clearer voice and higher data speed
- LCD Display: to display ISO status, ALC status, actual gain and downlink output power that make booster installation and troubleshooting much easier
- MGC: control button to adjust the gain for both uplink and downlink independently, 31dB range
- Excellent RF performance, larger coverage area, clearer voice and higher speed data services.
- Elegant design, small size, very low power consumption to save cost during operation and low heat dissipation.

Booster's port description

The following image shows the key components of the booster. There are 3 parts: first part is LCD indicator, which will show the booster status. Second part is control button. Third part is connectors to the outdoor antenna and indoor antenna. The following tables and graphs show the details.

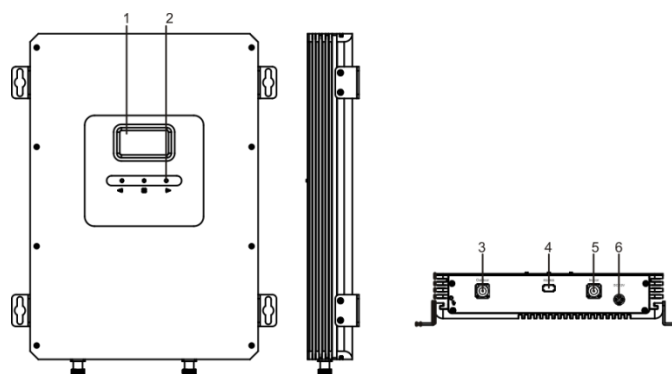

1. LCD 2. Control Button 3. Outdoor antenna port
4. Debug Port 5. Indoor antenna port 6. Power connector

LCD Introduce

After power on the repeater, the display area of working frequency will light all the time, the working frequency will display in turn.

“ISO” Isolation alarm indication.

When the repeater doesn't have enough isolation between the outdoor and indoor antennas, the “ISO” is flashing. Vice Versa, the “ISO” is off.

“AIC” Strong receiving power alarm indication.

When the repeater's receiving too strong signal from outside, output power gets overrated and “AIC” starts flashing. When output power is balanced, the “AIC” is off.

Gain or Power indication.

The displayed value represents the real-time gain and power.

When the repeater's output power is lower than -10dBm, the LCD will display “---”.

When LCD screen is in the “OFF” state and the repeater breaks down, LCD screen will be flashing.

When LCD screen is “ON” and the repeater breaks down, LCD6 and LCD7 will display “OFF” under the current band.

Manual gain control (MGC)

Since the booster has intelligent software system, MGC attenuation is not needed, except for the cases when you don't feel comfortable about ISO or ALC flashing, or in some extreme cases you might need to attenuate gain value.

When the LCD is in the circulation display or page turning query mode, press the key into the setting mode and choose operation objects: frequency, uplink or downlink gain .

Note:

In case you need to adjust gain, please ensure uplink gain to be equal with or to be 5dB less than downlink gain, uplink gain shouldn't be more than downlink gain in order to avoid interference with mobile network.

Install Hiboost Booster system

Before you install

- Make sure you have sufficient cable length between proposed outdoor/indoor antennas.

- Make sure the place where you install the booster is near to one existing electrical outlet. It should also be well ventilated, away from excessive heat, moisture, and direct sunlight.

Install tools and accessories:

No.	Name	Specification	Quantity	Remark
1	Plastic expansion bolt	Φ 8	5	Standard accessories
2	Tapping screw	M6*50	4	Standard accessories
3	Hanging folder		1	Standard accessories
4	Reciprocating drill		1	Engineering-owned
5	Shot bit	Ø8	1	Engineering-owned

Installation overview

The booster has LCD display and intelligent self-adaptive system, LCD displays real time working state, and intelligent self-adaptive system can automatically calculate and adjust the booster to obtain its best performance, so it is very easy to install for end-user.

General installation steps:

Step1. Install your outdoor antenna on the roof where there is the strongest signal.

Step2. Install the indoor antenna where you want to improve the signal.

Step3. Mount your signal booster, connect the cables to the signal booster from the outdoor antenna and indoor antenna at the designated ports, and connect the booster to the AC supply (make sure all the cables are connected).

Step4. Plug in the booster to a power supply and self-adaptive system will automatically adjust best performance in 30 seconds. (NB! Before you plug it in, make sure all the cables are connected firmly!). For more details refer to “**Booster Commissioning**”.

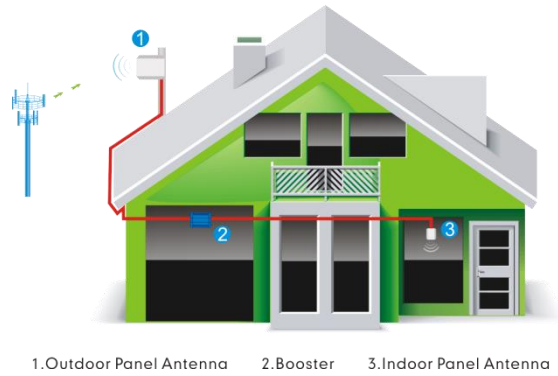

1. Outdoor Antenna 2. Booster 3. Indoor Antenna

1. Install Outdoor Antenna

1.1 How to find the position with the strongest receiving signal

The booster's main function is to improve weak RF signal inside a house, office or any other indoor area. The receiving strength of the outdoor antenna and the strength of the signal reception outdoors directly affect the efficiency of indoor coverage. That's why it's crucially important to install the outdoor antenna in the point where signal reception is the strongest.

There are two methods to find the strongest receiving signal. One is to use booster's LCD display, the other is to use mobile phone to test signal bars. We'd highly recommend you to use LCD display as this method is more accurate.

- **LCD Display Method**

Connect the outdoor antenna to the booster's outdoor port with an original coaxial cable that comes in a kit and power on the booster. Fix the outdoor antenna outside the window or on the top of the building and point it to the nearest cell tower. Then have a look at output power value displayed on LCD.

The outdoor antenna receives the strongest signal when the booster's output power reaches its full value. The place where you can reach it is the best to mount the outdoor antenna.



Remark: when ALC shows up flashing, it means the receiving signal power is stronger than the system needs it. It is recommended to adjust outdoor antenna position unless ALC alarm disappears. Or you can leave it as it is to let the booster self-adjust automatically. However when ALC flashes, and the displayed gain is more than 30 dB less than rated gain value, try to adjust outdoor antenna to decrease the receiving power.

- **Mobile Phone Method**

You can use telephone to test signal strength near the window or on the top of the building. The number of bars on network indicator will define approximate strength of the received signal. Normally the roof of the building is the best place to receive the strongest signal. As shown on the graph below, you need to test the signal in points from A to E, and select a place with best signal strength for outdoor installation. It is recommended to use mobile app that can display signal level, since it is more accurate than checking signal bars.

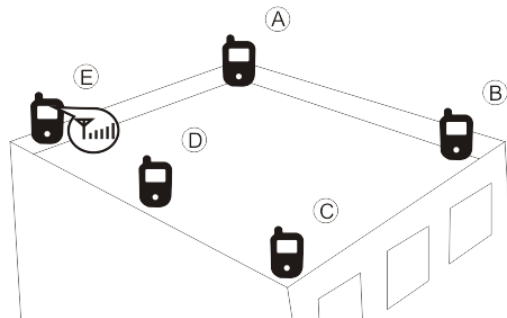

More tips: Please try to pick up signal from cell towers that are not so busy, which can be estimated by the population density in the area served by this tower. It's also recommended to avoid a cell tower near a supermarket, shopping mall, stadium and any other public place visited by many people regularly. This will

help on successful phone call connections or higher speed data services.

1.2 Install Outdoor Antenna

In most cases, the panel antenna is the best choice. You can also choose wide band YAGI antenna as an option.

There are 2 types of installation: wall mount or pole mount.

Install outdoor panel antenna onto the wall for your reference:

Step1: Unscrew antenna from L-mounting bracket on antenna base with wrench.

Step2: Mount vertical plate of the L-bracket on the wall with supplied screws.

Step3: Screw antenna back onto horizontal plate.

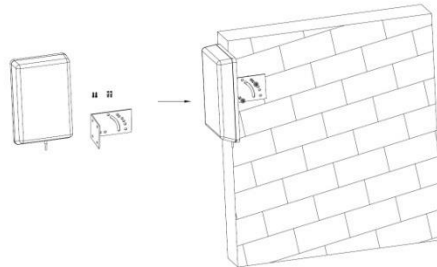

Notes:

- Wrap waterproof tape around the connectors between outdoor antenna and feeder line to avoid water or other kinds of damage.

2. Install Indoor Antenna

According to the requirement of practical application, please select Indoor panel antenna, or Omni-ceiling antenna as indoor antenna for coverage

Install indoor panel as reference.

Step1: Select a place on a wall projecting the area where you want reception.

Normally, to provide an overall coverage, you will need to choose a corner.

Step2: Mount the bracket on the wall after drilling the screw to the wall.

Step3: Put the panel antenna on the bracket.

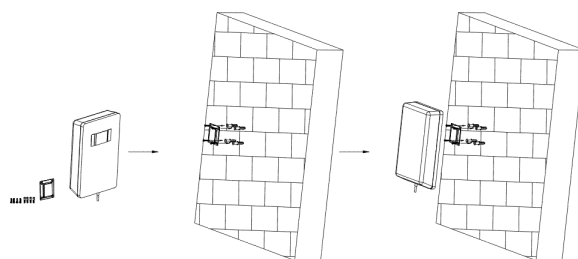

When you choose Indoor ceiling omni antenna or whip antenna, the best place to install it is the center of your house as the graph shows.

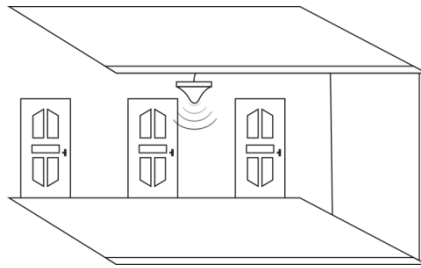

3. Install the signal booster

Step1: Select an indoor location near to a power outlet on a wall.

Step2: Mount the booster with the screws included as shown in the figure.

Step3: Connect the outdoor antenna cables to booster connector marked "outdoor". Tighten the connection with hand or wrench.

Step4: Connect the indoor antenna cables to booster connector marked "indoor". Tighten the connection with hand or wrench.

Step5: Connect the AC power cord to the signal booster, and then connect the plug to the electrical outlet to power on the booster

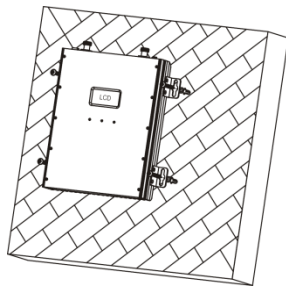

Booster installation

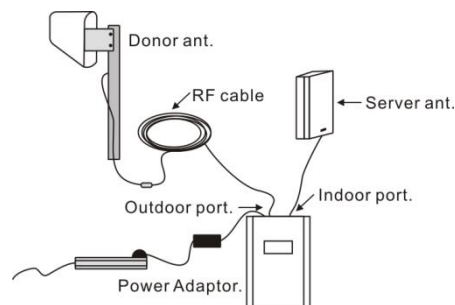

Connection from cable to booster

4. Booster Commissioning

Overview: The booster has quite intelligent startup system, booster commissioning is an automatic process to guarantee its optimal performance.

After finishing the booster system installation, please power on the booster, the booster starts its initialization to check it is receiving signal, the isolation status to ensure its best performance. This will take around 3~5 seconds.

After the booster start up, please check whether the coverage is good. If it is good,

the booster system is completed.

You can check the output power displayed in LCD. It may vary at 1~3dB difference which is normal due to outdoor signal conditions. It would be perfect that the output power reaches its rated one for largest coverage; but you can always leave it even though it doesn't as long as the coverage is good enough for you.

In case the coverage is not enough, please take below measures as per below conditions.

1. The rated output power is reached, but the coverage is not enough or the signal in specific areas has not been improved

- Check whether the indoor antenna is installed correctly or not, you may try to move the antenna location to improve coverage.
- Check if it is necessary to adjust the direction of the indoor antenna.
- Check whether it is necessary to add more indoor antennas since barriers block the signal penetration.

2. The rated output power is not reached.

1) Please adjust the outdoor antenna to get a stronger receiving signal in order to get higher output power (not necessarily to reach rated value as long as the coverage is enough)

2) please observe the LCD display, if the reading gain is less than rated value and "ISO" is flashing, it means the gain is reduced by **ISO function** for not having enough isolation.

Measures: One of below actions are recommended to eliminate ISO problems and increase the gain

- Adjust the antenna's directions or locations, or enlarge the distance between them.
- Enlarge the vertical or horizontal distance between donor antenna and server antenna.
- Use the barrier, such as walls, to increase the isolation.
- Change server antenna(server antenna can be changed to other antenna type which has better directional antenna pattern, also you can let server

antenna and donor antenna point opposite direction).

- Reduce the booster's downlink gain by the control button. Keep the uplink attenuation value and downlink attenuation value same then restart the booster.

More about "ISO" indication

ISO status indicates if the booster has enough isolation between outdoor and indoor antennas in order to avoid loop back or so-called self-oscillation. This is an intelligent system that works automatically to ensure the booster has no interference to either call/data services, or mobile networks. "ISO" flashes in LCD display when ISO function works; the flashing status shows ISO is working, and the self-oscillation has been eliminated.

LED	Status	Meaning	Solve methods
ISO status	Remain still	No loop back or no self-oscillation	NO action is needed
	Flashing but actual gain is not more than 30dB less than rated gain	Slight loop back or self-oscillation	NO action is needed
	Flashing but actual gain is more than 30dB less than rated gain	Deep loop back or self-oscillation	Working properly, but deep loop, below actions are recommended: <ul style="list-style-type: none"> ● Adjust the antennas' directions or locations to enlarge the distance. ● Add the vertical or horizontal distance between outdoor and indoor antennas. ● Use the barrier like walls to increase the isolation. ● Reduce the booster's gain by external attenuator or replace with lower gain antenna if the above methods don't work.

More about "AGC" indication: Flashing ALC indicates if the booster has a strong receiving power

LED	Status	Meaning	Solve methods
ALC status	Remain still	Output power is not weak or just suitable	Check coverage, leave it if it is good; take below actions to increase signal if coverage is not good. <ol style="list-style-type: none"> 1. Adjust the antenna direction or location to get stronger receiving signal 2. Replace current antenna with higher

			gain to get stronger receiving signal
	Flashing but actual gain is not more than 30dB less than rated gain	Full output power	Working properly
	Flashing but actual gain is more than 30dB less than rated gain	Too strong receiving signal	Working properly, but too strong signal, actions are recommended: 1. Adjust the antennas' directions or locations to lower down input power. 2. Reduce the booster's gain by external attenuator or replace with lower gain antenna if the above methods don't work.

Notes: The flashing ISO and ALC status are to show you that ISO and ALC functions are working to solve the self-oscillation or strong signal problems, so the problems have been solved already. In most cases, there is no need for you to do anything, except deep self-oscillation or too strong signals that we recommend your actions but not mandatory, since the booster still solves the problems. However it is already more proper for you to deal with it.

More about LCD indication:

LCD	Status	Meaning	Solve methods
"---		Output power is lower than -10dBm	Check coverage, leave it if it is good; take below actions to increase signal if coverage is not good. 1. Adjust the antenna direction or location to get stronger receiving signal 2. Replace current antenna with higher gain to get stronger receiving signal
"OFF"	Actual gain is more than 51dB less than rated gain	Severe loop back or self-oscillation or output power is severe over rated to lead that the repeater breaks down.	Not working properly, actions must be taken and recommend the below actions: 1. Adjust the antennas' directions or locations to lower down input power or enlarge the distance. 2. Add the vertical or horizontal distance between outdoor and indoor antennas.

Flashing LCD screen			<ol style="list-style-type: none"> 3. Use the barrier like walls to increase the isolation. 4. Reduce the booster's gain by external attenuator or replace with lower gain antenna if the above methods don't work.
---------------------	--	--	---

Trouble Shooting

Problem	Resolution
The signal booster has no power.	Check that the AC outlet is working.
The booster's power is on but the phone is not connected into the network and still cannot communicate.	<p>Try to fasten the connections between the different parts of the system.</p> <p>Change the direction of donor antenna or its installation position.</p> <p>Use barriers (like buildings) to block signals of other operators.</p>
Good downlink signal with poor communication quality.	<p>Check whether there's interference.</p> <p>Consult the operator whether the signal source base station works well.</p>
The power is on but the coverage is not good.	Firstly check the "ISO", "ALC" and other LCD indication, take actions according to the description of Booster Commissioning (Page14, Page15 and Page16).

Industrial booster warning label

WARNING. This is NOT a CONSUMER device. It is designed for installation by FCC LICENSEES and QUALIFIED INSTALLERS. You MUST have an FCC LICENSE or express consent of an FCC Licensee to operate this device. Unauthorized use may result in significant forfeiture penalties, including penalties in excess of \$100,000 for each continuing violation.

Notice

The Manufacturer's rated output power of this equipment is for single carrier operation. For situations when multiple carrier signals are present, the rating would have to be reduced by 3.5dB, especially where the output signal is re-radiated and can cause interference to adjacent band users. This power reduction is to be by means of input power or gain reduction and not by an attenuator at the output of the device.

La puissance de sortie nominale indiquée par le fabricant pour cet appareil concerne son fonctionnement avec porteuse unique. Pour des appareils avec porteuses multiples, on doit réduire la valeur nominale de 3, 5 dB, surtout si le signal de sortie est

retransmis et qu'il peut causer du brouillage aux utilisateurs de bandes adjacentes. Une telle réduction doit porter sur la puissance d'entrée ou sur le gain, et ne doit pas se faire au moyen d'un atténuateur raccordé à la sortie du dispositif.

Specifications

Uplink Frequency Range	698-716 / 776 – 787 / 824-849 / 1850-1915 / 1710-1780
Downlink Frequency Range	728-746 / 746 – 757 / 869-894 / 1930-1995 / 2110-2180
Supported Standards	CDMA, WCDMA, GSM, EDGE, HSPA+, EVDO, LTE and all cellular standards
F20-5S Max .Gain	73±3dB(UL)/78±3dB(DL)
F23-5S Max .Gain	78±3dB(UL)/83±3dB(DL)
F27-5S Max .Gain	83±3dB(UL)/83±3dB(DL)
F20-5S Nominal passband gain	60~73dB/65~73dB/62~73dB/60~73dB/62~73dB(UL) 65~78dB/65~78dB/65~78dB/59~78dB/67~78dB(DL)
F23-5S Nominal passband gain	65~78dB/70~78dB/67~78dB/65~78dB/67~78dB(UL) 70~83dB/70~83dB/72~83dB/64~83dB/72~83dB(DL)
F27-5S Nominal passband gain	70~83dB/75~83dB/72~83dB/70~83dB/72~83dB(UL) 70~83dB/70~83dB/72~83dB/64~83dB/72~83dB(DL)
F20-5S Max .Output Power	20±3dBm(UL)/20±3dBm(DL)
F23-5S Max .Output Power	20±3dBm(UL)/23±3dBm(DL)
F27-5S Max .Output Power	20±3dBm(UL)/27±3dBm(DL)
F20-5S Rated .Output Power	20dBm(UL)/20 dBm(DL)
F23-5S Rated .Output Power	20dBm(UL)/23 dBm(DL)
F27-5S Rated .Output Power	20dBm(UL)/27 dBm(DL)
MGC (Step Attenuation)	31dB/1dB step
Automatic Gain Control	≥31dB
Inter-modulation	≤-13dBm
Spurious Emission	≤-13dBm
Indicator	LCD diaplay frequency, gain, power, ALC, ISO, etc.
I/O Port	N-Female
Impedance	50 ohm
Environment Conditions	IP40
Dimensions	11*15.7*2.1inch /280*400*53mm
Weight	≤17.6lbs. / 8Kg
Power Supply	Input AC100~240V,50/60Hz,Output DC12V /7A

The Maximum indoor and outdoor Gain is 7.0 dBi

FCC Caution:

Any Changes or modifications not expressly approved by the party responsible for compliance could void the user's authority to operate the equipment.

This device complies with part 15 of the FCC Rules. Operation is subject to the following two conditions: (1) This device may not cause harmful interference, and (2) this device must accept any interference received, including interference that may cause undesired operation.

This equipment complies with FCC radiation exposure limits set forth for an uncontrolled environment .This equipment should be installed and operated with minimum distance 30cm between the radiator& your body.

This transmitter must not be co-located or operating in conjunction with any other antenna or transmitter.

Notice:

When this device operating in the 1710-1755 MHz band,the maximum antenna should be fixed height of 10 meters above ground. To meet FCC EIRP limit, the of antenna used with this amplifier must be offset by cable loss.

