

F23BUUM13

series user 's manual

Index

How to install the driver

Put the product plug into the USB port of PC.....3

Copy the driver into the PC.....3

Install the driver & Install driver successfully.....6

The test interface.....7

Installation Guide.....8

1. Put the product plug into the USB port, the "device manager" of PC is shown below:

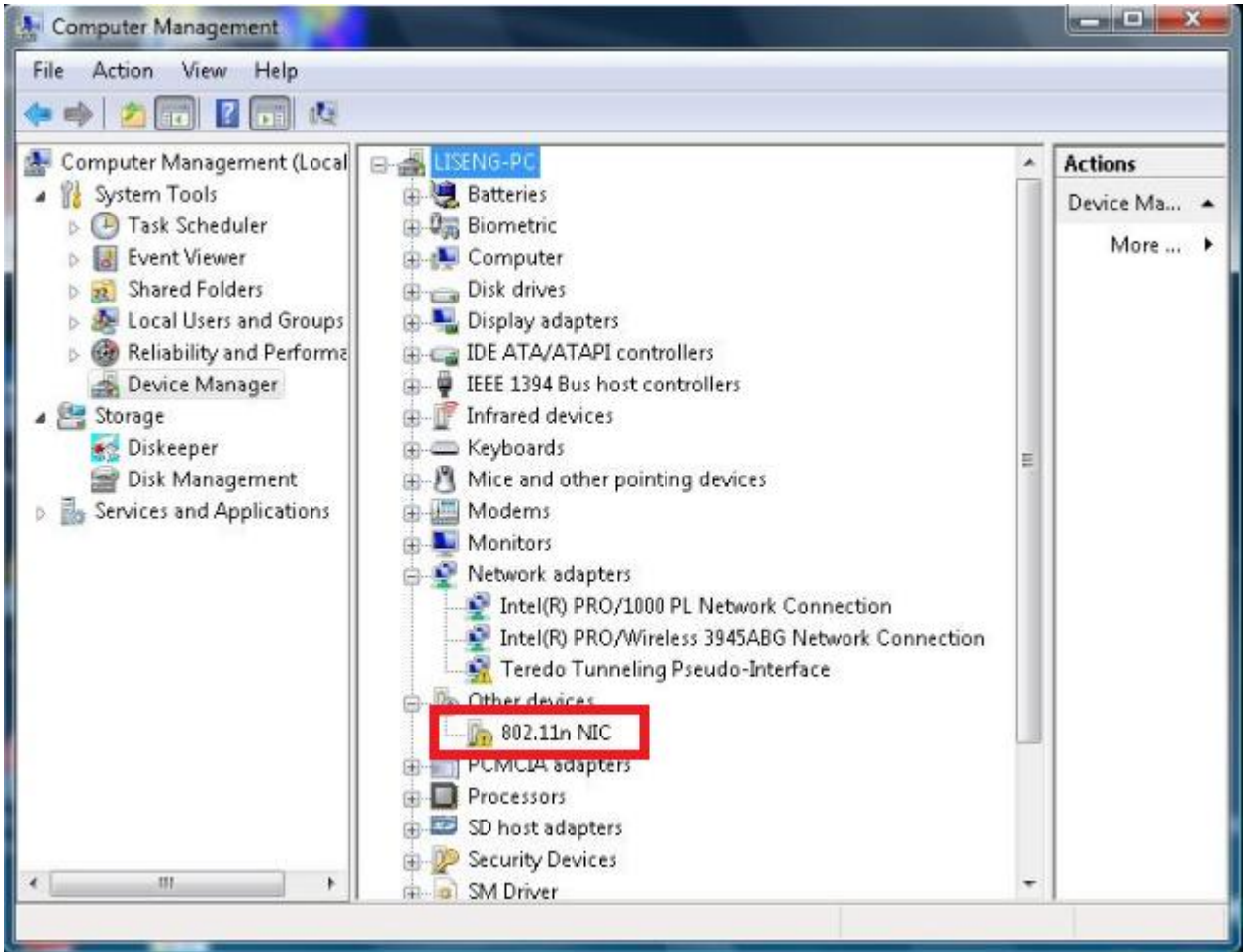

2. Copy the corresponding driver "MP_Kit_RTL11n_8723BU_USB_v28_20131212" into the PC, and install driver, the installation methods: open the file "MP_Kit_RTL11n_8723BU_USB_v28_20131212", double click "Setup" installation program, guide to install.

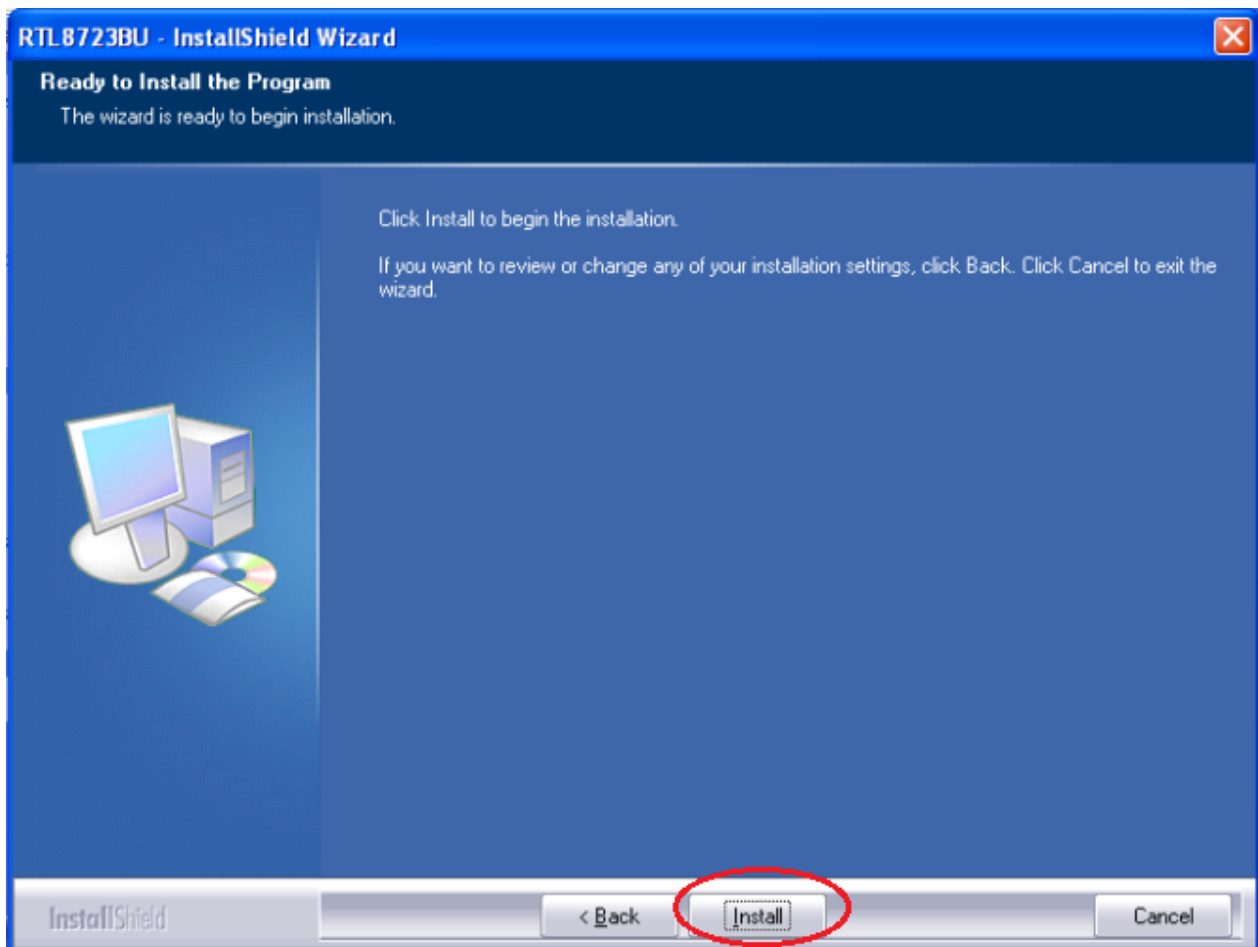
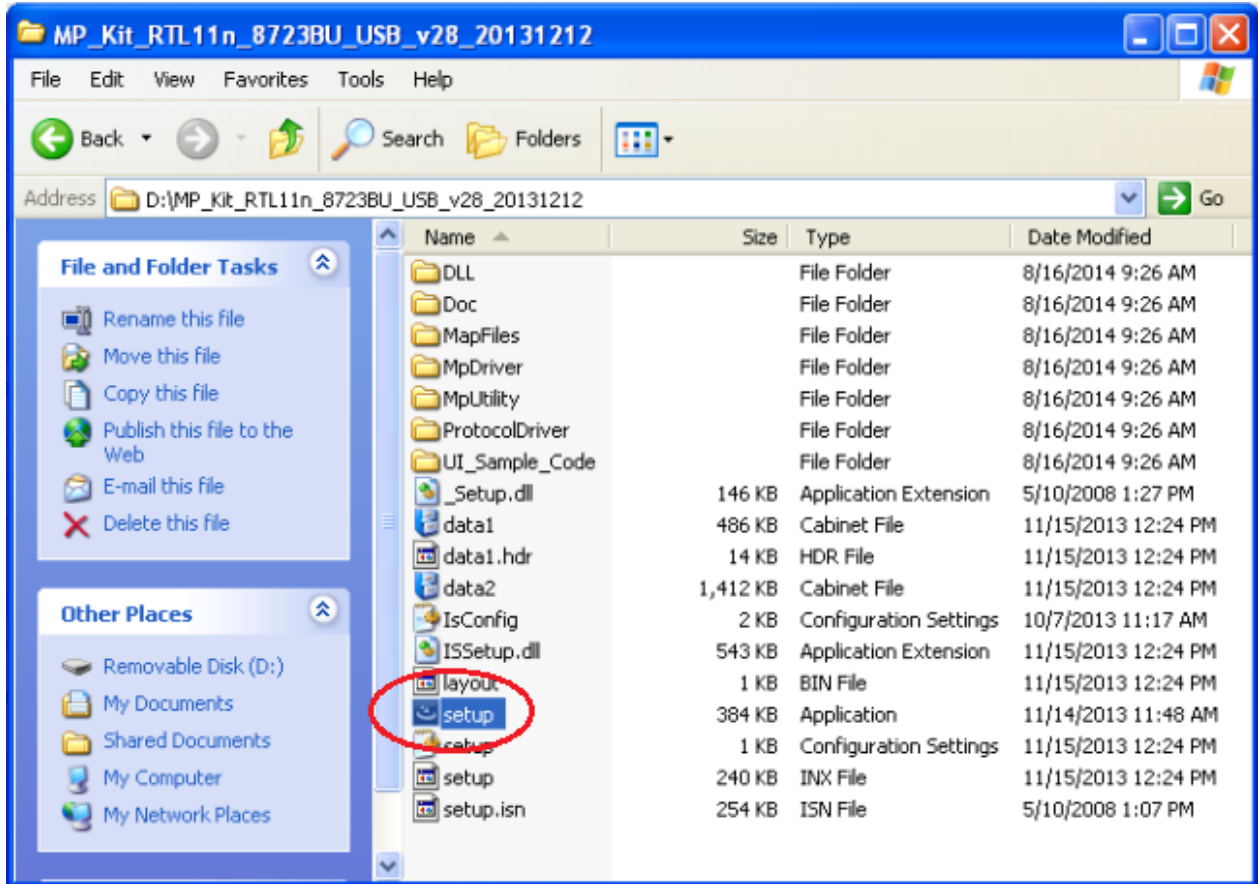

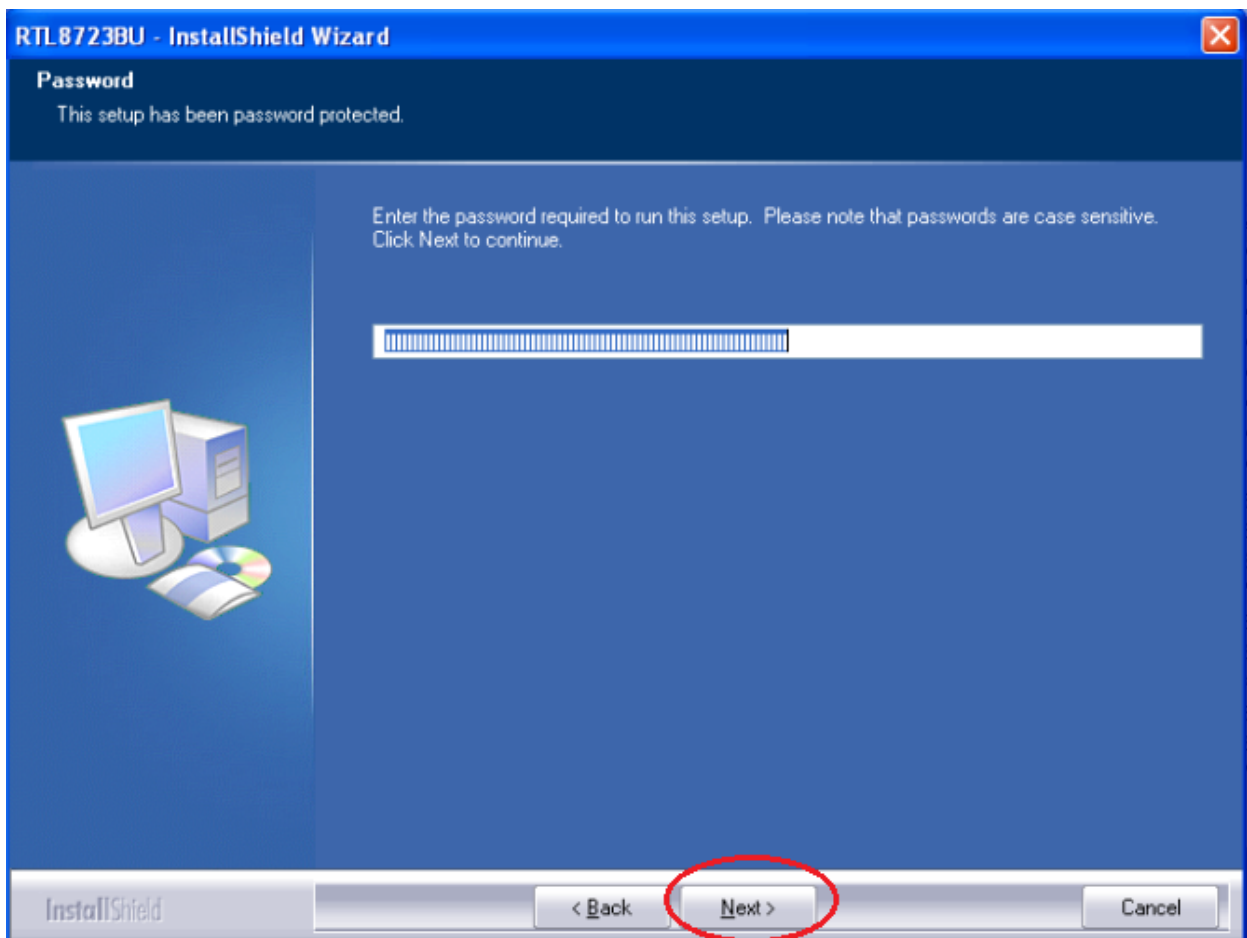
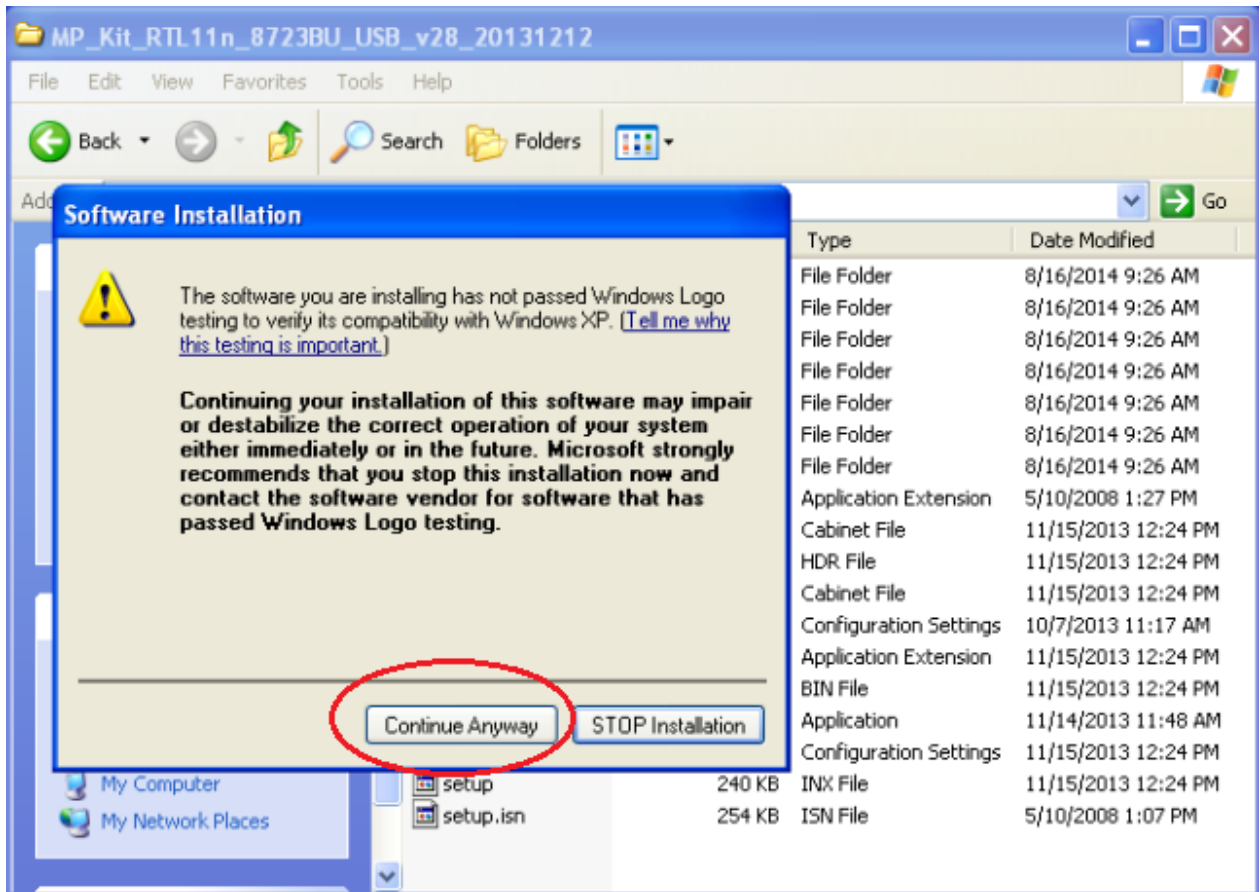

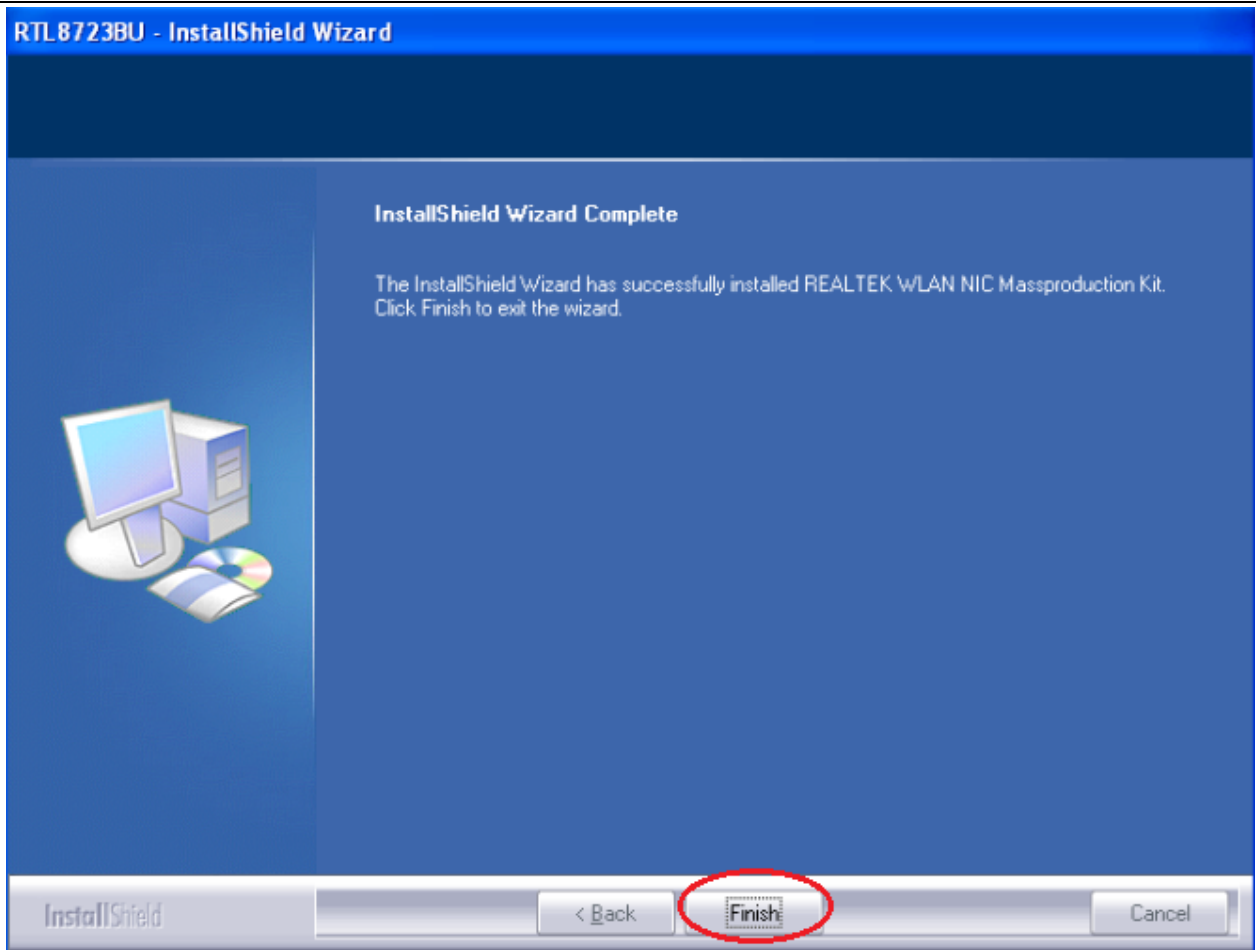

3. After install driver successfully, the "device manager" of PC is shown below:

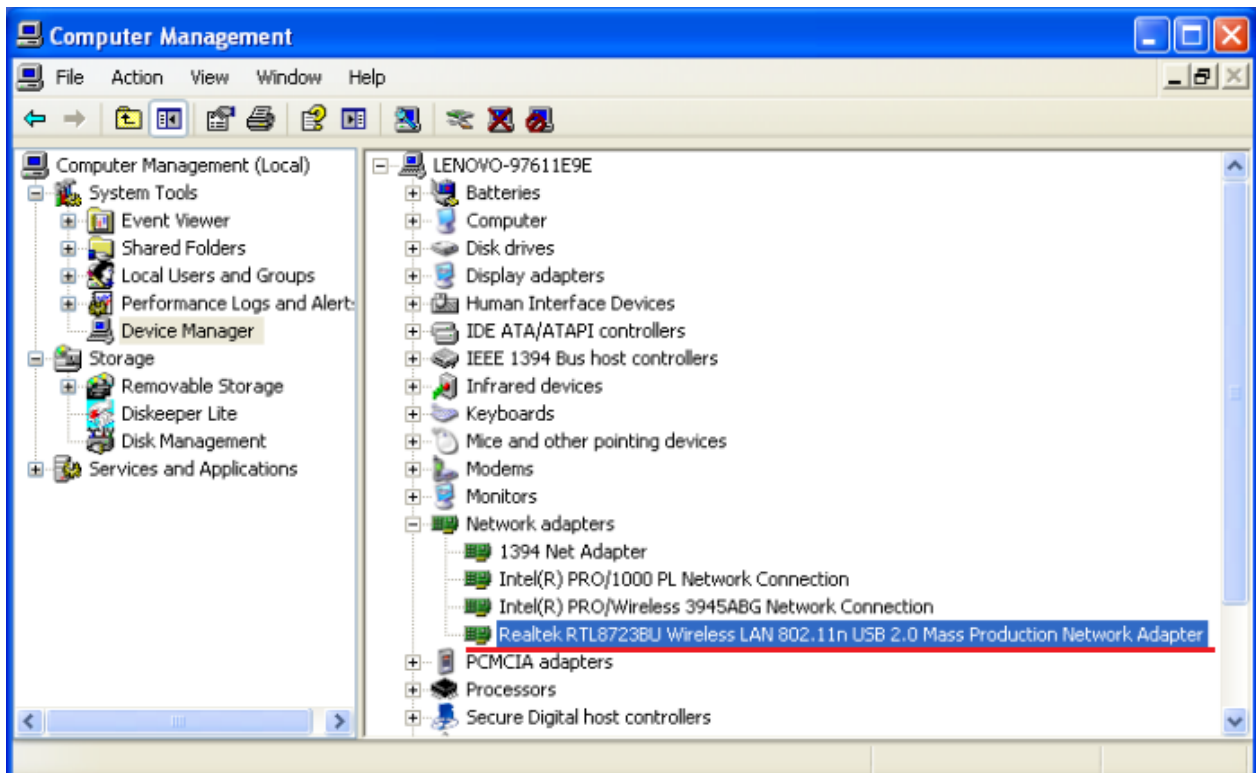

4. After install driver successfully. double click the icon "  " in PC desktop, as shown below:

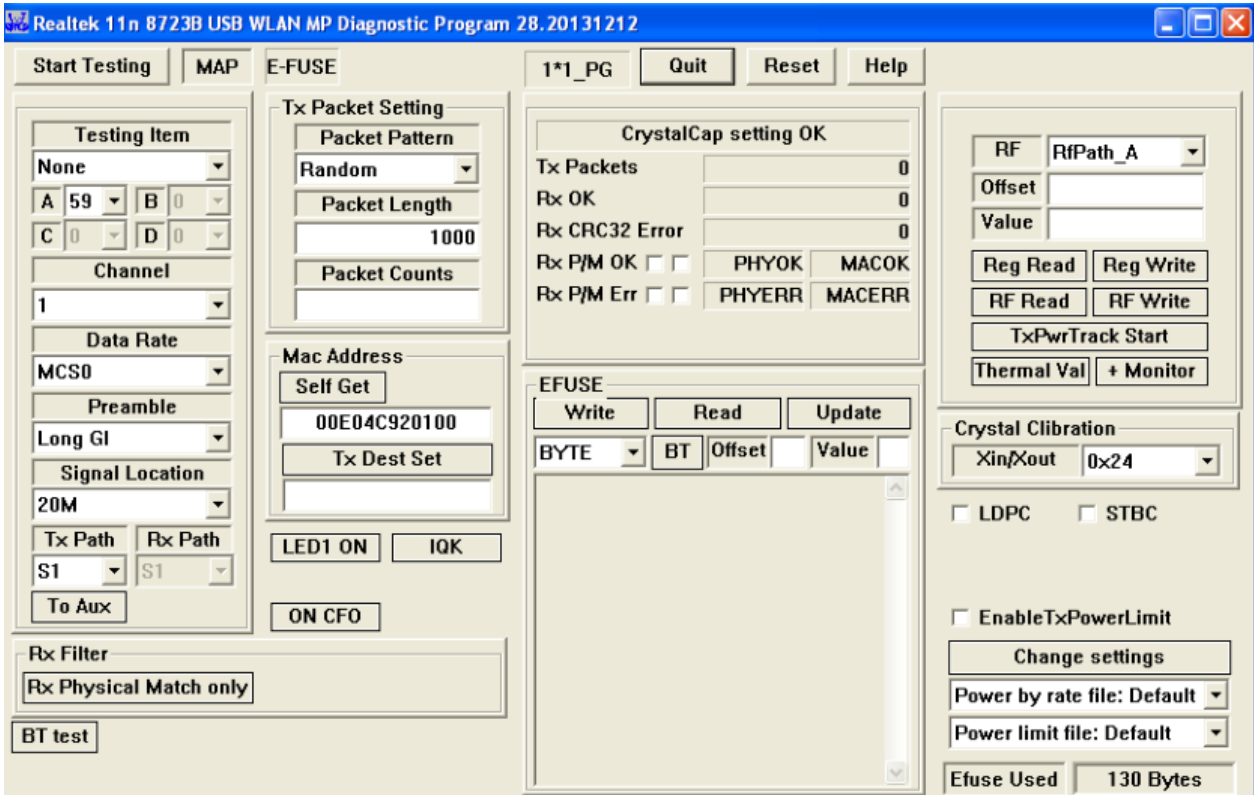
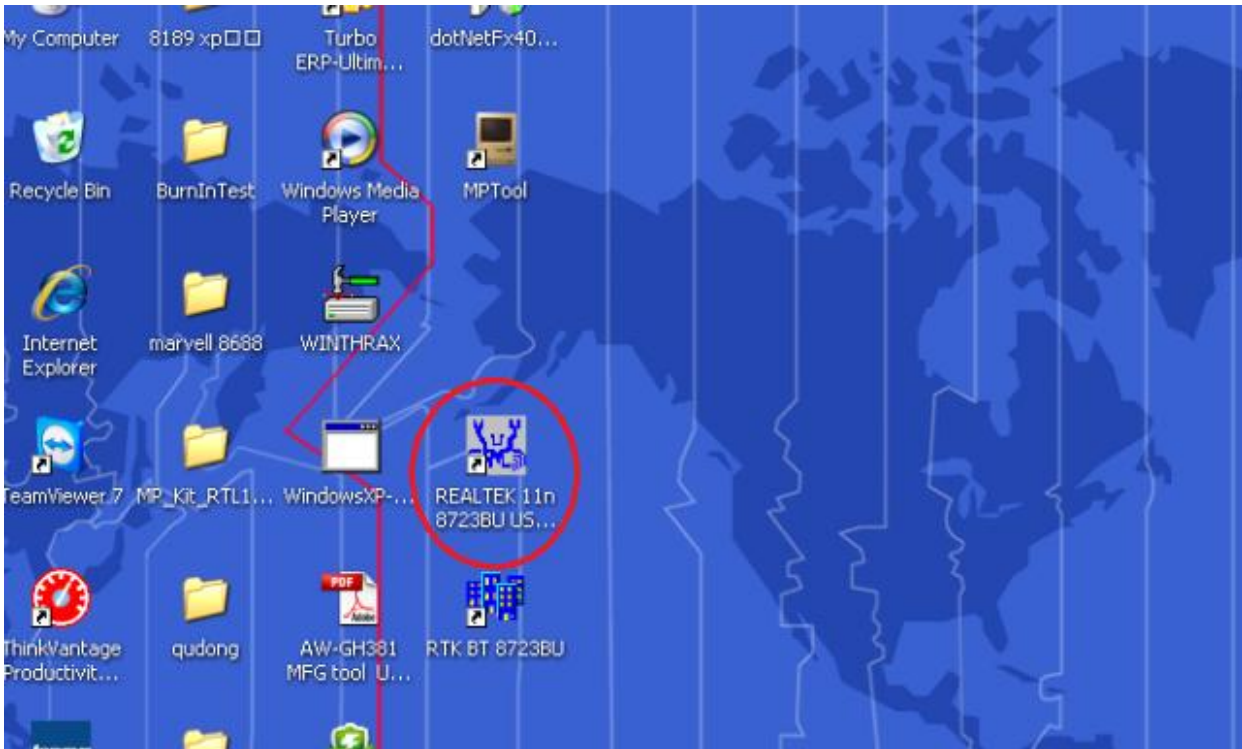

Installation Guide

1. Check RTL8723BU Module connection pin is clean for soldering.



2. Ready the Master PCB which will connect with RTL8723BU Module. Check connection pads is clean for soldering.

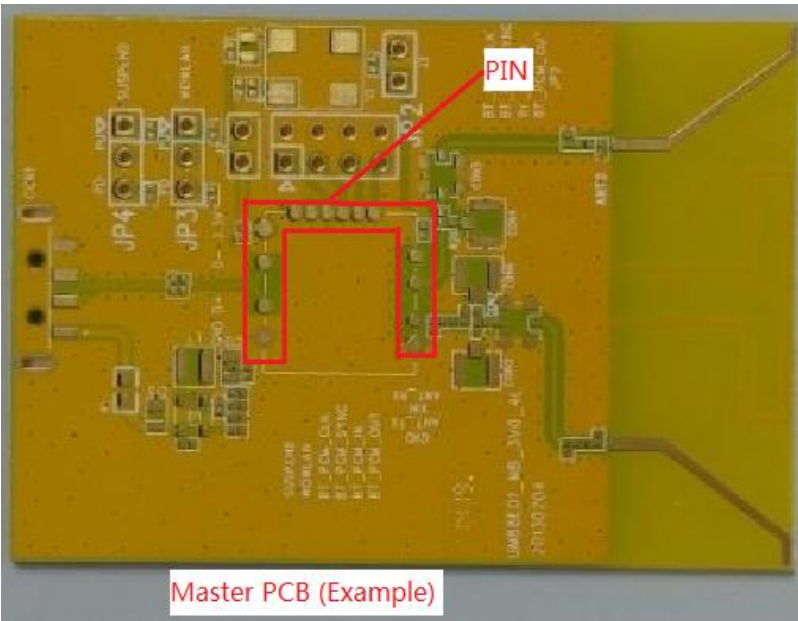

Master PCB (Example)

3. Place the Module on the Master PCB. Then solder it in sequence : 1.2.3

This antenna is disable

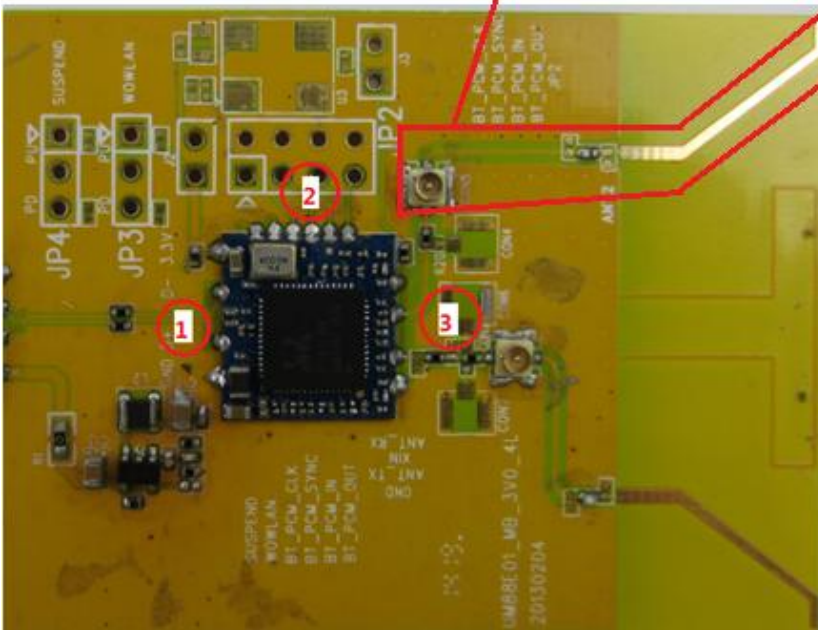

4. After soldering, Check all pads are well connected.

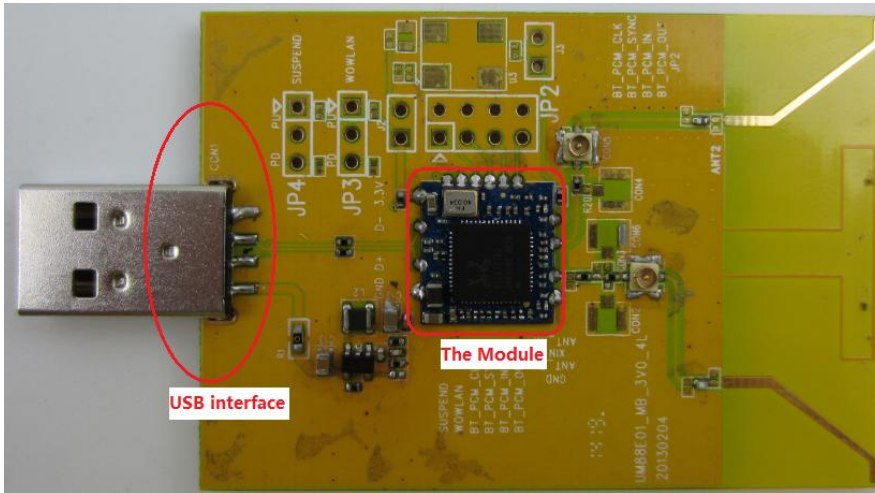

FCC Statement:

The final end product must be labeled in a visible area with the following "Contains TX FCC ID:2AATL-F23BUUM13". If the size of the end product is smaller than 8x10cm, then additional FCC part 15.19 stayement is required to be availale in the users manual:

This device complies with part 15 of the FCC Rules. Operation is subject to the following two conditions: (1) This device may not cause harmful interference, and (2) this device must accept any interference received, including interference that may cause undesired operation.

This equipment has been tested and found to comply with the limits for a Class B digital device, pursuant to part 15 of the FCC Rules. These limits are designed to provide reasonable protection against harmful interference in a residential installation. This equipment generates, uses and can radiate radio frequency energy and, if not installed and used in accordance with the instructions, may cause harmful interference to radio communications. However, there is no guarantee that interference will not occur in a particular installation. If this equipment does cause harmful interference to radio or television reception, which can be determined by turning the equipment off and on, the user is encouraged to try to correct the interference by one or more of the following measures:

- Reorient or relocate the receiving antenna.
- Increase the separation between the equipment and receiver.
- Connect the equipment into an outlet on a circuit different from that to which the receiver is connected.
- Consult the dealer or an experienced radio/TV technician for help.

Caution: Any changes or modifications not expressly approved by the party responsible for compliance could void the user's authority to operate the equipment.

FCC Radiation Exposure Statement:

This modular complies with FCC RF radiation exposure limits set forth for an uncontrolled environment. This transmitter must not be co-located or operating in conjunction with any other antenna or transmitter. Due to missing shielding the module is strictly limited to integration by the Grantee himself or his dedicated OEM integrator under control of the Grantee. However, the OEM integrator is still responsible for testing their end-product for any additional compliance requirements required with this module installed.

This device is intended only for OEM integrators under the following conditions:

- 1) This module is granted as a Limited Modular Approval.
- 2) This device has been designed to operate with a FPC antenna having a maximum gain of 0dBi. Only this type of antenna may be used.

This device has been evaluated and shown compliant with the FCC RF Exposure limits under fixed exposure conditions (antennas are greater than 20cm from a person's body) when installed in certain specific OEM configurations.