

THANK YOU!

We are grateful for your purchase of HYT product. We believe this easy-to-use radio will provide you with dependable and reliable communications. This HYT portable two-way radio is a precision device. Treat it with care, and you will enjoy years of reliable operation.

MODELS COVERED IN THIS MANUAL

TC3600 VHF Radio

TC3600 UHF Radio

Contents

User Safety, Training, and General Information

Compliance with RF Energy Exposure Standards

Important Note: FCC Information

FCC Compliance

Precautions

Product Inspection

Battery Information

Accessory Installation

- Battery

- Antenna

- Belt Clip

- Earplug Cover

- External Earphone/Microphone (optional)

Getting Started

Features and Operation

- Turn on/off the radio

- Adjust the Volume

- Power-on Password (only for keypad mode)

- Keypad Lock/Unlock (only for keypad mode)

- Select Channel

- Transmit

- Receive

- Monitor

- Repeater/Talk Around

- Repeater/ Reverse Frequency

- Power Level

- Scan

- Call

- Emergency ANI/Emergency Alert

- Record

- VOX Feature

- Low Battery Alert

- 2-Tone/HDC1200 Selective Signalling

Troubleshooting Guide

Care and Cleaning

Optional Accessories

Frequency Chart

User Safety, Training, and General Information

READ THIS IMPORTANT INFORMATION ON SAFE AND EFFICIENT OPERATION BEFORE USING YOUR HYT PORTABLE TWO-WAY RADIO.

Compliance with RF Energy Exposure Standards

Your **HYT** two-way radio is designed and tested to comply with a number of national and international standards and guidelines (listed below) regarding human exposure to radio frequency electromagnetic energy. This radio complies with the IEEE (FCC) and ICNIRP exposure limits for occupational/controlled RF exposure environment at duty cycles of up to 50% talk-50% listen and should be used for occupational use only. In terms of measuring RF energy for compliance with the FCC exposure guidelines, your radio radiates measurable RF energy only while it is transmitting (during talking), not when it is receiving (listening) or in standby mode.

Note: The approved batteries supplied with this radio are rated for a 5-5-90 duty cycle (5% talk-5% listen-90% standby), even though this radio complies with the FCC occupational RF exposure limits at duty cycles of up to 50% talk.

Your HYT two-way radio complies with the following of RF energy exposure standards and guidelines:

- United States Federal Communications Commission, Code of Federal Regulations; 47CFR part 2 sub-part J
- American National Standards Institute (ANSI)/Institute of Electrical and Electronic Engineers (IEEE) C95. 1-1992
- Institute of Electrical and Electronic Engineers (IEEE) C95. 1-1999 Edition
- International Commission on Non-Ionizing Radiation Protection (ICNIRP) 1998
- Ministry of Health (Canada) Safety Code 6. Limits of Human Exposure to Radio Frequency Electromagnetic Fields in the Frequency Range from 3KHz to 300GHz, 1999
- Australian Communications Authority Radio communications (Electromagnetic Radiation-Human Exposure) Standard 1999 (applicable to wireless phones only)

Operational Instructions and Training Guidelines

To ensure optimal performance and compliance with the occupational/controlled

environment RF energy exposure limits in the above standards and guidelines, users should transmit no more than 50% of the time and always adhere to the following procedures:

Transmit and Receive

To transmit (talk), push the Push-To-Talk (PTT) button; to receive, release the PTT button.

Hand-held radio operation

Hold the radio in a vertical position with the microphone one to two inches (2.5 to 5 cm) away from the lips.

Body-worn operation

- Body-worn operations are restricted to belt-clips, holsters or similar accessories that have no metallic component in the assembly and that provide at least 1.5 cm separation between the device, including its antenna, and the user's body.
- Always place the radio in a HYT approved clip, holder, holster, case, or body harness for this product. Use of non- HYT -approved accessories may exceed FCC RF exposure guidelines.
- If you do not use a HYT approved body-worn accessory and are not using the radio in the intended use position in front of the face, then ensure the antenna and the radio are kept four inch (6 cm) from the body when transmitting.

Antennas & Batteries

- Use only HYT approved, supplied antenna or HYT approved replacement antenna. Unauthorized antennas, modifications, or attachments could damage the radio and may violate FCC regulations.
- Use only HYT approved, supplied batteries or HYT approved replacement batteries. Use of non- HYT -approved batteries may exceed FCC RF exposure guidelines.

Approved Accessories

For a list of HYT approved accessories, see the accessories page of this user manual or visit the following website which lists approved accessories: <http://www.hyt.com.cn>.

Important note: FCC Information

MODIFICATIONS OR CHANGES NOT EXPRESSLY APPROVED BY THE MANUFACTURER COULD VOID THE USER'S AUTHORITY TO OPERATE THE EQUIPMENT.

IMPORTANT NOTE: To maintain compliance with the FCC's RF exposure guidelines, hold the transmitter and antenna at least 1 inch (2.5 centimeters) from your face and speak in a normal voice, with the antenna pointed up and away from the face. If you wear the headset on your body while using the headset accessory, use only the manufacturer's supplied belt clip for this product and ensure that the antenna is at least 1 inch (2.5 centimeters) from your body when transmitting. To provide the recipients of your transmission the best sound quality, hold the unit at least 5cm (2 inches) from the mouth, and place the antenna slightly off to one side.



Your radio generates radio frequency electromagnetic energy during transmission mode. The radio is designed for and classified as "Occupational Use Only" and must be used by individuals who are properly trained and aware of these hazards and the means in which to minimize such hazards. This radio is NOT intended for use by the "General Population" or in uncontrolled environments.



To ensure that your exposure to radio frequency electromagnetic energy is within the FCC allowable limits for occupational use, always follow these guidelines:

DO NOT operate the radio without a proper antenna attached, as this may damage the radio and increase your RF exposure. A proper antenna is supplied with the radio by the manufacturer or an antenna specifically authorized by the manufacturer for use with this radio.

DO NOT transmit for more than 50% of the total radio use time (this is a maximum 50% duty cycle radio). Transmitting more than 50% can cause FCC RF exposure compliance requirements to be exceeded. Pressing the PTT switch enables the radio to transmit.

ALWAYS use ONLY authorized accessories with this radio. Use of unauthorized accessories can cause the FCC RF Exposure compliance requirements to be exceeded.

FCC Compliance

This equipment has been tested and found to comply with the limits for a Class B digital device, pursuant to part 15 of the FCC Rules. These limits are designed to provide reasonable protection against harmful interference in a residential installation. This equipment generates, uses and can radiate radio frequency energy and, if not installed and used in accordance with the instructions, may cause harmful interference to radio communications. However, there is no guarantee that interference will not occur in a particular installation. If this equipment does cause harmful interference to radio or television reception, which can be determined by turning the equipment off and on, the

user is encouraged to try to correct the interference by one or more of the following measures:

- Reorient or relocate the receiving antenna.
- Increase the separation between the equipment and receiver.
- Connect the equipment into an outlet on a circuit different from that to which the receiver is connected.
- Consult the dealer or an experienced radio/TV technician for help.

FCC Requirements

Your radio must be properly licensed by the Federal Communications Commission prior to use. Your HYT Wireless dealer can assist you in meeting these requirements. Your dealer will program each radio with your authorized frequencies, signaling codes, etc., and will be there to meet your communications needs as your system expands.

Precautions

- Only qualified technicians are allowed to maintain this product.
- Do not use the radio or charge a battery in explosive areas such as coal gas, dust, steam, etc.
- Switch OFF the radio while refueling or parking at gas station.
- Do not modify or adjust this radio for any reason.
- Do not expose the radio to direct sunlight over a long time nor place it close to heating source.
- Do not place the radio in excessively dusty, humid areas, or on unstable surfaces.
- Stubby antenna especially suits communication in close quarters; While long and fine antenna provides better communication quality and avoids any uncomfortableness when wearing the radio on waist.
- The communication range will be impacted in rainy or cloudy days or when you are in forest.

Safety: It is important that the operator is aware of and understands hazards common to the operation of any radio.

Supplied Accessories

Please carefully take the transceiver out of the box. We recommend that you confirm the items listed in the following table are enclosed before discarding the box. If any items are missing or have been damaged during shipment, file a claim with the carrier immediately.

Available Accessories

Item	Qty. (pcs)
Antenna*	1
Belt Clip	1
Strap	1
Battery	1
Desktop Charger	1
AC Adapter	1
Owner's Manual	1
Declaration of Conformity*	1

*Notes:

- ① Frequency is marked on the color circle of the antenna. Red circle indicates UHF and green indicates VHF. If frequency is not marked on the color circle, please refer to the label on the main unit for details.
- ② Only for European market.

Battery Information (Take a keypad type model for example)

Initial use of the battery

The battery is not fully charged at the factory. Please charge the new battery before initial use. In general, the battery should be charged for 12 hours before initial use, which is suitable for Ni-Cd, Ni-MH or Li-ion battery charged with slow or rapid charger. It is recommended to take this step during the first three times of use. When the battery power is low, it needs to be charged.

Applicable Battery Packs

Charge only the HYT approved battery packs. Other batteries may burst and cause personal injury.

Safety attention

1. Conductive metals including jewelry, key, etc, may result in short circuit, discharge, generation of a large quantity of heat, or leakage when coming into contact with battery contacts or electrodes. To avoid damage to articles or human injury, treat any battery with care.
2. Do not short out the battery terminals or dispose of the battery in fire. Never attempt to disassemble the battery. If discarded, the battery should be thrown into dedicated battery recycle box.

Normal operation

- ★ Please charge the battery indoor to ensure the optimal charging effect.
- ★ In general, the battery can be removed if the charger indicator turns from red to green.
- ★ Turn off the radio when charging the battery inside the radio.
- ★ Do not charge the battery if its power hasn't been used up (if the power used up, the radio will give alert tone), otherwise, the battery life will be shortened.
- ★ Do not return fully charged batteries to the charger for an "extra boost". This action will significantly reduce cycle life.

To prolong battery life

- ★ Battery performance will be greatly decreased under -20°C temperature. Please use back-up battery in cold weather. The cold battery unable to work in this situation may work under room temperature, so keep it for later use.
- ★ The dust on the battery contact may affect the life cycle of the battery. Please use clean dry cloth to wipe it before the insertion of the battery into the radio.

Battery storage notice

1. Due to the self-discharge, the battery which will not be used for a long time should be stored after full charge to avoid the damage to the battery because of over-discharge.
2. Take out the battery stored for about 6 months to charge it, to avoid the influence of electrolyte over-discharge on battery capacity.
3. Notice the ambient humidity and temperature for the battery storage. Please store it in cool dry area with room temperature, to decrease self-discharge.

Battery charging

When radio LED flashes red and three Beeps sound every 30 seconds after the battery is installed, that means battery power is low. Please charge the battery.

You are recommended to use HYT-approved, supplied charger; Charger LED will indicate the charging status.

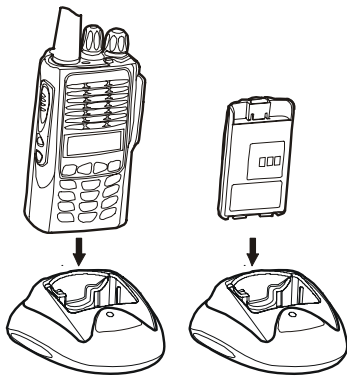

LED	Indication
Flashing red	Low battery voltage
Red	Charging
Green	Fully charged

1. Plug the power cable into the adapter.
2. Plug the DC socket of adapter into the DC jack on the rear of the charger.
3. Insert the battery or the radio with battery into the charger cup.
4. Plug the AC socket of adapter into an AC outlet.
5. Make sure that the battery connectors are in contact with the charging terminals; the charger LED glows red and charging begins.
6. The charger LED glows green when the battery is fully charged in about 3 hours, please remove the battery or the radio with battery from the charger.

***Notes:** Charger LED may flash red if you put the battery into the charger, which is a normal pre-charge process for the charger to protect the battery when the battery power is low. It will turn to normal charge status (glow red) after 30 seconds.

Accessory Installation (Take a keypad type model for example)

Battery

Attaching the battery:

Insert the two tabs on bottom of the battery into the slots at the bottom of the radio. Push the top of the battery towards the radio until a click is heard. (See figure 1)



Fig. 1

Removing the battery:

Turn off the radio. Push the battery latch on the middle of the radio to remove the upper side of the battery away from the radio and then remove the battery. (See figure 2)

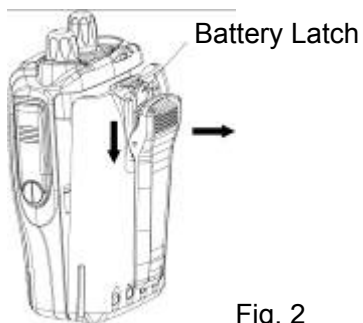

Fig. 2

Antenna

Insert the threaded end of the antenna into the connector on top of the radio. Rotate the antenna clockwise to fasten it.

Rotate the antenna counterclockwise to remove it. (See figure 3)

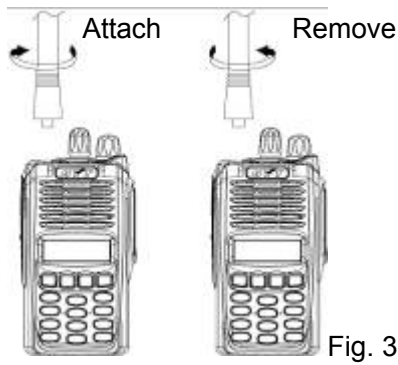

Fig. 3

Belt Clip

Attaching Belt Clip:

Align the slot of the belt clip with the T-slot at the battery cover and press the belt clip downwards until it is locked. (See figure 4)

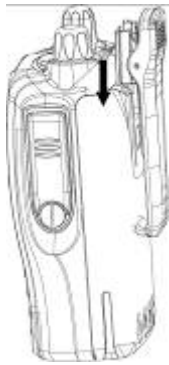

Fig. 4

Removing the belt clip:

Press the disassembly release upwards with a key until it releases and then push the belt clip upwards with your thumb to remove it. (See figure 5)

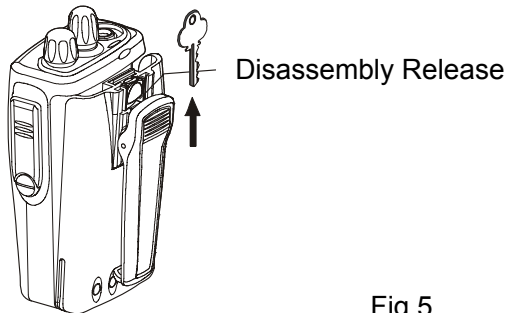

Fig.5

Earphone/Microphone Jack Cover

To remove the Earphone/Microphone jack cover, rotate the screw at the bottom of the cover counterclockwise with a screwdriver until it is free. (See figure 6)



Fig. 6

External Earphone/Microphone (Optional)

Insert the tab at the bottom of the earphone/microphone into the slot on the radio. (See figure 7). Align the thumbscrew at top of the earphone/microphone with the hole on the radio and turn it clockwise to fasten.

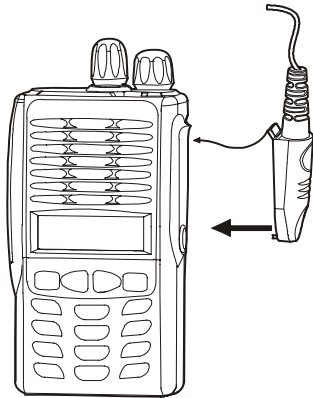
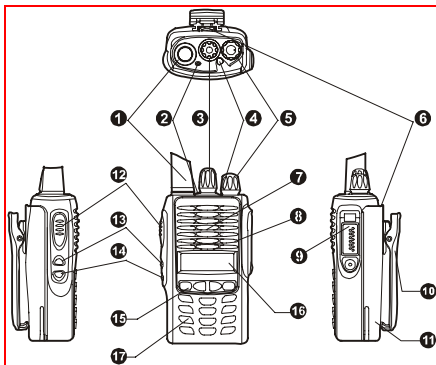
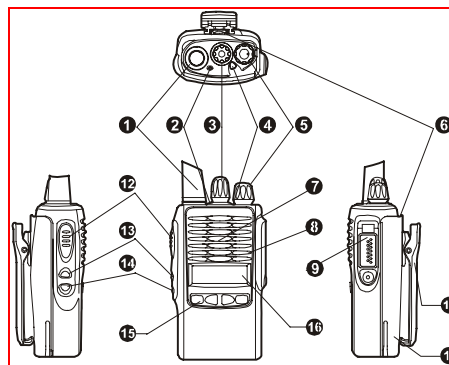

Fig. 7

Getting Started



(Keypad type model)



(Non-keypad type model)

(1) Antenna

Used to transmit/receive signals.

(2) LED

The following table indicates LED mode and corresponding radio status:

LED	Status
Not lit	Standby
Green	Receive
Red	Transmit
Flashing green	Scan
Flashing red	Low battery voltage
Flashing orange	Call waiting

(3) Channel Selector

Used to select wanted channel.

(4) Programmable key [A]

(5) Power/Volume Control Knob

Rotate the Power/Volume Knob clockwise until a “click” is heard to turn the radio on; rotate fully counter-clockwise to turn the radio off. When the radio is on, turn the knob to adjust volume.

(6) Battery Latch

Used to fasten the battery.

(7) Speaker

Used to output receiver audio and alert tones

(8) Microphone

Used to input voice audio

(9) External Jack

Used to connect with external earphone or programming cable.

(10) Belt Clip

Used to clip the radio on your belt

(11) Battery Pack

(12) PTT Button

Press and hold the PTT Button to transmit. Release the PTT Button to receive.

(13) Programmable Key [B]

(14) Programmable Key [C]

The following table shows the key function when:

- Short pressed
- Long pressed

Key Function	Short Press	Long Press
Emergency Alert	Enable emergency Alert	Disable emergency Alert
Monitor	Disable monitor	Monitor
Scan	Enable/Disable scan	Enable/Disable scan
Nuisance Delete	Delete nuisance channel in scan	Delete nuisance channel in scan
Select High/Low Power	Select High/Low Power	Select High/Low Power
Repeater/Talk Around	Select Repeater or Talk Around Mode	Select Repeater or Talk Around Mode
Repeater/Reverse Frequency	Select Repeater or Reverse Frequency Mode	Select Repeater or Reverse Frequency Mode
Call	Transmit a Call	Transmit a Call
Selective Call	Transmit selective call or group call signalling (2-Tone) or HDC shortcut key	Transmit selective call or group call signalling (2-Tone) or HDC shortcut key
Vibration	Toggle Vibration On/off	Toggle Vibration On/off
Record	Enable/Disable Record Function	Enable/Disable Record Function
Play	Toggle Record Playing On/off	Toggle Record Playing On/off
Delete	Delete the Current Message	Delete the Current Message

Please contact your dealer for more details about the programmable keys.

(15) Function Keypad (See figure 8)

Exit: Used to return to the upper menu

Up key

Down key

Menu/Select Key: Used to enter menu mode. In menu mode, this key is used to select options.

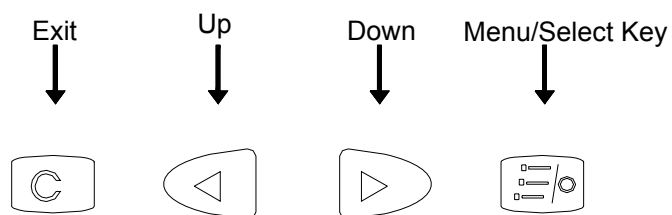

Fig. 8

(16) LCD Display

Used to indicate operation status of the radio.

(17) Numeric Keypad (See figure 9)

Used to input information to the program menu of the radio. (Only for a keypad type model)

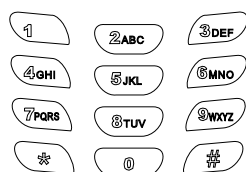

Fig. 9

Features and Operation

Turn On/Off the Radio

To turn the radio on, rotate the “Power/Volume” knob clockwise. An alert tone indicates that the self-test of the radio completed successfully. The LED glows green during power-up. If self-test fails and/or the selected channel is not set, you will also hear an alert tone.

To turn the radio off, rotate the “Power/Volume” knob counterclockwise until a click is heard.



Adjust the Volume

Rotate the “Power/Volume” knob to adjust the volume.

Power-on Password (Only for a keypad type model)

This radio offers password protection feature. “Password” will appear on LCD after power on if password is set in the radio. The radio enters conventional mode after entering 1-8 digit password.

Keypad Lock/Unlock (Only for a keypad type model)

Hold down  key and then press “*” key in 2 seconds to lock the keypad. When the keypad is locked, holding down  key and then pressing “*” key in 2 seconds can unlock the keypad. LCD displays “ ” icon when keypad is locked.

Select Channel

The radio provides 256 conventional channels (16 zones, 16 channels in each zone). Some of the channels may be not programmed and can't be used. Please contact your dealer for more details.

Rotate the “Channel Selector” knob to select the wanted channel.

1. Select an appropriate zone. (Refer to “select zone” in Menu Mode).
2. Rotate “Channel Selector” knob until your wanted channel is selected.

Transmit

1. Turn on the radio.
2. Rotate the “Channel Selector” knob to select the wanted channel.

3. Make sure there is no activity on the channel.
4. Press the PTT button and speak into the microphone with your mouth 1- 2 inches away from the radio. The LED glows red during transmission.
5. Release the PTT button to finish transmission.

Receive

1. Turn on the radio.
2. Rotate the “Channel Selector” knob to select the wanted channel.
3. Adjust the volume.
4. If vibration mode is set and a call is received, the radio will alert you with vibration and no audio will be heard. The LED glows green during receiving.
5. When CTCSS/CDCSS or squelch tail elimination feature is set by your dealer:
 - No squelch tail will be heard at the end of a received transmission when the courtesy tone is disabled.
 - A beep tone sounds at the end of a received transmission when the courtesy tone is enabled.

Please contact your dealer for more details.

Monitor

1. Press MONI key to monitor the current channel.
2. Press MONI key again to exit.
3. Your dealer can set three monitor modes: Selective call monitor, CTCSS monitor and Carrier monitor.

Selective call monitor: To prohibit selective call squelch;

CTCSS monitor: To prohibit all signaling squelch and open the speaker when carrier is detected.

Carrier monitor: To prohibit all squelch and open the speaker.

Repeater/Talk Around

When you are out of the communication range of the repeater and within the communication range of your group member, you can bypass the repeater and talk directly to your group member.

Press the programmed “Repeater/Talk Around” key to select between “repeater” and

“talk around” mode. An alert tone indicates that radio is in talk around mode (simplex). A different alert tone indicates that the radio is out of the talk around mode (duplex).

Repeater/Reverse Frequency

When you are out of the communication range of the repeater and within the communication range of your group member, you can talk with your group member by reverse frequency when your group member is still within the communication range of the repeater.

Press programmed “Repeater/Reverse Frequency” key to select between “repeater” and “reverse frequency”. An alert tone indicates that radio operates in reverse frequency mode. A different alert tone indicates that the radio is out of the reverse frequency mode.

Note: “Repeater/Talk Around” and “Repeater/Reverse Frequency” cannot be set simultaneously within one radio.

Power Level

Each channel of the radio can have different power levels that are user selectable.

- High power allows you to transmit greater distances.
- Low power helps to save battery life.

Press the programmed “power select” key to select high/low power. An alert tone indicates when the power level is toggled.

Scan

Scan feature allows you to monitor all channels for activity.

When scan feature is enabled, the radio will detect all channels. If an active channel is detected, the radio will remain on that channel while receiving (The dealer can program a channel as scan item or non-scan-item).

Disable/Enable Scan Feature

1. Press the scan key to begin scanning.
2. Press the scan key again to stop scanning.

The LED flashes green in scan mode.

Callback

The radio will transmit on the callback channel if the PTT button is pressed while scanning.

Please contact your dealer for more details about callback channel.

Nuisance Channel Delete

Nuisance channel delete feature allows you to temporarily delete an unwanted channel from the scan list.

When the radio stops on the nuisance channel, press the programmed “nuisance delete” key until an alert tone sounds to delete this channel.

When scan feature is enabled again, the deleted channel will return to the scan list.

Note: Priority channel cannot be deleted.

Priority Channel Scan

This feature allows you to scan important channels. The dealer can program a channel as priority channel through the programming software.

Note: The radio will constantly monitor the priority channel when it stops on a non-priority channel. If activity is detected on the priority channel, the radio will revert to the priority channel and remain there as long as the channel stays active.

Please contact your dealer for more details.

Call

Press the programmed call key and the radio will send a preprogrammed signaling code to compatible receivers with the same code. The compatible receiver sounds an alert tone to draw the user’s attention.

Emergency ANI/Emergency Alert

The radio can be programmed to transmit an emergency ANI or emergency alert. ANI can be DTMF or five-tone (set by your dealer).

If emergency alert is enabled, the radio will sound an audible alert at high volume.

1. Press the Emergency Alert key to enable Emergency Alert feature.
2. Press and hold the Emergency Alert key to disable Emergency Alert feature.

If the radio is programmed to transmit emergency ANI, press emergency key and then:

1. The radio transmits emergency ANI on the preprogrammed emergency channel. The times of transmission and the interval time between every two transmission can be set by your dealer.
2. The radio can receive signals during the interval time.

3. Emergency ANI will not be sent any more when emergency ANI transmission is completed or when PTT key/Disable Emergency Key is pressed.
4. The radio will transmit/receive only on the emergency channel (set by your dealer) after exit from the emergency ANI transmission mode until the radio is turned off and back on.
5. In emergency mode, the radio can receive signals, and only PTT and Monitor key are enabled.
6. In emergency mode, if vibration mode is set, the radio will toggle vibration off automatically and output receiver audio through the speaker.
7. If the current transmit power is set as low, it will switch to high power automatically.

Record

Record and play can be performed when the radio is in receiving mode and no signal appears.

Record

1. Press Record key or select Record feature in the menu to begin record.
2. When the memory is full and a new message is received, the oldest unprotected message will be deleted. Unread message will not be deleted.
3. The radio stops recording when the record time elapses or any valid key is pressed or when signal appears.
4. The radio can be set to delete all messages after power off (set by your dealer).

Play

1. Press Play key, the radio can play all the messages continuously starting from newest to oldest. In the menu mode, you can select any message to play.
2. There is a one-second interval and an alert tone between two messages.
3. The radio stops playing when any valid key is pressed or signal appears. When all the messages are played, the radio stops playing.
4. Press Delete key during playing to delete the selected message and continue to play next one. You can select and delete a message through the menu mode.

The radio will sound an alert every two minutes to remind you of the new message. Unread icon will be displayed. When all the new messages are played, the Unread icon

on LCD disappears.

VOX Feature

Plug an earphone into the radio. In the menu mode, turn the VOX feature on to enable VOX feature. The VOX feature enables you to transmit automatically by speaking into the microphone.

1. Transmission starts automatically when you start speaking and stops automatically when you stop speaking.
2. Press the PTT button to disable the VOX feature.

The VOX feature will be reactivated after switching the power off and then back on.

Low Battery Alert

When the battery voltage becomes low, the red LED will flash and a beep sound is heard. At this time, the battery should be replaced or recharged.

2-Tone/HDC1200 Selective Call

The radio can call selected radios if selective call feature is enabled. Selective call signalling includes 2-Tone and HDC signalling.

✧ 2-Tone

Press the Selcall key or go to the required 2-Tone signalling in Call List and press the PTT key to transmit.

The radio enters call waiting mode when transmission ends or at receiving a valid selective signalling. The LED flashes orange in call waiting mode. The radio will exit from the call waiting mode when the call waiting reset time elapses, the MONI key is pressed, or when the channel selector knob is rotated.

Please refer to your dealer for details.

✧ HDC1200

Send a Selective Call

You can send a selective call to another radio or a radio group if your radio supports this function

To send a selective call

1. Press  or shortcut key "SelCall" to enter menu mode (the channel should be defined with HDC1200).

2. Press ◀ or ▶ to find **Selective Call** in the menu and press  key to choose.
3. Press ◀ or ▶ to select required ID in call list, or enter your required ID with the keypad (keypad type model only).
4. Press the PTT key to send the call. The radio alerts with customized alert tone and exits from menu mode to call wait mode.
5. Press the PTT key to transmit and release to receive.
6. The radio resets and exits call wait mode.

Receive a selective call



The radio alerts when receiving a selective call and LED flashes orange.

“Call Received” and preset name (or caller ID) are displayed alternatively on the LCD.

Send an Alert Call

An alert call can be sent to alert others.

To send an alert Call:

1. Press  or shortcut key “SelCall” to enter menu mode (the channel should be defined with HDC1200).
2. Press ◀ or ▶ to find **Alert Call** in the menu and press  key to choose.
3. Press ◀ or ▶ to select required ID in call list, or enter your required ID with the keypad (keypad type model only).
4. Press the PTT key to send the call and. **Transmitting**
5. **Acknowledge** is displayed on the screen when the Call Alert Page is received;
While **No Acknowledge** is displayed when the Call Alert Page is not received;
6. Press the PTT key to transmit and release to receive.
7. The radio resets and exits call wait mode.

Receive an Alert Call



The radio alerts with the customized tone when receiving an alert call. The text “Call Received” and predefined name/Caller ID are displayed alternatively on the LCD before you respond.

Press the PTT key to respond and stop the alert tone. Press any key other than the PTT key to delete the information on LCD after exiting the call wait mode..

Radio Check

This feature allows you to determine whether a radio is in the range that may cause any interference to local radio users. Radio check also works when trying to send a selective call or when call alert fails (need signalling protocol support).

To execute a radio check:

1. Press  or shortcut key “SelCall” to enter menu mode (the channel should be defined with HDC1200).
2. Press ◀ or ▶ key to find **Radio Check** in the menu and press  to select.
3. Press ◀ or ▶ key to select your required ID in call list or enter your required ID number with numeric keypad (for keypad type model only).
4. Press the PTT key to send and **Transmitting** is displayed on the screen.
5. **Acknowledge** appears when the radio check is received while **No Acknowledge** appears when radio check is not received

Radio Kill/Revive

Your radio is endowed with a safe-added feature, which allows the radio to be disabled when a stun signalling is received from a base station.

This feature is applied when:

- The radio is stolen,
- Your vehicle is under maintenance
- System problem

Note: when your radio is disabled by the base station, all the keys are disabled except power on/off keys. The radio can be revived only by receiving a revive signalling from base station. Radio status information before stun is displayed when radio is re-powered on.

Please contact your dealer for more details about the programmable keys

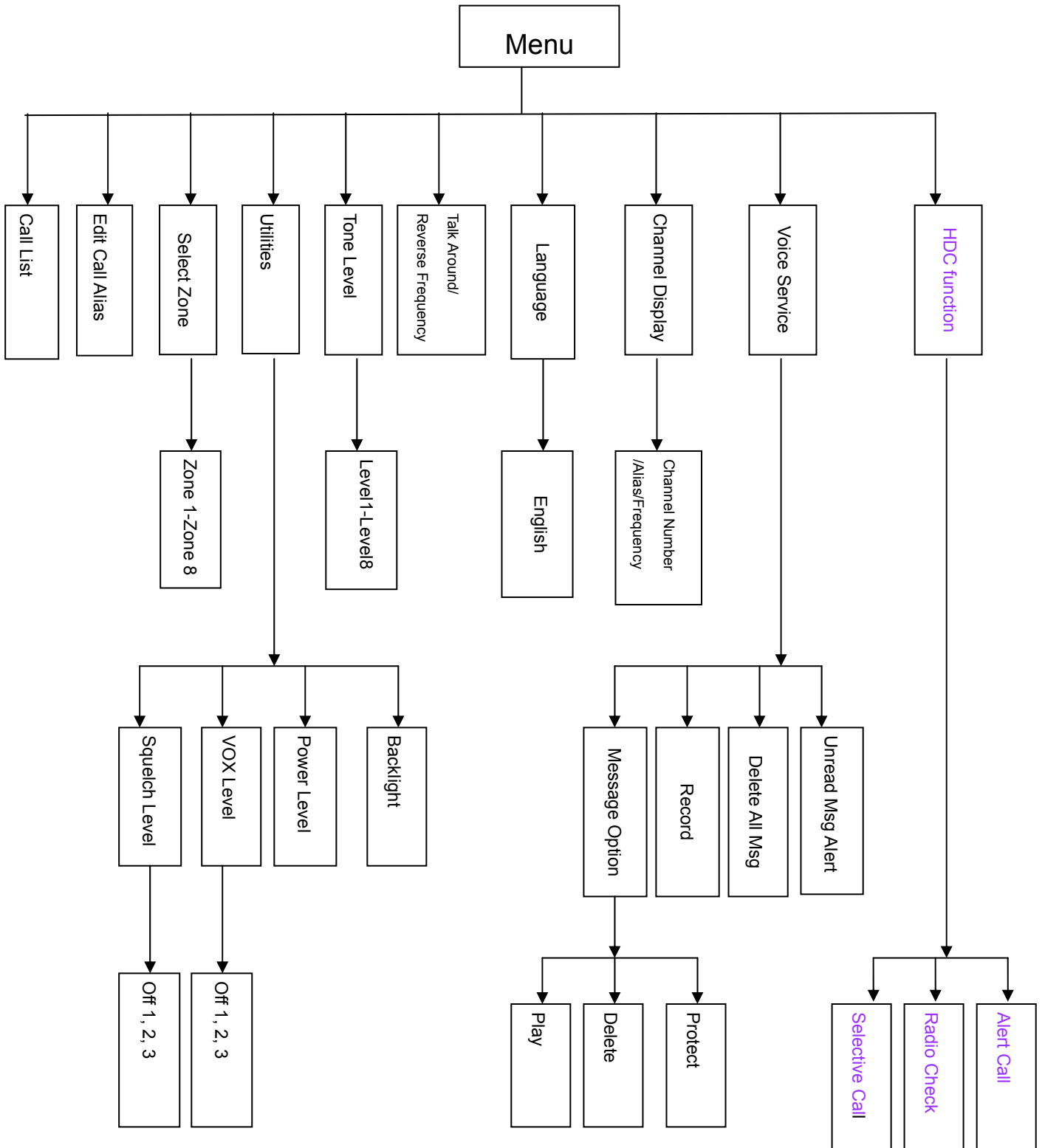

Menu Mode (Functions are subject to addition without prior notice)

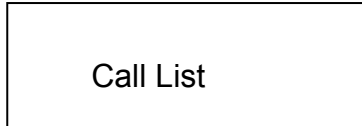

Call List

1. Press  key in standby mode to enter the main menu and go to the “call list” item. Press [C] key to exit from the menu mode.







2. Press  key to enter call list and then press ◀/▶ key to select upwards/downwards. Press  key to save the change and exit from the menu. Press [C] key to return to the upper menu without saving the change.

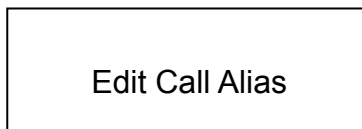

Edit Call Alias

1. Press  in standby mode to enter the main menu and then press ▶ key to enter “edit call alias” item.



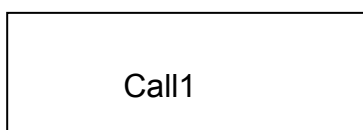

2. Press  key to enter selective call list and then press ◀/▶ key to select a call alias. Press  key again to edit the selective call alias. Input characters through the numeric keyboard and press ◀/▶ key to move. Press  key to save the change and return to the selective call list. Press [C] key to return to the selective call list without saving the change. Press  key to continue the above operation and [C] key to return to the main menu.

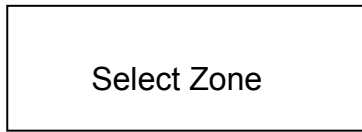

Select Zone

1. Press ► key to enter “select zone” item.



2. Press  key to enter the zone list (1-16) and press ◀/▶ key to select a zone.

Press  key to save the selected zone and return to the main menu. Press [C] key to return to the main menu without saving the change.

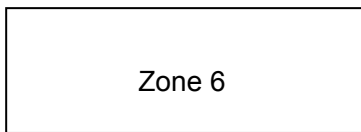



Utilities

Squelch Level

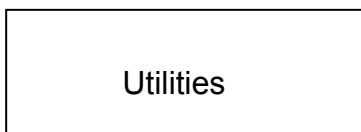
1. Press ► key to enter “Utilities” menu.



2. Press  key to enter the utilities menu. Press ◀/▶ key to select the item and  key to enter the item. After entering the item, LCD displays the current squelch level (Off, level 1-3). Press ◀/▶ key to change the squelch level.

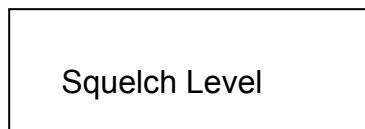

3. Press  key to save the change and return to the utilities menu. Press [C] key to return to the utilities menu without saving the change.

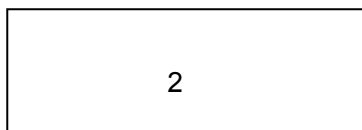

VOX Level

1. Enter the “Utilities” menu.

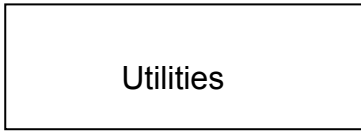

2. Press ► key to go to VOX item. Press  key to enter the item. LCD displays current VOX level.



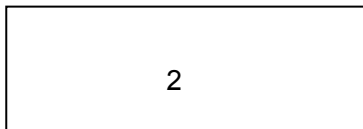

3. Press ◀/▶ key to change the VOX level (off, level 1-3). VOX feature is disabled when OFF. Press  key to save the change and return to the utilities menu. Press [C] key to quit without saving the change.



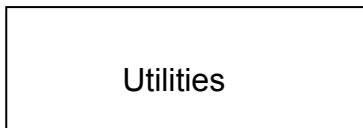

Power Level

1. Enter the “Utilities” menu.

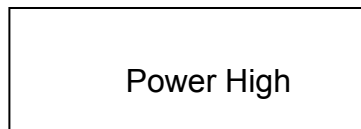
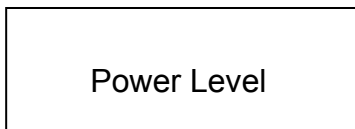

2. Press ► key to go to “power level” item. Press  key to enter the item. LCD displays power level option.



3. Press ◀/▶ key to toggle the power level (High/Low). Press  key to save the change and return to the utilities menu. Press [C] key to quit without saving the change.

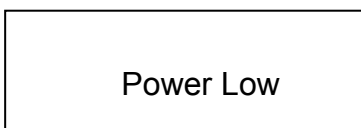



Backlight

1. Enter the “Utilities” menu.

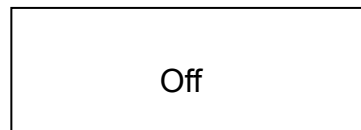
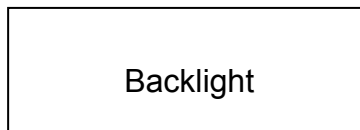

2. Press ► key to go to “backlight” item. Press  key to enter the item. LCD displays backlight option.



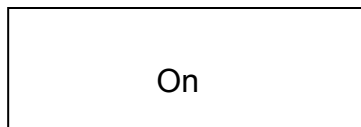

3. Press ◀/▶ key to turn the backlight on/off. Press  key to save the change and return to the utilities menu. Press [C] key to quit without saving the change.



Tone Level

1. Press ► key to go to “tone level” item.



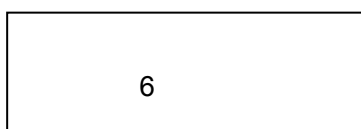

2. Press  key to enter “tone level” (level 1-8) item. LCD displays current tone level. Press ◀/▶ key to change the tone level. You will hear a confirmation tone at the same time. Press  key to save the change and return to the utilities menu. Press [C] key to quit without saving the change.

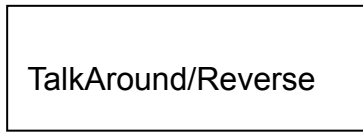

Talk Around/Reverse Frequency

1. Press ► key to go to “talk around/reverse frequency” item.



2. Press  key to enter this item. LCD displays the current transmit mode. Press ◀/▶ key to change the transmit mode. Press  key to save the change and return to the utilities menu. Press [C] key to return without saving the change.

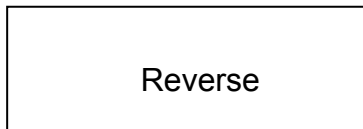

Language

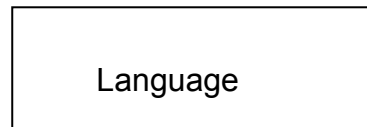

1. Press ► key to go to “language” item. Press  to enter “language” item and LCD displays the current language. Press ◀/▶ key to toggle the language interface. (Only English is available)



Channel Display

1. Press ► key to go to “channel display” item.



2. Press  key to enter channel display item. LCD displays the current channel display mode. Press ◀/▶ key to toggle the display mode. Press  key to save the change and return to the utilities menu. Press [C] key to return without saving the change. Channel display mode can be switched among channel number, channel alias and receiving frequency.



Note:

1. Press ◀/▶ key in the main menu to toggle the setting item in the above order.
2. In the menu mode, the radio will return to the standby mode automatically without saving the setting if the display is kept for over 20 seconds or the channel selector knob is rotated.

Voice Service

Press ▶ key to go to “Voice Service” item. Press  key to enter the item.



Message Option

Press ◀/▶ key to enter “Message Option”. Press ◀/▶ key to select an item and press  key to enter the selected item. After entering the item, press ◀/▶ key to operate as following.

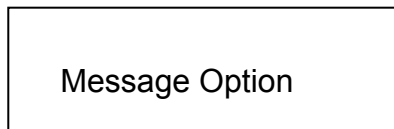



Play: Play the selected message.

Delete: Delete the selected message.



Protect: Protect/Unprotect the selected message. “P” is displayed if a message is a protected message.

Record

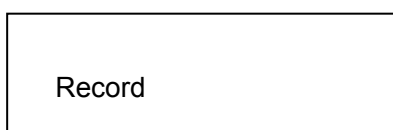
Press ◀/▶ key to enter “Record” item. Press  key to begin recording. The radio stops recording when the record time elapses or  key is pressed again.





Delete All Messages

Press ◀/▶ key to enter “delete all messages” item. Press  key and “Delete All?” will be displayed. Press  key again to delete all messages. Press C key to exit.

Delete All Msg

Unread Message Alert



Press ◀/▶ key to enter “Unread message alert” item. Press  key and “On”/“Off” will be displayed. Press ◀/▶ key to toggle unread message alert on/off. Press  key to save the change. Press C key to exit.

Unread Msg Alert

● HDC Function

1. Press ▶ to go to “HDC function” item.

HDC Function











2. Press  to enter and LCD displays the detailed function items. Press ◀/▶ to toggle between the items and then press  to enter the selected item.



Press  to enter the call list of selected functions. Press ◀/▶ to go to required call list. Press【C】 to go back to HDC function menu. Press the PTT key to transmit the selected call list.

Call List Alias
or
HDC (1-200)

Appendix 1 LCD Display







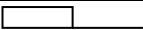

Description				
Signal Strength Indicator	Keypad Lock	Battery Power Indicator	Carrier Indicator	Speaker on
				
High/Low Power	Transmitting	Monitoring	Scanning	Call Waiting
Hi Lo 				
Unread Message				
				

Appendix 2 Entering Characters

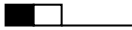
Key	Number of times key is pressed								
	1	2	3	4	5	6	7	8	9
0	0	+	-	*	/	()	<	>
1	Space	1	,	.	'	"	:	!	?
2	A	B	C	2	a	b	c		
3	D	E	F	3	d	e	f		
4	G	H	I	4	g	h	i		
5	J	K	L	5	j	k	l		
6	M	N	O	6	m	n	o		
7	P	Q	R	S	7	p	q	r	s
8	T	U	V	8	t	u	v		
9	W	X	Y	Z	9	w	x	y	z
*	*	&	%						
#	#	@	\$	~					

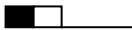
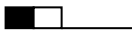
Appendix 3 Alert Tone

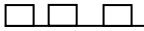
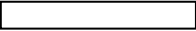
High tone Low tone

Operation	Description	Audible Tone
Turn on the radio	Power on-Ready	
Turn on the radio	Power on-Failure	
Repeater/Talk Around	Repeater	
Repeater/Talk Around	Talk Around	
Repeater/Reverse Frequency	Repeater	
Repeater/Reverse Frequency	Reverse Frequency	
Select Power	High Power	
Select Power	Low Power	
	Low Battery Alert Tone	
	Idle Channel Tone	
	PLL Unlock Tone	

Care and Cleaning

- Avoid physical abuse to your radio such as carrying it by the antenna or by the speaker microphone.
- Wipe the battery contacts with a lint-free cloth to remove dirt, grease, or other material that may prevent good electrical contact.
- When not in use, keep the accessory jacks covered with the protective cap.
- The case, controls, and keypad can be cleaned with a mild detergent and warm water. Avoid using strong chemicals.

Optional Accessories



Dual Pocket Rapid Charger CH20L01
(for Li-Ion batteries)



Multi-unit Charger MCL01
(for Li-Ion batteries)



Remote Speaker
Microphone SM08N1



Receive-only Earpiece with Transparent
Acoustic Tube (use with Remote
Speaker Microphone SM08) ESS04



Receive-only Earpiece (for use with Remote
Speaker Microphone SM08) ESS01



Switch Power (exclusive to dual
pocket rapid charger) PS2001



Earbud with in-line VOX ESN01



Earbud with Transparent
Acoustic Tube EAN01



Earset with Boom Mic & in-line VOX EHN02



Earset with in-line Mic & VOX EHN01



Throat-vibrating Earpiece with
Transparent Acoustic Tube ELN01



Headset ECN02



Chest Pack LCBN03



Transparent Waterproof
Bag LCBY03



Leather Carry Case (display & keypad
model) (applicable to TC3600 series)
LCBY08

Frequency Chart

Model:

Serial Number:

Channel	Transmit Frequency	Transmit CTCSS/DCS	Transmit 2-Tone/5-Tone	Transmit ANI/DTMF	Receive Frequency	Receive CTCSS/DCS	Receive 2-Tone/5-Tone
1							
2							
3							
4							
5							
6							
7							
8							
9							
10							
11							
12							
13							
14							
15							
16							

HYT endeavors to achieve the accuracy and completeness of this manual, but is not liable for any possible omission and printing mistakes.

All the above specifications and design are subject to change without prior notice.

All the reproduction and translation of this manual without authorization of HYT is not allowed.