

FM radio reception

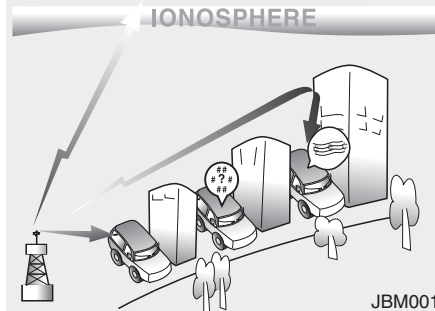

D300800AHM

How vehicle audio works

AM and FM radio signals are broadcast from transmitter towers located around your city. They are intercepted by the radio antenna on your vehicle. This signal is then received by the radio and sent to your vehicle speakers.

When a strong radio signal has reached your vehicle, the precise engineering of your audio system ensures the best possible quality reproduction. However, in some cases the signal coming to your vehicle may not be strong and clear. This can be due to factors such as the distance from the radio station, closeness of other strong radio stations or the presence of buildings, bridges or other large obstructions in the area.

AM radio reception

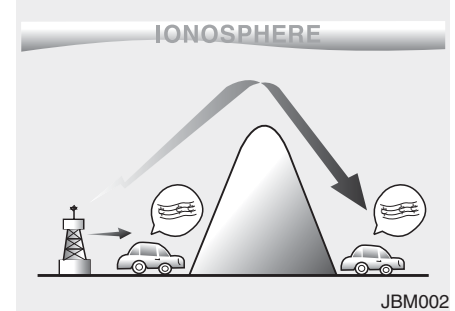

JBM002

AM broadcasts can be received at greater distances than FM broadcasts. This is because AM radio waves are transmitted at low frequencies. These long, low frequency radio waves can follow the curvature of the earth rather than travelling straight out into the atmosphere. In addition, they curve around obstructions so that they can provide better signal coverage.

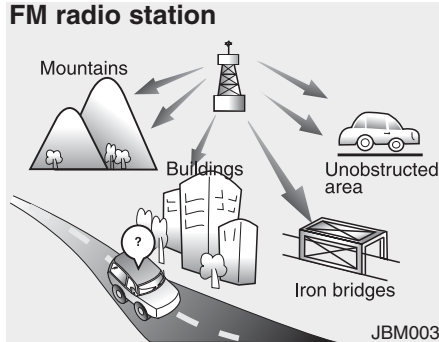

FM broadcasts are transmitted at high frequencies and do not bend to follow the earth's surface. Because of this, FM broadcasts generally begin to fade at short distances from the station.

Also, FM signals are easily affected by buildings, mountains, or other obstructions. These can result in certain listening conditions which might lead you to believe a problem exists with your radio. The following conditions are normal and do not indicate radio trouble:

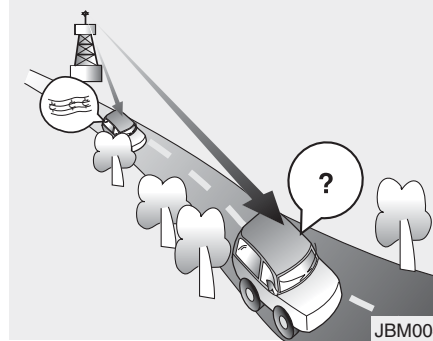

- **Fading** - As your vehicle moves away from the radio station, the signal will weaken and sound will begin to fade. When this occurs, we suggest that you select another stronger station.
- **Flutter/Static** - Weak FM signals or large obstructions between the transmitter and your radio can disturb the signal causing static or fluttering noises to occur. Reducing the treble level may lessen this effect until the disturbance clears.

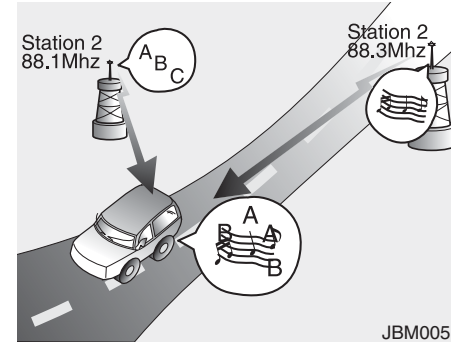

- **Station Swapping** - As a FM signal weakens, another more powerful signal near the same frequency may begin to play. This is because your radio is designed to lock onto the clear-est signal. If this occurs, select another station with a stronger signal.
- **Multi-Path Cancellation** - Radio signals being received from several directions can cause distortion or fluttering. This can be caused by a direct and reflected signal from the same station, or by signals from two stations with close frequencies. If this occurs, select another station until the condition has passed.

Using a cellular phone or a two-way radio

When a cellular phone is used inside the vehicle, noise may be produced from the audio equipment. This does not mean that something is wrong with the audio equipment. In such a case, use the cellular phone at a place as far as possible from the audio equipment.

⚠ CAUTION

When using a communication system such a cellular phone or a radio set inside the vehicle, a separate external antenna must be fitted. When a cellular phone or a radio set is used with an internal antenna alone, it may interfere with the vehicle's electrical system and adversely affect safe operation of the vehicle.

⚠ WARNING

Do not use a cellular phone while driving. Stop at a safe location to use a cellular phone.

Care of disc

- If the temperature inside the car is too high, open the car windows for ventilation before using your car audio.
- It is illegal to copy and use MP3/WMA files without permission. Use CDs that are created only by lawful means.
- Do not apply volatile agents such as benzene and thinner, normal cleaners and magnetic sprays made for analogue disc onto CDs.
- To prevent the disc surface from getting damaged. Hold and carry CDs by the edges or the edges of the center hole only.
- Clean the disc surface with a piece of soft cloth before playback (wipe it from the center to the outside edge).
- Do not damage the disc surface or attach pieces of sticky tape or paper onto it.
- Make sure on undesirable matter other than CDs are inserted into the CD player (Do not insert more than one CD at a time).

- Keep CDs in their cases after use to protect them from scratches or dirt.
- Depending on the type of CD-R/CD-RW CDs, certain CDs may not operate normally according to manufacturing companies or making and recording methods. In such circumstances, if you still continue to use those CDs, they may cause the malfunction of your car audio system.

*** NOTICE - Playing an Incompatible Copy Protected Audio CD**

Some copy protected CDs, which do not comply with the international audio CD standards (Red Book), may not play on your car audio. Please note that if you try to play copy protected CDs and the CD player does not perform correctly the CDs maybe defective, not the CD player.

■ CD Player : AC100DFE/AC110DFE



■ CD Changer : AC600DFE/AC610DFE



*There will be no  Bluetooth logo if the Bluetooth® feature is not supported.

VF_AC100DFE_EU / VF_AC600DFE_EU



Using RADIO, SETUP, VOLUME and AUDIO CONTROL

1. **FM** Button

Turns to FM mode and toggles FM1 and FM2 when the button is pressed each time.

2. **AM** Button

Pressing the **AM** button selects the AM band. AM Mode is displayed on the LCD.

3. **TA** Button

TA(Traffic announcement) Channels in FM, CD, AUX mode, turns on/off the reception of TA channels of RDS.

4. **SEEK** Button

- When the **SEEK TRACK** (down arrow) is pressed, it will automatically tune to the next lower station.
- When the **SEEK TRACK** (up arrow) is pressed, it will automatically tune to the next higher station.

5. **Power** Button & **Volume** Knob

- Turns the audio system on/off when the ignition switch is on ACC or ON.
- If the knob is turned clockwise/counter-clockwise, the volume will increase /decrease.
- Depending on the model if the ignition switch is not on ACC or ON position. the “Battery Discharge” warning appears on LCD after 10 seconds of power-up, and automatically turns off after 1 hours of operation.



6. **PRESET** Buttons

- Press **1** ~ **6** buttons less than 0.8 seconds to play the station saved in each button.

- Press **1** ~ **6** buttons more than 0.8 seconds or longer to save the current station to the respective button with a beep.



7. **AST** Button (AUTO STORE)

When the button is pressed, it automatically selects and saves channels with high reception rate to PRESET buttons **1** ~ **6** and plays the channel saved in PRESET1. If no channel is saved after AST, it will play the previous channel.

- Saves only to the Preset memory (1)~(6) of FMA or AMA mode in some models.

8. **DARK** Button

Turn the LCD Display & Backlight ON/OFF when **DARK** button press.



9. PTY Button

- Moves **PTY FOLDER** button when searching PTY in RDS Broadcasting Program Type selection.
- Moves **PTY FOLDER** button when searching PTY in RDS Broadcasting Program Type selection.

10. SETUP Button

Press the **SETUP** button to convert to Setup Mode. In the Setup Mode screen, select the mode you want to set by pressing the **knob**. Press **knob** to enter detailed setup mode. The Setup Mode screens are each different according to the Bluetooth, External Amp option selections.

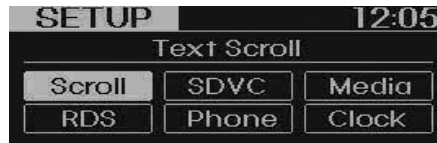

• SCROLL

Select whether long file names are scrolled continuously (On) or just once (Off).



- SDVC (Speed Dependent Volume Control)
Select this item to turn the SDVC feature On or Off. If it is turned ON, volume level is adjusted automatically according to the vehicle speed.



• MEDIA

Select default display of MP3 play information. "Folder/File" or "Artist/Title" can be selected.

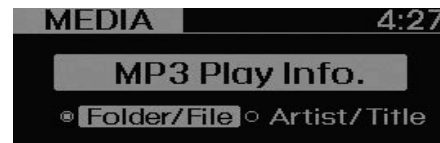

• RDS(if available)

RDS menu includes News/AF/Region/TA Vol. menu sequentially.



- NEWS(NEWS MENU indication is possible with RDS MENU)

Turns the automatic NEWS reception feature ON or OFF.



- AF(AF MENU indication is possible with RDS MENU)

Select this item to turn the AF(Alternate Frequency) feature ON or OFF.



- TA VOL.(TA VOL. MENU indication is possible with RDS MENU)
Adjusts the TA (Traffic Announcement) volume level according to normal audio volume level.



- REGION(REGION MENU indication is possible with RDS MENU)
Selects whether REGION code is used (ON) or not (OFF) once the radio determines the AF jump condition. If AUTO is selected, AF jump condition is determined automatically via PI reception status.



- CLOCK
Select this item to enter Clock setup mode.(12/24Hr., Auto, Time)

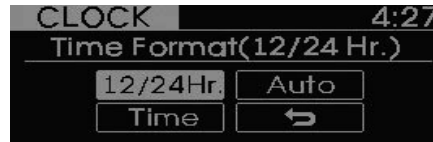

- 12/24 Hr.
Select "12/24 Hr." button to enter Time Format menu.

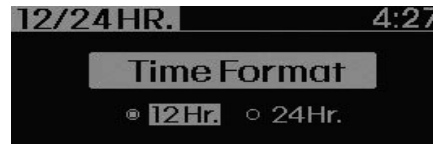

- Auto
Select "Auto" button to enter Automatic RDS Time menu.



- Time
Select "Time" button to enter Time setting. Adjust the hour and press the knob to set. Adjust the minute and press the knob to complete and exit from clock adjustment mode. Pressing the SETUP button more than 0.8 seconds while in power off, screen will allow the user to make immediately adjustments to the clock.

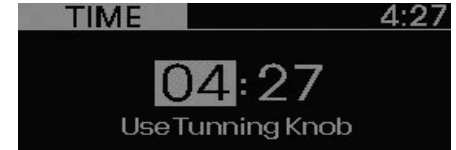



- PHONE (if equipped)
Select this item to enter PHONE setup mode. Refer to "BLUETOOTH PHONE OPERATION" section for detailed information.





* "PHONE" menu is not available if the audio does not support Bluetooth features.



11. & Knob



Within the screen displayed after first pressing the  knob, turn the  knob to select the mode. The modes will change in order of BASS . MIDDLE ↔ TREBLE ↔ FADER ↔ BALANCE.

• BASS Control

Press  and turn the  knob to adjust the bass setting. In this state, turn the  knob clockwise to increase the bass and counter-clockwise to decrease the bass. (Based on bass frequency band, the range of adjustment is max +10/min-10.)



BASS -1 ← BASS 0 → BASS +1

• MIDDLE Control

Press  and turn the  knob to adjust the middle setting. In this state, turn the  knob clockwise to increase the middle and counter-clockwise to decrease the middle. (Based on middle frequency band, the range of adjustment is max +10/min-10.)



MIDDLE -1 ← MIDDLE 0 → MIDDLE +1

• TREBLE Control

Press  and turn the  knob to adjust the treble setting. In this state, turn the  knob clockwise to increase the treble and counter-clockwise to decrease the treble. (Based on treble frequency band, the range of adjustment is max +10/min-10.)



TREBLE -1 ← TREBLE 0 → TREBLE +1

• FADER Control

Press  and turn the  knob clockwise and counter-clockwise to adjust the front/rear volume levels. In this state, turn the  knob clockwise to increase the front speaker volume and counter-clockwise to increase the rear speaker volume. (The front/rear can each be adjusted to F=10/R=10.)

FADER F=1 ← FADER F=R → FADER R=1

• BALANCE Control

Press  and turn the  knob to adjust the left/right volume setting. In this state, turn the  knob clockwise to decrease the left speaker volume and counter-clockwise to decrease the right speaker volume.

(The left/right can each be adjusted to L=10/R=10.)







Using CD Player

1. **CD/AUX** Button (CD)

If the CD is loaded, turns to CD mode. If no CD, it displays "No Media" for 3 seconds and returns to the previous mode.

2. **TRACK** Button

- Press  button for less than 0.8 seconds to play from the beginning of current song.
- Press  button for less than 0.8 seconds and press again within 1 second to play the previous song.
- Press  button for 0.8 seconds or longer to initiate reverse direction high speed sound search of current song.

- Press  button for less than 0.8 seconds to play the next song.
- Press  button for 0.8 seconds or longer to initiate forward direction high speed sound search of current song



3. **1** Button (RANDOM)

Press this button for less than 0.8 seconds to activate 'RDM' mode and more than 0.8 seconds to activate 'ALL RDM' mode.

- RDM : Only files/tracks in a folder/disc are played back in a random sequence.
- ALL RDM (MP3/WMA Only) : All files in a disc are played back in the random sequence.

4. **2** Button (REPEAT)

Press this button for less than 0.8 seconds to activate 'RPT' mode and more than 0.8 seconds to activate 'FLD.RPT' mode.

- RPT : Only a track (file) is repeatedly played back.
- FLD.RPT (MP3/WMA Only) : Only files in a folder are repeatedly played back.

5. **5** Button (SCAN)

Play each song in the CD for 10 seconds. To cancel SCAN Play, press this button again.

6. **DISC** Button (CD changer : AC600DFE/AC610DFE)

- Preset **3** change button changes disc to the previous disc.
- Preset **4** change button changes disc to the next disc.



7. INFO Button

Displays the information of the current song.

- Audio CD : Disc Title/Artist, Track Title /Artist, Total Track.
- MP3 CD : File Name, Title, Artist, Album, Folder, Total Files (Not displayed if the information is unavailable on the CD or file.)

8. FOLDER Button

- Press button to move to child folder of the current folder and display the first song in the folder. Press knob to move to the folder displayed. It will play the first song in the folder.
- Press button to move to parent folder of the current folder and display the first song in the folder.

Press knob to move to the folder displayed.

9. & Knob

- Turn this knob clockwise to browse songs after current song, or counter-clockwise to browse songs before current song. To play the displayed song, press the knob.
- Pressing this knob without turning enters to AUDIO CONTROL mode.



10. CD Eject Button

Push button for less than 0.8 seconds to eject the CD during CD playback. This button is enabled when ignition switch is off.

- ALL EJECT (CD Changer : AC600DFE/AC610DFE)

Press this button for more than 0.8 seconds to eject all discs inside the deck in respective order.

11. CD Slot

Insert a CD label side up and gently push in while ignition switch is on ACC or ON. The audio automatically switches to CD mode and begins to play the CD.

If the audio was turned off, audio power will automatically turned on as the CD is inserted.

- This audio only recognizes 12cm-size, CD-DA (Audio CD) or ISO data-CD (MP3 CD).
- If UDF data-CD or non-CD (e.g. DVD) is inserted, "Reading Error" message will be displayed and the disc will be ejected.

12. CD Indicator (CD Player : AC100 DFE /AC110DFE)

When car ignition switch is ACC or ON and if the CD is loaded, this indicator is lighted. If the CD is ejected the light is turned off.



CAUTION

Do not insert a CD if CD indicator is lit.



13. LOAD Button (CD Changer : AC600DFE/AC610DFC)

Push **LOAD** button to load CDs to available CDC deck (from 1~6). Push **LOAD** button for more than 2 seconds to load into all available decks. The last CD will play. 10 seconds idle status will disable loading process.

NOTE:

Order of playing files (folders) :

1. Song playing order : ① to ⑭ sequentially.

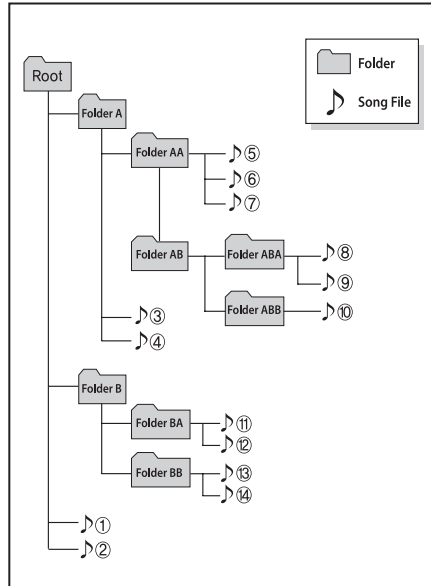

2. Folder playing order :

* If no song file is contained in the folder, that folder is not displayed.

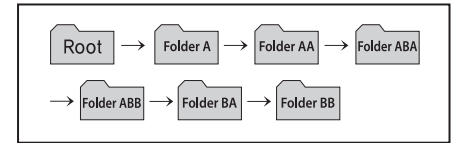

CAUTION IN USING USB DEVICE

- To use an external USB device, make sure the device is not connected when starting up the vehicle. Connect the device after starting up.
- If you start the engine when the USB device is connected, it may damage the USB device. (USB flashdrives are very sensitive to electric shock.)
- If the engine is started up or turned off while the external USB device is connected, the external USB device may not work.
- It may not play inauthentic MP3 or WMA files.
 - 1) It can only play MP3 files with the compression rate between 8Kbps~320Kbps.
 - 2) It can only play WMA music files with the compression rate between 8Kbps~320Kbps.
- Take precautions for static electricity when connecting or disconnecting the external USB device.

(Continued)

(Continued)

- An encrypted MP3 PLAYER is not recognizable.
- Depending on the condition of the external USB device, the connected external USB device can be unrecognizable.
- When the formatted byte/sector setting of External USB device is not either 512BYTE or 2048BYTE, then the device will not be recognized.
- Use only a USB device formatted to FAT 12/16/32.
- USB devices without USB I/F authentication may not be recognizable.
- Make sure the USB connection terminal does not come in contact with the human body or other objects.
- If you repeatedly connect or disconnect the USB device in a short period of time, it may break the device.
- You may hear a strange noise when connecting or disconnecting a USB device.

(Continued)

(Continued)

- If you disconnect the external USB device during playback in USB mode, the external USB device can be damaged or may malfunction. Therefore, disconnect the external USB device when the audio is turned off or in another mode. (e.g, **Radio or CD**)
- Depending on the type and capacity of the external USB device or the type of the files stored in the device, there is a difference in the time taken for recognition of the device.
- Do not use the USB device for purposes other than playing music files.
- **Playing videos through the USB is not supported.**
- Use of USB accessories such as rechargers or heaters using USB I/F may lower performance or cause trouble.
- If you use devices such as a USB hub purchased separately, the vehicle's audio system may not recognize the USB device. In that case, connect the USB device directly to the multimedia terminal of the vehicle.

(Continued)

(Continued)

- *If the USB device is divided by logical drives, only the music files on the highest-priority drive are recognized by car audio.*
- *Devices such as MP3 Player/ Cellular phone/Digital camera can be unrecognizable by standard USB I/F can be unrecognizable.*
- *Charging through the USB may not be supported in some mobile devices.*
- ** A car exclusive cable (Provided or sold separately) is required to use the iPod.*
- *Some non-standard USB devices (METAL COVER TYPE USB) can be unrecognizable.*
- *Some USB flash memory readers (such as CF, SD, microSD, etc.) or external-HDD type devices can be unrecognizable.*
- *Music files protected by DRM (DIGITAL RIGHTS MANAGEMENT) are not recognizable.*
- *The data in the USB memory may be lost while using this audio. Always back up important data on a personal storage device.*

(Continued)

(Continued)

- *Please avoid using USB memory products which can be used as key chains or cellular phone accessories as they could cause damage to the USB jack. Please make certain only to use plug type connector products as shown below.*





Using USB device

1. **CD/AUX** Button (USB or AUX)

If the auxiliary device is connected, it switches to USB or AUX mode to play the sound from the auxiliary player.

If there is no auxiliary device, then the message “No Media” will become displayed on the LCD for 3 seconds and returns to previous mode.

2. **TRACK** Button

- Press the **SEEK TRACK** button for less than 0.8 seconds to play from the beginning of the current song. Press the button for less than 0.8 seconds and press it again within 1 second to move to and play the previous song.

Press the button for 0.8 seconds or longer to play the song in reverse direction in fast speed.

- Press the **SEEK TRACK** button for less than 0.8 seconds to move to the next song. Press the button for 0.8 seconds or longer to play the song in forward direction in fast speed.

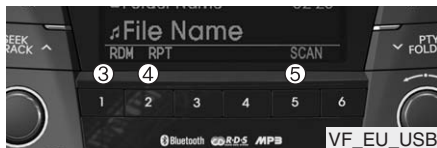

3. **1** Button (RANDOM)

- Press this button for less than 0.8 seconds to play songs randomly in current folder.
- Press this button for 0.8 seconds or longer to play songs randomly in entire USB device.
- To cancel RANDOM play, press this button again.

4. **2** Button (REPEAT)

- Press this button for less than 0.8 seconds to repeat current song.

- Press this button for 0.8 seconds or longer to repeat all songs in current folder.
- To cancel REPEAT, press this button again.

5. **5** Button (SCAN)

Plays each song in the USB device for 10 seconds. To cancel **SCAN play**, press this button again.







6. **INFO** Button

Displays the information of the file currently played in the order of FILE NAME, TITLE, ARTIST, ALBUM, FOLDER, TOTAL FILE, NORMAL DISPLAY (Displays no information if the file has no song information.)



- Pressing this knob without turning enters to AUDIO CONTROL mode.

7. **FOLDER** Button

- Press  button to move to child folder of the current folder and display the first song in the folder.
Press  knob to move to the folder displayed. It will play the first song in the folder.
- Press  button to move to parent folder display the first song in the folder. Press  knob to move to the folder displayed.

8. & Knob

- Turn this knob clockwise to browse songs after current song, or counter clockwise to browse songs before current song. To play the displayed song, press the knob.

* NOTICE FOR USING THE iPod DEVICE

- Some iPod models might not support the communication protocol and the files will not be played.
Supported iPod models:
 - iPod Mini
 - iPod 4th(Photo) ~ 6th(Classic) generation
 - iPod Nano 1st~4th generation
 - iPod Touch 1st~2nd generation
- The order of search or playback of songs in the iPod can be different from the order searched in the audio system.
- If the iPod disabled due to its own malfunction, reset the iPod. (Reset: Refer to iPod manual)
- An iPod may not operate normally on low battery.
- Some iPod devices, such as the iPhone, can be connected through the Bluetooth® interface. The device must have audio Bluetooth® capability (such as for stereo headphone Bluetooth®). The device can play, but it will not be controlled by the audio system.



CAUTION IN USING THE iPod DEVICE

- The **Hyundai** iPod Power Cable is needed in order to operate iPod with the audio buttons on the audio system. The USB cable provided by Apple may cause malfunction and should not be used for **Hyundai** vehicles.
- * The **Hyundai** iPod Power Cable may be purchased through your **Hyundai** Dealership.
- When connecting iPod with the iPod Power Cable, insert the connector to the multimedia socket completely. If not inserted completely, communications between iPod and audio may be interrupted.
- When adjusting the sound effects of the iPod and the audio system, the sound effects of both devices will overlap and might reduce or distort the quality of the sound.
- Deactivate (turn off) the equalizer function of an iPod when adjusting the audio system's volume, and turn off the equalizer of the audio system when using the equalizer of an iPod.

(Continued)

(Continued)

- When the iPod cable is connected, the system can be switched to AUX mode even without iPod device and may cause noise. Disconnect the iPod cable when you are not using the iPod device.
- When not using iPod with car audio, detach the iPod cable from iPod. Otherwise, iPod may remain in accessory mode, and may not work properly.

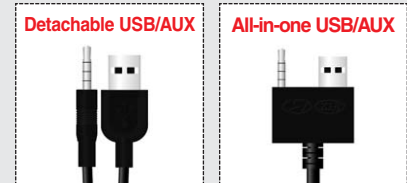

- When connecting the iPod, use the USB/AUX terminals.
- When disconnecting the iPod, disconnect both the USB/AUX terminal.
- The iPod exclusive cable must be connected to both the USB/AUX terminals for iPod charging and operations to be supported.



Using iPod

* iPod is a trademark of Apple Inc.

1. **CD/AUX** Button (iPod)

If iPod is connected, it switches to the iPod mode from the previous mode to play the song files stored in the iPod.

If there is no iPod connected, then it displays the message "No Media" for 3 seconds and returns to the previous mode.

2. **TRACK** Button

- Press **SEEK TRACK** button for less than 0.8 seconds to play from the beginning of current song.
- Press **SEEK TRACK** button for less than 0.8 seconds and press again within 1 second to play the previous song.

- Press **SEEK TRACK** button for 0.8 seconds or longer to initiate reverse direction high speed sound search of current song.
- Press **SEEK TRACK** button for less than 0.8 seconds to play the next song.
- Press **SEEK TRACK** button for 0.8 seconds or longer to initiate forward direction high speed sound search of current song.

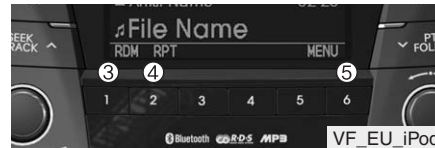

3. **1** Button (RANDOM)

- Press this button for less than 0.8 seconds to shuffle order of all songs in current category. (Song Random)
- Press this button for 0.8 seconds or longer to shuffle order of albums in current category. (Album Random)
- To cancel RANDOM Play, press this button again.

4. **2** Button (REPEAT)

Repeats the song currently played.

5. **6** Button (MENU)

Moves to the upper category from currently played category of the iPod.

To move to (play) the category (song) displayed, press **SEEK TRACK** knob.

You will be able to search through the lower category of the selected category. The standard order of iPod's category is **SONGS, ALBUMS, ARTISTS, GENRES**, iPod.



6. **INFO** Button

Displays the information of the file currently played in the order of TITLE, ARTIST, ALBUM, NORMAL DISPLAY (Displays no information if the file has no song information.)



7. & Knob

When you rotate the knob clockwise, it will display the songs (category) ahead of the song currently played (category in the same level).

Also, when you rotate the knob counter-clockwise, it will display the songs (category) before the song currently played (category in the same level).

To listen to the song displayed in the song category, press the button to skip to and play the selected song.

Pressing the button changes the BASS, MIDDLE, TREBLE, FADER and BALANCE TUNE mode. The mode selected is shown on the display. After selecting each mode, rotate the Audio control knob clockwise or counterclockwise.



CAUTION IN USING BLUETOOTH® CELLULAR PHONE

- *Do not use a cellular phone or perform Bluetooth® settings (e.g. pairing a phone) while driving.*
- *Some Bluetooth®-enabled phones may not be recognized by the system or fully compatible with the system.*
- *Before using Bluetooth® related features of the audio system, refer your phone's User's Manual for phone-side Bluetooth® operations.*
- *The phone must be paired to the audio system to use Bluetooth® related features.*
- *You will not be able to use the hands-free feature when your phone (in the car) is outside of the cellular service area (e.g. in a tunnel, in a underground, in a mountainous area, etc.).*
- *If the cellular phone signal is poor or the vehicles interior noise is too loud, it may be difficult to hear the other person's voice during a call.*



(Continued)

(continued)

- *Do not place the phone near or inside metallic objects, otherwise communications with Bluetooth® system or cellular service stations can be disturbed.*
- *While a phone is connected through Bluetooth® your phone may discharge quicker than usual for additional Bluetooth®-related operations.*
- *Some cellular phones or other devices may cause interference noise or malfunction to audio system. In this case, store the device in a different location may resolve the situation.*
- *Please save your phone name in English, or your phone name may not be displayed correctly.*

BLUETOOTH® PHONE OPERATION (if equipped)



1. **VOLUME** button : Raises or lowers speaker volume.
2.  button : Activates voice recognition.
3.  button : Places or transfers a call.
4.  button : Rejects or ends a call.

■ What is Bluetooth®?

Bluetooth® is a wireless technology that allows multiple devices to be connected in a short range, low-powered devices like hands-free, stereo headset, steering remote control, etc. For more information, visit the Bluetooth® website at www.Bluetooth.com

■ General Features

- This audio system supports Bluetooth® hands-free and stereo-headset features.
 - HANDS-FREE feature: Making or receiving calls wirelessly through voice recognition.
 - STEREO-HEADSET feature: Playing music from cellular phones (that supports A2DP feature) wirelessly.
- Voice recognition engine of the Bluetooth® system supports 10 types of languages:
 - FRENCH
 - GERMAN
 - UK ENGLISH
 - SPANISH
 - DUTCH
 - ITALIAN
 - DANISH
 - RUSSIAN
 - POLISH
 - SWEDISH

* NOTICE

- The phone must be paired to the system before using Bluetooth® features.
- Only one selected (linked) cellular phone can be used with the system at a time.
- Some phones are not fully compatible with this system.
- The Bluetooth® word mark and logos are registered trademarks owned by Bluetooth® SIG, Inc. and any use of such marks by Hyundai is under license. A Bluetooth enabled cell phone is required to use Bluetooth® wireless technology.

■ Bluetooth® Language Setting

The system language can be changed by the following steps:

1. Power on the audio system with the volume set to an audible level.
2. Press and hold  button on the steering wheel until the audio displays "Please Wait".
 - The Bluetooth® system will reply in currently selected language that it is changing to the next language.
 - System language cycles between FRENCH/GERMAN/UK ENGLISH SPANISH/DUTCH/ITALIAN/DANISH/ RUSSIAN/POLISH/SWEDISH.
3. When completed, the audio display returns to normal.
4. Repeat steps 2 and 3 for the next language selection.

NOTE:

The phone needs to be paired again after changing system language.

- **Avoid resting your thumb or finger on the  button as the language could unintentionally change.**

■ Voice Recognition Activation



- The voice recognition engine contained in the Bluetooth® System can be activated in the following conditions:

- Button Activation

The voice recognition system will be active when the  button is pressed and after the sound of a Beep.

- Active Listening

The voice recognition system will be active for a period of time when the Voice Recognition system has asked for a customer response.

- The system can recognize single digits from zero to nine while number greater than ten will not be recognized.
- If the command is not recognized, the system will announce "Pardon" or No input voice signal from microphone. (No response)
- The system shall cancel voice recognition mode in following cases : When pressing the  button and saying cancel following the beep. When not making a call and pressing the  button. When voice recognition has failed 3 consecutive times.

- At any time if you say "help", the system will announce what commands are available.

■ Menu tree

The menu tree identifies available voice recognition Bluetooth® functions.

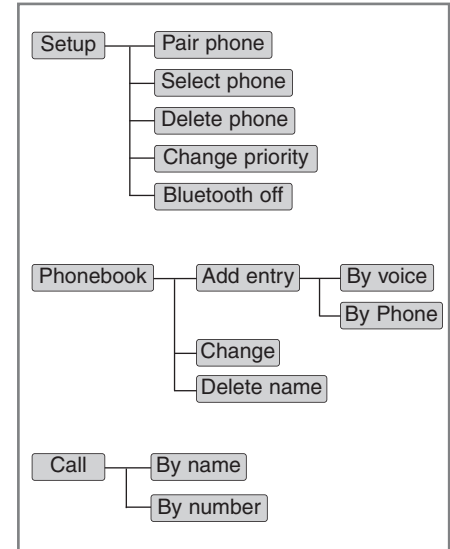

■ Voice Operation Tip

To get the best performance out of the Voice Recognition System, observe the following:

- Keep the interior of the vehicle as quiet as possible. Close the window to eliminate surrounding noise (traffic noise, vibration sounds, etc), which may disturb recognizing the voice command correctly.
- Speak a command after a beep sound within 5 seconds. Otherwise the command will not be received properly.
- Speak in a natural voice without pausing between words.

■ Phone Setup

All Bluetooth®-related operations can be performed by voice command or by manual operation.

- By Voice Command:



1. Press  button.
2. Say "Set up".
 - The system replies with available commands.
 - 1) Pair phone
 - 2) Select phone
 - 3) Delete phone
 - 4) Change priority

5) Bluetooth off

- To skip the information message, Press  again and then a beep is heard.



- By Manual Operation:

1. Push the **SETUP** button to enter SETUP mode.
2. Rotate the  knob to move the cursor between items push the  knob to select "Phone".

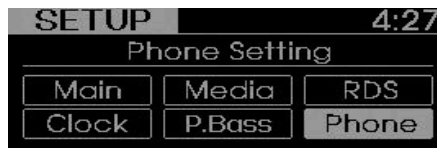

3. Rotate the  knob to move the cursor between items and push the  knob to select a desired item.



• Pairing phone

Before using Bluetooth® features, the phone must be paired (registered) to the audio system. Up to 5 phones can be paired with the system.



NOTE:

The pairing procedure of the phone varies according to each phone model. Before attempting to pair phone, please see your phone's User's Guide for instructions.

NOTE:

Once pairing with the phone is completed, there is no need to pair with that phone again unless the phone is deleted manually from the audio system (refer "Deleting Phone" section) or the vehicle's information is removed from the phone.

- By Voice Command:

1. Press  button.
2. Say "Set Up".
 - The system replies with available commands.
 - To skip the information message, press  again and then a beep is heard.

3. Say "Pair Phone"
4. Proceed at next step.
5. Say the name of your phone when prompted.
 - Use any name to uniquely describe your phone.
 - Use Full name to voice tag.
 - Not use to short name or similar to voice command.
6. Bluetooth® system will repeat the name you stated.
7. Say "Yes" to confirm.
8. The audio displays "searching passkey: 0000" and asks you to initiate pairing procedure from the phone.
9. Search the Bluetooth® system on your phone .Your phone should display your [vehicle model name] on the Bluetooth® device list. Then attempt pairing on your phone
10. After Pairing is completed, your phone will start to transfer phone/contact list to the audio system.
 - This process may take from a few minutes to over 10 minutes depending on the phone model and number of entries in the phone/contact list.

- By Manual Operation:
1. Select "Pair" in PHONE menu, then proceed from step5.



NOTE:

- **Until the audio displays "Transfer Complete", Bluetooth® hands-free feature may not be fully operational.**
- **Depending on the phone make and model, the phone book contact list mat not transfer to the audio system.**

NOTE:

If the phone is paired to two or more vehicles of the same model, i.e. both vehicles are HYUNDAI i40, some phones may not handle Bluetooth® devices of that name correctly. In this case, you may need to change the

name displayed on your phone from i40 to i401 and i402.

Refer to your phone's User's Guide, or contact your cellular carrier or phone manufacturer for instructions.

• Connecting phone

When the Bluetooth® system is enabled, the phone previously used is automatically selected and re-connected. If you want to select different phone previously paired, the phone can be selected through "Select Phone" menu.

Only a selected phone can be used with the hands-free system at a time.

- By Voice Command:

1. Press  button.
2. Say "Set Up".
3. Say "Select Phone" after prompt
 - The system lists all the registered phone names.
4. Say the name or number of desired phone from the list.
5. Say "Yes" to confirm.

- By Manual Operation:

1. Select "Select" in PHONE menu, then select desired phone from the list.

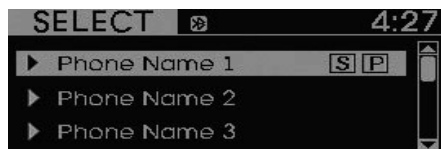

• Changing Priority

When several phones are paired to the audio system, the system attempts to connect following order when the Bluetooth® is enabled:

1. "Priority" checked phone.
2. Previously connected phone
3. Gives up auto connection.

- By Voice Command:

1. Press  button.
2. Say "Set Up".
3. Say "Change Priority" after prompt.
 - The system lists all the registered phone names.

4. Say the name or number of desired phone from the list.
5. Say "Yes" to confirm.

- By Manual Operation:

1. Select "Priority" in PHONE menu, then select desired phone from the list.

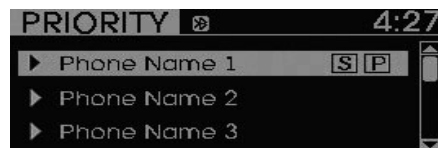

• Deleting Phone

The paired phone can be deleted.

- When the phone is deleted, all the information associated with that phone is also deleted (including phonebook).
- If you want to use the deleted phone with the audio system again, pairing procedure must be completed once more.

- By Voice Command:

1. Press  button.
2. Say "Set Up".
3. Say "Delete Phone" after prompt.
 - The system lists all the registered phone names.
4. Say the name or number of desired phone from the list.
5. Say "Yes" to confirm.

- By Manual Operation:

1. Select "Delete" in PHONE menu, then select desired phone from the list.

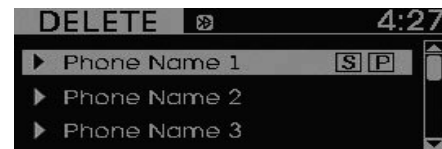

• **Changing Language**

- By Voice Command:

1. Select "Language" in PHONE menu, adjust language to desired language by turning  knob, then press the knob to confirm.

- Supported Languages:

FRENCH/GERMAN/UK ENGLISH
SPANISH/DUTCH/ITALIAN/DANISH/RUSSIAN/POLISH/SWEDISH.

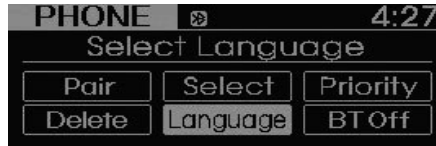

NOTE:

The Phone need to be paired again after changing system language.

- Avoid resting your thumb or finger on the talk button as the language could unintentionally change.

• **Turning Bluetooth® ON/OFF**

Bluetooth® system can be enabled (ON) or disabled (OFF) by this menu.

- If Bluetooth® is disabled, all the commands related to Bluetooth® system prompts whether you wish to turn Bluetooth® ON or not.

- By Voice Command:

1. Press  button.
2. Say "Set Up"
3. Say "Bluetooth Off" after prompt.
4. Say "Yes" to confirm.

- By Manual Operation:

1. Select "BT Off" in PHONE menu, then after announcement, say "YES" to confirm.

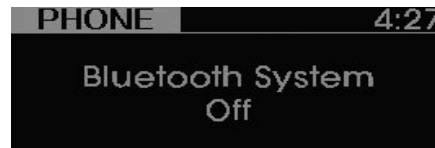



■ **Phone Book (In-Vehicle)**

• **Adding Entry**

Phone numbers and voice tags can be registered. Entries registered in the phone can also be transferred.

• **Adding Entry by Voice**

1. Press  button.
2. Say "Phonebook".
 - The system replies with all available commands.
 - To skip the information message, press  again and then a beep is heard.
3. Say "Add Entry".
4. Say "By Voice" to proceed.
5. Say the name of the entry when prompted.
6. Say "Yes" to confirm.
7. Say the phone number of that entry when prompted.
8. Say "Store" if phone number input is finished.
9. Say a phone number type. "Home", "Work", "Mobile", "Other" or "Default" is available.
10. Say "Yes" to complete adding entry.
11. Say "Yes" to store additional location for this contact, or say "Cancel" to finish the process.

* NOTICE

- The system can recognize single digits from zero to nine. Numbers that are ten or greater cannot be recognized.
- You can enter each digit individually or group digits together in preferred string lengths.
- To speed up input, it is a good idea to group all digits into a continuous string.
- Recommend to enter the numbers constituted an grouping within all digit numbers to dial 995 / 734 / 0000.
- The display corresponding to each operation appears on the screen as follows:

Input operation example:

1. Say: "Nine, nine, five"

→ Display: "995"

2. And say: "Seven, three, four"

→ Display: "995734"

• Adding Entry by Phone

1. Press  button.
2. Say "Phonebook".
3. Say "Add Entry" after prompt.
4. Say "By Phone" to proceed.
5. Say "Yes" to confirm.
6. Your phone will start to transfer phone/contact list to the audio system. This process may take over 10 minutes depending on the phone model and number of entries
7. Wait till the audio displays "Transfer Complete" message.

• Changing Name

The registered names can be modified.

1. Press  button.
2. Say "Phonebook".
3. Say "Change Name" after prompt.
4. Say the name of the entry (voice tag).
5. Say "Yes" to confirm.
6. Say new desired name.

• Deleting Name

The registered names can be deleted.

1. Press  button.
2. Say "Phonebook".
3. Say "Delete Name" after prompt.
4. Say the name of the entry (voice tag).
5. Say "Yes" to confirm.

■ Making a Phone Call

• Calling by Name

A phone call can be made by speaking names registered in the audio system.

1. Press  button.
2. Say "Call".
3. Say "Name" when prompted.
4. Say desired name (voice tag).
5. Say desired location (phone number type). Only stored locations can be selected.
6. Say "Yes" to confirm and make a call.

* Tip

A shortcut to each of the following functions is available:

1. Say "Call Name"
2. Say "Call <john>"
3. Say "Call <john> at <home>"

• Dialing by Number

A phone call can be made by dialing the spoken numbers. The system can recognize single digits from zero to nine.

1. Press  button.
2. Say “Call”.
3. Say “Number” when prompted.
4. Say desired phone numbers.
5. Say “Dial” to complete the number and make a call.

* Tip



A shortcut to each of the following functions is available:

1. Say “Dial Number”
2. Say “Dial <digit>”

■ Receiving a Phone Call

When receiving a phone call, a ringtone is audible from speakers and the audio system changes into telephone mode.

When receiving a phone call, “Incoming call” message and incoming phone number (if available) are displayed on the audio.

- To Answer a Call:
 - Press  button on the steering wheel.
- To Reject a Call:
 - Press  button on the steering wheel.
- To Adjust Ring Volume:
 - Use VOLUME buttons on the steering wheel.
- To Transfer a Call to the Phone (Secret Call):
 - Press  button on the steering wheel until the audio system transfers a call to the phone.

■ Talking on the Phone

When talking on the phone, “Active Call” message and the other party’s phone number (if available) are displayed on the audio.

- To Finish a Call
 - Press  button on the steering wheel.

* NOTICE

In the following situations, you or the other party may have difficulty hearing each other:

1. Speaking at the same time, your voice may not reach each other parties. (This is not a malfunction.) Speak alternately with the other party on the phone.
2. Keep the Bluetooth® volume to a low level. High-level volume may result in distortion and echo.
3. When driving on a rough road.
4. When driving at high speeds.
5. When the window is open.
6. When the air conditioning vents are facing the microphone.
7. When the sound of the air conditioning fan is loud.

■ Bluetooth® Audio Music Streaming

The audio system supports Bluetooth® A2DP (Audio Advanced Distribution Profile) and AVRCP (Audio Video Remote Control Profile) technologies.

Both profiles provide streaming of music via compatible “PAIRED” Bluetooth® Cellular phone.



To stream music from the Bluetooth® cellular phone, play your music files on your cellular phone according to your cellular phone user’s manual and press the **CD/AUX** button on the audio system until “MP3 play” is displayed on the LCD.

The audio system head unit displays ‘MP3 MODE’.

NOTE:

- In addition to streaming MP3 files, all music and sound files your cellular phone supports can be played by the audio system.
- Bluetooth® compatible cellular phones must include A2DP and AVRCP capabilities.
- Some A2DP and AVRCP compatible Bluetooth® cellular phones may not play music through the audio system initially. These cellular phones may need to have the Bluetooth® streaming enabled, for example;
i.e : Menu→Filemanager→Music→Option→Play via Bluetooth
- Please refer to User’s Guide for your cellular phone for more information. To cancel Bluetooth® cellular phone music streaming, stop music playback on the cellular phone or change the audio mode to AM/FM, CD, iPod, ect.

■ Key matrix

No.	KEY		Class							
			Paired H/P Empty	Disconnected	Connected		Incoming Call	Outgoing Call	Active Call	2nd Call
					Normal mode	BT SETUP menu				
1		SHORT	Not Paired	Not Connecting	-	-	Accept Call	-	2nd call 1st Call:waiting 2nd Call:active	2nd Call 2nd Call:waiting 1st Call:active
		LONG	-	-	-	-	-	-	Transfer call:secret call	
2		SHORT	VR MODE Cancel	VR MODE Cancel	VR MODE Cancel	VR MODE Cancel	Reject Call	End Call	End Call	End Call
		LONG [10sec]	-	-	Speaker Adaptation (Only English)	Speaker Adaptation (Only English)	-	-	-	-
3		SHORT	Active	Active	Active	Active	-	-	-	-
		LONG [10sec]	-	-	-	-	-	-	-	-

This equipment has been tested and found to comply with the limits for a Class A digital device, pursuant to part 15 of the FCC Rules. These limits are designed to provide reasonable protection against harmful interference in a residential installation. This equipment generates, uses and can radiate radio frequency energy and, if not installed and used in accordance with the instructions, may cause harmful interference to radio communications. However, there is no guarantee that interference will not occur in a particular installation. If this equipment does cause harmful interference to radio or television reception, which can be determined by turning the equipment off and on, the user is encouraged to try to correct the interference by one or more of the following measures:

- Reorient or relocate the receiving antenna.
- Increase the separation between the equipment and receiver.
- Connect the equipment into an outlet on a circuit different from that to which the receiver is connected.
- Consult the dealer or an experienced radio/TV technician for help.

Caution: Any changes or modifications to this device not explicitly approved by manufacturer could void your authority to operate this equipment.

This device complies with part 15 of the FCC Rules. Operation is subject to the following two conditions: (1) This device may not cause harmful interference, and (2) this device must accept any interference received, including interference that may cause undesired operation.

This equipment complies with FCC radiation exposure limits set forth for an uncontrolled environment. This equipment should be installed and operated with minimum 20 cm between the radiator and your body. This transmitter must not be collocated or operating in conjunction with any other antenna or transmitter unless authorized to do so by the FCC.