

How vehicle audio works

FM reception

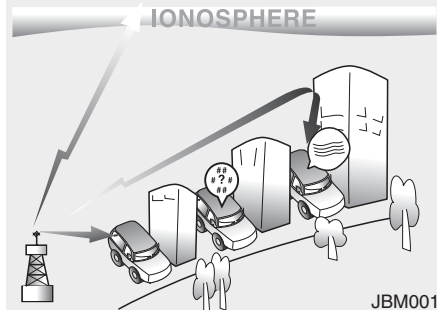

AM and FM radio signals are broadcast from transmitter towers located around your city. They are intercepted by the radio antenna on your vehicle. This signal is then received by the radio and sent to your vehicle speakers.

When a strong radio signal has reached your vehicle, the precise engineering of your audio system ensures the best possible quality reproduction. However, in some cases the signal coming to your vehicle may not be strong and clear.

This can be due to factors, such as the distance from the radio station, closeness of other strong radio stations or the presence of buildings, bridges or other large obstructions in the area.

AM reception

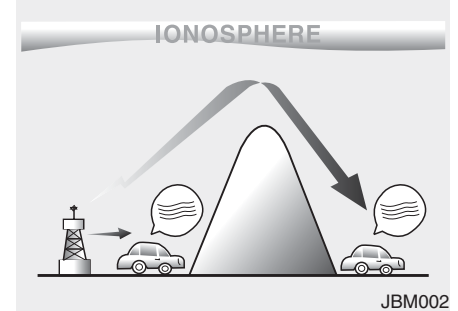

AM broadcasts can be received at greater distances than FM broadcasts. This is because AM radio waves are transmitted at low frequencies. These long, low frequency radio waves can follow the curvature of the earth rather than travelling straight out into the atmosphere. In addition, they curve around obstructions so that they can provide better signal coverage.

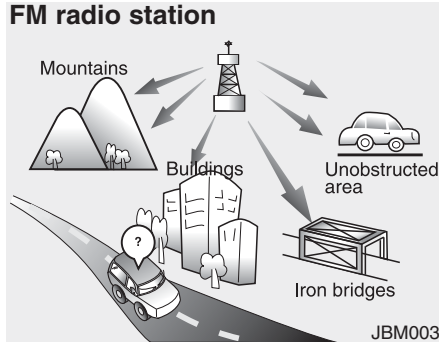

FM broadcasts are transmitted at high frequencies and do not bend to follow the earth's surface. Because of this, FM broadcasts generally begin to fade at short distances from the station. Also, FM signals are easily affected by buildings, mountains, or other obstructions. These can result in certain listening conditions which might lead you to believe a problem exists with your radio. The following conditions are normal and do not indicate radio trouble:

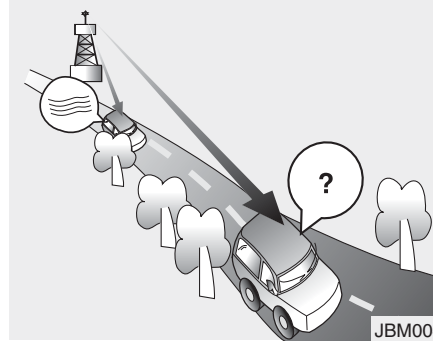

- **Fading** - As your vehicle moves away from the radio station, the signal will weaken and sound will begin to fade. When this occurs, we suggest that you select another stronger station.
- **Flutter/Static** - Weak FM signals or large obstructions between the transmitter and your radio can disturb the signal causing static or fluttering noises to occur. Reducing the treble level may lessen this effect until the disturbance clears.

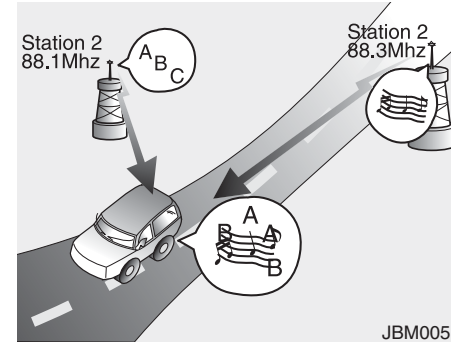

- **Station Swapping** - As a FM signal weakens, another more powerful signal near the same frequency may begin to play. This is because your radio is designed to lock onto the clearest signal. If this occurs, select another station with a stronger signal.
- **Multi-Path Cancellation** - Radio signals being received from several directions can cause distortion or fluttering. This can be caused by a direct and reflected signal from the same station, or by signals from two stations with close frequencies. If this occurs, select another station until the condition has passed.

Using a cellular phone or a two-way radio

When a cellular phone is used inside the vehicle, noise may be produced from the audio system. This does not mean that something is wrong with the audio equipment. In such a case, use the cellular phone at a place as far as possible from the audio equipment.

CAUTION

When using a communication system such as a cellular phone or a radio set inside the vehicle, a separate external antenna must be fitted. When a cellular phone or a radio set is used with an internal antenna alone, it may interfere with the vehicle's electrical system and adversely affect safe operation of the vehicle.

WARNING

Do not use a cellular phone while driving. Stop at a safe location to use a cellular phone.

⚠ WARNING

- *Do not stare at the screen while driving. Staring at the screen for prolonged periods of time could lead to traffic accidents.*
- *Do not disassemble, assemble, or modify the audio system. Such acts could result in accidents, fire, or electric shock.*
- *Using the phone while driving may lead to a lack of attention of traffic conditions and increase the likelihood of accidents. Use the phone feature after parking the vehicle.*
- *Heed caution not to spill water or introduce foreign objects into the device. Such acts could lead to smoke, fire, or product malfunction.*

(Continued)

(Continued)

- *Please refrain from use if the screen is blank or no sound can be heard as these signs may indicate product malfunction. Continued use in such conditions could lead to accidents(fires, electric shock) or product malfunctions.*
- *Do not touch the antenna during thunder or Lightning Such acts may cause electric shock by lightning.*
- *Do not stop or park in parking-restricted areas to operate the product. Such acts could lead to traffic accidents.*
- *Use the system with the vehicle ignition turned on. Prolonged use with the ignition turned off could result in battery discharge.*

⚠ CAUTION

- *Operating the device while driving could lead to accidents due to a lack of attention to external surroundings. park the vehicle before operating the device.*
- *Adjust the volume to levels that allow the driver to hear sounds from outside of the vehicle. Driving in a state where external sounds cannot be heard may lead to accidents.*
- *Pay attention to the volume setting when turning the device on. A sudden output of extreme volume upon turning the device on could lead to hearing impairment. (Adjust the volume to a suitable levels before turning off the device.)*

(Continued)

(Continued)

- ***If you want to change the position of device installation, please inquire with your place of purchase or service maintenance center. Technical expertise is required to install or disassemble the device.***
- ***Turn on the car ignition before using this device. Do not operate the audio system for long periods of time with the ignition turned off as such operations may lead to battery discharge.***
- ***Keep the device safe from severe shock or impact. Direct pressure onto the front side of the monitor may cause damage to the LCD or touch screen.***

(Continued)

(Continued)

- ***When cleaning the device, make sure to turn off the device and use a dry and smooth cloth. Never use tough materials, chemical cloths, or solvents (alcohol, benzene, thinners, etc.) as such materials may damage the device panel or cause color/quality deterioration***
- ***Do not place beverages close to the audio system. Spilling beverages may lead to system malfunction.***
- ***In case of product malfunction, please contact your place of purchase or After Service center.***
- ***Placing the audio system within an electromagnetic environment may result in noise interference.***

Caring for disc

- If the temperature inside the car is too high, open the car windows to ventilate before using the system.
- It is illegal to copy and use MP3/WMA files without permission. Use CDs that are created only by lawful means.
- Do not apply volatile agents, such as benzene and thinner, normal cleaners and magnetic sprays made for analogue disc onto CDs.
- To prevent the disc surface from getting damaged, hold CDs by the edges or the center hole only.
- Clean the disc surface with a piece of soft cloth before playback (wipe it from the center to the outside edge).
- Do not damage the disc surface or attach pieces of sticky tape or paper.
- Make certain only CDs are inserted into the CD player (Do not insert more than one CD at a time).
- Keep CDs in their cases after use to protect them from scratches or dirt.

- Depending on the type of CD-R/CD-RW CDs, certain CDs may not operate normally according to manufacturing companies or making and recording methods. In such circumstances, continued use may cause malfunctions to your audio system.

* NOTICE

- Playing an Incompatible Copy Protected Audio CD

Some copy protected CDs, which do not comply with international audio CD standards (Red Book), may not play on your car audio. Please note that inability to properly play a copy protected CD may indicate that the CD is defective, not the CD player.

NOTE:

Order of playing files (folders) :

1. Song playing order : ① to ⑭

2. Folder playing order :

* If no song file is contained in the folder, that folder is not displayed.

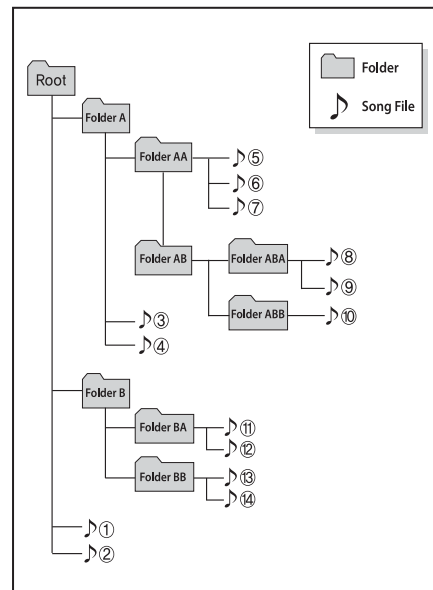
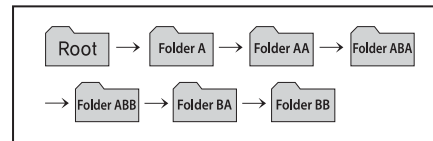

* NOTICE - USING THE USB DEVICE

- To use an external USB device, make sure the device is not connected when starting up the vehicle. Connect the device after starting up.
- If you start the engine when the USB device is connected, it may damage the USB device. (USB flashdrives are very sensitive to electric shock.)
- If the engine is started up or turned off while the external USB device is connected, the external USB device may not work.
- The System may not play inauthentic MP3 or WMA files.
 - 1) It can only play MP3 files with the compression rate between 8Kbps~320Kbps.
 - 2) It can only play WMA music files with the compression rate between 8Kbps~320Kbps.
- Take precautions for static electricity when connecting or disconnecting the external USB device.

(Continued)

- An encrypted MP3 PLAYER is not recognizable.
- Depending on the condition of the external USB device, the connected external USB device can be unrecognizable.
- When the formatted byte/sector setting of External USB device is not either 512BYTE or 2048BYTE, then the device will not be recognized.
- Use only a USB device formatted to FAT 12/16/32.
- USB devices without USB I/F authentication may not be recognizable.
- Make sure the USB connection terminal does not come in contact with the human body or other objects.
- If you repeatedly connect or disconnect the USB device in a short period of time, it may break the device.
- You may hear a strange noise when connecting or disconnecting a USB device.

(Continued)

(Continued)

- If you disconnect the external USB device during playback in USB mode, the external USB device can be damaged or may malfunction. Therefore, disconnect the external USB device when the audio is turned off or in another mode. (e.g, Radio, CD)
- Depending on the type and capacity of the external USB device or the type of the files stored in the device, there is a difference in the time taken for recognition of the device.
- Do not use the USB device for purposes other than playing music files.
- Playing videos through the USB is not supported.
- Use of USB accessories such as rechargers or heaters using USB I/F may lower performance or cause trouble.

(Continued)

(Continued)

- If you use devices such as a USB hub purchased separately, the vehicle's audio system may not recognize the USB device. In that case, connect the USB device directly to the multimedia terminal of the vehicle.
- If the USB device is divided by logical drives, only the music files on the highest-priority drive are recognized by car audio.
- Devices such as MP3 Player/ Cellular phone/Digital camera can be unrecognizable by standard USB I/F.
- Charging through the USB may not be supported in some mobile devices.
- USB HDD or USB types liable to connection failures due to vehicle vibrations are not supported. (i-stick type)
- Some non-standard USB devices (METAL COVER TYPE USB) can be unrecognizable.

(Continued)

(Continued)

- Some USB flash memory readers (such as CF, SD, micro SD, etc.) or external-HDD type devices can be unrecognizable.
- Music files protected by DRM (DIGITAL RIGHTS MANAGEMENT) are not recognizable.
- The data in the USB memory may be lost while using this audio. Always back up important data on a personal storage device.
- Please avoid using USB memory products which can be used as key chains or cellular phone accessories as they could cause damage to the USB jack. Please make certain only to use plug type connector products.



* NOTICE - USING THE iPod® DEVICE

- Some iPod models may not support communication protocol and files may not properly play. Supported iPod models:
 - iPhone 3GS/4
 - iPod touch 1st~4th generation
 - iPod nano 1st~6th generation
 - iPod classic
- The order of search or playback of songs in the iPod can be different from the order searched in the audio system.
- If the iPod disabled due to its own malfunction, reset the iPod. (Reset: Refer to iPod manual)
- An iPod may not operate normally on low battery.

(Continued)

(Continued)

- Some iPod devices, such as the iPhone, can be connected through the Bluetooth® Wireless Technology interface. The device must have audio Bluetooth® Wireless Technology capability (such as for stereo headphone Bluetooth® Wireless Technology). The device can play, but it will not be controlled by the audio system.
- To use iPod features within the audio, use the cable provided upon purchasing an iPod device.
- Skipping or improper operation may occur depending on the characteristics of your iPod/Phone device.
- If your iPhone is connected to both the Bluetooth® Wireless Technology and USB, the sound may not be properly played. In your iPhone, select the Dock connector or Bluetooth® Wireless Technology to change the sound output (source).

(Continued)

(Continued)

- When connecting iPod with the iPod Power Cable, insert the connector to the multimedia socket completely. If not inserted completely, communications between iPod and audio may be interrupted.
- When adjusting the sound effects of the iPod and the audio system, the sound effects of both devices will overlap and might reduce or distort the quality of the sound.
- Deactivate (turn off) the equalizer function of an iPod when adjusting the audio system's volume, and turn off the equalizer of the audio system when using the equalizer of an iPod.
- When not using iPod with car audio, detach the iPod cable from iPod. Otherwise, iPod may remain in accessory mode, and may not work properly.

■ CD Player (for RDS model) :



* No  Bluetooth logo will be shown if the *Bluetooth*® Wireless Technology feature is not supported.

SYSTEM CONTROLLERS AND FUNCTIONS

* Display and settings may differ depending on the selected audio.

Audio Head Unit (for RDS model)



(1)  (EJECT)
Ejects the disc.

(2)  **RADIO**



Changes to FM/AM mode.

Each time the key is pressed, the mode is changed in order of FM1 → FM2 → FMA → AM → AMA.

(3)  **MEDIA**

Changes to CD, USB(iPod), AUX, My Music, BT Audio mode.

Each time the key is pressed, the mode is changed in order of CD, USB(iPod), AUX, My Music, BT Audio.

* In Setup>Display, the media pop up screen will be displayed when [Mode Pop up] is turned On .
When the pop up screen is displayed, use the  TUNE knob or keys  ~  to select the desired mode.

(4)  (for *Bluetooth*[®] Wireless Technology equipped model)

Operates Phone Screen

* When a phone is not connected, the connection screen is displayed.

(5) PWR/VOL knob

 Power Knob: Turns power On/Off by pressing the knob

 Volume Knob: Sets volume by turning the knob left/right

(6) 

Radio Mode : Automatically searches for broadcast frequencies.

CD, USB, iPod, My Music modes.

- Shortly press the key (under 0.8 seconds): Moves to next or previous song (file)

- Press and hold the key (over 0.8 seconds): Rewinds or fast-forwards the current song.



(7)

Each time the button is shortly pressed (under 0.8 seconds), sets screen Off → Screen On → Screen Off

※ Audio operation is maintained and only the screen will be turned Off. In the screen Off state, press any key to turn the screen On again.

(8) **TA/SCAN**

Radio Mode

- Shortly press the key (under 0.8 seconds): TA On/Off
- Press and hold the key (over 0.8 seconds): Previews each broadcast for 5 seconds each

Media mode

- Press and hold the key (over 0.8 seconds): Previews each song (file) for 10 seconds each

※ Press and holding the key again to continue listening to the current song (file).

(9)

Moves to the Display, Sound, Phone and System setting mode.

(10) **MEMU**

Displays menus for the current mode.

(11)

FM : RDS Program Type Search

CD MP3, USB mode : Folder Search

(12)

Radio mode : Changes frequency by turning the knob left/right

CD, USB, iPod, My Music mode: Searches songs (files) by turning the knob left/right

※ When the desired song is displayed, press the knob to play the song.

Moves focus in all selection menus and selects menus

(13) **1 ~ 6** (Preset)



Radio Mode: Saves frequencies (channels) or receives saved frequencies (channels)

CD, USB, iPod, My Music mode

- **1 RPT** : Repeat

- **2 RDM** : Random

In the Radio, Media, Setup, and Menu pop up screen, the number menu is selected.

Audio Head Unit



(14) **FM**

Changes to FM mode.

Each time the key is pressed, the mode is changed in order of FM1 → FM2 → FMA.

(15) **AM**

Changes to AM mode.

Each time the key is pressed, the mode is changed in order of AM → AMA.

■ CD Player :



* No  Bluetooth logo will be shown if the *Bluetooth*® Wireless Technology feature is not supported.

SYSTEM CONTROLLERS AND FUNCTIONS

* Display and settings may differ depending on the selected audio.

Audio Head Unit



(1) **EJECT** (EJECT)

Ejects the disc.

(2) **RADIO**

Changes to FM/AM mode.

Each time the key is pressed, the mode is changed in order of FM1 → FM2 → AM.

(3) **MEDIA**

Changes to CD, USB(iPod), AUX, My Music, BT Audio mode.

Each time the key is pressed, the mode is changed in order of CD, USB(iPod), AUX, My Music, BT Audio.

* In Setup>Display, the media pop up screen will be displayed when [Mode Pop up] is turned **On**.

When the pop up screen is displayed, use the **TUNE** knob or keys **1** ~ **6** to select the desired mode.

(4) **PHONE** (for *Bluetooth*[®] Wireless Technology equipped model)

Operates Phone Screen

* When a phone is not connected, the connection screen is displayed.

(5) **PWR/VOL knob**

● Power Knob: Turns power On/Off by pressing the knob

● Volume Knob: Sets volume by turning the knob left/right

(6) **SEEK TRACK**

Radio Mode : Automatically searches for broadcast frequencies.

CD, USB, iPod, My Music modes.

- Shortly press the key (under 0.8 seconds): Moves to next or previous song (file)

- Press and hold the key (over 0.8 seconds): Rewinds or fast-forwards the current song.



(7) **DISP**

Each time the button is shortly pressed (under 0.8 seconds), sets screen Off → Screen On → Screen Off

* Audio operation is maintained and only the screen will be turned Off. In the screen Off state, press any key to turn the screen On again.

(8) **SCAN**

Radio Mode

Previews each broadcast for 5 seconds each

Media mode

Previews each song (file) for 10 seconds each

(9) **SETUP**

Moves to the Display, Sound, System setting modes

(10) **MEMU**

Displays menus for the current mode.

* iPod List : Move to parent category

(11) **∨ FOLDER ∨**

CD MP3, USB mode : Folder Search

(12) **TUNE knob**

Radio mode : Changes frequency by turning the knob left/right

CD, USB, iPod, My Music mode: Searches songs (files) by turning the knob left/right

* When the desired song is displayed, press the knob to play the song.

Moves focus in all selection menus and selects menus

(13) **1 ~ 6 (Preset)**



Radio Mode: Saves frequencies (channels) or receives saved frequencies (channels)

CD, USB, iPod, My Music mode

- **1 RPT** : Repeat

- **2 RDM** : Random

In the Radio, Media, Setup, and Menu pop up screen, the number menu is selected.

Audio Head Unit



(14) **FM**

Changes to FM mode.

Each time the key is pressed, the mode is changed in order of FM1 → FM2 → FMA.

(15) **AM**



Changes to AM mode.

Each time the key is pressed, the mode is changed in order of AM → AMA.

SETUP (for RDS model)

- AM101A7EE,AM111A7EE

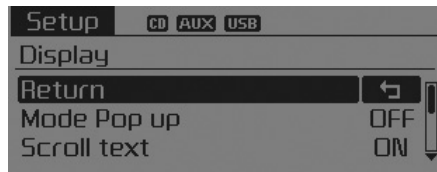

DISPLAY SETTINGS

Press the  key ▶ Select [Display] through  TUNE knob ▶ Select menu through  TUNE knob





Mode Pop up

[Mode Pop up] ▶ Changes  selection mode

- During On state, press the  or  key to display the mode change pop up screen.

Scroll text

[Scroll text] ▶ Set  / 



-  : Maintains scroll
-  : Scrolls only one (1) time.

Song Info

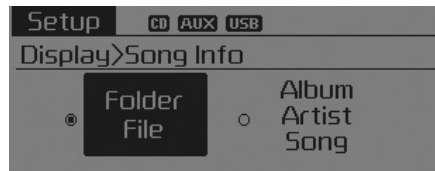
When playing an MP3 file, select the desired display info from 'Folder/File' or 'Album/Artist/Song'.



SOUND SETTINGS

Press the  key ▶ Select [Sound] through  TUNE knob ▶ Select menu through  TUNE knob

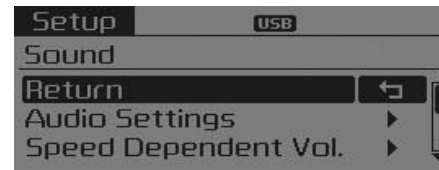

Audio Settings

This menu allows you to set the 'Bass, Middle, Treble' and the Sound Fader and Balance.

Select [Audio Settings] ▶ Select menu through **TUNE** knob ▶ Turn **TUNE** knob left/right to set

- Bass, Middle, Treble : Selects the sound tone.
- Fader, Balance : Moves the sound fader and balance.
- Default : Restores default settings.
- * Return : While adjusting values, re-pressing the **TUNE** knob will restore the parent menu.

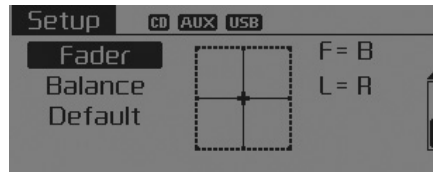
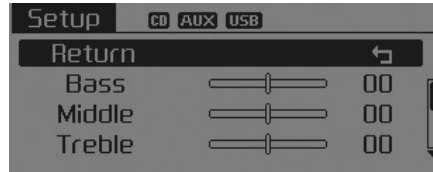

Speed Dependent Volume Control

This feature is used to automatically control the volume level according to the speed of the vehicle.

Select [Speed Dependent Vol.] ▶ Set in 4 levels [Off/Low/Mid/High] of **TUNE** knob

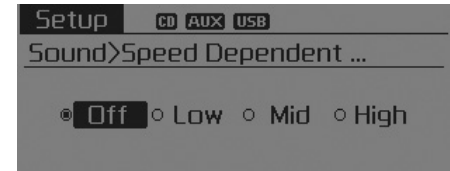



Volume Dialogue

Adjusts voice recognition volume.

Select [Volume Dialogue] ▶ Set volume of **TUNE** knob



PHONE SETUP (Bluetooth® Wireless Technology equipped model)

Press the  key ▶ Select [Phone]
through  TUNE knob ▶ Select menu
through  TUNE knob

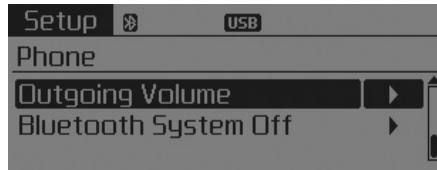
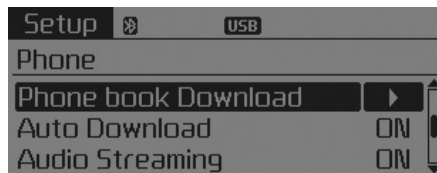
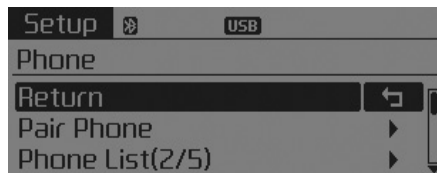

CAUTION

To pair a Bluetooth® Wireless Technology enabled mobile phone, authentication and connection processes are first required. As a result, you cannot pair your mobile phone while driving the vehicle. First park your vehicle before use.

Pair Phone

Select [Pair Phone] ▶ Set through
 TUNE knob

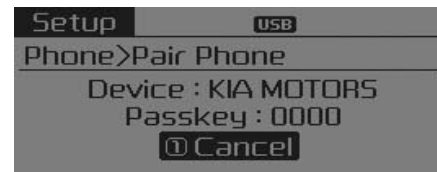

- ① Search for device names as displayed on your mobile phone and connect.
 - ② Input the passkey displayed on the screen. (Passkey : 0000)
- * The device name and passkey will be displayed on the screen for up to 3 minutes. If pairing is not completed within the 3 minutes, the mobile phone pairing process will automatically be canceled.

- ③ Pairing completion is displayed.
- * In some mobile phones, pairing will automatically be followed by connection.
 - * It is possible to pair up to five *Bluetooth®* Wireless Technology enabled mobile phones.

Phone List

The names of up to 5 paired phones will be displayed.



A [▶] is displayed in front of the currently connected phone.

Select the desired name to setup the selected phone.

Connecting a phone

Select [Phone List]▶Select mobile phone through TUNE knob▶
Select [Connect Phone]

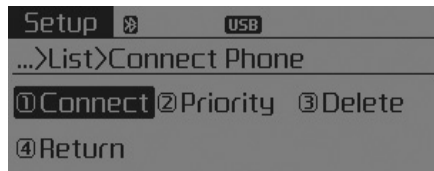

- ① Select a mobile phone that is not currently connected.
- ② Connect the selected mobile phone.
- ③ Connection completion is displayed.

* If a phone is already connected, disconnect the currently connected phone and select a new phone to connect.

Disconnecting a connected phone

Select [Phone List]▶Select mobile phone through TUNE knob▶
Select [Disconnect Phone]

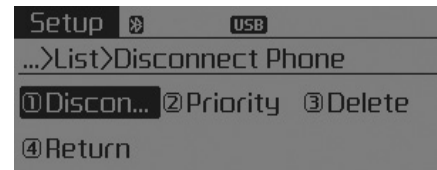

- ① Select the currently connected mobile phone.
- ② Disconnect the selected mobile phone.
- ③ Disconnection completion is displayed.

Changing connection sequence (Priority)

This is used to change the order (priority) of automatic connection for the paired mobile phones.

Select [Phone List]▶Select [Priority] through  TUNE knob▶Select No. 1 Priority mobile phone

- ① Select [Priority].
 - ② From the paired phones, select the phone desired for No.1 priority.
 - ③ The changed priority sequence is displayed.
- * Once the connection sequence (priority) is changed, the new no. 1 priority mobile phone will be connected.
- when the no. 1 priority cannot be connected: Automatically attempts to connect the most recently connected phone.
 - Cases when the most recently connected phone cannot be connected: Attempts to connect in the order in which paired phones are listed.

- The connected phone will automatically be changed to No. 1 priority.

Delete

Select [Phone List]▶Select mobile phone through  TUNE knob▶Select [Delete]

- ① Select the desired mobile phone.
 - ② Delete the selected mobile phone.
 - ③ Deletion completion is displayed.
- * When attempting to delete a currently connected phone, the phone is first disconnected.

CAUTION

- ***When you delete a mobile phone, the mobile phone phone book will also be erased.***
- ***For stable Bluetooth® Wireless Technology communication, delete the mobile phone from the audio and also delete the audio from your mobile phone.***

Phone book Download

This feature is used to download phone book and call histories into the audio system.

Select [Phone book Download]▶Select through  TUNE knob

CAUTION

- ***The download feature may not be supported in some mobile phones.***
- ***If a different operation is performed while phone book is being downloaded, downloading will be discontinued. Phone book already downloaded will be saved.***
- ***When downloading new phone book, delete all previously saved phone book before starting download.***

Auto Download

When connecting a mobile phone, it is possible to automatically download new phone book and Call Histories.

Select [Auto Download] ▶ Set  /  through 

Audio Streaming

Songs (files) saved in your *Bluetooth*[®] Wireless Technology enabled mobile phone can be played through the audio system.

Select [Audio Streaming] ▶ Set  /  through 

CAUTION

The *Bluetooth*[®] Wireless Technology audio streaming feature may not be supported in some mobile phones.

Outgoing Volume

This is used to set the volume of your voice as heard by the other party while on a *Bluetooth*[®] Wireless Technology enabled handsfree call.

Select [Outgoing Volume] ▶ Set volume through 

* Even while on a call, the volume can be changed by using the  key.

Bluetooth[®] Wireless Technology System Off

This feature is used when you do not wish to use the *Bluetooth*[®] Wireless Technology system.

Select [Bluetooth System Off] ▶ Set through 

* If a phone is already connected, disconnect the currently connected phone and turn the *Bluetooth*[®] Wireless Technology system off.

Using the *Bluetooth*[®] Wireless Technology System

To use *Bluetooth*[®] Wireless Technology when the system is currently off, follow these next steps.

- Turning On *Bluetooth*[®] Wireless Technology through the  Key
Press the  key ▶ Screen Guidance

* Moves to the screen where *Bluetooth*[®] Wireless Technology functions can be used and displays guidance.

- Turning On *Bluetooth*[®] Wireless Technology through the  Key

Press the  key ▶ Select [Phone]



- ① A screen asking whether to turn on *Bluetooth*[®] Wireless Technology will be displayed.
- ② On the screen, select to turn on *Bluetooth*[®] Wireless Technology and display guidance.

※ If the *Bluetooth*[®] Wireless Technology system is turned on, the system will automatically try to connect the most recently connected *Bluetooth*[®] Wireless Technology mobile phone.

CAUTION

- *Bluetooth*[®] Wireless Technology connection may become intermittently disconnected in some mobile phones. Follow these next steps to try again.
- 1) *Turn the Bluetooth*[®] *Wireless Technology* function within the mobile phone ON/OFF and try to connect again.
 - 2) *Turn the mobile phone power ON/OFF* and try to connect again.
 - 3) *Completely remove the mobile phone battery, reboot, and then try to connect again.*
 - 4) *Reboot the audio system and try to connect again*
 - 5) *Delete all paired devices in your mobile phone and the audio system and pair again for use.*

SYSTEM SETTINGS

Press the  key ▶ Select [System] through  TUNE knob ▶ Select menu through  TUNE knob



Memory Information (if equipped)

Displays currently used memory and total system memory.

Select [Memory Information] ▶ OK

The currently used memory is displayed on the left side while the total system memory is displayed on the right side.



VRS Mode

This feature is used to change voice command feedback between Normal and Expert modes.

Select [VRS Mode] ▶ Set through  TUNE knob

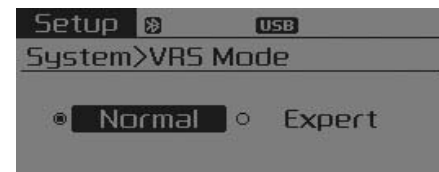

- Normal : This mode is for beginner users and provides detailed instructions during voice command operation.
- Expert : This mode is for expert users and omits some information during voice command operation. (When using Expert mode, guidance instructions can be heard through the [Help] or [Menu] commands.

* May differ depending on the selected audio.

Language

This menu is used to set the display and voice recognition language.

Select [Language] ▶ Set through
⊙ TUNE knob



- * The system will reboot after the language is changed.
- * Language support by region
 - Deutsch, English(UK), Français, Italiano, Español, Nederlands, Svenska, Dansk, Русский, Polski

SETUP

- AM101A7GG, AM111A7GG
 AM101A7GE, AM111A7GE
 AM101A7GN, AM111A7GN
 AM101A7GL, AM111A7GL

DISPLAY SETTINGS

Press the **SETUP** key ▶ Select [Display] through **TUNE** knob ▶ Select menu through **TUNE** knob

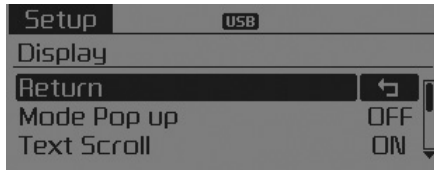

Mode Pop up

[Mode Pop up] ▶ Changes On.

- During On state, press the **RADIO** or **MEDIA** key to display the mode change pop up screen.

Text Scroll

[Text Scroll] ▶ Set On / Off

- On : Maintains scroll
- Off : Scrolls only one (1) time.

Media Display

When playing an MP3 file, select the desired display info from 'Folder/File' or 'Album/Artist/Song'.



SOUND SETTINGS

Press the **SETUP** key ▶ Select [Sound] through **TUNE** knob ▶ Select menu through **TUNE** knob

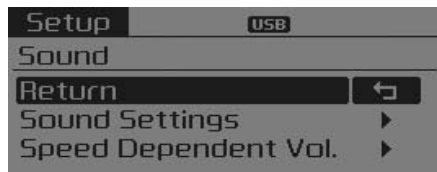

Sound Settings

This menu allows you to set the 'Bass, Middle, Treble' and the Sound Fader and Balance.

Select [Sound Settings] ▶ Select menu through **TUNE** knob ▶ Turn **TUNE** knob left/right to set

- Bass, Middle, Treble : Selects the sound tone.
- Fader, Balance : Moves the sound fader and balance.
- Default : Restores default settings.
- * Return : While adjusting values, re-pressing the **TUNE** knob will restore the parent menu.

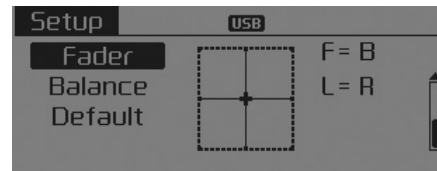
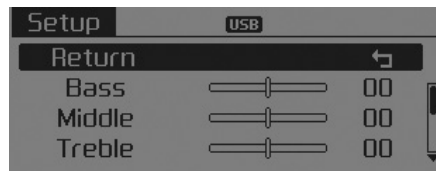

Speed Dependent Volume Control

This feature is used to automatically control the volume level according to the speed of the vehicle.

Select [Speed Dependent Vol.] ▶ Set in 4 levels [Off/Low/Mid/High] of **TUNE** knob

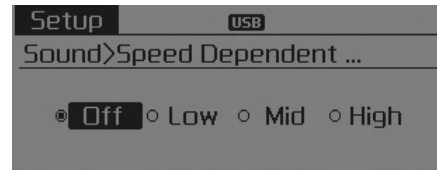

PHONE SETUP (for Bluetooth® Wireless Technology equipped model)

Press the **SETUP** key ▶ Select [Phone]
through **TUNE** knob ▶ Select menu
through **TUNE** knob

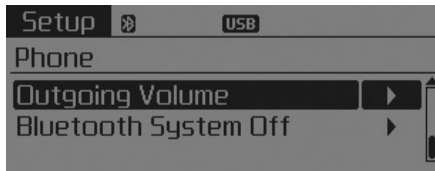
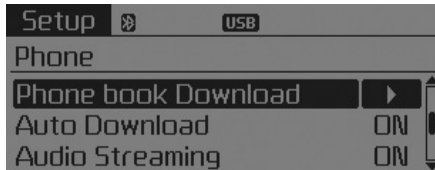
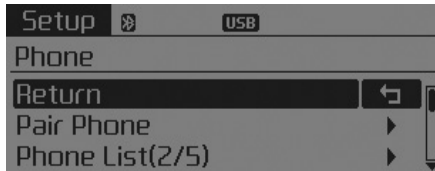

⚠ CAUTION

To pair a Bluetooth® Wireless Technology enabled mobile phone, authentication and connection processes are first required. As a result, you cannot pair your mobile phone while driving the vehicle. First park your vehicle before use.

Pair Phone

Select [Pair Phone] ▶ Set through
TUNE knob



- ① Search for device names as displayed on your mobile phone and connect.
- ② Input the passkey displayed on the screen. (Passkey : 0000)

- * The device name and passkey will be displayed on the screen for up to 3 minutes. If pairing is not completed within the 3 minutes, the mobile phone pairing process will automatically be canceled.
- ③ Pairing completion is displayed.
- * In some mobile phones, pairing will automatically be followed by connection.
- * It is possible to pair up to five Bluetooth® Wireless Technology enabled mobile phones.

Phone List

The names of up to 5 paired phones will be displayed.

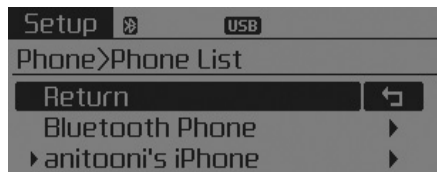

A [▶] is displayed in front of the currently connected phone.

Select the desired name to setup the selected phone.

Connecting a phone

Select [Phone List]▶Select mobile phone through TUNE knob▶Select [Connect Phone]



- ① Select a mobile phone that is not currently connected.
 - ② Connect the selected mobile phone.
 - ③ Connection completion is displayed.
- ※ If a phone is already connected, disconnect the currently connected phone and select a new phone to connect.

Disconnecting a connected phone

Select [Phone List]▶Select mobile phone through TUNE knob▶Select [Disconnect Phone]

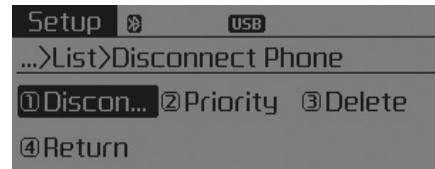

- ① Select the currently connected mobile phone.
- ② Disconnect the selected mobile phone.
- ③ Disconnection completion is displayed.

Changing connection sequence (Priority)

This is used to change the order (priority) of automatic connection for the paired mobile phones.

Select [Phone List]▶Select [Priority] through TUNE knob▶Select No. 1 Priority mobile phone

- ① Select [Priority].
 - ② From the paired phones, select the phone desired for No.1 priority.
 - ③ The changed priority sequence is displayed.
- ✳ Once the connection sequence (priority) is changed, the new no. 1 priority mobile phone will be connected.
- when the no. 1 priority cannot be connected: Automatically attempts to connect the most recently connected phone.
 - Cases when the most recently connected phone cannot be connected: Attempts to connect in the order in which paired phones are listed.
 - The connected phone will automatically be changed to No. 1 priority.

Delete

Select [Phone List]▶Select mobile phone through  TUNE knob▶Select [Delete]

- ① Select the desired mobile phone.
 - ② Delete the selected mobile phone.
 - ③ Deletion completion is displayed.
- ✳ When attempting to delete a currently connected phone, the phone is first disconnected.

CAUTION

- *When you delete a mobile phone, the mobile phone contacts will also be erased.*
- *For stable Bluetooth® Wireless Technology communication, delete the mobile phone from the audio and also delete the audio from your mobile phone.*

Contacts Download

This feature is used to download contacts and call histories into the audio system.

Select [Contacts Download]▶Select through  TUNE knob

CAUTION

- *The download feature may not be supported in some mobile phones.*
- *If a different operation is performed while Contacts are being downloaded, downloading will be discontinued. Contacts already downloaded will be saved.*
- *When downloading new Contacts, delete all previously saved Contacts before starting download.*

Auto Download

When connecting a mobile phone, it is possible to automatically download new Contacts and Call Histories.

Select [Auto Download] ▶ Set ON / OFF through 

Audio Streaming

Songs (files) saved in your *Bluetooth*[®] Wireless Technology enabled mobile phone can be played through the audio system.

Select [Audio Streaming] ▶ Set ON / OFF through 

CAUTION

*The **Bluetooth**[®] Wireless Technology audio streaming feature may not be supported in some mobile phones.*

Outgoing Volume

This is used to set the volume of your voice as heard by the other party while on a *Bluetooth*[®] Wireless Technology enabled handsfree call.

Select [Outgoing Volume] ▶ Set volume through 

* Even while on a call, the volume can be changed by using the  key.

Bluetooth[®] Wireless Technology System Off

This feature is used when you do not wish to use the *Bluetooth*[®] Wireless Technology system.

Select [Bluetooth System Off] ▶ Set through 

* If a phone is already connected, disconnect the currently connected phone and turn the *Bluetooth*[®] Wireless Technology system off.

Using the *Bluetooth*[®] Wireless Technology System

To use *Bluetooth*[®] Wireless Technology when the system is currently off, follow these next steps.

- Turning On *Bluetooth*[®] Wireless Technology through the **PHONE** Key
Press the **PHONE** key ▶ Screen Guidance

* Moves to the screen where *Bluetooth*[®] Wireless Technology functions can be used and displays guidance.

- Turning On *Bluetooth*[®] Wireless Technology through the **SETUP** Key
Press the **SETUP** key ▶ Select [Phone]
- ① A screen asking whether to turn on *Bluetooth*[®] Wireless Technology will be displayed.
- ② On the screen, select **YES** to turn on *Bluetooth*[®] Wireless Technology and display guidance.
- * If the *Bluetooth*[®] Wireless Technology system is turned on, the system will automatically try to connect the most recently connected *Bluetooth*[®] Wireless Technology mobile phone.

 **CAUTION**

- *Bluetooth*[®] Wireless Technology connection may become intermittently disconnected in some mobile phones. Follow these next steps to try again.
- 1) Turn the *Bluetooth*[®] Wireless Technology function within the mobile phone ON/OFF and try to connect again.
 - 2) Turn the mobile phone power ON/OFF and try to connect again.
 - 3) Completely remove the mobile phone battery, reboot, and then try to connect again.
 - 4) Reboot the audio system and try to connect again
 - 5) Delete all paired devices in your mobile phone and the audio system and pair again for use.

SYSTEM SETTINGS

Press the **SETUP** key ▶ Select [System] through **TUNE knob** ▶ Select menu through **TUNE knob**



Memory Information (if equipped)

Displays currently used memory and total system memory.

Select [Memory Information] ▶ OK

The currently used memory is displayed on the left side while the total system memory is displayed on the right side.

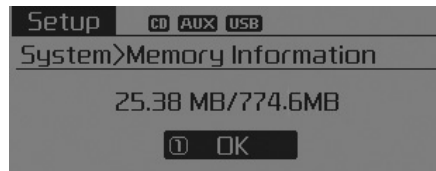

Language

Select [Language] ▶ Set through **TUNE knob**



* The system will reboot after the language is changed.

* Language support by region
- 한국어, English

RADIO (for RDS model)

Changing RADIO mode





SEEK

Press the  key

- Shortly pressing the key (under 0.8 seconds): Changes the frequency.
- Pressing and holding the key (over 0.8 seconds): Automatically searches for the next frequency.

Preset SEEK

Press the  ~  key

- Shortly pressing the key (under 0.8 seconds): Plays the frequency saved in the corresponding key.
- Pressing and holding the key (over 0.8 seconds): Pressing and holding the desired key from  ~  will save the currently playing broadcast to the selected key and sound a BEEP.

SCAN

Press the  key



- Pressing and holding the key (over 0.8 seconds): The broadcast frequency increases and previews each broadcast for 5 seconds each. After scanning all frequencies, returns and plays the current broadcast frequency.

Selecting through manual search

Turn the  TUNE knob left/right to adjust the frequency.

- AM101A7EE, AM111A7EE
 - FM : Changes by 50KHz
 - AM : Changes by 9kHz

Traffic Announcement (TA)

Shortly pressing the  key (under 0.8 seconds): Set  (On/Off TA Traffic Announcement) mode.

PTY Up/Down

- Press the  key when searching PTY in RDS Broadcasting Program Type selection.

MENU

Within  key are the **AST**(Auto Store) and Info functions.

AST (Auto Store)

Press the **MENU** key ▶ Set [**1** AST] through **TUNE** knob or **1 RPT** key.



Select AST (Auto Store) to save frequencies with superior reception to presets **1** ~ **6**. If no frequencies are received, then the most recently received frequency will be broadcast.

* Saves only to the Preset memory **1** ~ **6** of FMA or AMA mode.

AF (Alternative Frequency)

Press the **MENU** key ▶ Set [**2** AF] through **TUNE** knob or **2 RDM** key.

The Alternative Frequency option can be turned On/Off.

Region

Press the **MENU** key ▶ Set [**3** Region] through **TUNE** knob or **3** key.

The Region option can be turned On/Off.

News

Press the **MENU** key ▶ Set [**4** News] through **TUNE** knob or **4** key.

The News option can be turned On/Off.

Info Volume

Info Volume refers to the sound volume upon receiving News or Traffic information.

The info volume can be controlled by turning the **VOL** knob left/right while a news or traffic broadcast is playing.

* AF, Region, and News are RDS Radio menus.

RADIO

Changing RADIO mode

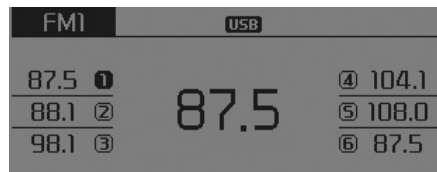





SEEK

Press the  key

- Shortly pressing the key (under 0.8 seconds): Changes the frequency.
- Pressing and holding the key (over 0.8 seconds): Automatically searches for the next frequency.



Preset SEEK

Press the  ~  key

- Shortly pressing the key (under 0.8 seconds): Plays the frequency saved in the corresponding key.
- Pressing and holding the key (over 0.8 seconds): Pressing and holding the desired key from  ~  will save the currently playing broadcast to the selected key and sound a BEEP.

SCAN

Press the  key

- Shortly pressing the key (under 0.8 seconds): The broadcast frequency increases and previews each broadcast for 5 seconds each. After scanning all frequencies, returns and plays the current broadcast frequency.
- Pressing and holding the key (over 0.8 seconds): Previews the broadcasts saved in Preset  ~  for 5 seconds each.

Selecting through manual search

Turn the  TUNE knob left/right to adjust the frequency.

- AM101A7GE / AM111A7GE

- FM : Changes by 50KHz
- AM : Changes by 9kHz

- AM101A7GG / AM111A7GG

- FM : Changes by 100KHz
- AM : Changes by 9kHz

- AM101A7GN / AM111A7GN

- FM : Changes by 200KHz
- AM : Changes by 10kHz

- AM101A7GL / AM111A7GL

- FM : Changes by 100KHz
- AM : Changes by 10kHz

MENU

Within **MENU** key are the A.Store (Auto Store) and Info functions.

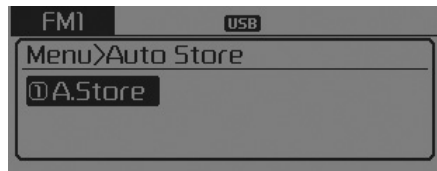

A.Store (Auto Store)

Press the **MENU** key ▶ Set [**① A.Store**] through **TUNE** knob or **1 RPT** key.

Select A.Store(Auto Store) to save frequencies with superior reception to presets **1** ~ **6**. If no frequencies are received, then the most recently received frequency will be broadcast.

BASIC METHOD OF USE : AUDIO CD / MP3 CD / USB / IPOD / MY MUSIC

Press the **MEDIA** key to change the mod mode in order of CD → USB(iPod) → AUX → My Music → BT Audio.

The folder/file name is displayed on the screen.



<Audio CD>



<CD MP3>

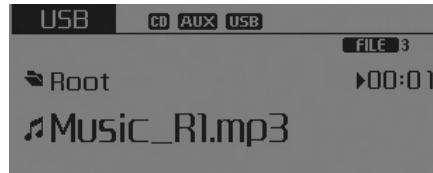

<USB>

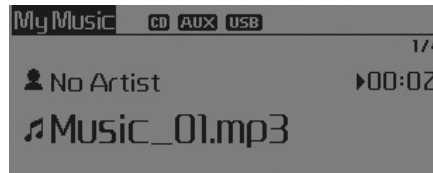

<My Music>

- * The CD is automatically played when a CD is inserted.
- * The USB music is automatically played when a USB is connected.

Repeat

While song (file) is playing ▶ **1 RPT** (RPT) key

Audio CD, MP3 CD, USB, iPod, My Music mode: RPT on screen

- To repeat one song (Shortly pressing the key (under 0.8 seconds)): Repeats the current song.

MP3 CD, USB mode: FLD.RPT on screen

- To repeat folder (pressing twice): repeats all files within the current folder.

* Press the **1 RPT** key again to turn off repeat.

Random

While song (file) is playing ▶  (RDM) key

Audio CD, My Music mode: RDM on screen

- Random (Shortly pressing the key) : Plays all songs in random order.

MP3 CD, USB mode: FLD.RDM on screen

- Folder Random (Shortly pressing the key) : Plays all files within the current folder in random order.

iPod mode: ALB RDM on screen

- Album Random (Shortly pressing the key) : Plays all files within albums of the current category in random order.

MP3 CD, USB, iPod mode: ALL RDM on screen

- All Random (pressing twice): Plays all files in random order.
- ※ Press the  key again to turn off **random**.

Changing Song/File

- Shortly pressing the key : Plays the current song from the beginning.

※ If the  key is pressed again within 1 second, the previous song is played.

- Pressing and holding the key (over 0.8 seconds): Rewinds the song.

While song (file) is playing ▶  key

- Shortly pressing the key : Plays the next song.

• **Pressing and holding the key (over 0.8 seconds): Fast forwards the song.**

Scan (for RDS model)

- Pressing and holding the  key (over 0.8 seconds) : Scans all songs for 10 seconds starting from the next song.

※ Pressing and holding the  key again to turn off.

Scan

- Shortly pressing the the  key : Scans all songs from the next song for 10 seconds each.

※ Press the  key again to turn off.

※ The SCAN function is not supported in iPod mode.

Folder Search : MP3 CD, USB Mode

While file is playing ▶ **PTY FOLDER** ^ / **FOLDER** ^ (Folder Up) key

- Searches the next folder.

While file is playing ▶ **PTY FOLDER** v / **FOLDER** v (Folder Down) key

- Searches the parent folder.

* If a folder is selected by pressing the **TUNE** knob, the first file within the selected folder will be played.

* In iPod mode, moves to the Parent Folder.

Searching Songs (File)

- Turning **TUNE** knob : Searches for songs (files)
- Pressing **TUNE** knob : Plays selected song (file).

MENU : Audio CD

Press the CD MP3 mode **MENU** key to set the Repeat, Random, Information features.



Repeat

Press the **MENU** key ▶ Set [**1 RPT**] through the **TUNE** knob or **1 RPT** key to repeat the current song.

* Press RPT again to turn off.

Random

Press the **MENU** key ▶ Set [**2 RDM**] through the **TUNE** knob or **2 RDM** key to randomly play songs within the current folder.

* Press RDM again to turn off.

Information

Press the **MENU** key ▶ Set [**3 Info**] through the **TUNE** knob or **3** key to display information of the current song.

* Press the **MENU** key to turn off info display.

MENU : MP3 CD / USB

Press the CD MP3 mode **MENU** key to set the Repeat, Folder Random, Folder Repeat, All Random, Information, and Copy features.



Repeat

Press the **MENU** key ▶ Set [**1 RPT**] through the **TUNE** knob or **1 RPT** key to repeat the current song.

* Press RPT again to turn off.

Folder Random

Press the **MENU** key ▶ Set [**2**F.RDM] through the **TUNE** knob or **2 RDM** key to randomly play songs within the current folder.

* Press F.RDM again to turn off.

Folder Repeat

Press the **MENU** key ▶ Set [**3**F.RPT] through the **TUNE** knob or **3** key to repeat songs within the current folder.

* Press F.RPT again to turn off.

All Random

Press the **MENU** key ▶ Set [**4**A.RDM] through the **TUNE** knob or **4** key to randomly play all songs within the CD.

* Press A.RDM again to turn off.

Information

Press the **MENU** key ▶ Set [**5**Info] through the **TUNE** knob or **5** key to display information of the current song.

* Press the **MENU** key to turn off info display.

Copy (if equipped)

Press the **MENU** key ▶ Set [**6**Copy] through the **TUNE** knob or **6** key.

This is used to copy the current song into My Music. You can play the copied Music in My Music mode.

* If another key is pressed while copying is in progress, a pop up asking you whether to cancel copying is displayed.

* If another media is connected or inserted (USB, CD, iPod, AUX) while copying is in progress, copying is canceled.

* Music will not be played while copying is in progress.

MENU : iPod

In iPod mode, press the **MENU** key to set the Repeat, Album Random, All Random, Information and Search features.

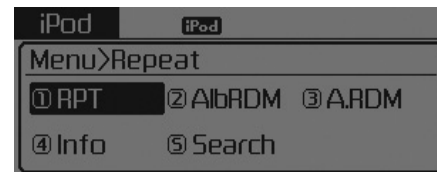

Repeat

Press the **MENU** key ▶ Set [**1**RPT] through the **TUNE** knob or **1 RPT** key to repeat the current song.

* Press RPT again to turn repeat off.

Album Random

Press the **MENU** key ▶ Set [**2**Alb.RDM] through the **TUNE** knob or **2 RDM** key.

Plays albums within the currently playing category in random order.

* Press Alb.RDM again to turn off.

All Random

Press the **MENU** key ▶ Set [**3**A.RDM] through the **TUNE** knob or **3** key.

Plays all songs within the currently playing category in random order.

* Press A.RDM again to turn off.

Information

Press the **MENU** key ▶ Set [**4**Info] through the **TUNE** knob or **4** key.

Displays information of the current song.

* Press the **MENU** key to turn off info display.

Search

Press the **MENU** key ▶ Set [**5**Search] through the **TUNE** knob or **5** key.

Displays iPod category list.

* Searching iPod category is **MENU** key pressed, move to parent category.

MENU : My Music Mode

(if equipped)

In My Music mode, press the **MENU** key to set the Repeat, Random, Information, Delete, Delete All, and Delete Selection features.



Repeat

Press the **MENU** key ▶ Set [**1**RPT] through the **TUNE** knob or **1 RPT** key.

Repeats the currently playing song.

* Press RPT again to turn repeat off.

Random

Press the **MENU** key ▶ Set [**2**RDM] through the **TUNE** knob or **2** **RDM** key.

Plays all songs in random order.

* Press RDM again to turn random off.

Information

Press the **MENU** key ▶ Set [**3**Info] through the **TUNE** knob or **3** key.

Displays information of the current song.

* Press the **MENU** key to turn off info display.

Delete

Press the **MENU** key ▶ Set [**4**Delete] through the **TUNE** knob or **4** key.

Deletes currently playing file

In the play screen, pressing delete will delete the currently playing song.

Deletes file from list



- ① Select the file you wish to delete by using the **TUNE** knob.
- ② Press the **MENU** key and select the delete menu to delete the selected file.

Delete All

Press the **MENU** key ▶ Set [**5**Del.All] through the **TUNE** knob or **5** key.

Deletes all songs of My Music.

Delete Selection

Press the **MENU** key ▶ Set [**6**Del.Sel] through the **TUNE** knob or **6** key.

Songs within My Music are selected and deleted.

- ① Select the songs you wish to delete from the list.

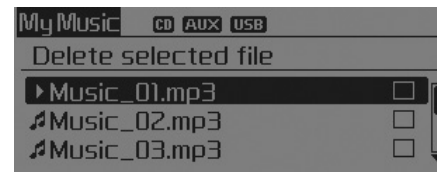

- ② After selecting, press the **MENU** key and select the delete menu.



* NOTICE - USING THE My Music

- Even if memory is available, a maximum of 6,000 songs can be stored.
- The same song can be copied up to 1,000 times.
- Memory info can be checked in the System menu of Setup.

AUX

AUX is used to play external MEDIA currently connected with the AUX terminal.

AUX mode will automatically start when an external device is connected with the AUX terminal.

If an external device is connected, you can also press the **MEDIA** key to change to AUX mode.



- * AUX mode cannot be started unless there is an external device connected to the AUX terminal.

* NOTICE - USING THE AUX

- Fully insert the AUX cable into the AUX terminal for use.

BLUETOOTH® WIRELESS TECHNOLOGY AUDIO (if equipped)

What is Bluetooth® Wireless Technology?

Bluetooth® Wireless Technology is a wireless technology that allows multiple devices to be connected in a short range, low-powered devices like hands-free, stereo headset, wireless remote controller, etc. For more information, visit the *Bluetooth®* Wireless Technology website at www.Bluetooth.com

Before using *Bluetooth®* Wireless Technology audio features

- *Bluetooth®* Wireless Technology audio may not be supported depending on the compatibility of your *Bluetooth®* Wireless Technology mobile phone.
 - In order to use *Bluetooth®* Wireless Technology audio, you must first pair and connect the *Bluetooth®* Wireless Technology mobile phone.
 - *Bluetooth®* Wireless Technology audio can be used only when the [Audio Streaming] of Phone is turned On.
- * Setting *Bluetooth®* Wireless Technology Audio Streaming : Press the **SETUP** key ▶ Select [Phone] through the  TUNE knob ▶ Select [Audio Streaming] through the  TUNE knob ▶ Set **ON**/**OFF**

Starting Bluetooth® Wireless Technology Audio

- Press the **MEDIA** key to change the mode in order of CD → USB → AUX → My Music → BT Audio.
 - If BT Audio is selected, *Bluetooth®* Wireless Technology audio will start playing.
- * Audio may not automatically start playing in some mobile phones.

Using the Bluetooth® Wireless Technology audio features

- Play / Pause

Press the  TUNE knob to play and pause the current song.



- * The previous song / next song / play / pause functions may not be supported in some mobile phones.



PHONE (if equipped)



Before using the *Bluetooth*® Wireless Technology phone features

- In order to use *Bluetooth*® Wireless Technology phone, you must first pair and connect the *Bluetooth*® Wireless Technology mobile phone.
- If the mobile phone is not paired or connected, it is not possible to enter Phone mode. Once a phone is paired or connected, the guidance screen will be displayed.
- If Priority is set upon vehicle ignition (IGN/ ACC ON), the *Bluetooth*® Wireless Technology phone will be automatically connected. Even if you are outside, the *Bluetooth*® Wireless Technology phone will be automatically connected once you are in the vicinity of the vehicle. If you do not want automatic *Bluetooth*® Wireless Technology phone connection, set the *Bluetooth*® Wireless Technology power to OFF.

Making a call using the Steering remote controller



- (1) MUTE button : Mute the microphone during a call.
- (2) VOLUME button : Raises or lowers speaker volume.
- (3)  button : Activates voice recognition.
- (4)  button : Places and transfers calls.
- (5)  button : Ends calls or cancels functions.

- Check call history and making call
 - ① Shortly press (under 0.8 seconds) the  key on the steering remote controller.
 - ② The call history list will be displayed on the screen.
 - ③ Press the  key again to connect a call to the selected number.
- Redialing the most recently called number
 - ① Press and hold (over 0.8 seconds) the  key on the steering remote controller.
 - ② The most recently called number is redialed.

Phone MENU (for RDS model)

Press the  key to display three menus (Call History, Phone Book, Phone Setup).

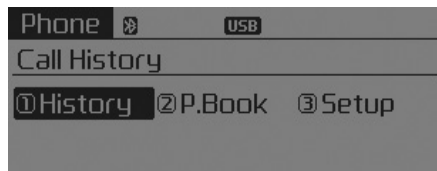

Call history

Press the  key ▶ Set [1 History] through the  TUNE knob or  key.

The call history is displayed and can be used to select a number and make a call.

If call history does not exist, a screen asking whether to download call history is displayed. (The download feature may not be supported in some mobile phones)

Phone Book

Press the  key ▶ Set [2 P. Book] through the  TUNE knob or  key.

The phone book is displayed and can be used to select a number and make a call.

- * If more than one number is saved to one contact, then a screen showing the mobile phone number, Home and office number is displayed. Select the desired number to make the call.
- * If phone book do not exist, a screen asking whether to download phone book is displayed. (The download feature may not be supported in some mobile phones)

Phone Setup

Press the  key ▶ Set [3 Setup] through the  TUNE knob or  key.

The *Bluetooth*[®] Wireless Technology mobile phone setup screen is displayed. For more information, refer to "Phone Setup".

Phone MENU

Press the **PHONE** key to display three menus (Call History, Contacts, Phone Setup).



Call history

Press the **PHONE** key ▶ Set [1 History] through the **TUNE** knob or **1 RPT** key.

The call history is displayed and can be used to select a number and make a call.

If call history does not exist, a screen asking whether to download call history is displayed. (The download feature may not be supported in some mobile phones)

Contacts

Press the **PHONE** key ▶ Set [2 Contacts] through the **TUNE** knob or **2 RDM** key.

The Contacts are displayed and can be used to select a number and make a call.

- * If more than one number is saved to one contact, then a screen showing the mobile phone number, Home and office number is displayed. Select the desired number to make the call.
- * If Contacts do not exist, a screen asking whether to download Contacts is displayed. (The download feature may not be supported in some mobile phones)

Phone Setup

Press the **PHONE** key ▶ Set [3 Setup] through the **TUNE** knob or **3** key.

The *Bluetooth*® Wireless Technology mobile phone setup screen is displayed. For more information, refer to "Phone Setup".

*** NOTICE - USING THE
Bluetooth[®] Wireless
Technology CELLULAR
PHONE**

- Do not use a cellular phone or perform *Bluetooth*[®] Wireless Technology settings (e.g. pairing a phone) while driving.
- Some *Bluetooth*[®] Wireless Technology -enabled phones may not be recognized by the system or fully compatible with the system.
- Before using *Bluetooth*[®] Wireless Technology related features of the audio system, refer your phone's User's Manual for phone-side *Bluetooth*[®] Wireless Technology operations.
- The phone must be paired to the audio system to use *Bluetooth*[®] Wireless Technology related features.
- You will not be able to use the hands-free feature when your phone (in the car) is outside of the cellular service area (e.g. in a tunnel, in a underground, in a mountainous area, etc.).

(Continued)

(Continued)

- If the cellular phone signal is poor or the vehicles interior noise is too loud, it may be difficult to hear the other person's voice during a call.
- Do not place the phone near or inside metallic objects, otherwise communications with *Bluetooth*[®] Wireless Technology system or cellular service stations can be disturbed.
- While a phone is connected through *Bluetooth*[®] Wireless Technology your phone may discharge quicker than usual for additional *Bluetooth*[®] Wireless Technology-related operations.
- Some cellular phones or other devices may cause interference noise or malfunction to audio system. In this case, store the device in a different location may resolve the condition.
- Phone contact names should be saved in English or they may not be displayed correctly.

(Continued)

(Continued)

- If Priority is set upon vehicle ignition(IGN/ACC ON), the *Bluetooth*[®] Wireless Technology phone will be automatically connected.

Even if you are outside, the *Bluetooth*[®] Wireless Technology phone will be automatically connected once you are in the vicinity of the vehicle.

If you do not want automatic *Bluetooth*[®] Wireless Technology connection, turn the *Bluetooth*[®] Wireless Technology feature off.

- The hands-free call volume and quality may differ depending on the mobile phone type.
- *Bluetooth*[®] Wireless Technology features can be used only when the mobile phone has been paired and connected with the device. For more information on pairing and connecting *Bluetooth*[®] Wireless Technology enabled mobile phones, refer to the "Phone Setup" section.

(Continued)

(Continued)

- When a *Bluetooth*® Wireless Technology mobile phone is connected, a (📶) icon will appear at the top of the screen. If a (📶) icon is not displayed, this indicates that a *Bluetooth*® Wireless Technology enabled device has not been connected. You must connect the device before use. For more information on *Bluetooth*® Wireless Technology mobile phones, refer to the “Phone Setup” section.
- Pairing and connecting a *Bluetooth*® Wireless Technology enabled mobile phone will work only when the *Bluetooth*® Wireless Technology option within your mobile phone has been turned on. (Methods of turning on the *Bluetooth*® Wireless Technology enabled feature may differ depending on the mobile phone.)

(Continued)

(Continued)

- In some mobile phones, starting the ignition while talking through *Bluetooth*® Wireless Technology enabled handsfree call will result in the call becoming disconnected. (Switch the call back to your mobile phone when starting the ignition.)
- Some features may not be supported in some *Bluetooth*® Wireless Technology mobile phone and devices.
- *Bluetooth*® Wireless Technology enabled operation may be unstable depending on the communication state.
- Placing the audio system within an electromagnetic environment may result in noise interference.

*** NOTICE - USING VOICE COMMAND**

- The voice recognition feature of this product supports recognition of the commands listed within this user's manual.
- While using voice recognition, operating the steering remote control or the device will terminate voice recognition and allow you to manually operate desired functions.
- Position the microphone above the head of the driver's seat. For superior performance, maintain good posture when saying voice commands.

(Continued)

(Continued)

- Voice recognition may not function properly due to outside noise. The following conditions can affect the performance of Voice Recognition:
 - When the windows and sunroof are open
 - When the heating/cooling system is on
 - When passing a tunnel
 - When driving on rugged and uneven roads
- After downloading *Bluetooth*® Wireless Technology phone book, the system requires some times to convert the phone book into voice information. During this time, voice recognition may not operate properly.
- Upon inputting your phone book, special symbols and numbers cannot be recognized by voice. For example, “# John Doe%&” will be recognized as “John Doe”.

VOICE COMMAND (if equipped)

Starting Voice Command

- To start voice command, shortly press the  key on the steering wheel remote controller.
- If voice command is in [Normal Mode], then the system will say “Please say a command. Beep”
- * If voice command is in [Expert Mode], then the system will only say a “Beep-”
- * Setting Voice command [Normal Mode] / [Expert Mode] : Press the **SETUP** key ▶ Select **[System]** ▶ **Select [VRS Mode]** ▶ Set [Normal Mode] / [Expert Mode]
- Say the voice command.

* NOTICE

For proper voice recognition, say the voice command after the guidance message and the “Beep” sound.



Skipping the Guidance Message

While the guidance message is being stated, shortly press the  key (under 0.8 seconds) to discontinue the guidance message and sound the “beep”.

After the “beep”, say the voice command.



Ending Voice Command

- While using voice command, press and hold the  key (over 0.8 seconds) to end voice command.
- While using voice command, pressing the steering wheel remote controller or a different key will end voice command.
- In a state where the system is waiting for your voice command, say “cancel” or “end” to end voice command.
- In a state where the system is waiting for your voice command, shortly press the  key (under 0.8 seconds) to end voice command.

* Illustration on using voice commands

• Starting voice command.

Shortly pressing the  key (under 0.8 seconds):

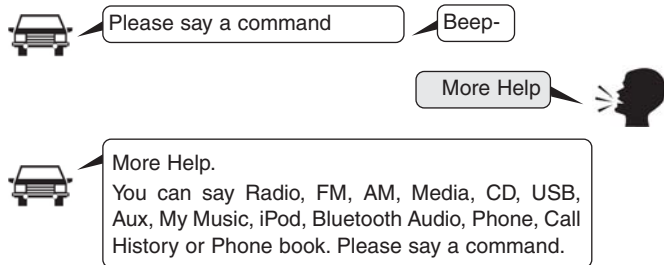

• Skipping Voice Recognition

Shortly pressing the  key (under 0.8 seconds):

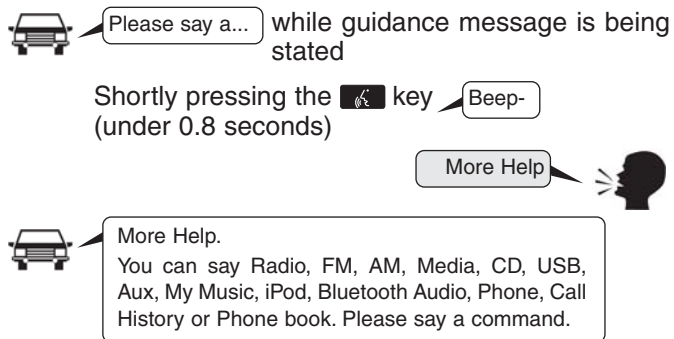

• End voice command.

Shortly pressing the  key (under 0.8 seconds):

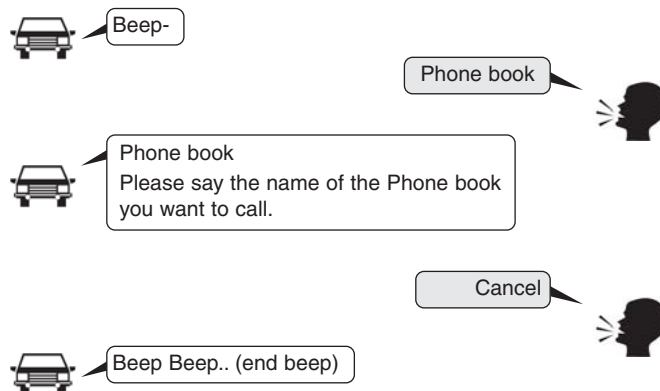

Voice Command List

- **Common Commands:** These are commands that can be used in all situations. (However, some commands may not be supported in special circumstances.)

Command	Function
More Help	Provides guidance on commands that can be used anywhere in the system.
Help	Provides guidance on commands that can be used within the current mode.
Call<Name>	Calls <Name> saved in phone book Ex) Call "John"
Phone	Provides guidance on Phone related commands. After saying this command, say "Call History", "Phone book", "Dial Number" to execute corresponding functions.
Call History	Displays the Call History screen.
Phone book	Displays the phone book screen. After saying this command, say the name of a phone book saved in the phone book to automatically connect the call.
Dial Number	Display the Dial number screen. After saying this command, you can say the number what you want to call.
Redial	Connects the most recently called number.
Radio	<ul style="list-style-type: none"> • When listening to the radio, displays the next radio screen. (FM1→FM2→FMA→AM→AMA) • When listening to a different mode, displays the most recently played radio screen.

Command	Function
FM	<ul style="list-style-type: none"> • When currently listening to the FM radio, maintains the current state. • When listening to a different mode, displays the most recently played FM screen.
FM1(FM One)	Displays the FM1 screen.
FM2(FM Two)	Displays the FM2 screen.
FMA	Displays the FMA screen.
AM	Displays the AM screen.
AMA	Displays the AMA screen.
FM Preset 1~6	Plays the most recently played broadcast saved in FM Preset 1~6.
AM Preset 1~6	Plays the broadcast saved in AM Preset 1~6.
FM 87.5~107.9	Plays the FM broadcast of the corresponding frequency.
AM 530~1710	Plays the AM broadcast of the corresponding frequency.
TA on	Enable Traffic Announcement
TA off	Disable Traffic Announcement
News on	Enable RDS News feature
News off	Disable RDS News feature

Features of your vehicle

Command	Function
Media	Moves to the most recently played media screen.
Play Track 1~30	If a music CD has been inserted, plays the corresponding track.
CD	Plays the music saved in the CD.
Search CD	Moves to the CD track or file selection screen. <ul style="list-style-type: none">• For audio CDs, move to the screen and say the track number to play the corresponding track.• Moves to MP3 CD file selection screen. After manually operate the device to select and play music.
USB	Plays USB music.
Search USB	Moves to USB file selection screen. After manually operate the device to select and play music.
iPod	Plays iPod music.
Search iPod	Moves to the iPod file selection screen. After, manually operate the device to select and play music.
My Music	Plays the music saved in My Music.
Search My Music	Moves to My Music file selection screen. After manually operate the device to select and play music.

Command	Function
AUX (Auxiliary)	Plays the connected external device.
Bluetooth Audio	Plays the music saved in connected <i>Bluetooth</i> [®] Wireless Technology device.
Mute	Mutes the radio or music volume.
Pardon?	Repeats the most recent comment.
Cancel (Exit)	Ends voice command.

- **FM/AM radio commands:** Commands that can be used while listening to FM, AM radio.

Command	Function
Preset 1~6	Plays the broadcast saved in Preset 1~6.
Auto Store	Automatically selects radio broadcast frequencies with superior reception and saves in Presets 1~6.
Preset Save 1~6	Saves the current broadcast frequency to Preset 1~6.
Seek up	Plays the next receivable broadcast.
Seek down	Plays the previous receivable broadcast.
Next Preset	Selects the preset number next to the most recently selected preset. (Example: When currently listening to preset no. 3, then preset no. 4 will be selected.)
Previous Preset	Selects the preset number previous to the most recently selected preset. (Example: When currently listening to preset no. 3, then preset no. 2 will be selected.)
Scan	Scans receivable frequencies from the current broadcast and plays for 10 seconds each.
Preset Scan	Moves to the next preset from the current present and plays for 10 seconds each.
AF on	Enable Alternative Frequency feature
AF off	Disable Alternative Frequency feature
Region	Enable Region feature

- **Audio CD commands:** Commands that can be used while listening to Audio CD.

Command	Function
Region off	Disable Region feature
Program Type	Moves to the RDS Program type selection screen. After, manually operate the device to select a desired program type.
Random	Randomly plays the tracks within the CD.
Random Off	Cancels random play to play tracks in sequential order.
Repeat	Repeats the current track.
Repeat Off	Cancels repeat play to play tracks in sequential order.
Next Track	Plays the next track.
Previous Track	Plays the previous track.
Scan	Scans the tracks from the next track for 10 seconds each.
Track 1~30	Plays the desired track number.
Search Track	Moves to the track selection screen. After, say the track name to play the corresponding track.
Information	Displays the information screen of the current track.

- **MP3 CD / USB commands:** Commands that can be used while listening to music files saved in CD and USB.

Command	Function
Random	Randomly plays the files within the current folder.
All Random	Randomly plays all saved files.
Random Off	Cancels random play to play files in sequential order.
Repeat	Repeats the current file.
Folder Repeat	Repeats all files in the current folder.
Repeat Off	Cancels repeat play to play files in sequential order.
Next File	Plays the next file.
Previous File	Plays the previous file.
Scan	Scans the files from the next files for 10 seconds each.
Search File	Moves to the file selection screen.
Search Folder	Moves to the folder selection screen.
Information	Displays the information screen of the current file.
Copy	Copies the current file into My Music.

- **iPod Commands:** Commands that can be used while playing iPod.

Command	Function
All Random	Randomly plays all saved songs.
Random	Randomly plays the songs within the current category.
Random Off	Cancels random play to play songs in sequential order.
Repeat	Repeats the current song.
Repeat Off	Cancels repeat play to play songs in sequential order.
Next Song	Plays the next song.
Previous Song	Plays the previous song.
Search Song	Moves to the song selection screen.
Information	Displays the information screen of the current song.

- **My Music Commands:** Commands that can be used while playing My Music.

Command	Function
Random	Randomly plays all saved files.
Random Off	Cancels random play to play files in sequential order.
Repeat	Repeats the current file.
Repeat Off	Cancels repeat play to play files in sequential order.
Next File	Plays the next file.
Previous File	Plays the previous file.
Scan	Scans the files from the next files for 10 seconds each.
Search File	Moves to the file selection screen.
Information	Displays the information screen of the current file.
Delete	Deletes the current file. You will bypass an additional confirmation process.
Delete All	Deletes all files saved in My Music. You will bypass an additional confirmation process.

- **Bluetooth® Wireless Technology Audio Commands:** Commands that can be used while playing Phone Music.

Command	Function
Play	Plays the currently paused song.
Pause	Pauses the current song.

APPENDIX

Name	Description
AST (A.store)	Automatically selects and saves channels
SDVC	Speed Dependent Volume Control

FCC Warning

This equipment has been tested and found to comply with the limits for a Class B digital device, pursuant to part 15 of the FCC Rules. These limits are designed to provide reasonable protection against harmful interference in a residential installation.

This equipment generates, uses and can radiate radio frequency energy and, if not installed and used in accordance with the instructions, may cause harmful interference to radio communications. However, there is no guarantee that interference will not occur in a particular installation. If this equipment does cause harmful interference to radio or television reception, which can be determined by turning the equipment off and on, the user is encouraged to try to correct the interference by one or more of the following measures:

- Reorient or relocate the receiving antenna.
- Increase the separation between the equipment and receiver.
- Connect the equipment into an outlet on a circuit different from that to which the receiver is connected.
- Consult the dealer or an experienced radio/TV technician for help

Caution: Any changes or modifications to this device not explicitly approved by manufacturer could void your authority to operate this equipment.

This device complies with part 15 of the FCC Rules. Operation is subject to the following two conditions: (1) This device may not cause harmful interference, and (2) this device must accept any interference received, including interference that may cause undesired operation.

This equipment complies with FCC radiation exposure limits set forth for an uncontrolled environment.

This equipment should be installed and operated with minimum 20 cm between the radiator and your body. This transmitter must not be collocated or operating in conjunction with any other antenna or transmitter unless authorized to do so by the FCC.