

How vehicle audio works

FM reception

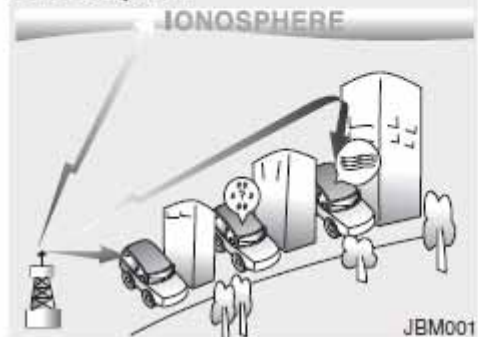

AM and FM radio signals are broadcast from transmitter towers located around your city. They are intercepted by the radio antenna on your vehicle. This signal is then processed by the radio and sent to your vehicle speakers.

When a strong radio signal has reached your vehicle, the precise engineering of your audio system ensures the best possible quality reproduction. However, in some cases the signal coming to your vehicle may not be strong and clear.

This can be due to factors, such as the distance from the radio station, closeness of other strong radio stations or the presence of buildings, bridges or other large obstructions in the area.

AM reception

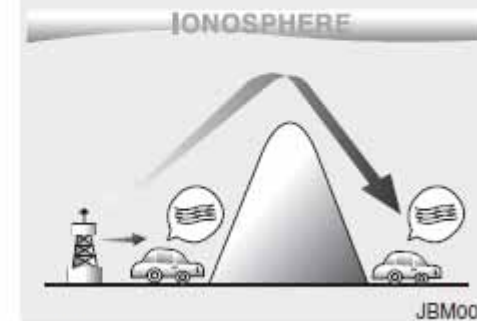

AM broadcasts can be received at greater distances than FM broadcasts. This is because AM radio waves are transmitted at low frequencies. These long distance, low frequency radio waves can follow the curvature of the earth rather than travelling straight. In addition, they curve around obstructions resulting in better signal coverage.



FM broadcasts are transmitted at high frequencies and do not bend to follow the earth's surface. Because of this, FM broadcasts generally begin to fade within short distances from the station. Also, FM signals are easily affected by buildings, mountains, and obstructions. This can lead to undesirable or unpleasant listening conditions which might lead you to believe a problem exists with your radio. The following conditions are normal and do not indicate radio trouble:

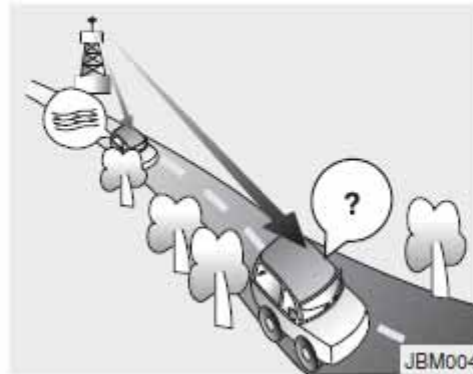

- **Fading** - As your vehicle moves away from the radio station, the signal will weaken and sound will begin to fade. When this occurs, we suggest that you select another stronger station.
- **Flutter/Static** - Weak FM signals or large obstructions between the transmitter and your radio can disturb the signal causing static or fluttering noises to occur. Reducing the treble level may lessen this effect until the disturbance clears.

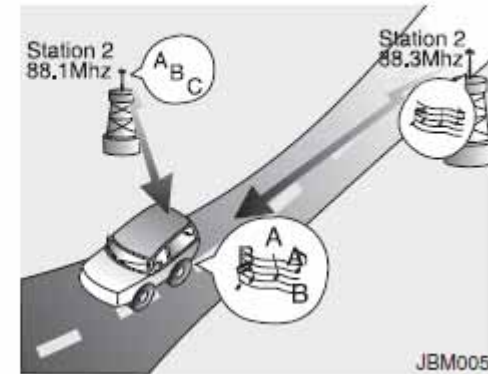

- **Station Swapping** - As an FM signal weakens, another more powerful signal near the same frequency may begin to play. This is because your radio is designed to lock onto the clearest signal. If this occurs, select another station with a stronger signal.
- **Multi-Path Cancellation** - Radio signals being received from several directions can cause distortion or fluttering. This can be caused by a direct and reflected signal from the same station, or by signals from two stations with close frequencies. If this occurs, select another station until the condition has passed.

Using a cellular phone or a two-way radio

When a cellular phone is used inside the vehicle, noise may be produced from the audio system. This does not mean that something is wrong with the audio equipment. In such a case, try to operate mobile devices as far from the audio equipment as possible.

⚠ CAUTION

When using a communication system such as a cellular phone or a radio set inside the vehicle, a separate external antenna must be fitted. When a cellular phone or a radio set is used with an internal antenna alone, it may interfere with the vehicle's electrical system and adversely affect safe operation of the vehicle.

⚠ WARNING

Do not use a cellular phone while driving. Stop at a safe location to use a cellular phone.

Caring for disc

- If the temperature inside the car is too high, open the car windows to ventilate before using the system.
- It is illegal to copy and use MP3/WMA files without permission. Use CDs that are created only by lawful means.
- Do not apply volatile agents, such as benzene and thinner, normal cleaners and magnetic sprays made for analogue disc onto CDs.
- To prevent the disc surface from getting damaged, hold CDs by the edges or the center hole only.
- Clean the disc surface with a piece of soft cloth before playback (wipe it from the center to the outside edge).
- Do not damage the disc surface or attach pieces of sticky tape or paper.
- Make certain only CDs are inserted into the CD player (Do not insert more than one CD at a time).
- Keep CDs in their cases after use to protect them from scratches or dirt.

- Depending on the type of CD-R/CD-RW CDs, certain CDs may not operate normally according to the manufacturing companies. In such circumstances, continued use may cause malfunctions to your audio system.

*** NOTICE**

- Playing an Incompatible Copy Protected Audio CD

Some copy protected CDs, which do not comply with international audio CD standards (Red Book), may not play on your car audio. Please note that inability to properly play a copy protected CD may indicate that the CD is defective, not the CD player.

NOTE:

Order of playing files (folders) :

1. Song playing order : ① to ⑭ sequentially.
 2. Folder playing order :
- * If no song file is contained in the folder, that folder is not displayed.

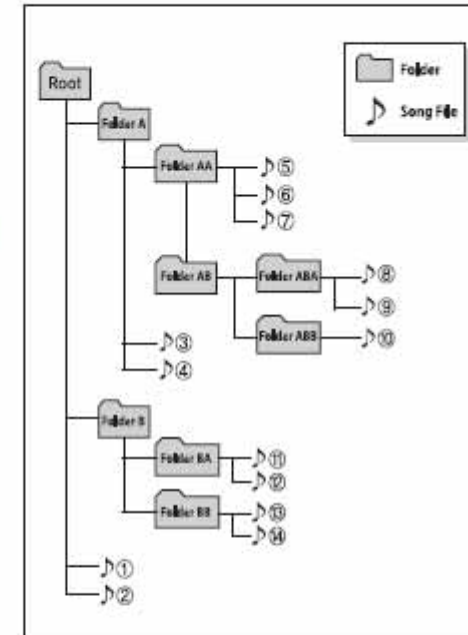
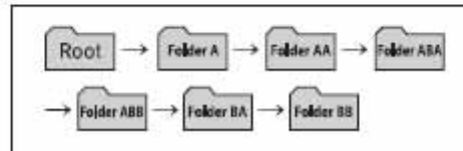

⚠ WARNING

- *Do not stare at the screen while driving. Staring at the screen for prolonged periods of time could lead to traffic accidents.*
- *Do not disassemble, assemble, or modify the audio system. Such acts could result in accidents, fire, or electric shock.*
- *Using the phone while driving may lead to a lack of attention of traffic conditions and increase the likelihood of accidents. Use the phone feature after parking the vehicle.*
- *Heed caution not to spill water or introduce foreign objects into the device. Such acts could lead to smoke, fire, or product malfunction.*

(Continued)

(Continued)

- *Please refrain from use if the screen is blank or no sound can be heard as these signs may indicate product malfunction. Continued use in such conditions could lead to accidents (fires, electric shock) or product malfunctions.*
- *Do not touch the antenna during thunder or lightening as such acts may lead to lightning induced electric shock.*
- *Do not stop or park in parking-restricted areas to operate the product. Such acts could lead to traffic accidents.*
- *Use the system with the vehicle ignition turned on. Prolonged use with the ignition turned off could result in battery discharge.*

⚠ CAUTION

- *Operating the device while driving could lead to accidents due to a lack of attention to external surroundings. First park the vehicle before operating the device.*
- *Adjust the volume to levels that allow the driver to hear sounds from outside of the vehicle. Driving in a state where external sounds cannot be heard may lead to accidents.*
- *Pay attention to the volume setting when turning the device on. A sudden output of extreme volume upon turning the device on could lead to hearing impairment. (Adjust the volume to a suitable levels before turning off the device.)*

(Continued)

(Continued)

- *If you want to change the position of device installation, please inquire with your place of purchase or service maintenance center. Technical expertise is required to install or disassemble the device.*
- *Turn on the car ignition before using this device. Do not operate the audio system for long periods of time with the ignition turned off as such operations may lead to battery discharge.*
- *Do not subject the device to severe shock or impact. Direct pressure onto the front side of the monitor may cause damage to the LCD or touch screen.*

(Continued)

(Continued)

- *When cleaning the device, make sure to turn off the device and use a dry and smooth cloth. Never use tough materials, chemical cloths, or solvents (alcohol, benzene, thinners, etc.) as such materials may damage the device panel or cause color/quality deterioration*
- *Do not place beverages close to the audio system. Spilling beverages may lead to system malfunction.*
- *In case of product malfunction, please contact your place of purchase or After Service center.*
- *Placing the audio system within an electromagnetic environment may result in noise interference.*

XM RADIO MODE

Features of your vehicle

Satellite radio reception

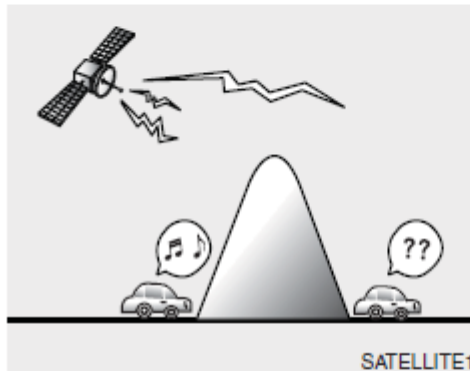

You may experience difficulties in receiving XM™ satellite radio signals in the following situations.

- If you are driving in a tunnel or a covered parking area.
- If you are driving beneath the top level of a multi-level freeway.
- If you are driving under a bridge.
- If you are driving next to a tall vehicle (such as a truck or a bus) that blocks the signal.

- If you are driving in a valley where the surrounding hills or peaks block the signal from the satellite.
- If you are driving on a mountain road where the signal is blocked by mountains.

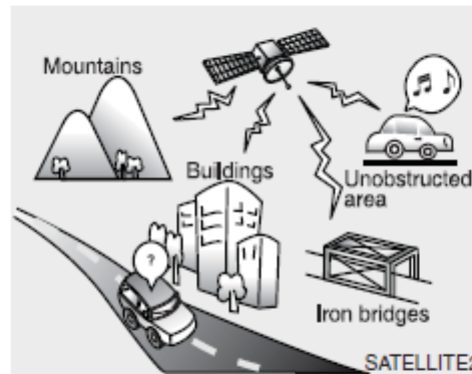

- If you are driving in an area with tall trees that block the signal (30 ft. /10m or more), for example on an road that goes through a dense forest.
- The signal can become weak in some areas that are not covered by the XM™ repeater network.

NOTE:

There may also be additional unforeseen circumstances leading to reception problems with the XM™ satellite radio signal.

Advisory Messages, such as 'CH Unavailable' may occur when starting XM Radio.

*** NOTICE - USING THE DISCS**

- This device has been manufactured to be compatible with software bearing the following logo marks.
- Do not clean discs with chemical solutions, such as record sprays, antistatic sprays, antistatic liquids, benzene, or thinners.
- After using a disc, put the disc back in its original case to prevent disc scratches.
- Hold discs by their edges or within the center hole to prevent damages to disc surfaces.
- Do not introduce foreign substances into the disc insert/eject slot. Introducing foreign substances could damage the device interior.
- Do not insert two discs simultaneously.
- When using CD-R/CD-RW discs, differences in disc reading and playing times may occur depending on the disc manufacturer, production method and the recording method as used by the user.

(Continued)

(Continued)

- Clean fingerprints and dust off the disc surface (coated side) with a soft cloth.
- The use of CD-R/CD-RW discs attached with labels may result in disc slot jams or difficulties in disc removal. Such discs may also result in noise while playing.
- Some CD-R/CD-RW discs may not properly operate depending on the disc manufacturer, production method and the record method as used by the user. If problems persist, trying using a different CD as continued use may result in malfunctions.
- The performance of this product may differ depending on the CD-RW Drive Software.
- Copy-protected CDs such as S-type CDs may not function in the device. DATA discs cannot be played. (However, such discs may still operate but will do so abnormally.)

(Continued)

(Continued)

- Do not use abnormally shaped discs (8cm, heart-shaped, octagon-shaped) as such discs could lead to malfunctions.
- If the disc is straddled on the disc slot without removal for 10 seconds, the disc will automatically be re-inserted into the disc player.
- Only genuine audio CDs are supported. Other discs may result in recognition failure (e.g. copy CD-R, CDs with labels)

*** NOTICE - USING THE USB DEVICE**

- Connect the USB device after turning on the engine. The USB device may become damaged if it is already connected when the ignition is turned on. The USB device may not operate properly if the car ignition is turned on or off with the USB device connected.
- Heed caution to static electricity when connecting/disconnecting USB devices.
- Encoded MP3 Players will not be recognized when connected as an external device.
- When connecting an external USB device, the device may not properly recognize the USB is in some states.
- Only products formatted with byte/sectors under 64Kbyte will be recognized.
- This device recognizes USB devices formatted in FAT 12/16/32 file formats. This device does not recognize files in NTFS file format.

(Continued)

(Continued)

- Some USB devices may not be supported due to compatibility issues.
- Avoid contact between the USB connector with bodily parts or foreign objects.
- Repeated connecting/disconnecting of USB devices within short periods of time may result in product malfunction.
- A strange noise may occur when disconnecting the USB.
- Make sure to connect/disconnect external USB devices with the audio power turned off.
- The amount of time required to recognize the USB device may differ depending on the type, size or file formats stored in the USB. Such differences in time are not indications of malfunctions.
- The device only supports USB devices used to play music files.
- USB images and videos are not supported.

(Continued)

(Continued)

- Do not use the USB I/F to charge batteries or USB accessories that generate heat. Such acts may lead to worsened performance or damage to the device.
- The device may not recognize the USB device if separately purchased USB hubs and extension cables are being used. Connect the USB directly with the multimedia terminal of the vehicle.
- When using mass storage USB devices with separate logical drives, only files saved to the root drive can be played.
- Files may not properly operate if application programs are installed to the USBs.
- The device may not operate normally if MP3 Players, cellular phones, digital cameras, or other electronic devices (USB devices not recognized as portable disk drives) are connected with the device.

(Continued)

- Charging through the USB may not work for some mobile devices.
- The device may not support normal operation when using a USB memory type besides (Metal Cover Type) USB Memory.
- The device may not support normal operation when using formats such as HDD Type, CF, or SD Memory.
- The device will not support files locked by DRM (Digital Rights Management.)
- USB memory sticks used by connecting an Adaptor (SD Type or CF Type) may not be properly recognized.
- The device may not operate properly when using USB HDDs or USBs subject to connection failures caused by vehicle vibrations. (e.g. i-stick type)

(Continued)

(Continued)

- Avoid use of USB memory products that can also be used as key chains or mobile phone accessories. Use of such products may cause damage to the USB jack.
- Connecting an MP3 device or phone through various channels, such as AUX/BT or Audio/USB mode may result in pop noises or abnormal operation.
- USB memory without the certification mark may not be recognized.



*** NOTICE - USING THE iPod® DEVICE**

- iPod® is a registered trademark of Apple Inc.
- In order to use the iPod while operating the keys, you must use a dedicated iPod cable. (the cable that is supplied when purchasing iPod/iPhone products)
- If the iPod is connected to the vehicle while it is playing, a high pitch sound could occur for approximately 1-2 seconds immediately after connecting. If possible, connect the iPod to the vehicle with the iPod stopped/paused.
- During ACC ON state, connecting the iPod through the iPod cable will charge the iPod through the car audio system.
- When connecting with the iPod cable, make sure to fully insert the jack to prevent communication interference.

(Continued)

(Continued)

- When the EQ features of an external device, such as the iPod, and the audio system are both active, EQ effects could overlap and cause sound deterioration and distortion. Whenever possible, turn off the EQ feature within the external device upon use by connecting with the audio system.
- Noise may occur when an iPod or AUX device is connected. When such devices are not being used, disconnect the device for storage.
- When the iPod or AUX device power is connected to the power jack, playing the external device may result in noise. In such cases, disconnect the power connection before use.
- Skipping or improper operation may occur depending on the characteristics of your iPod/Phone device.

(Continued)

(Continued)

- If your iPhone is connected to both the *Bluetooth®* Wireless Technology and USB, the sound may not be properly played. In your iPhone, select the Dock connector or *Bluetooth®* Wireless Technology to change the sound output (source).
- iPod mode cannot be operated when the iPod cannot be recognized due to versions that do not support communication protocols.
- For fifth generation iPod Nano devices, the iPod may not be recognized when the battery level is low. Please charge the iPod for use.
- Search/play orders shown within the iPod device may differ with the orders shown within the audio system.
- If the iPod malfunctions due to an iPod device defect, reset the iPod and try again. (To learn more, refer to your iPod manual)

(Continued)

(Continued)

- Some iPods may not sync with the System depending on its version. If the Media is removed before the Media is recognized, then the system may not properly restore the previously operated mode. (iPad charging is not supported.)

*** NOTICE - USING THE
Bluetooth® Wireless
Technology Audio Mode**

- *Bluetooth*® Wireless Technology Audio Mode can be used only when a *Bluetooth*® Wireless Technology phone has been connected.
- *Bluetooth*® Wireless Technology Audio Mode will not be available when connecting mobile phones that do not support this feature.
- While *Bluetooth*® Wireless Technology Audio is playing, if the *Bluetooth*® Wireless Technology phone is connected, then the music will also stop.
- Moving the Track up/down while playing *Bluetooth*® Wireless Technology audio mode may result in pop noises in some mobile phones.
- *Bluetooth*® Wireless Technology streaming audio may not be supported in some mobile phones.

(Continued)

(Continued)

- When returning to *Bluetooth*® Wireless Technology Audio mode after ending a call, the mode may not automatically restart in some mobile phones.
- Receiving an incoming call or making an outgoing call while playing *Bluetooth*® Wireless Technology Audio may result in audio interference.

*** NOTICE - USING UPON
CONNECTING *Bluetooth*[®]
Wireless Technology PHONE**

- Before connecting the car audio system with the mobile phone, check to see that the mobile phone supports *Bluetooth*[®] Wireless Technology features.
- Even if the phone supports *Bluetooth*[®] Wireless Technology, the phone will not be found during device searches if the phone has been set to hidden state or the *Bluetooth*[®] Wireless Technology power is turned off. Disable the hidden state or turn on the *Bluetooth*[®] Wireless Technology power prior to searching/connecting with the car audio system.
- If you do not want to automatically connect your *Bluetooth*[®] Wireless Technology phone, try the following.
 1. Turn off the *Bluetooth*[®] feature in your mobile phone.

(Continued)

(Continued)

- For more information on *Bluetooth*[®] Wireless Technology features within your mobile, refer to your mobile phone user's manual.
- 2. Turn off the *Bluetooth*[®] Wireless Technology feature in your car audio system.
 - To turn off the *Bluetooth*[®] Wireless Technology feature in your car audio system, go to **SETUP** ▶ [Phone] and [turn off] the *Bluetooth*[®] Wireless Technology feature.
- Park the vehicle when connecting the car audio system with your mobile phone.
- *Bluetooth*[®] Wireless Technology connection may become intermittently disconnected in some mobile phones. Follow these steps to try again.
 1. Turn the *Bluetooth*[®] Wireless Technology function within the mobile phone off/on and try again.
 2. Turn the mobile phone power Off/On and try again.

(Continued)

(Continued)

3. Completely remove the mobile phone battery, reboot, and then again.
 4. Reboot the audio system and try again.
 5. Delete all paired devices, pair and try again.
- The Handsfree call volume and quality may differ depending on the mobile phone.
 - *Bluetooth*[®] Wireless Technology features supported within the vehicle are as follows. Some features may not be supported depending on your *Bluetooth*[®] Wireless Technology device.
 - Answering and placing *Bluetooth*[®] Wireless Technology Handsfree calls
 - Menu operation during call (Switch to Private, Switch to call waiting, Outgoing volume)
 - Download Call History
 - Download Mobile Phone book
 - Phone book/Call History Auto Download

(Continued)

(Continued)

- It is possible to pair up to five *Bluetooth*® Wireless Technology devices to the car system.
- Only one *Bluetooth*® Wireless Technology device can be connected at a time.
- Other devices cannot be paired while a *Bluetooth*® Wireless Technology device is already connected.
- When a *Bluetooth*® Wireless Technology device is being connected, the connection process cannot be canceled.
- Only *Bluetooth*® Wireless Technology Handsfree and *Bluetooth*® Wireless Technology audio related features will operate within this system.
- Normal operation is possible only for devices that support Handsfree or audio features, such as a *Bluetooth*® Wireless Technology mobile phone or a *Bluetooth*® Wireless Technology audio device.

(Continued)

(Continued)

- Only one function can be used at a time between the *Bluetooth*® Wireless Technology Handsfree and *Bluetooth*® Wireless Technology audio. (While playing *Bluetooth*® Wireless Technology audio, streaming will end upon entering the *Bluetooth*® Wireless Technology phone screen.)
- If a connected *Bluetooth*® Wireless Technology device becomes disconnected for various reasons, such as being out of range, turning the device OFF, or a *Bluetooth*® Wireless Technology communication error, *Bluetooth*® Wireless Technology devices are automatically searched and connected.
- *Bluetooth*® Handsfree is a feature that enables drivers to practice safe driving. Connecting the head unit with a *Bluetooth*® phone allows the user to conveniently make calls, receive calls, and manage the phone book. Before using the *Bluetooth*®, carefully read the contents of this user's manual.

*** NOTICE - USING THE Voice Recognition**

- When using the voice recognition feature, only commands listed within the user's manual are supported.
- Be aware that during the operation of the voice recognition system, pressing any key other than the **⏏** key or touching the screen will terminate voice recognition mode.
- For superior voice recognition performance, position the microphone used for voice recognition above the head of the driver's seat and maintain a proper position when saying commands.
- Within the following situations, voice recognition may not function properly due to external sound.
 - When the windows and sunroof are open
 - When the wind of the cooling / heating device is strong
 - When entering and passing through tunnels

(Continued)

(Continued)

- When driving on rugged and uneven roads
- During severe rain (heavy rains, windstorms)
- Phone related voice commands can be used only when a *Bluetooth*[®] Wireless Technology device is connected.
- When making calls by stating a name, the corresponding contact must be downloaded and stored within the audio system.
- After downloading the *Bluetooth*[®] Wireless Technology phone book, it takes some times to convert the phone book data into voice information. During this time, voice recognition may not properly operate.
- Pronounce the voice commands naturally and clearly as if in a normal conversation.

■ **CD Player : AC1xxDKxx**

AC101DKMG, AC111DKMG, AC100DKGN, AC110DKGN, AC101DKGE, AC111DKGE, AC101DKGL, AC111DKGL, AC113DKMG, AC113DKGG, AC112DKEE, AC1B2DKAN, AC1BADKKN, AC114DKGG



COMPONENT NAMES AND FUNCTIONS

Head Unit



(1)  (EJECT)

Press to insert or eject disc.
When press and held(3seconds) : emergency eject.

(2)  **RADIO**

Converts to Radio (FM, AM, XM) mode.
Each time this key is pressed, the mode is changed in order of FM1, FM2, AM, XM1, XM2, XM3.

(3)  **MEDIA**

Starts Media mode.
Each time this key is pressed, the mode is changed in order of CD, USB(iPod), AUX, My Music, BT Audio.

(4)  **PHONE**

Converts to Phone mode.

(5)  **SETUP**

Converts to Setup mode.

(6)  PWR/VOL knob

 Volume : Turn left/right to control volume.

(7)  **SEEK**, **TRACK**

When pressed shortly (under 0.8 seconds).

- FM, AM mode : plays previous/next frequency.
- XM mode : plays previous/next channel.
- CD, USB, iPod, My Music mode : changes the track, file.

When pressed and held (over 0.8 seconds).

- FM, AM mode : continuously changes the frequency until the key is released and plays the current frequency.
- XM mode : continuously changes the channel until the key is released and plays the current channel.
- CD, USB, iPod, My Music mode : rewinds or fast forwards the track or file.
- During a Handsfree call, controls the call volume.



(8) **SCAN**

- FM, AM mode : previews all receivable broadcasts for 5 seconds each.
- XM mode : previews all receivable broadcasts for 10 seconds each.
- CD, USB, iPod, My Music mode : previews each song (file) for 10 seconds each.

(9) **CLOCK**

Displays the time/date/day.

Press and hold the key (over 0.8 seconds) to setting the Clock/Calendar screen.

(10) **FOLDER** , **FOLDER**

- CD MP3, USB mode : Folder Search
- XM mode: Category Search

(11) **DISP**

Turns the monitor display on/off.

(12) **MENU**

Displays supported menus within each mode.

(13) **TUNE** knob

- FM, AM mode : turn to change broadcast frequencies.
- CD, USB, iPod mode : turn to search tracks/channels/files.



(14) **1** ~ **6** (Preset)

- Radio mode : saves a frequency or receives saved frequencies.
- MEDIA mode : press the **1 RPT** key to repeat and **2 RDM** key to play in random order (shuffle).

Steering wheel remote controller



(1) VOLUME
Used to control volume.

(2) SEEK

- When pressed shortly (under 0.8 seconds).
 - FM, AM, XM mode : searches broadcast frequencies saved to presets.
 - CD, USB, iPod, My Music, BT Audio mode : changes the track, file.
- When pressed and held (over 0.8 seconds).
 - FM, AM, XM mode : automatically searches broadcast frequencies and channels.
 - CD, USB, iPod, My Music mode : rewinds or fast forwards the track or file.

(3) MODE

Each time this key is pressed, the mode is changed in order of FM1, FM2, AM, XM1, XM2, XM3, CD, USB(iPod), AUX, My Music, BT Audio. If the media is not connected or a disc is not inserted, corresponding modes will be disabled.

Press and hold the key (over 0.8 seconds) to turn the audio system on/off.

When power is off, press the key to turn power back on.

(4) MUTE

Mutes audio volume.

(5) 

- When pressed shortly.
 - When pressed in the phone screen, displays call history screen.
 - When pressed in the dial screen, makes a call.
 - When pressed in the incoming call screen, answers the call.
 - When pressed during call waiting, switches to waiting call (Call Waiting).
- When pressed and held (over 0.8 seconds).
 - When pressed in the *Bluetooth*[®] Wireless Technology Handsfree wait mode, redials the last call.
 - When pressed during a *Bluetooth*[®] Wireless Technology Handsfree call, switches call back to mobile phone (Private).
 - When pressed while calling on the mobile phone, switches call back to *Bluetooth*[®] Wireless Technology Handsfree (Operates only when *Bluetooth*[®] Wireless Technology Handsfree is connected).

(6) 

Ends phone call.

(7) 

- When pressed shortly
 - Starts voice recognition
 - When selecting during a voice prompt, stops the prompt and converts to voice command waiting state
- When pressed and held (over 0.8 seconds)
 - Ends voice recognition

RADIO MODE

Basic Mode Screen



(1) Mode Display
Displays currently operating mode.

(2) Frequency
Displays the current frequency.

(3) Preset
Displays currently playing preset number [1] ~ [6].

(4) MENU
Displays Radio menus.

(5) Preset Display
Displays saved presets.

(6) A.Store(Auto Store)
Automatically saves frequencies with superior reception to Preset buttons.

Switching to Radio Mode

Pressing the **RADIO** key will change the operating mode in order of FM1 → FM2 → AM → XM1 → XM2 → XM3.



If [Mode Pop up] is turned on within **SETUP** ▶ [Display], then pressing the **RADIO** key will display the Radio mode pop up screen.

Use **TUNE** knob to move the focus. Press the **TUNE** knob to select.

* NOTICE

If the **RADIO** key is pressed with the system power off, then the power will turn on and the most recently played broadcast will be played.

Searching Radio Frequencies

Using Seek

Press the **SEEK**, **TRACK** key to play the previous/next frequency.

Using TUNE

Turn the **TUNE** knob to select the frequency.

- FM : Increases/decreased by 200kHz
- AM : Increases/decreased by 10kHz

Using Radio Mode

Selecting Presets

Press the **MENU** key ▶ Select **Presets**

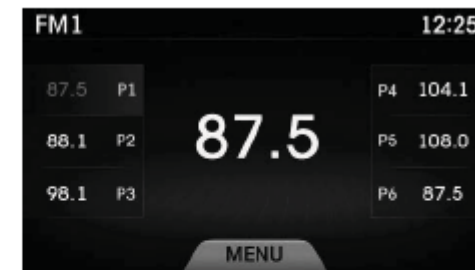

The 6 presets are displayed. Press the **1** ~ **6** key to play the desired preset.

Saving Presets



After selecting the frequency ▶ Press and hold the desired preset **1** ~ **6** key.

A 'beep' will sound and the frequency is saved to the selected preset button.

Auto Store

After pressing the **MENU** key ▶ Select the **A.Store** button to automatically save receivable frequencies to Preset buttons.

A total of 18 frequencies with six preset frequencies each for FM1 / FM2 / AM modes can be saved.

* NOTICE

While Auto Store is operating, selecting the **A.Store** button again will cancel the function and restore the previous frequency.

Scan

Press the **SCAN** key to scan all radio frequencies.

Press and hold the **SCAN** key (over 0.8 seconds) to scan preset buttons.

- Scan All : Scans frequencies with superior reception for 5 seconds each.
- Preset Scan : Scans broadcasts saved to presets for 5 seconds each.

Once scan is complete, the previously playing frequency is restored.

During Scan, pressing the **SCAN** key again will cancel the scan operation and restore the previously played frequency.

XM RADIO MODE

Basic Mode Screen



(1) Mode Display

Displays currently operating mode.

(2) Channel Information

Displays the category, channel number, channel name, artist and song title.

(3) Preset

Displays currently playing preset number [1] ~ [6].

(4) MENU

Displays XM Radio menus.

(5) Preset Display

Displays saved presets.

Using SEEK

Press the **SEEK**, **TRACK** keys to play the previous/next channel.

* If the "Category" icon is displayed, channels are changed within the current category.

Using Tune

Press the **TUNE** knob to search all channels.

Searching Categories

Select the category by using the **FOLDER**, **FOLDER** keys and press the **TUNE** knob to select.



Channels for the selected category are played.

Selecting Presets

Press the **MENU** key ▶ Select **Preset**

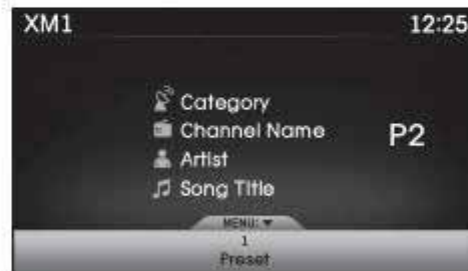

The 6 preset buttons are displayed. Press the **1** ~ **6** key to play the desired preset.

Saving Presets



After selecting the channel ▶ Press and hold the desired preset **1** ~ **6** key.

A 'beep' will sound and the channel is saved to the selected preset button.

SCAN

Press the **SCAN** key to scan all channels with superior reception for 10 seconds each.

Once scan is complete, the previously played channel will be restored.

During Scan, pressing the **SCAN** key again will cancel the scan operation and restore the previously played channel.

If the "Category" icon is displayed, channels are changed within the current category.

MEDIA MODE

Pressing the **MEDIA** key will change the operating mode in order of CD-USB(iPod)-AUX-My Music - BT Audio.



If [Mode Pop up] is turned on within **SETUP** ▶ [Display], then pressing the **MEDIA** key will display the Media mode Pop-up screen.

Use the **TUNE** knob to move the focus. Press the knob to select.

* NOTICE

- If the **MEDIA** key is pressed with the system power off, then the power will turn on and the most recently played media mode will be played.
- The media mode pop up screen can be displayed only when there are two or more media modes turned on.

AUDIO CD MODE

Basic Mode Screen



(1) Mode

Displays currently operating mode.

(2) Operation State

From Repeat / Shuffle / Scan, displays the currently operating function.

(3) Track Info

Displays information about the current track.

(4) Play State

Displays the play/pause state.

(5) Play Time

Displays the current play time.

(6) MENU

Displays the Audio CD Menu.

(7) Repeat

Turns the Repeat feature on/off.

(8) Shuffle

Turns the Shuffle feature on/off.

(9) List

Moves to the list screen.

(10) Info

Shows detailed information about the current track.

Using Audio CD Mode

Playing/Pausing CD Tracks

Once an audio CD is inserted, the mode will automatically start and begin playing.

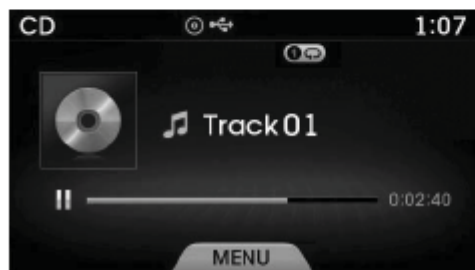

While playing, press the **TUNE** knob to pause and press again to play.

*** NOTICE**

- Only genuine audio CDs are supported. Other discs may result in recognition failure (e.g. copy CD-R, CDs with labels)
- The artist and title information are displayed on the screen if track information is included within the audio CD.

Changing Tracks

Press the **SEEK**, **TRACK** key to move to the previous or next track.

*** NOTICE**

- Pressing the **TRACK** key after the track has been playing for 2 seconds will start the current track from the beginning.
- Pressing the **TRACK** key before the track has been playing for 1 seconds will start the previous track.

Selecting from the List

Press the **TUNE** knob keys to search and select for the desired track.

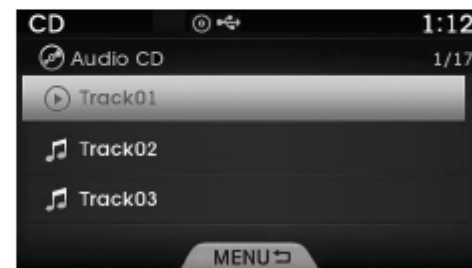

Once you find the desired track, press the **TUNE** knob to start playing.

Rewinding / Fast-forwarding Tracks

While playing, press and hold the **SEEK**, **TRACK** key (over 0.8 seconds) to rewind or fast-forward the current track.

Scan

Press the **SCAN** key to play the first 10 seconds of each track.

Audio CD Mode Menu

If you press the **MENU** key, you will have access to the Repeat, Shuffle, List and Info features.



Repeat

Press the **MENU** key ▶ Select **Repeat**
Repeat :Repeats the current track.

Shuffle

Press the **MENU** key ▶ Select **Shuffle**
Shuffle :Plays tracks in random order

* NOTICE

The **1**, **2** keys are shortcut keys to set the Repeat and Shuffle features.

List

Press the **MENU** key ▶ Select **List**



Press the **TUNE** knob to search for the desired track and press the **TUNE** knob to select.

Info

Press the **MENU** key ▶ Select **Info**

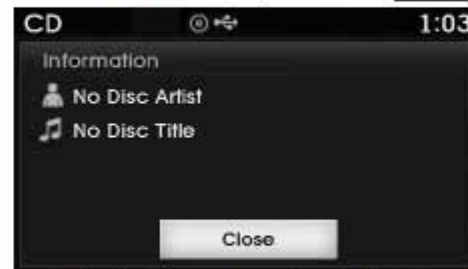

Details for the currently playing track are displayed.

MP3 CD MODE

Basic Mode Screen



(1) Mode

Displays currently operating mode.

(2) Operation State

From Repeat / Shuffle / Scan, displays the currently operating function.

(3) File Index

Displays the current file number.

(4) File Info

Displays information about the current file.

(5) Play State

Displays the play/pause state.

(6) Play Time

Displays the current play time.

(7) MENU

Displays the CD MP3 Menu.

(8) Repeat

Turns the Repeat feature on/off.

(9) Shuffle

Turns the Shuffle feature on/off.

(10) List

Moves to the list screen.

(11) Info

Shows detailed information about the current file.

(12) Copy

Copies the current file into My Music

Using MP3 CD Mode

Playing/Pausing MP3 Files

Once an MP3 disc is inserted the mode will automatically start and being playing.



While playing, press the **TUNE** knob to pause and press again to play.

* NOTICE

- If there are numerous files and folders within the disc, reading time could take more than 10 seconds and the list may not be displayed or song searches may not operate. Once loading is complete, try again.

Changing Files

Press the **SEEK**, **TRACK** keys to select the previous or next file.

* NOTICE

- Pressing the **TRACK** key after the file has been playing for 2 seconds will start the current file from the beginning.
- Pressing the **TRACK** key before the file has been playing for 1 seconds will start the previous file.

Selecting from the List

Press the **TUNE** knob to search and select for the desired files.

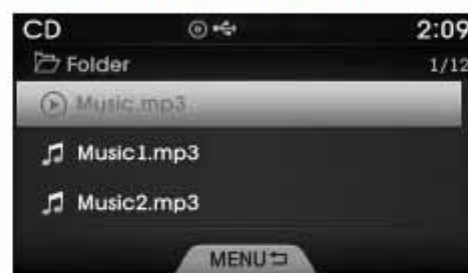

Once you find the desired file, press the **TUNE** knob to start playing.

Rewinding / Fast-forwarding Files

While playing, press and hold the **SEEK**, **TRACK** keys (over 0.8 seconds) to rewind or fast-forward the current file.

Scan

Press the **SCAN** key to play the first 10 seconds of each file.

Searching Folders

Select the folder by using the **FOLDER**, **FOLDER** keys and press the **TUNE** knob to select.



The first file within the selected folder will begin playing.

MP3 CD Mode Menu

If you press the **MENU** key, you will have access to the Repeat, Shuffle, List, Info and Copy features.



Repeat

Press the **MENU** key ▶ Select **Repeat**

Each time the button is pressed, the feature changes in order of Repeat –Repeat Folder–Off.

- Repeat Once : Repeats the current file.
- Repeat Folder : Repeats all files within the current Folder.

Shuffle

Press the **MENU** key ▶ Select **Shuffle**

Each time the button is pressed, the feature changes in order of Shuffle Folder – Shuffle All– Off.

- Folder Shuffle : Plays all files within the current folder in Random order.
- Shuffle All : Plays all files in Random order.

* NOTICE

The **1**, **2** keys are shortcut keys to set the Repeat and Shuffle features.

List

Press the **MENU** key ▶ Select **List**

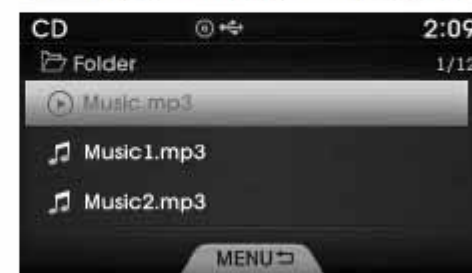

Press the **TUNE** knob to search for the desired file and press the **TUNE** knob to select.

Info

Press the **MENU** key ▶ Select **Info**
Details for the currently playing file are displayed.

*** NOTICE**

- When the 'Folder File' option is set as the default display within Display setup, the album/artist/file information are displayed as detailed file information.
- When the 'Album Artist Song' option is set as the default display, the folder name/file name are displayed as detailed file information.
- The title, artist and album info are displayed only when such information are recorded within the MP3 file ID3 tag.

Copy Files

Press the **MENU** key ▶ Select **Copy**
The currently playing file is copied into My Music.

*** NOTICE**

- Selecting another feature during copying will display a pop-up asking whether you wish to cancel copying. To cancel, select 'Yes'.

Features of your vehicle

USB MODE

Basic Mode Screen



(1) Mode

Displays currently operating mode.

(2) Operation State

From Repeat / Shuffle / Scan, displays the currently operating function.

(3) File Index

Displays the current file number.

(4) File Info

Displays information about the current file.

(5) Play State

Changes the play/pause state.

(6) Play Time

Displays the current play time.

(7) MENU

Displays USB Menu.

(8) Repeat

Turns the Repeat feature on/off.

(9) Shuffle

Turns the Shuffle feature on/off.

(10) List

Moves to the list screen.

(11) Info

Displays additional information for the current file.

(12) Copy

Copies the current file into My Music.

Using USB Mode

Playing/Pausing USB Files

Once a USB is connected, the mode will automatically start and begin playing a USB file.

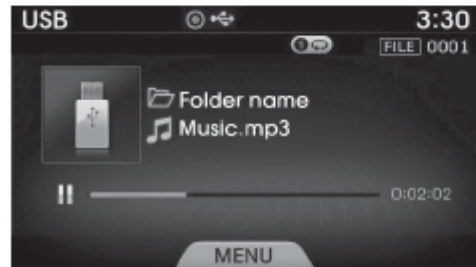

While playing, press the **TUNE** knob to pause and press again to play.

* NOTICE

- Loading may require additional time if there are many files and folders within the USB and result in faulty list display or file searching. Normal operations will resume once loading is complete.
- The device may not support normal operation when using a USB memory type besides (Metal Cover Type) USB Memory.

Changing Files

Press the **SEEK**, **TRACK** keys to select the previous or next file.

* NOTICE

- Pressing the **TRACK** key after the file has been playing for 2 seconds will start the current file from the beginning.
- Pressing the **TRACK** key before the file has been playing for 1 seconds will start the previous file.

Selecting from the List

Press the **TUNE** knob to search and select desired files.

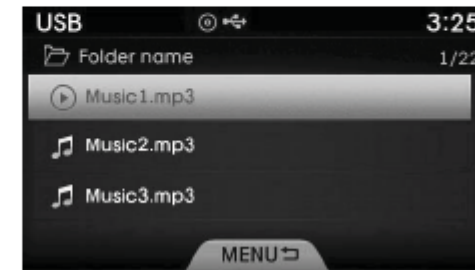

Once you find the desired file, press the **TUNE** knob to start playing.

Rewinding / Fast-forwarding Files

While playing, press and hold the **SEEK**, **TRACK** keys (over 0.8 seconds) to rewind or fast-forward the current file.

Scan

Press the **SCAN** key to play the first 10 seconds of each file.

Features of your vehicle

Searching Folders

Select the folder by using the **FOLDER**, **FOLDER** keys and press the **TUNE** knob to select.



The first file within the selected folder will begin playing.

USB Mode Menu

If you press the **MENU** key, you will have access to the Repeat, Shuffle, List, Info and Copy features.



Repeat

Press the **MENU** key ▶ Select **Repeat**
Each time the button is pressed, the feature changes in order of Repeat → Repeat Folder → Off.

- Repeat : Repeats the current file.
- Folder Repeat : Repeats all files within the current folder.

Shuffle

Press the **MENU** key ▶ Select **Shuffle**
Each time the button is pressed, the feature changes in order of Shuffle Folder → Shuffle All → Off.

- Folder Shuffle : Plays the files in the current folder in random order.
- Shuffle All : Plays all files in random order.

* NOTICE

- The **1**, **2** keys are shortcut keys to set the Repeat and Shuffle features.

List

Press the **MENU** key ▶ Select **List**



Press the **TUNE** knob to search for the desired file and press the **TUNE** knob to select.

Info

Press the **MENU** key ▶ Select **Info**

Details for the currently playing file are displayed.

*** NOTICE**

- When the 'Folder File' option is set as the default display within Display setup, the album/artist/file information are displayed as detailed file information.
- When the 'Album Artist Song' option is set as the default display, the folder name/file name are displayed as detailed file information.
- The title, artist and album info are displayed only when such information are recorded within the MP3 file ID3 tag.

Copy Files

Press the **MENU** key ▶ Select **Copy**

The currently playing file is copied into My Music.

*** NOTICE**

Selecting another feature during copying will display a pop-up asking whether you wish to cancel copying. To cancel, select 'Yes'.

iPod MODE

Basic Mode Screen



(1) Mode

Displays currently operating mode.

(2) Operation State

From Repeat / Shuffle, displays the currently operating function.

(3) Song Index

Displays the current song/total number of songs.

(4) Song Info

Displays information about the current song.

(5) Play State

Changes the play/pause state.

(6) Play Time

Displays the current play time.

(7) MENU

Displays the iPod Menu.

(8) Repeat

Turns the Repeat feature on/off.

(9) Shuffle

Turns the Shuffle feature on/off.

(10) List

Moves to the list screen.

Using iPod Mode

Playing/Pausing iPod Songs

Once an iPod is connected, the mode will automatically start and begin playing an iPod song.



While playing, press the **TUNE** knob to pause and press again to play.

* NOTICE

- iPods with unsupported communication protocols may not properly operate in the audio system.

Changing Songs

Press the **SEEK**, **TRACK** keys to select the previous or next file.

* NOTICE

- Pressing the **TRACK** key after the song has been playing for 2 seconds will start the current song from the beginning.
- Pressing the **TRACK** key before the song has been playing for 1 seconds will start the previous song.
- Slight time differences may exist depending your iPod product.

Rewinding / Fast-forwarding Songs

While playing, press and hold the **SEEK**, **TRACK** keys (over 0.8 seconds) to rewind or fast-forward the current song.

Searching Categories

Use the **TUNE** knob to search categories and press the knob to select.

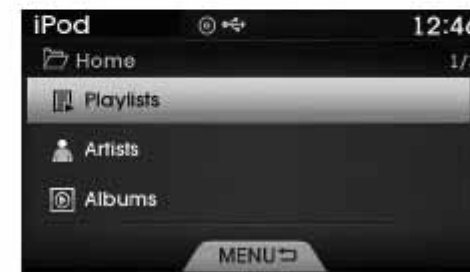

If you press the **MENU** key within the Category Menu, This button is used to move to the previous category.

* NOTICE

- There are eight categories that can be searched, including Playlists, Artists, Albums, Genres, Songs, Composers, Audiobooks and Podcasts.
- If the search mode is accessed while playing a song, the most recently searched category is displayed.
- Search steps upon initial connection may differ depending on the type of iPod device.

Features of your vehicle

iPod Mode Menu

If you press the **MENU** key, you will have access to the Repeat, Shuffle and List features.



Repeat

Press the **MENU** key ▶ Select **Repeat**

- Repeat Once : Repeats the current song.

Shuffle

Press the **MENU** key ▶ Select **Shuffle**

- Shuffle Album : Plays songs within the current category in random order.
- Shuffle All : Plays all songs in Random order.

List

Press the **MENU** key ▶ Select **List**

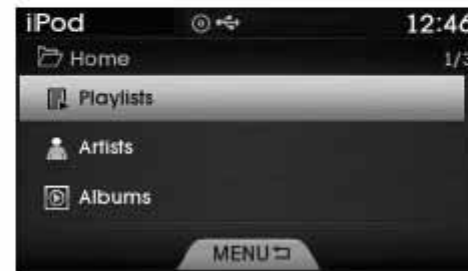

Press the **TUNE** knob to search for the desired file and press the **TUNE** knob to select.

AUX MODE

Using AUX Mode

Press the **MEDIA** key ▶ Select [AUX]



An external device can be connected to play music.

*** NOTICE**

- If an external device connector is connected with the AUX terminal, then AUX mode will automatically operate. Once the connector is disconnected, the previous mode will be restored.
- AUX mode can be used only when an external audio player (camcorder, car VCR, etc.) has been connected.
- The AUX volume can be controlled separately from other audio modes.

⚠ CAUTION

- *Connecting a connector jack to the AUX terminal without an external device will convert the system to AUX mode, but only output noise. When an external device is not being used, also remove the connector jack.*
- *When the external device power is connected to the power jack, playing the external device may output noise. In such cases, disconnect the power connection before use.*
- *Fully insert the AUX cable to the AUX jack upon use.*

Connecting an External Device



External audio players (Camcorders, car VCR, etc.) can be played through a dedicated cable.

MY MUSIC MODE

Basic Mode Screen



(1) Mode

Displays currently operating mode.

(2) Operation State

From Repeat / Shuffle / Scan, displays the currently operating function.

(3) File Index

Displays the current file/total number of files.

(4) File Info

Displays information about the current file.

(5) Play State

Displays the play/pause state.

(6) Play Time

Displays the current play time.

(7) MENU

Displays the My Music Menu

(8) Repeat

Turns the Repeat feature on/off.

(9) Shuffle

Turns the Shuffle feature on/off.

(10) List

Moves to the list screen.

(11) Info

Displays detailed information for the current file.

(12) Delete

Deletes the current file.

Using My Music Mode

Playing/Pausing My Music Files



While playing, press the **TUNE** knob to pause and press again to play.

* NOTICE

If there are no files saved within My Music, the **My Music** button will be disabled.

Changing Files

Press the **SEEK**, **TRACK** keys to select the previous or next file.

* NOTICE

- Pressing the **TRACK** key after the file has been playing for 2 seconds will start the current file from the beginning.
- Pressing the **TRACK** key before the file has been playing for 1 second will start the previous file.

Selecting from the List

Press the **TUNE** knob to search and select desired files.

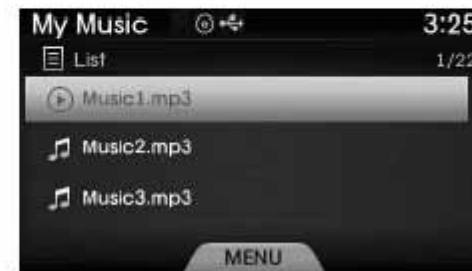

Once you find the desired file, press the **TUNE** knob to start playing.

Rewinding / Fast-forwarding Files

While playing, press and hold the **SEEK**, **TRACK** keys (over 0.8 seconds) to rewind or fast-forward the current file.

Scan

Press the **SCAN** key to play the first 10 seconds of each file.

My Music Mode Menu

If you press the **MENU** key, you will have access to the Repeat, Shuffle, List, Info and Delete features.

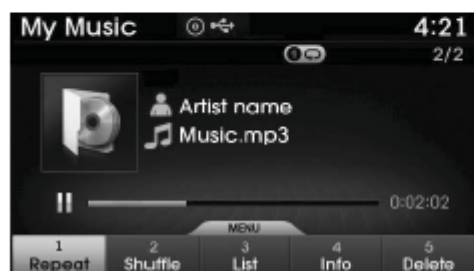

Repeat

Press the **MENU** key ▶ Select **Repeat**
Repeat : Repeats the current file.

Shuffle

Press the **MENU** key ▶ Select **Shuffle**
Shuffle : Plays all files in random order.

* NOTICE

The **1**, **2** keys are shortcut keys to set the Repeat and Shuffle features.

List

Press the **MENU** key ▶ Select **List**

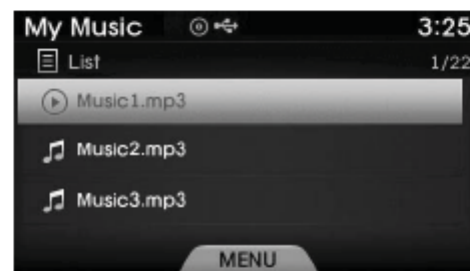

Press the **TUNE** knob to search for the desired file and press the **TUNE** knob to select.

Info

Press the **MENU** key ▶ Select **Info**
Details for the currently playing file are displayed.

* NOTICE

The title, artist and album info are displayed only when such information is recorded within the MP3 file ID3 tag.

Deleting Files

Press the **MENU** key ▶ Select **Delete**
The currently playing file is deleted.

List Menu

From the List screen ▶ Press the **MENU** ▶ Select [Edit].

Files saved in My Music can be selected and deleted.

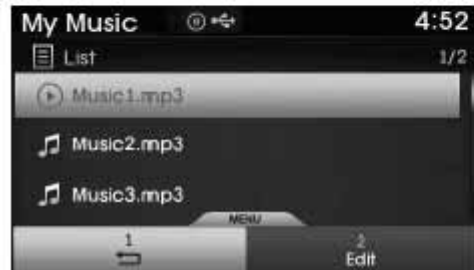

Use **TUNE** knob and the **TUNE** knob to search and select files you want to delete and select the **Delete** button from the Menu.



- (1) : Moves to the previous screen
- (2) Select All: Selects all files
- (3) Unselect All: Deselects all selected files
- (4) Delete: Deletes selected files

* NOTICE

- If there is memory available, up to 6,000 files can be saved.
- Identical files cannot be copied more than 1,000 times.
- To check memory information, go to **SETUP** ▶ [System] ▶ [Memory Information]



Bluetooth® Wireless Technology AUDIO MODE

Using Bluetooth® Wireless Technology Audio Mode

Playing/Pausing Bluetooth® Wireless Technology Audio

Once a *Bluetooth®* Wireless Technology device is connected, the mode will automatically start.



While playing, press the  TUNE knob to pause and press  TUNE knob to play.

*** NOTICE**

The play/pause feature may operate differently depending on the mobile phone.

Changing Files

Press the ,  key to move to the previous or next file.

Setting Connection

If a *Bluetooth®* Wireless Technology device has not been connected, press the  key ▶[Phone] button to display the *Bluetooth®* Wireless Technology connection screen.

It is possible to use the pair phone, connect/disconnect and delete features from your *Bluetooth®* Wireless Technology phone.

*** NOTICE**

- If music is not yet playing from your mobile device after converting to *Bluetooth®* Wireless Technology Audio mode, pressing the play button once may start playing the mode. Check to see that music is playing from the *Bluetooth®* Wireless Technology device after converting to *Bluetooth®* Wireless Technology Audio Mode.

Pairing a *Bluetooth*[®] Wireless Technology Device

What is Bluetooth[®] Wireless Technology Pairing?

Pairing refers to the process of synchronizing your *Bluetooth*[®] Wireless Technology phone or device with the car audio system for connection. Pairing is necessary to connect and use the *Bluetooth*[®] Wireless Technology feature.

Pairing **PHONE** Key / Key on the Steering Remote Controller

When No Devices have been Paired

1. Press the **PHONE** key or the  key on the steering remote controller. The following screen is displayed.
2. Select the **OK** button to enter the Pair Phone screen.

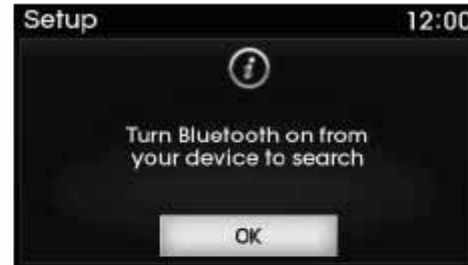



- 1) Car Name : Name of device as shown when searching from your *Bluetooth*[®] Wireless Technology device
- 2) Passkey : Passkey used to pair the device
3. From your *Bluetooth*[®] Wireless Technology device (i.e. Mobile Phone), search and select your car audio system.

4. After a few moments, a screen is displayed where the passkey is entered.

Hear, enter the passkey "0000" to pair your *Bluetooth*® Wireless Technology device with the car audio system.

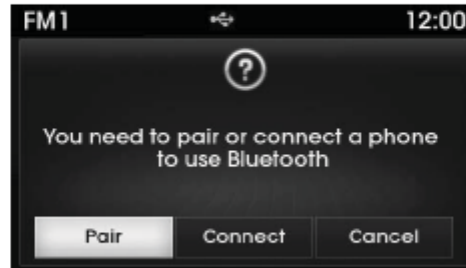
*** NOTICE**



If *Bluetooth*® Wireless Technology devices are paired but none are currently connected, pressing the **PHONE** key or the  key on the steering wheel displays the following screen. Press the [Pair] button to pair a new device or press the [Connect] to connect a previously paired device.

Pairing through [PHONE] Setup

Press the **SETUP** key ▶ Select [Phone] ▶ Select [Pair Phone] ▶ Select  TUNE knob

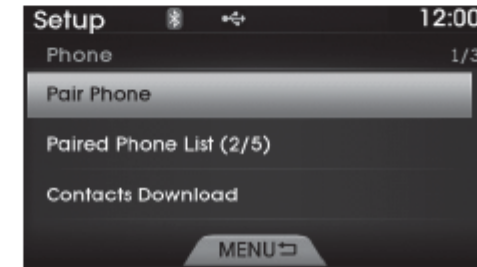

1. The following steps are the same as those described in the section "When No Devices have been Paired" on the previous page.

*** NOTICE**

- *Bluetooth*® Wireless Technology features supported within the vehicle are as follows. Some features may not be supported depending on your *Bluetooth*® Wireless Technology device.
 - Outgoing/Incoming Handsfree calls
 - Operations during a call (Switch to Private, Switch to call waiting, MIC on/off)
 - Downloading Call History
 - Downloading Mobile Contacts
 - *Bluetooth*® Wireless Technology device auto connection
 - Bluetooth Audio Streaming
- Up to five *Bluetooth*® Wireless Technology devices can be paired to the Car Handsfree system.
- Only one *Bluetooth*® Wireless Technology device can be connected at a time.
- Other devices cannot be paired while a *Bluetooth*® Wireless Technology device is connected.
- Only *Bluetooth*® Wireless Technology Handsfree and Bluetooth audio related features are supported.
- Bluetooth related operations are possible only within devices that support Handsfree or audio features, such as a *Bluetooth*® Wireless Technology mobile phone or a Bluetooth audio device.
- If a connected *Bluetooth*® Wireless Technology device becomes disconnected due to being out of communication range, turning the device OFF, or a *Bluetooth*® Wireless Technology communication error, corresponding *Bluetooth*® Wireless Technology devices are automatically searched and reconnected.
- If the system becomes unstable due to communication errors between the car Handsfree and the *Bluetooth*® Wireless Technology device, reset the device by turning off and back on again. Upon resetting *Bluetooth*® Wireless Technology device, the system will be restored.
- After pairing is complete, a contacts download request is sent once to the mobile phone. Some mobile phones may require confirmation upon receiving a download request, ensure your mobile phone accepts the connection. Refer to your phones user's manual for additional information regarding phone pairing and connections.

Connecting a Device

Press the **SETUP** key ▶ Select [Phone] ▶ Select [Paired Phone List]

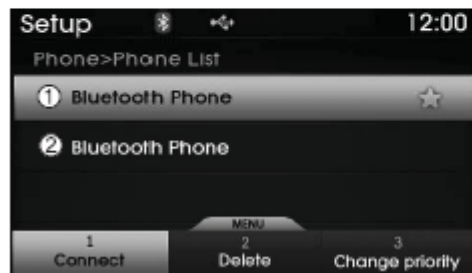

- 1) Connected Phone : Device that is currently connected
- 2) Paired Phone : Device that is paired but not connected

From the paired phone list, select the device you want to connect and Select the **Connect** button.

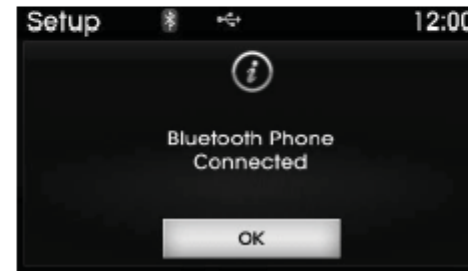

Changing Priority

What is Priority?

It is possible to pair up to five *Bluetooth*® Wireless Technology devices with the car audio system. The "Change Priority" feature is used to set the connection priority of paired phones.

Press the **SETUP** key ▶ Select [Phone] ▶ Select [Paired Phone List]



From the paired phone list, select the phone you want to switch to the highest priority, then select the **Change priority** button from the Menu. The selected device will be changed to the highest priority.

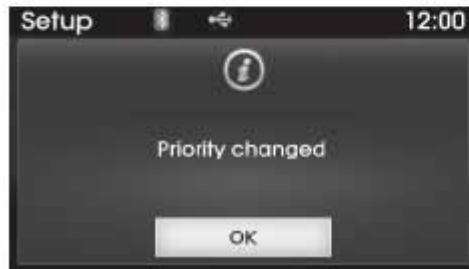

*** NOTICE**

Priority icon will be displayed when the selected phone is set as a priority phone.



Disconnecting a Device

Press the **SETUP** key ▶ Select [Phone] ▶ Select [Paired Phone List]



From the paired phone list, select the currently connected device and select the **Disconnect** button.

Deleting a Device

Press the **SETUP** key ▶ Select [Phone] ▶ Select [Paired Phone List]



From the paired phone list, select the device you want to delete and select the **Delete** button.

* NOTICE

- When deleting the currently connected device, the device will automatically be disconnected to proceed with the deleting process.
- If a paired *Bluetooth*[®] Wireless Technology device is deleted, the device's call history and contacts data will also be deleted.
- To re-use a deleted device, you must pair the device again.

USING *Bluetooth*® Wireless Technology

Phone Menu Screen

Phone Menus

With a *Bluetooth*® Wireless Technology device connected, press the **PHONE** key to display the Phone menu screen.



- 1) Dial Number : Displays the dial screen where numbers can be dialed to make calls
- 2) Call History : Device the call history list screen
- 3) Contacts : Displays the Contacts list screen

- 4) Setup : Displays Phone related settings.

* NOTICE

- If you press the [Call History] button but there is no call history data, a prompt is displayed which asks to download call history data.
- If you press the [Contacts] button but there is no contacts data stored, a prompt is displayed which asks to download contacts data.
- This feature may not be supported in some mobile phones. For more information on download support, refer to your mobile phone user's manual.

Calling by Dialing a Number

Press the **PHONE** key ▶ Select [Dial Number]



- 1) Dial Pad : Used to enter phone number
- 2) Call : If a number has been entered, calls the number. If no number has been entered, switches to call history screen
- 3) End : Deletes the entered phone number
- 4) Delete : Deletes entered numbers one digit at a time

Answering Calls

Answering a Call

Answering a call with a *Bluetooth®* Wireless Technology device connected will display the following screen.

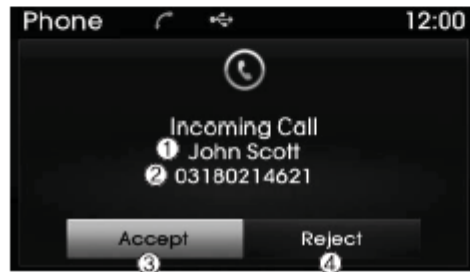

- 1) Caller : Displays the other party's name when the incoming caller is saved within your contacts
- 2) Incoming Number : Displays the incoming number
- 3) Accept : Accept the incoming call
- 4) Reject : Reject the incoming call

* NOTICE

- When an incoming call pop-up is displayed, most Audio and SETUP mode features are disabled. Only the call volume will operate.
- The telephone number may not be properly displayed in some mobile phones.
- When a call is answered with the mobile phone, the call mode will automatically revert to Private mode.

During a Handsfree Call

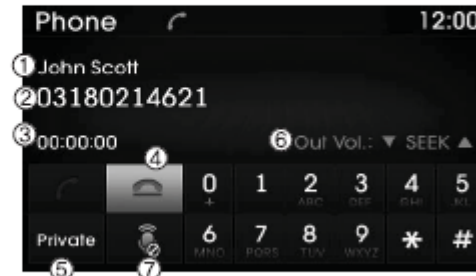

- 1) Caller : Displays the other party's name if the incoming caller is saved within your contacts
- 2) Incoming Number : Displays the incoming number
- 3) Call time : Displays the call time
- 4) End : Ends call
- 5) Private : Converts to Private mode
- 6) Out Vol. : Sets call volume as heard by the other party
- 7) Mute : Turns Mic Mute On/Off

* NOTICE

If the mic is muted, the other party will not be able to hear your voice.

Call History

Press the **PHONE** key ▶ Select [Call History]



A list of incoming, outgoing and missed calls is displayed.

Select the **Download** button to download the call history.

1) Call History :

- Displays recent calls (call history)
- Connects call upon selection

2) Download : Download Recent Call History

- Call history may not be saved in the call history list in some mobile phones.

- Calls received with hidden caller ID will not be saved in the call history list.
- Calling through the call history is not possible when there is no call history stored or a *Bluetooth*® Wireless Technology phone is not connected.
- Up to 20 received, dialed and missed calls are stored in Call History.
- Time of received/dialed calls and call time information are not saved.

Contacts

Press the **PHONE** key ▶ Select [Contacts]



The list of saved phone book entries is displayed. Select the **Download** button to download the call history.

1) Contacts List :

- Displays downloaded contacts entries
- Connects call upon selection

2) Download : Download contacts entries

*** NOTICE**

- Up to 1,000 contacts saved in your *Bluetooth*® Wireless Technology phone can be downloaded into the car contacts. Contacts that have been downloaded to the car cannot be edited or deleted on the phone.
- Mobile phone contacts are managed separately for each paired *Bluetooth*® Wireless Technology device (max 5 devices x 1,000 contacts each). Previously downloaded data is maintained even if the *Bluetooth*® Wireless Technology device has been disconnected. (However, the contacts and call history saved to the phone will be deleted if a paired phone is deleted.)
- It is possible to download contacts during Bluetooth streaming audio.
- When downloading contacts, the icon will be displayed within the status bar.
- It is not possible to begin downloading a contact list when the contact download feature has been turned off within the *Bluetooth*® Wireless Technology device. In addition, some devices may require device authorization upon attempting to download contacts. If downloading does not normally occur, check the *Bluetooth*® Wireless Technology device settings or the screen state.
- The contacts download feature may not be supported in some mobile phones. For more information of supported *Bluetooth*® devices and function support, refer to your phone's user manual.

VOICE RECOGNITION

Using Voice Recognition

Starting Voice Recognition

Shortly press the  key on the steering wheel remote controller. Say a command.

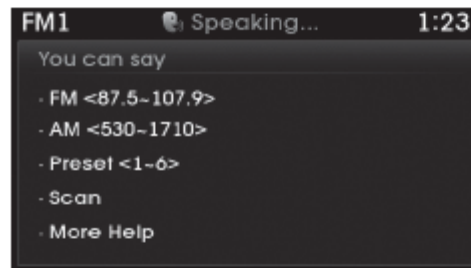

If prompt feedback is in [ON], then the system will say "Please say a command after the beep (BEEP)"

- If prompt feedback is in [OFF] mode, then the system will only say "(BEEP)"
- To change Prompt Feedback [On]/[Off], go to **SETUP** ▶ [System] ▶ [Prompt Feedback]

* NOTICE

For proper recognition, say the command after the voice instruction and beep tone.

Contact List Best Practices

- 1) Do not store single-name entries (e.g., "Bob", "Mom", "Kim", etc.). Instead, always use full names (including first and last names) for all contacts (e.g., use "Jacob Stevenson" instead of "Dad").
- 2) Do not use abbreviations (i.e., use "Lieutenant" instead of "Lt." or "Sergeant" instead of "Sgt.").
- 3) Do not use acronyms (i.e., use "County Finance Department" instead of "CFD").

- 4) Do not use special characters (e.g., "@", "hyphen -", "asterisk *", "ampersand &").
- 5) If a name is not recognized from the contact list, change it to a more descriptive name (e.g., use "Grandpa Joseph" instead of "Pa Joe").

Skipping Prompt Messages

While prompt message is being stated ▶ Shortly press the  key on the steering remote controller

The prompt message is immediately ended and the beep tone will sound. After the "beep", say the voice command.

Re-starting Voice Recognition

While system waits for a command ▶ Shortly press the  key on the steering remote controller

The command wait state is immediately ended and the beep tone will sound. After the "beep", say the voice command.

Features of your vehicle

※ Illustration on using voice commands

• **Starting voice command.**

Shortly pressing the  key (under 0.8 seconds):

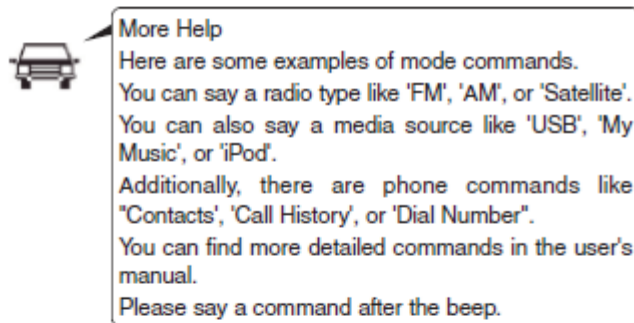
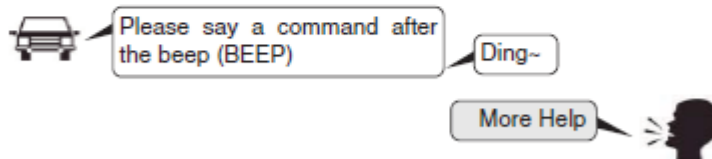

• **Skipping Voice Recognition**

Shortly pressing the  key (under 0.8 seconds):

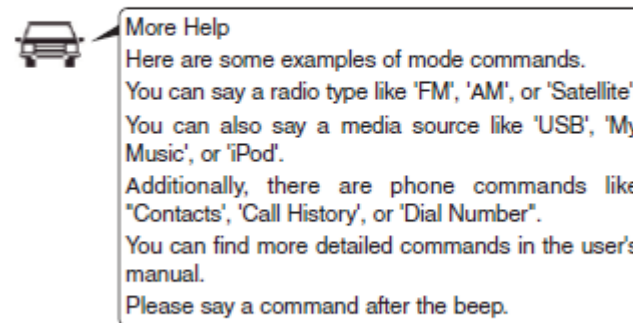
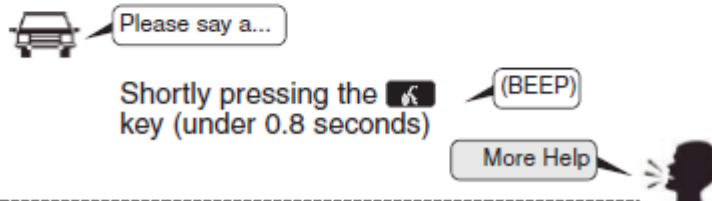

• **End voice command.**

Shortly pressing the  key (under 0.8 seconds):

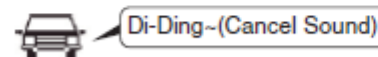
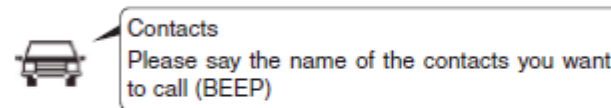
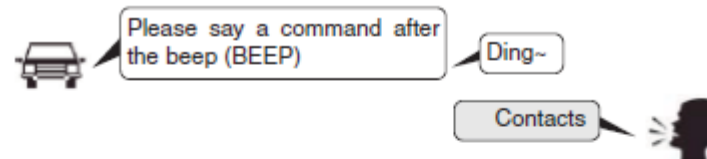

USING SETUP

Starting Mode

Press the **SETUP** key to display the Setup screen.

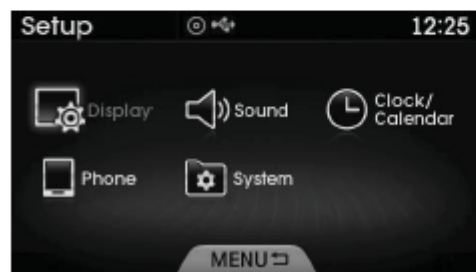

You can select and control options related to [Display], [Sound], [Clock / Calendar], [Phone] and [System].

* NOTICE

Once settings have been changed, press the **MENU** key to return to the previous menu.

Display Settings

Adjusting the Brightness

Press the **SETUP** key ▶ Select [Display] ▶ Select [Brightness]

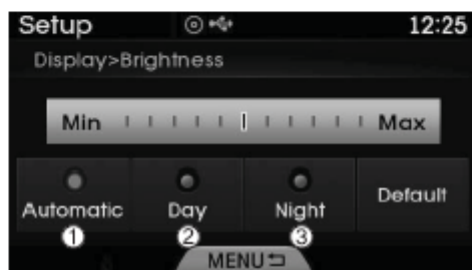

Use the **TUNE** knob to adjust the screen brightness or set the Brightness on Automatic, Daylight, or Nightmode.

- (1) Automatic : Adjusts the brightness automatically
- (2) Day : Always maintains the brightness on high
- (3) Night : Always maintains the brightness on low

Mode Pop-up

Press the **SETUP** key ▶ Select [Display] ▶ Select [Mode Pop up]

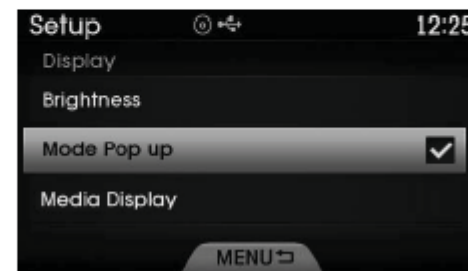

This feature is used to display the Mode Pop-up screen when entering radio and media modes.

When this feature is turned on, pressing the **RADIO** or **MEDIA** key will display the Mode Pop-up screen.

* NOTICE

The media Mode Pop-up screen can be displayed only when two or more media modes have been connected.

MP3 Information Display

Press the **SETUP** key ▶ Select [Display]
▶ Select [Media Display]



This feature is used to change the information displayed within USB and MP3 CD modes.

- (1) Folder File : Displays file name and folder name
- (2) Album Artist Song : Displays album name/artist name/song

Sound Settings

Sound Settings

Press the **SETUP** key ▶ Select [Sound]
▶ Select [Sound Setting]



Use **TUNE** knob to adjust the Bass/Middle/Treble and Fader/ Balance settings.

After selecting the Bass / Middle / Treble, use the **TUNE** knob to adjust the settings.

After selecting the Fader / Balance, use the **TUNE** knob to move the cursor on the control screen to the desired position.

SDVC (Speed Dependent Volume Control)

Press the **SETUP** key ▶ Select [Sound] ▶ Select [Speed Dependent Vol.]



The volume level is controlled automatically according to the vehicle speed.

Use the **TUNE** knob to select from On/Off.

Voice Recognition Setting

Press the **SETUP** key ▶ Select [Sound] ▶ Select [Voice Recognition Vol.]



Use the **TUNE** knob to adjust the Voice Recognition volume.

Blue Link Volume

Press the **SETUP** key ▶ Select [Sound] ▶ Select [Blue Link Voice Vol.]

Use the **TUNE** knob to adjust the Blue Link Voice Recognition volume.



*** NOTICE**

This feature may not be available depending on whether your device supports Blue Link.

Clock/Calendar Setting

Clock Setting

Press the **SETUP** key ▶ Select [Clock/Calendar] ▶ Select [Clock Settings]

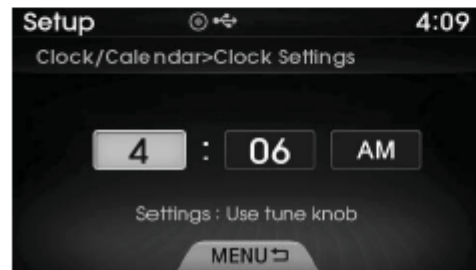

Use the **TUNE** knob to select the Hour, Minutes and AM/PM setting and use **TUNE** knob to change settings.

Calendar Setting

Press the **SETUP** key ▶ Select [Clock/Calendar] ▶ Select [Calendar Settings]

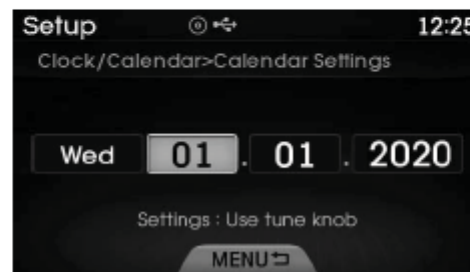

Use the **TUNE** knob to select the Month, Day, and Year and use **TUNE** knob to change settings.

Time Format

Press the **SETUP** key ▶ Select [Clock/Calendar] ▶ Select [Time Format]

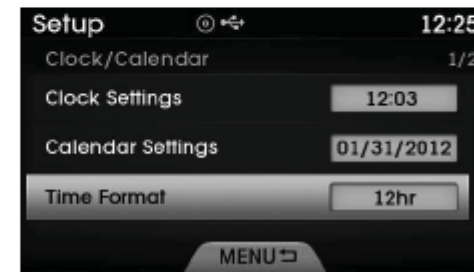

This feature is used to change the clock format between 12hr or 24hr.

Clock Display

Press the **SETUP** key ▶ Select [Clock/Calendar] ▶ Select [Clock Display (Power off)]

This feature is used to display a clock on the screen when the audio system is turned off.

Bluetooth® Wireless Technology Setting

Pairing a New Device

Press the **SETUP** key ▶ Select [Phone] ▶ Select [Pair Phone]



Bluetooth® Wireless Technology devices can be paired with the audio system.

For more information, refer to the "Pairing through Phone Setup" section within Bluetooth® Wireless Technology.

Viewing Paired Phone List

Press the **SETUP** key ▶ Select [Phone] ▶ Select [Paired Phone List]



This feature is used to view mobile phones that have been paired with the audio system. Upon selecting a paired phone, the setup menu is displayed.

For more information, refer to the "Setting Bluetooth® Wireless Technology Connection" section within Bluetooth® Wireless Technology.

1) Connect/Disconnect Phone : Connect/ disconnects currently selected phone

2) Delete : Deletes the currently selected phone

3) Change Priority : Sets currently selected phone to highest connection priority

* NOTICE BEFORE DOWNLOADING CONTACTS

- Only contacts within connected phones can be downloaded. Also check to see that your mobile phone supports the download feature.
- To learn more about whether your mobile phone supports contacts downloads, refer to your mobile phone user's manual.
- The contacts for only the connected phone can be downloaded.

Downloading Contacts

Press the **SETUP** key ▶ Select [Phone] ▶ Select [Contacts Download]

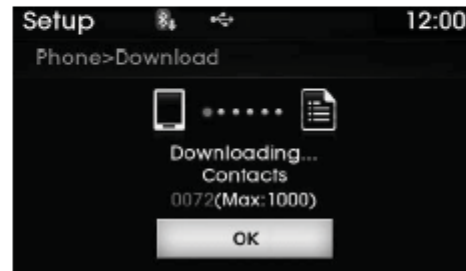

As the contacts are downloaded from the mobile phone, a download progress bar is displayed.

* NOTICE

- Upon downloading phone contacts, the previous corresponding data is deleted.
- This feature may not be supported in some mobile phones.
- Voice Recognition may not operate while contacts are being downloaded.

Auto Download (Contacts)

Press the **SETUP** key ▶ Select [Phone] ▶ Select [Auto Download]

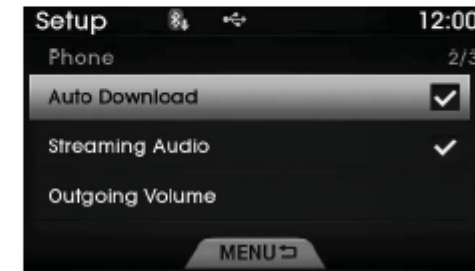

This feature is used to automatically download mobile contacts entries once a *Bluetooth*® Wireless Technology phone is connected.

* NOTICE

- The Auto Download feature will download mobile contacts entries every time the phone is connected. The download time may differ depending on the number of saved contacts entries and the communication state.
- Before downloading contacts, first check to see that your mobile phone supports the contacts download feature.

Features of your vehicle

Streaming Audio

Press the **SETUP** key ▶ Select [Phone] ▶ Select [Streaming Audio]



When Streaming Audio is turned on, you can play music files saved in your *Bluetooth*® Wireless Technology device through the audio system.

Outgoing Volume

Press the **SETUP** key ▶ Select [Phone] ▶ Select [Outgoing Volume]



Use **FOLDER** , **FOLDER** keys to adjust the outgoing volume level.

* NOTICE

While on a call, the volume can be changed by using the **SEEK** , **TRACK** key.

Turning Bluetooth System Off

Press the **SETUP** key ▶ Select [Phone] ▶ Select [Bluetooth System Off]

Once *Bluetooth*® Wireless Technology is turned off, *Bluetooth*® Wireless Technology related features will not be supported within the audio system.



*** NOTICE**

To turn *Bluetooth*[®] Wireless
Technology back on, go to **SETUP** ▶
[Phone] and press “Yes”.

System Setting

Memory Information

Press the **SETUP** key ▶ Select [System] ▶ Select [Memory Information]



This feature displays information related to system memory.

- (1) Using : Displays capacity currently in use
- (2) Capacity : Displays total capacity

Voice Recognition Mode Setting

Press the **SETUP** key ▶ Select [System] ▶ Select [Prompt Feedback]

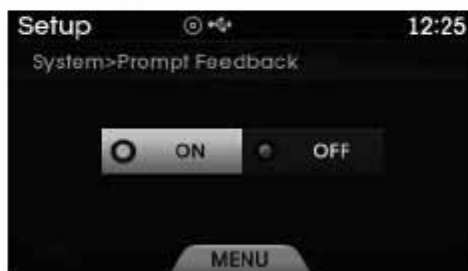

This feature is used to select the desired prompt feedback option from Normal and Expert.

- (1) ON : When using voice recognition, provides detailed guidance prompts
- (2) OFF : When using voice recognition, omits some guidance prompts

Language

Press the **SETUP** key ▶ Select [System] ▶ Select [Language]



This feature is used to change the system and voice recognition language.

If the language is changed, the system will restart and apply the selected language.

REAR VIEW CAMERA (if equipped)

- The system has been equipped with a rear view camera for user safety by allowing a wider rear range of vision.
- The rear view camera will automatically operate when the ignition key is turned ON and the transmission lever is set to R.
- The rear view camera will automatically stop operating when set to a different lever.

CAUTION

The rear view camera has been equipped with an optical lens to provide a wider range of vision and may appear different from the actual distance. For safety, directly check the rear and left/right sides.

Appendix Homologation

FCC Compliance Statement.

This device complies with part 15 of the FCC Rules.
Operation is subject to the following two conditions :

- (1) This device may not cause harmful interference, and
- (2) This device must accept any interference received, including interference that may cause undesired operation.

This equipment generates, uses and can radiate radio frequency energy and, if not installed and used in accordance with the instructions, may cause harmful interference to radio communications. However, there is no guarantee that interference will not occur in a particular installation. If this equipment does cause harmful interference to radio or television reception, which can be determined by turning the equipment off and on, the user is encouraged to try to correct the interference by one or more of the following measures:

- Reorient or relocate the receiving antenna.
- Increase the separation between the equipment and receiver.
- Connect the equipment into an outlet on a circuit different from that to which the receiver is connected.
- Consult the dealer or an experienced radio/TV technician for help.

Do Not



Any changes or modifications to the equipment not expressly approved by the party responsible for compliance could void user's authority to operate the equipment.

Be sure

The antenna(s) used for this device must be installed to provide a separation distance of at least 20 cm from all persons and must not be co-located or operating in conjunction with any other antenna or transmitter.

IC Compliance Statement.

This device complies with Industry Canada licence-exempt RSS standard(s).
Operation is subject to the following two conditions:
(1) this device may not cause interference, and
(2) this device must accept any interference, including interference that may cause undesired operation of the device.

Le présent appareil est conforme aux CNR d'Industrie Canada applicables aux appareils radio exempts de licence. L'exploitation est autorisée aux deux conditions suivantes :

- (1) l'appareil ne doit pas produire de brouillage, et
- (2) l'utilisateur de l'appareil doit accepter tout brouillage radioélectrique subi, même si le brouillage est susceptible d'en compromettre le fonctionnement.