

YD AUDIO\_A TYPE  
FCC ID: TQ8-AM1A1B0AN  
IC: 5074A-AM1A1B0KN

## Features of your vehicle

### Caring for disc

- If the temperature inside the car is too high, open the car windows to ventilate before using the system.
- It is illegal to copy and use MP3/WMA files without permission. Use CDs that are created only by lawful means.
- Do not apply volatile agents, such as benzene and thinner, normal cleaners and magnetic sprays made for analogue disc onto CDs.
- To prevent the disc surface from getting damaged, hold CDs by the edges or the center hole only.
- Clean the disc surface with a piece of soft cloth before playback (wipe it from the center to the outside edge).
- Do not damage the disc surface or attach pieces of sticky tape or paper.
- Make certain only CDs are inserted into the CD player (Do not insert more than one CD at a time).
- Keep CDs in their cases after use to protect them from scratches or dirt.

## Features of your vehicle

- Depending on the type of CD-R/CD-RW CDs, certain CDs may not operate normally according to the manufacturing companies. In such circumstances, continued use may cause malfunctions to your audio system.

### \* NOTICE

#### - Playing an Incompatible Copy Protected Audio CD

Some copy protected CDs, which do not comply with international audio CD standards (Red Book), may not play on your car audio. Please note that inability to properly play a copy protected CD may indicate that the CD is defective, not the CD player.

### NOTE:

#### Order of playing files (folders) :

1. Song playing order : ① to ⑭

2. Folder playing order :

\* If no song file is contained in the folder, that folder is not displayed.

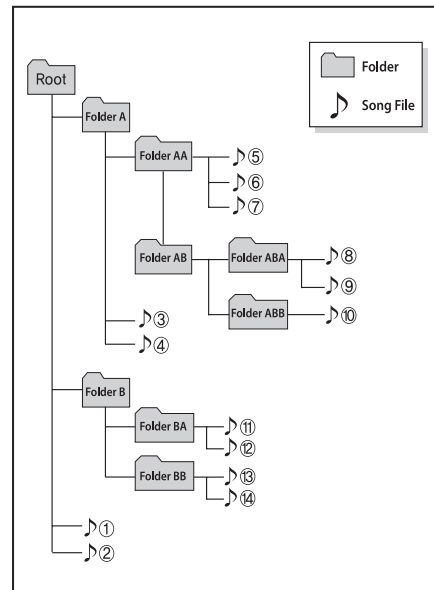
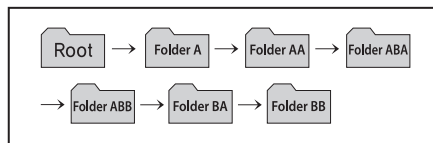

**⚠ WARNING - Driver  
Distraction**

- Do not stare at the screen while driving. Staring at the screen for prolonged periods of time could lead to traffic accidents.
- Using the phone while driving may lead to a lack of attention of traffic conditions and increase the likelihood of accidents. Use the phone feature after parking the vehicle.

**⚠ WARNING - Audio  
System**

- Do not disassemble, assemble, or modify the audio system. Such acts could result in accidents, fire, or electric shock.
- Heed caution not to spill water or introduce foreign objects into the device. Such acts could lead to smoke, fire, or product malfunction.

**⚠ WARNING - Antenna**

Do not touch the antenna during thunder or lightening as such acts may lead to lightning induced electric shock.

**⚠ CAUTION**

*Refrain from use if the screen is blank or no sound can be heard as these signs may indicate a product malfunction.*

## Features of your vehicle

- Adjust the volume to levels that allow the driver to hear sounds from outside of the vehicle. Driving in a state where external sounds cannot be heard may lead to accidents.
- Pay attention to the volume setting when turning the device on. A sudden output of extreme volume upon turning the device on could lead to hearing impairment. (Adjust the volume to a suitable levels before turning off the device.)
- If you want to change the position of device installation, please inquire with your place of purchase or service maintenance center. Technical expertise is required to install or disassemble the device.
- Turn on the car ignition before using this device. Do not operate the audio system for long periods of time with the ignition turned off as such operations may lead to battery discharge.

### **CAUTION - LCD Monitor**

***Do not subject the device to severe shock or impact. Direct pressure onto the front side of the monitor may cause damage to the LCD or touch screen.***

### **CAUTION - Device cleaning**

- ***When cleaning the device, make sure to turn off the device and use a dry and smooth cloth.***
- ***Never use tough materials, chemical cloths, or solvents (alcohol, benzene, thinners, etc.) as such materials may damage the device panel or cause color/quality deterioration.***

***(Continued)***

***(Continued)***

- ***Prevent caustic solutions such as perfume and cosmetic oil from contacting the dashboard because they may cause damage or discoloration.***
- ***Placing the audio system within an electromagnetic environment may result in noise interference.***

### **\* NOTICE**

**In case of product malfunction, please contact your place of purchase or After Service center.**

**USING THE USB DEVICE**

- To use an external USB device, make sure the device is not connected when starting up the vehicle. Connect the device after starting up.
- If you start the engine when the USB device is connected, it may damage the USB device. (USB flashdrives are very sensitive to electric shock.)
- If the engine is started up or turned off while the external USB device is connected, the external USB device may not work.
- The System may not play unauthenticated MP3 or WMA files.
  - 1) It can only play MP3 files with the compression rate between 8Kbps ~ 320Kbps.
  - 2) It can only play WMA music files with the compression rate between 8Kbps ~ 320Kbps.
- Take precautions for static electricity when connecting or disconnecting the external USB device.

(Continued)

(Continued)

- An encrypted MP3 PLAYER is not recognizable.
- Depending on the condition of the external USB device, the connected external USB device can be unrecognizable.
- When the formatted byte/sector setting of External USB device is not either 512BYTE or 2048BYTE, then the device will not be recognized.
- Use only a USB device formatted to FAT 12/16/32.
- USB devices without USB I/F authentication may not be recognizable.
- Make sure the USB connection terminal does not come in contact with the human body or other objects.
- If you repeatedly connect or disconnect the USB device in a short period of time, it may break the device.

(Continued)

(Continued)

- You may hear a strange noise when connecting or disconnecting a USB device.
- If you disconnect the external USB device during playback in USB mode, the external USB device can be damaged or may malfunction. Therefore, disconnect the external USB device when the audio is turned off or in another mode. (e.g, Radio, CD)
- Depending on the type and capacity of the external USB device or the type of the files stored in the device, there is a difference in the time taken for recognition of the device.
- Do not use the USB device for purposes other than playing music files.
- Playing videos through the USB is not supported.
- Use of USB accessories such as rechargers or heaters using USB I/F may lower performance or cause trouble.

(Continued)

## Features of your vehicle

(Continued)

- If you use devices such as a USB hub purchased separately, the vehicle's audio system may not recognize the USB device. In that case, connect the USB device directly to the multimedia terminal of the vehicle.
- If the USB device is divided by logical drives, only the music files on the highest-priority drive are recognized by car audio.
- Devices such as MP3 Player/Cellular phone/Digital camera can be unrecognizable by standard USB I/F can be unrecognizable.
- Charging through the USB may not be supported in some mobile devices.
- USB HDD or USB types liable to connection failures due to vehicle vibrations are not supported. (i-stick type)
- Some non-standard USB devices (METAL COVER TYPE USB) can be unrecognizable.

(Continued)

(Continued)

- Some USB flash memory readers (such as CF, SD, micro SD, etc.) or external-HDD type devices can be unrecognizable.
- Music files protected by DRM (DIGITAL RIGHTS MANAGEMENT) are not recognizable.
- The data in the USB memory may be lost while using this audio. Always back up important data on a personal storage device.
- Please avoid using USB memory products which can be used as key chains or cellular phone accessories as they could cause damage to the USB jack. Please make certain only to use plug type connector products.



**USING THE iPod® DEVICE**

- Some iPod® models may not support communication protocol and files may not properly play.  
Supported iPod® models:
  - iPhone® 3GS/4
  - iPod® touch 1st~4th generation
  - iPod® nano 1st~6th generation
  - iPod® classic
- The order of search or playback of songs in the iPod® can be different from the order searched in the audio system.
- If the iPod® is disabled due to its own malfunction, reset the iPod®. (Reset: Refer to iPod® manual)
- An iPod® may not operate normally on low battery.

(Continued)

(Continued)

- Some iPod® devices, such as the iPhone®, can be connected through the *Bluetooth®* Wireless Technology interface. The device must have audio *Bluetooth®* Wireless Technology capability (such as for stereo headphone *Bluetooth®* Wireless Technology ). The device can play, but it will not be controlled by the audio system.
- To use iPod® features within the audio, use the cable provided upon purchasing an iPod® device.
- Skipping or improper operation may occur depending on the characteristics of your iPod®/iPhone® device.
- If your iPhone® is connected to both the *Bluetooth®* Wireless Technology and USB, the sound may not be properly played. In your iPhone®, select the Dock connector or *Bluetooth®* Wireless Technology to change the sound output (source).

(Continued)

(Continued)

- When connecting iPod® with the iPod® Power Cable, insert the connector to the multimedia socket completely. If not inserted completely, communications between iPod® and audio may be interrupted.
- When adjusting the sound effects of the iPod® and the audio system, the sound effects of both devices will overlap and might reduce or distort the quality of the sound.
- Deactivate (turn off) the equalizer function of an iPod® when adjusting the audio system's volume, and turn off the equalizer of the audio system when using the equalizer of an iPod®.
- When not using iPod® with car audio, detach the iPod® cable from iPod®. Otherwise, iPod® may remain in accessory mode, and may not work properly.
- Beside support 1M cable when purchasing iPod®/iPhone products, Long Cable cannot be recognized.

## Features of your vehicle

### Bluetooth® Wireless Technology

#### Bluetooth® Wireless Technology

The *Bluetooth*® word mark and logos are registered trademarks owned by Bluetooth SIG, Inc. and any use of such marks by Kia is under license.

A *Bluetooth*® enabled call phone is required to use *Bluetooth*® wireless technology.

#### **⚠ WARNING**

**Driving while distracted can result in a loss of vehicle control that may lead to an accident, severe personal injury, and death. The driver's primary responsibility is in the safe and legal operation of a vehicle, and use of any handheld devices, other equipment, or vehicle systems which take the driver's eyes, attention and focus away from the safe operation of a vehicle or which are not permissible by law should never be used during operation of the vehicle.**

### Before Using the Bluetooth® Handsfree

#### What is Bluetooth® ?

- *Bluetooth*® refers to a short-distance wireless networking technology which uses a 2.4GHz ~ 2.48GHz frequency to connect various devices within a certain distance.
- Supported within PCs, external devices, *Bluetooth*® phones, PDAs, various electronic devices, and automotive environments, *Bluetooth*® allows data to be transmitted at high speeds without having to use a connector cable.
- *Bluetooth*® Handsfree refers to a device which allows the user to conveniently make phone calls with *Bluetooth*® mobile phones through the audio system.
- *Bluetooth*® Handsfree may not be supported in some mobile phones. To learn more about mobile device compatibility, visit <http://www.kia.com/us/en/content/owners/bluetooth>.

### Precautions for Safe Driving

- *Bluetooth*® Handsfree is a feature that enables drivers to practice safe driving. Connecting the head unit with a *Bluetooth*® phone allows the user to conveniently make and receive calls and use contacts. Before using *Bluetooth*®, carefully read the contents of this user's manual.
- Excessive use or operations while driving may lead to negligent driving practices and result in accidents. Refrain from excessive operations while driving.
- Viewing the screen for prolonged periods of time is dangerous and may lead to accidents. When driving, view the screen only for short periods of time.



### When connecting a Bluetooth® Phone

- Before connecting the head unit with the mobile phone, check to see that the mobile phone supports Bluetooth® features.
  - Even if the phone supports Bluetooth®, the phone will not be found during device searches if the phone has been set to hidden state or the Bluetooth® power is turned off. Disable the hidden state or turn on the Bluetooth® power prior to searching/connecting with the Head unit.
  - Bluetooth phone is automatically connected when the ignition on.
  - If you do not want automatic connection with your Bluetooth® device, turn off the Bluetooth® feature within your mobile phone.
  - The Handsfree call volume and quality may differ depending on the mobile phone.
- Park the vehicle when connecting the head unit with the mobile phone.
  - Bluetooth® connection may become intermittently disconnected in some mobile phones. Follow these steps to try again.
    1. Within the mobile phone, turn the Bluetooth® function off/on and try again.
    2. Turn the mobile phone power Off/On and try again.
    3. Completely remove the mobile phone battery, reboot, and then again.
    4. Reboot the Audio System and try again.
    5. Delete all paired devices, pair and try again.

## Features of your vehicle

---

### Voice Recognition

- When using the voice recognition feature, only commands listed within the user's manual are supported.
- Be aware that during the operation of the voice recognition system, pressing any key other than the  key terminate voice recognition mode.
- For superior voice recognition performance, position the microphone used for voice recognition above the head of the driver's seat and maintain a proper position when saying commands.
- Within the following situations, voice recognition may not function properly due to external sound.
  - When the windows and sunroof are open
  - When the wind of the cooling / heating device is strong
  - When entering and passing through tunnels

(Continued)

(Continued)

- When driving on rugged and uneven roads
- During severe rain (heavy rains, windstorms)
- Phone related voice commands can be used only when a *Bluetooth*® Wireless Technology device is connected.
- When making calls by stating a name, the corresponding contact must be downloaded and stored within the audio system.
- After downloading the *Bluetooth*® Wireless Technology phone book, it takes some times to convert the phone book data into voice information. During this time, voice recognition may not properly operate.
- Pronounce the voice commands naturally and clearly as if in a normal conversation.

## Features of your vehicle

### SYSTEM CONTROLLERS AND FUNCTIONS

\* Display and settings may differ depending on the selected audio.

#### Audio Head Unit



(1)  (EJECT)  
Ejects the disc.

(2) **RADIO**

Changes to FM/AM/SiriusXM mode.

Each time the key is pressed, the mode is changed in order of FM1 → FM2 → AM → SAT1 → SAT2 → SAT3.

\* In Setup>Display, the radio pop up screen will be displayed when [Mode Pop up] is turned .



When the pop up screen is displayed, use the  TUNE knob or keys  ~  to select the desired mode.

(3) **MEDIA**

Changes to CD, USB(iPod®), AUX, My Music, BT Audio mode.

Each time the key is pressed, the mode is changed in order of CD, USB(iPod®), AUX, My Music, BT Audio.

\* In Setup>Display, the media pop up screen will be displayed when [Mode Pop up] is turned .

When the pop up screen is displayed, use the  TUNE knob or keys  ~  to select the desired mode.

(4) **PHONE**

Operates Phone Screen

\* When a phone is not connected, the connection screen is displayed.

(5) 

Radio Mode : Automatically searches for broadcast frequencies.

CD, USB, iPod®, My Music modes

- Shortly press the key (less than 1 second): Moves to next or previous song (file)

- Press and hold the key (more than 1 second): Rewinds or fast-forwards the current song.

BT Audio mode : Moves to next or previous song(file)

\* The Play/Pause feature may operate differently depending on the mobile phone.

(6) PWR/VOL knob

 Power : Turns power On/Off by pressing the knob

 Volume : Sets volume by turning the knob left/right

## Features of your vehicle

### (7) **DISP**

Each time the button is shortly pressed (less than 1 second), it sets the screen Off → Screen On → Screen Off

\* Audio operation is maintained and only the screen will be turned Off. In the screen Off state, press any key to turn the screen On again.

### (8) **SCAN**

Radio Mode

- Shortly press the key : Previews each broadcast for 5 seconds each.

- Press and hold the key (more than 1 second): Previews the broadcasts saved in Preset **1** ~ **6** for 5 seconds each.

\* Press the **SCAN** key again to continue listening to the current frequency.

\* SAT Radio does not support the Preset scan feature.

CD, USB, My Music mode

- Shortly press the key (less than 1 second): Previews each song (file) for 10 seconds each.

\* Press the **SCAN** key again to continue listening to the current song (file).

### (9) **SETUP**

Moves to the Display, Sound, Phone, System setting modes.

### (10) **MENU**

Displays menus for the current mode.

\* iPod® List : Move to parent category

### (11) **CAT FOLDER**

Radio Mode

- SiriusXM RADIO : Category Search  
MP3 CD, USB mode : Folder Search

### (12) **TUNE** knob

Radio mode : Changes frequency by turning the knob left/right.

CD, USB, iPod®, My Music mode: Searches songs (files) by turning the knob left/right.

\* When the desired song is displayed, press the knob to play the song.

Moves focus in all selection menus and selects menus.

## Features of your vehicle

---

### (13) **1** ~ **6** (Preset)

Radio Mode: Saves frequencies (channels) or receives saved frequencies (channels)

CD, USB, iPod®, My Music mode

- **1** : Repeat

- **2** : Random

In the Radio, Media, Setup, and Menu pop up screen, the number menu is selected.

### (14) **FM/AM**

Changes to FM/AM mode.

Each time the key is pressed, the mode is changed in order of FM1 → FM2 → AM.

### (15) **SAT**

Changes to SiriusXM Satellite Radio mode.

Each time the key is pressed, the mode is changed in order of SAT1 → SAT2 → SAT3.

## SETUP

### Display Settings

Press the **SETUP** key ▶ Select [Display] through **TUNE** knob or **1** key ▶ Select menu through **TUNE** knob



### Mode Pop up

[Mode Pop up] ▶ Changes **On**/**Off** selection mode

- During On state, press the **RADIO** or **MEDIA** key to display the mode change pop up screen.

### Media Display

When playing an MP3 file, select the desired display info from 'Folder/File' or 'Album/Artist/Song'.



## Features of your vehicle

### SOUND SETTINGS

Press the **SETUP** key ▶ Select [Sound] through **TUNE** knob or **2** key ▶ Select menu through **TUNE** knob



#### Tone

This menu allows you to set the Bass, Middle, Treble.

Select [Tone] ▶ Select menu through **TUNE** knob ▶ Turn **TUNE** knob left/right to set

- Bass, Middle, Treble : Selects the sound tone.
- Default : Restores default settings.
- \*Return : While adjusting values, pressing the **TUNE** knob will restore the parent menu.

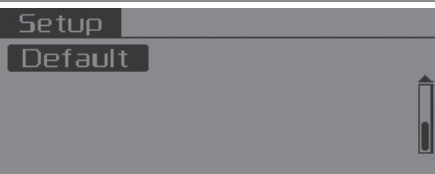

#### Position

This menu allows you to set the Fader, Balance.

Select [Position] ▶ Select menu through **TUNE** knob ▶ Turn **TUNE** knob left/right to set

- Fader, Balance : Selects the sound fader and balance.
- Default : Restores default settings.
- \*Return : While adjusting values, pressing the **TUNE** knob will restore the parent menu.

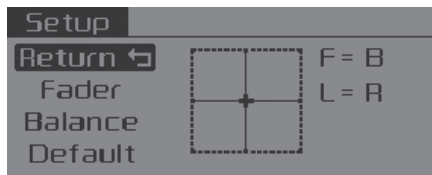

#### Speed Dependent Volume Control

This feature is used to automatically control the volume level according to the speed of the vehicle.

Select [Speed Dependent Vol.] ▶ Set [Off/On] of **TUNE** knob

#### Voice Recognition Volume

Adjusts voice recognition volume.

Select [Voice Recognition Vol.] ▶ Set volume of **TUNE** knob

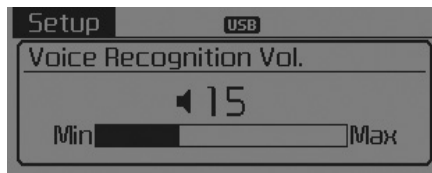

## SYSTEM SETTINGS

Press the **SETUP** key ▶ Select [System] ▶ Select menu through 

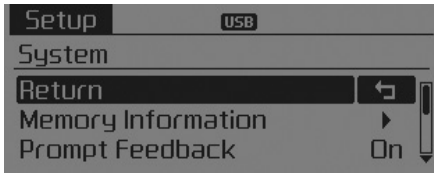

### Memory Information

Displays currently used memory and total system memory.

Select [Memory Information] ▶ OK

The currently used memory is displayed on the left side while the total system memory is displayed on the right side.



### Prompt Feedback

This feature is used to change voice command feedback between Normal and Expert modes.

Select [Prompt Feedback] ▶ Set through 

- On : This mode is for beginner users and provides detailed instructions during voice command operation.

- Off : This mode is for expert users and omits some information during voice command operation. (When using Expert mode, guidance instructions can be heard through the [Help] or [Menu] commands.)

### Language

This menu is used to set the display and voice recognition language.

Select [Language] ▶ Set through 



\*The system will reboot after the language is changed.

\*Language support by region  
- English, Francais, Espanol



## Features of your vehicle

### RADIO : FM, AM or SiriusXM

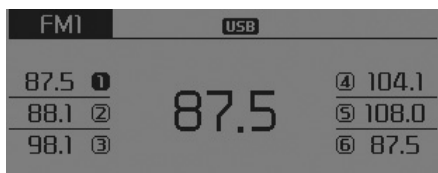

### SEEK

Press the key

- Shortly pressing the key (less than 1 second): Automatically searches for the next station.
- Pressing and holding the key (more than 1 second): While holding the key, frequency changes without stopping. When the key is released, automatically searches for the next frequency from that point.

### Preset SEEK

Press the ~ key

- Shortly pressing the key (less than 1 second): Plays the frequency saved in the corresponding key.
- Pressing and holding the key (more than 1 second): Pressing and holding the desired key from ~ will save the currently playing broadcast to the selected key and sound a BEEP.

### SCAN

Press the key

- Shortly pressing the key (less than 1 second): The broadcast frequency increases and previews each broadcast for 5 seconds each. After scanning all frequencies, returns and plays the current broadcast frequency.
- Pressing and holding the key (more than 1 second): Previews the broadcasts saved in Preset ~ for 5 seconds each.

### Selecting through manual search

Turn the TUNE knob left/right to adjust the frequency.

## MENU

Within **MENU** key are the A.Store (Auto Store) and Info functions.



### ① A.Store

Press the **MENU** key ▶ Set [A.Store] through **TUNE** knob or **1** key.

Saves broadcasts with superior reception to **1** ~ **6** keys. If no frequencies are received, then the most recently received frequency will be broadcast.

## Features of your vehicle

### SiriusXM® Satellite Radio information

#### Satellite Radio channels:

Enjoy SiriusXM Satellite Radio with a 3-month trial subscription to the Sirius Select package. You'll get over 140 channels, including commercial-free music, plus all your favorite sports, exclusive talk, entertainment, and a selection of premium programming. For more information and a complete list of SiriusXM channels, visit [siriusxm.com](http://siriusxm.com) in the United States, [siriusxm.ca](http://siriusxm.ca) in Canada, or call SiriusXM at 1-888-539-7474.

#### Satellite Radio reception factors:

To receive the satellite signal, your vehicle has been equipped with a satellite radio antenna located on the roof of your vehicle. The vehicle roof provides the best location for an unobstructed, open view of the sky, a requirement of a satellite radio system. Like AM/FM, there are several factors that can affect satellite radio reception performance:

- **Antenna obstructions:** For optimal reception performance, keep the antenna clear of snow and ice build-

up and keep luggage and other material as far away from the antenna as possible.

- **Terrain:** Hills, mountains, tall buildings, bridges, tunnels, freeway overpasses, parking garages, dense tree foliage and thunderstorms can interfere with your reception.

#### SiriusXM Satellite Radio service:

SiriusXM is a subscription-based satellite radio service that broadcasts music, sports, news and entertainment programming to radio receivers, which are available for installation in motor vehicles or factory installed, as well as for the home, portable and wireless devices, and through an Internet connection on personal computer. Vehicles that are equipped with a factory installed SiriusXM Satellite Radio system include:

- Hardware and an introductory trial subscription term, which begins on the date of sale or lease of the vehicle.
- For a small upgrade fee, access to SiriusXM music channels, and other select channels over the Internet using any computer connected to the Internet (U.S. customers only).

For information on extended subscription terms, contact SiriusXM at 1-888-539-7474.

#### NOTE:

**SiriusXM services require a subscription sold separately, or as a package, by Sirius XM Radio Inc. If you decide to continue service after your trial, the subscription plan you choose will automatically renew thereafter and you will be charged according to your chosen payment method at then-current rates. Fees and taxes apply. To cancel you must call SiriusXM at 1-866-635-2349. See SiriusXM Customer Agreement for complete terms at [www.siriusxm.com](http://www.siriusxm.com) SiriusXM U.S. satellite and data services are available only in the 48 contiguous USA, DC and PR \ satellite service is also available in Canada; see [www.siriusxm.ca](http://www.siriusxm.ca). All fees and programming subject to change. Sirius, XM and all related marks and logos are trademarks of Sirius XM Radio Inc.**

## SiriusXM RADIO

### Using SiriusXM Satellite Radio

Your Kia vehicle is equipped with a 3-month trial subscription to SiriusXM so you have access to over 140 channels of music, information, and entertainment programming.

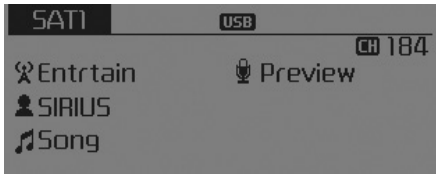

### Activation

In order to extend or reactivate your Sirius Select subscription, you will need to contact SiriusXM Customer Care at 1-800-643-2112. Have your 12-digit RID (Radio Identification Number) / ESN (Electronic Serial Number) ready. To retrieve the RID / ESN, turn on the radio, press the **RADIO** button, and tune to channel zero.

Please note that the vehicle will need to be turned on, in Sirius mode, and have an unobstructed view of the sky in order for the radio to receive the activation signal.

### SEEK

Press the **RADIO** key ▶ **SEEK TRACK** ⏮

- Shortly pressing the key (less than 1 second): select previous or next channel.
- Pressing and holding the key (more than 1 second): continuously move to previous or next channel.
- \* If the "Category" icon is displayed, channels are changed within the current category.



### SCAN

Press the **RADIO** key ▶ **SCAN**

- Shortly pressing the key (less than 1 second): Previews each broadcast for 5 seconds each.
- \* Press the **SCAN** key again to continue listening to the current frequency.
- \* If the "Category" icon is displayed, channels are changed within the current category.

### Category

Press the **CAT FOLDER** key ▶ Set through the **TUNE** knob

- The display will indicate the category menus, highlight the category that the current channel belongs to.
- In the Category List Mode, press the **CAT FOLDER** key to navigate category list.
- Press the tune knob to select the lowest channel in the highlighted category.
- \* If channel is selected by selecting category, then the "CATEGORY" icon is displayed at the top of the screen.

## Features of your vehicle

### Preset

Press the **RADIO** key ▶ **1** ~ **6**

- Shortly pressing the key (less than 1 second): Plays the frequency saved in the corresponding key.
- Pressing and holding the key (more than 1 second): Pressing and holding the desired key from **1** ~ **6** will save the current broadcast to the selected key and sound a BEEP.

### \* Troubleshooting



#### 1. Antenna Error

If this message is displayed, the antenna or antenna cable is broken or unplugged. Please consult with your Kia dealership.



#### 2. No Signal

If this message is displayed, it means that the antenna is covered and that the SiriusXM Satellite Radio signal is not available. Ensure the antenna is uncovered and has a clear view of the sky.

### Tune

- Rotate  TUNE knob : Changes the channel number or scrolls category list.
- Press  TUNE knob : Selects the menu.

### Menu

Select category menu through the  TUNE knob ▶ Press the **MENU** key ▶ Select [**Info**] through the  TUNE knob or **1** key

### Info (Information)

Displays the Artist/Song info of the current song.

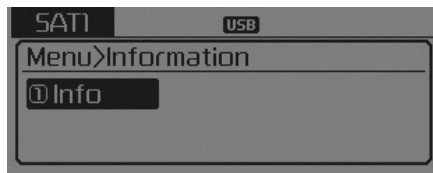

## BASIC METHOD OF USE :

### Audio CD / MP3 CD / USB / iPod® / My Music

Press the **MEDIA** key to change the mode in order of CD → USB(iPod®) → AUX → My Music → BT Audio.

The folder/file name is displayed on the screen.



<Audio CD>



<MP3 CD>



<USB>



<My Music>

\*The CD is automatically played when a CD is inserted.

\*The USB music is automatically played when a USB is connected.

## Repeat

While song (file) is playing ▶ **1 RPT** (RPT) key

Audio CD, MP3 CD, USB, iPod®, My Music mode: RPT on screen

- To repeat one song (press the key) : Repeats the current song.

MP3 CD, USB mode: FLD.RPT on screen

- To repeat folder (pressing twice): repeats all files within the current folder.

\* Press the **1 RPT** key again to turn off repeat.

## Random

While song (file) is playing ▶ **2 RDM** (RDM) key

Audio CD, My Music mode: RDM on screen

- Random (press the key) : Plays all songs in random order.

## Features of your vehicle

MP3 CD, USB mode: FLD.RDM on screen

- Folder Random (press the key) : Plays all files within the current folder in random order.

iPod® mode: ALL RDM on screen

- All Random (press the key) : Plays all files in random order.

MP3 CD, USB : ALL RDM on screen

- All Random (pressing twice): Plays all files in random order.

\* Press the **RDM** key again to turn off repeat.

### Changing Song/File

While song (file) is playing ▶ **SEEK TRACK** key

- Shortly pressing the key : Plays the current song from the beginning.

\* If the **SEEK TRACK** key is pressed again within 2 second, the previous song is played.

- Pressing and holding the key (more than 1 second): Rewinds the song.

While song (file) is playing ▶ **SEEK TRACK** key

- Shortly pressing the key : Plays the next song.
- Pressing and holding the key (more than 1 second): Fast forwards the song.

### Scan

While song (file) is playing ▶ **SCAN** key

- Shortly pressing the key : Scans all songs from the next song for 10 seconds each.

\* Press the **SCAN** key again to turn off.

\* The SCAN function is not supported in iPod® mode.

### Folder Search : MP3 CD, USB Mode

While file is playing ▶ **CAT FOLDER** key (Folder Up) key

- Searches the next folder.

While file is playing ▶ **CAT FOLDER** key (Folder Down) key

- Searches the parent folder.

\* If a folder is selected by pressing the **TUNE** knob, the first file within the selected folder will be played.

\* In iPod® mode, moves to the Parent Folder.

### Searching Songs (File)

- Turning **TUNE** knob : Searches for songs (files).
- Pressing **TUNE** knob : Plays selected song (file).

**MENU : Audio CD**

Press the Audio CD mode **MENU** key to set the Repeat, Random, Information features.

**Repeat**

Press the **MENU** key ▶ Set [**1 RPT**] through the TUNE knob or **1 RPT** key to repeat the current song.

\* Press RPT again to turn off.

**Random**

Press the **MENU** key ▶ Set [**2 RDM**] through the TUNE knob or **2 RDM** key to randomly play songs within the current CD.

\* Press RDM again to turn off.

**Information**

Press the **MENU** key ▶ Set [**3 Info**] through the TUNE knob or **3** key to display information of the current song.

\* Press the **MENU** key to turn off info display.

**MENU : MP3 CD / USB**

Press the MP3 CD/USB mode **MENU** key to set the Repeat, Folder Random, Folder Repeat, All Random, Information, and Copy features.

**Repeat**

Press the **MENU** key ▶ Set [**1 RPT**] through the TUNE knob or **1 RPT** key to repeat the current song.

\* Press RPT again to turn off.



## Features of your vehicle

### Folder Random

Press the **MENU** key ▶ Set [**2**F.RDM] through the **TUNE** knob or **2 RDM** key to randomly play songs within the current folder.

\* Press F.RDM again to turn off.

### Folder Repeat

Press the **MENU** key ▶ Set [**3**F.RPT] through the **TUNE** knob or **3** key to repeat songs within the current folder.

\* Press F.RPT again to turn off.

### All Random

Press the **MENU** key ▶ Set [**4**A.RDM] through the **TUNE** knob or **4** key to randomly play all songs within the CD/USB.

\* Press A.RDM again to turn off.

### Information

Press the **MENU** key ▶ Set [**5**Info] through the **TUNE** knob or **5** key to display information of the current song.

\* Press the **MENU** key to turn off info display.

### Copy

Press the **MENU** key ▶ Set [**6**Copy] through the **TUNE** knob or **6** key.

This is used to copy the current song into My Music. You can play the copied Music in My Music mode.

\* If another key is pressed while copying is in progress, a pop up asking you whether to cancel copying is displayed.

\* If another media is connected or inserted (USB, CD, iPod®, AUX) while copying is in progress, copying is canceled.

\* Music will not be played while copying is in progress.

## MENU : iPod®

In iPod® mode, press the **MENU** key to set the Repeat, Random, Information and Search features.

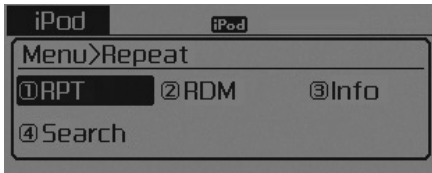

### Repeat

Press the **MENU** key to Set **[1]RPT** through the **TUNE** knob or **1 RPT** key to repeat the current song.

\* Press RPT again to turn repeat off.

### Random

Press the **MENU** key to Set **[2]RDM** through the **TUNE** knob or **2** key.

Plays all songs within the currently playing category in random order.

\* Press RDM again to turn off.

## Information

Press the **MENU** key to Set **[3]Info** through the **TUNE** knob or **3** key.

Displays information of the current song.

\* Press the **MENU** key to turn off info display.

## Search

Press the **MENU** key to Set **[4]Search** through the **TUNE** knob or **4** key.

Displays iPod® category list.

\* Searching iPod® category is **MENU** key pressed, move to parent category.

## Features of your vehicle

### MENU : My Music Mode

In My Music mode, press the **MENU** key to set the Repeat, Random, Information, Delete, Delete All, and Delete Selection features.



#### Repeat

Press the **MENU** key ▶ Set [**1**RPT] through the **TUNE** knob or **1 RPT** key.

Repeats the currently playing song.  
\* Press RPT again to turn repeat off.

#### Random

Press the **MENU** key ▶ Set [**2**RDM] through the **TUNE** knob or **2 RDM** key.

Plays all songs in random order.  
\* Press RDM again to turn random off.

### Information

Press the **MENU** key ▶ Set [**3**Info] through the **TUNE** knob or **3** key.

Displays information of the current song.

\* Press the **MENU** key to turn off info display.

### Delete

Press the **MENU** key ▶ Set [**4**Delete] through the **TUNE** knob or **4** key.

Deletes currently playing file

In the play screen, pressing delete will delete the currently playing song.

Deletes file from list

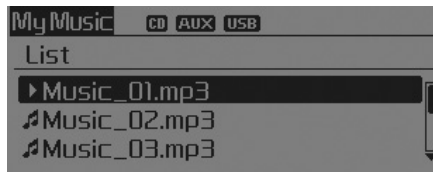

① Select the file you wish to delete by using the **TUNE** knob.

② Press the **MENU** key and select the delete menu to delete the selected file.

### Delete All

Press the **MENU** key ▶ Set [**5**Del.All] through the **TUNE** knob or **5** key.

Deletes all songs of My Music.

### Delete Selection

Press the **MENU** key ▶ Set [**6**Del.Sel] through the **TUNE** knob or **6** key.

Songs within My Music are selected and deleted.

① Select the songs you wish to delete from the list.

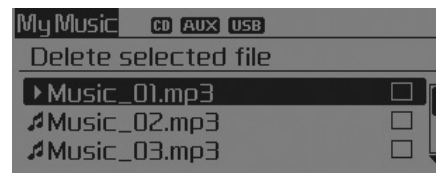

- ② After selecting, press **MENU** key and select the delete menu.

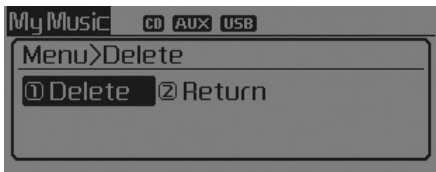

## My Music

- Even if memory is available, a maximum of 6,000 songs can be stored.
- The same song can be copied up to 1,000 times.
- Memory info can be checked in the System menu of Setup.

## AUX

AUX is used to play external MEDIA currently connected with the AUX terminal.

AUX mode will automatically start when an external device is connected with the AUX terminal.

If an external device is connected, you can also press the **MEDIA** key to change to AUX mode.



\*AUX mode cannot be started unless there is an external device connected to the AUX terminal.

## AUX

Fully insert the AUX cable into the AUX terminal for use.

## Features of your vehicle

### **Bluetooth® Wireless Technology AUDIO**

#### **What is Bluetooth® Wireless Technology?**

*Bluetooth®* Wireless Technology allows devices to be connected in a short distance, including hands-free devices, stereo headsets, wireless remote controllers, etc. For more information, visit the *Bluetooth®* Wireless Technology website at [www.Bluetooth.com](http://www.Bluetooth.com).

Before using *Bluetooth®* Wireless Technology audio features

- *Bluetooth®* Wireless Technology audio may not be supported depending on the compatibility of your *Bluetooth®* Wireless Technology mobile phone.
- In order to use *Bluetooth®* Wireless Technology audio, you must first pair and connect the *Bluetooth®* Wireless Technology mobile phone.

- The Bluetooth® word mark and logos are registered trademarks owned by Bluetooth SIG, Inc. and any use of such marks by Kia is under license. Other trademarks and trade names are those of their respective owners. A Bluetooth® enabled cell phone is required to use *Bluetooth®* Wireless Technology.

- *Bluetooth®* Wireless Technology audio can be used only when the [Audio Streaming] of Phone is turned **(On)**.

#### **⚠ WARNING**

**Driving while distracted can result in a loss of vehicle control that may lead to an accident, severe personal injury, and death. The driver's primary responsibility is in the safe and legal operation of a vehicle, and use of any handheld devices, other equipment, or vehicle systems which take the driver's eyes, attention and focus away from the safe operation of a vehicle or which are not permissible by law should never be used during operation of the vehicle.**

### Starting *Bluetooth*® Wireless Technology Audio

- Press the **MEDIA** key to change the mode in order of CD → USB → AUX → My Music → BT Audio.
- If BT Audio is selected, *Bluetooth*® Wireless Technology audio will start playing.
- \* Audio may not automatically start playing in some mobile phones.

### Using the *Bluetooth*® Wireless Technology audio features

- Play / Stop  
Press the **TUNE** knob to play and pause the current song.

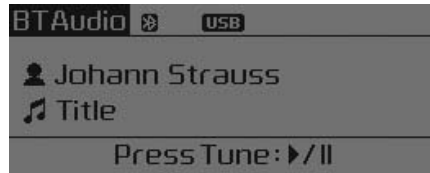

- \* The title / artist info may not be supported in some mobile phone. When it is not supported, no title/no artist will be displayed.
- Previous / Next song  
Press **SEEK TRACK** or **SEEK TRACK** to play previous or next song.
- \* The previous song / next song / play / pause functions may not be supported in some mobile phones.



## Features of your vehicle



### PHONE

Before using the *Bluetooth*® Wireless Technology phone features

- In order to use *Bluetooth*® Wireless Technology phone, you must first pair and connect the *Bluetooth*® Wireless Technology mobile phone.
- If the mobile phone is not paired or connected, it is not possible to enter Phone mode. Once a phone is paired or connected, the guidance screen will be displayed.
- If Priority is set upon vehicle ignition (IGN/ACC ON), the *Bluetooth*® Wireless Technology phone will be automatically connected. Even if you are outside, the *Bluetooth*® Wireless Technology phone will be automatically connected once you are in the vicinity of the vehicle. If you do not want automatic *Bluetooth*® Wireless Technology phone connection, set the *Bluetooth*® Wireless Technology power to OFF.

### Making a call using the Steering-wheel mount controls

- (1) MUTE key : Mutes the microphone during a call.
- (2) VOLUME key : Raises or lowers speaker volume.
- (3)  key : Activates voice recognition.
- (4)  key : Places and transfers calls.
- (5)  key : Ends calls or cancels functions.

- Check call history and making call
  - Shortly press (less than 0.8 seconds) the  key on the steering remote controller.
  - The call history list will be displayed on the screen.
  - Press the  key again to connect a call to the selected number.
- Redialing the most recently called number
  - Press and hold (more than 0.8 seconds) the  key on the steering remote controller.
  - The most recently called number is redialed.
- \* If call history does not exist, a screen asking whether to download call history is displayed. (The download feature may not be supported in some mobile phones)

## **Bluetooth® Wireless Technology**

### **Pairing a Bluetooth® Wireless Technology Device**

#### ***What is Bluetooth® Wireless Technology Pairing?***

Pairing refers to the process of synchronizing your *Bluetooth®* Wireless Technology phone or device with the car audio system for connection. Pairing is necessary to connect and use the *Bluetooth®* Wireless Technology feature.

The *Bluetooth®* word mark and logos are registered trademarks owned by Bluetooth SIG, Inc. and any use of such marks by Kia is under license. Other trademarks and trade names are those of their respective owners. A *Bluetooth®* enabled cell phone is required to use *Bluetooth®* Wireless Technology.

#### **⚠ WARNING**

**Driving while distracted can result in a loss of vehicle control that may lead to an accident, severe personal injury, and death. The driver's primary responsibility is in the safe and legal operation of a vehicle, and use of any handheld devices, other equipment, or vehicle systems which take the driver's eyes, attention and focus away from the safe operation of a vehicle or which are not permissible by law should never be used during operation of the vehicle.**



## Features of your vehicle

### Pairing **PHONE** key / key on the Steering Remote Controller

#### *When No Devices have been Paired*

1. Press the **PHONE** key or the  key on the steering remote controller. The following screen is displayed.

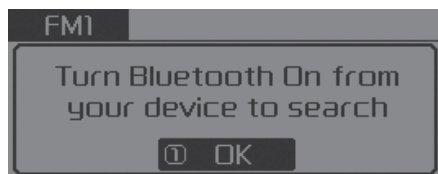

2. Select [OK] button to enter the Pair Phone screen.

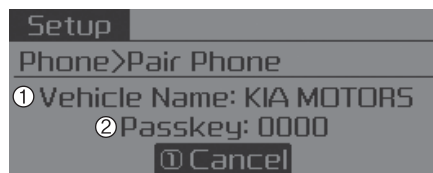

- 1) Vehicle Name : Name of device as shown when searching from your *Bluetooth*<sup>®</sup> Wireless Technology device.
- 2) Passkey : Passkey used to pair the device.
3. From your *Bluetooth*<sup>®</sup> Wireless Technology device (i.e. Mobile Phone), search and select your car audio system.

[Non SSP supported device]  
(SSP: Secure Simple Pairing)

4. After a few moments, a screen is displayed where the passkey is entered. Hear, enter the passkey "0000" to pair your *Bluetooth*<sup>®</sup> Wireless Technology device with the car audio system.

[SSP supported device]

4. After a few moments, a screen is displayed 6 digits passkey. Hear, check the passkey on your *Bluetooth*<sup>®</sup> Wireless Technology device and confirm.



5. Once pairing is complete, the following screen is displayed.

## Features of your vehicle

Some phones (i.e., iPhone®, Android and Blackberry phones) may offer an option to allow acceptance of all future Bluetooth connection requests by default." and "Visit <http://www.kia.com/us/en/content/owners/bluetooth> for additional information on pairing your Bluetooth-enabled mobile phone, and to view a phone compatibility list.

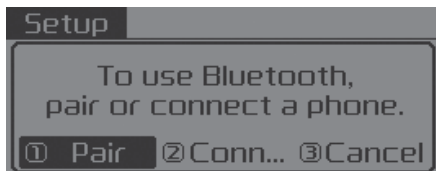

- If *Bluetooth*® Wireless Technology devices are paired but none are currently connected, pressing the **PHONE** key or the  key on the steering wheel displays the following screen. Select [Pair] button to pair a new device or select [Connect] to connect a previously paired device.

## Features of your vehicle

### Pairing through [PHONE] Setup

Press the **SETUP** key ▶ Select [Phone] ▶ Select [Pair Phone] ▶ Select  TUNE knob



1. The following steps are the same as those described in the section "When No Devices have been Paired" on the previous page.

- *Bluetooth*<sup>®</sup> Wireless Technology features supported within the vehicle are as follows. Some features may not be supported depending on your *Bluetooth*<sup>®</sup> Wireless Technology device.
  - Outgoing/Incoming Handsfree calls
  - Operations during a call (Switch to Private, Switch to call waiting, MIC on/off)
  - Downloading Call History
  - Downloading Mobile Contacts
  - *Bluetooth*<sup>®</sup> Wireless Technology device auto connection
  - Bluetooth Audio Streaming
- Up to five *Bluetooth*<sup>®</sup> Wireless Technology devices can be paired to the Car Handsfree system.
- Only one *Bluetooth*<sup>®</sup> Wireless Technology device can be connected at a time.
- Other devices cannot be paired while a *Bluetooth*<sup>®</sup> Wireless Technology device is connected.
- Only *Bluetooth*<sup>®</sup> Wireless Technology Handsfree and Bluetooth audio related features are supported.
- Bluetooth related operations are possible only within devices that support Handsfree or audio features, such as a *Bluetooth*<sup>®</sup> Wireless Technology mobile phone or a Bluetooth audio device.
- If a connected *Bluetooth*<sup>®</sup> Wireless Technology device becomes disconnected due to being out of communication range, turning the device OFF, or a *Bluetooth*<sup>®</sup> Wireless Technology communication error, corresponding *Bluetooth*<sup>®</sup> Wireless Technology devices are automatically searched and reconnected.
- If the system becomes unstable due to communication errors between the car Handsfree and the *Bluetooth*<sup>®</sup> Wireless Technology device, reset the device by turning off and back on again. Upon resetting *Bluetooth*<sup>®</sup> Wireless Technology device, the system will be restored.

- After pairing is complete, a contacts download request is sent once to the mobile phone. Some mobile phones may require confirmation upon receiving a download request, ensure your mobile phone accepts the connection. Refer to your phone's user's manual for additional information regarding phone pairing and connections.

### Connecting a Device

Press the **SETUP** key ▶ Select [Phone] ▶ Select [Phone List]



- 1) Connected Phone : Device that is currently connected.
- 2) Paired Phone : Device that is paired but not connected.

From the paired phone list, select the device you want to connect and select [Connect].

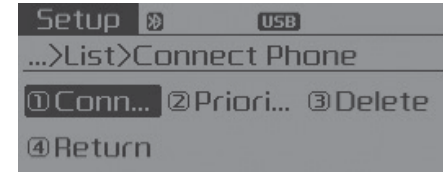

## Features of your vehicle

### Changing Priority

#### What is Priority?

It is possible to pair up to five *Bluetooth*<sup>®</sup> Wireless Technology devices with the car audio system. The "Change Priority" feature is used to set the connection priority of paired phones.

Press the **SETUP** key ▶ Select [Phone] ▶ Select [Phone List]



From the paired phone list, select the phone you want to switch to the highest priority, then select [Change Priority] button from the Menu. The selected device will be changed to the highest priority.

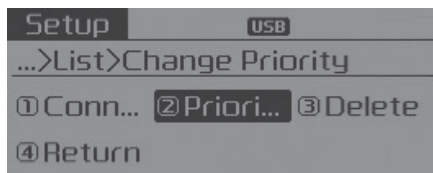

- Priority icon will be displayed when the selected phone is set as a priority phone.



## Disconnecting a Device

Press the **SETUP** key ▶ Select [Phone] ▶ Select [Phone List]



From the paired phone list, select the currently connected device and select [Disconnect] button.

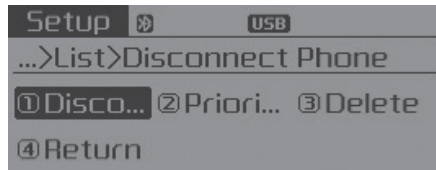

## Deleting a Device

Press the **SETUP** key ▶ Select [Phone] ▶ Select [Phone List]



From the paired phone list, select the device you want to delete and select [Delete] button.

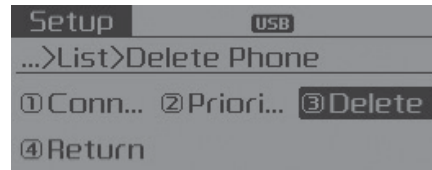

- When deleting the currently connected device, the device will automatically be disconnected to proceed with the deleting process.
- If a paired *Bluetooth*® Wireless Technology device is deleted, the device's call history and contacts data will also be deleted.
- To re-use a deleted device, you must pair the device again.

## Features of your vehicle

### USING *Bluetooth*<sup>®</sup> Wireless Technology

#### Phone Menu Screen

##### *Phone Menus*

With a *Bluetooth*<sup>®</sup> Wireless Technology device connected, press the **PHONE** key to display the Phone menu screen.

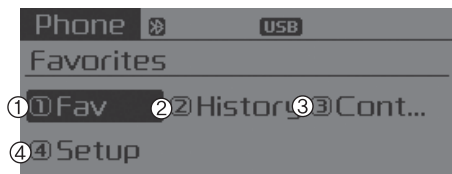

- 1) Favorite : Up to 20 frequently used contacts saved for easy access.
- 2) Call History : Displays the call history list screen.
- 3) Contacts : Displays the Contacts list screen.
- 4) Setup : Displays Phone related settings.

- If you select the [Call History] button but there is no call history data, a prompt is displayed which asks to download call history data.
- If you select the [Contacts] button but there is no contacts data stored, a prompt is displayed which asks to download contacts data.
- This feature may not be supported in some mobile phones. For more information on download support, refer to your mobile phone user's manual.

### Answering Calls

#### *Answering a Call*

Answering a call with a *Bluetooth*<sup>®</sup> Wireless Technology device connected will display the following screen.

To accept the call, press  key on the steering wheel while the call is incoming.



- 1) Caller : Displays the other party's name when the incoming caller is saved within your contacts.
- 2) Incoming Number : Displays the incoming number.

**\* NOTICE**

- When an incoming call pop-up is displayed, most Audio and SETUP mode features are disabled. Only the call volume will operate.
- The telephone number may not be properly displayed in some mobile phones.

**Favorites**

Press the **PHONE** key ▶ Select [Favorites]



- 1) Saved favorite contact : Connects call upon selection.
  - 2) To add favorite : Downloaded contacts be saved as favorite.
- To save Favorite, contacts should be downloaded.
  - Contact saved in Favorites will not be automatically updated if the contact has been updated in the phone. To update Favorites, delete the Favorite and create a new Favorite.

**Call History**

Press the **PHONE** key ▶ Select [Call History]



A list of incoming, outgoing and missed calls is displayed.

- Call history may not be saved in the call history list in some mobile phones.
- Calls received with hidden caller ID will not be saved in the call history list.
- Calling through the call history is not possible when there is no call history stored or a *Bluetooth*® Wireless Technology phone is not connected.
- Up to 50 received, dialed and missed calls are stored in Call History.
- Time of received/dialed calls and call time information are not stored in Call History.



## Features of your vehicle

### Contacts

Press the **PHONE** key ▶ Select [Contacts]

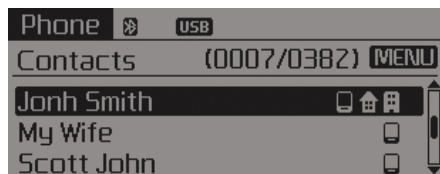

The list of saved phone book entries is displayed.

#### NOTE:

**Find a contact in an alphabetical order, press the **MENU** key.**



- Up to 1,000 contacts saved in your *Bluetooth*® Wireless Technology phone can be downloaded into the car contacts. Contacts that have been downloaded to the car cannot be edited or deleted on the phone.
- Mobile phone contacts are managed separately for each paired *Bluetooth*® Wireless Technology device (max 5 devices x 1,000 contacts each). Previously downloaded data is maintained even if the *Bluetooth*® Wireless Technology device has been disconnected. (However, the contacts and call history saved to the phone will be deleted if a paired phone is deleted.)
- It is possible to download contacts during Bluetooth streaming audio.
- When downloading contacts, the icon will be displayed within the status bar.
- It is not possible to begin downloading a contact list when the contact download feature has been turned off within the *Bluetooth*® Wireless Technology device. In addition, some devices may require device authorization upon attempting to download contacts. If downloading does not normally occur, check the *Bluetooth*® Wireless Technology device settings or the screen state.
- The contacts download feature may not be supported in some mobile phones. For more information of supported *Bluetooth*® devices and function support, refer to your phone's user manual.

## Bluetooth® Wireless Technology Setting

The *Bluetooth*® word mark and logos are registered trademarks owned by Bluetooth SIG, Inc. and any use of such marks by Kia is under license. Other trademarks and trade names are those of their respective owners. A *Bluetooth*® enabled cell phone is required to use *Bluetooth*® Wireless Technology.

### ⚠ WARNING

**Driving while distracted can result in a loss of vehicle control that may lead to an accident, severe personal injury, and death. The driver's primary responsibility is in the safe and legal operation of a vehicle, and use of any handheld devices, other equipment, or vehicle systems which take the driver's eyes, attention and focus away from the safe operation of a vehicle or which are not permissible by law should never be used during operation of the vehicle.**

### Pairing a New Device

Press the **SETUP** key ▶ Select [Phone] ▶ Select [Pair Phone]

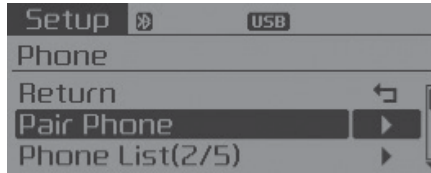

*Bluetooth*® Wireless Technology devices can be paired with the audio system.

For more information, refer to the "Pairing through Phone Setup" section within *Bluetooth*® Wireless Technology.

### Viewing Paired Phone List

Press the **SETUP** key ▶ Select [Phone] ▶ Select [Phone List]



This feature is used to view mobile phones that have been paired with the audio system. Upon selecting a paired phone, the setup menu is displayed.

For more information, refer to the "Setting *Bluetooth*® Wireless Technology Connection" section within *Bluetooth*® Wireless Technology.

## Features of your vehicle

- 1) Connect/Disconnect Phone : Connect/ disconnects currently selected phone.
- 2) Change Priority : Sets currently selected phone to highest connection priority.
- 3) Delete : Deletes the currently selected phone.
- 4) Return : Moves to the previous screen.

- To learn more about whether your mobile phone supports contacts downloads, refer to your mobile phone user's manual.
- The contacts for only the connected phone can be downloaded.

### Downloading Contacts

Press the **SETUP** key ▶ Select [Phone] ▶ Select [Contacts Download]



As the contacts are downloaded from the mobile phone, a download progress bar is displayed.

- Upon downloading phone contacts, the previous corresponding data is deleted.
- This feature may not be supported in some mobile phones.
- Voice Recognition may not operate while contacts are being downloaded.

### Outgoing Volume

Press the **SETUP** key ▶ Select [Phone] ▶ Select [Outgoing Volume]

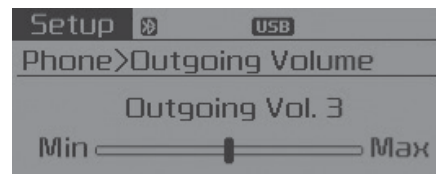

Use **TUNE** knob to adjust the outgoing volume level.

- While on a call, the volume can be changed by using the **SEEK TRACK** key.

### Turning Bluetooth System Off

Press the **SETUP** key ▶ Select [Phone] ▶ Select [Bluetooth System Off]

Once *Bluetooth*<sup>®</sup> Wireless Technology is turned off, *Bluetooth*<sup>®</sup> Wireless Technology related features will not be supported within the audio system.

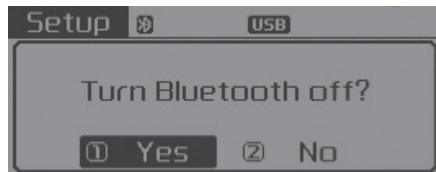
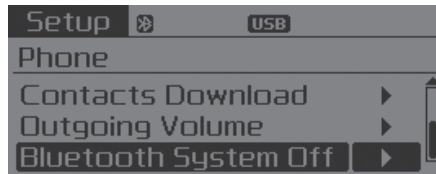

- To turn *Bluetooth*<sup>®</sup> Wireless Technology back on, go to **SETUP** ▶ [Phone] and select “Yes”.

## Features of your vehicle

### VOICE RECOGNITION

#### Using Voice Recognition

##### *Starting Voice Recognition*

Shortly press the  key on the steering wheel. Say a command.

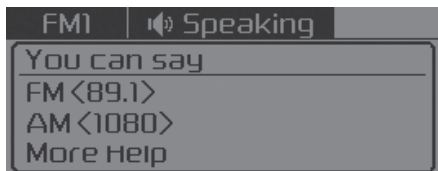

If prompt feedback is in [ON], then the system will say "Please say a command after the beep (BEEP)".

- If prompt feedback is in [OFF] mode, then the system will only say "(BEEP)".
- To change Prompt Feedback [On]/[Off], go to **SETUP** ▶ [System] ▶ [Prompt Feedback].
- For proper recognition, say the command after the voice instruction and beep tone.

#### Contact List Best Practices

- 1) Use full names vs. short or single syllable names ("John Smith" vs. "Dad", "Smith Residence" vs. "Home")
- 2) Avoid using special characters or hyphens (@, &, #, /, -, \*, +, etc.)
- 3) Avoid using acronyms ("In Case Emergency" vs. "ICE")
- 4) Spell words completely, no abbreviations ("Doctor Goodman" vs. "Dr. Goodman")

**Skipping Prompt Messages**

While prompt message is being stated ▶ Shortly press the  key on the steering remote controller.

The prompt message is immediately ended and the beep tone will sound. After the “beep”, say the voice command.

**Re-starting Voice Recognition**

While system waits for a command ▶ Shortly press the  key on the steering remote controller.

The command wait state is immediately ended and the beep tone will sound. After the “beep”, say the voice command.

**ENDING VOICE RECOGNITION**

While Voice Recognition is operating ▶ Press and hold the  key on the steering remote controller

- While using voice command, pressing any steering wheel control or a different key will end voice command.
- When the system is waiting for a voice command, say “cancel” or “end” to end voice command.
- When the system is waiting for a voice command, press and hold the  key on the steering wheel to end voice command.

**Voice Recognition and Phone Contact Tips:**

The Kia Voice Recognition System may have difficulty understanding some accents or uncommon names. When using Voice Recognition to place a call, speak in a moderate tone, with clear pronunciation.

To maximize the use of Voice Recognition, consider these guidelines when storing contacts:

- Do not store single-name entries (e.g., “Bob”, “Mom”, etc.). Instead, always use full names (including first and last names) for these contacts.
- Do not use special characters (e.g., '@', '-', '\*', '&', etc.).
- Do not use abbreviations (i.e., use “Lieutenant” instead of “Lt.”) or acronyms (i.e., use “County Finance Department” instead of “C. F. D.”; Be sure to say the name exactly as it is entered in the contacts list.

## Features of your vehicle

### Illustration on using voice commands

#### • Starting voice command.

Shortly pressing the  key (less than 0.8 seconds):

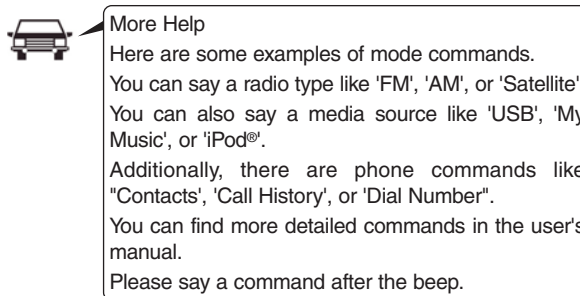
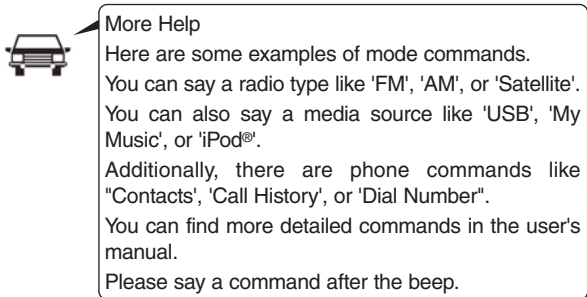
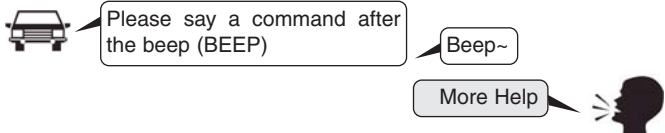

#### • Skipping Voice Recognition

Shortly pressing the  key (less than 0.8 seconds):



Shortly pressing the  key (less than 0.8 seconds):



#### • Ending voice command.

Shortly pressing the  key (less than 0.8 seconds):

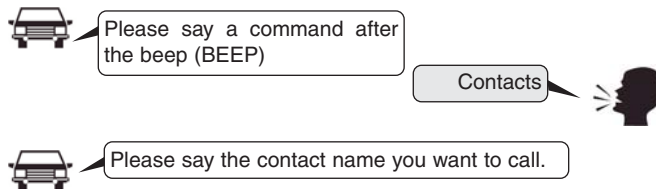

## Voice Command List

- **Common Commands:** These commands can be used in most operations. (However, a few commands may not be available during certain operations).

Command	Function
More Help	Provides guidance on commands that can be used anywhere in the system.
Help	Provides guidance on commands that can be used within the current mode.
Call<Name>	Calls <Name> saved in Contacts. Ex) Call "John Smith".
Call <Name> on Mobile	Calls <Name> to the number that is saved as "Mobile" in Contacts. Ex) Call "John Smith" on Mobile.
Call <Name> in Office	Calls <Name> to the number that is saved as "Office" in Contacts. Ex) Call "John Smith" in Office.
Call <Name> at Home	Calls <Name> to the number that is saved as "Home" in Contacts. Ex) Call "John Smith" at Home.
Call <Name> on Other	Calls <Name> to the number that is saved as "Other" in Contacts. Ex) Call "John Smith" on Other.
Phone	Provides guidance on Phone related commands. After saying this command, say "Favorites", "Call History", "Contacts" or "Dial Number" execute corresponding functions.
Favorites	Displays the Favorite screen.
Call History	Displays the Call History screen.

Command	Function
Contacts	Displays the Contacts screen. After saying this command, say the name of a contact saved in the Contacts to automatically connect the call.
Dial Number	Displays the Dial number screen. After saying this command, you can say the number that you want to call.
Redial	Connects the last dialed call number.
Tutorial	Provides guidance on how to use voice recognition and Bluetooth® connections.
Radio	<ul style="list-style-type: none"> <li>• When listening to the radio, displays the next radio screen. (FM1→FM2→AM→SAT1→SAT2→SAT3→FM1)</li> <li>• When listening to a different mode, displays the most recently played radio screen.</li> <li>• When currently listening to the FM radio, maintains the current state.</li> <li>• When listening to a different mode, displays the most recently played FM screen.</li> </ul>
FM1(FM One)	Displays the FM1 screen.
FM2(FM Two)	Displays the FM2 screen.
AM	Displays the AM screen.



## Features of your vehicle

Command	Function
FM Preset 1~6	Plays the most recently played broadcast saved in FM Preset 1~6.
AM Preset 1~6	Plays the broadcast saved in AM Preset 1~6.
FM 87.5~107.9	Plays the FM broadcast of the corresponding frequency.
AM 530~1710	Plays the AM broadcast of the corresponding frequency.
SIRIUS (Satellite)	<ul style="list-style-type: none"> <li>• When currently listening to the SiriusXM®, maintains the current state.</li> <li>• When listening to a different mode, displays the most recently played SiriusXM® screen.</li> </ul>
SIRIUS (Satellite) 1~3	Displays the selected SiriusXM® screen.
SIRIUS Channel 0~223	Plays the selected SiriusXM® channel.
Media	Moves to the most recently played media screen.
CD	Plays the music saved in the CD.
USB	Plays USB music.
iPod®	Plays iPod® music.

Command	Function
My Music	Plays the music saved in My Music.
AUX (Auxiliary)	Plays the connected external device.
Bluetooth® Audio	Plays the music saved in connected Bluetooth® device.
Mute	Mutes the sound.
Cancel (Exit)	Ends voice command.

## Features of your vehicle

- **FM/AM radio Commands:** Commands available during FM, AM radio operation.

Command	Function
Preset 1~6	Plays the broadcast station saved in Preset 1~6.
Scan	Scans receivable frequencies from the current broadcast and plays for 10 seconds each.
Preset Scan	Moves to the next preset from the current present and plays for 10 seconds each.
Information	Displays the information of the current broadcast.(This feature can be used when receiving RBDS broadcasts.)

- **Satellite radio Commands:** Commands that can be used while listening to Satellite Radio.

Command	Function
Channel 0~223	Plays the selected Satellite Radio channel.
Scan	Scans receivable channels from the current broadcast and plays for 10 seconds each.
Preset 1~6	Plays the broadcast saved in Preset 1~6.
Information	Displays the information of the current broadcast.

## Features of your vehicle

- **Audio CD Commands:** Commands available during Audio CD operation.

Command	Function
Random	Randomly plays the tracks within the CD.
Random Off	Cancels random play to play tracks in sequential order.
Repeat	Repeats the current track.
Repeat Off	Cancels repeat play to play tracks in sequential order.
Track 1~30	Plays the desired track number.

- **MP3 CD / USB Commands:** Commands available during USB and MP3 CD operation.

Command	Function
Random	Randomly plays the files within the current folder.
Random Off	Cancels random play to play files in sequential order.
Repeat	Repeats the current file.
Repeat Off	Cancels repeat play to play files in sequential order.
Information	Displays the information screen of the current file.
Next Folder	Play the first file in the next folder.
Previous Folder	Play the first file in the previous folder.

## Features of your vehicle

- iPod® Commands: Commands available during iPod® operation.

Command	Function
Random	Randomly plays the songs within the current category.
Random Off	Cancels random play to play songs in sequential order.
Repeat	Repeats the current song.
Repeat Off	Cancels repeat play to play songs in sequential order.

- My Music Commands: Commands available during My Music operation.

Command	Function
Random	Randomly plays all saved files.
Random Off	Cancels random play to play files in sequential order.
Repeat	Repeats the current file.
Repeat Off	Cancels repeat play to play files in sequential order.
Delete	Deletes the current file. You will bypass an additional confirmation process.

## Features of your vehicle

- **Bluetooth®** Wireless Technology Audio Commands: Commands available during **Bluetooth®** Wireless Technology audio streaming from mobile phone operation Command Operation.

Command	Function
Play	Plays the currently paused song.
Pause	Pauses the current song.

**iPod®** is a registered trademark of Apple Inc. iPod® mobile digital device sold separately. The **Bluetooth®** word mark and logos are registered trademarks owned by Bluetooth SIG, Inc. and any use of such marks by Kia is under license. SiriusXM services require a subscription sold separately, or as a package, by Sirius XM Radio Inc. If you decide to continue service after your trial, the subscription plan you choose will automatically renew thereafter and you will be charged according to your chosen payment method at then-current rates. Fees and taxes apply. To cancel you must call SiriusXM at 1-866-635-2349. See SiriusXM Customer Agreement for complete terms at [www.siriusxm.com](http://www.siriusxm.com). SiriusXM U.S. satellite and data services are available only in the 48 contiguous USA, DC and PR (with coverage limitations). SiriusXM satellite service is also available in Canada; see [www.siriusxm.ca](http://www.siriusxm.ca). All fees and programming subject to change. Sirius, XM and all related marks and logos are trademarks of Sirius XM Radio Inc. Android™ is a trademark of Google, Inc. BlackBerry is a registered trademark of Research In Motion Limited (RIM). All other marks, channel names and logos are the property of their respective owners. All rights reserved.

## **FCC Warning**

This equipment has been tested and found to comply with the limits for a Class B digital device, pursuant to part 15 of the FCC Rules. These limits are designed to provide reasonable protection against harmful interference in a residential installation. This equipment generates, uses and can radiate radio frequency energy and, if not installed and used in accordance with the instructions, may cause harmful interference to radio communications. However, there is no guarantee that interference will not occur in a particular installation. If this equipment does cause harmful interference to radio or television reception, which can be determined by turning the equipment off and on, the user is encouraged to try to correct the interference by one or more of the following measures:

- Reorient or relocate the receiving antenna.
- Increase the separation between the equipment and receiver.
- Connect the equipment into an outlet on a circuit different from that to which the receiver is connected.
- Consult the dealer or an experienced radio/TV technician for help.

Caution: Any changes or modifications to this device not explicitly approved by manufacturer could void your authority to operate this equipment.

This device complies with part 15 of the FCC Rules. Operation is subject to the following two conditions:

(1) This device may not cause harmful interference, and (2) this device must accept any interference received, including interference that may cause undesired operation.

## **IC Warning**

"This device complies with Industry Canada licence-exempt RSS standard(s)."

Operation is subject to the following conditions: (1) this device may not cause interference, and (2) this device must accept any interference, including interference that may cause undesired operation of the device.

Le présent appareil est conforme aux CNR d'Industrie Canada applicables aux appareils radio exempts de licence. L'exploitation est autorisée aux deux conditions suivantes : (1) l'appareil ne doit pas provoquer de brouillage, et (2) l'appareil doit accepter tout brouillage radioélectrique subi, même si le brouillage est susceptible d'en compromettre le fonctionnement.