

Features of your vehicle

The Bluetooth and Voice Recognition Manual is provided in two versions due to software version differences. Before reading the manual, check the following.

■ DOT LCD type audio

Press the **SETUP** key ▶ Select [Phone]

1. If you CAN find “Audio Streaming” menu,
▶ (Go to #### page)

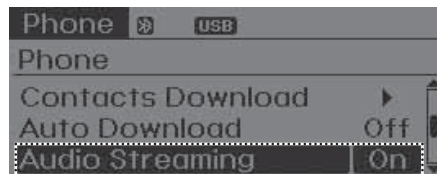

2. If you CANNOT find “Audio Streaming” menu,
▶ (Go to 2 page)

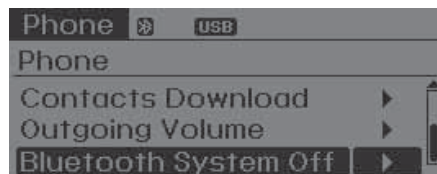

■ Color LCD type audio

Press the **SETUP** key ▶ Select [Phone]

1. If you CAN find “Streaming Audio” menu,
▶ (Go to #### page)

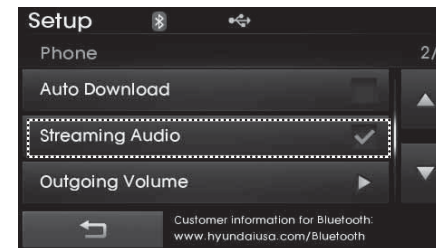

2. If you CANNOT find “Streaming Audio” menu,
▶ (Go to 62 page)

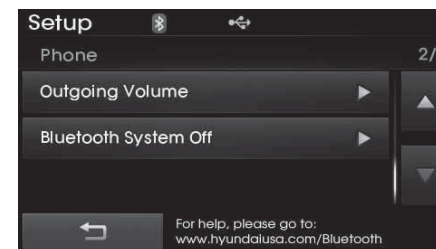

Features of your vehicle

How vehicle audio works

FM reception

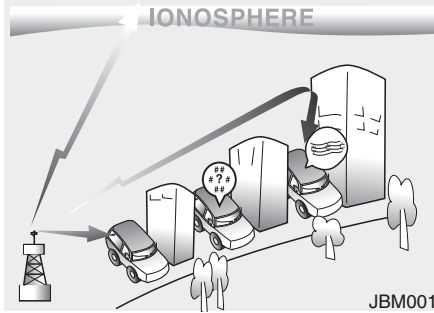

AM and FM radio signals are broadcast from transmitter towers located around your city. They are intercepted by the radio antenna on your vehicle. This signal is then processed by the radio and sent to your vehicle speakers.

When a strong radio signal has reached your vehicle, the precise engineering of your audio system ensures the best possible quality reproduction. However, in some cases the signal coming to your vehicle may not be strong and clear.

This can be due to factors, such as the distance from the radio station, closeness of other strong radio stations or the presence of buildings, bridges or other large obstructions in the area.

AM reception

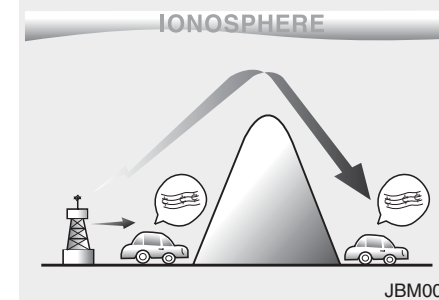

AM broadcasts can be received at greater distances than FM broadcasts. This is because AM radio waves are transmitted at low frequencies. These long distance, low frequency radio waves can follow the curvature of the earth rather than travelling straight. In addition, they curve around obstructions resulting in better signal coverage.

Features of your vehicle

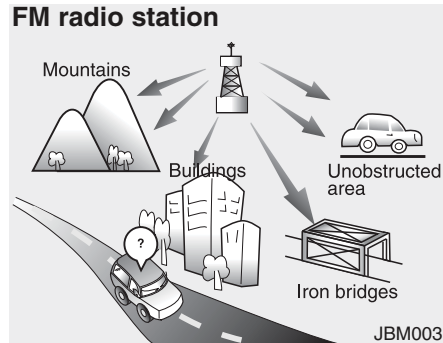

FM broadcasts are transmitted at high frequencies and do not bend to follow the earth's surface. Because of this, FM broadcasts generally begin to fade within short distances from the station. Also, FM signals are easily affected by buildings, mountains, and obstructions. This can lead to undesirable or unpleasant listening conditions which might lead you to believe a problem exists with your radio. The following conditions are normal and do not indicate radio trouble:

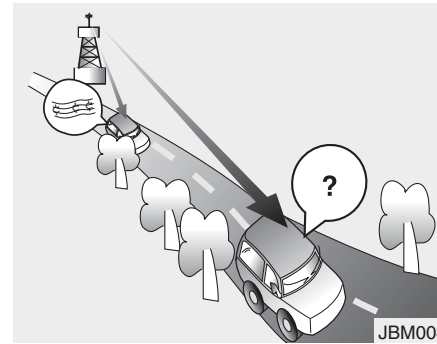

- **Fading** - As your vehicle moves away from the radio station, the signal will weaken and sound will begin to fade. When this occurs, we suggest that you select another stronger station.
- **Flutter/Static** - Weak FM signals or large obstructions between the transmitter and your radio can disturb the signal causing static or fluttering noises to occur. Reducing the treble level may lessen this effect until the disturbance clears.

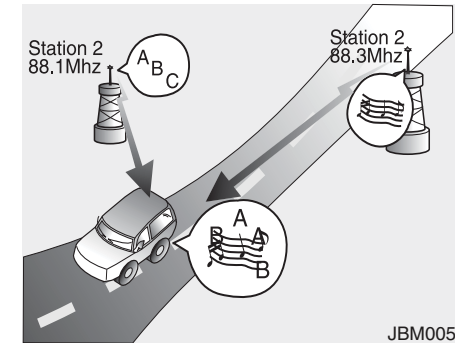

- **Station Swapping** - As an FM signal weakens, another more powerful signal near the same frequency may begin to play. This is because your radio is designed to lock onto the clearest signal. If this occurs, select another station with a stronger signal.
- **Multi-Path Cancellation** - Radio signals being received from several directions can cause distortion or fluttering. This can be caused by a direct and reflected signal from the same station, or by signals from two stations with close frequencies. If this occurs, select another station until the condition has passed.

Features of your vehicle

Using a cellular phone or a two-way radio

When a cellular phone is used inside the vehicle, noise may be produced from the audio system. This does not mean that something is wrong with the audio equipment. In such a case, try to operate mobile devices as far from the audio equipment as possible.

CAUTION

When using a communication system such as a cellular phone or a radio set inside the vehicle, a separate external antenna must be fitted. When a cellular phone or a radio set is used with an internal antenna alone, it may interfere with the vehicle's electrical system and adversely affect safe operation of the vehicle.

WARNING

Do not use a cellular phone while driving. Stop at a safe location to use a cellular phone.

Caring for disc

- If the temperature inside the car is too high, open the car windows to ventilate before using the system.
- It is illegal to copy and use MP3/WMA files without permission. Use CDs that are created only by lawful means.
- Do not apply volatile agents, such as benzene and thinner, use normal cleaners and magnetic sprays made for analogue disc onto CDs.
- To prevent the disc surface from getting damaged, hold CDs by the edges or the center hole only.
- Clean the disc surface with a piece of soft cloth before playback (wipe it from the center to the outside edge).
- Do not damage the disc surface or attach pieces of sticky tape or paper.
- Make certain only CDs are inserted into the CD player (Do not insert more than one CD at a time).
- Keep CDs in their cases after use to protect them from scratches or dirt.

- Depending on the type of CD-R/CD-RW CDs, certain CDs may not operate normally according to the manufacturing companies. In such circumstances, continued use may cause malfunctions to your audio system.

*** NOTICE - Playing an Incompatible Copy Protected Audio CD**

Some copy protected CDs, which do not comply with international audio CD standards (Red Book), may not play on your car audio. Please note that inability to properly play a copy protected CD may indicate that the CD is defective, not the CD player.

NOTE:

Order of playing files (folders) :

1. Song playing order : ① to ⑭ sequentially.

2. Folder playing order :

* If no song file is contained in the folder, that folder is not displayed.

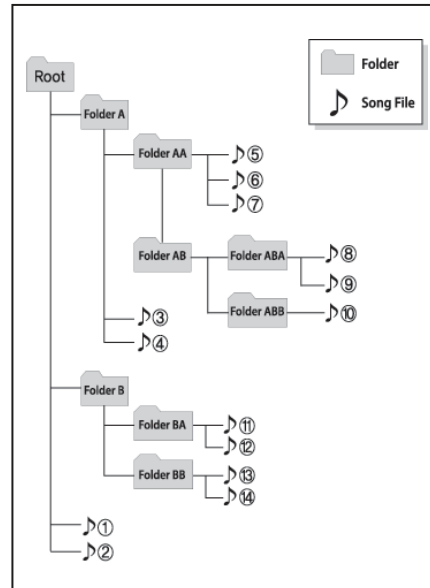
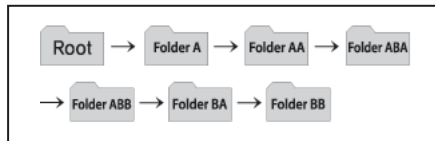

⚠ WARNING

- Do not stare at the screen while driving. Staring at the screen for prolonged periods of time could lead to traffic accidents.
- Do not disassemble, assemble, or modify the audio system. Such acts could result in accidents, fire, or electric shock.
- Using the phone while driving may lead to a lack of attention of traffic conditions and increase the likelihood of accidents. Use the phone feature after parking the vehicle.
- Heed caution not to spill water or introduce foreign objects into the device. Such acts could lead to smoke, fire, or product malfunction.

(Continued)

Features of your vehicle

(Continued)

- Please refrain from use if the screen is blank or no sound can be heard as these signs may indicate product malfunction. Continued use in such conditions could lead to accidents (fires, electric shock) or product malfunctions.
- Do not touch the antenna during thunder or lightning as such acts may lead to lightning induced electric shock.
- Do not stop or park in parking-restricted areas to operate the product. Such acts could lead to traffic accidents.
- Use the system with the vehicle ignition turned on.
Prolonged use with the ignition turned off could result in battery discharge.

CAUTION

- *Operating the device while driving could lead to accidents due to a lack of attention to external surroundings. First park the vehicle before operating the device.*
- *Adjust the volume to levels that allow the driver to hear sounds from outside of the vehicle. Driving in a state where external sounds cannot be heard may lead to accidents.*
- *Pay attention to the volume setting when turning the device on. A sudden output of extreme volume upon turning the device on could lead to hearing impairment. (Adjust the volume to a suitable levels before turning off the device.)*

(Continued)

(Continued)

- *Turn on the car ignition before using this device. Do not operate the audio system for long periods of time with the ignition turned off as such operations may lead to battery discharge.*
- *Do not subject the device to severe shock or impact. Direct pressure onto the front side of the monitor may cause damage to the LCD or touch screen.*
- *When cleaning the device, make sure to turn off the device and use a dry and smooth cloth. Never use tough materials, chemical cloths, or solvents (alcohol, benzene, thinners, etc.) as such materials may damage the device panel or cause color/quality deterioration.*

(Continued)

Features of your vehicle

(Continued)

- ***Do not place beverages close to the audio system. Spilling beverages may lead to system malfunction.***
- ***In case of product malfunction, please contact your closest authorized Hyundai dealer.***
- ***Placing the audio system within an electromagnetic environment may result in noise interference.***
- ***Prevent caustic solutions such as perfume and cosmetic oil from contacting the dashboard because they may cause damage or discoloration.***

Features of your vehicle

* NOTICE - USING THE USB DEVICE

- To use an external USB device, make sure the device is not connected when starting up the vehicle. Connect the device after starting up.
- If you start the engine when the USB device is connected, it may damage the USB device. (USB flashdrives are very sensitive to electric shock.)
- If the engine is started up or turned off while the external USB device is connected, the external USB device may not work.
- The System may not play unauthenticated MP3 or WMA files.
 - 1) It can only play MP3 files with the compression rate between 8Kbps~320Kbps.
 - 2) It can only play WMA music files with the compression rate between 8Kbps~320Kbps.
- Take precautions for static electricity when connecting or disconnecting the external USB device.

(Continued)

(Continued)

- An encrypted MP3 PLAYER is not recognizable.
- Depending on the condition of the external USB device, the connected external USB device can be unrecognizable.
- When the formatted byte/sector setting of External USB device is not either 512BYTE or 2048BYTE, then the device will not be recognized.
- Use only a USB device formatted to FAT 12/16/32.
- USB devices without USB I/F authentication may not be recognizable.
- Make sure the USB connection terminal does not come in contact with the human body or other objects.
- If you repeatedly connect or disconnect the USB device in a short period of time, it may break the device.
- You may hear a strange noise when connecting or disconnecting a USB device.

(Continued)

(Continued)

- If you disconnect the external USB device during playback in USB mode, the external USB device can be damaged or may malfunction. Therefore, disconnect the external USB device when the audio is turned off or in another mode. (e.g, Radio, CD)
- Depending on the type and capacity of the external USB device or the type of the files stored in the device, there is a difference in the time taken for recognition of the device.
- Do not use the USB device for purposes other than playing music files.
- Playing videos through the USB is not supported.
- Use of USB accessories such as rechargers or heaters using USB I/F may lower performance or cause trouble.

(Continued)

Features of your vehicle

(Continued)

- If you use devices such as a USB hub purchased separately, the vehicle's audio system may not recognize the USB device. In that case, connect the USB device directly to the multimedia terminal of the vehicle.
- If the USB device is divided by logical drives, only the music files on the highest-priority drive are recognized by car audio.
- Devices such as MP3 Player/ Cellular phone/Digital camera can be unrecognizable by standard USB I/F can be unrecognizable.
- Charging through the USB may not be supported in some mobile devices.
- USB HDD or USB types liable to connection failures due to vehicle vibrations are not supported. (i-stick type)
- Some non-standard USB devices (METAL COVER TYPE USB) can be unrecognizable.

(Continued)

(Continued)

- Some USB flash memory readers (such as CF, SD, micro SD, etc.) or external-HDD type devices can be unrecognizable.
- Music files protected by DRM (DIGITAL RIGHTS MANAGEMENT) are not recognizable.
- The data in the USB memory may be lost while using this audio. Always back up important data on a personal storage device.
- Please avoid using USB memory products which can be used as key chains or cellular phone accessories as they could cause damage to the USB jack. Please make certain only to use plug type connector products.



Features of your vehicle

* NOTICE - USING THE iPod® DEVICE

- Some iPod® models may not support communication protocol and files may not properly play.

Supported iPod® models:

- iPhone® 3GS/4
- iPod® touch 1st~4th generation
- iPod® nano 1st~6th generation
- iPod® classic
- The order of search or playback of songs in the iPod® can be different from the order searched in the audio system.
- If the iPod® is disabled due to its own malfunction, reset the iPod®. (Reset: Refer to iPod® manual)
- An iPod® may not operate normally on low battery.

(Continued)

(Continued)

- Some iPod® devices, such as the iPhone®, can be connected through the *Bluetooth*® Wireless Technology interface. The device must have audio *Bluetooth*® Wireless Technology capability (such as for stereo headphone *Bluetooth*® Wireless Technology). The device can play, but it will not be controlled by the audio system.
- To use iPod® features within the audio, use the cable provided upon purchasing an iPod® device.
- Skipping or improper operation may occur depending on the characteristics of your iPod®/iPhone® device.
- If your iPhone® is connected to both the *Bluetooth*® Wireless Technology and USB, the sound may not be properly played. In your iPhone®, select the Dock connector or *Bluetooth*® Wireless Technology to change the sound output (source).

(Continued)

(Continued)

- When connecting iPod® with the iPod® Power Cable, insert the connector to the multimedia socket completely. If not inserted completely, communications between iPod® and audio may be interrupted.
- When adjusting the sound effects of the iPod® and the audio system, the sound effects of both devices will overlap and might reduce or distort the quality of the sound.
- Deactivate (turn off) the equalizer function of an iPod® when adjusting the audio system's volume, and turn off the equalizer of the audio system when using the equalizer of an iPod®.
- When not using iPod® with car audio, detach the iPod® cable from iPod®. Otherwise, iPod® may remain in accessory mode, and may not work properly.

* NOTICE - *Bluetooth*[®] Wireless Technology

- The *Bluetooth*[®] word mark and logos are registered trademarks owned by Bluetooth SIG, Inc. and any use of such marks is under license.
A *Bluetooth*[®] enabled call phone is required to use *Bluetooth*[®] wireless technology.
- *Bluetooth*[®] Wireless Technology phone compatibility can be checked by visiting www.hyundaiusa.com and under the SERVICE & PARTS - BLUETOOTH COMPATIBILITY menu.

* NOTICE - BEFORE USING THE *Bluetooth*[®] HANDSFREE

What is Bluetooth[®] ?

- *Bluetooth*[®] refers to a short-distance wireless networking technology which uses a 2.4GHz ~ 2.48GHz frequency to connect various devices within a certain distance.
- Supported within PCs, external devices, *Bluetooth*[®] phones, PDAs, various electronic devices, and automotive environments, *Bluetooth*[®] allows data to be transmitted at high speeds without having to use a connector cable.
- *Bluetooth*[®] Handsfree refers to a device which allows the user to conveniently make phone calls with *Bluetooth*[®] mobile phones through the audio system.
- *Bluetooth*[®] Handsfree may not be supported in some mobile phones. To learn more about mobile device compatibility, visit www.hyundaiusa.com.

* NOTICE - PRECAUTIONS FOR SAFE DRIVING

- *Bluetooth*[®] is a feature that enables drivers to use handsfree while driving.
Connecting the head unit with a *Bluetooth*[®] phone allows the user to conveniently make and receive calls and use contacts. Before using *Bluetooth*[®], carefully read the contents of this user's manual.
- Excessive use or operations while driving may lead to negligent driving practices and result in accidents. Refrain from excessive operations while driving.
- Viewing the screen for prolonged periods of time is dangerous and may lead to accidents. When driving, view the screen only for short periods of time.

Features of your vehicle

*** NOTICE - WHEN CONNECTING A *Bluetooth*[®] PHONE**

- Before connecting the head unit with the mobile phone, check to see that the mobile phone supports *Bluetooth*[®] features.
- Even if the phone supports *Bluetooth*[®], the phone will not be found during device searches if the phone has been set to hidden state or the *Bluetooth*[®] power is turned off. Disable the hidden state or turn on the *Bluetooth*[®] power prior to searching/connecting with the Head unit.
- *Bluetooth* phone is automatically connected when the ignition is turned on.
- If you do not want automatic connection with your *Bluetooth*[®] device, turn off the *Bluetooth*[®] feature within your mobile phone.
- The Handsfree call volume and quality may differ depending on the mobile phone.

(Continued)

(Continued)

- Park the vehicle when connecting the head unit with the mobile phone.
- *Bluetooth*[®] connection may become intermittently disconnected in some mobile phones. Follow these steps to try again.
 1. Within the mobile phone, turn the *Bluetooth*[®] function off/on and try again.
 2. Turn the mobile phone power Off/On and try again.
 3. Completely remove the mobile phone battery, reboot, and then again.
 4. Reboot the Audio System and try again.
 5. Delete all paired devices, pair and try again.
- Handsfree call quality and volume may differ depending on the model of your mobile phone.

*** NOTICE - USING THE VOICE RECOGNITION**

- When using the voice recognition feature, only commands listed within the user's manual are supported.
- Be aware that during the operation of the voice recognition system, pressing any key other than the  key terminates voice recognition mode.
- For superior voice recognition performance, position the microphone used for voice recognition above the head of the driver's seat and maintain a proper position when saying commands.
- Within the following situations, voice recognition may not function properly due to external sound.
 - When the windows and sunroof are open
 - When the wind of the cooling / heating device is strong
 - When entering and passing through tunnels

(Continued)

(Continued)

- When driving on rugged and uneven roads
- During severe rain (heavy rains, windstorms)
- Phone related voice commands can be used only when a *Bluetooth*[®] Wireless Technology device is connected.
- When making calls by stating a name, the corresponding contact must be downloaded and stored within the audio system.
- After downloading the *Bluetooth*[®] Wireless Technology phone book, it takes some time to convert the phone book data into voice information. During this time, voice recognition may not properly operate.
- Pronounce the voice commands naturally and clearly as if in a normal conversation.

Features of your vehicle

SYSTEM CONTROLLERS AND FUNCTIONS

Audio Head Unit



1. (EJECT)

- Ejects the disc.

2. **RADIO**

- Changes to FM/AM/XM mode.
- Each time the key is pressed, the mode is changed in order of FM1 → FM2 → AM → XM1 → XM2 → XM3
- * In Setup>Display, the radio pop up screen will be displayed when



[Mode Pop up] is turned .

When the pop up screen is displayed, use the  TUNE knob or keys  ~  to select the desired mode.

3. **MEDIA**

- Changes to CD, USB, iPod, AUX, My Music, BT Audio modes.
- Each time the key is pressed, the mode is changed in order of CD, USB, iPod, AUX, My Music, BT Audio modes.



* In Setup>Display, the media pop up screen will be displayed when [Mode Pop up] is turned .

When the pop up screen is displayed, use the  TUNE knob or keys  ~  to select the desired mode.



4. **PHONE**

- Operates Phone Screen
- * When a phone is not connected, the connection screen is displayed.

5. POWER/VOL knob

-  Power Knob: Turns power On/Off by pressing the knob
-  Volume Knob: Sets volume by turning the knob left/right

6. ~ (Preset)

- Radio Mode: Saves frequencies (channels) or receives saved frequencies (channels)
- CD, USB, iPod, My Music mode
 -  : Repeat
 -  : Random
- In the Radio, Media, Setup, and Menu pop up screen, the number menu is selected.

7.

- Radio Mode : Automatically searches for broadcast frequencies.
- CD, USB, iPod, My Music modes :
 - Shortly press the key (under 0.8 seconds): Moves to next or previous song(file)
 - Press and hold the key (over 0.8 seconds): Rewinds or fast-forwards the current song(file)

Features of your vehicle

8. **DISP**

- Each time the button is shortly pressed (under 0.8 seconds), it sets the screen Off → Screen On → Screen Off
- * Audio operation is maintained and only the screen will be turned Off. In the screen Off state, press any key to turn the screen On again.

9. **SCAN**

- Radio Mode
 - Shortly press the key (under 0.8 seconds): Previews each broadcast for 5 seconds each
 - Press and hold the key (over 0.8 seconds): Previews the broadcasts saved in Preset **1** ~ **6** for 5 seconds each.
- * Press the **SCAN** key again to continue listening to the current frequency.
- * SiriusXM™ Radio does not support the Preset scan feature.
- CD, USB, iPod mode
 - Shortly press the key (under 0.8 seconds): Previews each song (file) for 10 seconds each
- * Press the **SCAN** key again to continue listening to the current song (file).

10. **SETUP**

- Shortly press the key (under 0.8 seconds) : Moves to the Display, Sound, Phone, System setting modes

11. **MENU**

- Displays menus for the current mode.

12. **TUNE** knob

- Radio mode : Changes frequency by turning the knob left/right
- CD, USB, iPod mode: Searches songs (files) by turning the knob left/right
- * When the desired song is displayed, press the knob to play the song.
- Moves focus in all selection menus and selects menus

13. **CAT FOLDER**

- Radio Mode
 - SiriusXM™ RADIO : Category Search
- MP3, CD, USB mode : Folder Search
- iPod mode: Moves to parent folder
- * May differ depending on the selected audio.

Features of your vehicle

Audio Head Unit (For NON Bluetooth model)

14. **FM/AM**

- Changes to FM mode.
- Each time the key is pressed, the mode changed in order of FM1 → FM2 → AM.

15. **SAT**

- Changes to SiriusXM™ mode.

SYSTEM CONTROLLERS AND FUNCTIONS

Audio Head Unit



1. (EJECT)

- Ejects the disc.

2. RADIO

- Changes to FM/AM/XM mode.
- Each time the key is pressed, the mode is changed in order of FM1 → FM2 → AM



* In Setup>Display, the radio pop up screen will be displayed when [Mode Pop up] is turned .

When the pop up screen is displayed, use the  TUNE knob or keys  ~  to select the desired mode.

3. MEDIA

- Changes to CD, USB, iPod, AUX, My Music, BT Audio modes.
- Each time the key is pressed, the mode is changed in order of CD, USB, iPod, AUX, My Music, BT Audio modes.

* In Setup>Display, the media pop up screen will be displayed when [Mode Pop up] is turned .



When the pop up screen is displayed, use the  TUNE knob or keys  ~  to select the desired mode.

4. PHONE



- Operates Phone Screen

* When a phone is not connected, the connection screen is displayed.

5. POWER/VOL knob

-  Power Knob: Turns power On/Off by pressing the knob
-  Volume Knob: Sets volume by turning the knob left/right

6. ~ (Preset)

- Radio Mode: Saves frequencies (channels) or receives saved frequencies (channels)
- CD, USB, iPod, My Music mode
 -  : Repeat
 -  : Random
- In the Radio, Media, Setup, and Menu pop up screen, the number menu is selected.

7.

- Radio Mode : Automatically searches for broadcast frequencies.
- CD, USB, iPod, My Music modes :
 - Shortly press the key (under 0.8 seconds): Moves to next or previous song(file)
 - Press and hold the key (over 0.8 seconds): Rewinds or fast-forwards the current song(file)

Features of your vehicle

8. **DISP**

- Each time the button is shortly pressed (under 0.8 seconds), it sets the screen Off → Screen On → Screen Off
- * Audio operation is maintained and only the screen will be turned Off. In the screen Off state, press any key to turn the screen On again.

9. **SCAN**

- Radio Mode
- Shortly press the key (under 0.8 seconds): Previews each broadcast for 5 seconds each
- Press and hold the key (over 0.8 seconds): Previews the broadcasts saved in Preset **1** ~ **6** for 5 seconds each.
- * Press the **SCAN** key again to continue listening to the current frequency.
- * XM Radio does not support the Preset scan feature.
- CD, USB, iPod mode
- Shortly press the key (under 0.8 seconds): Previews each song (file) for 10 seconds each
- * Press the **SCAN** key again to continue listening to the current song (file).

10. **SETUP**

- Shortly press the key (under 0.8 seconds) : Moves to the Display, Sound, Phone, System setting modes

11. **MENU**

- Displays menus for the current mode.

12. **TUNE** knob

- Radio mode : Changes frequency by turning the knob left/right
- CD, USB, iPod mode: Searches songs (files) by turning the knob left/right
- * When the desired song is displayed, press the knob to play the song.
- Moves focus in all selection menus and selects menus

13. **FOLDER**

- MP3, CD, USB mode : Folder Search
- iPod mode: Moves to parent folder
- * May differ depending on the selected audio.

Audio Head Unit (For NON Bluetooth model)

14. **FM**

- Changes to FM mode.
- Each time the key is pressed, the mode changed in order of FM1 → FM2.

15. **AM**

- Changes to AM mode.

Features of your vehicle

SETUP

Display Settings

Press the **SETUP** key ▶ Select [Display] through **TUNE** knob or **RPT** key ▶ Select menu through **TUNE** knob



Mode Pop up

[Mode Pop up] ▶ Changes **On**/**Off** selection mode

- During On state, press the **RADIO** or **MEDIA** key to display the mode change pop up screen.

Media Display

When playing an MP3 file, select the desired display info from 'Folder/File' or 'Album/Artist/Song'.



Features of your vehicle

SOUND SETTINGS

Press the **SETUP** key ▶ Select [Sound] through **TUNE** knob or **2RDM** key ▶ Select menu through **TUNE** knob

Sound Settings

This menu allows you to set the 'Bass, Middle, Treble' and the Sound Fader and Balance.

Select [Sound Settings] ▶ Select menu through **TUNE** knob ▶ Turn **TUNE** knob left/right to set

- Bass, Middle, Treble : Selects the sound tone.
- Fader, Balance : Moves the sound fader and balance.
- Default : Restores default settings.
- * Back : While adjusting values, pressing the **TUNE** knob will restore the parent menu.

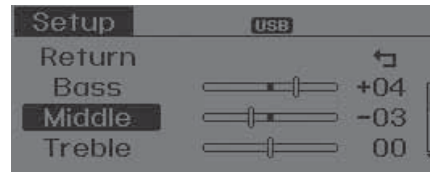

Speed Dependent Volume Control

This feature is used to automatically control the volume level according to the speed of the vehicle.

Select [SDVC] ▶ Turn SDVC On/Off by pressing the **TUNE** knob.



Voice Recognition Volume

Adjusts voice recognition volume.

Select [Voice Recognition Vol.] ▶ Set volume of **TUNE** knob



Features of your vehicle

SYSTEM SETTINGS

Press the **SETUP** key ▶ Select [System] through tune knob or **4** key ▶ Select menu through **TUNE** knob

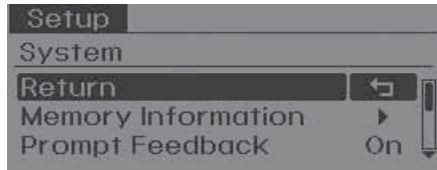

Memory Information

Displays currently used memory and total system memory.

Select [Memory Information] ▶ OK

The currently used memory is displayed on the left side while the total system memory is displayed on the right side.



Prompt Feedback

This feature is used to change voice command feedback between Normal and Expert modes.

Select [Prompt Feedback] ▶ Set through **TUNE** knob

- Normal(On) : This mode is for beginner users and provides detailed instructions during voice command operation.

- Expert(Off) : This mode is for expert users and omits some information during voice command operation. (When using Expert mode, guidance instructions can be heard through the [Help] or [Menu] commands.

Language

This menu is used to set the display and voice recognition language.

Select [Language] ▶ Set through **TUNE** knob



- * The system will reboot after the language is changed.
- * Language support by region
 - English, Francais, Espanol

Features of your vehicle

RADIO : FM, AM OR SIRIUSXM™



SEEK

Press the **SEEK TRACK** key

- Shortly pressing the key (under 0.8 seconds): Changes the frequency.
- Pressing and holding the key (over 0.8 seconds): Automatically searches for the next frequency.

Preset SEEK

Press the **1** ~ **6** key

- Shortly pressing the key (under 0.8 seconds): Plays the frequency saved in the corresponding key.
- Pressing and holding the key (over 0.8 seconds): Pressing and holding the desired key from **1** ~ **6** will save the currently playing broadcast to the selected key and sound a BEEP.

SCAN

Press the **SCAN** key

- Shortly pressing the key (under 0.8 seconds): The broadcast frequency increases and previews each broadcast for 5 seconds each. After scanning all frequencies, returns and plays the current broadcast frequency.
- Pressing and holding the key (over 0.8 seconds): Previews the broadcasts saved in Preset **1** ~ **6** for 5 seconds each.

Selecting through manual search

Turn the **TUNE** knob left/right to adjust the frequency.

- FM : Changes by 200kHz
- AM : Changes by 10kHz

MENU

Within **MENU** key are the A.Store (Auto Store) and Info functions.



1 A.Store

Press the **MENU** key ▶ Set [A.Store] through **TUNE** knob or **1 RPT** key
Saves broadcasts with superior reception to **1** ~ **6** keys. If no frequencies are received, then the most recently received frequency will be broadcast.

Features of your vehicle

SIRIUSXM™ RADIO

Using XM satellite Radio

Your vehicle is equipped with a 3 month complimentary period of XM Satellite Radio. XM provides access to over 130 channels of music, information, and entertainment programming.

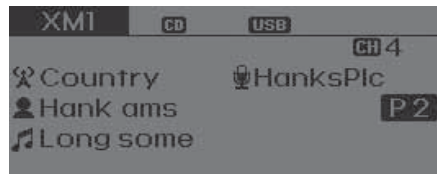

SEEK

Press the **SEEK TRACK** key

- Shortly pressing the key (under 0.8 seconds): select previous or next channel.
- Pressing and holding the key (over 0.8 seconds): continuously move to previous or next channel.
- * If the "Category" icon is displayed, channels are changed within the current category.

SCAN

Press the **SCAN** key

- Shortly pressing the key (under 0.8 seconds): Previews each broadcast for 10 seconds each
- * Press the **SCAN** key again to continue listening to the current frequency
- * If the "Category" icon is displayed, channels are changed within the current category.

Category

Press the **CAT FOLDER** key ▶ Set through the **TUNE** knob



- The display will indicate the category menus, highlight the category that the current channel belongs to.
- In the Category List Mode, press the **CAT FOLDER** key to navigate category list.
- Press the tune knob to select the lowest channel in the highlighted category.
- * If channel is selected by selecting category, then the "CATEGORY" icon is displayed at the top of the screen.

Features of your vehicle

Preset

Press the **1** ~ **6** key

- Shortly pressing the key (under 0.8 seconds): Plays the frequency saved in the corresponding key.
- Pressing and holding the key (over 0.8 seconds): Pressing and holding the desired key from **1** ~ **6** will save the current broadcast to the selected key and sound a BEEP.

Tune

- Rotate **TUNE** knob : Changes the channel number or scrolls category list.
- Press **TUNE** knob : Selects the menu.

Menu

Select category menu through the **TUNE** knob ▶ Press the **MENU** key
▶ Select **[Info]** through the **TUNE** knob or **1 RPT** key

Info (Information)



Displays the Artist/Song info of the current song.

Features of your vehicle

BASIC METHOD OF USE : Audio CD / MP3 CD / USB / iPod® / My Music

Press the **MEDIA** key to change the mod mode in order of CD → USB(iPod®) → AUX → My Music → BT Audio.



The folder/file name is displayed on the screen.

- * The CD is automatically played when a CD is inserted.
- * The USB music is automatically played when a USB is connected.



Repeat

While song (file) is playing ▶ **1 RPT** (RPT) key

Audio CD, MP3 CD, USB, iPod®, My Music mode: RPT on screen

- To repeat one song (Shortly pressing the key (under 0.8 seconds)): Repeats the current song.

MP3 CD, USB mode: FLD.RPT on screen

- To repeat folder (Pressing the key twice).

* Press the **1 RPT** key again to turn off repeat.

Random

While song (file) is playing ▶ **2 RDM** (RDM) key

Audio CD, iPod®, My Music mode: RDM on screen

- Random (press the key : Plays all songs in random order.

MP3 CD, USB mode: FLD.RDM on screen

- Folder Random (press the key : Plays all files within the current folder in random order.

MP3 CD, USB mode : ALL RDM on screen

- All Random (pressing twice): Plays all files in random order.

* Press the **2 RDM** key again to turn off repeat.

Features of your vehicle

Changing Song/File

While song (file) is playing ▶  key

- Shortly pressing the key (under 0.8 seconds): Plays the current song from the beginning.
- * If the  key is pressed again within 1 second, the previous song is played.
- Pressing and holding the key (over 0.8 seconds): Rewinds the song.

While song (file) is playing ▶  key

- Shortly pressing the key (under 0.8 seconds): Plays the next song.
- Pressing and holding the key (over 0.8 seconds): Fast forwards the song.

Scan

While song (file) is playing ▶  key
Scans all songs for 10 seconds starting from the next song.

- * Press the  key again to turn off.
- * The SCAN function is not supported in iPod mode.

Folder Search : MP3 CD, USB Mode



While file is playing ▶  key
(Folder Up) key

- Searches the next folder.

While file is playing ▶  key
(Folder Down) key

- Searches the previous folder.
- * If a folder is selected by pressing the  TUNE knob, the first file within the selected folder will be played.

Searching Songs (File)

- Turning  TUNE knob : Searches for songs (files)
- Pressing  TUNE knob : Plays selected song (file).

Features of your vehicle

MENU : Audio CD

Press the CD MP3 mode **MENU** key to set the Repeat, Random, Information features.



Repeat

Press the **MENU** key ▶ Set [**1 RPT**] through the **TUNE** knob or **1 RPT** key to repeat the current song.

* Press RPT again to turn off.

Random

Press the **MENU** key ▶ Set [**2 RDM**] through the **TUNE** knob or **2 RDM** key to randomly play songs within the current folder.

* Press RDM again to turn off.

Information

Press the **MENU** key ▶ Set [**3 Info**] through the **TUNE** knob or **3** key to display information of the current song.

* Press the **MENU** key to turn off info display.

Features of your vehicle

MENU : MP3 CD / USB

Press the CD MP3 mode **MENU** key to set the Repeat, Folder Random, Folder Repeat, All Random, Information, and Copy features.



Repeat

Press the **MENU** key ▶ Set [**1**RPT] through the **TUNE** knob or **1 RPT** key to repeat the current song.

* Press RPT again to turn off.

Folder Random

Press the **MENU** key ▶ Set [**2**F.RDM] through the **TUNE** knob or **2 RDM** key to randomly play songs within the current folder.

* Press F.RDM again to turn off.

Folder Repeat

Press the **MENU** key ▶ Set [**3**F.RPT] through the **TUNE** knob or **3** key to repeat songs within the current folder.

* Press F.RPT again to turn off.

All Random

Press the **MENU** key ▶ Set [**4**A.RDM] through the **TUNE** knob or **4** key to randomly play all songs within the CD.

* Press A.RDM again to turn off.

Information

Press the **MENU** key ▶ Set [**5**Info] through the **TUNE** knob or **5** key to display information of the current song.

* Press the **MENU** key to turn off info display.

Copy

Press the **MENU** key ▶ Set [**6**Copy] through the **TUNE** knob or **6** key.

This is used to copy the current song into My Music. You can play the copied Music in My Music mode.

* If another key is pressed while copying is in progress, a pop up asking you whether to cancel copying is displayed.

* If another media is connected or inserted (USB, CD, iPod®, AUX) while copying is in progress, copying is canceled.

* Music will not be played while copying is in progress.

Features of your vehicle

MENU : iPod®

In iPod® mode, press the **MENU** key to set the Repeat, Random, Information and Search features.

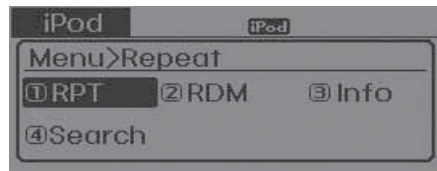

Repeat

Press the **MENU** key to Set [**1 RPT**] through the **TUNE** knob or **1 RPT** key to repeat the current song.

* Press RPT again to turn repeat off.

Random

Press the **MENU** key to Set [**2 RDM**] through the **TUNE** knob or **2 RDM** key.

Plays all songs within the currently playing category in random order.

* Press RDM again to turn off.

Information

Press the **MENU** key to Set [**3 Info**] through the **TUNE** knob or **3** key.

Displays information of the current song.

* Press the **MENU** key to turn off info display.

Search

Press the **MENU** key to Set [**4 Search**] through the **TUNE** knob or **4** key.

Displays iPod® category list.

* Searching iPod® category is **MENU** key pressed, move to parent category.

MENU : My Music Mode

In My Music mode, press the **MENU** key to set the Repeat, Random, Information, Delete, Delete All, and Delete Selection features.

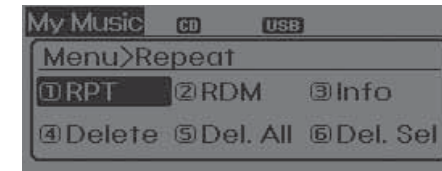

Repeat

Press the **MENU** key to Set [**1 RPT**] through the **TUNE** knob or **1 RPT** key. Repeats the currently playing song.

* Press RPT again to turn repeat off.

Random

Press the **MENU** key to Set [**2 RDM**] through the **TUNE** knob or **2 RDM** key.

Plays all songs within the currently playing folder in random order.

* Press RDM again to turn random off.

Features of your vehicle

Information

Press the **MENU** key ▶ Set [**3**Info] through the **TUNE** knob or **3** key. Displays information of the current song.

* Press the **MENU** key to turn off info display.

Delete

Press the **MENU** key ▶ Set [**4**Delete] through the **TUNE** knob or **4** key.

- Deletes currently playing file

In the play screen, pressing delete will delete the currently playing song.

- Deletes file from list

① Select the file you wish to delete by using the **TUNE** knob.

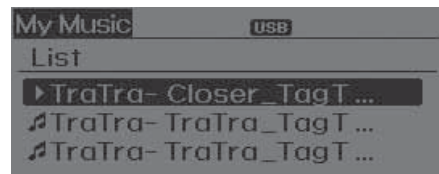

② Press the **MENU** key and select the delete menu to delete the selected file.

Delete All

Press the **MENU** key ▶ Set [**5**Del.All] through the **TUNE** knob or **5** key. Deletes all songs of My Music.

Delete Selection

Press the **MENU** key ▶ Set [**6**Del.Sel] through the **TUNE** knob or **6** key. Songs within My Music are selected and deleted.

① Select the songs you wish to delete from the list.

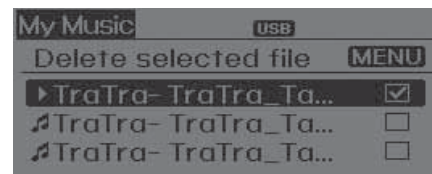

② After selecting, press the **MENU** key and select the delete menu.

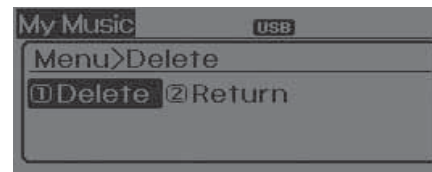

AUX

AUX is used to play external MEDIA currently connected with the AUX terminal.

AUX mode will automatically start when an external device is connected to the AUX terminal.

If an external device is connected, you can also press the **MEDIA** key to change to AUX mode.



* AUX mode cannot be started unless there is an external device connected to the AUX terminal.

Features of your vehicle

Bluetooth® Wireless Technology AUDIO

What is Bluetooth® Wireless Technology?

Bluetooth® Wireless Technology allows devices to be connected in a short distance, including hands-free devices, stereo headsets, wireless remote controllers, etc. For more information, visit the Bluetooth® Wireless Technology website at www.Bluetooth.com

Before using Bluetooth® Wireless Technology audio features

- Bluetooth® Wireless Technology audio may not be supported depending on the compatibility of your Bluetooth® Wireless Technology mobile phone.
- In order to use Bluetooth® Wireless Technology audio, you must first pair and connect the Bluetooth® Wireless Technology mobile phone.

- Bluetooth® Wireless Technology audio can be used only when the [Audio Streaming] of Phone is turned On.

* Setting Bluetooth® Wireless Technology Audio Streaming : Press the **SETUP** key ▶ Select [Phone] through the tune knob or **3** key ▶ Select [Audio Streaming] through the TUNE knob ▶ Set On / Off

Starting Bluetooth® Wireless Technology Audio

- Press the **MEDIA** key to change the mode in order of CD → USB → AUX → My Music → BT Audio.
- If BT Audio is selected, Bluetooth® Wireless Technology audio will start playing.
- * Audio may not automatically start playing in some mobile phones.

Using the Bluetooth® Wireless Technology audio features

- Play / Stop

Press the TUNE knob to play and pause the current song.

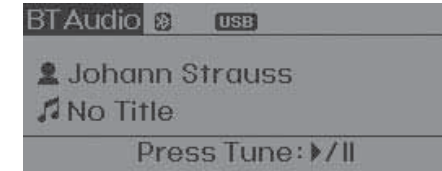

- * The play / pause functions may not be supported in some mobile phones.

PHONE (IF EQUIPPED)

Before using the *Bluetooth*[®] Wireless Technology phone features

- In order to use *Bluetooth*[®] Wireless Technology phone, you must first pair and connect the *Bluetooth*[®] Wireless Technology mobile phone.
- If the mobile phone is not paired or connected, it is not possible to enter Phone mode. Once a phone is paired or connected, the guidance screen will be displayed.
- If Priority is set upon vehicle ignition (IGN/ACC ON), the *Bluetooth*[®] Wireless Technology phone will be automatically connected. Even if you are outside, the first *Bluetooth*[®] Wireless Technology phone will be automatically connected once you are in the vicinity of the vehicle. If you do not want automatic *Bluetooth*[®] Wireless Technology phone connection, set the *Bluetooth*[®] Wireless Technology power to OFF.

Making a call using the Steering wheel remote controller

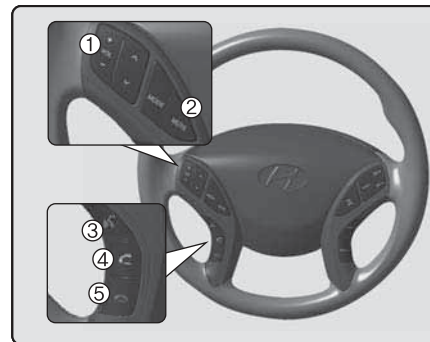

* The actual feature in the vehicle may differ from the illustration.

1. VOLUME button : Raises or lowers speaker volume.
2. MUTE button : Mutes the microphone during a call.
3. button : Activates voice recognition.
4. button : Places and transfers calls.
5. button : Ends calls or cancels functions.

- Check call history and making call

- ① Shortly press (under 0.8 seconds) the key on the steering remote controller.
- ② The call history list will be displayed on the screen.
- ③ Press the key again to connect a call to the selected number.

- Redialing the most recently called number

- ① Press and hold (over 0.8 seconds) the key on the steering remote controller.
- ② The most recently called number is redialed.

Features of your vehicle

Bluetooth® Wireless Technology

Pairing a Bluetooth® Wireless Technology Device

What is Bluetooth® Wireless Technology Pairing?

Pairing refers to the process of synchronizing your *Bluetooth®* Wireless Technology phone or device with the car audio system for connection. Pairing is necessary to connect and use the *Bluetooth®* Wireless Technology feature.

⚠ WARNING

Driving while distracted can result in a loss of vehicle control that may lead to an accident, severe personal injury, and death. The driver's primary responsibility is in the safe and legal operation of a vehicle, and use of any handheld devices, other equipment, or vehicle systems which take the driver's eyes, attention and focus away from the safe operation of a vehicle or which are not permissible by law should never be used during operation of the vehicle.

Pairing **PHONE** Key / Key on the Steering Remote Controller

When No Devices have been Paired

1. Press the **PHONE** key or the  key on the steering remote controller. The following screen is displayed.



2. Select [OK] button to enter the Pair Phone screen.

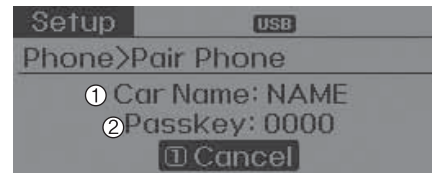

- 1) Car Name : Name of device as shown when searching from your *Bluetooth*[®] Wireless Technology device
- 2) Passkey : Passkey used to pair the device
3. From your *Bluetooth*[®] Wireless Technology device (i.e. Mobile Phone), search and select your car audio system.

[Non SSP supported device]

(SSP: Secure Simple Pairing)

4. After a few moments, a screen is displayed where the passkey is entered.
Hear, enter the passkey "0000" to pair your *Bluetooth*[®] Wireless Technology device with the car audio system.

[SSP supported device]

4. After a few moments, a screen is displayed 6 digits passkey .
Hear, check the passkey on your *Bluetooth*[®] Wireless Technology device and confirm.



5. Once pairing is complete, the following screen is displayed.

Features of your vehicle

During the pairing process, make sure that all connection requests on the phone are accepted for phonebook download and to allow acceptance of all future connection requests. Visit <http://www.hyundaiusa.com/Bluetooth> for additional information on pairing your Bluetooth-enabled mobile phone, and to view a phone compatibility list.

* NOTICE



If **Bluetooth®** Wireless Technology devices are paired but none are currently connected, pressing the **PHONE** key or the  key on the steering wheel displays the following screen. Select [Pair] button to pair a new device or select [Connect] to connect a previously paired device.

Pairing through [PHONE] Setup

Press the **SETUP** key ▶ Select [Phone] ▶ Select [Pair Phone] ▶ Select **TUNE** knob



1. The following steps are the same as those described in the section "When No Devices have been Paired" on the previous page.

* NOTICE

- **Bluetooth®** Wireless Technology features supported within the vehicle are as follows. Some features may not be supported depending on your **Bluetooth®** Wireless Technology device.
 - **Outgoing/Incoming Handsfree calls**

- **Operations during a call (Switch to Private, Switch to call waiting, MIC on/off)**
- **Downloading Call History**
- **Downloading Mobile Contacts**
- **Bluetooth®** Wireless Technology device auto connection
- **Bluetooth Audio Streaming**
- **Up to five Bluetooth®** Wireless Technology devices can be paired to the Car Handsfree system.
- **Only one Bluetooth®** Wireless Technology device can be connected at a time.
- **Other devices cannot be paired while a Bluetooth®** Wireless Technology device is connected.
- **Only Bluetooth®** Wireless Technology Handsfree and Bluetooth audio related features are supported.
- **Bluetooth** related operations are possible only within devices that support Handsfree or audio features, such as a **Bluetooth®** Wireless Technology mobile phone or a Bluetooth audio device.
- **If a connected Bluetooth®** Wireless Technology device becomes disconnected due to being out of communication range, turning the device OFF, or a **Bluetooth®** Wireless Technology communication error, corresponding **Bluetooth®** Wireless Technology devices are automatically searched and reconnected.
- **If the system becomes unstable due to communication errors between the car Handsfree and the Bluetooth®** Wireless Technology device, reset the device by turning off and back on again. Upon resetting **Bluetooth®** Wireless Technology device, the system will be restored.
- **After pairing is complete, a contacts download request is sent once to the mobile phone. Some mobile phones may require confirmation upon receiving a download request, ensure your mobile phone accepts the connection. Refer to your phones user's manual for additional information regarding phone pairing and connections.**

Features of your vehicle

Connecting a Device

Press the **SETUP** key ▶ Select [Phone] ▶ Select [Paired Phone List]

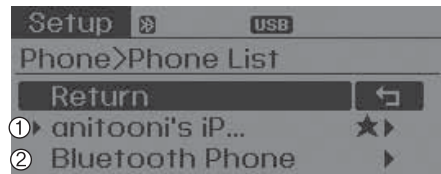

- 1) Connected Phone : Device that is currently connected
- 2) Paired Phone : Device that is paired but not connected

From the paired phone list, select the device you want to connect and select [Connect].

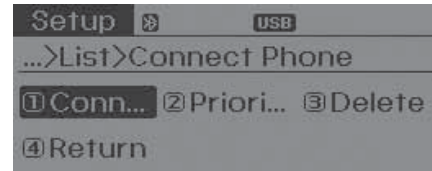

Changing Priority

What is Priority?

It is possible to pair up to five *Bluetooth*® Wireless Technology devices with the car audio system. The "Change Priority" feature is used to set the connection priority of paired phones.

Press the **SETUP** key ▶ Select [Phone] ▶ Select [Paired Phone List]

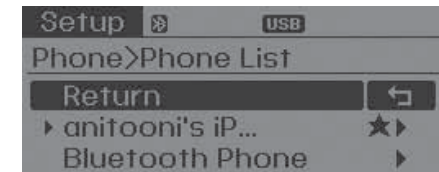

Features of your vehicle

From the paired phone list, select the phone you want to switch to the highest priority, then select [Change Priority] button from the Menu. The selected device will be changed to the highest priority.

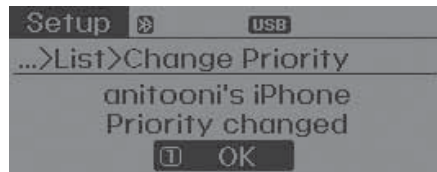
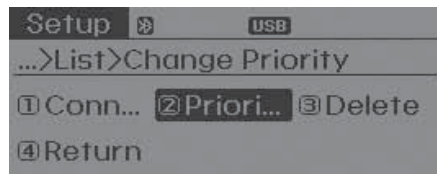

* NOTICE

Priority icon will be displayed when the selected phone is set as a priority phone.



Disconnecting a Device

Press the **SETUP** key ▶ Select [Phone] ▶ Select [Paired Phone List]

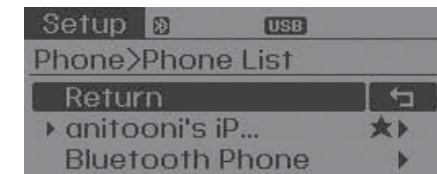

From the paired phone list, select the currently connected device and select [Disconnect] button.

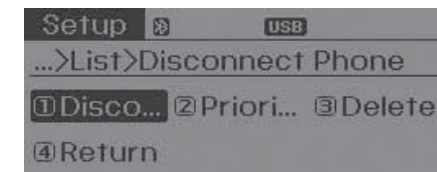

Features of your vehicle

Deleting a Device

Press the **SETUP** key ▶ Select [Phone] ▶ Select [Paired Phone List]

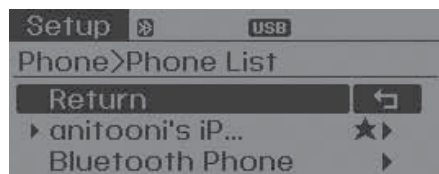

From the paired phone list, select the device you want to delete and select [Delete] button.

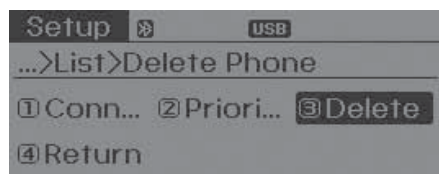

* NOTICE

- When deleting the currently connected device, the device will automatically be disconnected to proceed with the deleting process.
- If a paired *Bluetooth*® Wireless Technology device is deleted, the device's call history and contacts data will also be deleted.
- To re-use a deleted device, you must pair the device again.

USING *Bluetooth*[®] WIRELESS TECHNOLOGY (IF EQUIPPED)

Phone Menu Screen

Phone Menus

With a *Bluetooth*[®] Wireless Technology device connected, press the **PHONE** key to display the Phone menu screen.

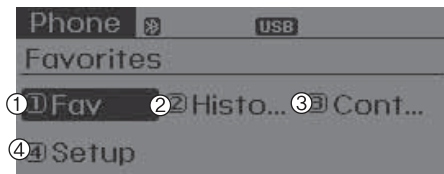

- 1) Favorite : Up to 20 frequently used contacts saved for easy access
- 2) Call History : Device the call history list screen
- 3) Contacts : Displays the Contacts list screen
- 4) Setup : Displays Phone related settings.

* NOTICE

- If you select the [Call History] button but there is no call history data, a prompt is displayed which asks to download call history data.
- If you select the [Contacts] button but there is no contacts data stored, a prompt is displayed which asks to download contacts data.
- This feature may not be supported in some mobile phones. For more information on download support, refer to your mobile phone user's manual.

Answering Calls

Answering a Call

Answering a call with a *Bluetooth*[®] Wireless Technology device connected will display the following screen.

To accept the call, press  key on the steering wheel while the call is incoming.

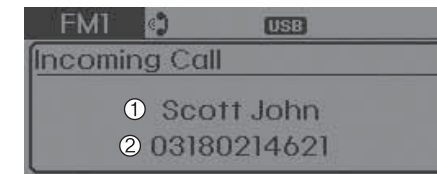

- 1) Caller : Displays the other party's name when the incoming caller is saved within your contacts
- 2) Incoming Number : Displays the incoming number

Features of your vehicle

* NOTICE

- When an incoming call pop-up is displayed, most Audio and SETUP mode features are disabled. Only the call volume will operate.
- The telephone number may not be properly displayed in some mobile phones.
- When a call is answered with the mobile phone, the call mode will automatically revert to Private mode.

Favorites

Press the **PHONE** key ▶ Select [Favorites]

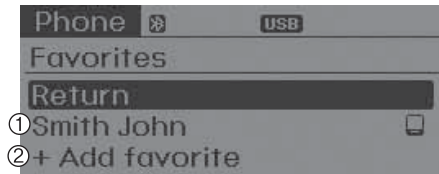

- 1) Saved favorite contact : Connects call upon selection
- 2) To add favorite : Downloaded contacts be saved as favorite.

* NOTICE

- To save Favorite, contacts should be downloaded.
- Contact saved in Favorites will not be automatically updated if the contact has been updated in the phone. To update Favorites, delete the Favorite and create a new Favorite.

Call History

Press the **PHONE** key ▶ Select [Call History]



A list of incoming, outgoing and missed calls is displayed.

- Call history may not be saved in the call history list in some mobile phones.
- Calls received with hidden caller ID will not be saved in the call history list.
- Calling through the call history is not possible when there is no call history stored or a *Bluetooth*® Wireless Technology phone is not connected.
- Up to 50 received, dialed and missed calls are stored in Call History.
- Time of received/dialed calls and call time information are not saved.

Features of your vehicle

Contacts

Press the **PHONE** key ▶ Select [Contacts]

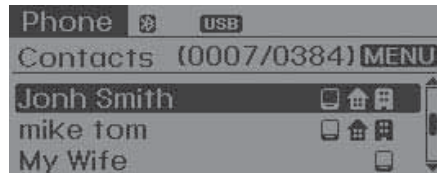

The list of saved phone book entries is displayed.

NOTE:

Find a contact in an alphabetical order, press the **MENU** key.



* NOTICE

- Up to 1,000 contacts saved in your *Bluetooth*® Wireless Technology phone can be downloaded into the car contacts. Contacts that have been downloaded to the car cannot be edited or deleted on the phone.
 - Mobile phone contacts are managed separately for each paired *Bluetooth*® Wireless Technology device (max 5 devices x 1,000 contacts each). Previously downloaded data is maintained even if the *Bluetooth*® Wireless Technology device has been disconnected. (However, the contacts and call history saved to the phone will be deleted if a paired phone is deleted.)
 - It is possible to download contacts during Bluetooth streaming audio.
 - When downloading contacts, the icon will be displayed within the status bar.
- It is not possible to begin downloading a contact list when the contact download feature has been turned off within the *Bluetooth*® Wireless Technology device. In addition, some devices may require device authorization upon attempting to download contacts. If downloading does not normally occur, check the *Bluetooth*® Wireless Technology device settings or the screen state.
 - The contacts download feature may not be supported in some mobile phones. For more information of supported *Bluetooth*® devices and function support, refer to your phone's user manual.

Features of your vehicle

Bluetooth® Wireless Technology Setting

The *Bluetooth*® word mark and logos are registered trademarks owned by Bluetooth SIG, Inc. and any use of such marks by Hyundai is under license. Other trademarks and trade names are those of their respective owners. A *Bluetooth*® enabled cell phone is required to use *Bluetooth*® Wireless Technology.

⚠ WARNING

Driving while distracted can result in a loss of vehicle control that may lead to an accident, severe personal injury, and death. The driver's primary responsibility is in the safe and legal operation of a vehicle, and use of any handheld devices, other equipment, or vehicle systems which take the driver's eyes, attention and focus away from the safe operation of a vehicle or which are not permissible by law should never be used during operation of the vehicle.

Pairing a New Device

Press the **SETUP** key ▶ Select [Phone] ▶ Select [Pair Phone]



Bluetooth® Wireless Technology devices can be paired with the audio system.

For more information, refer to the "Pairing through Phone Setup" section within *Bluetooth*® Wireless Technology.

Viewing Paired Phone List

Press the **SETUP** key ▶ Select [Phone] ▶ Select [Paired Phone List]

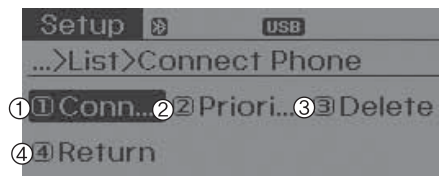

This feature is used to view mobile phones that have been paired with the audio system. Upon selecting a paired phone, the setup menu is displayed.

For more information, refer to the "Setting *Bluetooth*® Wireless Technology Connection" section within *Bluetooth*® Wireless Technology.

Features of your vehicle

- 1) Connect/Disconnect Phone : Connect/disconnects currently selected phone
- 2) Change Priority : Sets currently selected phone to highest connection priority
- 3) Delete : Deletes the currently selected phone
- 4) Return : Moves to the previous screen

* NOTICE BEFORE DOWN-LOADING CONTACTS

- Only contacts within connected phones can be downloaded. Also check to see that your mobile phone supports the download feature.
- To learn more about whether your mobile phone supports contacts downloads, refer to your mobile phone user's manual.
- The contacts for only the connected phone can be downloaded.

Downloading Contacts

Press the **SETUP** key ▶ Select [Phone] ▶ Select [Contacts Download]

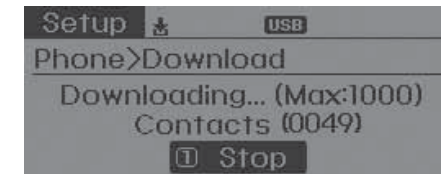

As the contacts are downloaded from the mobile phone, a download progress bar is displayed.

* NOTICE

- Upon downloading phone contacts, the previous corresponding data is deleted.
- This feature may not be supported in some mobile phones.
- Voice Recognition may not operate while contacts are being downloaded.

Features of your vehicle

Outgoing Volume

Press the **SETUP** key ▶ Select [Phone] ▶ Select [Outgoing Volume]

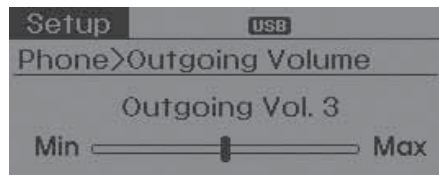

Use **TUNE** knob to adjust the outgoing volume level.

* NOTICE

While on a call, the volume can be changed by using the **SEEK TRACK** key.

Turning Bluetooth System Off

Press the **SETUP** key ▶ Select [Phone] ▶ Select [Bluetooth System Off]

Once *Bluetooth*® Wireless Technology is turned off, *Bluetooth*® Wireless Technology related features will not be supported within the audio system.

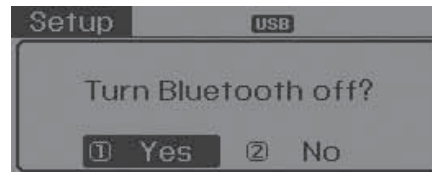
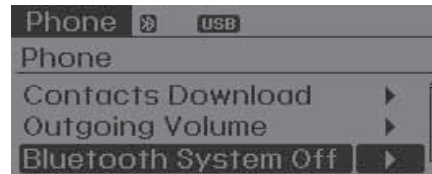

* NOTICE

To turn *Bluetooth*® Wireless Technology back on, go to **SETUP** ▶ [Phone] and select “Yes”.

VOICE RECOGNITION

Using Voice Recognition

Starting Voice Recognition

Shortly press the  key on the steering wheel. Say a command.

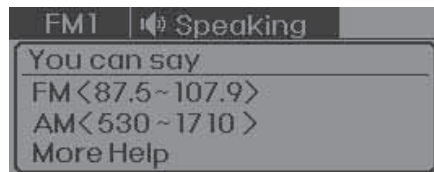

If prompt feedback is in [ON], then the system will say "Please say a command after the beep (BEEP)"

- If prompt feedback is in [OFF] mode, then the system will only say "(BEEP)"
- To change Prompt Feedback [On]/[Off], go to **SETUP** ▶ [System] ▶ [Prompt Feedback]

* NOTICE

For proper recognition, say the command after the voice instruction and beep tone.

Contact List Best Practices

- 1) Do not store single-name entries (e.g., "Bob", "Mom", "Kim", etc.). Instead, always use full names (including first and last names) for all contacts (e.g., use "Jacob Stevenson" instead of "Dad").
- 2) Do not use abbreviations (i.e., use "Lieutenant" instead of "Lt." or "Sergeant" instead of "Sgt.>").
- 3) Do not use acronyms (i.e., use "County Finance Department" instead of "CFD").
- 4) Do not use special characters (e.g., "@", "hyphen -", "asterisk *", "ampersand &").
- 5) If a name is not recognized from the contact list, change it to a more descriptive name (e.g., use "Grandpa Joseph" instead of "Pa Joe").

Skipping Prompt Messages

While prompt message is being stated ▶ Shortly press the  key on the steering remote controller

The prompt message is immediately ended and the beep tone will sound. After the "beep", say the voice command.

Re-starting Voice Recognition

While system waits for a command ▶ Shortly press the  key on the steering remote controller

The command wait state is immediately ended and the beep tone will sound. After the "beep", say the voice command.

Features of your vehicle

ENDING VOICE RECOGNITION

While Voice Recognition is operating
▶ Press and hold the  key on the steering remote controller

* NOTICE

- While using voice command, pressing any steering wheel control or a different key will end voice command.
- When the system is waiting for a voice command, say “cancel” or “end” to end voice command.
- When the system is waiting for a voice command, press and hold the  key on the steering wheel to end voice command.

Voice Recognition and Phone Contact Tips:

The Hyundai Voice Recognition System may have difficulty understanding some accents or uncommon names.

When using Voice Recognition to place a call, speak in a moderate tone, with clear pronunciation. To maximize the use of Voice Recognition, consider these guidelines when storing contacts:

- Do not store single-name entries (e.g., “Bob”, “Mom”, etc.). Instead, always use full names (including first and last names) for these contacts
- Do not use special characters (e.g., '@', '-', '*', '&', etc.)
- Do not use abbreviations (i.e., use “Lieutenant” instead of “Lt.”) or acronyms (i.e., use “County Finance Department” instead of “C. F. D.”); Be sure to say the name exactly as it is entered in the contacts list

Features of your vehicle

Illustration on using voice commands

- Starting voice command.

Shortly pressing the  key (under 0.8 seconds):

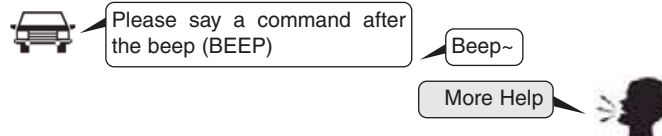

More Help
Here are some examples of mode commands. You can say a radio type like 'FM', 'AM', or 'Satellite'. You can also say a media source like 'USB', 'My Music', or 'iPod'. Additionally, there are phone commands like "Contacts", 'Call History', or 'Dial Number'. You can find more detailed commands in the user's manual. Please say a command after the beep.



More Help
Here are some examples of mode commands. You can say a radio type like 'FM', 'AM', or 'Satellite'. You can also say a media source like 'USB', 'My Music', or 'iPod'. Additionally, there are phone commands like "Contacts", 'Call History', or 'Dial Number'. You can find more detailed commands in the user's manual. Please say a command after the beep.

- Skipping Voice Recognition

Shortly pressing the  key (under 0.8 seconds):

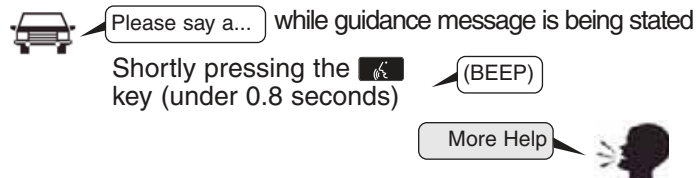

- End voice command.

Shortly pressing the  key (under 0.8 seconds):

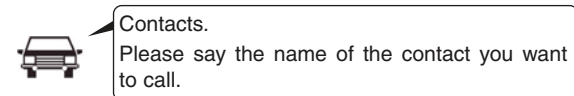
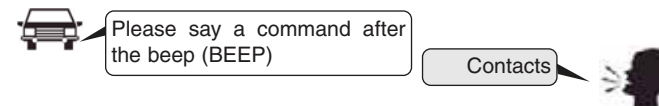

Features of your vehicle

Voice Command List

- **Common Commands:** These commands can be used in most operations. (However a few commands may not be available during certain operations)

Command	Function
More Help	Provides guidance on commands that can be used anywhere in the system.
Help	Provides guidance on commands that can be used within the current mode.
Call<Name>	Calls <Name> saved in Contacts Ex) Call "John Smith"
Call <Name> on Mobile	Calls <Name> to the number that is saved as "Mobile" in Contacts Ex) Call "John Smith" on Mobile
Call <Name> in Office	Calls <Name> to the number that is saved as "Office" in Contacts Ex) Call "John Smith" in Office
Call <Name> at Home	Calls <Name> to the number that is saved as "Home" in Contacts Ex) Call "John Smith" at Home
Call <Name> on Other	Calls <Name> to the number that is saved as "Other" in Contacts Ex) Call "John Smith" on Other
Phone	Provides guidance on Phone related commands. After saying this command, say "Favorites", "Call History", "Contacts" or "Dial Number" execute corresponding functions.
Favorites	Display the Favorite screen.
Call History	Displays the Call History screen.

Command	Function
Contacts (Call by Name)	Displays the Contacts screen. After saying this command, say the name of a contact saved in the Contacts to automatically connect the call.
Dial Number	Display the Dial number screen. After saying this command, you can say the number that you want to call.
Redial	Connects the most recently called number.
Tutorial	Provide guidance on how to use voice recognition and Bluetooth® connections.
Radio	<ul style="list-style-type: none"> • When listening to the radio, displays the next radio screen. (FM1→FM2→AM→XM1→XM2→XM3→FM1) • When listening to a different mode, displays the most recently played radio screen. • When currently listening to the FM radio, maintains the current state. • When listening to a different mode, displays the most recently played FM screen.
FM1(FM One)	Displays the FM1 screen.
FM2(FM Two)	Displays the FM2 screen.
AM	Displays the AM screen.

Features of your vehicle

Command	Function
FM Preset 1~6	Plays the most recently played broadcast saved in FM Preset 1~6.
AM Preset 1~6	Plays the broadcast saved in AM Preset 1~6.
FM 87.5~107.9	Plays the FM broadcast of the corresponding frequency.
AM 530~1710	Plays the AM broadcast of the corresponding frequency.
SiriusXM™	<ul style="list-style-type: none"> • When currently listening to the SiriusXM™, maintains the current state. • When listening to a different mode, displays the most recently played SiriusXM™ screen.
SiriusXM™ 1~3	Displays the selected XM screen.
SiriusXM™ Channel 0~255	Plays the selected XM channel.
Media	Moves to the most recently played media screen.
CD	Plays the music saved in the CD.
USB	Plays USB music.
iPod®	Plays iPod music.

Command	Function
My Music	Plays the music saved in My Music.
AUX (Auxiliary)	Plays the connected external device.
Bluetooth® Audio	Plays the music saved in connected Bluetooth® device.
Please repeat	Repeats the most recent comment.
Mute	Mutes the sound.
Cancel (Exit)	Ends voice command.

Features of your vehicle

- **FM/AM radio commands:** Commands available during FM, AM radio operation

Command	Function
Preset 1~6	Plays the broadcast station saved in Preset 1~6.
Scan	Scans receivable frequencies from the current broadcast and plays for 10 seconds each.
Preset Scan	Moves to the next preset from the current present and plays for 10 seconds each.
Information	Displays the information of the current broadcast. (This feature can be used when receiving RBDS broadcasts.)

- **Satellite radio commands:** Commands that can be used while listening to Satellite Radio.

Command	Function
Channel 0~255	Play the selected Satellite Radio channel.
Scan	Scans receivable channels from the current broadcast and plays for 10 seconds each.
Preset 1~6	Plays the broadcast saved in Preset 1~6.
Information	Displays the information of the current broadcast.

Features of your vehicle

- Audio CD commands: Commands available during Audio CD operation

Command	Function
Random	Randomly plays the tracks within the CD.
Random Off	Cancels random play to play tracks in sequential order.
Repeat	Repeats the current track.
Repeat Off	Cancels repeat play to play tracks in sequential order.
Track 1~30	Plays the desired track number.

- MP3 CD / USB commands: Commands available during USB and MP3 CD operation

Command	Function
Random	Randomly plays the files within the current folder.
Random Off	Cancels random play to play files in sequential order.
Repeat	Repeats the current file.
Repeat Off	Cancels repeat play to play files in sequential order.
Information	Displays the information screen of the current file.
Next Folder	Play the first file in the next folder
Previous Folder	Play the first file in the previous folder

Features of your vehicle

- iPod® Commands: Commands available during iPod® operation

Command	Function
Random	Randomly plays the songs within the current category.
Random Off	Cancels random play to play songs in sequential order.
Repeat	Repeats the current song.
Repeat Off	Cancels repeat play to play songs in sequential order.

- My Music Commands: Commands available during My Music operation

Command	Function
Random	Randomly plays all saved files.
Random Off	Cancels random play to play files in sequential order.
Repeat	Repeats the current file.
Repeat Off	Cancels repeat play to play files in sequential order.
Delete	Deletes the current file. You will bypass an additional confirmation process.

Features of your vehicle

- **Bluetooth® Wireless Technology Audio Commands:** Commands available during *Bluetooth®* Wireless Technology audio streaming from mobile phone operation Command Operation







Command	Function
Play	Plays the currently paused song.
Pause	Pauses the current song.

SiriusXM™ service requires a subscription, sold separately, after 3-month trial included with vehicle purchase. If you decide to continue your SiriusXM™ service at the end of your trial subscription, the plan you choose will automatically renew and bill at then-current rates until you call us at 1-866-635-2349 to cancel. See our Customer Agreement for complete terms at www.siriusxm.com. Other fees and taxes apply. All fees and programming are subject to change. Sirius satellite service is available only to those at least 18 and older in the 48 contiguous USA, D.C., and PR (with coverage limitations). Our Internet radio service is available throughout our satellite service area and in AK and HI. Certain channels are not available on our Internet radio service or on mobile devices. SiriusXM Traffic available in select markets. See siriusxm.com/traffic for more information. © 2013 Sirius XM Radio Inc. Sirius, XM and all related marks and logos are trademarks of Sirius XM Radio Inc. iPod® is a registered trademark of Apple Inc. iPod® mobile digital device sold separately. The *Bluetooth®* word mark and logos are registered trademarks owned by Bluetooth SIG, Inc. and any use of such marks by Hyundai is under license. A *Bluetooth®* enabled cell phone is required to use *Bluetooth®* wireless technology. All rights reserved.

Features of your vehicle

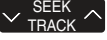
SYSTEM CONTROLLERS AND FUNCTIONS

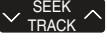
Audio Head Unit

1.  (EJECT)
 - Ejects the disc.
2. 
 - Convert to Radio mode.
 - Each time the key is pressed, the mode is changed in order of FM1, FM2, AM, XM1, XM2, XM3.
3. 
 - Convert to Media Mode
 - Each time the key is pressed, the mode is changed in order of CD, USB(iPod®), AUX, My Music, BT Audio.
4.  (for *Bluetooth*® Wireless Technology equipped model)
 - Converts to Phone mode
 - * When a phone is not connected, the connection screen is displayed.
5. POWER/VOL knob
 -  Power : Press to turn power on/off.
 -  Volume : Turn left/right to control volume.
6. 
 - When pressed shortly (under 0.8 seconds)
 - Radio mode : plays previous/next frequency.
 - Media (CD/USB/iPod®/My Music) modes : changes the track, Song(file)
 - When pressed and held (Over 0.8 seconds)
 - Radio mode : continuously changes the frequency. Upon release, plays the current frequency.
 - Media (CD/USB/iPod®/My Music) modes : rewinds or fast forwards the track or file
 - During a Handsfree call, controls the call volume.
7. 
 - XM RADIO™ : Category Search
 - CD/USB/MP3 mode : Search Folder

Features of your vehicle

8. **DISP**

- Turns the monitor display on/off.

9. **MUTE**

When the button is pressed, stopssound and "Audio Mute" is displayed on LCD.

10. **SCAN**

- Radio Mode : previews all receivable broadcasts for 5 seconds each
- Media (CD/USB/My Music) modes : previews each song (file) for 10 seconds each.

11. **SETUP**

- Converts to Setup mode.

12. **TUNE knob**

- Radio mode : turn to change broadcast frequencies.
- Media (CD/USB/iPod®/My Music) modes : turn to search tracks/channels/files.

13. **DISC-IN LED**

- LED that indicates whether a disc is inserted.

Audio Head Unit

(For NON Bluetooth model)

14. **FM/AM**

- Changes to FM mode.
- Each time the key is pressed, the mode changed in order of FM1 → FM2 → AM.









15. **SAT**

- Changes to SiriusXM™ mode.

Features of your vehicle

SYSTEM CONTROLLERS AND FUNCTIONS

Audio Head Unit

1.  (EJECT)
 - Ejects the disc.
2. 
 - Convert to Radio mode.
 - Each time the key is pressed, the mode is changed in order of FM1, FM2, AM.
3. 
 - Convert to Media Mode
 - Each time the key is pressed, the mode is changed in order of CD, USB(iPod®), AUX, My Music, BT Audio.
4.  (for *Bluetooth*® Wireless Technology equipped model)
 - Converts to Phone mode
 - * When a phone is not connected, the connection screen is displayed.
5. POWER/VOL knob
 -  Power : Press to turn power on/off.
 -  Volume : Turn left/right to control volume.
6. 
 - When pressed shortly (under 0.8 seconds)
 - Radio mode : plays previous/next frequency.
 - Media (CD/USB/iPod®/My Music) modes : changes the track, Song(file)
 - When pressed and held (Over 0.8 seconds)
 - Radio mode : continuously changes the frequency. Upon release, plays the current frequency.
 - Media (CD/USB/iPod®/My Music) modes : rewinds or fast forwards the track or file
 - During a Handsfree call, controls the call volume.
7. 
 - CD/USB/MP3 mode : Search Folder

Features of your vehicle

8. **DISP**

- Turns the monitor display on/off.

9. **MUTE**

When the button is pressed, stop sound and "Audio Mute" is displayed on LCD.

10. **SCAN**

- Radio Mode : previews all receivable broadcasts for 5 seconds each
- Media (CD/USB/My Music) modes : previews each song (file) for 10 seconds each.

11. **SETUP**

- Converts to Setup mode.

12. **TUNE knob**

- Radio mode : turn to change broadcast frequencies.
- Media (CD/USB/iPod®/My Music) modes : turn to search tracks/ channels/files.

Audio Head Unit (For NON Bluetooth model)

13. **FM**

- Changes to FM mode.
- Each time the key is pressed, the mode changed in order of FM1 → FM2.

14. **AM**

- Changes to AM mode.

Features of your vehicle

Making a call using the Steering-wheel mounted controls

※ The actual feature in the vehicle may differ from the illustration.

1. VOLUME

- Used to control volume.

2. SEEK

- When pressed shortly (under 0.8 seconds)
 - Radio mode : searches broadcast frequencies saved to presets.
 - Media(CD / USB / iPod® / My Music / BT Audio) modes : changes the track, file or chapter.
- When pressed and held (over 0.8 seconds)
 - Radio mode, automatically searches broadcast frequencies and channels
 - Media(CD / USB / iPod® / My Music) modes, rewinds or fast forwards the track or song(file)
 - BT Audio mode may not be supported in some mobile phones.

3. MODE

- Each time this key is pressed, the mode is changed in order of FM1 → FM2 → AM → XM1 → XM2 → XM3 → CD → USB or iPod → AUX → My Music → BT Audio
- If the media is not connected or a disc is not inserted, corresponding modes will be disabled.

4. MUTE

- Mutes audio volume.

Features of your vehicle

5. 
- When pressed shortly
 - Starts voice recognition
 - When selecting during a voice prompt, stops the prompt and converts to voice command waiting state
 - When pressed and held (over 0.8 seconds)
 - Ends voice recognition

6. 
- When pressed shortly
 - When pressed in the phone screen, displays call history screen
 - When pressed in the dial screen, makes a call
 - When pressed in the incoming call screen, answers the call
 - When pressed during call waiting, switches to waiting call (Call Waiting)
 - When pressed and held (over 0.8 seconds)
 - When pressed in the *Bluetooth*[®] Wireless Technology Handsfree wait mode, redials the last call
 - When pressed during a *Bluetooth*[®] Wireless Technology Handsfree call, switches call back to mobile phone (Private)
 - When pressed while calling on the mobile phone, switches call back to *Bluetooth*[®] Wireless Technology Handsfree (Operates only when *Bluetooth*[®] Wireless Technology Handsfree is connected)

7. 
- Ends phone call

Features of your vehicle

SIRIUSXM™ RADIO MODE

Features of your vehicle

Satellite radio reception

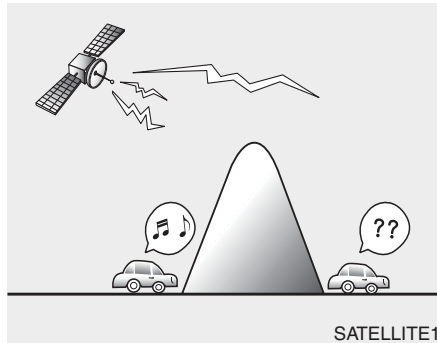

You may experience difficulties in receiving XM satellite™ radio signals in the following situations.

- If you are driving in a tunnel or a covered parking area.
- If you are driving beneath the top level of a multi-level freeway.
- If you are driving under a bridge.
- If you are driving next to a tall vehicle (such as a truck or a bus) that blocks the signal.

- If you are driving in a valley where the surrounding hills or peaks block the signal from the satellite.
- If you are driving on a mountain road where the signal is blocked by mountains.

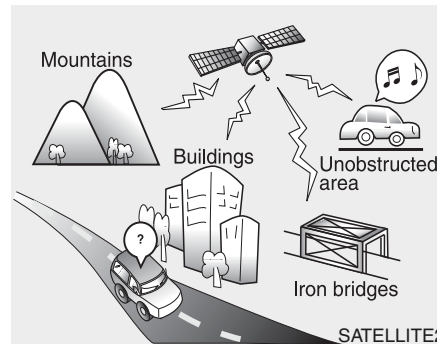

- If you are driving in an area with tall trees that block the signal (30 ft./10m or more), for example on a road that goes through a dense forest.
- The signal can become weak in some areas that are not covered by the XM repeater network.

NOTE:

There may also be additional unforeseen circumstances leading to reception problems with the XM satellite™ radio signal.

Advisory Messages, such as 'CH Unavailable' may occur when starting XM Radio™.

Features of your vehicle

Basic Mode Screen

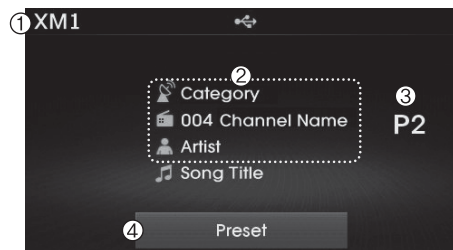

1. Mode Display
Displays currently operating mode.

2. Channel Information
Displays the category, channel number, channel name, artist and title information.

3. Preset
Displays currently playing preset number [1] ~ [6].

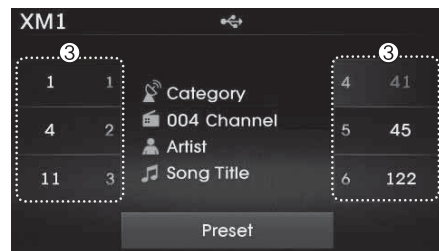

4. Preset Display
Displays saved presets.

Features of your vehicle

Using SEEK

Press the **SEEK TRACK** key to play the previous/next channel.

* If the "Category" icon is displayed, channels are changed within the current category.

Using Tune

Turn the **TUNE** knob to select the desired channel.

SCAN

Press the **SCAN** key to scan all channels with superior reception for 10 seconds each.

Once scan is complete, the previously played channel will be restored.

During Scan, pressing the **SCAN** key again will cancel the scan operation and restore the previously played channel.

If the "Category" icon is displayed, channels are changed within the current category.

Searching Categories

Select the category by using the **CAT FOLDER** key and press the **TUNE** knob to select.

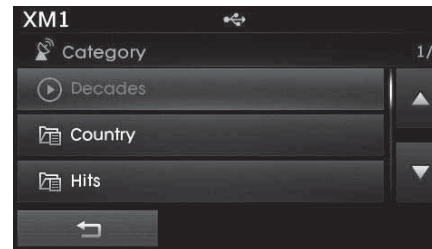

Channels for the selected category are played.

Selecting Presets/Saving Presets

Press the **Preset** button to display the broadcast information for the channel saved to each button.

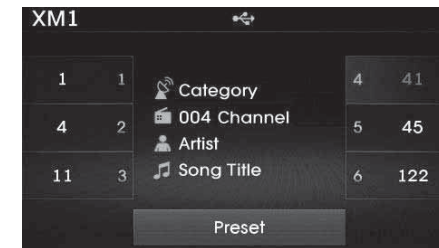

Press the **1** ~ **6** buttons to play the desired preset.

* NOTICE

While listening to a channel you want to save as a preset, press and hold one of the **1** ~ **6** preset buttons (over 0.8 seconds) to save the current channel to the selected preset.

*** NOTICE - USING THE DISCS**

- This device has been manufactured to be compatible with software bearing the following logo marks.
- Do not clean discs with chemical solutions, such as record sprays, antistatic sprays, antistatic liquids, benzene, or thinners.
- After using a disc, put the disc back in its original case to prevent disc scratches.
- Hold discs by their edges or within the center hole to prevent damages to disc surfaces.
- Do not introduce foreign substances into the disc insert/eject slot. Introducing foreign substances could damage the device interior.
- Do not insert two discs simultaneously.
- When using CD-R/CD-RW discs, differences in disc reading and playing times may occur depending on the disc manufacturer, production method and the recording method as used by the user.

(Continued)

(Continued)

- Clean fingerprints and dust off the disc surface (coated side) with a soft cloth.
- The use of CD-R/CD-RW discs attached with labels may result in disc slot jams or difficulties in disc removal. Such discs may also result in noise while playing.
- Some CD-R/CD-RW discs may not properly operate depending on the disc manufacturer, production method and the record method as used by the user. If problems persist, trying using a different CD as continued use may result in malfunctions.
- The performance of this product may differ depending on the CD-RW Drive Software.
- Copy-protected CDs such as S-type CDs may not function in the device. DATA discs cannot be played. (However, such discs may still operate but will do so abnormally.)

(Continued)

(Continued)

- Do not use abnormally shaped discs (8cm, heart-shaped, octagon-shaped) as such discs could lead to malfunctions.
- If the disc is straddled on the disc slot without removal for 10 seconds, the disc will automatically be re-inserted into the disc player.
- Only genuine audio CDs are supported. Other discs may result in recognition failure (e.g. copy CD-R, CDs with labels)

Features of your vehicle

MEDIA MODE

Pressing the **MEDIA** key will change the operating mode in order of CD → USB(iPod®) → AUX → My Music → BT Audio.

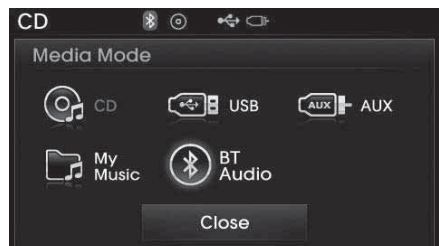

If [Mode Pop up] is turned on within **SETUP** ▶ [Display], then pressing the **MEDIA** key will display the Media Pop-up Mode screen.

Turn the **TUNE** knob to move the focus. Press the knob to select.

* NOTICE

The media mode pop up screen can be displayed only when there are two or more media modes turned on.

Title Icon

When a *Bluetooth*® Wireless Technology, iPod®, USB, or AUX device is connected or a CD is inserted, the corresponding mode icon will be displayed.



Icon	Title
	<i>Bluetooth</i> ® Wireless Technology
	CD
	iPod®
	USB
	AUX

AUDIO CD MODE

Basic Mode Screen



- 1. Mode
Displays currently operating mode.
- 2. Operation State
From Repeat/Random(Shuffle)/ Scan, displays the currently operating function.
- 3. Track Info
Displays information about the current track.

- 4. Play/Pause
Changes the play/pause state.
- 5. Play Time
Displays the current play time.
- 6. Info
Shows detailed information about the current track.
- 7. Random(Shuffle)
Turns the Random(Shuffle) feature on/off.
- 8. Repeat
Turns the Repeat feature on/off.
- 9. List
Moves to the list screen.

Features of your vehicle

Using Audio CD Mode

Playing/Pausing CD Tracks

Once an audio CD is inserted, the mode will automatically start and begin playing.

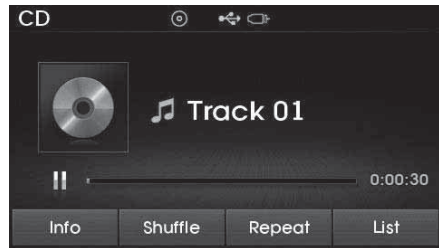

While playing, press the button to pause and press button to play.

* NOTICE

- Only genuine audio CDs are supported. Other discs may result in recognition failure (e.g. copy CD-R, CDs with labels)
- The artist and title information are displayed on the screen if track information is included within the audio CD.

Changing Tracks

Press the key to move to the previous or next track.

* NOTICE

- Pressing the key after the track has been playing for 2 seconds will start the current track from the beginning.
- Pressing the key before the track has been playing for 1 seconds will start the previous track.

Selecting from the List

Turn the TUNE knob left/right to search for the desired track.

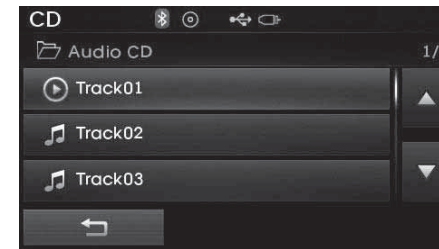

Once you find the desired track, press the TUNE knob to start playing.

Rewinding / Fast-forwarding Tracks

While playing, press and hold the key (over 0.8 seconds) to rewind or fast-forward the current track.

Scan

Press the SCAN key to play the first 10 seconds of each file.

Features of your vehicle

Audio CD Mode Menu

Within this mode, you will have access to the Info, Random(Shuffle), Repeat and List features.

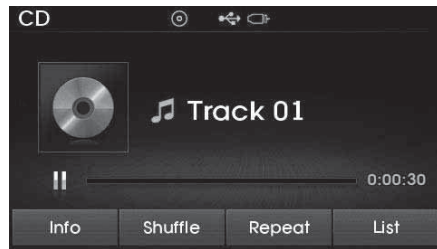

Info

Press the **Info** button to display details about the current disc.

Random(Shuffle)

Press the **Shuffle** button to play tracks in random(Shuffle) order.

Press the **Shuffle** button again to turn the Random(Shuffle) feature off.

- Random(Shuffle): Plays all tracks in random(Shuffle) order.

Repeat

Press the **Repeat** button to repeat the current track. Press the button again to turn the repeat feature off.

- Repeat : Repeats the current track.

List

Press the **List** button to display the track list screen.

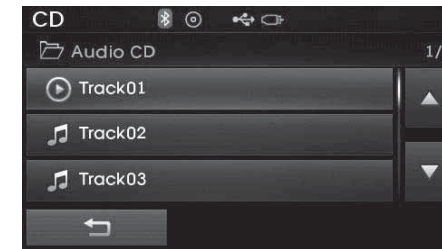

Turn the **TUNE** knob left/right to search for tracks. Once the desired track is displayed, press the knob to select and play.

Features of your vehicle

MP3 CD MODE

Basic Mode Screen

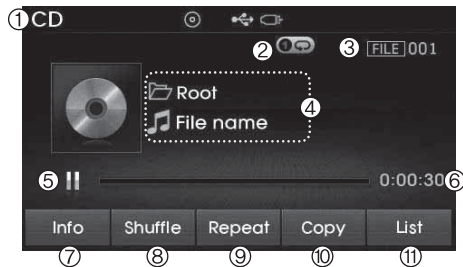

1. Mode
Displays currently operating mode.

2. Operation State
From Repeat/Random(Shuffle)/ Scan, displays the currently operating function.

3. File Index
Displays the current file number.

4. File Info
Displays information about the current file.

5. Play/Pause
Changes the play/pause state.

6. Play Time
Displays the current play time.

7. Info
Shows detailed information about the current file.

8. Random(Shuffle)
Turns the Random(Shuffle) feature on/off.

9. Repeat
Turns the Repeat feature on/off.

10. Copy
Copies the current file into My Music

11. List
Moves to the list screen.

Using MP3 CD Mode

Playing/Pausing MP3 Files

Once an MP3 disc is inserted the mode will automatically start and being playing.



While playing, press the **||** button to pause and press **▶** button to play.

* NOTICE



If there are numerous files and folders within the disc, reading time could take more than 10 seconds and the list may not be displayed or song searches may not operate. Once loading is complete, try again.

Features of your vehicle

Changing Files

Press the  key to move to the previous or next file.

* NOTICE

- Pressing the  key after the file has been playing for 2 seconds will start the current file from the beginning.
- Pressing the  key before the file has been playing for 1 second will start the previous file.

Selecting from the List

Turn the  knob left/right to search for the desired file.



Once you find the desired file, press the  knob to start playing.

Rewinding / Fast-forwarding Files

While playing, press and hold the  key (over 0.8 seconds) to rewind or fast-forward the current file.

Scan

Press the  key to play the first 10 seconds of each file.

Searching Folders

Press the  key to select and search folders.

Once the desired folder is displayed, press the  knob to select.



The first file within the selected folder will begin playing.

MP3 CD Mode Menu

Within this mode, you will have access to the Info, Random(Shuffle), Repeat, Copy and List features.



Info

Press the  button to display details about the current file.

Features of your vehicle

* NOTICE

- When the 'Folder File' option is set as the default display within Display setup, the album/artist/file information are displayed as detailed file information.
- When the 'Album Artist Song' option is set as the default display, the folder name/file name are displayed as detailed file information.
- The title, artist and album info are displayed only when such information are recorded within the MP3 file ID3 tag.

Random(Shuffle)

Press the **Shuffle** button to play files in random(Shuffle) order.

Each time the button is pressed, the feature changes in order of Random (Shuffle) Folder → Random (Shuffle) All → Off.

- Random(Shuffle) Folder : Plays all files within the current folder in Random (Shuffle) order.
- Random(Shuffle) All : Plays all files in Random(Shuffle) order.

Repeat

Press the **Repeat** button to repeat the current file or folder.

Each time the button is pressed, the feature changes in order of Repeat →Repeat Folder→Off.

- Repeat: Repeats the current file.
- Repeat Folder: Repeats all files within the current Folder.

Copying Files

Press the **Copy** button to copy the current file into My Music.

* NOTICE

Selecting another feature during copying will display a pop-up asking whether you wish to cancel copying. To cancel, select "Yes".

List

Press the **List** button to display the file list screen.



Turn the **TUNE** knob left/right to search for files. Once the desired file is displayed, press the knob to select and play.

*** NOTICE - USING THE USB DEVICE**

- Connect the USB device after turning on the engine. The USB device may become damaged if it is already connected when the ignition is turned on. The USB device may not operate properly if the car ignition is turned on or off with the USB device connected.
- Heed caution to static electricity when connecting/disconnecting USB devices.
- Encoded MP3 Players will not be recognized when connected as an external device.
- When connecting an external USB device, the device may not properly recognize the USB is in some states.
- Only products formatted with byte/sectors under 64Kbyte will be recognized.
- This device recognizes USB devices formatted in FAT 12/16/32 file formats. This device does not recognize files in NTFS file format.

(Continued)

(Continued)

- Some USB devices may not be supported due to compatibility issues.
- Avoid contact between the USB connector with bodily parts or foreign objects.
- Repeated connecting/disconnecting of USB devices within short periods of time may result in product malfunction.
- A strange noise may occur when disconnecting the USB.
- Make sure to connect/disconnect external USB devices with the audio power turned off.
- The amount of time required to recognize the USB device may differ depending on the type, size or file formats stored in the USB. Such differences in time are not indications of malfunctions.
- The device only supports USB devices used to play music files.
- USB images and videos are not supported.

(Continued)

(Continued)

- Do not use the USB I/F to charge batteries or USB accessories that generate heat. Such acts may lead to worsened performance or damage to the device.
- The device may not recognize the USB device if separately purchased USB hubs and extension cables are being used. Connect the USB directly with the multimedia terminal of the vehicle.
- When using mass storage USB devices with separate logical drives, only files saved to the root drive can be played.
- Files may not properly operate if application programs are installed to the USBs.
- The device may not operate normally if MP3 Players, cellular phones, digital cameras, or other electronic devices (USB devices not recognized as portable disk drives) are connected with the device.

Features of your vehicle

(Continued)

- Charging through the USB may not work for some mobile devices.
- The device may not support normal operation when using a USB memory type besides (Metal Cover Type) USB Memory.
- The device may not support normal operation when using formats such as HDD Type, CF, or SD Memory.
- The device will not support files locked by DRM (Digital Rights Management.)
- USB memory sticks used by connecting an Adaptor (SD Type or CF Type) may not be properly recognized.
- The device may not operate properly when using USB HDDs or USBs subject to connection failures caused by vehicle vibrations. (e.g. i-stick type)

(Continued)

(Continued)

- Avoid use of USB memory products that can also be used as key chains or mobile phone accessories. Use of such products may cause damage to the USB jack.
- Connecting an MP3 device or phone through various channels, such as AUX/BT or Audio/ USB mode may result in pop noises or abnormal operation.



Features of your vehicle

USB MODE

Basic Mode Screen

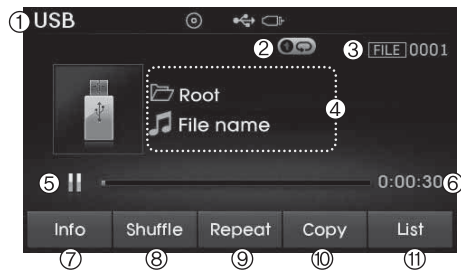

1. Mode
Displays currently operating mode.

2. Operation State
From Repeat/Random(Shuffle)/Scan, displays the currently operating function.

3. File Index
Displays the current file number.

4. File Info
Displays information about the current file.

5. Play/Pause
Changes the play/pause state.

6. Play Time
Displays the current play time.

7. Info
Displays detailed information for the current file.

8. Random(Shuffle)
Turns the Random(Shuffle) feature on/off.

9. Repeat
Turns the Repeat feature on/off.

10. Copy
Copies the current file into My Music.

11. List
Moves to the list screen.

Features of your vehicle

Using USB Mode

Playing/Pausing USB Files

Once a USB is connected, the mode will automatically start and begin playing a USB file.



While playing, press the **||** button to pause and press **▶** button to play.

* NOTICE

- Loading may require additional time if there are many files and folders within the USB and result in faulty list display or file searching. Normal operations will resume once loading is complete.
- The device may not support normal operation when using a USB memory type besides (Metal Cover Type) USB Memory.

Changing Files

Press the **SEEK TRACK** keys to move to the previous or next file.

* NOTICE

- Pressing the **SEEK TRACK** key after the file has been playing for 2 seconds will start the current file from the beginning.
- Pressing the **SEEK TRACK** key before the file has been playing for 1 seconds will start the previous file.

Selecting from the List

Turn the **TUNE** knob left/right to search for the desired file.

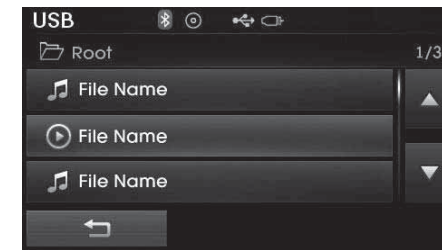

Once you find the desired file, press the **TUNE** knob to start playing.

Rewinding / Fast-forwarding Files

While playing, press and hold the **SEEK TRACK** key (over 0.8 seconds) to rewind or fast-forward the current file.

Scan

Press the **SCAN** key to play the first 10 seconds of each file.

Features of your vehicle

Searching Folders

Press the  key to select and search folders.

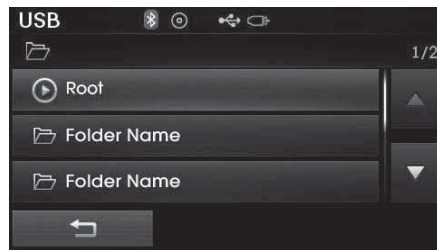

Once the desired folder is displayed, press the  TUNE knob to select.

The first file within the selected folder will begin playing.

USB Mode Menu

Within this mode, you will have access to the Info, Random(Shuffle), Repeat, Copy and List features.



Info

Press the  button to display details about the current file.

* NOTICE

- When the 'Folder File' option is set as the default display within Display setup, the album/artist/file information are displayed as detailed file information.
- When the 'Album Artist Song' option is set as the default display, the folder name/file name are displayed as detailed file information.
- The title, artist and album info are displayed only when such information are recorded within the MP3 file ID3 tag.

Random (Shuffle)

Press the  button to play files in random(Shuffle) order.

Each time the button is pressed, the feature changes in order of Random(Shuffle) Folder→Random(Shuffle) All→Off.

- Random(Shuffle) Folder : Plays the files in the current folder in random(Shuffle) order.
- Random(Shuffle) All : Plays all files in random(Shuffle) order.

Features of your vehicle

Repeat

Press the **Repeat** button to repeat the current file or folder.

Each time the button is pressed, the feature changes in order of Repeat → Repeat Folder → Off.

- Repeat (Icon) : Repeats the current file.
- Repeat Folder (Icon) : Repeats all files within the current folder.

Copying Files

Press the **Copy** button to copy the current file into My Music.

*** NOTICE**

Selecting another feature during copying will display a pop-up asking whether you wish to cancel copying. To cancel, select "Yes".

List

Press the **List** button to display the file list screen.

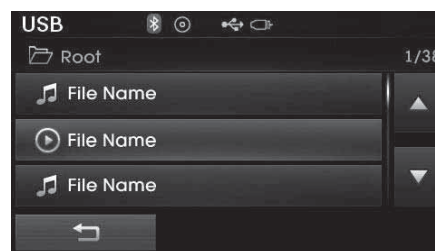

Turn the **TUNE** knob left/right to search for files. Once the desired file is displayed, press the knob to select and play.

*** NOTICE - USING THE iPod® DEVICE**

- iPod® is a registered trademark of Apple Inc.
- In order to use the iPod® while operating the keys, you must use a dedicated iPod® cable. (the cable that is supplied when purchasing iPod®/iPhone® products)
- If the iPod® is connected to the vehicle while it is playing, a high pitch sound could occur for approximately 1-2 seconds immediately after connecting. If possible, connect the iPod to the vehicle with the iPod® stopped/paused.
- During ACC ON state, connecting the iPod® through the iPod® cable will charge the iPod® through the car audio system.
- When connecting with the iPod® cable, make sure to fully insert the jack to prevent communication interference.

(Continued)

(Continued)

- When the EQ features of an external device, such as the iPod®, and the audio system are both active, EQ effects could overlap and cause sound deterioration and distortion. Whenever possible, turn off the EQ feature within the external device upon use by connecting with the audio system.
- Noise may occur when an iPod® or AUX device is connected. When such devices are not being used, disconnect the device for storage.
- When the iPod® or AUX device power is connected to the power jack, playing the external device may result in noise. In such cases, disconnect the power connection before use.
- Skipping or improper operation may occur depending on the characteristics of your iPod®/Phone® device.

(Continued)

(Continued)

- If your iPhone® is connected to both the *Bluetooth*® Wireless Technology and USB, the sound may not be properly played. In your iPhone®, select the Dock connector or *Bluetooth*® Wireless Technology to change the sound output (source).
- iPod mode cannot be operated when the iPod® cannot be recognized due to versions that do not support communication protocols.
- For fifth generation iPod® Nano devices, the iPod® may not be recognized when the battery level is low. Please charge the iPod® for use.
- Search/play orders shown within the iPod® device may differ with the orders shown within the audio system.
- If the iPod® malfunctions due to an iPod® device defect, reset the iPod® and try again. (To learn more, refer to your iPod® manual)

(Continued)

Features of your vehicle

(Continued)

- Some iPod®s may not sync with the System depending on its version. If the Media is removed before the Media is recognized, then the system may not properly restore the previously operated mode. (iPad® charging is not supported.)

iPod® MODE

Basic Mode Screen



1. Mode

Displays currently operating mode.

2. Operation State

From Repeat/Random(Shuffle), displays the currently operating function.

3. Song Index

Displays the current song/total number of songs.

4. Song Info

Displays information about the current song.

5. Play/Pause

Changes the play/pause state.

6. Play Time

Displays the current play time.

7. Random(Shuffle)

Turns the Random(Shuffle) feature on/off.

8. Repeat

Turns the Repeat feature on/off.

9. List

Moves to the list screen.

Features of your vehicle

Using iPod® Mode

Playing/Pausing iPod® Songs

Once an iPod® is connected, the mode will automatically start and begin playing an iPod® song.

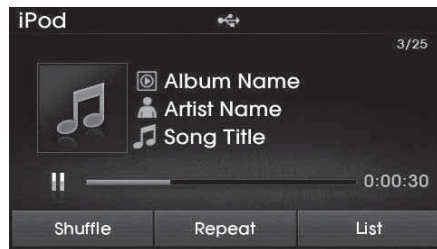

While playing, press the **||** button to pause and press **▶** button to play.

* NOTICE

iPod® with unsupported communication protocols may not properly operate in the audio system.

Changing Songs

Press the **SEEK TRACK** key to move to the previous or next song.

* NOTICE

- Pressing the **SEEK TRACK** key after the song has been playing for 2 seconds will start the current song from the beginning.
- Pressing the **SEEK TRACK** key before the song has been playing for 1 second will start the previous song.
- Slight time differences may exist depending your iPod® product.

Rewinding / Fast-forwarding Songs

While playing, press and hold the **SEEK TRACK** key (over 0.8 seconds) to rewind or fast-forward the current song.

Searching Categories

Turn the **TUNE** knob left/right to search for the desired category.

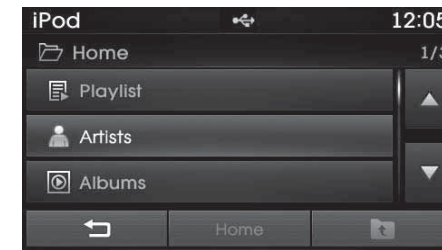

Once you find the desired category, press the **TUNE** knob to select and play.

* NOTICE



There are eight categories that can be searched, including **Playlists, Artists, Albums, Genres, Songs, Composers, Audiobooks and Podcasts.**

Features of your vehicle

Category Menu

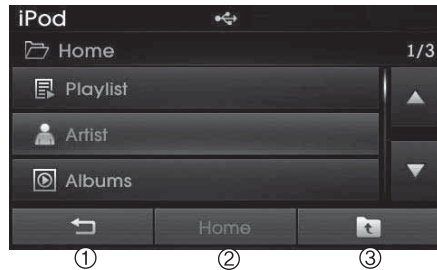
Within the iPod® Category menu, you will have access to the , Home, and  features.



1.  : Displays the play screen
2. Home : Moves to the iPod® root category screen
3.  : Moves to the previous category

* NOTICE

- If the search mode is accessed while playing a song, the most recently searched category is displayed.
- Search steps upon initial connection may differ depending on the type of iPod® device.

iPod® Mode Menu

Within this mode, you will have access to the Random(Shuffle), Repeat and List features.

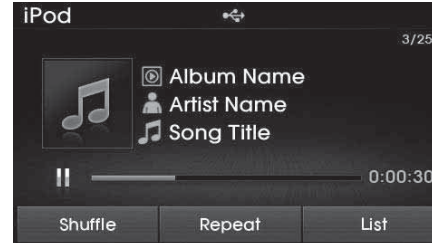

Random(Shuffle)

Press the  button to play songs in random(Shuffle) order.

- Random(Shuffle) All : Plays all songs in Random(Shuffle) order.

Repeat

Press the  button to repeat the current song. Press the button again to turn the repeat feature off.

- Repeat : Repeats the current song

List

Press the  button to display the Category Menu.

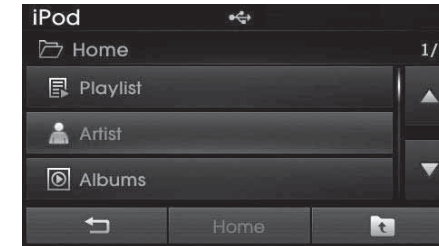

Turn the  knob left/right to search for the desired category.

Once you find the desired category, press the  knob to select and play.

AUX MODE

Using AUX Mode

Press the **MEDIA** key ▶ Select [AUX]

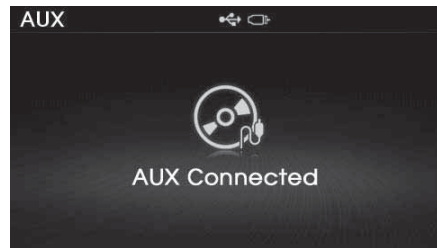

An external device can be connected to play music.

Connecting an External Device

External audio players (Camcorders, car VCR, etc.) can be played through a dedicated cable.

* NOTICE

- If an external device connector is connected with the AUX terminal, then AUX mode will automatically operate. Once the connector is disconnected, the previous mode will be restored.
- AUX mode can be used only when an external audio player (camcorder, car VCR, etc.) has been connected.
- The AUX volume can be controlled separately from other audio modes.
- Connecting a connector jack to the AUX terminal without an external device will convert the system to AUX mode, but only output noise. When an external device is not being used, also remove the connector jack.
- When the external device power is connected to the power jack, playing the external device may output noise. In such cases, disconnect the power connection before use.
- Fully insert the AUX cable to the AUX jack upon use.

Features of your vehicle

MY MUSIC MODE

Basic Mode Screen



1. Mode

Displays currently operating mode.

2. Operation State

From Repeat/Random(Shuffle)/ Scan, displays the currently operating function.

3. File Index

Displays the current file/total number of files.

4. File Info

Displays information about the current file.

5. Play/Pause

Changes the play/pause state.

6. Play Time

Displays the current play time.

7. Info

Displays detailed information for the current file.

8. Random(Shuffle)

Turns the Random(Shuffle) feature on/off.

9. Repeat

Turns the Repeat feature on/off.

10. Delete

Deletes the current file.

11. List

Moves to the list screen.

Features of your vehicle

Using My Music Mode

Playing/Pausing My Music Files

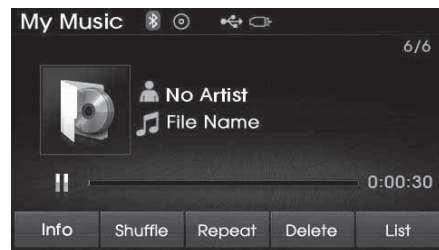

While playing, press the **||** button to pause and press **▶** button to play.

* NOTICE

If there are no files saved within My Music, the **My Music** button will be disabled.

Changing Files

Press the **SEEK TRACK** key to move to the previous or next file.

* NOTICE

- Pressing the **SEEK TRACK** key after the file has been playing for 2 seconds will start the current file from the beginning.
- Pressing the **SEEK TRACK** key before the file has been playing for 1 seconds will start the previous file.

Selecting from the List

Turn the **TUNE** knob left/right to search for the desired file.

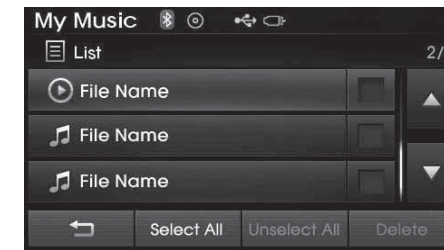

Once you find the desired file, press the **TUNE** knob to start playing.

Rewinding / Fast-forwarding Files

While playing, press and hold the **SEEK TRACK** key (over 0.8 seconds) to rewind or fast-forward the current file.

Scan

Press the **SCAN** key to play the first 10 seconds of each file.

Features of your vehicle

My Music Mode Menu

Within this mode, you will have access to the Info, Random(Shuffle), Repeat, Delete and List features.

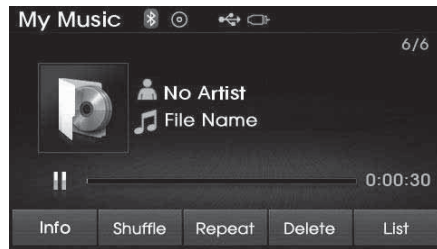

Info

Press the **Info** button to display details about the current file.

* NOTICE

The title, artist and album info are displayed only when such information is recorded within the MP3 file ID3 tag.

Random

Press the **Shuffle** button to play files in random order. Press the button again to turn the Random feature off.

Repeat

Press the **Repeat** button to repeat the current song. Press the button again to turn the repeat feature off.

Deleting Files

Press the **Delete** button to delete the current file.

List

Press the **List** button to display the file list screen.

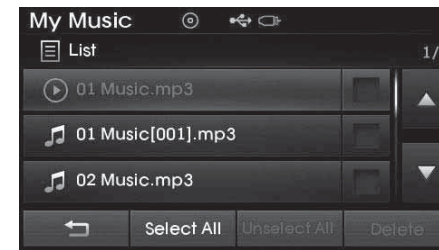

Turn the **TUNE** knob left/right to search for files. Once the desired file is displayed, press the knob to select and play.

Features of your vehicle

List Menu

From the List screen, it is possible to delete files you previously saved into My Music.

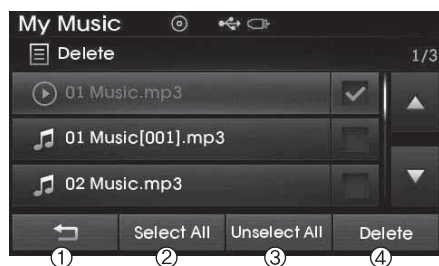

Press the **Select All** button or individually select the files you want to delete. Once files are selected, the **Unselect All** button and **Delete** buttons will be enabled.

- 1) **←**: Moves to the previous screen
- 2) **Select All**: Selects all files
- 3) **Unselect All**: Deselects all selected files
- 4) **Delete**: Deletes selected files

After selecting the files you want to delete, press the **Delete** button to delete the selected files.

* NOTICE

- If there is memory available, up to 6,000 files can be saved.
- Identical files cannot be copied more than 1,000 times.
- To check memory information, go to **SETUP** ▶ [System] ▶ [Memory Information]

Features of your vehicle

*** NOTICE - USING THE *Bluetooth*[®] Wireless Technology Audio Mode**

- *Bluetooth*[®] Wireless Technology Audio Mode can be used only when a *Bluetooth*[®] Wireless Technology phone has been connected.
- *Bluetooth*[®] Wireless Technology Audio Mode will not be available when connecting mobile phones that do not support this feature.
- While *Bluetooth*[®] Wireless Technology Audio is playing, if the *Bluetooth*[®] Wireless Technology phone is connected, then the music will also stop.
- Moving the Track up/down while playing *Bluetooth*[®] Wireless Technology audio mode may result in pop noises in some mobile phones.
- *Bluetooth*[®] Wireless Technology streaming audio may not be supported in some mobile phones.

(Continued)

(Continued)

- When returning to *Bluetooth*[®] Wireless Technology Audio mode after ending a call, the mode may not automatically restart in some mobile phones.
- Receiving an incoming call or making an outgoing call while playing *Bluetooth*[®] Wireless Technology Audio may result in audio interference.



Bluetooth® Wireless Technology AUDIO MODE (IF EQUIPPED)

Using Bluetooth® Wireless Technology Audio Mode

Playing/Pausing Bluetooth® Wireless Technology Audio

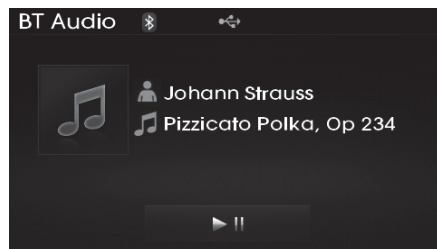
Once a *Bluetooth®* Wireless Technology device is connected, the mode will automatically start.



While playing, press the  button to pause and press  button to play.

*** NOTICE**

The play/pause feature may operate differently depending on the mobile phone.

Changing Files

Press the  key to move to the previous or next file.

Setting Connection

If a *Bluetooth®* Wireless Technology device has not been connected, press the  key ►[Phone] button to display the *Bluetooth®* Wireless Technology connection screen.

It is possible to use the pair phone, connect/disconnect and delete features from your *Bluetooth®* Wireless Technology phone.

*** NOTICE**

- If the *Bluetooth®* Wireless Technology audio is not operating properly, check whether the feature is turned off at  ►[Phone] ►[Streaming Audio]. If the feature is off, turn back on and try again.
- If music is not yet playing from your mobile device after converting to *Bluetooth®* Wireless Technology Audio mode, pressing the play button once may start playing the mode. Check to see that music is playing from the *Bluetooth®* Wireless Technology device after converting to *Bluetooth®* Wireless Technology Audio Mode.

Features of your vehicle

Pairing a *Bluetooth®* Wireless Technology Device

What is Bluetooth® Wireless Technology Pairing?

Pairing refers to the process of synchronizing your *Bluetooth®* Wireless Technology phone or device with the car audio system for connection. Pairing is necessary to connect and use the *Bluetooth®* Wireless Technology feature.

Pairing **PHONE** Key / Key on the Steering Remote Controller

When No Devices have been Paired

1. Press the **PHONE** key or the  key on the steering remote controller. The following screen is displayed.
2. Press the **OK** button to enter the Pair Phone screen.

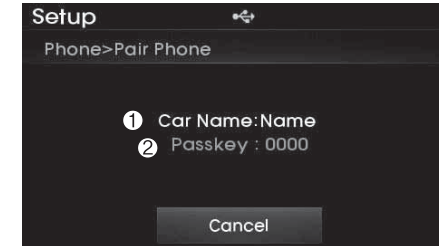
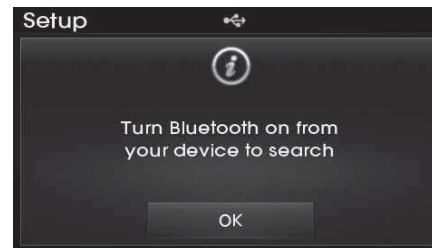

- 1) Car Name : Name of device as shown when searching from your *Bluetooth®* Wireless Technology device
- 2) Passkey : Passkey used to pair the device
- 3) From your *Bluetooth®* Wireless Technology device (i.e. Mobile Phone), search and select your car audio system.

Features of your vehicle

[Non SSP supported device]
(SSP: Secure Simple Pairing)

- After a few moments, a screen is displayed where the passkey is entered.
Hear, enter the passkey "0000" to pair your *Bluetooth*® Wireless Technology device with the car audio system.

[SSP supported device]

- After a few moments, a screen is displayed 6 digits passkey.
Hear, check the passkey on your *Bluetooth*® Wireless Technology device and confirm.

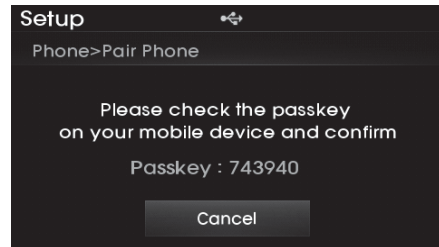

- Once pairing is complete, the following screen is displayed.

*** NOTICE**

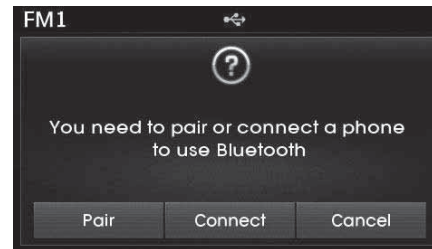

If *Bluetooth*® Wireless Technology devices are paired but none are currently connected, pressing the **PHONE** key or the  key on the steering wheel displays the following screen. Press the [Pair] button to pair a new device or press the [Connect] to connect a previously paired device.

Pairing through [PHONE] Setup

Press the **SETUP** key ▶ Select [Phone] ▶ Select [Pair Phone] ▶ Select  TUNE knob

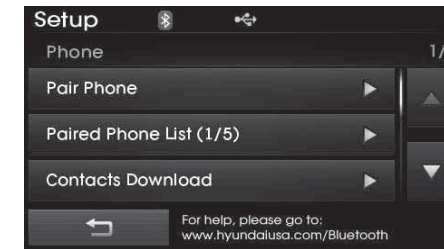

- The following steps are the same as those described in the section "When No Devices have been Paired" on the previous page.

Features of your vehicle

* NOTICE

- **Bluetooth® Wireless Technology** features supported within the vehicle are as follows. Some features may not be supported depending on your **Bluetooth® Wireless Technology** device.
 - **Outgoing/Incoming Handsfree calls**
 - **Operations during a call (Switch to Private, Switch to call waiting, MIC on/off)**
 - **Downloading Call History**
 - **Downloading Mobile Contacts**
 - **Bluetooth® Wireless Technology device auto connection**
 - **Bluetooth Audio Streaming**
- **Up to five Bluetooth® Wireless Technology devices** can be paired to the Car Handsfree system.
- **Only one Bluetooth® Wireless Technology device** can be connected at a time.
- **Other devices cannot be paired** while a **Bluetooth® Wireless Technology device** is connected.
- **Only Bluetooth® Wireless Technology Handsfree and Bluetooth audio related features** are supported.
- **Bluetooth related operations** are possible only within devices that support Handsfree or audio features, such as a **Bluetooth® Wireless Technology mobile phone** or a **Bluetooth audio device**.
- **If a connected Bluetooth® Wireless Technology device** becomes disconnected due to being out of communication range, turning the device **OFF**, or a **Bluetooth® Wireless Technology communication error**, corresponding **Bluetooth® Wireless Technology devices** are automatically searched and reconnected.
- **If the system becomes unstable** due to communication errors between the car Handsfree and the **Bluetooth® Wireless Technology device**, reset the device by turning off and back on again. Upon resetting **Bluetooth® Wireless Technology device**, the system will be restored.
- **After pairing is complete**, a **contacts download request** is sent once to the mobile phone. Some mobile phones may require confirmation upon receiving a download request, ensure your mobile phone accepts the connection. Refer to your phones user's manual for additional information regarding phone pairing and connections.

Features of your vehicle

Connecting a Device

Press the **SETUP** key ▶ Select [Phone] ▶ Select [Paired Phone List]

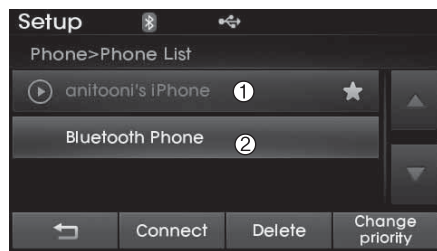

- 1) Connected Phone : Device that is currently connected
- 2) Paired Phone : Device that is paired but not connected

From the paired phone list, select the device you want to connect and press the **Connect** button.



Changing Priority

What is Priority?

It is possible to pair up to five *Bluetooth*® Wireless Technology devices with the car audio system. The "Change Priority" feature is used to set the connection priority of paired phones.

Press the **SETUP** key ▶ Select [Phone] ▶ Select [Paired Phone List]



Features of your vehicle

From the paired phone list, select the phone you want to switch to the highest priority, then press the **Change priority** button from the Menu. The selected device will be changed to the highest priority.

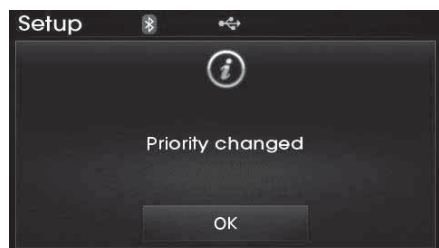

* NOTICE

Priority icon will be displayed when the selected phone is set as a priority phone.

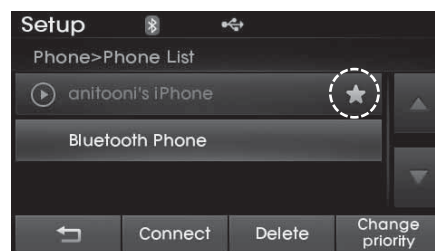

Disconnecting a Device

Press the **SETUP** key ▶ Select [Phone] ▶ Select [Paired Phone List]

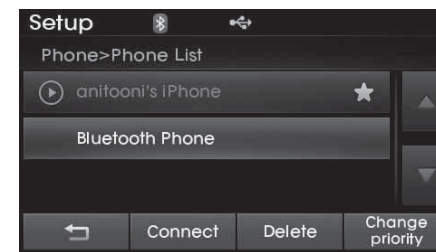

From the paired phone list, select the currently connected device and press the **Disconnect** button.

Deleting a Device

Press the **SETUP** key ▶ Select [Phone] ▶ Select [Paired Phone List]

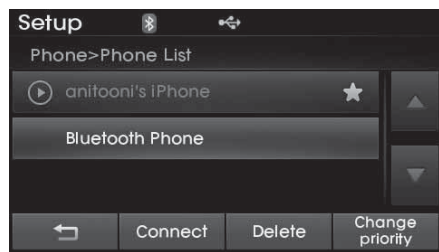

From the paired phone list, select the device you want to delete and press the **Delete** button.

* NOTICE

- When deleting the currently connected device, the device will automatically be disconnected to proceed with the deleting process.
- If a paired *Bluetooth*® Wireless Technology device is deleted, the device's call history and contacts data will also be deleted.
- To re-use a deleted device, you must pair the device again.

Features of your vehicle

USING *Bluetooth*® Wireless Technology

Phone Menu Screen

Phone Menus

With a *Bluetooth*® Wireless Technology device connected, press the **PHONE** key to display the Phone menu screen.



- 1) Favorites : Up to 20 frequently used contacts saved for easy access
- 2) Dial Number : Displays the dial screen where numbers can be dialed to make calls
- 3) Call History : Device the call history list screen

- 4) Contacts : Displays the Contacts list screen
- 5) Setup : Displays Phone related settings

* NOTICE

- If you press the [Call History] button but there is no call history data, a prompt is displayed which asks to download call history data.
- If you press the [Contacts] button but there is no contacts data stored, a prompt is displayed which asks to download contacts data.
- This feature may not be supported in some mobile phones. For more information on download support, refer to your mobile phone user's manual.

Favorites

Press the **PHONE** key ▶ Select [Favorites]

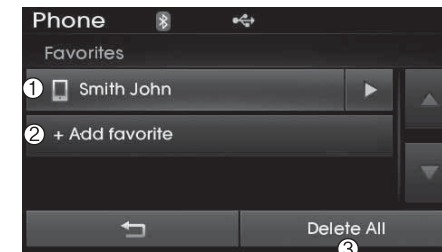

- 1) Saved favorite contact : Connects call upon selection
- 2) To add favorite : Downloaded contacts be saved as favorite.
- 3) Delete All : Delete all stored favorite contacts

* NOTICE

- To save Favorite, contacts should be downloaded.
- Contact saved in Favorites will not be automatically updated if the contact has been updated in the phone. To update Favorites, delete the Favorite and create a new Favorite.

Features of your vehicle

Calling by Dialing a Number

Press the **PHONE** key ▶ Select [Dial Number]

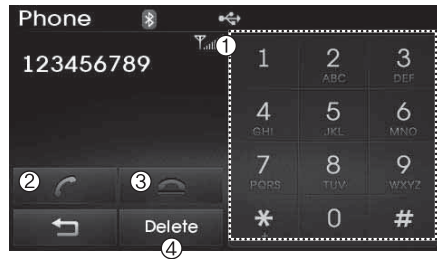

- 1) Dial Pad : Used to enter phone number
- 2) Call : If a number has been entered, calls the number. If no number has been entered, switches to call history screen
- 3) End : Deletes the entered phone number
- 4) Delete : Deletes entered numbers one digit at a time

Answering Calls

Answering a Call

Answering a call with a *Bluetooth®* Wireless Technology device connected will display the following screen.

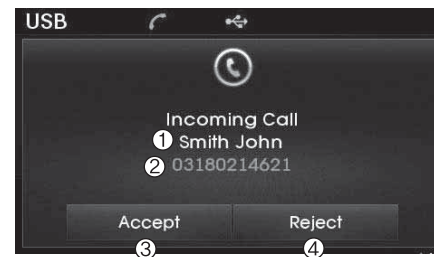

- 1) Caller : Displays the other party's name when the incoming caller is saved within your contacts
- 2) Incoming Number : Displays the incoming number
- 3) Accept : Accept the incoming call
- 4) Reject : Reject the incoming call

* NOTICE

- When an incoming call pop-up is displayed, most Audio and SETUP mode features are disabled. Only the call volume will operate.
- The telephone number may not be properly displayed in some mobile phones.
- When a call is answered with the mobile phone, the call mode will automatically revert to Private mode.

Features of your vehicle

During a Handsfree Call



- 1) Caller : Displays the other party's name if the incoming caller is saved within your contacts
- 2) Incoming Number : Displays the incoming number
- 3) Call time : Displays the call time
- 4) End : Ends call
- 5) Private : Converts to Private mode
- 6) Out Vol. : Sets call volume as heard by the other party
- 7) Mute : Turns Mic Mute On/Off

* NOTICE

If the mic is muted, the other party will not be able to hear your voice.

Call History

Press the **PHONE** key ▶ Select [Call History]



A list of incoming, outgoing and missed calls is displayed.

Press the **Download** button to download the call history.

1) Call History :

- Displays recent calls (call history)
- Connects call upon selection

2) Download : Download Recent Call History

- Call history may not be saved in the call history list in some mobile phones.

- Calls received with hidden caller ID will not be saved in the call history list.
- Calling through the call history is not possible when there is no call history stored or a *Bluetooth*® Wireless Technology phone is not connected.
- Up to 50 received, dialed and missed calls are stored in Call History.
- Time of received/dialed calls and call time information are not saved.

Features of your vehicle

Contacts

Press the **PHONE** key ▶ Select [Contacts]

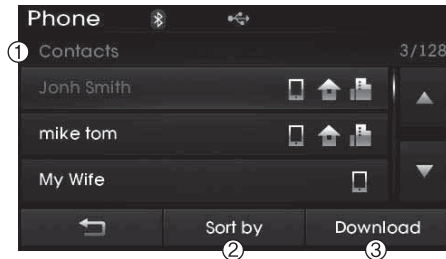

The list of saved phone book entries is displayed. Press the **Download** button to download the call history.

1) Contacts List :

- Displays downloaded contacts entries
- Connects call upon selection

2) Sort by : Find a contact in an alphabetical order.

3) Download : Download contacts entries

*** NOTICE**

- Up to 1,000 contacts saved in your *Bluetooth*® Wireless Technology phone can be downloaded into the car contacts. Contacts that have been downloaded to the car cannot be edited or deleted on the phone.
- Mobile phone contacts are managed separately for each paired *Bluetooth*® Wireless Technology device (max 5 devices x 1,000 contacts each). Previously downloaded data is maintained even if the *Bluetooth*® Wireless Technology device has been disconnected. (However, the contacts and call history saved to the phone will be deleted if a paired phone is deleted.)
- It is possible to download contacts during Bluetooth streaming audio.
- When downloading contacts, the icon will be displayed within the status bar.

(Continued)

(Continued)

- It is not possible to begin downloading a contact list when the contact download feature has been turned off within the *Bluetooth*® Wireless Technology device. In addition, some devices may require device authorization upon attempting to download contacts. If downloading does not normally occur, check the *Bluetooth*® Wireless Technology device settings or the screen state.
- The contacts download feature may not be supported in some mobile phones. For more information of supported *Bluetooth*® devices and function support, refer to your phone's user manual.

Features of your vehicle

Bluetooth® Wireless Technology Setting

Pairing a New Device

Press the **SETUP** key ▶ Select [Phone] ▶ Select [Pair Phone]

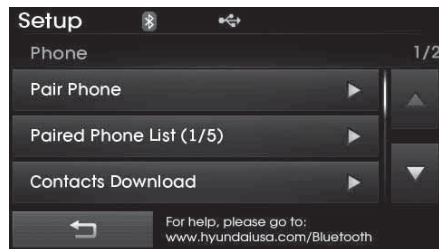

Bluetooth® Wireless Technology devices can be paired with the audio system.

For more information, refer to the “Pairing through Phone Setup” section within *Bluetooth®* Wireless Technology.

Viewing Paired Phone List

Press the **SETUP** key ▶ Select [Phone] ▶ Select [Paired Phone List]

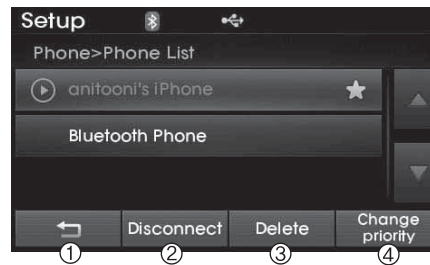

This feature is used to view mobile phones that have been paired with the audio system. Upon selecting a paired phone, the setup menu is displayed.

For more information, refer to the “Setting *Bluetooth®* Wireless Technology Connection” section within *Bluetooth®* Wireless Technology.

- 1)  : Moves to the previous screen
- 2) Connect/Disconnect Phone : Connect/ disconnects currently selected phone
- 3) Delete : Deletes the currently selected phone
- 4) Change Priority : Sets currently selected phone to highest connection priority

Features of your vehicle

* NOTICE BEFORE DOWNLOADING CONTACTS

- Only contacts within connected phones can be downloaded. Also check to see that your mobile phone supports the download feature.
- To learn more about whether your mobile phone supports contacts downloads, refer to your mobile phone user's manual.
- The contacts for only the connected phone can be downloaded.

Downloading Contacts

Press the **SETUP** key ▶ Select [Phone] ▶ Select [Contacts Download]

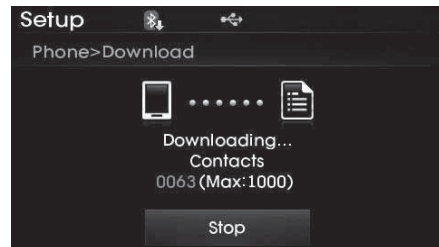

As the contacts are downloaded from the mobile phone, a download progress bar is displayed.

* NOTICE

- Upon downloading phone contacts, the previous corresponding data is deleted.
- This feature may not be supported in some mobile phones.
- Voice Recognition may not operate while contacts are being downloaded.

Outgoing Volume

Press the **SETUP** key ▶ Select [Phone] ▶ Select [Outgoing Volume]



Use the **-**, **+** buttons to adjust the outgoing volume level.

* NOTICE

While on a call, the volume can be changed by using the **SEEK TRACK** key.

Turning Bluetooth System Off

Press the **SETUP** key ▶ Select [Phone] ▶ Select [Bluetooth System Off]
Once *Bluetooth*® Wireless Technology is turned off, *Bluetooth*® Wireless Technology related features will not be supported within the audio system.

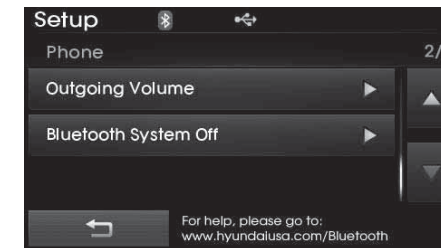

* NOTICE

To turn *Bluetooth*® Wireless Technology back on, go to **SETUP** ▶ [Phone] and press "Yes".

Features of your vehicle

VOICE RECOGNITION

Using Voice Recognition

Starting Voice Recognition

Shortly press the  key on the steering wheel remote controller. Say a command.

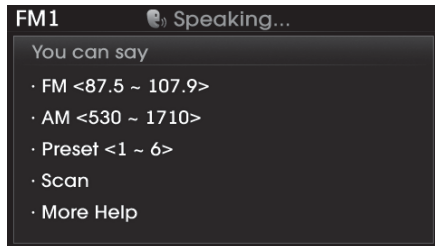

If prompt feedback is in [ON], then the system will say "Please say a command after the beep (BEEP)"

- If prompt feedback is in [OFF] mode, then the system will only say "(BEEP)"
- To change Prompt Feedback [On]/[Off], go to **SETUP** ▶ [System] ▶ [Prompt Feedback]

* NOTICE

For proper recognition, say the command after the voice instruction and beep tone.

Contact List Best Practices

- 1) Do not store single-name entries (e.g., "Bob", "Mom", "Kim", etc.). Instead, always use full names (including first and last names) for all contacts (e.g., use "Jacob Stevenson" instead of "Dad").
- 2) Do not use abbreviations (i.e., use "Lieutenant" instead of "Lt." or "Sergeant" instead of "Sgt.>").
- 3) Do not use acronyms (i.e., use "County Finance Department" instead of "CFD").
- 4) Do not use special characters (e.g., "@", "hyphen -", "asterisk *", "ampersand &").
- 5) If a name is not recognized from the contact list, change it to a more descriptive name (e.g., use "Grandpa Joseph" instead of "Pa Joe").

Skipping Prompt Messages

While prompt message is being stated ▶ Shortly press the  key on the steering remote controller

The prompt message is immediately ended and the beep tone will sound. After the "beep", say the voice command.

Re-starting Voice Recognition

While system waits for a command ▶ Shortly press the  key on the steering remote controller

The command wait state is immediately ended and the beep tone will sound. After the "beep", say the voice command.

Features of your vehicle

* Illustration on using voice commands

• Starting voice command.

Shortly pressing the  key (under 0.8 seconds):

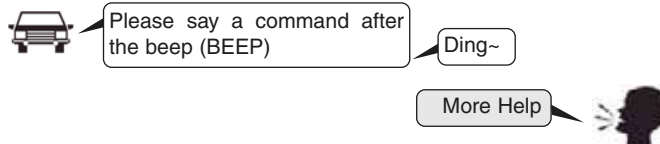

More Help
Here are some examples of mode commands. You can say a radio type like 'FM', 'AM', or 'Satellite'. You can also say a media source like 'USB', 'My Music', or 'iPod'. Additionally, there are phone commands like "Contacts", 'Call History', or 'Dial Number'. You can find more detailed commands in the user's manual. Please say a command after the beep.



More Help
Here are some examples of mode commands. You can say a radio type like 'FM', 'AM', or 'Satellite'. You can also say a media source like 'USB', 'My Music', or 'iPod'. Additionally, there are phone commands like "Contacts", 'Call History', or 'Dial Number'. You can find more detailed commands in the user's manual. Please say a command after the beep.

• Skipping Voice Recognition

Shortly pressing the  key (under 0.8 seconds):

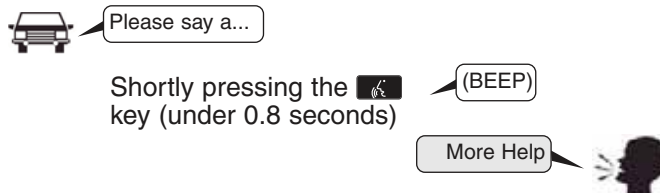

• End voice command.

Shortly pressing the  key (under 0.8 seconds):

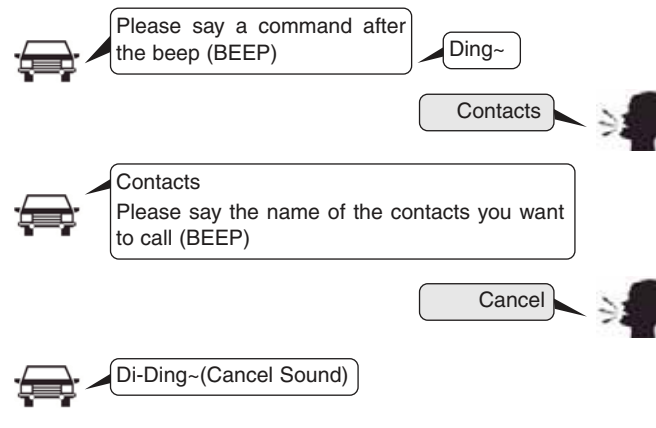

Features of your vehicle

Voice Command List

- **Common Commands:** These commands can be used in most operations. (However a few commands may not be available during certain operations)

Command	Function
More Help	Provides guidance on commands that can be used anywhere in the system.
Help	Provides guidance on commands that can be used within the current mode.
Call<Name>	Calls <Name> saved in Contacts Ex) Call "John Smith"
Call <Name> on Mobile	Calls <Name> to the number that is saved as "Mobile" in Contacts Ex) Call "John Smith" on Mobile
Call <Name> in Office	Calls <Name> to the number that is saved as "Office" in Contacts Ex) Call "John Smith" in Office
Call <Name> at Home	Calls <Name> to the number that is saved as "Home" in Contacts Ex) Call "John Smith" at Home
Call <Name> on Other	Calls <Name> to the number that is saved as "Other" in Contacts Ex) Call "John Smith" on Other
Phone	Provides guidance on Phone related commands. After saying this command, say "Favorites", "Call History", "Contacts" or "Dial Number" execute corresponding functions.
Favorites	Display the Favorite screen.
Call History	Displays the Call History screen.

Command	Function
Contacts (Call by Name)	Displays the Contacts screen. After saying this command, say the name of a contact saved in the Contacts to automatically connect the call.
Dial Number	Display the Dial number screen. After saying this command, you can say the number that you want to call.
Redial	Connects the most recently called number.
Tutorial	Provide guidance on how to use voice recognition and Bluetooth® connections.
Radio	<ul style="list-style-type: none"> • When listening to the radio, displays the next radio screen. (FM1→FM2→AM→XM1→XM2→XM3→FM1) • When listening to a different mode, displays the most recently played radio screen. • When currently listening to the FM radio, maintains the current state. • When listening to a different mode, displays the most recently played FM screen.
FM1(FM One)	Displays the FM1 screen.
FM2(FM Two)	Displays the FM2 screen.
AM	Displays the AM screen.

Features of your vehicle

Command	Function
FM Preset 1~6	Plays the most recently played broadcast saved in FM Preset 1~6.
AM Preset 1~6	Plays the broadcast saved in AM Preset 1~6.
FM 87.5~107.9	Plays the FM broadcast of the corresponding frequency.
AM 530~1710	Plays the AM broadcast of the corresponding frequency.
XM (Satellite)	<ul style="list-style-type: none"> • When currently listening to the SiriusXM™, maintains the current state. • When listening to a different mode, displays the most recently played SiriusXM™ screen.
XM (Satellite) 1~3	Displays the selected SiriusXM™ screen.
XM Channel 0~255	Plays the selected SiriusXM™ channel.
Media	Moves to the most recently played media screen.
CD	Plays the music saved in the CD.
USB	Plays USB music.
iPod®	Plays iPod music.

Command	Function
My Music	Plays the music saved in My Music.
AUX (Auxiliary)	Plays the connected external device.
Bluetooth® Audio	Plays the music saved in connected Bluetooth® device.
Please repeat	Repeats the most recent comment.
Mute	Mutes the sound
Cancel (Exit)	Ends voice command.

Features of your vehicle

- FM/AM radio commands: available during FM, AM radio operation

Command	Function
Preset 1~6	Plays the broadcast saved in Preset 1~6.
Scan	Scans receivable frequencies from the current broadcast and plays for 10 seconds each.
Preset Scan	Moves to the next preset from the current present and plays for 10 seconds each.
Information	Displays the information of the current broadcast.(This feature can be used when receiving RBDS broadcasts.)

- Satellite radio commands: Commands that can be used while listening to Satellite Radio.

Command	Function
Channel 0~255	Play the selected Satellite Radio channel.
Scan	Scans receivable channels from the current broadcast and plays for 10 seconds each.
Preset 1~6	Plays the broadcast saved in Preset 1~6.
Information	Displays the information of the current broadcast.

Features of your vehicle

- Audio CD commands: Commands available during Audio CD operation

Command	Function
Play	Plays the currently paused track.
Pause	Pauses the current track.
Shuffle	Randomly plays the tracks within the CD.
Shuffle Off	Cancels random play to play tracks in sequential order.
Repeat	Repeats the current track.
Repeat Off	Cancels repeat play to play tracks in sequential order.
Track 1~30	Plays the desired track number.

- MP3 CD / USB commands: Commands available during USB and MP3 CD operation

Command	Function
Play	Plays the currently paused file.
Pause	Pauses the current file.
Shuffle	Randomly plays the files within the current folder.
Shuffle Off	Cancels random play to play files in sequential order.
Repeat	Repeats the current file.
Repeat Off	Cancels repeat play to play files in sequential order.
Next Folder	Play the first file in the next folder
Previous Folder	Play the first file in the previous folder

Features of your vehicle

- **iPod® Commands:** Commands available during iPod® operation

Command	Function
Play	Plays the currently paused song.
Pause	Pauses the current song.
Shuffle	Randomly plays the songs within the current category.
Shuffle Off	Cancels random play to play songs in sequential order.
Repeat	Repeats the current song.
Repeat Off	Cancels repeat play to play songs in sequential order.

- **My Music Commands:** Commands available during My Music operation

Command	Function
Play	Plays the currently paused file.
Pause	Pauses the current file.
Shuffle	Randomly plays all saved files.
Shuffle Off	Cancels random play to play files in sequential order.
Repeat	Repeats the current file.
Repeat Off	Cancels repeat play to play files in sequential order.
Delete	Deletes the current file. You will bypass an additional confirmation process.

Features of your vehicle

SETUP

Starting Mode

Press the **SETUP** key ▶ Select the Setup screen.

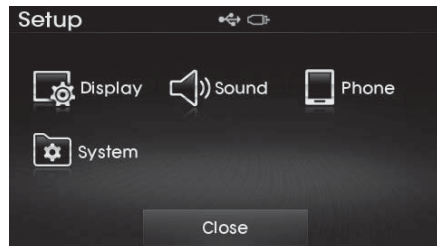

You can select and control options related to [Display], [Sound], [Phone] and [System].

Display Settings

Adjusting the Brightness

Press the **SETUP** key ▶ Select [Display] ▶ Select [Brightness]

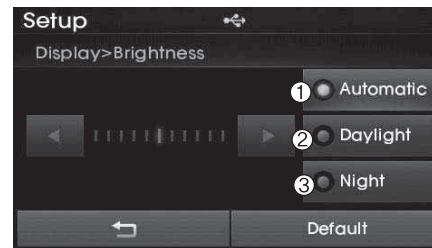

Use the ◀, ▶ buttons to adjust the screen brightness or set the Brightness on Automatic, Daylight, or Night mode.

Press the **Default** button to reset.

- 1) Automatic : Adjusts the brightness automatically
- 2) Daylight : Always maintains the brightness on high
- 3) Night: Always maintains the brightness on low

Mode pop up

Press the **SETUP** key ▶ Select [Display] ▶ Select [Mode Pop up]



This feature is used to display the Mode Pop up screen when entering radio and media modes.

When this feature is turned on, pressing the **RADIO** or **MEDIA** key will display the Mode Pop up screen.

* NOTICE

The media Mode pop up screen can be displayed only when two or more media modes have been connected.

Features of your vehicle

MP3 Information Display

Press the **SETUP** key ▶ Select [Display] ▶ Select [Media Display]

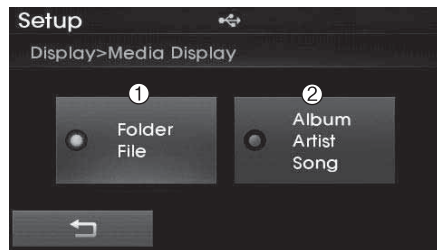

This feature is used to change the information displayed within USB and MP3 CD modes.

- 1) Folder File : Displays file name and folder name
- 2) Album Artist Song : Displays album name/artist name/song

Sound Settings

Sound Settings

Press the **SETUP** key ▶ Select [Sound] ▶ Select [Sound Setting]



Use the **◀**, **▶**, **▲**, **▼** buttons to adjust the Fader/Balance settings.

Use the **◀**, **▶** buttons to adjust the Bass/Middle/Treble settings.

Press the **Default** button to reset.

Features of your vehicle

SDVC (Speed Dependent Volume Control)

Press the **SETUP** key ▶ Select [Sound]
▶ Select [Speed Dependent Vol.]

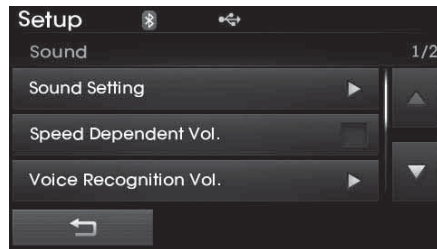

The volume level is controlled automatically according to the vehicle speed. SDVC can be set by selecting from On/Off.

Voice Recognition Volume

Press the **SETUP** key ▶ Select [Sound]
▶ Select [Voice Recognition Vol.]



Turn the **TUNE** knob to adjust the Voice Recognition volume.

Touch Screen Beep

Press the **SETUP** key ▶ Select [Sound]
▶ Select [Touch Screen Beep]

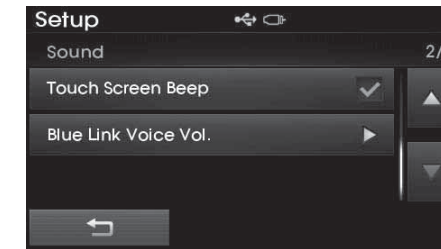

This feature is used to turn the touch screen beep on/off.

Features of your vehicle

Blue Link Voice Volume

Press the **SETUP** key ▶ Select [Sound]
▶ Select [Blue Link Voice Vol.]

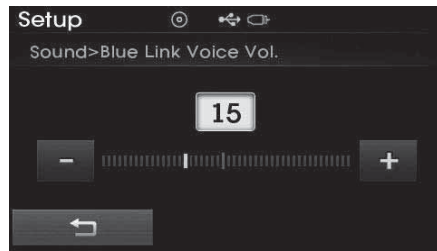

Turn the **TUNE** knob to adjust the Blue Link Voice Volume.

* Blue Link® may differ depending on the selected audio.

System Setting

Memory Information

Press the **SETUP** key ▶ Select [System] ▶ Select [Memory Information]

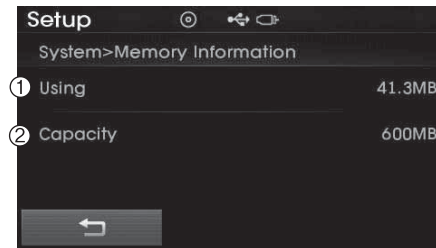

This feature displays information related to system memory.

- 1) Using : Displays capacity currently in use
- 2) Capacity : Displays total capacity

Prompt Feedback

Press the **SETUP** key ▶ Select [System] ▶ Select [Prompt Feedback]

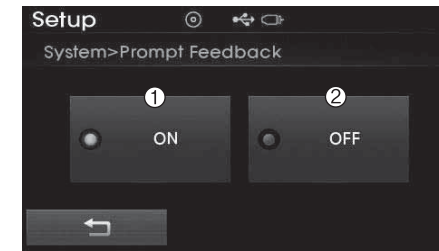

This feature is used to select the desired prompt feedback option from ON and OFF.

- 1) ON : When using voice recognition, provides detailed guidance prompts
- 2) OFF : When using voice recognition, omits some guidance prompts

Language

Press the **SETUP** key ▶ Select [System] ▶ Select [Language]

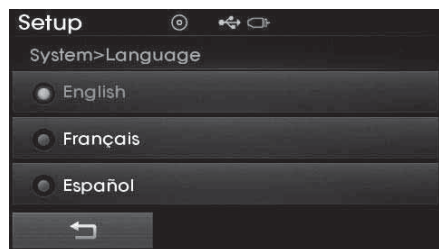

This feature is used to change the system and voice recognition language.

If the language is changed, the system will restart and apply the selected language.

REAR VIEW CAMERA (if equipped)

- The system has been equipped with a rear view camera for user safety by allowing a wider rear range of vision.
- The rear view camera will automatically operate when the ignition key is turned ON and the shift lever is set to R (Reverse).
- The rear view camera will automatically stop operating when shift lever is selected out of R (Reverse).

CAUTION

- *The rear view camera has been equipped with an optical lens to provide a wider range of vision and may appear different from the actual distance. For safety, directly check the rear and left/right sides.*

Features of your vehicle

Blue Link® (if equipped)

Hyundai aims to offer differentiated customer values through a 'Connected Car Life,' which is to provide consumers with fast and reliable IT technology. As consumers' lifestyles become more and more mobile in thanks to remarkable advances in smart phones, tablet PCs and overall wireless telecommunication, new lifestyle patterns demand seamless connection between one's office, home, outdoors and automobiles.

Automobile companies are now faced with the task of shifting their paradigm from vehicle-centered services to customer value-centered services, with the ultimate goal of securing global leadership in the field of vehicle IT and telematics.



Hyundai plans to achieve this by realizing a terminal platform flexible to changes in IT technology, cooperating with global IT companies, creating an eco-system and providing the latest contents & services based on an open environment.

Using the Room Mirror Key

Selecting the room mirror key will allow you to make service required inquiries, POI info searches, and emergency rescues by connecting to the Blue Link® Center.

Such features can be used only after subscribing to the Blue Link® service.

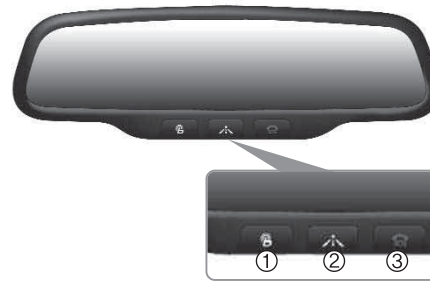

① (Blue Link® Center)

Makes requests for Blue Link® service related inquiries and consultations.

A call is connected to the Blue Link® service center employee.

Re-pressing the key will end the call.

This feature does not operate when you are on a Bluetooth® phone call.

② (Blue Link® for POI)

• Blue Link® for Voice command

Starts Blue Link® voice command.

Voice receiving voice guidance, shortly press the button to convert to voice command mode. Press and hold the button to end voice command.

• TBT VR Commands

1. Navigate to

"Navigate to" voice command is used to request the download of route data for a new destination, saved destinations, daily routes and previous destinations.

2. Save Destination

"Save Destination" VR command is used to assign a voice tag to the last downloaded destination and store it in a destination directory.

NOTE:

The Turn by Turn(TBT) feature supports the store of ten(10) destinations in the TBT destinations directory.

Features of your vehicle

3. Route Preview

“Route Preview” VR command allows the user to preview the route instructions (upcoming maneuver instructions) at any time during the route guidance.

4. Destinations List

“Destinations List” VR command allows the user to preview and delete the stored destinations with their associated voice tags in the Turn by Turn destinations directory.

5. Voice Guidance

“Voice Guidance” VR command allows the user to mute/unmute the Turn by Turn(TBT) direction announcements.

6. Suspend Route

“Suspend Route” VR command allows the user to suspend and pause Turn by Turn(TBT) route guidance while in the guidance mode.

7. Resume Route

“Resume Route” VR command allows the user to resume Turn by Turn(TBT) route guidance.



③ (Blue Link® for SOS)

In the case of an emergency, requests for help to the Blue Link® center.

Call is connected to the Blue Link® emergency rescue center. Re-pressing the key will end the call.

If already on a Bluetooth® phone call, the call will end to connect you to the Blue Link® Emergency Rescue Center.

CAUTION

- *You cannot talk simultaneously on the Bluetooth® phone and Blue Link® phone.*
- *While on a Bluetooth® call, pressing the  key or  key will display a message indicating that you are currently on a call.*
- *A message will be displayed if you receive a Bluetooth® Bluetooth® Wireless Technology call while already on a Blue Link® call. At this time, press the  key on the steering wheel remote controller to accept the call. The phone bell will not ring.*

Features of your vehicle

Eco Coach



- What is Eco Coach?

Every 2.5 minutes, Eco Coach compares your fuel economy against the government tested average (EPA) or other similar Hyundai models (community), based on your preference. Each month, or after every tank fill up, Eco Coach rates your extended average and gives you a reward star if you best the average.

See your My Hyundai web page for more information.

- What does the bar graph and horizontal line mean?

The horizontal line is adjusted once per month or at each tank full, based on your preference; it represents the EPA combined average or community average fuel economy target.

- What is My Eco MPG?

Your actual fuel economy average over 2.5 minutes.

This value is also shown in bar graph as your “now” rating.

- What are Eco Rewards?

If you beat the average (the EPA or community), you will receive an Eco Reward point.

See your my Hyundai web page for more information.

[Eco Driving] will not operate if the vehicle ignition is not turned on. Please operate with the ignition turned on.

Features of your vehicle

Turn by Turn

The Turn by Turn feature can be used through Blue Link®.

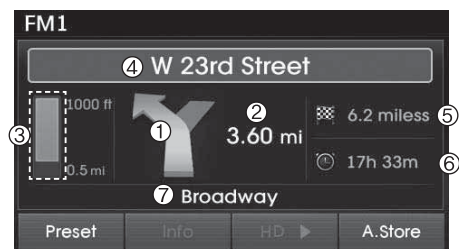

- 4.Next Street name
- 5.Distance to destination
- 6.Expected Time Arrival
- 7. Current Street name

* For information on specific Blue Link® operations, please refer to a separate manual.

- 1.Direction Indicator Image
- 2.Remaining distance until next point
- 3.The Count bar is divided into a total of 9 levels.

9 Level	0.5mi	8 Level	0.4mi
7 Level	0.3mi	6 Level	0.2mi
5 Level	0.1mi	4 Level	400ft
3 Level	300ft	2 Level	200ft
1 Level	100ft		

Appendix Homologation

FCC Compliance Statement.

This device complies with part 15 of the FCC Rules.

Operation is subject to the following two conditions :

- (1) This device may not cause harmful interference, and**
- (2) This device must accept any interference received, including interference that may cause undesired operation.**

This equipment generates, uses and can radiate radio frequency energy and, if not installed and used in accordance with the instructions, may cause harmful interference to radio communications. However, there is no guarantee that interference will not occur in a particular installation. If this equipment does cause harmful interference to radio or television reception, which can be determined by turning the equipment off and on, the user is encouraged to try to correct the interference by one or more of the following measures:

- Reorient or relocate the receiving antenna.
- Increase the separation between the equipment and receiver.
- Connect the equipment into an outlet on a circuit different from that to which the receiver is connected.
- Consult the dealer or an experienced radio/TV technician for help.

Do Not



Any changes or modifications to the equipment not expressly approved by the party responsible for compliance could void user's authority to operate the equipment.

Be sure

The antenna(s) used for this device must be installed to provide a separation distance of at least 20 cm from all persons and must not be co-located or operating in conjunction with any other antenna or transmitter.