

Haier Network Air Conditioner

Free Combination Multi-split Type Room Air Conditioner

Outdoor unit

AU422BIBAA

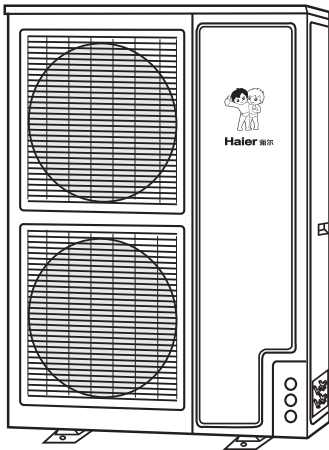

CONTENTS

To User.....	Inside front cover
Safety Precautions.....	1
Name of Parts.....	2
Installation Instruction.....	3-6
Electric Wiring.....	7-10
Operation and Performance.....	11
Troubleshooting.....	12-13
Pipe System Chart.....	14

No.*0010571564

- For the sake of safety and in order to use the air conditioner correctly, please read this manual and the operation manual of indoor unit carefully before using
- After reading this attached manual, please keep it properly. If the user is changed, please do give this manual to him

Characteristics of Products

Characteristics of Products

1. 220~230V normal power, suitable for both commercial use and home use.
2. Free choice of wire control and remote control.
3. Several types of indoor units, free combination of specification.
4. Single outdoor unit, space-saving and cost-saving.
5. Far distance network technology, realize the intelligentized living area (For details, please refer to the manual of indoor unit).
6. POWER FAILURE RESUME FUNCTION. Automatic set when power resumes.









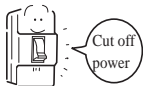

Safety Precautions

The following lists four kinds of safety precaution items and suggestions:

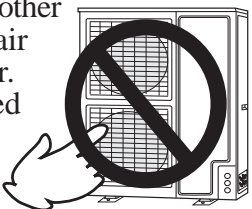
- ⚠ **Warning:** Improper use may cause death or serious injury.
- ⚠ **Notice:** Improper use may cause body hurt or unit damage; in some circumstance, it may cause serious results.
- 🚫 : Those contents marked with "Prohibition" are definitely prohibited action, otherwise, it may cause unit damage or risk to users' safety.
- ❗ : Those contents marked with "Forced" are definitely forced action, otherwise, it may cause unit damage or risk to users' safety.

The following safety precautions must be observed.

This safety precautions should keep in hand for reference.

⚠ Warning	
<ul style="list-style-type: none"> • Commissioned installation The installation work should be done by the after-sales service worker. Self-installation may cause water leakage, electric shock and fire accident because of improper installation.  • It is strictly prohibited to rebuild the air conditioner by yourself. Improper rebuilding may cause fire, electric shock and water leakage.  • If abnormal conditions (sear smell) occur, please stop the unit, turning off the electric power and contact the after-sales service center for solution. If still using the unit under this circumstance, the air conditioner may be damaged and may also cause electric shock or fire accidents.   • When needing repair, please ask the after-sales service work for help. Improper maintenance and repair may cause water leakage, electric shock and fire.  • During the unit operation, do not insert fingers or other articles alike into the air inlet, outlet and louver. Because the high-speed fan is very dangerous, it may cause hurt.  	<ul style="list-style-type: none"> • Ask after-sales service worker to take measure to prevent refrigerant from leaking. If the leaked refrigerant exceeds a certain density, it will cause lack of oxygen. If the room installed with air conditioner is too small, do take enough measure in order to avoid lack of oxygen even if refrigerant leaks.  • When the air conditioner must be dismantled and reinstalled, please ask the after-sales service center to do this work. Improper installation may cause water leakage, electric shock and fire.  • After a long-time using of the air conditioner, please check if the foundation of the unit is damaged. If the foundation is damaged without repair, the unit may fall down leading to body hurt.  • Any inflammable spray liquid cannot be place or use near the air conditioner, otherwise, fire accident may happen.  • Only after stopping the unit and cutting off power can clean the air conditioner to avoid electric shock or injury. 

Name of Parts

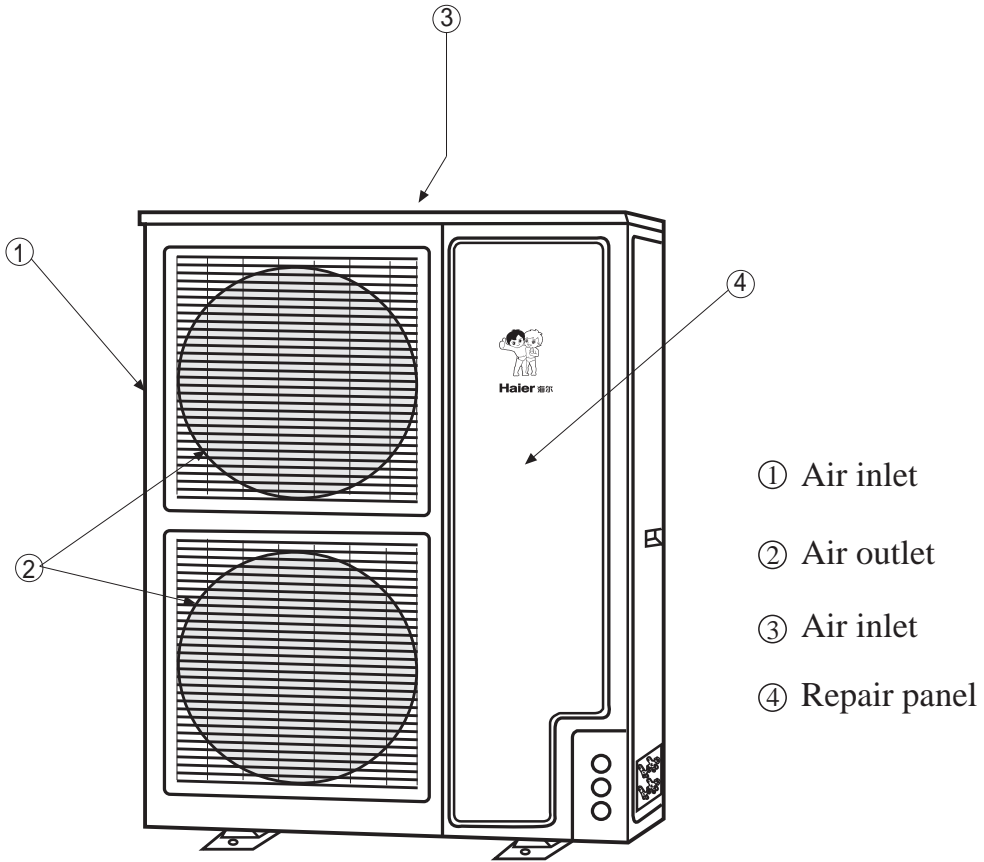

Note:

Do not block the air inlet and air outlet, otherwise the performance of the air conditioner may be lowered.

1. Choose installation place

The chosen installation place should meet the following requirements and get the user's consent.

- Place air can freely circulate.
- Place can perform level installation.
- The condensate water can be drained smoothly.
- Place where the noise and hot air will not disturb the neighbors.
- Place can ensure the space for successful maintenance and repair.
- Place where the four corners of the unit are easily installed and leaves at least 1m height space.
- Place where the wall hole is easy for drainage.
- When installing multiple units, make sure to leave enough space to avoid air short-circuit.
- If the outdoor unit near the street, it should not be lower than 2.5m.
- Please install in the place that can sufficiently bear the weight of the unit. The air conditioner cannot install on a non-special metal frame (e.g. theft guard net).
- Install in the place with intensity as high as possible to prevent the noise and vibration from spreading to other places.
- Avoid the place where the strong airflow directly toward the air inlet or air outlet.
- Avoid the place where high frequency electromagnetic waves are generated to prevent the communication of indoor and outdoor from being affected.
- Avoid the place where the combustible gas exists. The combustible gas around the air conditioner may cause fire.
- Avoid the place where the combustible gas may be leaked. If the leaked gas gathers around the air conditioner, it may cause fire accident.
- Avoid the place with too much oil, vapor and salinity, such as, seashore and hot spring area and the area with sulfurated gas, etc. corrosive gas.
- If install in these places, the air conditioner needs special maintenance.
- Avoid the place where the heat source directly radiates or with other heat sources.

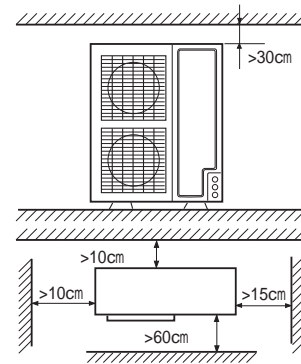





Installation instruction

Installation tools

- | | |
|--------------------------------|------------------------|
| 1. Screwdriver | 2. Steel saw |
| 3. Pipe cutter | 4. Pipe flarer |
| 5. Knife | 6. 70mm diameter drill |
| 7. Leakage detector/soap water | |
| 8. Spanner (diameter 17,27mm) | |
| 9. Spanner (14, 17, 19, 27mm) | |
| 10. Pincers | 11. Tape measure |
| 12. Scraper | 13. Refrigerant oil |
| 14. Vacuum pump | 15. Nitrogen tank |

The following is the manual mentioned standard accessories, please check them by yourself.

Name	Shape	Amount
Putty		1
Rubber cushion		4
Refrigerant oil		1
Plastic clamp		6
Manual		1

Install and fix

- Use screw bolt (M10) and screw nut to tightly fix the outdoor unit on its bracket, and keep it level.
- When install on the wall or roof, fix the bracket firmly and reliably to prevent from the attack of earthquake or strong wind.
- In order to lower the vibration, the rubber cushion must be installed.
- The installation slant degree of the unit should be less than 3*.

Standard accessories (self-provided installation parts)

Mark	A	B	C	D	E	F
Name of parts	Adhesive tape	Pipe supporting plate	Connection hose	Drain hose	Thermal insulation material	Plaster powder

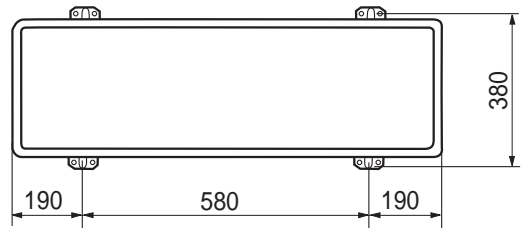

Installation dimension of outdoor unit (mm)

Connection of pipe

⚠ Warning

- During installation, if the refrigerant leaks, please immediately take ventilation measure.
- Once the leaked refrigerant gas meet fire, poisonous gas will be generated.
- After finishing installation, make sure the refrigerant gas will not lead.

1. Connection method of pipe

- (1) The joint of refrigerant connection pipe is at the right side of the outdoor unit.
- (2) The connection pipe can be connected out from the right side of outdoor unit.
 - For single system, the max length of connection pipe is 15m and the max fall is 5m.
 - In order to guarantee efficiency, the connection pipe should as short as possible.
 - Daub the refrigerant oil on the joint and flare.

Installation instruction

- When bending the pipes, give the roundness as large as possible, to avoid crashing and flat the pipes.
- To connect the pipe, fit the center and use hand to screw the nut, as shown in figure:

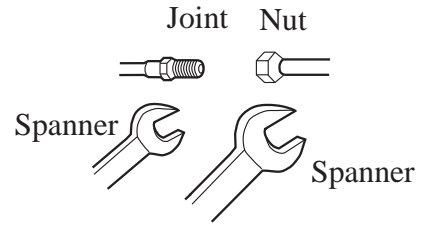

If do not fit the center and screw the nut hard, the screw thread may be damaged, which will cause refrigerant leakage.

- Pay attention not to let alien matters, such as sand, water get into the pipe.

Pipe diameter	Fasten torque
Liquid pipe 9.52mm	32.7~39.9 N.m
Gas pipe 15.88mm	62.8~74.5 N.m

(3) Connect the connection pipe of outdoor unit

- According to the connection method to connect the connection pipe and in/out liquid pipe and gas pipe.

2. Welding method of pipe

- (1) The refrigerant pipe should use clean new pipe. When performing work, pay attention to preventing vapor, dust from entering into the pipe.
- (2) When loosening and fastening the connection screw nut, do use two hands to handle. If use one hand, it cannot reach the necessary fastening level.

Please perform the fastening of the screw nut according to the specified torque

External diameter of connection pipe (mm)	Installation torque (N.m)	Fastening torque (N.m)
*9.52	24.5 (2.5kgf.m)	29.4 (3.0kgf.m)
*15.88	49.0 (5.0kgf.m)	53.9 (5.5kgf.m)

3. Cut and flaring method

Use pipe cutter to cut the pipe, the burrs must be removed.

After inserting the flarer, perform flared nut.

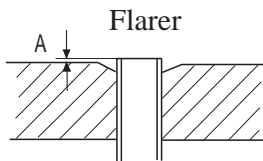

Flaring dimensions as follows:

Connect pipe	Pipe diameter	Dimension A (mm)
Liquid pipe	9.52mm (3/8")	1.0-1.2
Gas pipe	15.88mm (5/8")	1.4-2.2

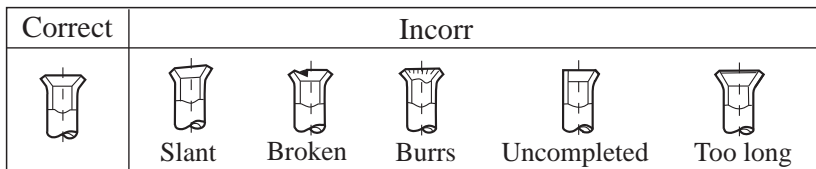

When connect the accessory thermal insulation material with the thermal insulation material of the onsite connection pipe, do not leave any gap. After finishing installing the thermal insulation material as below Figure shown, then use tape to bind them properly.

When connection, the connecting part should not leave any gap, and the thermal insulation material should be overlapped.

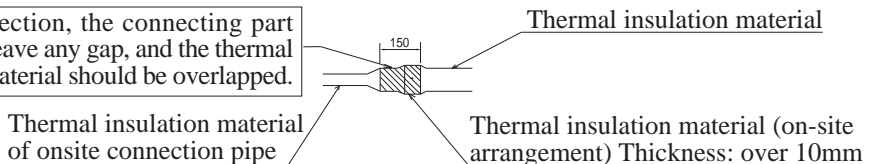

Installation instruction

4. Air discharging method

According to the method of the Figure shown, discharge the air in the indoor unit and pipe out.

- (1) Remove the valve cap of little stop valve of the outdoor unit.
- (2) Loosen the thick flare screw nut connected to big stop valve for about 1~1.5 circle.
- (3) Use spanner (hexagon spanner) open (turn anti-clockwise) the valve core of little stop valve for 90°, after the gas will discharge from the thick flare for about 15 seconds, then fasten the flare screw nut according to the specified torque.
- (4) Open the little and big stop valve.
- (5) Fasten the valve caps of the two valves.
- (6) Use leakage detector or soap water to check if there is leakage.

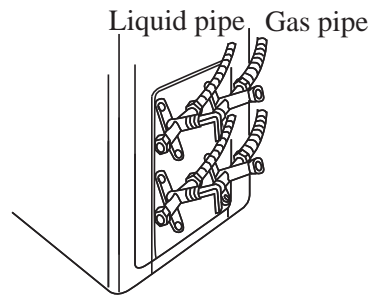

⚠ Notice

- When the length of the connection pipe of the single system exceeds 5m, it must use external system Freon R407C to discharge the air in the connection pipe out, then discharge the excessive refrigerant by the above method.
- The air conditioner newly left factory has been charged additional 80g R407C on the basis of the previous specified refrigerant amount.
- This method is only used in the installation for the first time to discharge the air in the connection pipe and indoor unit out.

5. Refrigerant charging amount



When the connection pipe (L) is less than or equal to 5m, it is not necessary to charge additional refrigerant. If the connection pipe (L) exceeds 5m, it needs to be added with 60g refrigerant every meter.



That is: refrigerant charging amount = (L-5)×60(g)

- Only in COOLING operation mode can charge the additional refrigerant.
- When charging, the refrigerant should be charged through the charging nozzle of the low pressure valve.
- When charging the refrigerant, please be careful not to let air mix into the system.

Electric wiring

⚠ Warning

- The wiring work should be commissioned to a qualified worker according to the installation manual to perform. The air conditioner must use special power circuit. Insufficient power capacity or improper work may cause electric shock and fire.
- When wiring, the power cable must use the specified cable to firmly connect and fix. Do not let the external force of the cable transfer to the terminal block. Improper connection or fixation may cause heat and fire, etc. accident. 
- Must connect with grounding wire. 

Connect with grounding wire as specified. Unreliable grounding may lead to electric shock. Do not connect the grounding wire on the gas pipe, city water pipe, lightning rod or telephone line. 
- Use the fuse with proper specification. Do not use wire or any other material to replace fuse, otherwise it may cause damage of unit or fire. 

⚠ Notice

- The Creepage breaker must be installed. 

If not installing Creepage breaker may easily cause electric shock. After wiring, please power on the unit to detect electricity leakage.
- If the power cable is damaged, in order to avoid danger, it must be changed by the manufacturer or its repair center or the similar professional personnel. For the power cable of indoor unit, please mate it according to the manual of indoor unit.
- Avoid the electric wire touching the high temperature part of the connection pipe, in order not to the insulation part of the cable be melted causing accidents.
- After connecting to the terminal block, the connection wire should be bent to a U-shaped bend and use wire presser to fix.
- Before performing vacuumizing the refrigerant pipe system, do not power on the outdoor unit,
- The power cable of indoor unit and the connection wire of indoor and outdoor unit should be complied with what the operation manual of indoor unit specified.
- The connection of power cable should be complied with the local wiring regulations.
- When wiring on site, choose the specification of wire and creepage breaker as follows:

Power supply	The minimum section area of wire (mm ²) (the connection wire of metal pipe and synthetic resin pipe)		Knife switch (A)		Creepage breaker
	Below 20m	Below 50m	Capacity	Fuse	
1PH, 220V, 50Hz	10	16	40	40	40A, 100mA, below 0.1s

Electric wiring

Instruction of wiring

Note:

- The air conditioner must use the special power circuit (Over 40A). The wiring method must be done by the qualified electrician according to the national wiring rules.
- The grounding line and the null line of the receptacle must be strictly separated. It is incorrect to connect the null line with the grounding line.
- When connecting the indoor & outdoor wire, check the number of the indoor & outdoor terminals, the terminals with the same number connected together with same one wire.
- All the wires should be copper core wires.
(When wiring, an appropriate distance should be kept between power wire and communication wire. They cannot be wrapped together, otherwise, it may cause communication disturbance, and the air conditioner cannot work normally.)
- Power supply: 1PH, 220~230V, 50Hz.
- The connection method of power cable is Y connection.

Wiring method of outdoor unit:

- Power cable (connect through outdoor unit)
Remove the repair panel of the outdoor unit, loosen the wire holding clamp A, then put the active wire, null wire and grounding wire of power cable through the wire holding clamp A and connect to the relative terminal block. After finishing connection, press the wire holding clamp A to the original state.

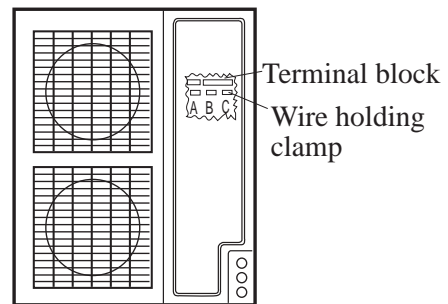

- Connect the outdoor unit power cable and communication wire
Loosen wire holding clamp B and C, put the power cable and communication wire connecting A system and B system indoor units through them and connect to the relative terminal block. After finishing connection, press the wire holding clamp B and C to the original state.

Wiring method of indoor unit:

- Connection the indoor unit power cable and communication wire
Loosen the wire holding panel, connect the power cable and communication wire of indoor unit to the relative terminal block.

Electric wiring

Wiring method

1. The wiring method of orbicular terminal

For the connection wire which end is orbicular terminal, its wiring method is as the right figure shown. Dismantle the screw and put it through the ring at the end of the connection wire, then connect it to the terminal block and tighten the screw.

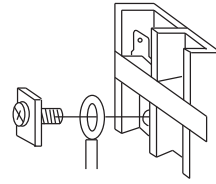

The wiring method of orbicular terminal

2. The wiring method of straight terminal

For those connection wires whose end are not orbicular terminals, their wiring method is:

Loosen the connecting screw, insert the end of the wire directly into the terminal block, and then tighten screw. Pull the wire outwards slightly to confirm it is held tightly.

3. Pressing method of connection wire:

After wiring, the connection wire must be pressed with wire holding clamp. The wire holding clamp should press on the out cover of the connection wire. As the right figure shown:

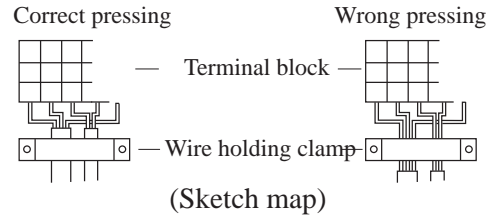

Note: The pressing method when there is not terminal block

Connect the wire of the same diameter to the two sides of wire ends.

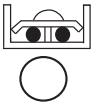

Do not connect the wire of the same diameter to the same side of the wire end.

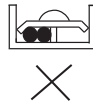

Do not connect the wires of different diameter together.

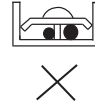

4. Connect wire between indoor & outdoor unit

- As the Figure shown, arrange the connection wire properly (note: the two * ends of the connection wire are different, do not connect them reversedly).
 - Open the repair panel of the outdoor unit, loosen the wire holding clamp (outdoor unit).
 - According to the wiring method * and the wiring diagram to connect * the connection wire properly.
 - According to the pressing method * of connection wire, press the connection wire properly. (outdoor unit)
- Reinstall the wiring cover.

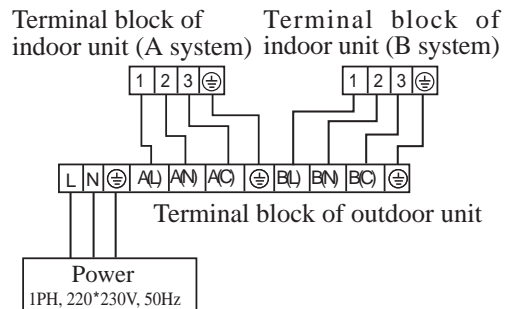

Electric wiring

Other instructions

1. Safety checking

*

- **If the joint of pipe leaks?
- **How about the thermal insulation of the joint of the pipe?
- **If the electric wire connection of the indoor and outdoor unit is inserted
- **firmly in the wiring board?
- **If the electric wire connection of the indoor and outdoor unit is fixed firmly?
- **If the arrangement of the drain hose correct?
- **If the connection of grounding wire is firm?
- **If the power voltage is complied with the electric specification?
- **If the noise is too large?

2. Test run

- (1)Open the stop valve of gas pipe.**
- (2)Open the stop valve of liquid pipe.**
- (3)Press ON/OFF button to start operation, use wire controller to set to COOLING operation.**
- (4)According to the operation manual to confirm the function of unit.**

Note:

After finishing installation work, perform test run to confirm everything is normal. Please explain the using method and maintenance method to the user according to the operation manual. Additionally, please give this manual to the user and ask them to keep it properly.

Operation and performance

3 minutes delay function

- If start the unit immediately after its stop, the compressor will operate after 3 minutes have elapsed to protect the unit.

The characteristic of HEATING operation

- During operation, if the outdoor temperature is too high, the fan motor of outdoor unit will automatically change to low fan speed.

About Defrosting operation in Heating operation

- During HEATING operation, when the outdoor unit frosts, in order to enhance the heating effect, the unit will automatically start DEFROSTING operation (about 2~10 minutes), at this time, the condensate water will be drained out from outdoor unit.
- During DEFROSTING operation, the fan motor of indoor unit will be in low fan speed or stop, the fan motor of outdoor unit will stop.

The working condition of the air conditioner

- In order to use the air conditioner correctly, please operate it in the following condition.

The operation range of the air conditioner

COOLING DEHUMIDIFYING	Indoor side	Maximum	D.B. 32*	W.B. 23*
		Minimum	D.B. 18*	W.B. 14*
	Outdoor side	Maximum	D.B. 43*	W.B. 26*
		Minimum	D.B. 18*	
HEATING	Indoor side	Maximum	D.B. 27*	
		Minimum	D.B. 15*	
	Outdoor side	Maximum	D.B. 24*	W.B. 18*
		Minimum	D.B. -7*	W.B. -8*

Note:

- * If the air conditioner operates out of this range for a long time, the protection device will act and at the same time the outdoor unit will give alarm.
- * In the working condition of simultaneous COOLING and HEATING, when the outdoor temperature $T1 \leq 28^{\circ}$, HEATING will not operate; when the outdoor temperature $T1 \leq 7^{\circ}$, COOLING will not operate.

When wrong action occurs during operation

During operation, because of the influence of thunder, automobile and wireless disturbance, the unit has wrong action, cut off the power switch, after powering on again, press 'ON/OFF' button, the unit can be turned on or off.

About the HEATING capacity

- HEATING operation adopts the heat pump type of absorbing the outdoor heat to release to indoor side, so if the outdoor temperature drops, the HEATING capacity may be lowered.
- When the outdoor temperature is low, the air conditioner can be used together with other heating devices.
- For details, please refer to the operation manual of indoor unit.



Troubleshooting

Trouble code display

Phenomenon of outdoor unit trouble	The flashing time of indicator light on outdoor control panel	Indoor control panel indication
The trouble of outdoor ambient temperature sensor	1 (A, B systems indicate together)	E3
The trouble of outdoor coil temperature sensor	2 (A and B system indicate individually)	E4
Over electric current protection	5 (A and B system indicate individually)	E5
CT wire breaks	6 (A and B system indicate individually)	E5
The communication trouble between indoor and outdoor unit	8 (A and B system indicate individually)	E8
Phenomenon of indoor unit trouble	Trouble indication on remote control type indoor unit	Trouble code on wire control type indoor unit
The trouble of indoor ambient temperature sensor	The compressor indicator light flashes 1 time in 0.2S/time frequency	E1
The trouble of indoor coil temperature sensor	The compressor indicator light flashes 2 time in 0.2S/time frequency	E2
The trouble of outdoor ambient temperature sensor	The compressor indicator light flashes 3 time in 0.2S/time frequency	E3
The trouble of outdoor coil temperature sensor	The compressor indicator light flashes 4 time in 0.2S/time frequency	E4
The trouble of electric current overload	The compressor indicator light flashes 5 time in 0.2S/time frequency	E5
The communication trouble between panel and indoor panel	The compressor indicator light flashes 8 time in 0.2S/time frequency	E8
The communication trouble between indoor panel and outdoor panel	The compressor indicator light flashes 9 time in 0.2S/time frequency	E9

Troubleshooting

Before contact the repair center, please check the following circumstances

	Symptom	Cause
Not trouble	* Blow out mist or water overflow	* The fan motor of outdoor unit automatically stop to perform defrosting.
	* Giving out noise	* During operation, in operation and shortly after unit stop, there is a sound of water flow; within 2~3 minutes after operation start, sometimes the sound becomes larger, this is the sound of refrigerant flowing and drainage of condensate water. * During operation, the air conditioner gives out the sound of ì Pu Chiî , it is because of the temperature change, the sound of heat exchangerís hot expansion and cold shrink.
	* Not get the needed COOLING or HEATING effect	* If set in ì HEATINGî , ì COOLINGî , ì FANî mode. * If the set temperature correct. * If the set fan speed is low.
Circumstances needing to further confirmation	* Auto operation, stop	* If set in ì TIMER ONî or ì TIMER OFFî mode.
	* Not operate 	* If because of power failure leading to unit stop. * If the power switch is cut off. (close the power switch) * If the fuse or breaker is burnt out. (please perform by the qualified electrician) * If the protection device acts. (the state of the operation indicator light of the wire controller) according to the instruction of the troubleshooting to check the cause.
	* Not get the needed COOLING or HEATING effect. 	* If the air outlet and inlet of the outdoor unit are blocked. (please cut off power, remove the obstacle) * If doors and windows are closed. (close doors and windows) * If there is too much dust on the indoor air filter. (please cut off power to clean the air filter) * If the position of the air outlet louver of the indoor unit is suitable. (adjust the position of the louver) * If exceeding the operation range of the air conditioner.

When the following circumstances occur, please stop the unit and cut off power, then contact the after-sales service center.

- * Bad action of button.
- * When fuse and breaker often blown out.
- * Alien articles and water enter into electric box.
- * Exclude the cause of protection device (refer to page 12), the unit still cannot operate.
- * Other abnormal circumstances.

Pipe system chart

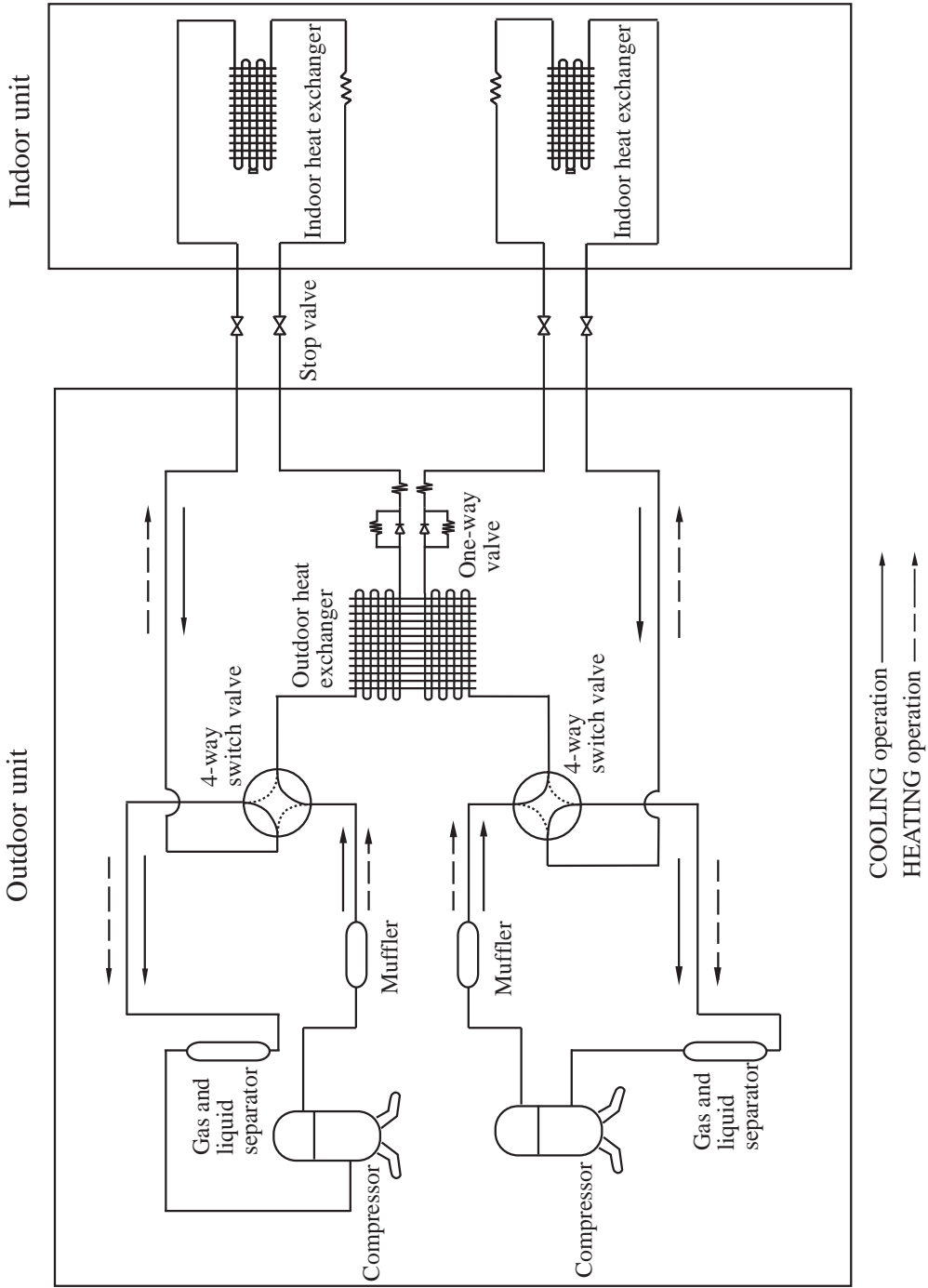

Note: The wiring diagram is pasted inside the unit.