

Haier

LCD TV
OWNER'S MANUAL

MODEL: LE24T1000F

Haier

Please READ this manual carefully
before operating your TV, and retain
it for future reference

The Haier logo consists of a solid grey square with the word "Haier" written in white, sans-serif font inside it.



Haier

Contents

1、 Safety and warnings.....	2-3
2、 Introduction.....	4
3、 Installation.....	5-8
4、 Remote Controller.....	9
5、 TV Operation.....	10-12
6、 Trouble shooting.....	13

IMPORTANT SAFETY INSTRUCTION

- 1) Read these instructions.
- 2) Keep these instructions.
- 3) Heed all warnings.
- 4) Follow all instructions.
- 5) Do not use this apparatus near water.
- 6) Clean only with dry cloth.
- 7) Do not block any ventilation openings, install in accordance with the instructions.
- 8) Do not install near any heat sources such as radiations, heat registers, stoves, or other apparatus (including amplifiers) that produce heat.
- 9) Do not defeat the safety purpose of the polarized plug. If the provided plug does not fit into your outlet, consult an electrician for replacement of the obsolete outlet.
- 10) Protected the power cord from being walked on or pinched particularly at plugs, convenience receptacles, and the point where they exit from the apparatus.
- 11) Only use attachments/accessories specified by the manufacturer.
- 12) Unplug this apparatus during lighting storms or when unused for long periods of time.
- 13) Refer all servicing to qualified service personnel. Servicing is required when the apparatus has been damaged in any way, such as power-supply cord or plug is damaged, liquid has been spilled or objects have fallen into the apparatus, the apparatus has been exposed to rain or moisture, does not operate normally, or has been dropped.
- 14) Mains plug is used as the disconnect device, the disconnect device shall remain readily operable.
- 15) The ventilation should not be impeded by covering the ventilation openings with items, such as newspapers, table-cloth, curtains, etc.
- 16) No naked flame sources, such as lighted candles, should be placed on the apparatus.
- 17) Attention should be drawn to the environmental aspects of battery disposal.
- 18) The use of apparatus in moderate climate.
- 19) The apparatus shall not be exposed to dripping or splashing and that no objects filled with liquids, such as vases, shall be placed on the apparatus.

	CAUTION RISK OF ELECTRIC SHOCK DO NOT OPEN!	
CAUTION TO REDUCE THE RISK OF ELECTRIC SHOCK, DO NOT REMOVE COVER (OR BACK). NO USER SERVICEABLE PARTS INSIDE. REFER SERVICING TO QUALIFIED SERVICE PERSONNEL.		

 The symbol indicates that dangerous voltages constituting a risk of electric shock are present within this unit.

 The symbol indicates that there are important operating and maintenance instructions in the literature accompanying this unit.

WARNING:

To reduce the risk of fire or electric shock, do not expose this apparatus to rain or moisture.

WARNING:

The batteries shall not be exposed to excessive heat such as sunshine, fire or the like.



This symbol indicates that this product incorporates double insulation between hazardous mains voltage and user accessible parts. When servicing use only identical replacement parts.



This marking indicates that this product should not be disposed with other household wastes throughout the EU. To prevent possible harm to the environment or human health from uncontrolled waste disposal, recycle it responsibly to promote the sustainable reuse of material resources. To return your used device, please use the return and collection systems or contact the retailer where the product was purchased. They can take this product for environmental safe recycling.

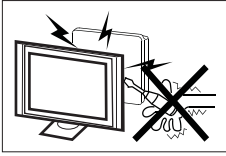

High voltages are used in the operation of this television receiver. Do not remove the cabinet back from your set. Refer servicing to qualified service personnel.

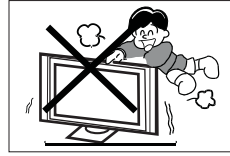

Never stand on, lean on, or suddenly push the television or its stand. You should pay special attention to children. Serious injury may result if it falls.

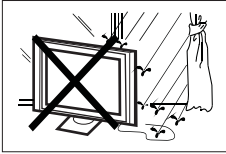

To prevent fire or electrical shock hazard, do not expose the television receiver to rain or moisture.

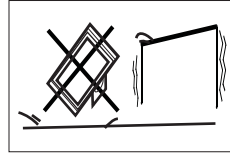

Do not place your television on an unstable cart, stand, shelf or table. Serious injury to an individual, and damage to the television, may result if it falls.

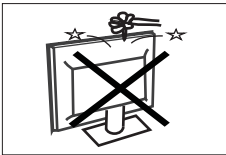

Do not drop or push objects into the television cabinet slots or openings. Never spill any kind of liquid on the television receiver.

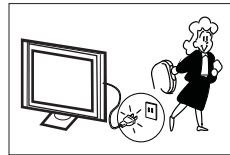

When the television receiver is not used for an extended period of time, it is advisable to disconnect the AC power cord from the AC outlet.

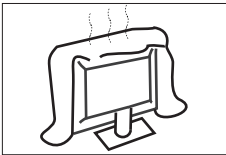

Do not block the ventilation holes in the back cover. Adequate ventilation is essential to prevent failure of electrical components.

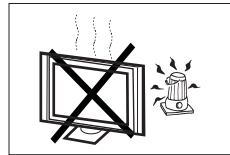

Avoid exposing the television receiver to direct sunlight and other sources of heat. Do not stand the television receiver directly on other products which give off heat, e.g. video cassette players and audio amplifiers. Do not place naked flame sources, such as lighted candles on the television.

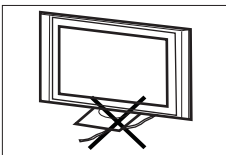

Do not trap the power supply cord under the television receiver.

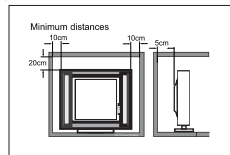

If the television is to be built into a compartment or similar enclosure, the minimum distances must be maintained. Heat build-up can reduce the service life of your television, and can also be dangerous.

Main features

- ① Used as Television, display terminal, PC display;
- ② High luminance, wide viewing angle;
- ③ Can store Air and Cable TV programs;
- ④ HDMI interface;
- ⑤ Multi-Media player (USB);

Accessories

Infrared Remote Controller.....	1
Battery(AAA).....	2
User's Manual.....	1
RF Extension Head	1

Main parameter

Viewing Picture Size (Diagonal)	24inch
Resolution	1920x1080
Aspect Ratio	16 : 9
TV System	PAL M, PAL N, NTSC
Video Signal System	PAL/NTSC/SECAM
Receiving Channel	Air 2-69 Cable 1-125
Input Power Voltage	AC 100-240V 50/60Hz
Power consumption	40W
Audio Output Power (THD≤7%)	2 x 3W
Signal Input	Analog RGB(VGA) x 1 High-Definition Multimedia Interface (HDMI) x 1 Composite Video Input x 1 Composite Video output x 1 Audio Input x 2 YCb (Pb)Cr (PR) x 1 USB x 1 RF x 1
Horizontal definition (TV line)	Composite Video input ≥350 Y Cb(Pb) Cr(Pr) ≥400

Front panel

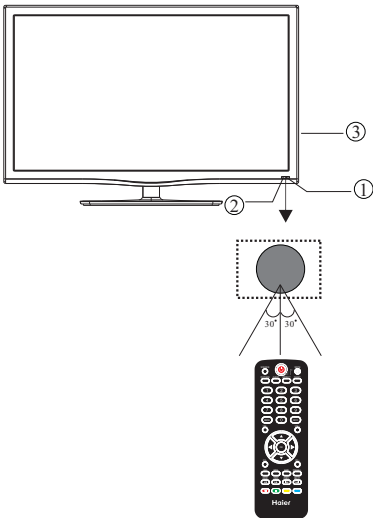

- 1: Remote control sensor.
- 2: Indicator LED: BLUE POWER ON.
RED STANDBY.
- 3: Key board

KEYBOARD

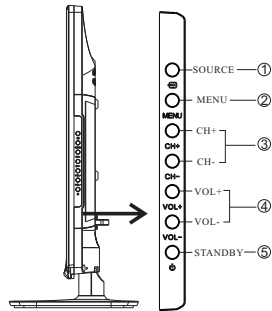

- 1. **SOURCE:**
Display the input source menu.
- 2. **MENU:**
Display main MENU.
- 3. **CH+/CH-**
In TV mode, press “CH+” or “CH-” to change the channel up and down.
In MENU mode, press “CH+” or “CH-” to select items.
- 4. **VOL+/VOL-**
Adjust sound level.
In MENU mode, press “VOL+” or “VOL-” to adjust the item that you selected.
- 5. **STANDBY**
Press this button to turn the unit ON from STANDBY mode.
Press it again to turn the set back to STANDBY.

REAR AV Connections

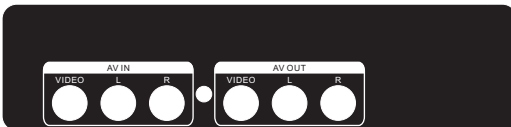

All the terminals are (from left to right):
VIDEO, AUDIO INPUT, AV OUTPUT.

Note: VIDEO and YPbPr share one audio channel.

REAR AV Connections (SIDE)

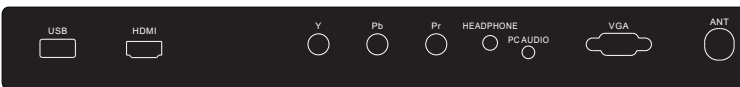

All the terminals are (from left to right):
USB, HDMI, YPbPr INPUT, HEADPHONE, PC AUDIO, VGA, RF.

Note: When HDMI port get DVI signal, the audio signal receives from the PC Audio channel.

ANTENNA

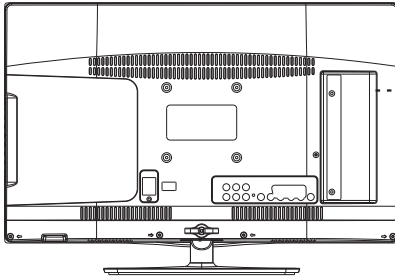

Note:
Aerial connections: IEC(female).
Input impedance: 75Ωunbalanced.

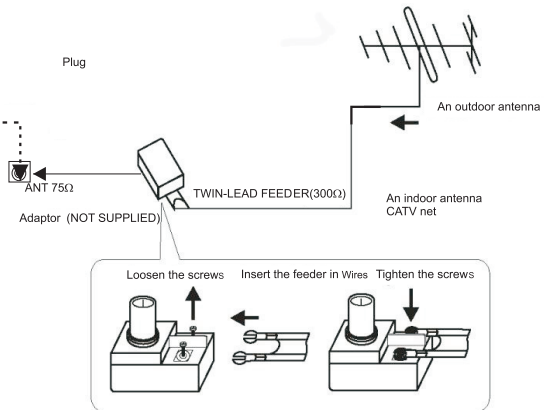

PC

STEPS:

Be sure both the TV and computer are Power off.

- 1.Connect VGA and audio cable
- 2.Connect power cord
- 3.Power on the TV, switch to PC mode
- 4.Power on the PC

This sequence is very important.

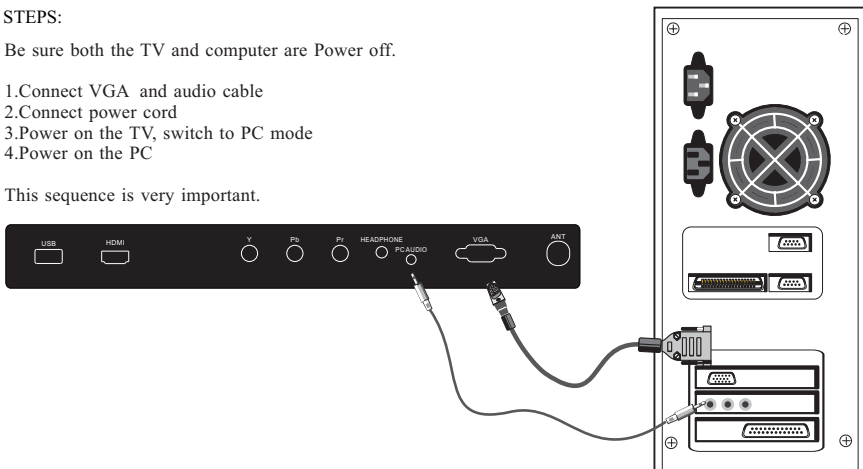

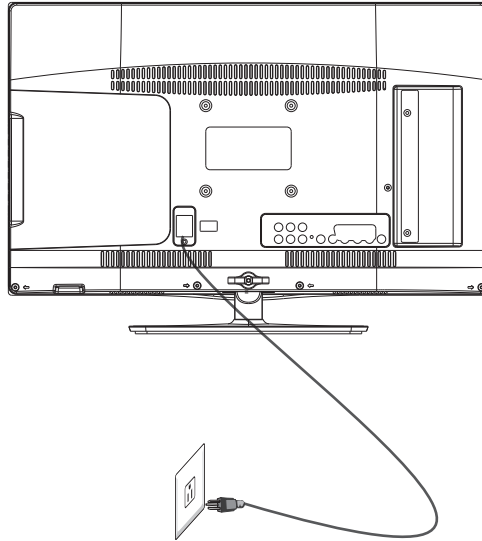

PRESET MODE (PC)

	RESOLUTION	V.Freq.(Hz)	H.Freq.(KHz)
1	800*600	60	37.88
2	1024*768	60	48.36
3	1280*768	60	47.3
4	1360*768	60	47.7
5	1920*1080	60	67.5

NOTE: PC V.Freq.(Hz) not more than 60Hz.

PRESET MODE (HDMI)

	RESOLUTION	V.Freq.(Hz)	H.Freq.(KHz)
1	800*600	60	37.88
2	1024*768	60	48.36
3	1360*768	60	47.7
4	1280*768	60	47.3
5	1920*1080	60	67.5

AV EQUIPMENT

This TV provides two group of AV, one group of YPbPr for convenient connection to VCR, DVD or other video equipment. Please refer to the owner's manual of the equipment to be connected as well.

You can use the input terminals on TV set rear as follows.

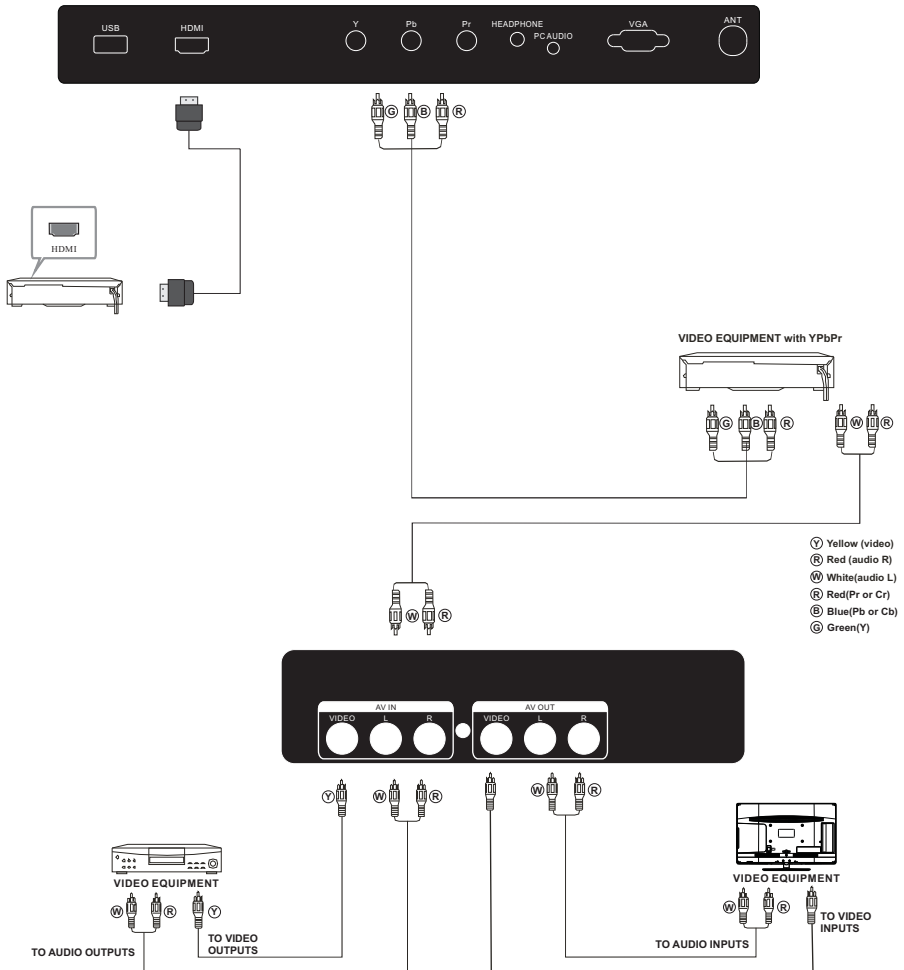

It can be connected to the following appliances: VCR, multi disc player, DVD, camcorder, video game or stereo system, etc... YPbPr can support these video fomats: 480i, 576i, 480p, 576p, 720p, 1080i, 1080p.

Note: 1. AV and YPbPr share one audio channel.

2. When HDMI port get DVI signal, the "PC Audio" channel is changed to receive the audio for HDMI port.

3. Sometimes it will not support in different device because the device suppls nonstandard signal.

4. When current source is TV, AV OUT signal is TV; when current source is AV, AV OUT signal is AV; other sources have no AV OUT signal.

The remote control cannot be operated unless the batteries are properly loaded inserted.
When using the remote control, aim it at the remote control sensor on the TV.

Function introduction

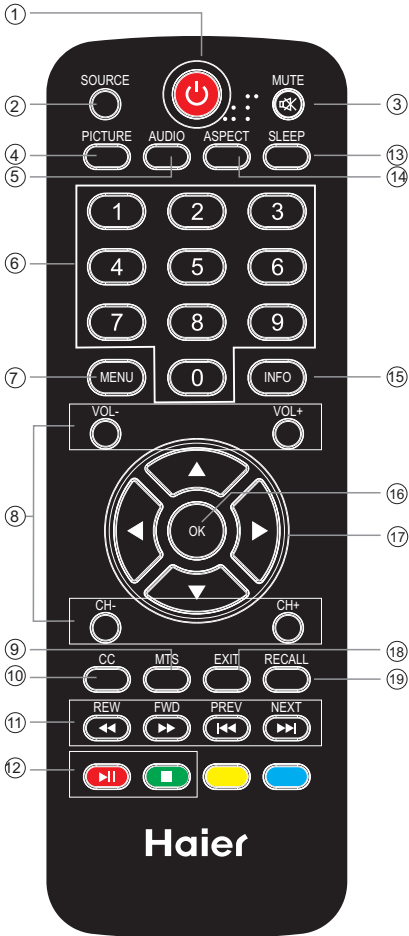

1. Press to turn on and off the TV.
2. SOURCE: To select input source.
3. Switches the TV sound on or off.
4. Press repeatedly to cycle through the available picture modes.
5. Press to cycle through the different sound mode settings
6. Press to change a channel.
7. Press to open the on-screen menu
- 8: Press CH+ or CH- to go to the next or previous channel, Press VOL+ or VOL- to increase or decrease the volume.
9. Press to activate the NTSC TV sounds, such as Stereo SAP or Monotone
10. Press to turn on or off the closed captions.
11. ◀◀ Rewind ▶▶ Forward ◀◀ Previous ▶▶ Next in USB mode
12. ▶|| Play/Pause ■ Stop
13. Press to display the sleep timer option.
14. To change the picture aspect ratio: Auto/4:3/16:9/ Zoom/Zoom2.
15. Press to display the TV status information on the bottom.
16. Press to confirm selections in an on-screen menu or to open a submenu.
17. To move within the menu.
18. Exit On Screen Display.
19. Press to go to the last viewed channel.

1. CHANNEL MENU

The first item of the MENU is channel menu (for TV source only).

You can search channels and edit programs here. Press ▼▲ to move, press OK button to confirm, and press ◀▶ to adjust.



1).Auto tuning:

Search all the TV channels automatically.

2). Antenna

There are air and cable, you can changed.

3). Skip

Press OK button to skip cunent channel.

4). MTS mode

Press OK button to choose the MTS mode.

5). Software update(USB):

Update the TV set a software by USB.

2. PICTURE MENU

The second item of the MENU is PICTURE MENU. You can adjust picture effect here, such as contrast, brightness, etc.

Press ▼▲ to move, press OK button to confirm, and press ◀▶ to adjust.

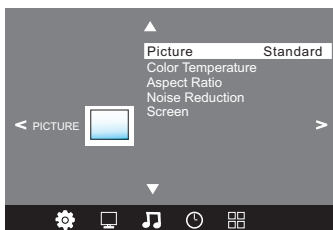

NOTE:

- 1).Tint is available in NTSC system only.
- 2).There are four color temperature modes can be selected, such as medium, warm, cool, and user.
- 3).Screen is available in PC mode only, which can adjust horizontal position, vertical position, size and phase.

3. SOUND MENU

The third item of the MENU is the SOUND MENU.

You can adjust the sound effect here such as treble, bass, balance etc.

Press ▼▲ to move, press OK button to confirm, and press ◀▶ to adjust.

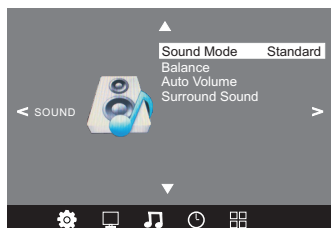

Note:

Auto volume: only available when the input signal volume is too large or distortion.

4. TIME MENU

The forth item of the menu is the TIME MENU. You can adjust the clock, power on/off time, sleep time etc.

Press ▼▲ to move, press OK button to confirm, and press ◀▶ to adjust.

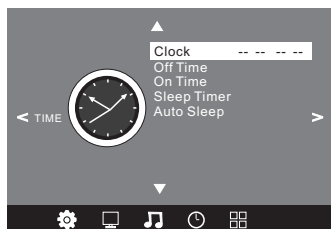

NOTE:

Within 15 minutes there is no signal, the TV will auto sleep. Once you power off the TV set by AC, the clock time will be reset.

5.OPTION MENU

The fifth item of the MENU is the OPTION MENU.

You can adjust the OSD language or Restore factory default, or Caption or Blue Screen.

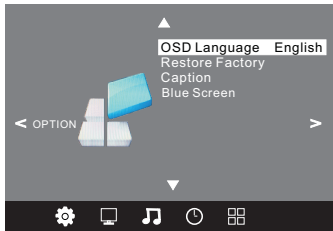

NOTE:
Restore factory default will clear all the programs and Reset all the settings to default value.

6. USB MENU

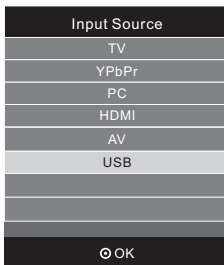

Press OK button to enter the USB menu.



Please make sure that the USB device have plugged in the slot. There are four type media item can be selected, such as photo, music, Movie, and text. Select the type media item by pressing ◀ ▶, press OK button to enter the disk selection menu.

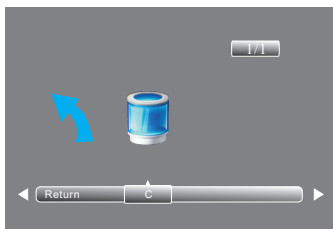

Press the ◀ ▶ to select the right disk and press OK to display media files and folder list or choose Return to back to the media type selection menu.

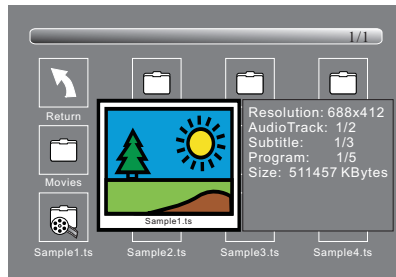

Select the media file by pressing ◀ ▶ or ▼ ▲, then the preview frame will pop up. Press the button ▶▶ to play the media file in full screen. When the media file (photo, music, Movie, or text type) is playing, press the OK or Info button can display the control bar.



Press ◀ ▶ to select the function icon, press OK button to confirm the function.

Press ▼ or EXIT button to exit the control bar.

NOTE:

You can adjust the audio track, subtitle, or program in the Info menu while Playing the video file.

Choose the Info icon and press OK can display the Info MENU.

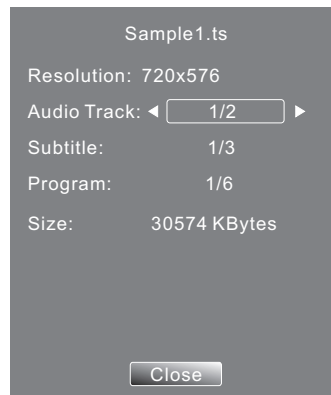

Hotel Mode:

Please press source key first, and then press number key “1001” to enter into Hotel Mode.

Hotel Mode Operation	
Hotel Mode Operation	OFF
Panel key lock	OFF
Max volume	100
Start Source	TV
Start Channel	1
Setup Menu display	Yes
Input source change	Yes
Save To USB	
Load	
Volume default	0

Hotel Mode Operation : Set Hotel mode on/off.

Panel key lock : Keypad will be locked, when Key Lock mode is on.

Max volume: Set max volume limited. This option allows you to set the Max Volume Level.

Start Source: Choose source, the options as follow: TV/YPbPr/PC/HDMI/AV/USB, press the ◀ or ▶ button to select the desired source.

Start Channel : In TV mode, you can select a channel number to be set as the TV present channel. Press the ◀ or ▶ button to select the desired channel number .















Setup Menu display : Main menu lock , main menu will not display when set to “No”

Input source change : Source lock, you can't change the source, when set to “No”

Save To USB: Backup all TV setting data to USB disk. (backup file named DATABASE.bin)

Load: Restore this data to TV from USB disk. When restore is executed, the TV will reboot.

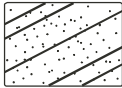
Volume default : Power on default volume, press the ◀ or ▶ button to select the desired volume.

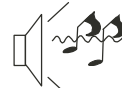
Trouble phenomenon		Inspection
Picture	Audio	
 <p>Snow</p>	 <p>Noise</p>	antenna position, direction or connection
 <p>Ghost</p>	 <p>Normal audio</p>	antenna position, direction or connection
 <p>Interfere</p>	 <p>Noise</p>	electronic equipment, car/ motorcycle, fluorescent light
 <p>Normal Picture</p>	 <p>Mute</p>	Volume(inspect wether the mute function on the remote control are started , or audio system are correct or not)
 <p>No picture</p>	 <p>Mute</p>	Power cord is not inserted Power switch is not opened Contrast and brightness/volume setup Press standby key on the remote control for inspecting
 <p>No color</p>	 <p>Normal audio</p>	color control
 <p>Scramble</p>	 <p>Normal audio or weak</p>	retune channel
 <p>No color</p>	 <p>Noise</p>	Audio system

Special Explanation: The accessories such as remote control is not belongs to the guarantee.

Haier