

**HIKVISION**

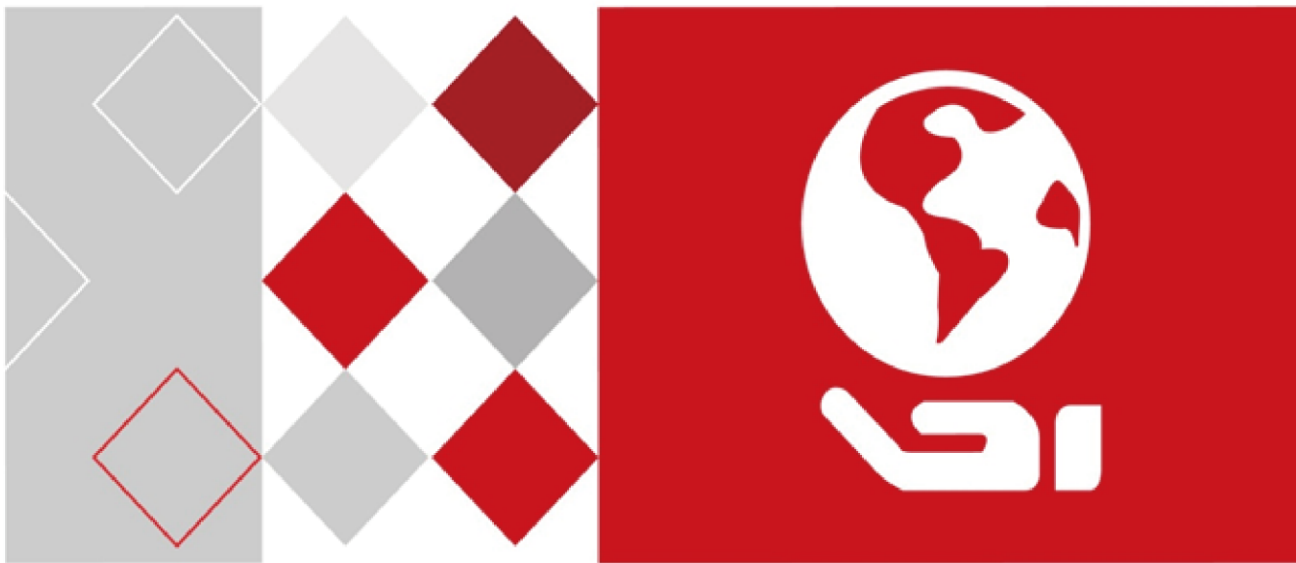

Mobile DVR

User Manual

# TABLE OF CONTENTS

<b>Chapter 1 Panel Introduction.....</b>	<b>9</b>
1.1 Front Panel .....	9
1.2 Rear Panel .....	10
<b>Chapter 2 Installation and Connections .....</b>	<b>12</b>
2.1 Install HDD .....	12
2.2 Install SIM Card .....	14
2.3 Install SD Card .....	16
2.4 Alarm Input/Output Connection .....	17
2.4.1 Alarm Input Connection .....	17
2.4.2 Alarm Output Connection .....	17
2.5 Sensor-in Wiring .....	17
2.6 Power Cord Wiring .....	17
2.6.1 Shutdown Delay .....	17
2.6.2 Timed Shutdown .....	19
<b>Chapter 3 Start Up Device .....</b>	<b>20</b>
3.1 Startup .....	20
3.2 Activation .....	20
<b>Chapter 4 Network.....</b>	<b>22</b>
4.1 Set Local Network .....	22
4.2 Connect Wireless Network .....	22
4.2.1 3G/4G Dialing .....	22
4.2.2 Set Wi-Fi .....	23
4.2.3 Set Wi-Fi AP .....	25
4.3 Firewall Settings .....	26
<b>Chapter 5 IP Camera .....</b>	<b>28</b>
5.1 Activate IP Cameras .....	28
5.2 Add IP Cameras .....	29
5.2.1 Quick Add .....	29
5.2.2 Add IP Camera Manually .....	30
5.2.3 Edit Protocol .....	30
5.3 Edit IP Cameras .....	31
5.4 Delet IP Cameras .....	31
<b>Chapter 6 Camera Management.....</b>	<b>33</b>
6.1 Basic Image Settings .....	33
6.1.1 Set OSD Parameters .....	33
6.1.2 Set Image Parameters .....	33
6.1.3 Set TVI Camera .....	34
6.2 Set Privacy Mask .....	35
6.3 Set Mirror Type .....	36
<b>Chapter 7 Live View .....</b>	<b>38</b>
7.1 Preview Settings .....	38
7.2 Set Camera Order .....	38

7.3 Right-Click Menu .....	39
7.4 PTZ Operation .....	40
7.4.1 Configure PTZ Settings .....	40
7.4.2 PTZ Control Panel .....	41
<b>Chapter 8 Storage .....</b>	<b>42</b>
8.1 Storage Settings .....	42
8.1.1 Format HDD .....	42
8.1.2 Configure Overwrite .....	42
8.1.3 View S.M.A.R.T. Information .....	43
8.2 Recording Settings .....	44
8.2.1 Configure Record Settings .....	44
8.2.2 Configure Motion Detection Recording .....	45
8.2.3 Configure Alarm Triggered Recording .....	46
8.2.4 Configure Alarm Terminal .....	46
8.2.5 Configure Schedule .....	47
8.3 Sensor-in Settings .....	48
<b>Chapter 9 Playback .....</b>	<b>49</b>
9.1 Instant Playback .....	49
9.2 Play Video by File .....	49
<b>Chapter 10 Platform .....</b>	<b>51</b>
10.1 Ehome .....	51
10.2 Guarding Vision .....	51
10.3 Register Device in Guarding Vision platform .....	52
<b>Chapter 11 Backup .....</b>	<b>53</b>
11.1 Manual Backup .....	53
11.2 Format Backup Device .....	54
<b>Chapter 12 Events and Alarms .....</b>	<b>55</b>
12.1 Configure Motion Detection Alarm .....	55
12.2 Configure Alarm Input .....	55
12.3 Configure Alarm Output .....	56
12.4 Configure Alarm Terminal .....	57
12.5 Configure Video Loss Alarm .....	58
12.6 Configure Video Tampering Alarm .....	58
12.7 Configure Video Quality Diagnostics .....	59
12.8 Configure Exception Alarm .....	60
12.9 Configure Satellite Positioning .....	60
12.10 Configure G-Sensor Alarm .....	61
12.11 Configure Arming Schedule and Linkage Actions .....	62
12.12 Configure Detection Area .....	63
<b>Chapter 13 User Account Management .....</b>	<b>64</b>
13.1 Add User .....	64
13.2 Delete User .....	65
13.3 Edit User .....	65
<b>Chapter 14 General System Configuration .....</b>	<b>66</b>

14.1 Configure Basic Display Settings .....	66
14.2 Configure DST Settings.....	66
14.3 Configure NTP .....	67
14.4 Configure Advanced Display Settings.....	68
<b>Chapter 15 Maintenance.....</b>	<b>70</b>
15.1 Check Status .....	70
15.2 View System Information .....	70
15.3 Upgrade the System.....	70
15.3.1 Upgrade by Local USB Flash Disk.....	71
15.3.2 Upgrade by Remote FTP server.....	71
15.4 Log Operation.....	72
15.4.1 View Log Files.....	72
15.4.2 Export Log Files .....	73
15.5 Restoring Default Settings.....	73
15.6 Import/Export Configuration Files .....	74
15.6.1 Import Configuration Files .....	74
15.6.2 Export Configuration Files .....	75
15.7 Serial Port Settings .....	75
<b>Chapter 16 Shut Down Device.....</b>	<b>77</b>
16.1 Enable Scheduled Startup/Shutdown .....	77
16.2 Enable Halt Delay .....	77
16.3 Reboot DVR.....	78
<b>Chapter 17 Appendix .....</b>	<b>0</b>
17.1 Glossary.....	0
17.2 FAQ.....	1
17.3 Remote Control .....	2
17.3.1 Buttons Description .....	2
17.3.2 Operation Introduction .....	4
17.3.3 Troubleshooting.....	5
17.3.4 Set Areas with Remote Control .....	6

## **User Manual**

COPYRIGHT ©2017 Hangzhou Hikvision Digital Technology Co., Ltd.

### **ALL RIGHTS RESERVED.**

Any and all information, including, among others, wordings, pictures, graphs are the properties of Hangzhou Hikvision Digital Technology Co., Ltd. or its subsidiaries (hereinafter referred to be “Hikvision”). This user manual (hereinafter referred to be “the Manual”) cannot be reproduced, changed, translated, or distributed, partially or wholly, by any means, without the prior written permission of Hikvision. Unless otherwise stipulated, Hikvision does not make any warranties, guarantees or representations, express or implied, regarding to the Manual.

### **About this Manual**

This Manual is applicable to Mobile Digital Video Recorder (MDVR).

The Manual includes instructions for using and managing the product. Pictures, charts, images and all other information hereinafter are for description and explanation only. The information contained in the Manual is subject to change, without notice, due to firmware updates or other reasons. Please find the latest version in the company website (<http://overseas.hikvision.com/en/>).

Please use this user manual under the guidance of professionals.

### **Trademarks Acknowledgement**

**HIKVISION** and other Hikvision’s trademarks and logos are the properties of Hikvision in various jurisdictions. Other trademarks and logos mentioned below are the properties of their respective owners.

### **Legal Disclaimer**

TO THE MAXIMUM EXTENT PERMITTED BY APPLICABLE LAW, THE PRODUCT DESCRIBED, WITH ITS HARDWARE, SOFTWARE AND FIRMWARE, IS PROVIDED “AS IS”, WITH ALL FAULTS AND ERRORS, AND HIKVISION MAKES NO WARRANTIES, EXPRESS OR IMPLIED, INCLUDING WITHOUT LIMITATION, MERCHANTABILITY, SATISFACTORY QUALITY, FITNESS FOR A PARTICULAR PURPOSE, AND NON-INFRINGEMENT OF THIRD PARTY. IN NO EVENT WILL HIKVISION, ITS DIRECTORS, OFFICERS, EMPLOYEES, OR AGENTS BE LIABLE TO YOU FOR ANY SPECIAL, CONSEQUENTIAL, INCIDENTAL, OR INDIRECT DAMAGES, INCLUDING, AMONG OTHERS, DAMAGES FOR LOSS OF BUSINESS PROFITS, BUSINESS INTERRUPTION, OR LOSS OF DATA OR DOCUMENTATION, IN CONNECTION WITH THE USE OF THIS PRODUCT, EVEN IF HIKVISION HAS BEEN ADVISED OF THE POSSIBILITY OF SUCH DAMAGES.

REGARDING TO THE PRODUCT WITH INTERNET ACCESS, THE USE OF PRODUCT SHALL BE WHOLLY AT YOUR OWN RISKS. HIKVISION SHALL NOT TAKE ANY RESPONSIBILITIES FOR ABNORMAL OPERATION, PRIVACY LEAKAGE OR OTHER DAMAGES RESULTING FROM CYBER ATTACK, HACKER ATTACK, VIRUS INSPECTION, OR OTHER INTERNET SECURITY RISKS; HOWEVER, HIKVISION WILL PROVIDE TIMELY TECHNICAL SUPPORT IF REQUIRED.

SURVEILLANCE LAWS VARY BY JURISDICTION. PLEASE CHECK ALL RELEVANT LAWS IN YOUR JURISDICTION BEFORE USING THIS PRODUCT IN ORDER TO ENSURE THAT YOUR USE CONFORMS THE APPLICABLE LAW. HIKVISION SHALL NOT BE LIABLE IN THE EVENT THAT THIS PRODUCT IS USED WITH ILLEGITIMATE PURPOSES.

IN THE EVENT OF ANY CONFLICTS BETWEEN THIS MANUAL AND THE APPLICABLE LAW, THE LATER PREVAILS.

## Regulatory Information

### FCC Information

Please take attention that changes or modification not expressly approved by the party responsible for compliance could void the user's authority to operate the equipment.

**FCC compliance:** This equipment has been tested and found to comply with the limits for a Class A digital device, pursuant to part 15 of the FCC Rules. These limits are designed to provide reasonable protection against harmful interference when the equipment is operated in a commercial environment. This equipment generates, uses, and can radiate radio frequency energy and, if not installed and used in accordance with the instruction manual, may cause harmful interference to radio communications. Operation of this equipment in a residential area is likely to cause harmful interference in which case the user will be required to correct the interference at his own expense.

### FCC Conditions

This device complies with Part 15 of the FCC Rules. Operation is subject to the following two conditions:

- (1) This device may not cause harmful interference, and
- (2) This device must accept any interference received, including interference that may cause undesired operation.

Attention that changes or modification not expressly approved by the party responsible for compliance could void the user's authority to operate the equipment.

Note: This product has been tested and found to comply with the limits for a Class B digital device, pursuant to Part 15 of the FCC Rules. These limits are designed to provide reasonable protection against harmful interference in a residential installation. This product generates, uses, and can radiate radio frequency energy and, if not installed and used in accordance with the instructions, may cause harmful interference to radio communications. However, there is no guarantee that interference will not occur in a particular installation. If this product does cause harmful interference to radio or television reception, which can be determined by turning the equipment off and on, the user is encouraged to try to correct the interference by one or more of the following measures:

- Reorient or relocate the receiving antenna.
- Increase the separation between the equipment and receiver.
- Connect the equipment into an outlet on a circuit different from that to which the receiver is connected.
- Consult the dealer or an experienced radio/TV technician for help.

This equipment should be installed and operated with a minimum distance 20cm between the radiator and your body

### EU Conformity Statement



This product and - if applicable - the supplied accessories too are marked with "CE" and comply therefore with the applicable harmonized European standards listed under the EMC Directive 2014/30/EU, the LVD Directive 2014/35/EU, the RoHS Directive 2011/65/EU.



2012/19/EU (WEEE directive): Products marked with this symbol cannot be disposed of as unsorted municipal waste in the European Union. For proper recycling, return this product to your local supplier upon the purchase of equivalent new equipment, or dispose of it at designated collection points. For more information see: [www.recyclethis.info](http://www.recyclethis.info)



2006/66/EC (battery directive): This product contains a battery that cannot be disposed of as unsorted municipal waste in the European Union. See the product documentation for specific battery information. The battery is marked with this symbol, which may include lettering to indicate cadmium (Cd), lead (Pb), or mercury (Hg). For proper recycling, return the battery to your supplier or to a designated collection point. For more information see: [www.recyclethis.info](http://www.recyclethis.info)

**Industry Canada ICES-003 Compliance**

This device meets the CAN ICES-3 (A)/NMB-3(A) standards requirements.



## Applicable Models

This manual is applicable to the models listed in the following table.

Series	Model
DS-M5504HM-T	DS-M5504HM-T(1T)
	DS- M5504HM-T/GW(1T)
	DS- M5504HM-T/GW/WI58(1T)

## Symbol Conventions

The symbols that may be found in this document are defined as follows.

Symbol	Description
 <b>NOTE</b>	Provides additional information to emphasize or supplement important points of the main text.
 <b>WARNING</b>	Indicates a potentially hazardous situation, which if not avoided, could result in equipment damage, data loss, performance degradation, or unexpected results.
 <b>DANGER</b>	Indicates a hazard with a high level of risk, which if not avoided, will result in death or serious injury.



## Safety Instructions

- Proper configuration of all passwords and other security settings is the responsibility of the installer and/or end-user.
- In the use of the product, you must be in strict compliance with the electrical safety regulations of the nation and region. Please refer to technical specifications for detailed information.
- Input voltage should meet both the SELV (Safety Extra Low Voltage) and the Limited Power Source with 9 to 32 VDC according to the IEC60950-1 standard. Please refer to technical specifications for detailed information.
- Do not connect several devices to one power adapter as adapter overload may cause over-heating or a fire hazard.
- Please make sure that the plug is firmly connected to the power socket.
- If smoke, odor or noise rise from the device, turn off the power at once and unplug the power cable, and then please contact the service center.

## Preventive and Cautionary Tips

Before connecting and operating your device, please be advised of the following tips:

- Ensure unit is installed in a well-ventilated, dust-free environment.
- Keep all liquids away from the device.
- Ensure environmental conditions meet factory specifications.
- Ensure unit is properly secured to a rack or shelf. Major shocks or jolts to the unit as a result of dropping it may cause damage to the sensitive electronics within the unit.
- Use the device in conjunction with an UPS if possible.
- Power down the unit before connecting and disconnecting accessories and peripherals.
- A factory recommended HDD should be used for this device.
- Improper use or replacement of the battery may result in hazard of explosion. Replace with the same or equivalent type only. Dispose of used batteries according to the instructions provided by the battery manufacturer.

# Chapter 1 Panel Introduction

## 1.1 Front Panel

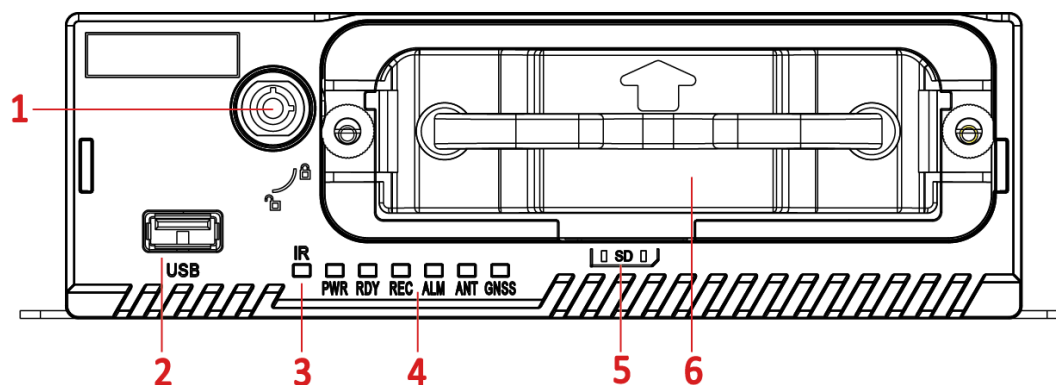

Figure 1-1 Front Panel

Table 1-1 Interface Description

No.	Name	Description
1	Dummy HDD lock	Lock/Unlock the dummy HDD.
2	USB interface	USB 2.0 interface.
3	IR receiver	IR receiver for remote control.
4	PWR	Power indicator <ul style="list-style-type: none"> <li>● Solid green: Device is powered on.</li> <li>● Solid red: Device is standby.</li> </ul>
	RDY	Ready indicator Solid green: Device starts up normally.
	REC	Recording indicator Solid green: Device is recording normally.
	GNSS	GNSS indicator <ul style="list-style-type: none"> <li>● Unlit: Positioning module is abnormal.</li> <li>● Solid green: Device is positioning.</li> <li>● Flashing green: Positioning succeeded.</li> </ul>
	ANT	ANT indicator <ul style="list-style-type: none"> <li>● Unlit: Dialing module is abnormal.</li> <li>● Solid green: Device is dialing.</li> </ul>

		● Flashing green: Dialing up succeeded.
	ALM	Alarm indicator Red: Alarm occurs.
5	SD card slot	Slot for SD card.
6	Dummy HDD	Two HDDs can be installed.

## 1.2 Rear Panel

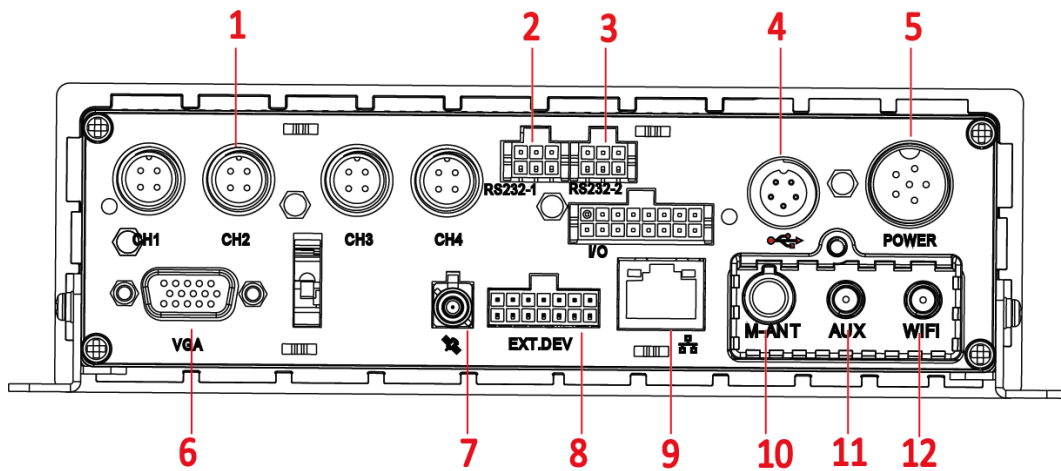

Figure 1-2 Rear Panel

Table 1-2 Interface Description

No.	Name	Description
1	CH1 to CH4	4 video inputs.
2	RS-232-1	For debugging.
3	RS-232-2	For connecting external devices.
4	USB interface	USB interface of 5-pin aviation plug.
5	Power	6-pin aviation plug for power supply.
6	VGA	VGA video output interface.
7	GNSS antenna	GNSS antenna interface.
8	EXT.DEV	RS-422 communication interface, two-way audio interface, and CVBS video output.
9	Network interface	10M/100M RJ45 Ethernet interface.
10	M-ANT	Main antenna interface of 3G/4G dialing.

11	AUX	Auxiliary Wi-Fi antenna interface.
12	Wi-Fi antenna	Wi-Fi antenna interface.

## Chapter 2 Installation and Connections



Product pictures in following chapters are for reference only. In the event of any conflicts between this manual and the product, the later prevails.

### 2.1 Install HDD

#### **Before You Start:**

Prepare the tools and components for installation:

- One factory recommended 2.5-inch HDD.
- Antistatic gloves
- Key to dummy HDD (delivered with device)
- Cross screwdriver
- Screws (delivered with device)

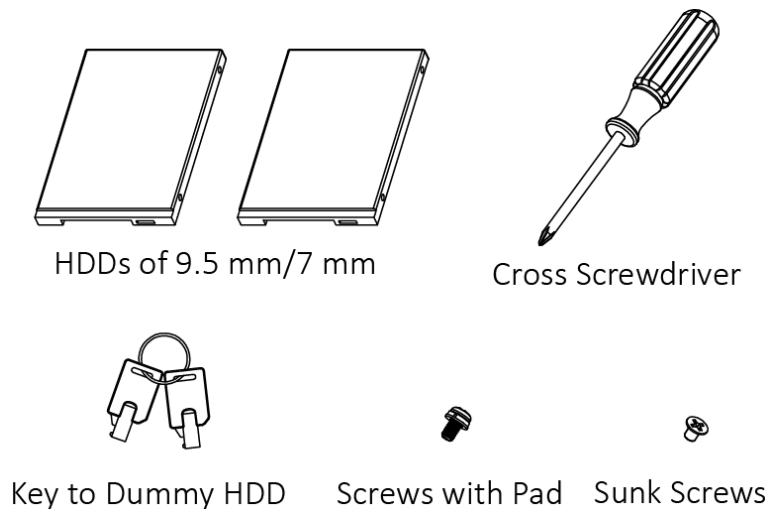

Figure 2-1 Tools

#### **Purpose:**

Perform the following steps to install the HDD on the device.

Step 1 Insert the key and turn counterclockwise to unlock dummy HDD.

Step 2 Unfasten the two screws of dummy HDD and pull dummy HDD out of device.

Step 3 Use cross screwdriver to loosen the two screws and remove them, and then take the dummy HDD apart.

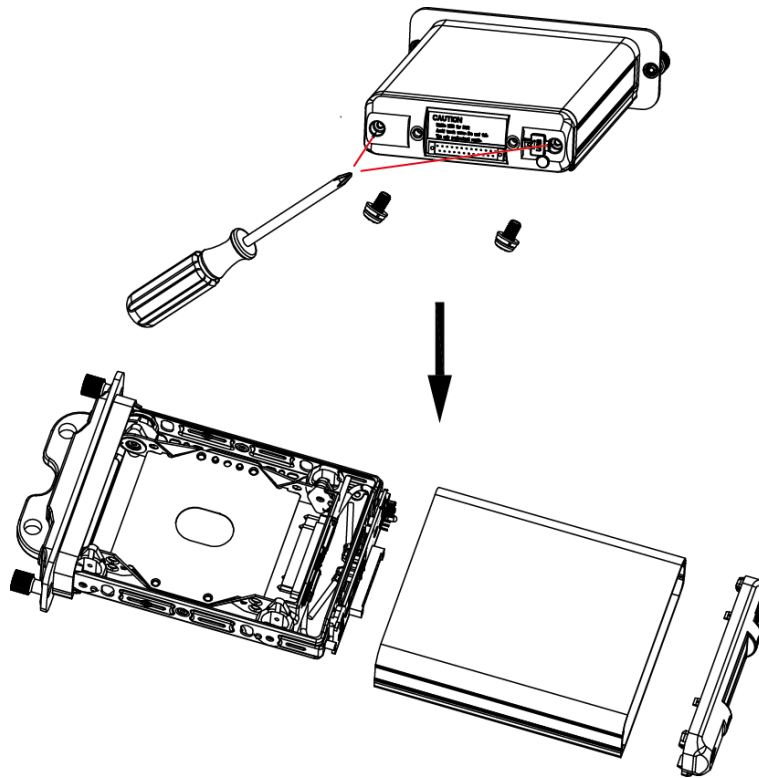

Figure 2-2 Take Apart Dummy HDD

Step 4 Place HDD into the dummy HDD, with the PCB facing down.

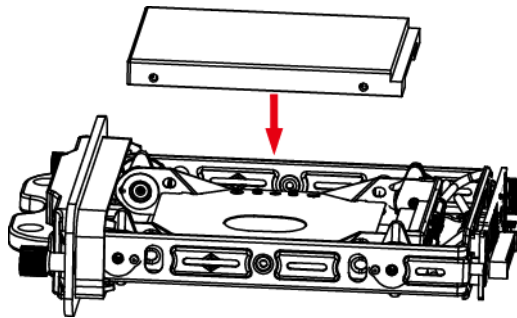

Figure 2-3 Place HDD

Step 5 Push the HDD along the direction shown in Figure 2-4 to connect HDD with socket of dummy HDD.

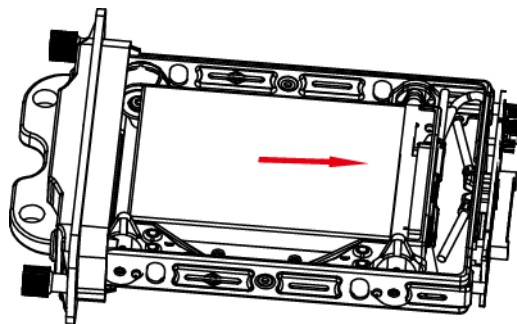

Figure 2-4 Push HDD

Step 6 Use four sunk screws to fix HDD with dummy HDD.

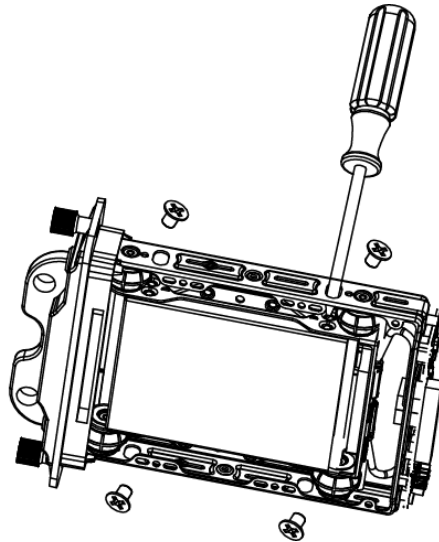

Figure 2-5 Fix HDD

Step 7 Reassemble the dummy HDD.

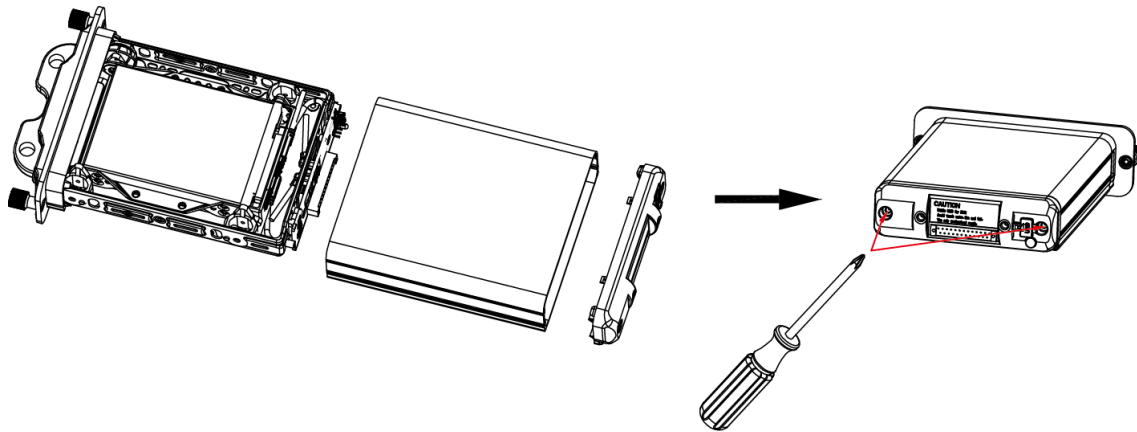

Figure 2-6 Reassemble Dummy HDD

Step 8 Plug the dummy HDD back to the device and then tighten the screws clockwise.

Step 9 Turn the key clockwise to lock dummy HDD.

## 2.2 Install SIM Card

### **Purpose:**

Pluggable 3G/4G wireless communication module is designed for the device and you should install the SIM card to realize the wireless communication function.

### **Before You Start**

Prepare the tools and components for installation:

- SIM card
- Wrench

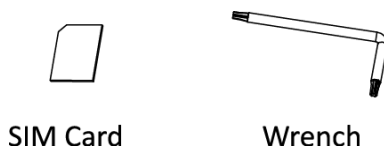

Figure 2-7 Tools

Step 1 Use wrench to unfasten and remove the two screws fixing the 3G/4G and Wi-Fi module.

Step 2 Pull out the 3G/4G and Wi-Fi module.

Step 3 Press the yellow button on the 3G/4G slot and then pull the SIM card tray out.

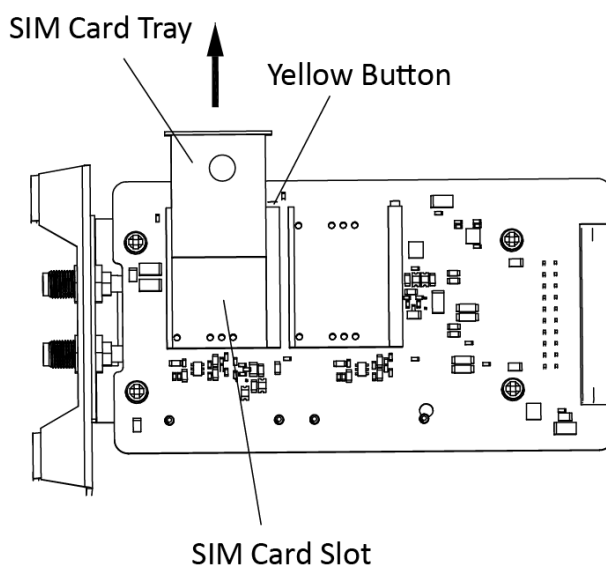

Figure 2-8 Pull out SIM Card Tray

Step 4 Place the SIM card on SIM card tray.

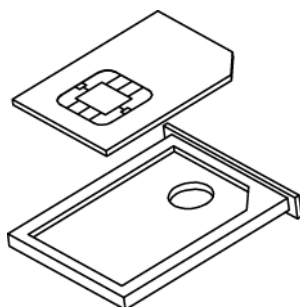

Figure 2-9 Place SIM card on SIM Card Tray

Step 5 Insert the SIM card tray back to SIM card slot.



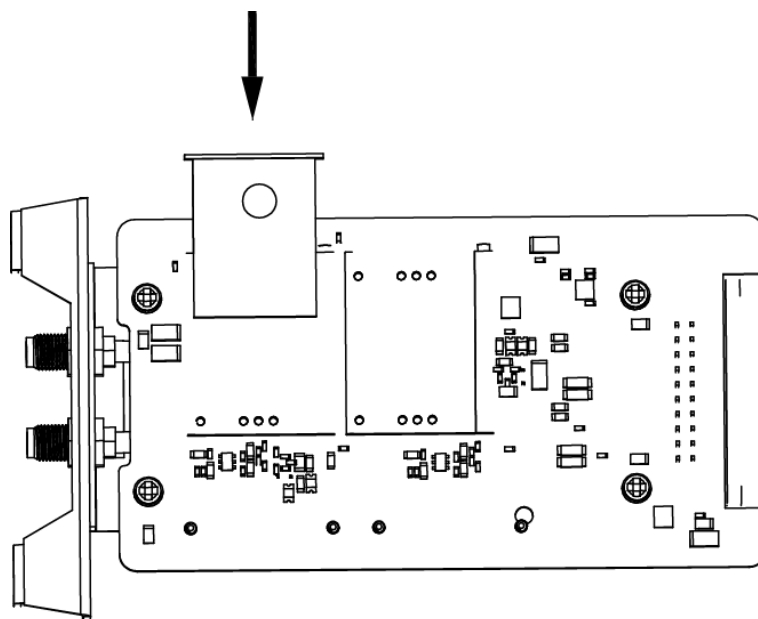

Figure 2-10 Insert SIM Card Tray back to SIM Card Slot

Step 6 Install the 3G/4G module back to the device and tighten the set screw.

## 2.3 Install SD Card

### ***Before You Start***

Prepare the tools and components for installation:

- Key to dummy HDD (delivered with device)
- SD card

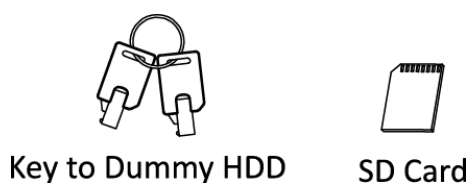

Figure 2-11 Tools

Step 1 Insert the key and turn counterclockwise to unlock dummy HDD.

Step 2 Unfasten the two screws of dummy HDD and pull dummy HDD out of device.

Step 3 Open the cover of SD card slot.

Step 4 Insert SD card into SD card slot with gold contacts facing down till you hear a click.

Step 5 Plug the dummy HDD back to the device, close the cover of SD card slot, and then tighten the screws clockwise.

Step 6 Turn the key clockwise to lock dummy HDD.

## 2.4 Alarm Input/Output Connection

### 2.4.1 Alarm Input Connection

The device adopts the high/low-level electrical signals triggering (high level: 6 to 36 VDC; low level: 0 to 5 VDC) to realize alarm input. And in order to avoid error report caused by voltage fluctuation, no alarm will be triggered by voltage ranging of 5 to 6VDC.

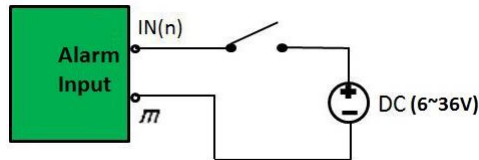

Figure 2-12 Alarm Input Connection

### 2.4.2 Alarm Output Connection

The alarm output interfaces A1 and B1 of the mobile DVR is opened normally if no alarm occurs. When an alarm output is triggered, the corresponding A1 and B1 interfaces will be connected. Thus, the active alarm device is required for the system.

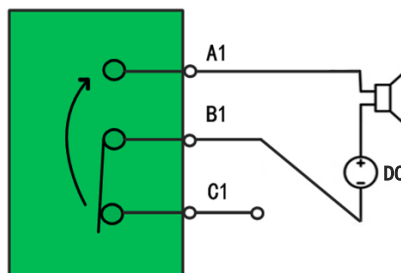

Figure 2-13 Alarm Output Connection

## 2.5 Sensor-in Wiring

Step 1 Connect the delivered extension cable to I/O interface.

Step 2 Connect the vehicle braking, reversing, left-turn, and right-turn signals to sensor-in interface.

## 2.6 Power Cord Wiring

### 2.6.1 Shutdown Delay

**Purpose:**

The device starts up when the vehicle ignites and shuts down after the vehicle is off. The vehicle ignition startup and shutdown are realized by the vehicle positive pole ignition switch (providing high level signal when the switch closes). The wire connection of the device varies with the vehicle ignition models.

 NOTE

- Please contact the vehicle manufacturer for the connection information of starting switch.
- The vehicle ignition switch, also called car key, controls the startup and shutdown of the vehicle. Most of vehicles adopt positive pole ignition switch currently.

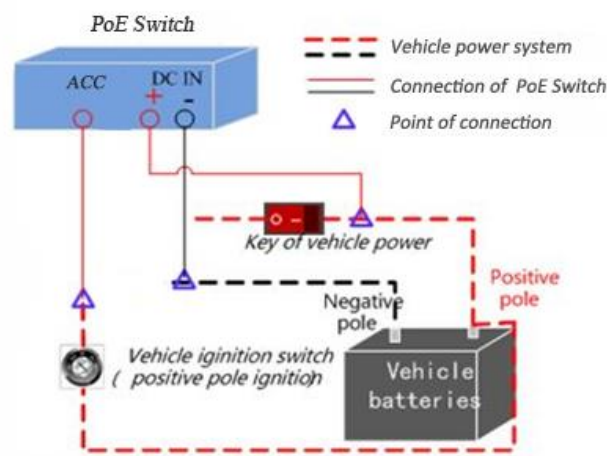

Figure 2-14 Connection of Positive Pole Ignition Switch

Ignition switch is connected to the positive pole of +12/24 VDC of vehicle batteries. Make sure that the connection is correct, and then perform the following steps:

- Step 1 Connect the "DC IN +" of the device to the positive pole of vehicle batteries, jumping over the switch of normal vehicle power.
- Step 2 Connect the "DC IN -" of the device to the negative pole of vehicle batteries.
- Step 3 Connect the "ACC" of the device to the vehicle ignition switch.

 NOTE

- Step 4 The normal vehicle power refers to the main power of the vehicle power supply system. After the vehicle is off, the normal vehicle power still provides direct-current source for the other devices inside and generally a main switch is used to turn on/off it.

## 2.6.2 Timed Shutdown

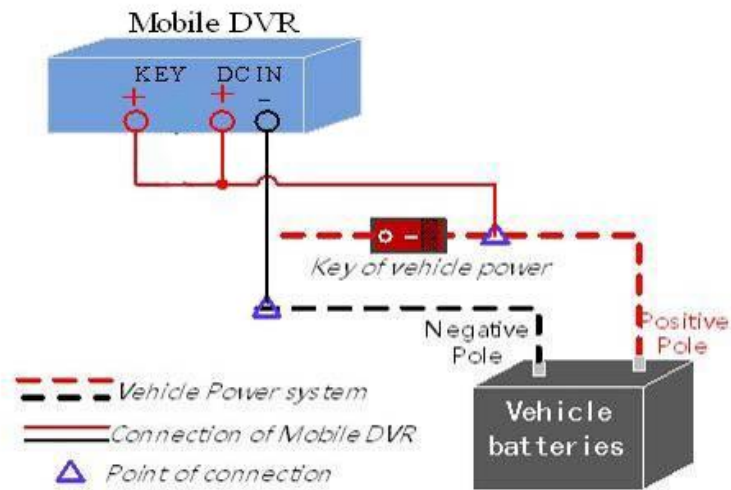

Figure 2-15 Timing On/Off

Step 2 Connect the “DC IN +” and “KEY +” of mobile DVR to the positive pole of vehicle batteries.

Step 3 Connect the “DC IN -” and “KEY -” of mobile DVR to the negative pole of vehicle batteries.

For detailed time settings of time-delay shutdown, see *16.1 Enable Scheduled Startup/Shutdown*.

## Chapter 3 Start Up Device

### 3.1 Startup

**Before you start:**

- Install the HDD. Refer to 2.1 Install HDD for details.
- Connect the cables and modules correctly. Refer to *Chapter 2 Installation and Connections* for details.

Step 1 Insert the key into the dummy HDD lock.

Step 2 Rotate it clockwise to **ON** status.



- Do not perform any operations during the startup process.
- The startup process takes about 1 minute. The system enters the live view interface after startup.

### 3.2 Activation

**Purpose:**

For the first-time access, you need to activate the device by setting an admin password. No operation is allowed before activation.

Step 1 Enter the same password in the text field of **New Password** and **Confirm**.

A screenshot of a software dialog box titled "Activation". It has a dark background with white text. The "User Name" field is filled with "admin". The "New Password" field contains seven asterisks and has three green bars to its right. The "Confirm" field also contains seven asterisks. Below the fields is a green checkmark icon followed by the text: "Valid password ranges from 8 to 16 characters and contains two or more character combinations, including numeric, lowercase, uppercase and other characters." At the bottom right, there are two buttons: "OK" and "Cancel".

Figure 3-1 Settings Admin Password



**STRONG PASSWORD RECOMMENDED**—We highly recommend you create a strong password of your own choosing (Using a minimum of 8 characters, including at least three of the following categories: upper case letters, lower case letters, numbers, and special characters.) in order to increase the security of your product. And we recommend you reset your password regularly, especially in the high security system, resetting the password monthly or weekly can better protect your product.

---

Step 2 Click **OK** to save the password and activate the device.



For the old version device, if you upgrade it to the new version, a dialog box will pop up once the device starts up. You can click **YES** and follow the wizard to set a strong password.

## Chapter 4 Network

### 4.1 Set Local Network

Step 1 Go to **Menu > Basic Settings > Network**.

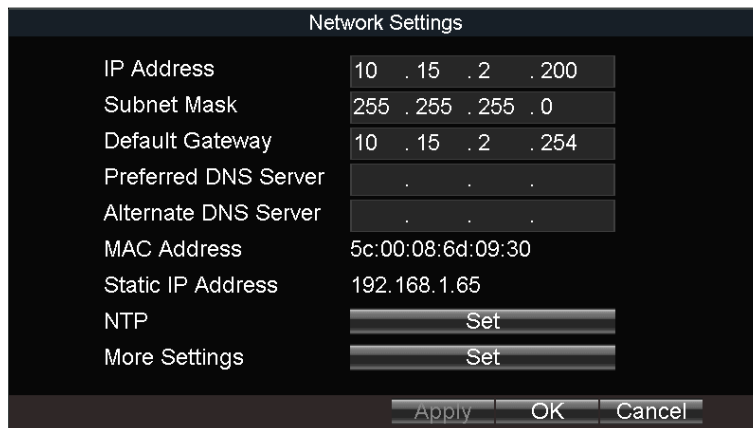

Figure 4-1 Local Network Settings

Step 2 Enter the device **IP Address, Subnet Mask, Default Gateway, DNS Server Address, and Download Server IP**.

Step 3 Optionally, click **Set** of **More Settings** to enable/disable **LAN Sharing**.

**LAN Sharing:** Enable the function to share 3G/4G network to network interface.



The IP address of the device should be unique in the network and the default value is 192.168.1.64.

Step 4 Click **OK**.

## 4.2 Connect Wireless Network

### 4.2.1 3G/4G Dialing

**Before you start:**

Install a 3G/4G SIM card on the device. Refer to 2.2 *Install SIM Card* for details.

Step 1 Go to **Menu > Basic Settings > Dial**.

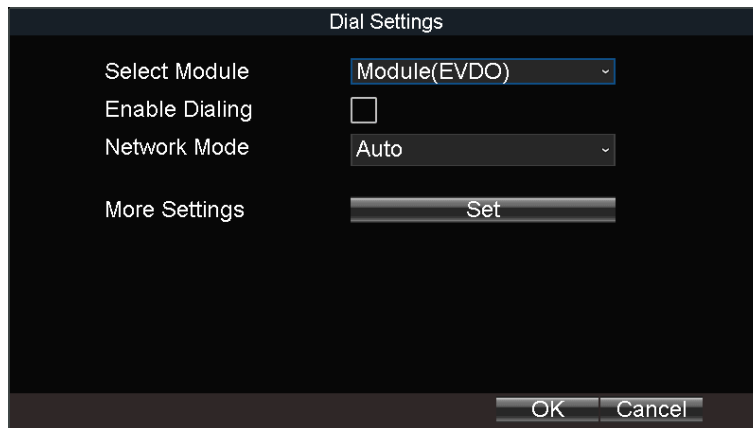

Figure 4-2 Dialing Settings

Step 2 Check **Enable Dialing**.

Step 3 Configure the 3G/4G VPDN (Virtual Private Dialup Network) settings. Please consult the local operator for the network parameters of the VPDN.

- 1) Click the **Set** button of **More Settings**.
- 2) Select **Bearing Mode**.
- 3) Enter **APN** (Access Point Name), **Dial Number**, **User Name**, and **Password**.
- 4) Select the **Verification Protocol**.
- 5) Click **OK**.

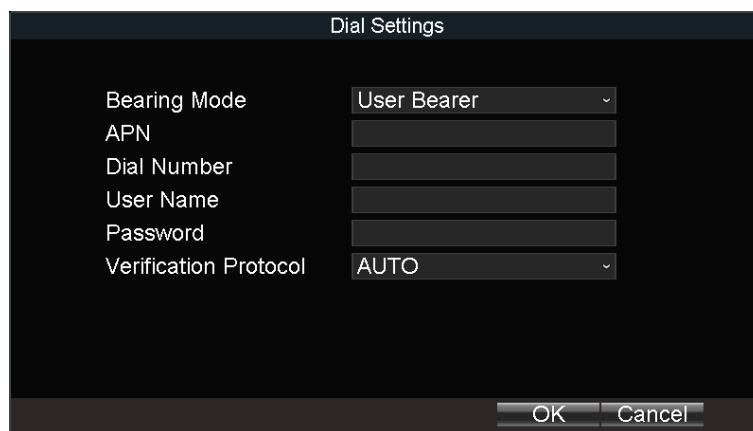

Figure 4-3 Private Network Settings

Step 4 Click **OK** and reboot the device to activate the new settings.

Step 5 Optionally, go to **Menu > Status > Dial** to view dialing status.

## 4.2.2 Set Wi-Fi

### **Purpose:**

Connect the device to a Wi-Fi network and transmit the data via the Wi-Fi.

Step 1 Go to **Menu > Basic Settings > WiFi**.



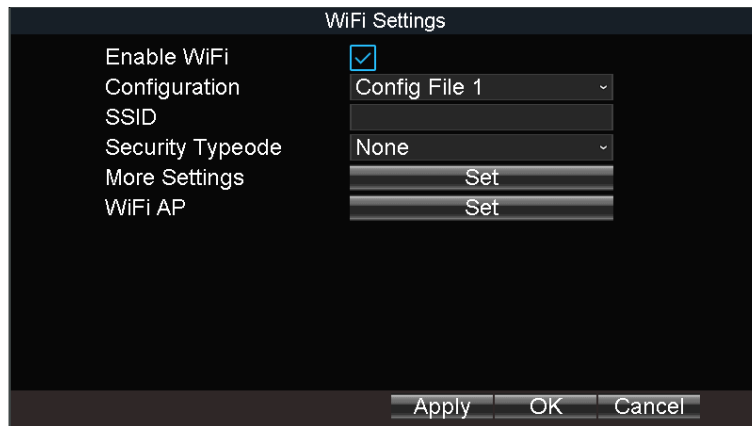

Figure 4-4 Wi-Fi Settings

Step 2 Check **Enable WiFi**.

Step 3 Select the **Configuration** file. 5 configuration files are available and only one SSID can be set for each file.

Step 4 Select network **SSID** (Service Set Identifier), **Security Type**, **Encryption Type**, and **Key**.

Step 5 Set the IP address and DNS server for Wi-Fi network.

- 6) Click **Set** of **More Settings**.
- 7) Configure IP address and DNS parameters.
- 8) Click **OK**.

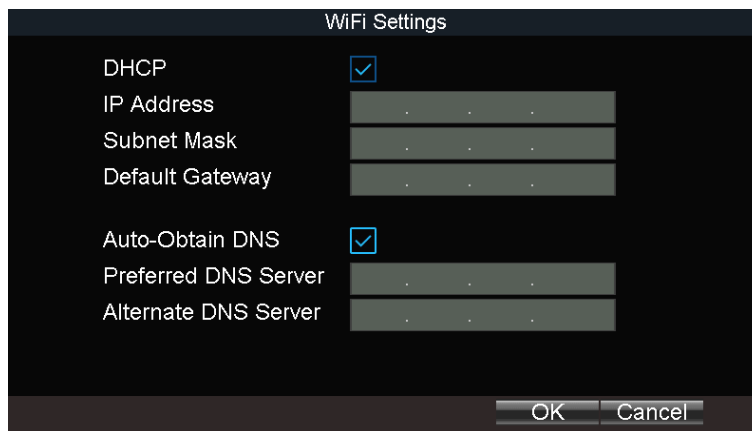

Figure 4-5 IP & DNS Settings for Wi-Fi

Step 6 Click **OK**.

Step 7 Optionally, go to **Menu > Status > WiFi** to view the Wi-Fi status.

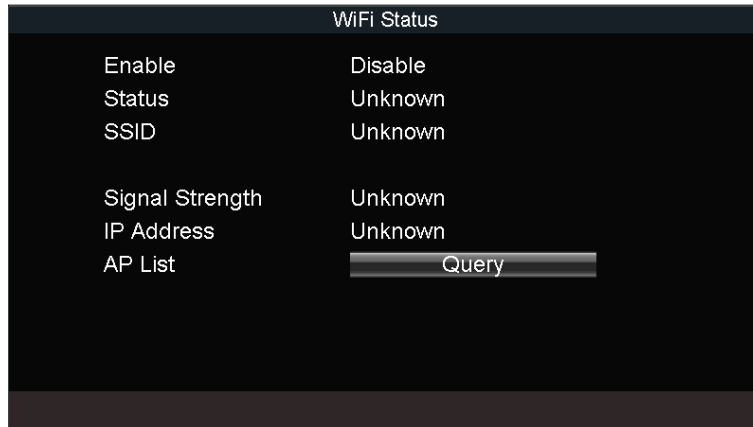

Figure 4-6 Wi-Fi Status Interface

### 4.2.3 Set Wi-Fi AP

**Purpose:**

Configure Wi-Fi access point settings.

Step 1 Go to **Menu > Basic Settings > WiFi.**

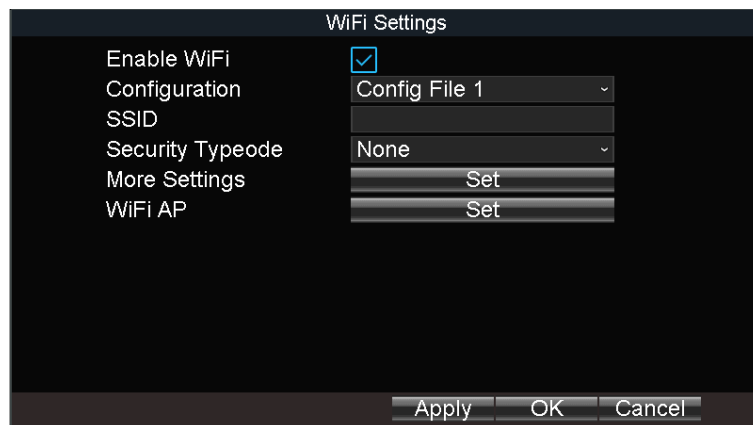

Figure 4-7 Wi-Fi Settings

Step 2 Click **Set of WiFi AP**

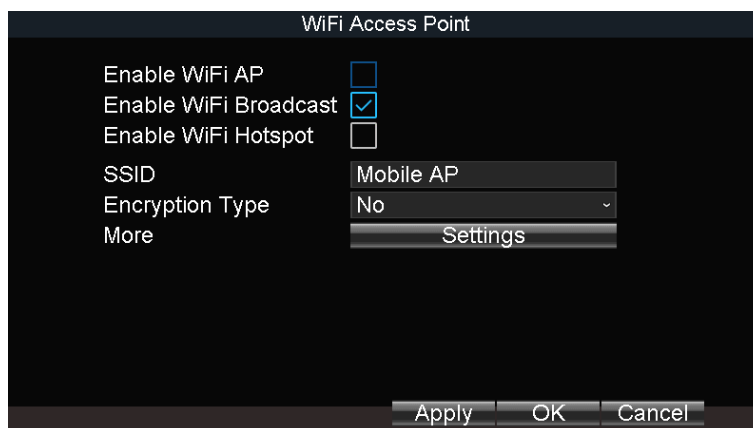

Figure 4-8 Wi-Fi Access Point Settings

Step 3 Check **Enable WiFi AP** and edit other parameters as required.

- **Enable WiFi AP:** Once enabled, the device can work as a wireless router.
- **Enable WiFi Broadcast:** Once enabled, other devices are able to detect the SSID of the device.
- **Enable WiFi Hotspot:** Enable it to share the device's internet connection. Other devices can access to internet via joining the hotspot.

Step 4 Click **OK**.

## 4.3 Firewall Settings

### **Purpose:**

The device provides software-based firewall to protect the device against the threats from the public network. A white list can be set, and only the trusted IP addresses on the white list can access the device via the network.



- 192.0.0.xxx is set as the default trusted IP addresses.
- The IP address of the platform server to add the device is set as the trusted IP address.
- Up to 16 IP addresses can be added on the white list.

Step 1 Go to **Menu > Other Settings > Firewall**.

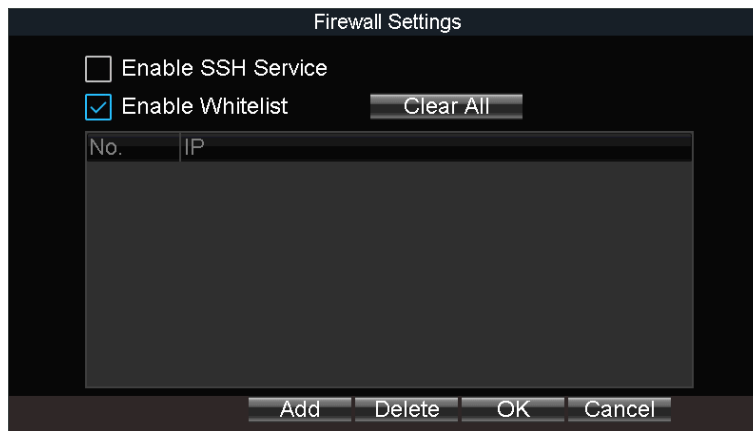

Figure 4-9 Firewall Settings

Step 2 Optionally, select **Enable SSH Service**, thus to effectively prevent information leakage during remote management.

Step 3 Click **Add**.

Step 4 Enter the trusted IP address and click **OK**.

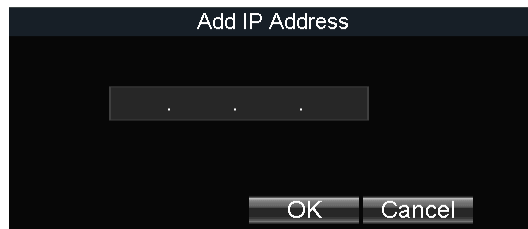

Figure 4-10 Add IP Address

Step result: The trusted IP address will be added on the white list.



The configured whitelist will be cleared after you reboot the device.

## Chapter 5 IP Camera

### **Purpose:**

Add IP cameras to the device. You can get the live view, record the video, and set the parameters of the connected IP camera.

### 5.1 Activate IP Cameras

#### **Purpose:**

Before adding an IP camera, activate it by setting a password for it.

Step 1 Go to **Menu > Other Settings > IPC Settings**.

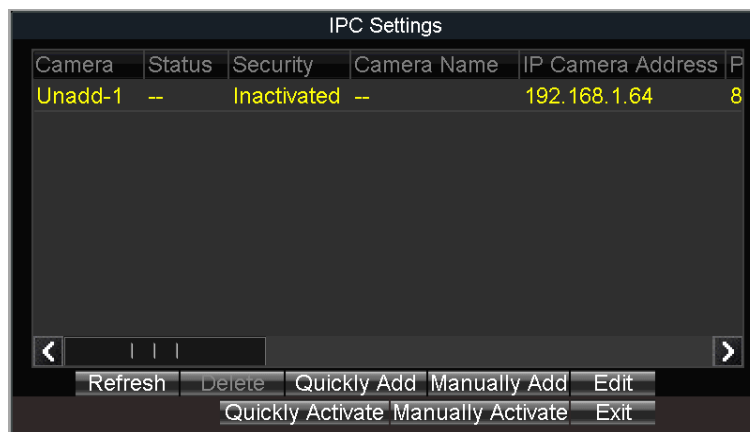

Figure 5-1 IPC Settings

Step 2 Select an inactivated IP camera.

Step 3 Activate the selected IP camera.

- **Option 1:** Quick Activation

Click **Quickly Activate**. The IP camera password will be set as the same with the device password.

- **Option 2:** Manual Activation

- 1) Click **Manually Activate**.

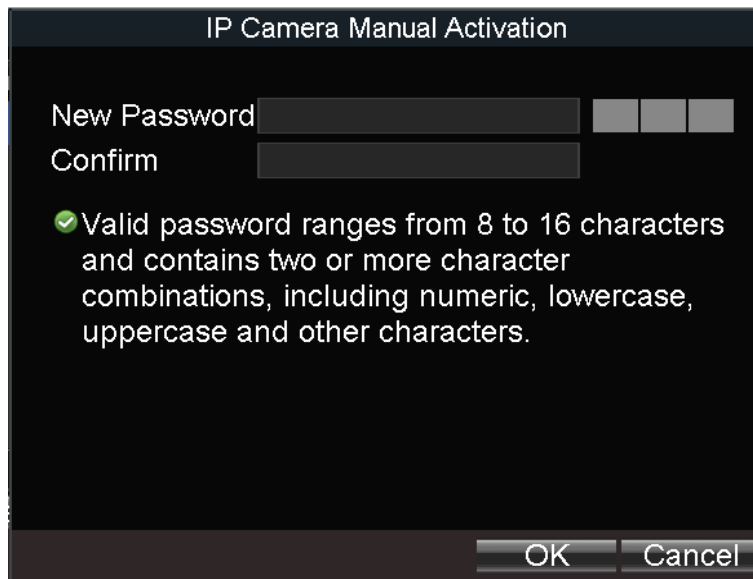

Figure 5-2 Activate IP Camera Manually

- 2) Enter New Password and enter the same password in Confirm.



**STRONG PASSWORD RECOMMENDED** – We highly recommend you create a strong password of your own choosing (Using a minimum of 8 characters, including at least three of the following categories: upper case letters, lower case letters, numbers, and special characters.) in order to increase the security of your product. And we recommend you reset your password regularly, especially in the high security system, resetting the password monthly or weekly can better protect your product.

- 3) Click **OK**.

## 5.2 Add IP Cameras

### ***Purpose:***

You can add the online IP cameras. Ensure the network communication between the device and IP camera is well.

### 5.2.1 Quick Add

### ***Purpose:***

The online IP cameras in the same network segment with the device will be displayed on a list. If the IP camera on the list has the same password with the device, you can quickly add it.

### ***Before you start:***

Make sure the IP camera password is the same with the device.

Step 1 Go to **Menu > Other Settings > IPC Settings**.

Step 2 Select an online IP camera.

Step 3 Click **Quickly Add**.

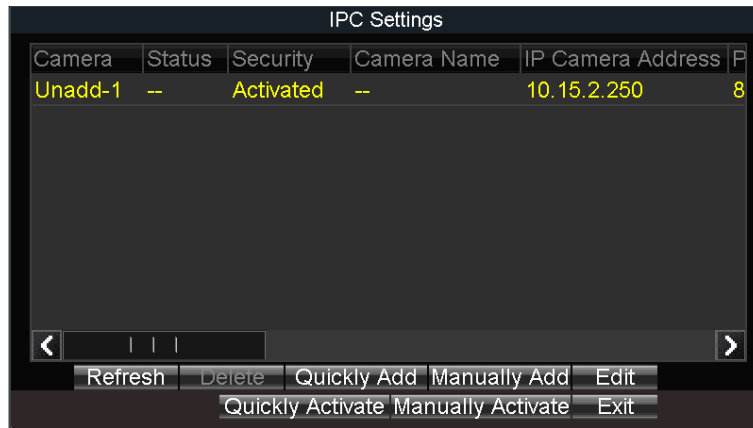



Figure 5-3 Quick Add IP Camera

- : The IP camera is disconnected.
- : The IP camera is connected.

## 5.2.2 Add IP Camera Manually

Step 1 Go to **Menu > Other Settings > IPC Settings**.

Step 2 Click **Manually Add**.

Step 3 Select the IP channel No. for the IP camera.

Step 4 Edit the required information, including the **IP address, Protocol, Port No., User Name, and Password**.

Step 5 Click **OK**.



Figure 5-4 Manual Add

## 5.2.3 Edit Protocol

### **Purpose:**

To connect the network cameras which are not configured with the standard protocols, you can configure the customized protocols for them. The system provides 16 customized protocols.

Step 1 Go to **Menu > Other Settings > IPC Settings.**

Step 2 Click **Manually Add.**

Step 3 Click **Protocol.**

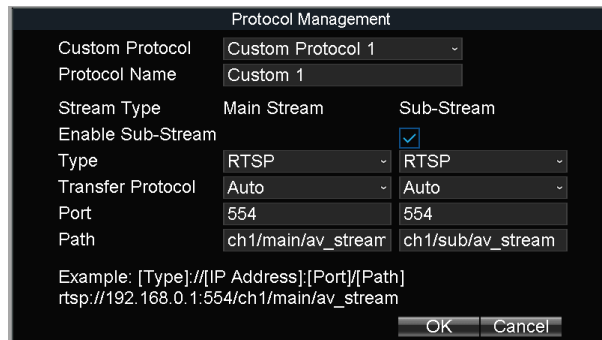

Figure 5-5 Protocol

Step 4 Edit parameters as required.

Step 5 Click **OK**

## 5.3 Edit IP Cameras

Step 1 Select an added IP camera and click **Edit.**

Step 2 Edit the parameters.

Step 3 Enter **Password.** The password must be correct.

Step 4 Click **OK.**

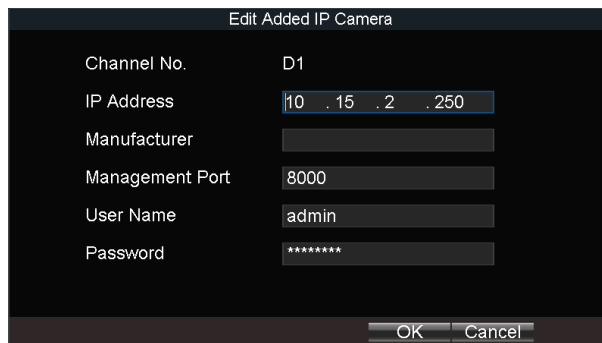

Figure 5-6 Edit IP Camera

## 5.4 Delet IP Cameras

Step 1 Select an IP camera and click **Delete.**

Step 2 Click **Yes** on the pop-up dialog box.





Figure 5-7 Delete IP Camera

## Chapter 6 Camera Management

### 6.1 Basic Image Settings

#### 6.1.1 Set OSD Parameters

**Purpose:**

Configure the camera name, OSD (On Screen Display) settings, etc.

Step 1 Go to **Menu > Other Settings > Camera**.

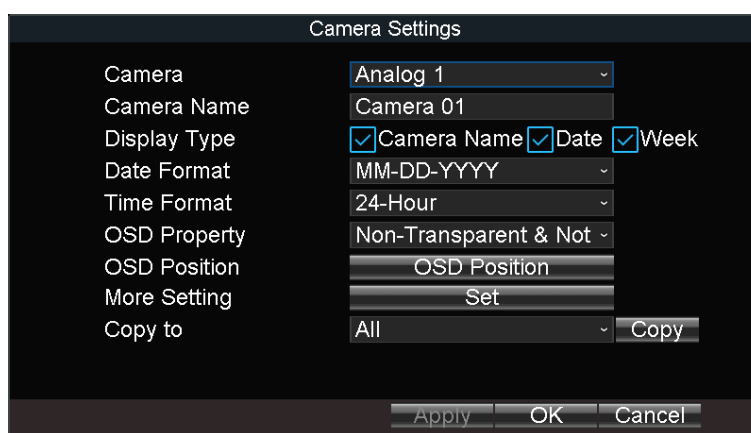

Figure 6-1 Camera Settings

Step 2 Select the **Camera** from the drop-down list.

Step 3 Edit parameters as your desire.

Step 4 Optionally, select the camera in Copy to dropdown list and click **Copy** to copy the current settings to the selected camera.

Step 5 Click **OK**.

#### 6.1.2 Set Image Parameters

Step 1 Go to **Menu > Other Settings > Camera**.

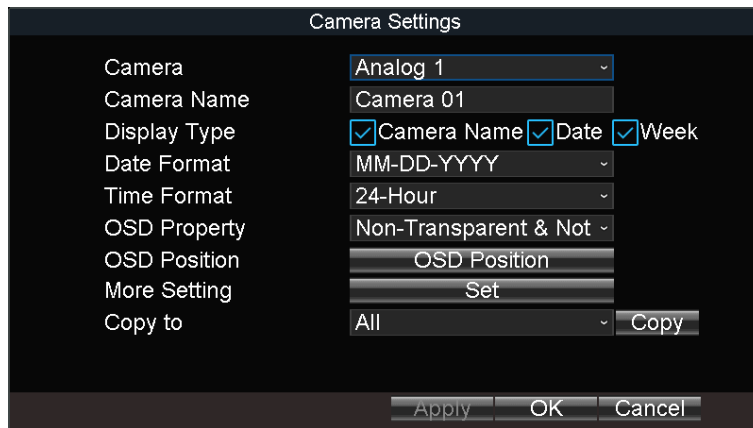

Figure 6-2 Camera Settings

Step 2 Click **Set** of **More Setting**.

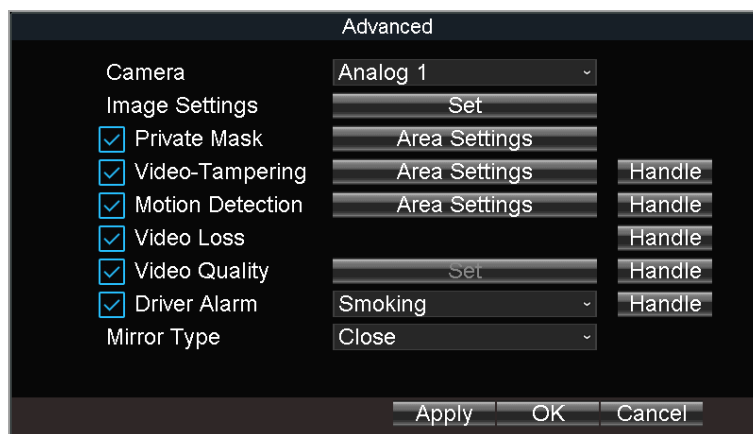

Figure 6-3 More Setting

Step 3 Click **Set** of Image Settings.



Figure 6-4 Image Settings

Step 4 Edit the parameters.

Step 5 Click **OK**.

Step 6 Click **OK** in advanced settings interface.

Step 7 Click **OK** in camera settings interface.

### 6.1.3 Set TVI Camera

**Purpose:**

Configure the image parameters of connected TVI camera. The feature is only available for TVI camera.

Step 1 Go to **Menu > Other Settings > Camera**.

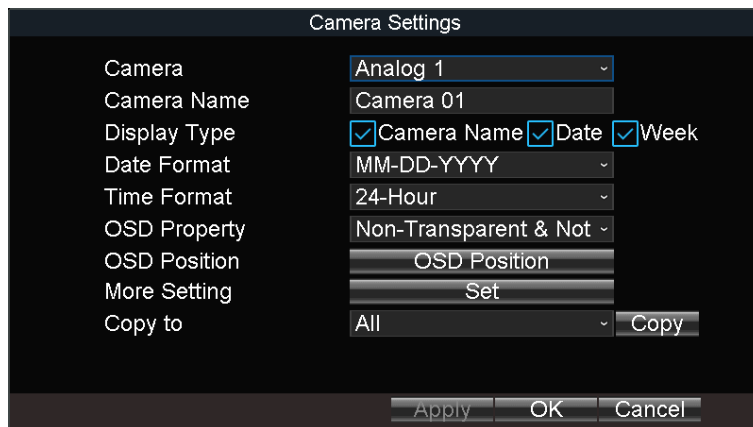

Figure 6-5 Advanced Settings

Step 2 Click **Set** of **More Setting**.

Step 3 Click **Set** of **TVI Camera Settings**.



Figure 6-6 TVI Camera Settings

Step 4 Edit the parameters according to your needs.

Step 5 Click **OK** in TVI Camera Settings interface.

Step 6 Click **OK** in Advanced settings interface.

Step 7 Click **OK** in Camera settings interface.

## 6.2 Set Privacy Mask

### **Purpose:**

The privacy mask can be used to protect personal privacy by concealing parts of the image from view or recording with a masked area.

Step 1 Go to **Menu > Other Settings > Camera**.

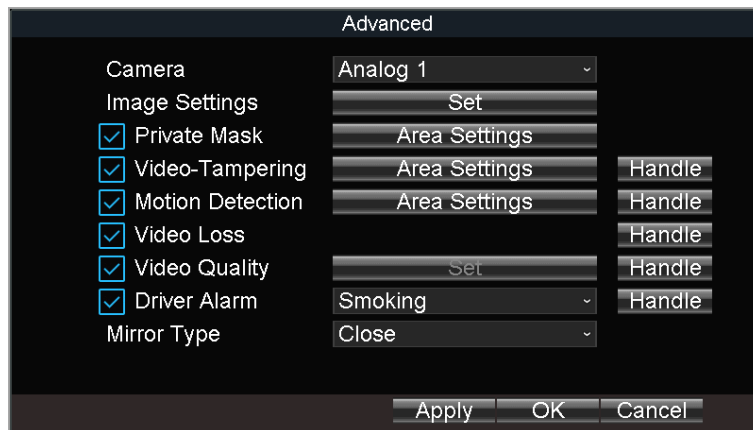

Figure 6-7 Advanced Settings

Step 2 Click **Set** of **More Setting**.

Step 3 Check **Private Mask**.

Step 4 Click **Area Settings** of **Private Mask**.

Step 5 Draw areas.

Step 6 Right click and select **Exit**.

Step 7 Click **OK** in Advanced settings interface.

Step 8 Click **OK** in Camera settings interface.

## 6.3 Set Mirror Type

### ***Purpose:***

Set the mirror type of the image as left/right, up/down, or center. The camera image will change according to the selected mirror type.

The feature is only available for IP camera. (To configure mirror image for analog camera, refer to 6.1.3 Set TVI Camera.)

Step 1 Go to **Menu > Other Settings > Camera**.



Figure 6-8 Advanced Settings

Step 2 Click **Set** of **More Setting**.

Step 3 Select **Mirror Type** as required.

Step 4 Click **OK** in Advanced settings interface.

Step 5 Click **OK** in Camera settings interface.

## Chapter 7 Live View

### 7.1 Preview Settings

**Purpose:**

Configure the dwell time of live view, set the camera order, enable/disable the audio preview, etc.

Step 1 Go to **Menu > Other Settings > Preview**.

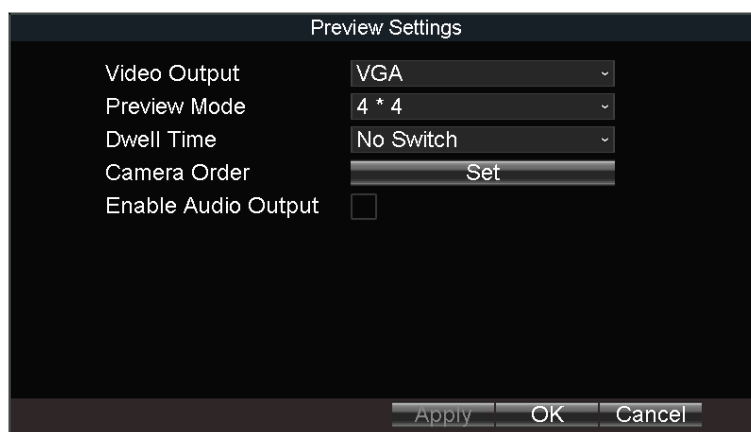

Figure 7-1 Preview Settings

Step 2 Select the **Video Output** according to the actual needs.

Step 3 Configure the Preview Mode, Dwell Time, Enable Audio Output.

- **Preview Mode:** Select the window division mode for live view.
- **Dwell Time:** The switch interval of the live view screen. The screen will be switched to the next one after the selected dwell time.
- **Enable Audio Output:** Enable/disable audio output for the selected video output.

Step 4 Click **OK**.

### 7.2 Set Camera Order

**Purpose:**

Set the live display order for cameras.

Step 1 Go to **Menu > Other Settings > Preview**.

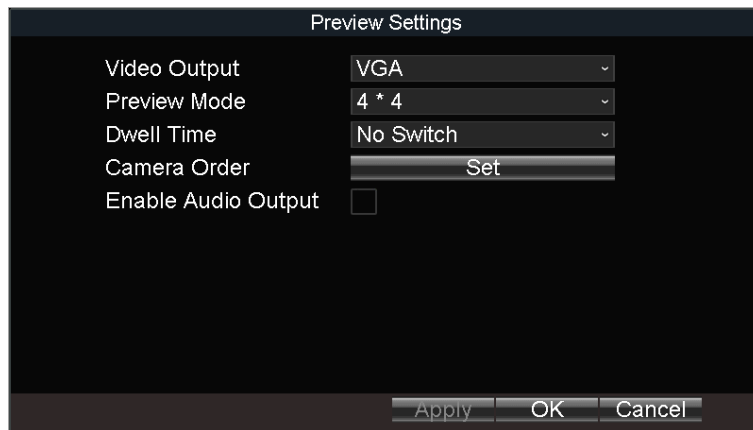

Figure 7-2 Preview Settings

Step 2 Click **Set** of **Camera Order**.

Step 3 Click  /  to switch camera.

Step 4 Click **OK**.

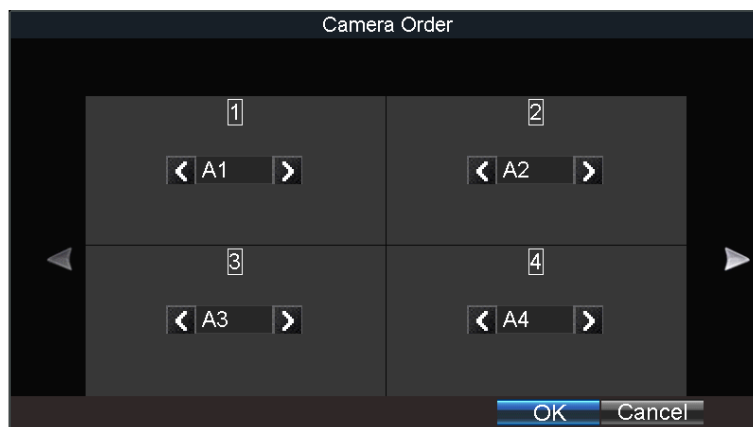

Figure 7-3 Camera Order

Step 5 Click **OK** in Preview Settings interface.

## 7.3 Right-Click Menu

### **Purpose:**

In live view, right click on a camera to pop up right-click menu.

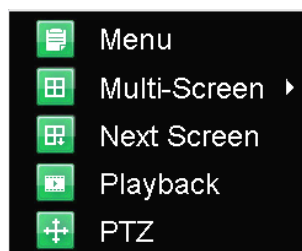

Figure 7-4 Right-Click Menu



Table 7-1 Item Description

Item	Description
Menu	Enter the main menu of the system by right clicking the mouse.
Multi-Screen	Adjust the screen layout by choosing from the dropdown list.
Next Screen	Switch to the next screen.
Playback	Enter the playback interface and start playing back the video of the selected channel immediately.
PTZ	Click to pop up PTZ control panel.

## 7.4 PTZ Operation

### 7.4.1 Configure PTZ Settings

**Purpose:**

Follow the procedure to set the parameters for PTZ. The configuration of the PTZ parameters should be done before you control the PTZ camera.

**Before you start:**

Connect the RS-485 cables of PTZ camera to EXT.DEV interface of the device.

Step 1 Go to **Menu > Other Settings > PTZ**.

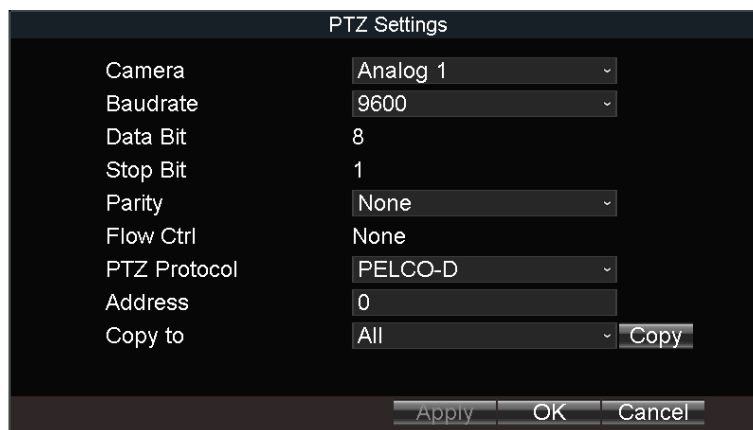

Figure 7-5 PTZ Settings

Step 2 Select the **Camera** for PTZ settings.

Step 3 Configure the parameters of the PTZ camera.



All the parameters should be exactly the same with those of the PTZ camera.

Step 4 Click **OK**.

## 7.4.2 PTZ Control Panel

In live view interface, right click a PTZ camera and click **PTZ** on right-click menu.

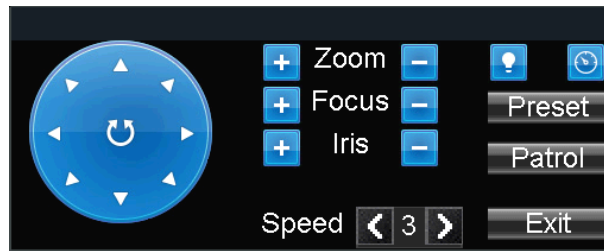







Figure 7-6 PTZ Control Panel

Table 7-2 Description of PTZ Control Panel

Icon	Description	Icon	Description	Icon	Description
	Direction buttons and the auto-cycle button		Zoom+, Focus+, Iris+		Zoom-, Focus-, Iris-
	Moving speed		Light on/off		Wiper on/off

# Chapter 8 Storage

## 8.1 Storage Settings

### 8.1.1 Format HDD

**Purpose:**

A newly installed hard disk drive (HDD) must be initialized before it can be used.

Step 1 Go to **Menu > Storage**.

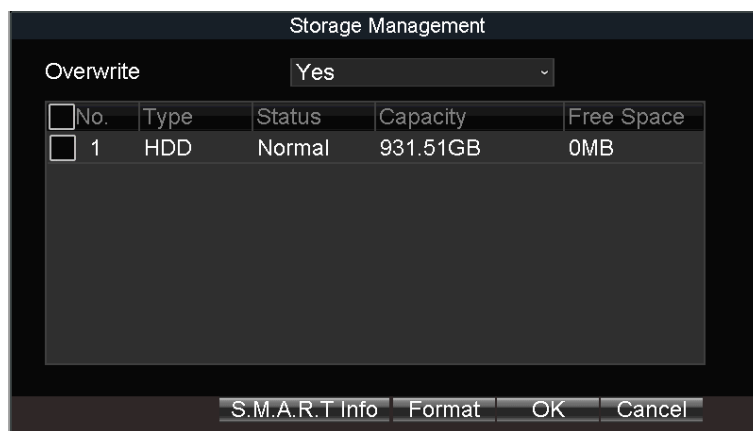

Figure 8-1 Storage Management

Step 2 Check the HDD to format.

Step 3 Click **Format**.

### 8.1.2 Configure Overwrite

**Purpose:**

The overwrite function is enabled by default. If the function is disabled, the recording will stop when the storage device is full.

Step 1 Go to **Menu > Storage**.

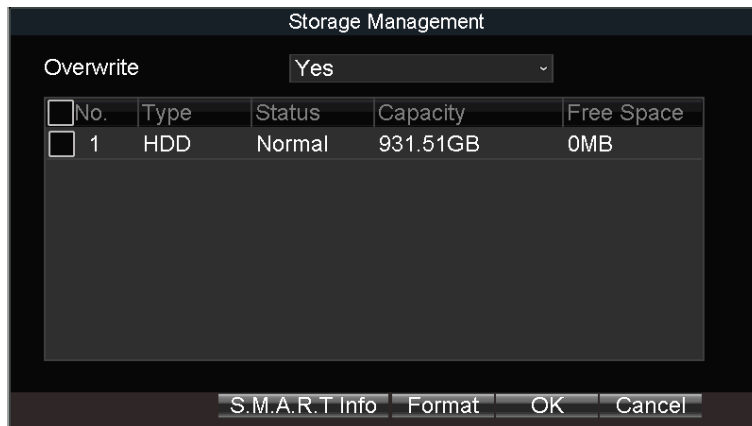

Figure 8-2 Storage Management

Step 2 Select **Overwrite** as **Yes** or **No**.

Step 3 Click **OK**.

### 8.1.3 View S.M.A.R.T. Information

**Purpose:**

The S.M.A.R.T. (Self-Monitoring, Analysis and Reporting Technology) is a monitoring system for HDD to detect and report on various indicators of reliability in the hopes of anticipating failures.

Step 1 Go to **Menu > Storage**.

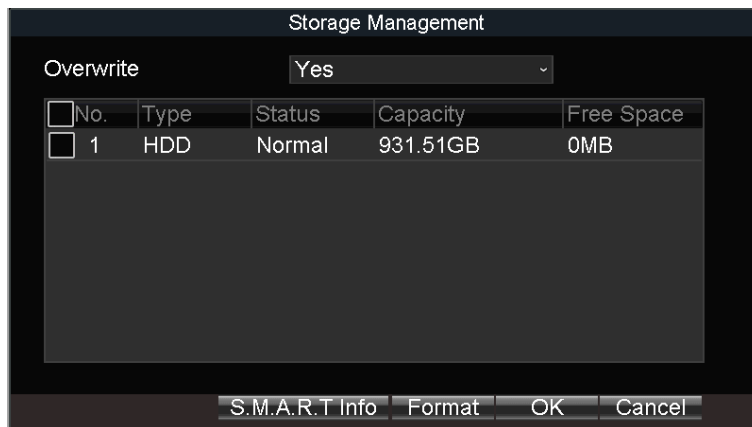

Figure 8-3 Storage Management

Step 2 Select an HDD.

Step 3 Click **S.M.A.R.T. Info**.

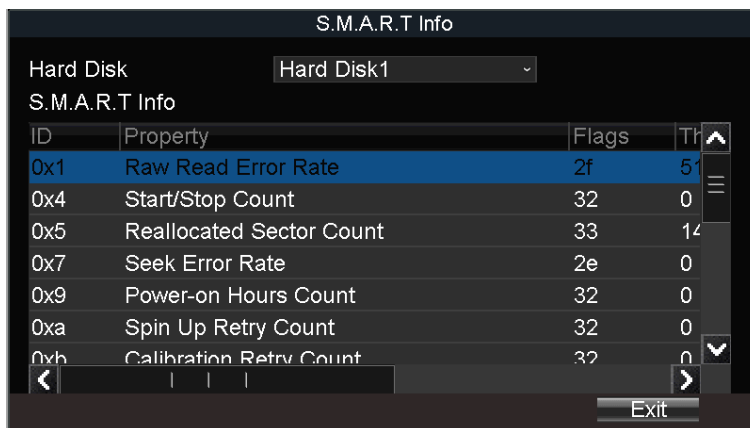

Figure 8-4 S.M.A.R.T Information

## 8.2 Recording Settings

### 8.2.1 Configure Record Settings

**Purpose:**

Configure the transmission stream type, the resolution, frame rate, etc.

Step 1 Go to **Menu > Basic Settings > Record**.

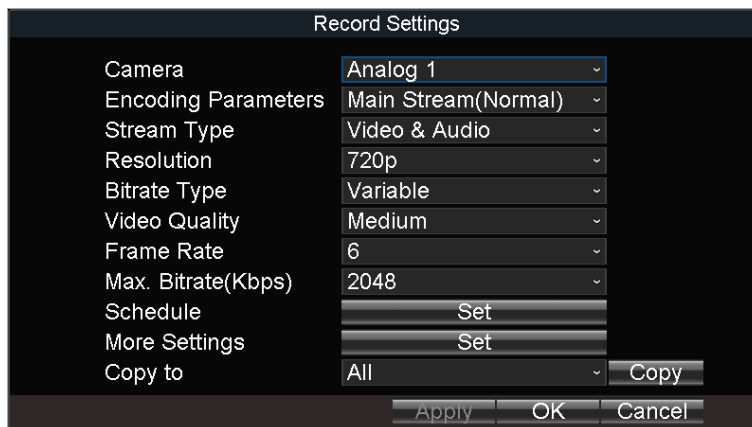

Figure 8-5 Record Settings

Step 2 Select camera in Camera drop-down list.

Step 3 Configure the image parameters.

- Encoding Parameters
  - Main Stream (Normal): Used for continuous recording.
  - Main Stream (Event): Used for event recording.
  - Sub Stream: Used for network transmission.
- Stream Type
  - Video and Video & Audio are selectable.
- Bitrate Type

- Variable and Constant are selectable.
- Variable: The video quality is configurable.
- Constant: The video quality is set as Medium and cannot be edited.
- Video Quality
 

Bitrate type is variable, you can set the video quality as Highest, Higher, Medium, Low, Lower, or Lowest.
- Frame Rate
 

Frame rate refers to the frequency of the image frame after compression. With other parameters constant, reduce the video frame rate, and you can lower the maximum bitrate to some extent.
- Max. Bitrate(Kbps)
 

Select the fixed value provided by the system or customize the maximum bitrate as desired.

Step 4 Edit recording schedule. For details, refer to *8.2.5 Configure Schedule*.

Step 5 Click **Set** of **More Settings** to configure the pre-record and post-record time.

- **Pre-Record:** Normally used for the event (motion or alarm) triggered record, when you want to record before the event happens. For example, when an alarm occurs at 10:00, if the pre-record time is set as 5 seconds, the camera records the alarm at 9:59:55.
- **Post-Record:** After the event finished, the video can also be recorded for a certain time. For example, when an alarm ends at 11:00, if the post-record time is set as 5 seconds, the camera records till 11:00:05.

Step 6 Click **OK**.

## 8.2.2 Configure Motion Detection Recording

### **Purpose:**

In the motion detection recording, once a motion event occurs, the device starts to record.

Step 1 Go to **Menu > Other Settings > Camera**.

Step 2 Click **Set** of **More Setting**.

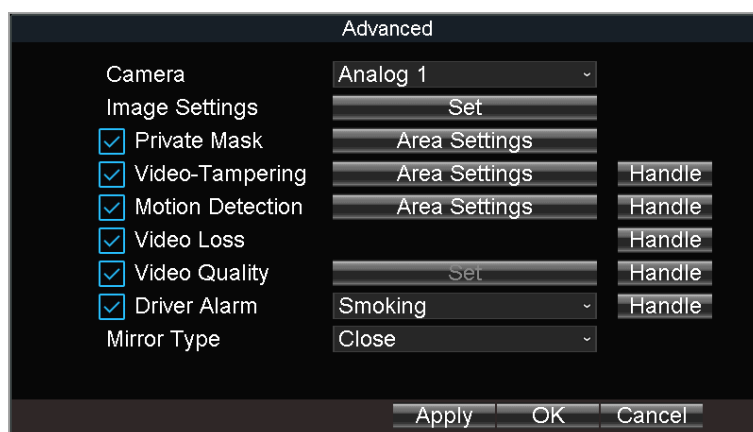

Figure 8-6 Motion Detection Settings

Step 3 Check **Motion Detection**.

Step 4 Click **Area Settings of Motion Detection**.

Step 5 Edit area settings. For details, refer to *12.12 Configure Detection Area*.

Step 6 Click **OK**.

Step 7 Set motion detection recording schedule. For details, refer to *8.2.5 Configure Schedule*.  
Recording type should be alarm, motion|alarm, or motion&alarm.

## 8.2.3 Configure Alarm Triggered Recording

### **Purpose:**

Follow the procedure to configure alarm triggered recording.

Step 1 Go to **Menu > Other Settings > Alarm In**.

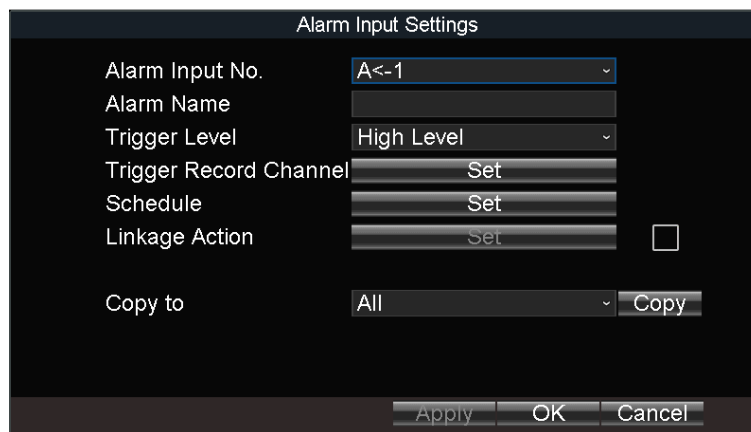

Figure 8-7 Alarm Input Settings

Step 2 Click **Set** of **Trigger Record Channel** to select the alarm triggered recording channel(s).

Step 3 Click **OK**.

Step 4 Enter the Record Settings interface to set alarm triggered recording schedule. Refer to *Chapter 3.1.2* for record settings. Recording type should be alarm, motion | alarm, or motion & alarm.

## 8.2.4 Configure Alarm Terminal

### **Before you start:**

- Install an alarm terminal. For details, refer to alarm terminal user manual.
- The RS-232 serial port should be used in the way of transparent channel and the baud rate should be set as 9600.

Step 1 Go to **Menu > Other Settings > Alarm Terminal**.



Figure 8-8 Alarm Terminal

Step 2 Check **Enable Alarm Terminal**.

Step 3 Edit the terminal name in **Terminal Name** text field.

Step 4 Select **Set** of **Trigger Record Channel** to set alarm triggered recording channel(s).

Step 5 Click **OK**.

## 8.2.5 Configure Schedule

Step 1 Go to **Menu > Basic Settings > Record**.

Step 2 Click **Set** of **Schedule**.

Step 3 Check **Enable Schedule**.

Step 4 Select the day from the dropdown list for settings.

Step 5 Configure all day schedule or custom schedule.

- Check **All Day** to enable all-day recording, and then select the recording type from the drop-down list.
- Uncheck **All Day**, customize the time period for recording, and select the recording type for each time period.

Step 6 Click **OK**.



**NOTE**

- 5 recording types are selectable: Normal, Motion Detection, Alarm, Motion|Alarm, and Motion&Alarm.
- Up to 8 time periods can be set for each day and each of the time periods cannot be overlapped.



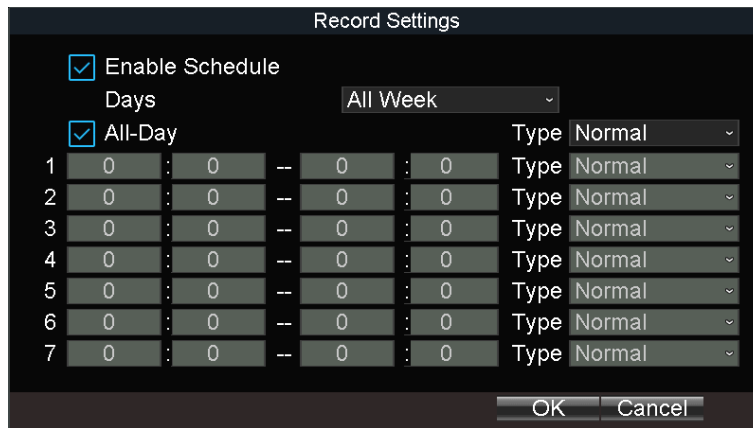

Figure 8-9 Record Schedule Settings

## 8.3 Sensor-in Settings

**Purpose:**

Sensor-in detects and records the driving information of the vehicle, including pedal braking, turning left/right, reversing, etc.

Step 1 Go to **Menu > Basic Settings > Sensor-In.**

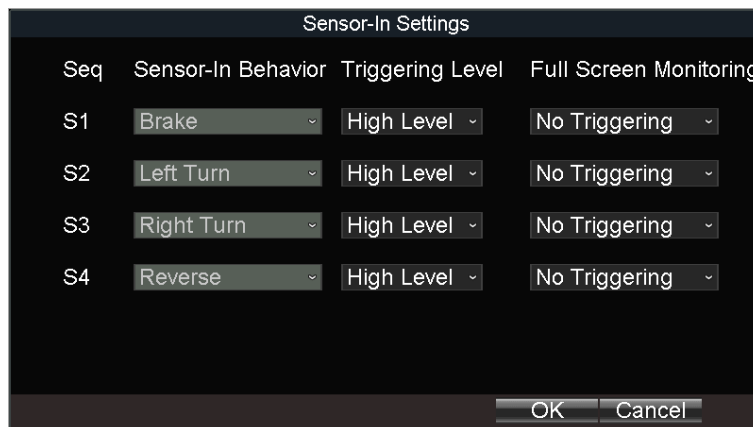

Figure 8-10 Sensor-In Settings

Step 2 Set **Triggering Level** and **Full Screen Monitoring** for sensor-in.

Step 3 Click **OK**.

## Chapter 9 Playback

### 9.1 Instant Playback

**Purpose:**

You can search and play back the record files stored on the device instantly.

Step 1 Go to **Menu > Video Search**.



Figure 9-1 Video Search

Step 2 Select **Search Mode** as **General**. Only general videos support instant playback.

**General:** Normal videos

Step 3 Select **Camera**.

Step 4 Select **Video Type**.

Step 5 Specify **Start Time** and **End Time**.

Step 6 Click **Play** to play back the matched videos.



If more than 4,000 videos are found, the top 4,000 items have the priority to be played.

### 9.2 Play Video by File

**Purpose:**

You can search and play back the record files stored on the mobile DVR.

Step 1 Go to **Menu > Video Search**.



Figure 9-2 Video Search

Step 2 Select **Search Mode**.

- **General**: Normal videos
- **Event**: Motion detection, alarm, motion | alarm, motion&alarm videos.

Step 3 Select **Camera**.

Step 4 Select **Video Type**.

Step 5 Specify **Start Time** and **End Time**.

Step 6 Click **Search**. The matched videos will be displayed.

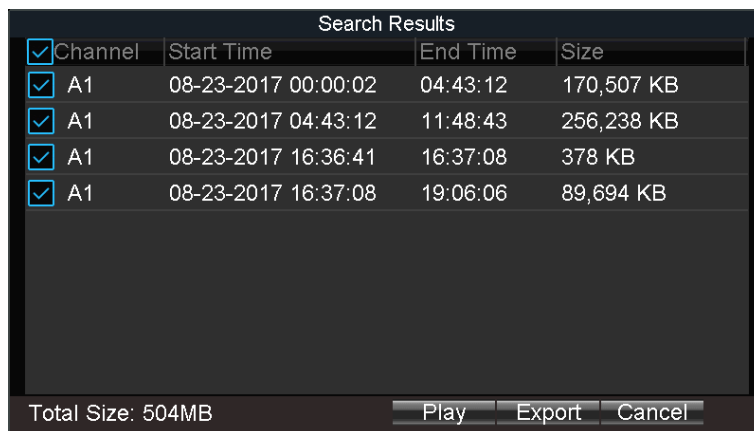

Figure 9-3 Search Result

Step 7 Select a video and click **Play**.

## Chapter 10 Platform

### 10.1 Ehome

**Purpose:**

The device can be remotely accessed via Ehome platform.

**Before you start:**

Create the device ID on the Ehome platform.

Step 1 Go to **Menu > Basic Settings > Platform**.

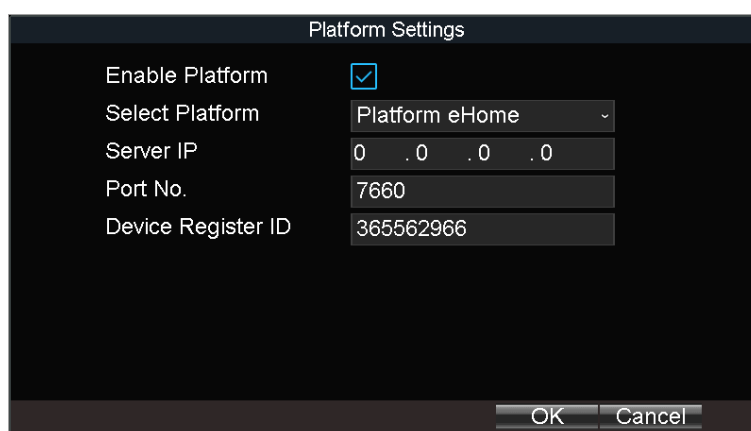

Figure 10-1 Platform Settings

Step 2 Check **Platform Enable**.

Step 3 Select **Platform** as **Ehome**.

Step 4 Configure the following parameters.

- **Server IP:** Enter the static IP address of iVMS server.
- **Port No.:** The default value is 7660.
- **Device Register ID:** The ID of the device registered on the Ehome platform. If you leave it empty, device logs in to the platform with serial No.

Step 5 Click **OK** and reboot the device to activate the new settings.

Step 6 Optionally, go to **Menu > Status > Platform** to view the platform status.

### 10.2 Guarding Vision

**Purpose:**

The device can be remotely accessed via guarding vision platform.

**Before you start:**

Register the device in guarding vision platform. For detailed steps, refer to *10.3 Register Device in Guarding Vision platform*.

Step 1 Go to **Menu > Basic Settings > Platform**.

Step 1 Check **Enable Platform**.

Step 2 Select **Platform** as **Guarding Vision**.

Step 3 Click **OK** and reboot the device to activate the new settings.

Step 4 Optionally, go to **Menu > Status > Platform** to view the platform status.

## 10.3 Register Device in Guarding Vision platform

Step 1 Access Guarding Vision platform.

- For computer user: dev.guardingvision.com.
- For mobile phone user: download Guarding Vision app.

Step 2 Log in the platform.

Step 3 Register device by adding the device serial number and verification code.

# Chapter 11 Backup

## 11.1 Manual Backup

**Purpose:**

Back up the videos stored on the device.

Step 1 Go to **Menu > Video Search**.



Figure 11-1 Video Search

Step 2 Select **Search Mode**.

- **General:** Normal videos
- **Event:** Motion detection, alarm, motion | alarm, motion&alarm videos.

Step 3 Select **Camera**.

Step 4 Select **Video Type**.

Step 5 Specify **Start Time** and **End Time**.

Step 6 Click **Search**. The matched videos will be displayed.

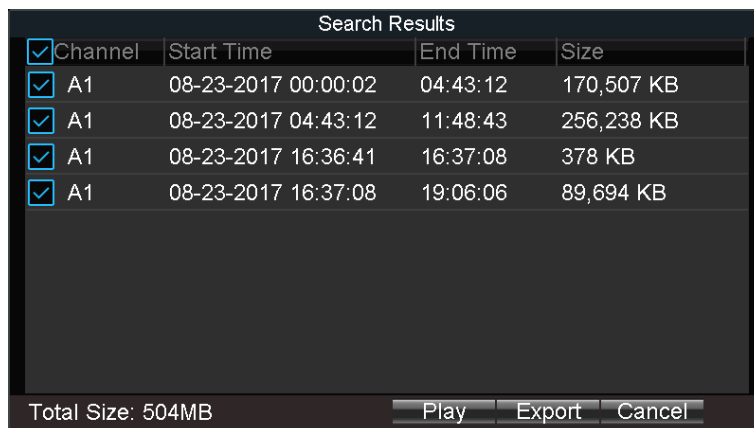

Figure 11-2 Search Result

Step 7 Select the videos and click **Export**.

## 11.2 Format Backup Device

### **Purpose:**

View the status and the free space/capacity of the connected backup device. And you can also format the backup device.

Step 1 Go to **Menu > Maintenance > Storage**.



Figure 11-3 Backup Device

Step 2 Select the **Backup Device**.

Step 3 View the **Status** and **Free Space/Capacity** of the backup device.

Step 4 Optionally, click **Format** to format the selected backup device.

## Chapter 12 Events and Alarms

### 12.1 Configure Motion Detection Alarm

**Purpose:**

When motion detection alarm is configured, once a motion event is detected, the device starts to record and multiple linkage actions will be triggered.

Step 1 Go to **Menu > Other Settings > Camera**.

Step 2 Click **Set** of **More Setting**.

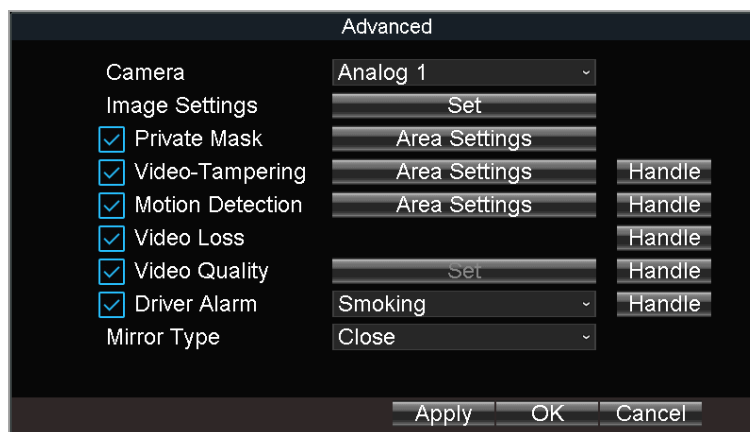

Figure 12-1 Motion Detection Settings

Step 3 Check **Motion Detection** to enable the function.

Step 4 Set the area for motion detection. For detailed steps, refer to *12.12 Configure Detection Area*.

Step 5 Set the arming schedule and alarm linkage actions. For detailed steps, refer to *12.11 Configure Arming Schedule and Linkage Actions*.

Step 6 Click **OK**.

### 12.2 Configure Alarm Input

**Purpose:**

Configure the settings for alarm input, including trigger level, arming schedule and alarm linkage actions, etc.

Step 1 Go to **Menu > Other Settings > Alarm In**.



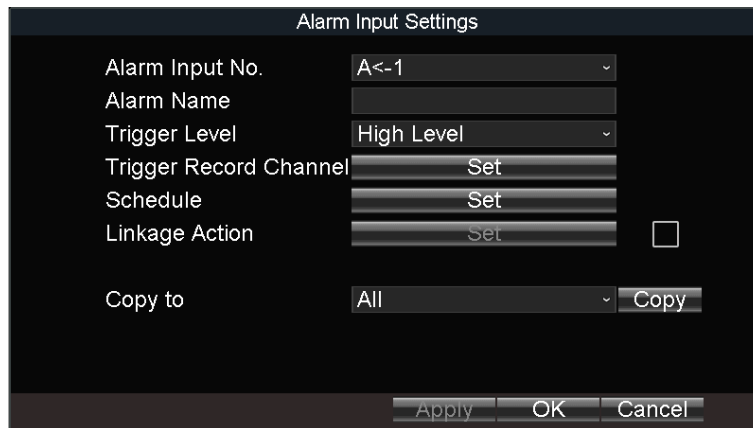

Figure 12-2 Alarm Input Settings

Step 2 Select **Alarm Input No.**

Step 3 Enter **Alarm Name.**

Step 4 Select **Trigger Level.**

- **High level:** 6 to 36 VDC.
- **Low level:** 0 to 5 VDC



NOTE

In order to avoid error caused by voltage fluctuation, no alarm will be triggered by voltage ranging from 5 VDC to 6 VDC.

Step 5 Click **Set** of **Schedule** to set arming schedule. For detailed steps, refer to *12.11 Configure Arming Schedule and Linkage Actions.*

Step 6 Check **Linkage Action** and click **Set** of Linkage Action to set the linkage actions. For detailed steps, refer to *12.11 Configure Arming Schedule and Linkage Actions.*

Step 7 Click **OK.**

## 12.3 Configure Alarm Output

### **Purpose:**

Configure the arming schedule, alarm duration time and alarm name for alarm output.

Step 1 Go to **Menu > Other Settings > Alarm Out.**

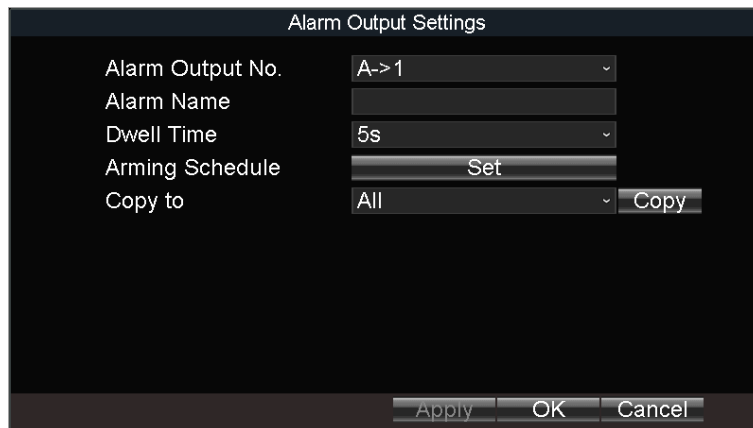

Figure 12-3 Alarm Output Settings

Step 2 Select **Alarm Output No.**

Step 3 Enter **Alarm Name.**

Step 4 Select **Dwell Time.**

- Dwell Time: Alarm output will keep alarming for the dwell time.

Step 5 Click **Set** of **Schedule** to set the arming schedule for alarm outputs. For detailed steps, refer to *12.11 Configure Arming Schedule and Linkage Actions.*

Step 6 Click **OK.**

## 12.4 Configure Alarm Terminal

Step 1 Go to **Menu > Other Settings > Alarm Terminal.**

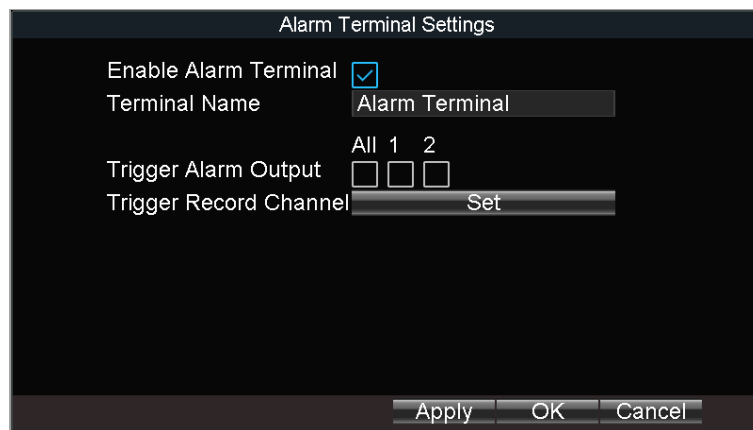

Figure 12-4 Alarm Terminal

Step 2 Check **Enable Alarm Terminal.**

Step 3 Edit the **Terminal Name.**

Step 4 Select the alarm outputs to trigger.

Step 5 Click **OK.**

## 12.5 Configure Video Loss Alarm

### **Purpose:**

When the device cannot receive video signal from the front-end devices, the video loss alarm will be triggered. Linkage actions, including audible warning and alarm output, can be set to respond.

Step 1 Go to **Menu > Other Settings > Camera**.

Step 2 Click **Set** of **More Setting**.

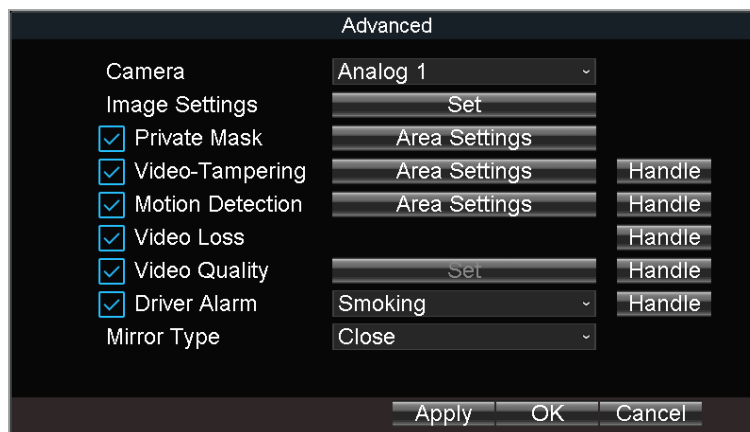

Figure 12-5 Video Loss

Step 3 Check **Video Loss**.

Step 4 Set arming schedule and linkage actions. For detailed steps, refer to *12.11 Configure Arming Schedule and Linkage Actions*.

Step 5 Click **OK**.

## 12.6 Configure Video Tampering Alarm

### **Purpose:**

A tampering alarm is triggered when the camera is covered and the monitoring area cannot be viewed. Linkage actions, including audible warning, alarm output, can be set to respond.

Step 1 Go to **Menu > Other Settings > Camera**.

Step 2 Click **Set** of **More Setting**.

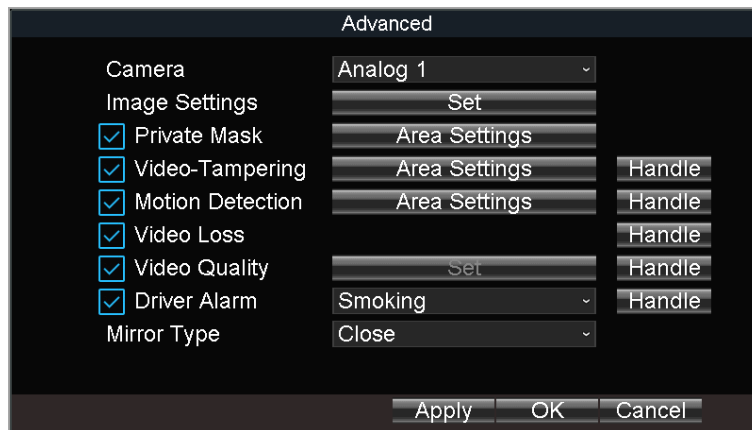

Figure 12-6 Video-Tampering

Step 3 Check **Tamper-proof**.

Step 4 Set area for video tampering detection. For detailed steps, refer to *12.12 Configure Detection Area*.



The video tampering alarm can be triggered only when the view of the camera is fully covered.

Step 5 Set arming schedule and linkage actions. For detailed steps, refer to *12.11 Configure Arming Schedule and Linkage Actions*.

Step 6 Click **OK**.

## 12.7 Configure Video Quality Diagnostics

### **Purpose:**

When your analog camera is out of focus, the linkage actions will be triggered.

Step 1 Go to **Menu > Other Settings > Camera**.

Step 2 Click **Set of More Setting**.

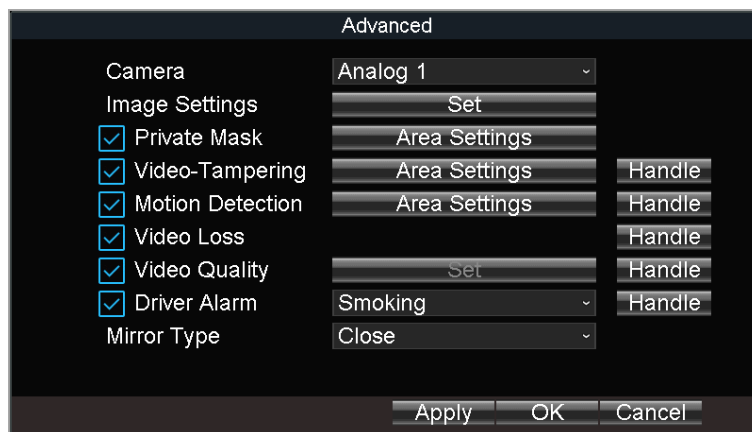

Figure 12-7 Video Quality Settings

Step 3 Check **Video Quality** to enable the function.

Step 4 Set arming schedule and linkage actions. For detailed steps, refer to *12.11 Configure Arming Schedule and Linkage Actions*.

Step 5 Click **OK**.

## 12.8 Configure Exception Alarm

### **Purpose:**

Configure alarms which are triggered by exceptions to take necessary actions in time.

Step 1 Go to **Menu > Other Settings > Exception**.

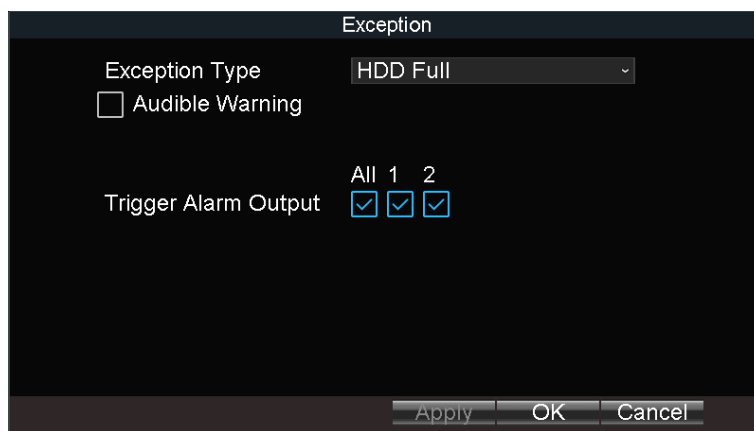

Figure 12-8 Exception

Step 2 Select **Exception Type** and set corresponding alarm linkage actions, including audible warning and alarm output.

Step 3 Click **OK**.

### **Info:**

Exception types include:

- **HDD Full:** The HDD is full.
- **HDD Error:** Writing HDD error, unformatted HDD, etc.
- **Network Disconnected:** Network cable is disconnected.
- **IP Conflicted:** Duplicated IP address.
- **Illegal Login:** Incorrect user ID or password.
- **Video Output Standard Mismatch:** I/O video standards do not match.
- **Abnormal Recording:** No space for saving recorded files.

## 12.9 Configure Satellite Positioning

### **Purpose:**

The built-in GNSS module supports GPS (Global Positioning System), enabling device positioning and speed limit alarm.

Step 1 Go to **Menu > Basic Settings > Position**.

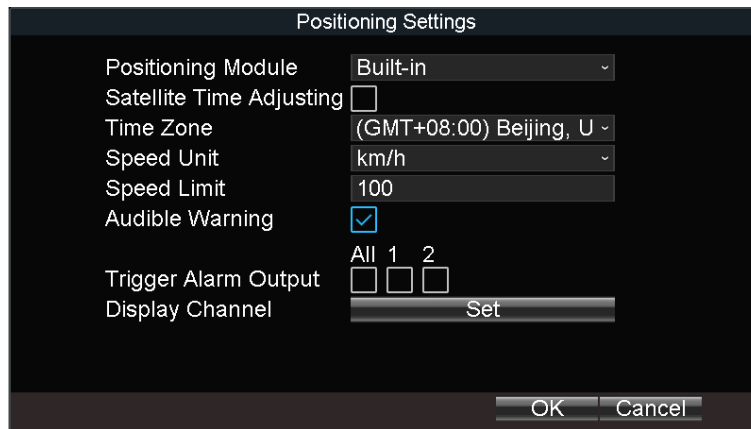

Figure 12-9 Position

Step 2 Select **Positioning Module**.

- **RS-232**: Obtain data from the satellite positioning module connected through RS-232 interface.
- **RS-485**: Obtain data from the satellite positioning module connected through RS-485 interface.
- **Built-in**: Obtain data from the satellite positioning module built in the mobile DVR.
- **Display Terminal**: Obtain data from display terminal.

Step 3 Check **Satellite Time Adjusting** and select your time zone.

Step 4 Select **Speed Unit** and input **Speed Limit**.

Step 5 Set the linkage action for speeding alarm, including **Audible Warning** and **Alarm Output**.

Step 6 Click **Set** of **Display Channel** and select display channels. The device positioning information will be displayed on the selected channels.

Step 7 Click **OK**.

Step 8 Optionally, go to **Menu > Status > Position** to view positioning status.

## 12.10 Configure G-Sensor Alarm

### **Purpose:**

G-Sensor detects and records acceleration information in 3-axial (X, Y, Z) directions.

### **Before you start:**

Connect an external sensor to the device for obtaining and providing the acceleration speed in 3-axial directions.

Step 1 Go to **Menu > Basic Settings > G-Sensor**.

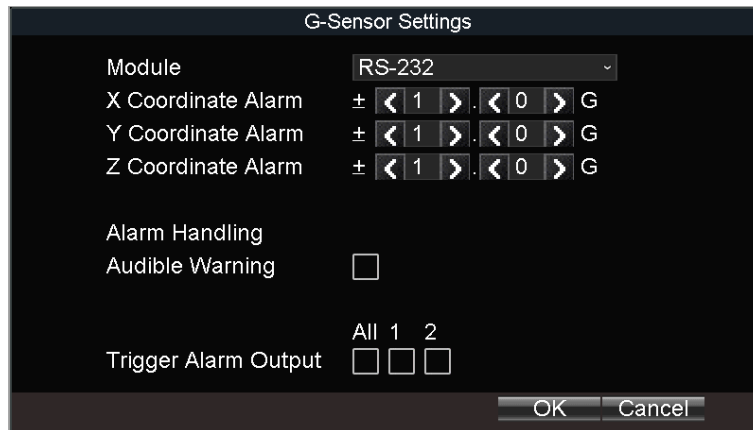

Figure 12-10 G-Sensor Settings

Step 2 Select your G-sensor mode under **Module**:

- **RS-232**: The G-sensor is connected to the mobile DVR through RS-232 interface.
- **Built-in**: The G-sensor is built in the mobile DVR.

Step 3 Set the limit value for acceleration alarm in X, Y and Z directions.



X, Y and Z represent the direction of acceleration and the unit of alarm value is G (G=9.8 m/s<sup>2</sup>).

Step 4 Set the linkage actions for acceleration alarm, including **Audible Warning** and **Alarm Output**.

Step 5 Click **OK**.

Step 6 Optionally, go to **Menu > Status > G-sensor** to view the G-sensor status.

## 12.11 Configure Arming Schedule and Linkage Actions

Step 1 Click **Handle** to set the arming schedule and alarm linkage actions.

Step 2 Select the day from **Arming Schedule** dropdown list.

Step 3 Set the arming period for selected day.

Step 4 (Optional) Copy the current settings to other days in the week.

Step 5 Check to enable linkage actions.

- **Full Screen Monitoring**

When an alarm is triggered, the local monitor displays the video image from the alarming channel configured for full screen monitoring.

- **Audible Warning**

Trigger an audible *beep* when an alarm is detected.

- **Trigger Alarm Output**

Trigger an alarm output when an alarm is detected.

Step 6 Click **OK**.

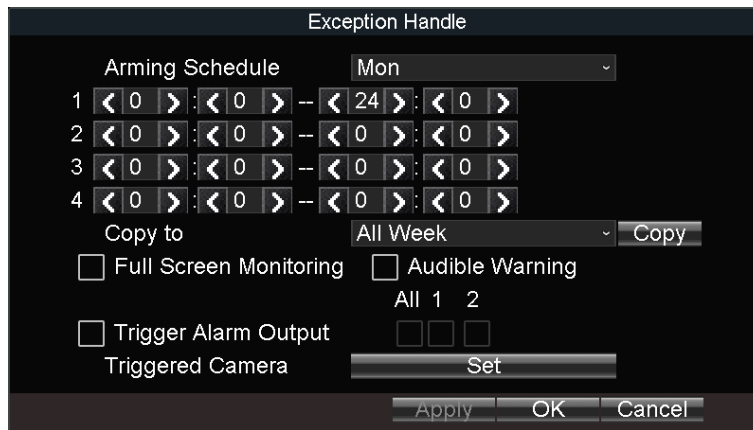

Figure 12-11 Linkage Action

## 12.12 Configure Detection Area

Step 1 Click **Area Settings**.

Step 2 Draw to draw detection area.

Step 3 Optionally, right click to delete areas or set detection sensitivity.

Step 4 Right click and select **Exit**.



# Chapter 13 User Account Management

## 13.1 Add User

### **Purpose:**

Add and delete users, and modify the password and permission of users.

Step 1 Go to **Menu > Other Settings > User**.

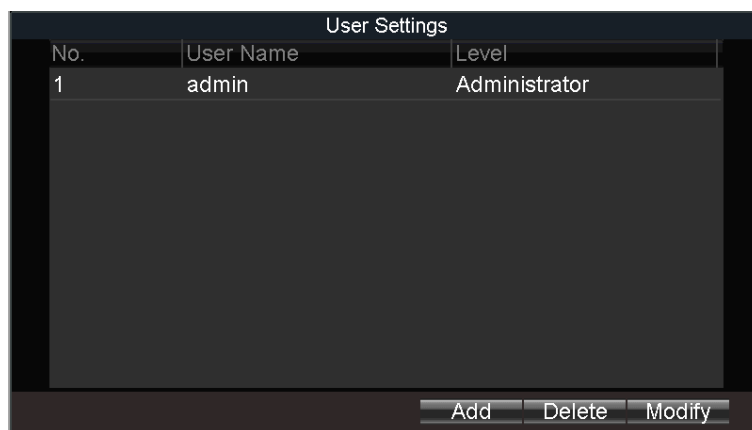

Figure 13-1 User Management

Step 2 Click **Add**.

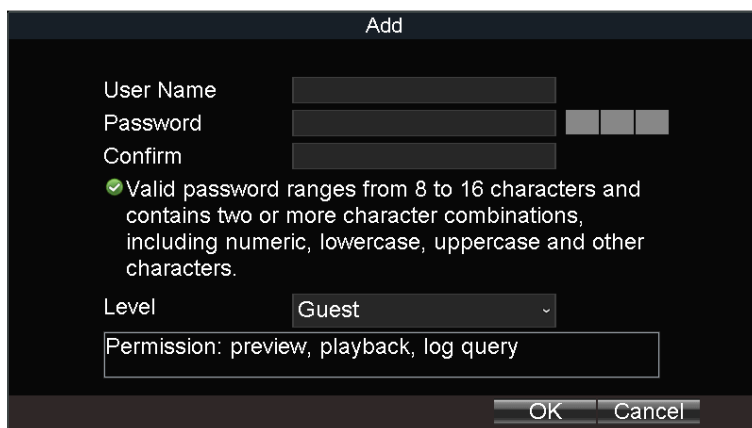

Figure 13-2 Add User

Step 3 Enter **User Name** and **Password** and enter the same password in **Confirm**.

Step 4 Select the user permission level.

- **Operator:** The operator has permissions for Preview, Playback, Backup, Log Search and Parameters Settings.
- **Guest:** The Guest has permissions for Preview, Playback, Backup and Log Search.

Step 5 Click **OK**.

## 13.2 Delete User

Step 1 Go to **Menu > Other Settings > User**.

Step 2 Select a user and click **Delete**.

Step 3 Click **Yes** in confirmation message box.

## 13.3 Edit User

Step 1 Go to **Menu > Other Settings > User**.

Step 2 Select a user and click **Modify**.

Step 3 Edit parameters as required.

Step 4 Click **OK**.

## Chapter 14 General System Configuration

### 14.1 Configure Basic Display Settings

**Purpose:**

Set system time, select CVBS output standard, enable password and configure DST settings, etc.

Step 1 Go to **Menu > Other Settings > Display**.



The system language is set as **English** by default and is not editable.

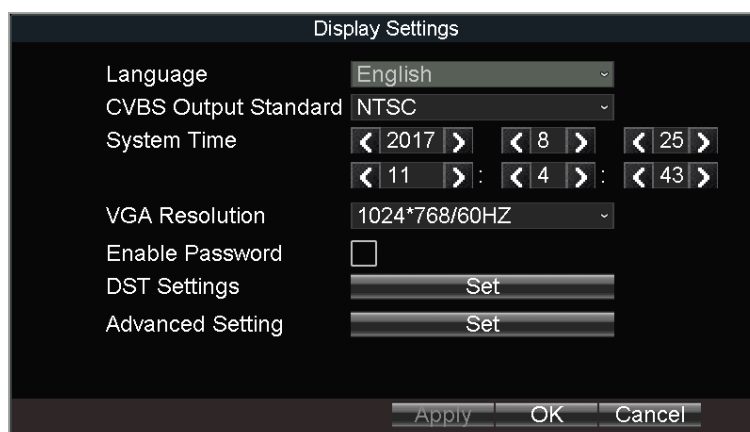

Figure 14-1 Display Settings

Step 2 Edit parameters as required.

- **CVBS Output Standard:** NTSC or PAL are selectable. Set it according to actual video input standard.
- **System Time:** Set it by adjusting year, month, day, hour, minute, and second.
- **VGA Resolution:** Specify the VGA output resolution.
- **Enable Password:** Check it to enable authentication before operations.

Step 3 Click **OK**.

### 14.2 Configure DST Settings

**Purpose:**

Configure DST (Daylight Saving Time) settings for the system.

Step 1 Go to **Menu > Other Settings > Display**.

Step 2 Click **Set** of **DST Settings**.

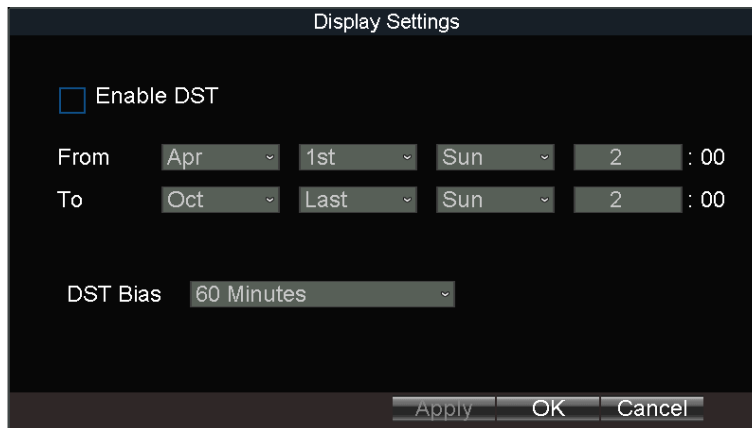

Figure 14-2 DST Settings

Step 3 Check **Enable DST**.

Step 4 Set the start time and end time for DST.

Step 5 Select **DST bias**.

Step 6 Click **OK** in DST settings interface.

Step 7 Click **OK** in Display Settings.

## 14.3 Configure NTP

Step 1 Go to **Menu > Basic Settings > Network**.

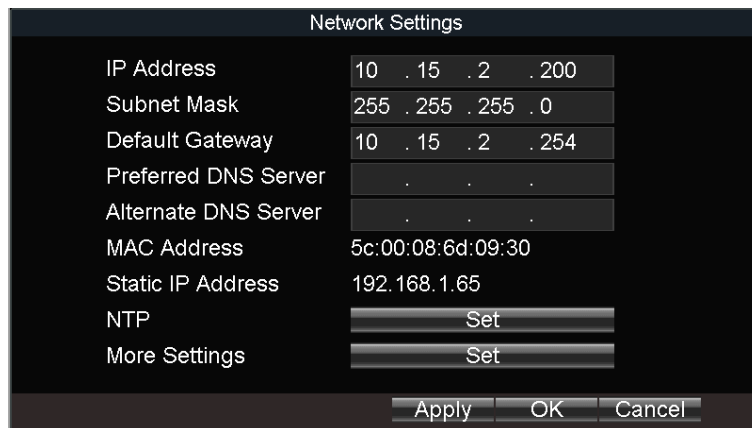

Figure 14-3 Local Network Settings

Step 2 Click **Set** of **NTP**.

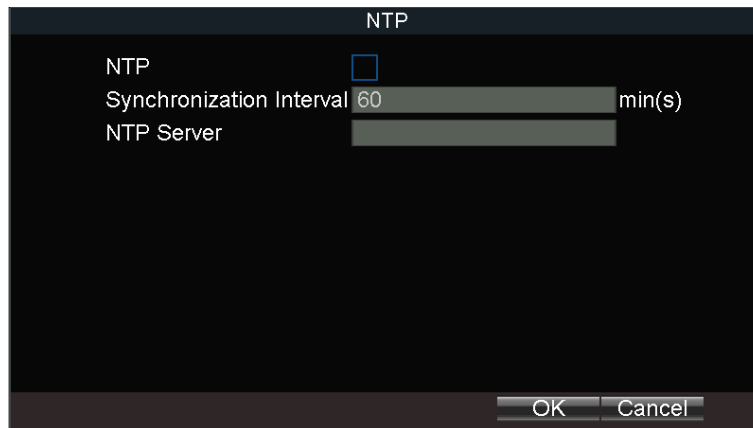

Figure 14-4 NTP Settings

Step 3 Check **NTP** to enable the function.

Step 4 Enter **Synchronization Interval**.

Step 5 Enter the IP address of **NTP server**.

Step 6 Click **OK** in NTP settings interface.

Step 7 Click **OK** in network settings interface.

## 14.4 Configure Advanced Display Settings

### **Purpose:**

You can set the system time, select the CVBS output standard, enable the password, configure the DST settings, etc.

Step 1 Go to **Menu > Other Settings > Display**.

Step 2 Click **Set** of **Advanced Settings**.

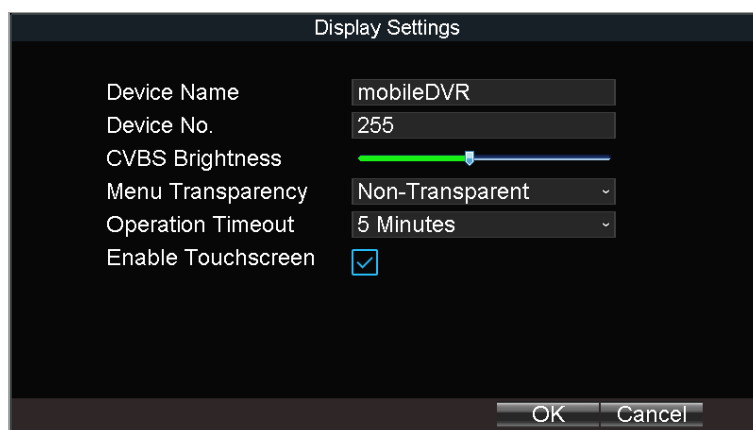

Figure 14-5 Advanced Settings

Step 3 Edit parameters as required.

- **Device Name:** Enter the system name as desired.

- **Device No.:** Edit the device No. for remote control. The device No. ranges from 1 to 255. The default device No. is 255.



It is not recommended to modify **Device No.** Otherwise, you need to enter the Device No. on the remote control every time you use it.

- **CVBS Brightness:** Adjust video output brightness.
- **Menu Transparency:** The transparency proportion of the menu displayed on the live view interface. You can set it as **1:3**, **1:1**, **3:1**, or **Non-transparent**. The smaller the proportion value is, the more transparent the menu is. When **Non-transparent** is selected, only the menu is displayed on the page.
- **Operation Timeout:** If no operation is performed after a specified period of time, live view will be displayed automatically.
- **Enable Touch Screen:** Enable/disable touch screen. If the function is on, PTZ function is unavailable.

Step 4 Click **OK**.

## Chapter 15 Maintenance

### 15.1 Check Status

Go to **Menu > Status** to view status of recording, 3G/4G, platform, satellite positioning, G-Sensor, alarm, and WiFi.

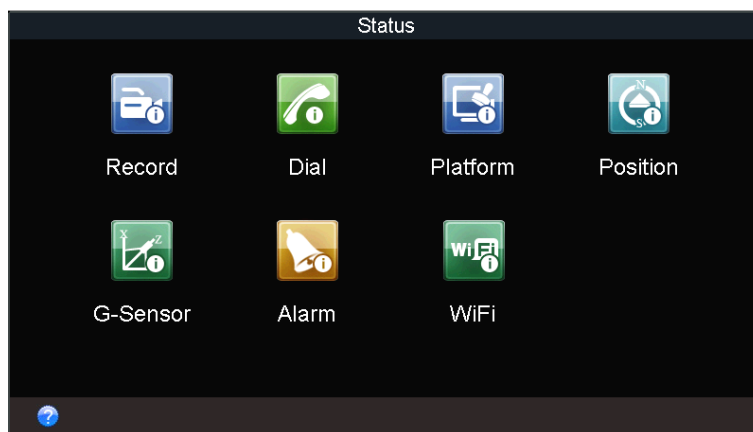

Figure 15-1 Status Interface

### 15.2 View System Information

Go to **Menu > Maintenance > Information** to view the device name, model, serial No., firmware version, encoding version, and panel version.



Figure 15-2 System Information

### 15.3 Upgrade the System

**Purpose:**

The device can be upgraded by local USB flash disk or remote FTP server.

## 15.3.1 Upgrade by Local USB Flash Disk

### **Before you start:**

Connect the USB device that contains the upgrade firmware.



The upgrade firmware should be stored in the root directory of the USB device.

Step 1 Go to **Menu > Maintenance > Upgrade**.

Step 2 Select **Upgrade Type** as **USB Upgrade**.

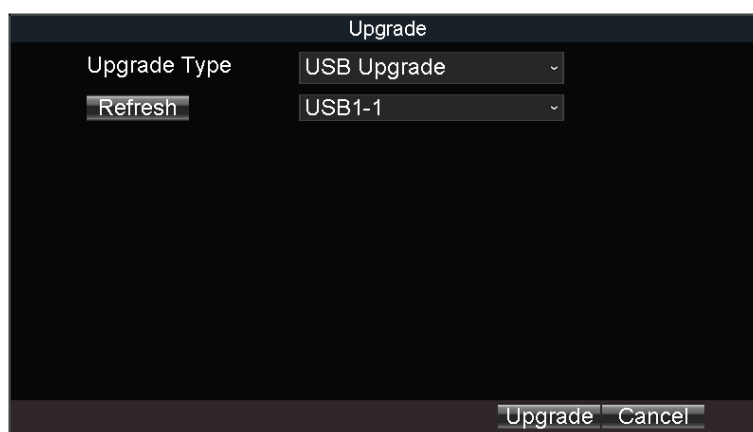

Figure 15-3 Upgrade Interface

Step 3 Click **Upgrade** to start upgrading and reboot the device to activate the new settings.

## 15.3.2 Upgrade by Remote FTP server

### **Before you start:**

Ensure the network connection of the PC (running FTP server) and the DVR is valid and correct. Run the FTP server on the PC and copy the firmware into the corresponding directory of your PC.



Refer to the user manual of the FTP server to set the FTP server on your PC and put the firmware file into the directory as required.

Step 1 Go to **Menu > Maintenance > Upgrade**.



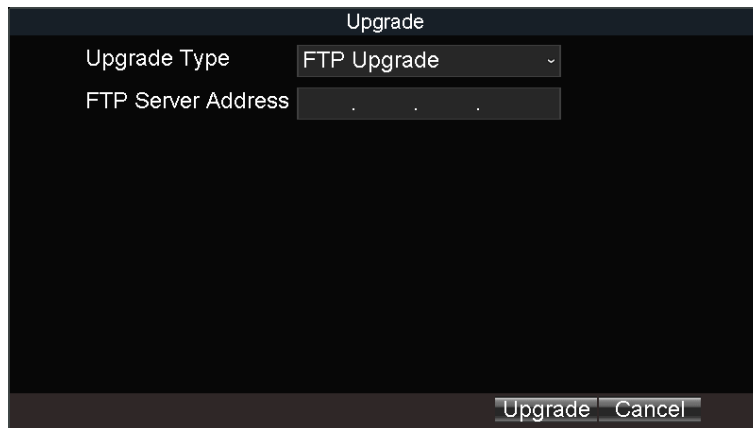

Figure 15-4 Upgrade Interface

Step 2 Select **Upgrade Type** as **FTP Upgrade**.

Step 3 Enter **FTP Server Address**.

Step 4 Click **Upgrade** to start upgrading and reboot the device to activate the new settings.

## 15.4 Log Operation

### 15.4.1 View Log Files

**Purpose:**

The operation, alarm, exception and information of the device can be stored in log files, which can be viewed and exported at any time.

Step 1 Go to **Menu > Maintenance > Log Search**.

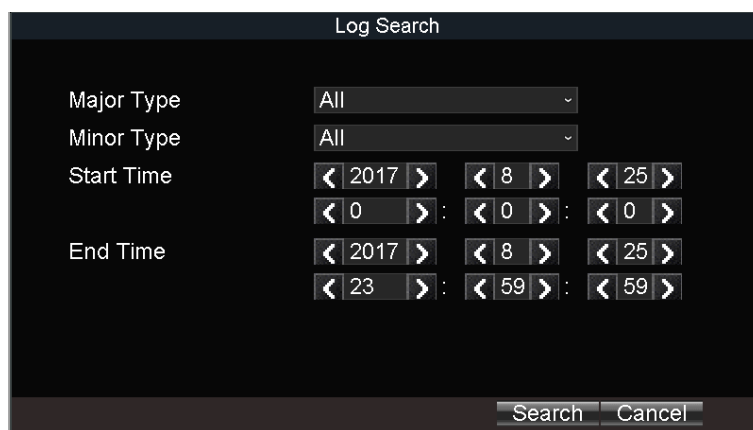

Figure 15-5 Log Search Interface

Step 2 Select the **Major Type** and **Minor Type** of the logs.

Step 3 Specify the **Start Time** and **End Time** for the log search.

Step 4 Click **Search**. The matched logs will be displayed.

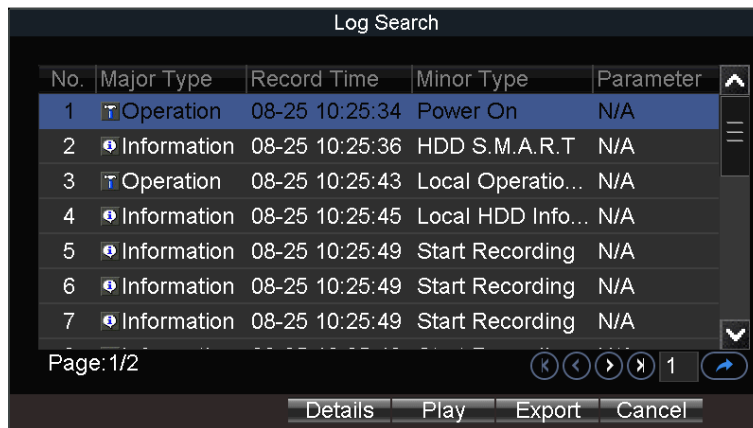

Figure 15-6 Log Search

## 15.4.2 Export Log Files

### **Purpose:**

The operation, alarm, exception and information of the device can be stored in log files, which can be viewed and exported at any time.

### **Before you start:**

Connect a backup device to the device.

Step 1 Go to **Menu > Maintenance > Log Search**.

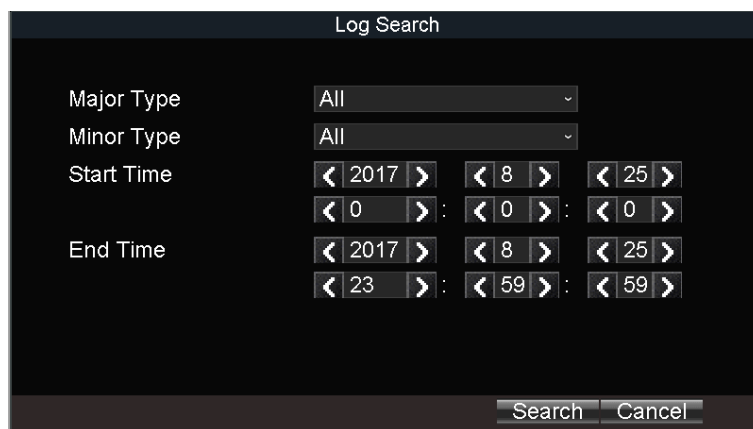

Figure 15-7 Log Search Interface

Step 2 Search log files. For detailed steps, refer to [15.4.1 View Log Files](#).

Step 3 Click **Export**.

## 15.5 Restoring Default Settings

Step 1 Go to **Menu > Maintenance > Default**.

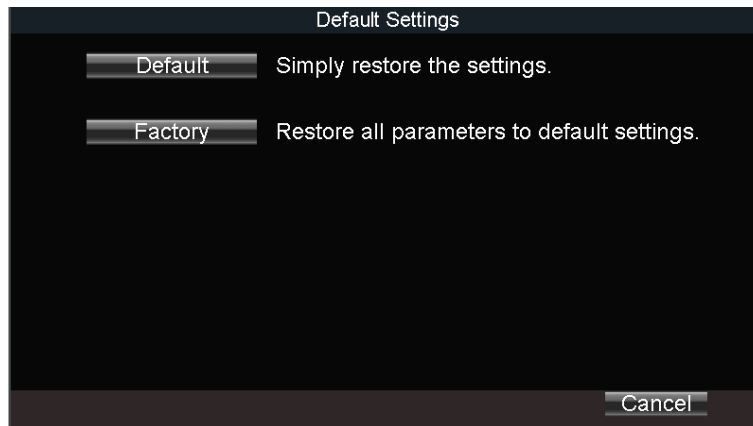

Figure 15-8 Restore Default Settings

Step 2 Select the restoring type from the following two options.

- **Default:** Restore all parameters, except the network (including IP address, subnet mask, gateway, MTU, NIC working mode, default route, server port, etc.) and user account parameters, to the factory default settings.
- **Factory:** Restore all parameters to the factory default settings.

Step 3 Click **OK** and click **Yes** in confirmation message box.

## 15.6 Import/Export Configuration Files

### 15.6.1 Import Configuration Files

#### **Purpose:**

The configuration files of one device can be imported to multiple device devices if they are to be configured with the same parameters.

#### **Before you start:**

Connect a backup device that contains the configuration file to the device. The configuration file should be stored on the root directory of the backup device.

Step 1 Go to **Menu > Maintenance > Configuration**.

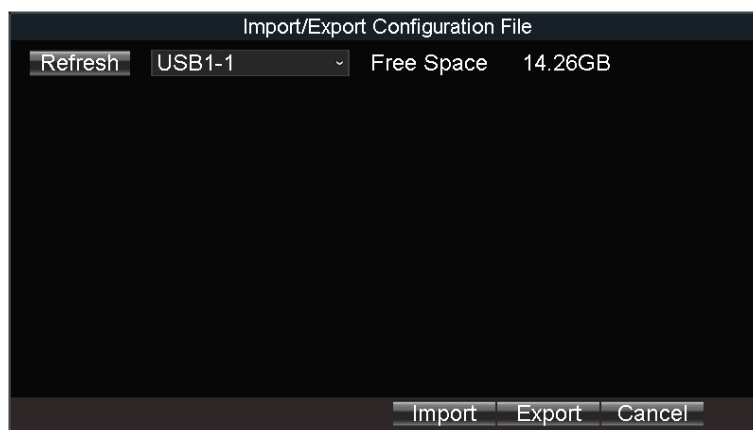

Figure 15-9 Import/Export Configuration Files

Step 2 Click **Import** and click **Yes** on confirmation message box.

## 15.6.2 Export Configuration Files

### **Purpose:**

The configuration files of the device can be exported to local device for backup.

### **Before you start:**

Connect a USB storage device to the mobile DVR.

Step 1 Go to **Menu > Maintenance > Configuration**.

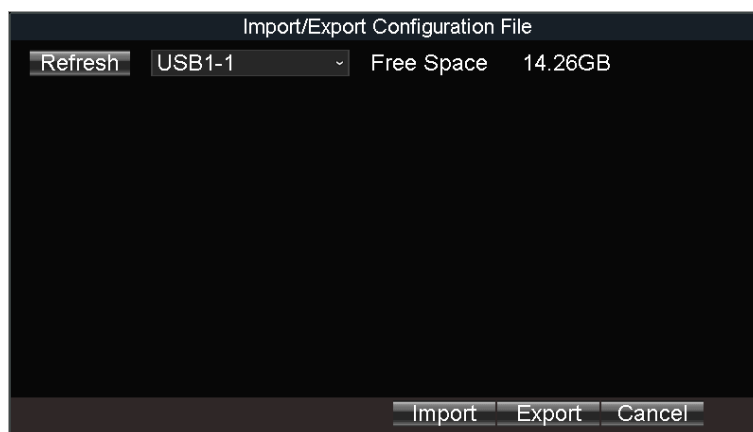

Figure 15-10 Import/Export Configuration Files

Step 2 Click **Export**.

## 15.7 Serial Port Settings

### **Purpose:**

Two types of serial ports are provided: RS-232 and RS-485.

The RS-232 port can be used in two ways:

- **Parameters Configuration:** Connect a PC to the DVR through the PC serial port. DVR parameters can be configured by using software such as HyperTerminal. The serial port parameters must be the same as of the device when connecting with the PC serial port.
- **Transparent Channel:** Connect a serial device directly to the device. The serial device will be controlled remotely by the PC through the network and the protocol of the serial device. If alarm button is connected, select RS-232 usage as Transparent Channel.

The RS-485 port can be used for transparent channel only.

Step 1 Go to **Menu > Basic Settings > Serial Port**.

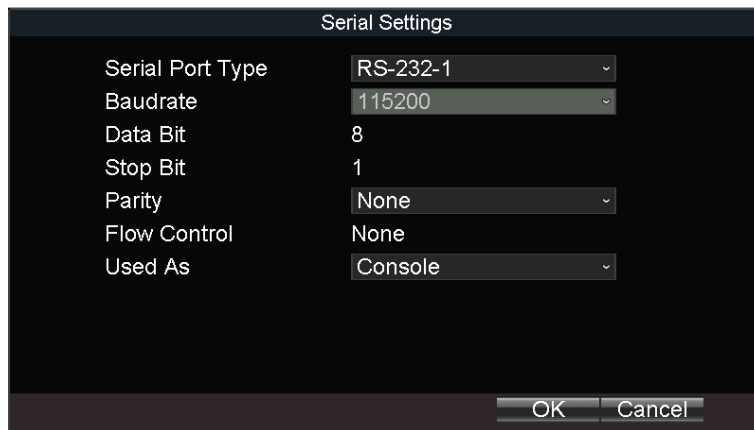

Figure 15-11 Serial Port Settings Interface

Step 2 Edit parameters as required.

Step 3 Click **OK**.

## Chapter 16 Shut Down Device

### 16.1 Enable Scheduled Startup/Shutdown

**Purpose:**

Set the scheduled startup/shutdown. The device will automatically start up/shut down according the schedule.

Step 1 Go to **Menu > Basic Settings > Start**.

Step 2 Select **Startup/Shutdown Mode** as **Scheduled Startup/Shutdown**.

Step 3 Select the **Date** to set the schedule.

Step 4 Specify the startup time segments. Two periods can be configured for each day. And the time periods cannot be overlapped each other.

Step 5 Optionally, select **Copy Date** and click **Copy** to copy the settings to the selected day.

Step 6 Click **OK**.

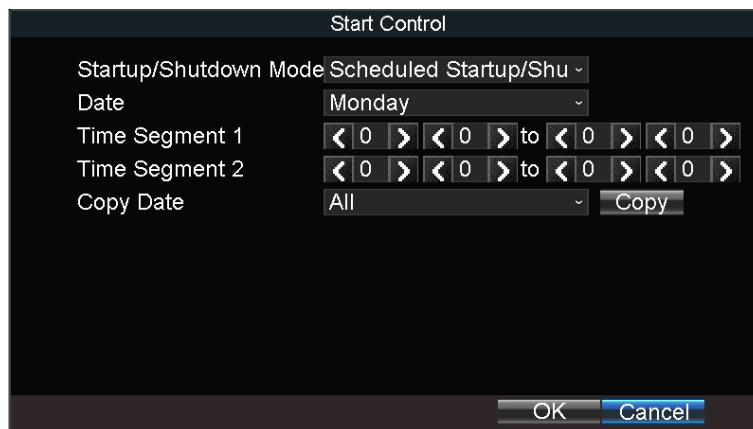

Figure 16-1 Scheduled Startup/Shutdown

### 16.2 Enable Halt Delay

**Purpose:**

You can set the shutdown delay time (Vehicle Ignition Startup and Shutdown) for the device.

Step 1 Go to **Menu > Basic Settings > Start**.

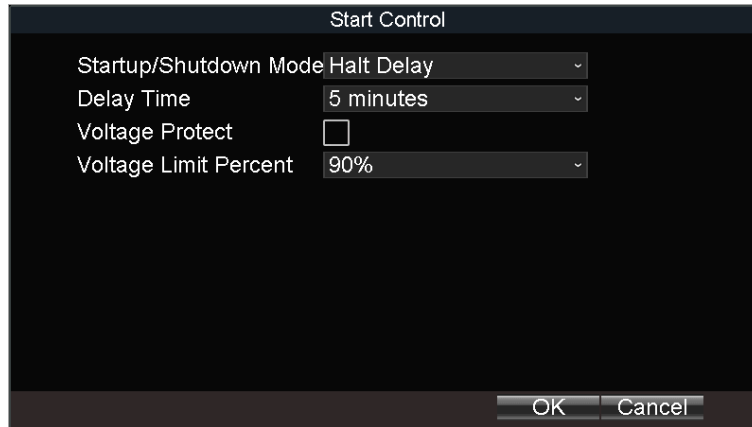

Figure 16-2 Start Control

Step 2 Select **Startup/Shutdown Mode** as **Halt Delay**.

Step 3 Select the Delay Time. The delay time ranges from 0 to 6 hours.

Step 4 Optionally, check **Voltage Protect** and select **Voltage Limit Percent**. If the voltage of the device reaches the selected threshold, the device will shut down automatically.

Step 5 Click **OK**.

## 16.3 Reboot DVR

Step 1 Go to **Menu > Maintenance > Reboot**.

Step 2 Click Reboot and click **Yes** on confirmation message box to reboot the device.

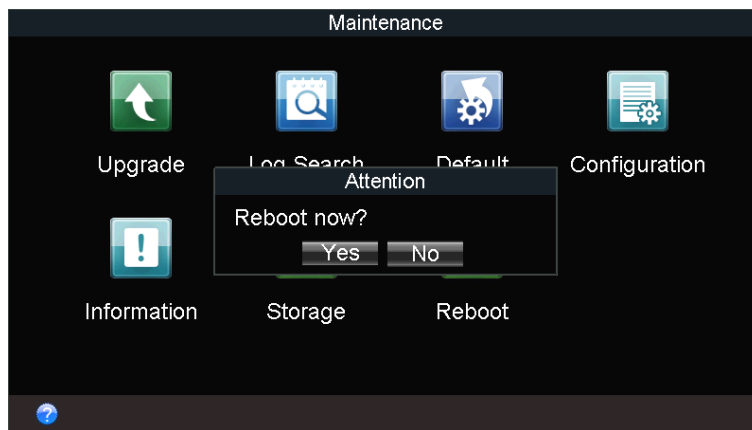

Figure 16-3 Reboot

# Chapter 17 Appendix

## 17.1 Glossary

- **3G/4G:** 3G/4G refers to the 3rd/4th-generation telecommunication technology which is the high speed transmission of the cell data. The 3G/4G service can transmit sound and other data simultaneously and the bitrate is up to hundreds kbps.
- **DHCP:** DHCP is the acronym of Dynamic Host Configuration Protocol, and it is one of the TCP/IP protocol stacks, it is used to assign the dynamic IP address to the host on the network.
- **Dual Stream:** Dual stream is a technology used to record high resolution video locally while transmitting a lower resolution stream over the network.
- **GNSS:** A satellite navigation system is a system of satellites that provide autonomous geo-spatial positioning with global coverage. It allows small electronic receivers to determine their location (longitude, latitude, and altitude) to high precision (within a few meters) using time signals transmitted along a line of sight by radio from satellites. The signals also allow the electronic receivers to calculate the current local time to high precision, which allows time synchronization. A satellite navigation system with global coverage may be termed GNSS (Global Navigation Satellite System).
- **GPS:** GPS (Global Positioning System) is a space-based global navigation satellite system that provides location and time information in all weather and anywhere on or near the earth, where there is an unobstructed line of sight to 4 or more GPS satellite.
- **G-Sensor:** G-sensor (Gravity-sensor) can sense the change of the accelerated force, such as the shaking, free falling and lifting. And those changes of the accelerated force can be sensed by the G-sensor in a means of electrical signals, and then link certain action according to the changes of the electrical signals. When applied in the hard disk protection, G-Sensor can check the current status of the hard disk in case of the affection of the R/W function by the sudden change of the accelerated force.
- **NTP:** NTP is Network Time Protocol, and it is a protocol used to synchronize the computer time.
- **Sensor-In:** Sensor-In is a built-in module on the mobile DVR used to record the movement information of the vehicle, such as the braking, left-turning and right-turning and so on. The information can be used for analysis of an accident.
- **Transparent Channel:** Transparent channel is a mechanism which analyzes the IP datagram and sends it by the serial interface. It extends the control distance of the serial devices and for the user, only the point to point transmission is seen and the actual transmission is ignored.
- **VPDN:** Virtual Private Dial-up Network is a network that uses primarily public telecommunication infrastructure, such as the internet, to provide remote office or travelling users' access to a central organization network, such as the ISP private network, financial network and so on.



- **Wi-Fi:** Wi-Fi is a mechanism of the wireless connecting electronic devices. A device enabled with Wi-Fi such as PC, video game console, can connect to the internet via a wireless network access point.

## 17.2 FAQ

- **Why does my DVR make a beeping sound after booting?**

The possible reasons for the warning beep on the device are as follows:

- a) There is no HDD installed in the device.
- b) The HDD is not initialized.
- c) HDD error

To cancel the beeping sound and use the device without HDD, enter the Exception Settings interface.

- **DVR fails to start up after connecting the power.**

Possible reasons:

- a) Incorrect voltage input (6 ~ 36 VDC) and power consumption ( $\geq 50W$ ).
- b) The HDD lock is not closed.
- c) The power connections are incorrect.
- d) The motherboard or power functions abnormally. In case of hardware failure, please contact the supplier of the product.

- **Fail to connect 3G/4G.**

Possible reasons for 3G/4G connection failure are as follows:

- a) Dialing is not enabled.
- b) APN, dial number, user name and password should be set for 3G/4G VPDN private network.
- c) No 3G/4G antenna connected. When both the master/slave antennas are connected, locate them vertically with above 20cm distance from each other.
- d) SIM card is out of service or 3G/4G service is not opened.

- **Fail to connect to Wi-Fi.**

Please check the following settings:

- a) The SSID, encryption type or password are entered incorrectly.
- b) AP (access point) or router works abnormally.
- c) No Wi-Fi antenna connected or the antenna is not vertically located.

- **The DVR cannot be accessed via platform (iVMS) after successful connection to 3G/4G or Wi-Fi.**

Possible reasons:

- a) The parameters (e.g., server IP, device registered ID, etc.) of the platform are configured incorrectly.
- b) The platform works abnormally.

- **Fail to obtain satellite positioning information.**

Possible reasons:

- a) The satellite positioning antenna is not placed outdoor.
- b) There is no satellite positioning module (built-in or external) available for the DVR.
- c) The **Position Module** is configured incorrectly.

- **Why does the device seem unresponsive when operating with the IR remote control?**

- a) The batteries are installed correctly, making sure that the polarities of the batteries are not reversed.
- b) The batteries are fresh and are not out of power.
- c) The remote sensor is not covered or blocked by other object.
- d) There are no fluorescent lamps in use nearby.

- **No backup device is detected when exporting recorded files?**

Possible reasons:

- a) There is no backup device connected with the DVR.
- b) The DVR and your backup device are not compatible.
- c) Initialize the backup device before using.
- d) The backup device is damaged.

## 17.3 Remote Control

### ***Purpose:***

The device can be controlled via IR remote control and mouse.

### 17.3.1 Buttons Description

#### ***Before you start:***

Batteries (2×AAA) must be installed before operation.

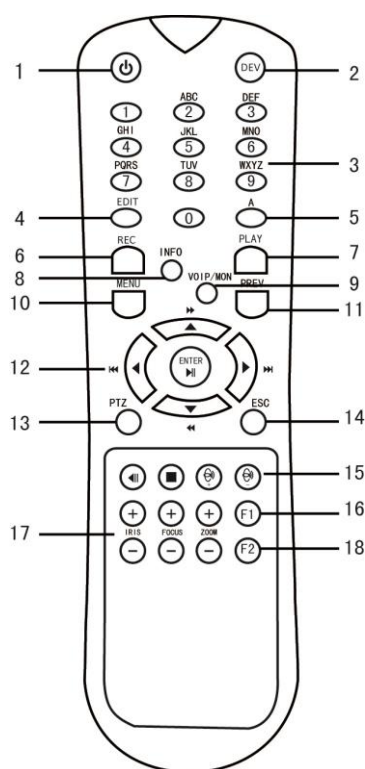

Figure 17-1 Remote Control

Table 17-1 Description of the IR Remote Control Buttons

No.	Name	Description
1	Power	Reserved
2	DEV	Input device number.
3	Number keys	Input number, symbol, and character. Switch to the corresponding channel in Live View mode.
4	Edit	Enter the edit status, and then delete the character in the front of the cursor. It can also be used to <i>tick</i> checkbox. In Playback mode, it can be used to generate video clips for backup.
5	A	Switch between input methods (Number, English, symbol) when in the edit status.
6	REC	Reserved
7	PLAY	Enter video search interface.
8	INFO	Reserved

9	VOIP/MON	Reserved
10	MENU	Enter Main menu interface.
11	PREV	Switch between single screen and multi-screen mode.
12	DIRECTION Buttons	Up, Down, Left, Right The DIRECTION buttons are used to navigate between different fields and items in menus. In the playback interface, they are used for fast forward, slow forward, rewind. In Live View mode, these buttons can be used to switch channel(s).
	ENTER	The ENTER button is used to confirm selection in any of the menu modes. It can also be used to <i>tick</i> checkbox. In Playback mode, it can be used to play or pause the video. In Auto-switch mode, it can be used to stop /start auto switch.
13	PTZ	Reserved
14	ESC	Back to the previous menu.
15	RESERVED	Reserved for future use.
16	F1	In video search interface, it can be used to select all record files.
17	PTZ Control Buttons	Buttons to adjust the iris, focus and zoom of a PTZ camera.
18	F2	Reserved

## 17.3.2 Operation Introduction

### **Purpose:**

In this chapter we will describe the operation via IR remote control about general steps in the following chapters.

### **Before you start:**

- Batteries are installed correctly and the polarities of the batteries are not reversed.
- Batteries are fresh and not out of charge.

- IR receiver is not obstructed.

Step 1 Go to **Menu > Other Settings > Display**.

Step 2 Click Set of Advanced Settings.

Step 3 Edit device number. The default number is 255.

Step 4 Press DEV on the remote control.

Step 5 Enter the device number.

Step 6 Press ENTER on the remote control.

Step 7 Refer to Table 17-2 for detailed operations.

Table 17-2 Remote Control Operations

Operation	Detailed Steps
Enter some contents in a text field.	Press Left/Right to position the cursor in the text field. Press Enter to edit. Press Edit to delete the previous content. Press A to switch input method. Press the numeric buttons to enter numbers, symbols, or characters. Press Enter to finish entering.
Click a button.	Press Left/Right to position the cursor in the checkbox. Press Enter to click the button.
Check the checkbox of a button.	Press Left/Right to position the cursor in the checkbox. Press Enter/Edit to check the checkbox.
Select an item from an option dropdown list.	Press Left/Right to position the cursor in the option. Press Enter to pop up dropdown list. Press Up/Down to select an item. Press Enter to select it.

### 17.3.3 Troubleshooting

**Purpose:**

If there is no response after you press any button on the remote, follow the procedure below to troubleshoot.

Step 1 Go to **Menu > Other Settings > Display**

Step 2 Click **Set** of **Advanced Settings**.

Step 3 Edit device number. The default number is 255.

Step 4 Press **DEV** on the remote control.

Step 5 Enter the device number.

Step 6 Press **ENTER** on the remote control.

### 17.3.4 Set Areas with Remote Control

Step 1 Click the **Area Settings** button.

Step 2 Press the **Edit** key on the remote control and a red block appears on the screen.

Step 3 Press the **Direction** keys on the remote control to adjust the position of the red block.

Step 4 Press the **Enter** key on the remote control to save the position of the red block.

Step 5 Press the **Direction** keys on the remote control to adjust the size of the block.

Step 6 Press the **Enter** key on the remote control to save the size of the block.

Step 7 Press the **Menu** key on the remote control to set the detection sensitivity. You can set the level as 1~6 or off. Click **OK** to save the settings.

Step 8 You can press the **A** key on the remote control to clear all the mask areas.

Press the **Enter** key on the remote control to save the settings and then press **Esc** key to exit.



First Choice for Security Professionals

UD07482B

[www.hikvision.com](http://www.hikvision.com)