

**HIKVISION**

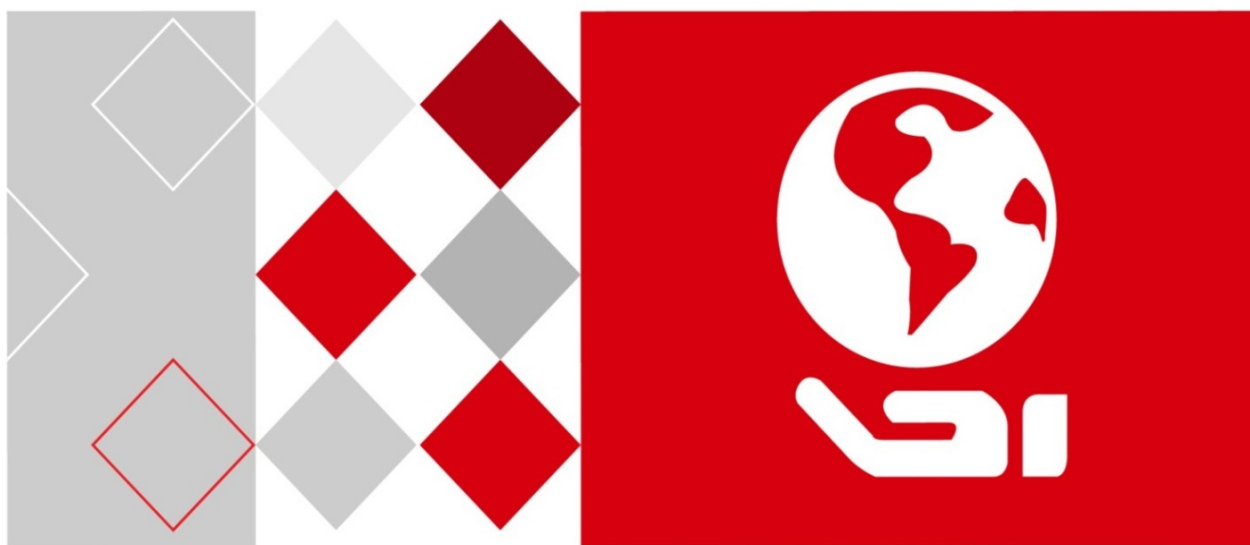

DS-3WF01C-2N

User Manual

## **User Manual**

COPYRIGHT ©2016 Hangzhou Hikvision Digital Technology Co., Ltd.

### **ALL RIGHTS RESERVED.**

Any and all information, including, among others, wordings, pictures, graphs are the properties of Hangzhou Hikvision Digital Technology Co., Ltd. or its subsidiaries (hereinafter referred to be “Hikvision”). This user manual (hereinafter referred to be “the Manual”) cannot be reproduced, changed, translated, or distributed, partially or wholly, by any means, without the prior written permission of Hikvision. Unless otherwise stipulated, Hikvision does not make any warranties, guarantees or representations, express or implied, regarding to the Manual.

### **About this Manual**

This Manual is applicable to DS-C10S-SXXT Series Video Wall Controller.

The Manual includes instructions for using and managing the product. Pictures, charts, images and all other information hereinafter are for description and explanation only. The information contained in the Manual is subject to change, without notice, due to firmware updates or other reasons. Please find the latest version in the company website (<http://overseas.hikvision.com/en/>).

Please use this user manual under the guidance of professionals.

### **Trademarks Acknowledgement**

**HIKVISION** and other Hikvision’s trademarks and logos are the properties of Hikvision in various jurisdictions. Other trademarks and logos mentioned below are the properties of their respective owners.

### **Legal Disclaimer**

TO THE MAXIMUM EXTENT PERMITTED BY APPLICABLE LAW, THE PRODUCT DESCRIBED, WITH ITS HARDWARE, SOFTWARE AND FIRMWARE, IS PROVIDED “AS IS”, WITH ALL FAULTS AND ERRORS, AND HIKVISION MAKES NO WARRANTIES, EXPRESS OR IMPLIED, INCLUDING WITHOUT LIMITATION, MERCHANTABILITY, SATISFACTORY QUALITY, FITNESS FOR A PARTICULAR PURPOSE, AND NON-INFRINGEMENT OF THIRD PARTY. IN NO EVENT WILL HIKVISION, ITS DIRECTORS, OFFICERS, EMPLOYEES, OR AGENTS BE LIABLE TO YOU FOR ANY SPECIAL, CONSEQUENTIAL, INCIDENTAL, OR INDIRECT DAMAGES, INCLUDING, AMONG OTHERS, DAMAGES FOR LOSS OF BUSINESS PROFITS, BUSINESS INTERRUPTION, OR LOSS OF DATA OR DOCUMENTATION, IN CONNECTION WITH THE USE OF THIS PRODUCT, EVEN IF HIKVISION HAS BEEN ADVISED OF THE POSSIBILITY OF SUCH DAMAGES.

REGARDING TO THE PRODUCT WITH INTERNET ACCESS, THE USE OF PRODUCT SHALL BE WHOLLY AT YOUR OWN RISKS. HIKVISION SHALL NOT TAKE ANY RESPONSIBILITIES FOR ABNORMAL OPERATION, PRIVACY LEAKAGE OR OTHER DAMAGES RESULTING FROM CYBER ATTACK, HACKER ATTACK, VIRUS INSPECTION, OR OTHER INTERNET SECURITY RISKS; HOWEVER, HIKVISION WILL PROVIDE TIMELY TECHNICAL SUPPORT IF REQUIRED.

SURVEILLANCE LAWS VARY BY JURISDICTION. PLEASE CHECK ALL RELEVANT LAWS IN YOUR JURISDICTION BEFORE USING THIS PRODUCT IN ORDER TO ENSURE THAT YOUR USE CONFORMS THE APPLICABLE LAW. HIKVISION SHALL NOT BE LIABLE IN THE EVENT THAT THIS PRODUCT IS USED WITH ILLEGITIMATE PURPOSES.

IN THE EVENT OF ANY CONFLICTS BETWEEN THIS MANUAL AND THE APPLICABLE LAW, THE LATER PREVAILS.

## Regulatory Information

### FCC Information

Please take attention that changes or modification not expressly approved by the party responsible for compliance could void the user's authority to operate the equipment.

**FCC compliance:** This product has been tested and found to comply with the limits for a Class B digital device, pursuant to Part 15 of the FCC Rules. These limits are designed to provide reasonable protection against harmful interference in a residential installation. This product generates, uses, and can radiate radio frequency energy and, if not installed and used in accordance with the instructions, may cause harmful interference to radio communications. However, there is no guarantee that interference will not occur in a particular installation. If this product does cause harmful interference to radio or television reception, which can be determined by turning the equipment off and on, the user is encouraged to try to correct the interference by one or more of the following measures:

- Reorient or relocate the receiving antenna.
- Increase the separation between the equipment and receiver.
- Connect the equipment into an outlet on a circuit different from that to which the receiver is connected.
- Consult the dealer or an experienced radio/TV technician for help.

### FCC Conditions

This device complies with part 15 of the FCC Rules. Operation is subject to the following two conditions:

1. This device may not cause harmful interference.
2. This device must accept any interference received, including interference that may cause undesired operation.

### EU Conformity Statement



This product and - if applicable - the supplied accessories too are marked with "CE" and comply therefore with the applicable harmonized European standards listed under the EMC Directive 2014/30/EU, the LVD Directive 2014/35/EU, the RoHS Directive 2011/65/EU.



2012/19/EU (WEEE directive): Products marked with this symbol cannot be disposed of as unsorted municipal waste in the European Union. For proper recycling, return this product to your local supplier upon the purchase of equivalent new equipment, or dispose of it at

designated collection points. For more information see: [www.recyclethis.info](http://www.recyclethis.info)



2006/66/EC (battery directive): This product contains a battery that cannot be disposed of as unsorted municipal waste in the European Union. See the product documentation for specific battery information. The battery is marked with this symbol, which may include lettering to indicate cadmium (Cd), lead (Pb), or mercury (Hg). For proper recycling, return

the battery to your supplier or to a designated collection point. For more information see:

[www.recyclethis.info](http://www.recyclethis.info)

This equipment should be installed and operated with a minimum distance 20cm between the radiator and your body

## Table of Contents

Chapter 1 Product Overview .....	5
1.1 Product Advantages .....	5
1.2 Electrical Specifications .....	6
1.3 Features.....	7
1.4 Using Example.....	8
1.5 Hardware Overview.....	8
1.6 LED Description .....	9
Chapter 2 Installation.....	11
2.1 Connections and installation .....	11
2.2 Restore to Factory Settings .....	12
2.3 Default Values .....	12
Chapter 3 Quick Configuration.....	13
3.1 Log in .....	13
3.2 Wizard .....	16
Chapter 4 Status.....	19
Chapter 5 System.....	21
5.1 System .....	21
5.2 Administration .....	24
5.3 LED Configuration.....	25
5.4 Backup / Upgrade.....	26
5.5 Reboot .....	27
Chapter 6 Services .....	28
6.1 CAPWAP.....	28
6.2 SNMP.....	29
Chapter 7 Network.....	33
7.1 Interfaces .....	33
7.1.1 Common Configuration.....	33
7.1.2 DHCP Server .....	36
7.1.3 Add New Interface.....	37
7.1.4 Router Mode.....	39
7.2 Wifi.....	42
7.2.1 Device Configuration.....	42
7.2.2 Interface Configuration.....	50
7.3 Firewall.....	52
7.4 VLAN.....	54
7.5 Ping Watchdog .....	57
Chapter 8 Logout.....	59
Chapter 9 FAQ.....	59

# Chapter 1 Product Overview

## 1.1 Product Advantages

DS-3WF01C-2N is specially designed for elevator wireless video transmission and customized products; compared with the traditional elevator video transmission products, it has the following advantages:

### **1. Good anti - jamming ability**

Super low frequency power supply interference, electrical spark interference, inverter motor interference, control signal interference etc. that below tens of kilohertz are found in the elevator environment, the use of WIFI high-frequency transmission, can effectively avoid the interference of elevator environment. At the same time the device supports extended frequency, can avoid the same frequency interference in the traditional WIFI.

### **2. Short construction period**

In the absence of a large amount of wiring work, so greatly shorten the construction period, save a lot of human resources.

### **3. Embedded XTrans technology**

DS-3WF01C-2N devices is embedded with XTrans technology, including TDMA, 20M/40MHz bandwidth, intelligent rate control, Auto ACK Time-out adjust. It makes the device have longer transmission distance, higher throughput and better point-to-multi-point performance.

### **4. Embedded hardware watchdog**

DS-3WF01C-2N is embedded with hardware watchdog, which is used to monitor the working status of the device. Once the system is not working properly, the device can be rebooted to guarantee the stability of the system.

### **5. More Non-standard channels availability**

Currently most of the WIFI devices are working at standard 802.11 2.4GHz frequency. However, standard 802.11 2.4GHz only provide limited channels, and there is serious interference if there are a lot of 2.4GHz WIFI devices nearby. DS-3WF01C-2N support more channels near 2.4GHz band, and spread the band to non-standard frequency part. The advantage of working at the non-standard band is to avoid the interference in the standard channels, and the wireless throughput can be improved.

Note: Please confirm whether those non-standard channels are permitted locally before using them.

## 1.2 Electrical Specifications

DS-3WF01C-2N electrical specifications as shown below:

Table 1-1 Electrical Specifications

	Items	Specifications
Wireless	Standard	IEEE802.11 b/g/n ( 2T2R 300Mbps )
	Operation Frequency	802.11 b/g/n(HT20): 2412MHz~2462MHz 802.11 n(HT40): 2422MHz~2452MHz
	Antenna	Internal, 6dBi, H: 65° V: 60°
	Receive Sensitivity	-72dBm@65Mbps , -97dBm@1Mbps
	Operation Frequency	11n : 300Mbps(HT40) , 130(HT20)
		11g : 54Mbps
Hardware	Power supply	48V POE+ or 12V DC
	Interface	3×10/100M Base-TX (Cat. 5/5E , RJ-45) ports
	Operation Temperature	-30°C ~ +65°C
	Storage Temperature	-40°C ~ +85°C
	Operation Humidity	5% ~ 95%RH
	Dimensions:	150*150*31.6mm
Software	Application scenarios	Elevator Car / Elevator Room
	Encryption	WPA-PSK/WPA2-PSK
	Network	Router/Bridge
	Security	MAC filter, SSID hidden
	Network Protocol	TCP/UDP/ARP/ICMP/DHCP/HTTP/NTP
	TDMA	Supported (Avoid 802.11 hidden-node problems, and improve the point-to-multi-point performance)

	Auto ACK timing Adjust	Supported
	Management and Logs	NTP, SNMP, Syslog, Telnet, AC
	Web based Configuration	Supported
	Firmware Update	Supported
	Bandwidth supported	20M/40MHz

### 1.3 Features

- High performance 802.11n 2x2 MIMO chip
- It supports four operating modes: Access Point, Client, Access Point (WDS), Client (WDS)
- Integrated XTrans technology, including TDMA, intelligent rate control, Auto ACK Time-out adjust
- TDMA solves the problems of hidden-node problem in the 802.11 network, thus having better long-distance and PTMP performance
- Support point-to-point, point-to-multipoint connection
- Unique antenna, RF amplifier, and low noise receiver to ensure long-distance video transmission
- Web based working scenario selection makes the installation and setting much easier
- Multi-network interface design, more conducive to the expansion of a variety of applications
- Web-based configuration, easy to use
- High temperature flame retardant housing ensure stable operation in harsh

environments

## 1.4 Using Example

DS-3WF01C-2N products can be used inside the elevator shaft to survey the video transmission, while the use of multiple network interfaces equipped with elevator advertising machine to real-time updates. Backhaul data networks can rely on existing properties or assembling outdoor wireless device.

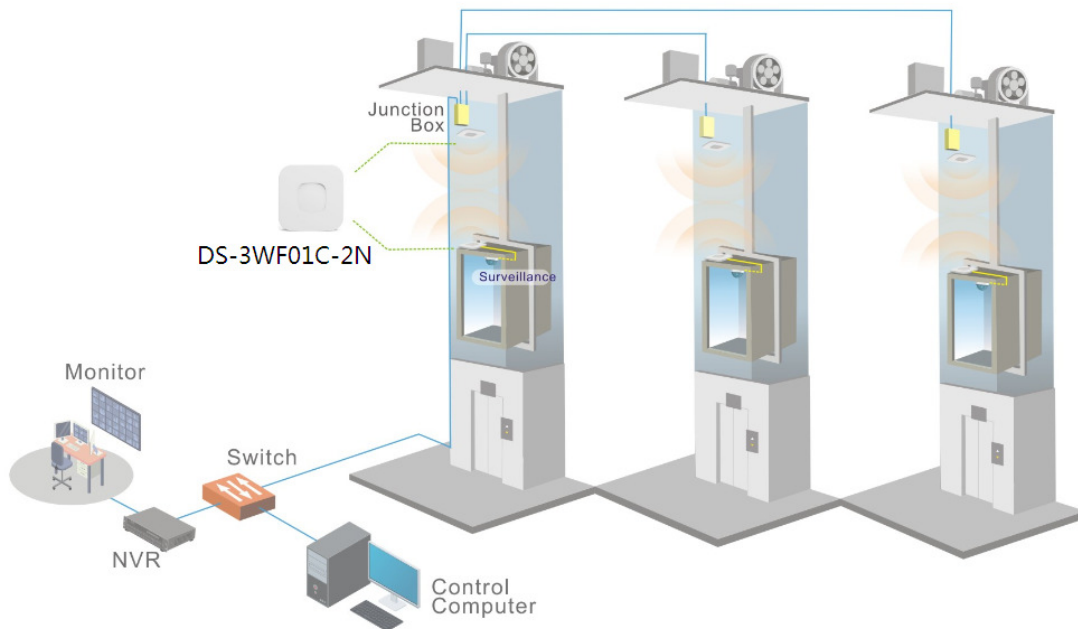

Figure 1-1 DS-3WF01C-2N Using Example

## 1.5 Hardware Overview

Hardware information of DS-3WF01C-2N is described in the following Table:

Table 1-2 Hardware Information

Hardware Specifications	
CPU/Baseband Radio	Atheros QCA9531



Memory	64MB DRAM, 8MB Flash
Physical Interface	3×10/100M Base-TX (Cat. 5/5E, RJ-45) Ports
LED	LAN, WLAN, 3×Link Quality
Power Supply	POE+, Power Adapter 12V

## 1.6 LED Description

DS-3WF01C-2N use LED to reflect the current status of working and quality of the connection. LED is mainly divided into two parts, status of the device and the quality of the connection. As shown on the picture, the first left LED indicator for the LAN, the second from the left for the WLAN indicator light, the middle three signal strength indicator, as specified in the following Table:



Figure 1-2 LED  
Table 1-3 LED Information

LED	Color	Status
LAN	Yellow	The light indicates there is an external device connects to the LAN port which is the LAN1 port of DS-3WF01C-2N.
WLAN	Green	The light indicates that the wireless DS-3WF01C-2N is enabled.  Blinking means enabled wireless devices,

		and is sending the wireless data.
--	--	-----------------------------------

Signal Level	Red	The light indicates the signal level
	Yellow	Green, yellow and red lights on, indicates the wireless signal level is high
	Green	Yellow and red lights on, indicating signal level is medium  Only red light on, indicating that the signal is weak or no signal

## Chapter 2 Installation

### 2.1 Connections and installation

The installation of DS-3WF01C-2N as shown in the following figure:

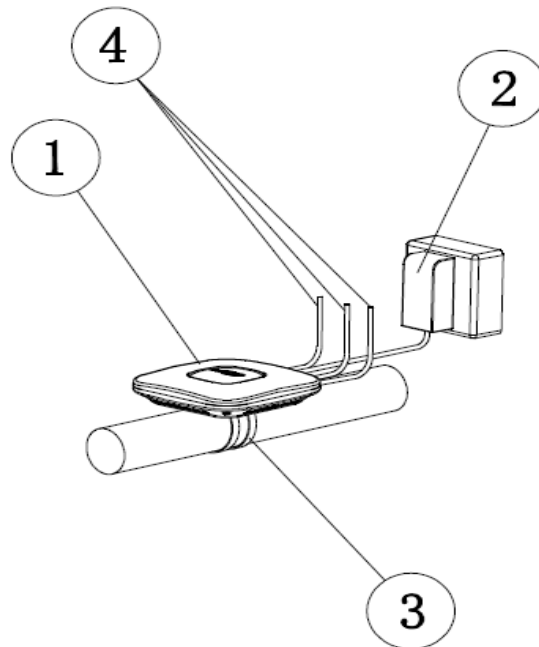

Figure 2-1 Connections

1. DS-3WF01C-2N Device

2. POE power adaptor

3. Mount Bracket

4. Three LAN port on the device can be connected to the camera

There are two devices within a package: DS-3WF01C-2N (T) and DS-3WF01C-2N (R), two POE power adaptors. The DS-3WF01C-2N (T) should be mounted on top of the elevator car; it's normally linked up with network cameras and other network advertising screens equipment through the network cable. DS-3WF01C-2N (R) should be installed in the elevator room, for receiving the network signal. The two devices can be fixed by each hoop.

The LAN port of the POE adaptor can be used for connecting a camera. You can also use your own DC12V power supply for the device.

## 2.2 Restore to Factory Settings

In some cases, users can restore the device to factory settings. Push the reset button for 5~10 seconds and wait for 2~3 minutes. The device will restore to factory settings.

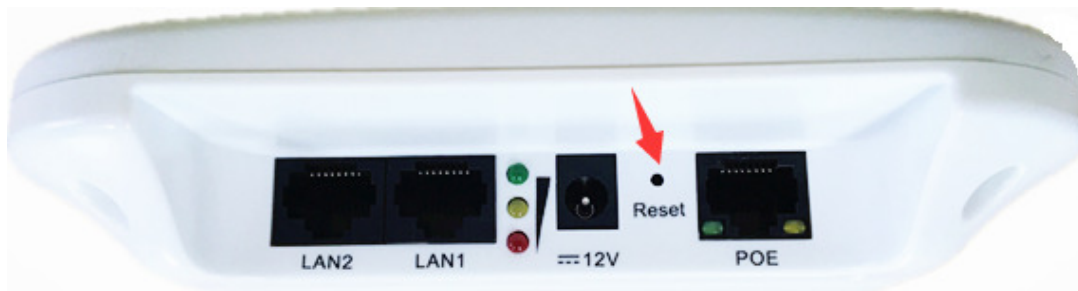

Figure 2-2 Reset

## 2.3 Default Values

There are two DS-3WF01C-2N devices: DS-3WF01C-2N (T) and DS-3WF01C-2N (R), a twin pack. They can be used directly without debugging after installation, the main

parameters of the default factory settings as shown below. If you want to change the default values and other parameters, please read the manual in the following sections.

Table 2-1 Main parameters at the factory settings

<b>Items</b>	<b>Elevator Car / DS-3WF01C-2N(T)</b>	<b>Elevator Room / DS-3WF01C-2N(R)</b>
Wireless mode	Access Point	Client
IP address	192.168.1.35	192.168.1.36
User name	root	root
Password	admin	admin
SSID	Wireless-Bridge	Wireless-Bridge
Hidden SSID	Enable	N/A
Channel	6(2.437 GHz)	Auto
Encryption	WPA2-PSK Key: 1234567890abc	WPA2-PSK Key: 1234567890abc
Network mode	Bridge	Bridge

## Chapter 3 Quick Configuration

### 3.1 Log in

To log in the DS-3WF01C-2N device, you need to configure the TCP/IP of your computer first as the following steps:

1. Right click Local Area Connection icon of your computer and click properties, then click Continue, the Local Area Connection Properties dialog box appears as shown below:

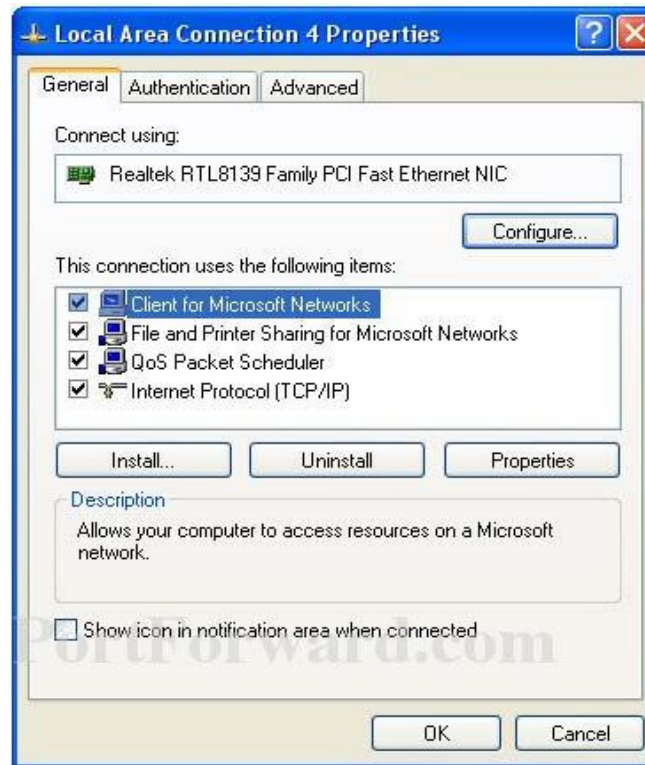

Figure 3-1 Local Area Connection Properties

2. Select Internet Protocol (TCP/IP) and click Properties button, and the following dialog box appears:

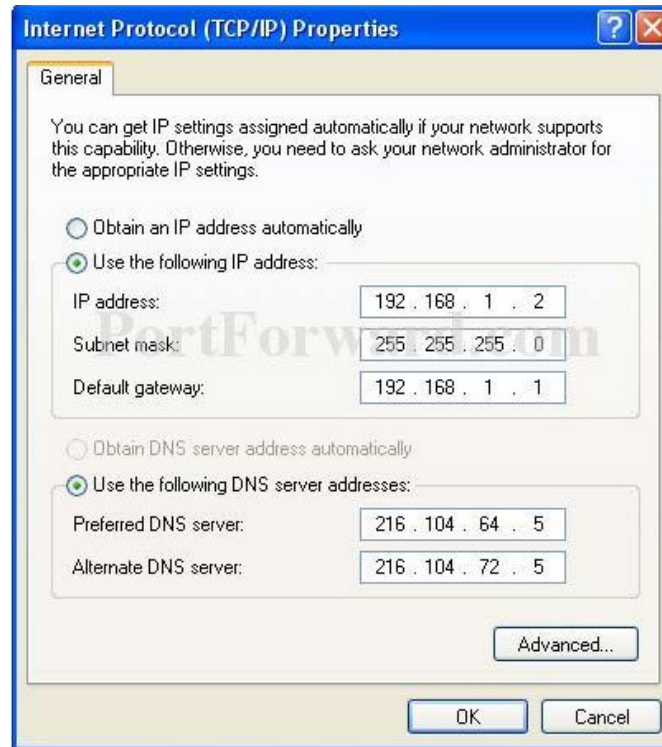

Figure 3-2 IP Settings

3. As shown in the figure above, IP address should be set to 192.168.1.\*, but cannot be the same as DS-3WF01C-2N, here \* can be a number between 1-255 (but not 36 or 35) since the DS-3WF01C-2N (T) default IP address is 192.168.1.35, and the DS-3WF01C-2N(R) default IP address is 192.168.1.36.
4. Input the default IP 192.168.1.36 or 192.168.1.35 into the address bar of your web browser, click Enter.
5. Input the user name and password (default is root/admin), the you can log in to the web configuration menu of the DS-3WF01C-2N device

## Authorization Required

Please enter your username and password.

Username

Password



---

Figure 3-3 DS-3WF01C-2N Login Page

## 3.2 Wizard

Users can quickly configure DS-3WF01C-2N according to the following steps through the wizard in this chapter.

1. The first page shown after log in is the Status page, which indicates the working status, current setting, software version and other information of the DS-3WF01C-2N device. User can switch to other pages by clicking the main menus.



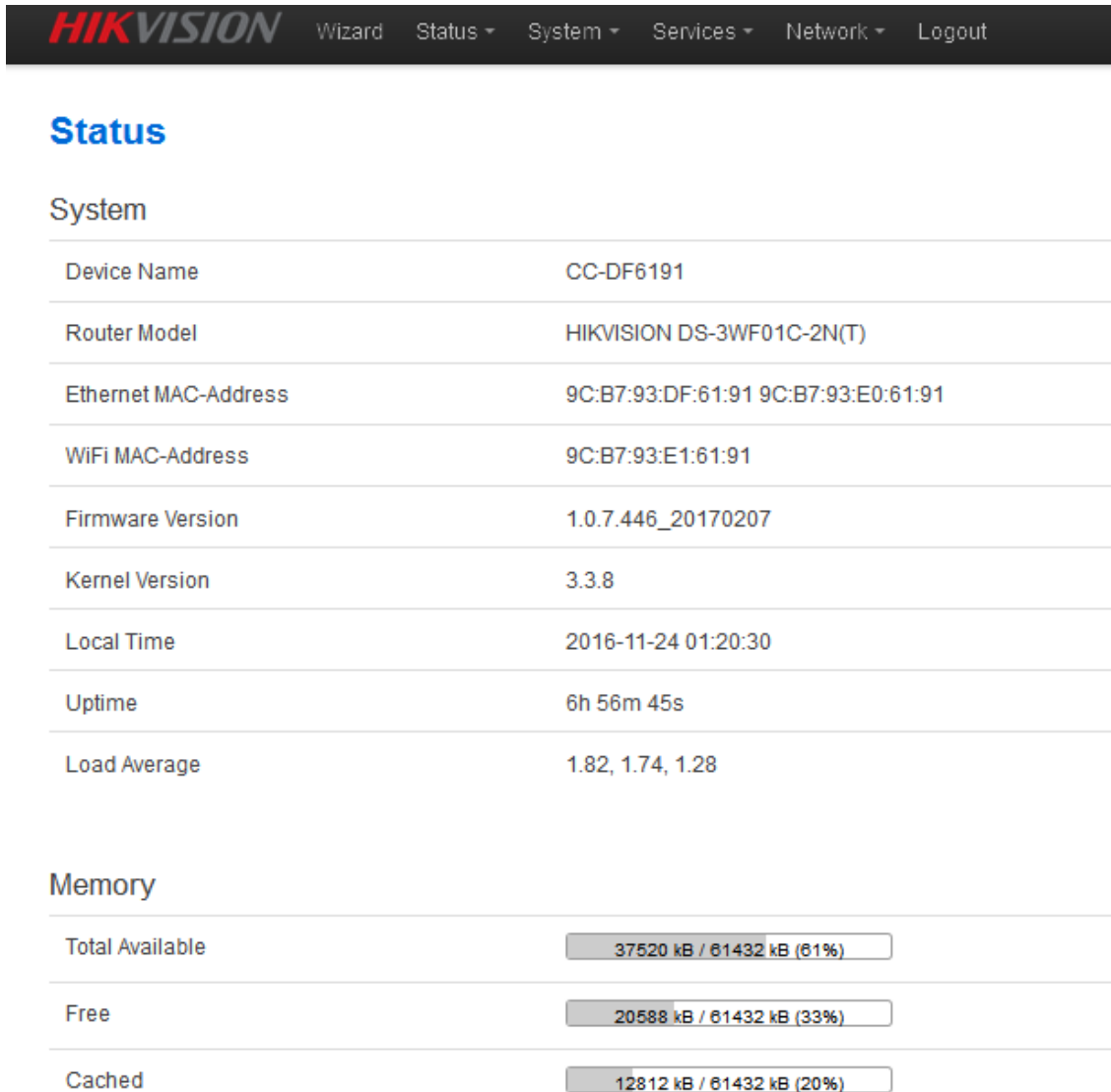

Figure 3-4 Status– DS-3WF01C-2N (T)

- Click Wizard. The page goes to Wizard page as shown below, and this page helps to set the basic network parameters. The default mode is Bridge mode, and the default LAN IP address of DS-3WF01C-2N (T) is 192.168.1.35, the default LAN IP address of DS-3WF01C-2N(R) is 192.168.1.36. If the user wants to configure the device to Router mode, please refer to chapter 7.

**Note:** If there are several DS-3WF01C-2N devices connected in the Point-to-Point or Point-to-Multi-Point topologies, they must be configured to different IP address to avoid conflicts.

## Wizard

Wizards can help you quickly configure frequently used parameters. After completing the wizard, you can also access other pages for more detailed configuration.

### General Settings

Application scenarios	<input type="text" value="Elevator Car"/>
IPv4 address	<input type="text" value="192.168.1.35"/>
IPv4 netmask	<input type="text" value="255.255.255.0"/>
IPv4 gateway	<input type="text"/>

Figure 3-5 Wizard – DS-3WF01C-2N (T)

**Elevator Car:** (AP mode), in this scenario mode, DS-3WF01C-2N will be set to AP mode; it can be connected to a client device. When you close the TDMA function, your phone or laptop can connect to the DS-3WF01C-2N. If you need other wireless configurations in detail, please refer to chapter 7.

## Wizard

Wizards can help you quickly configure frequently used parameters. After completing the wizard, you can also access other pages for more detailed configuration.

### General Settings

Application scenarios	<input type="text" value="Elevator Room"/>
IPv4 address	<input type="text" value="192.168.1.36"/>
IPv4 netmask	<input type="text" value="255.255.255.0"/>
IPv4 gateway	<input type="text"/>

Figure 3-6 Wizard – DS-3WF01C-2N (R)

**Elevator Room:** In this scenario mode, DS-3WF01C-2N will be set to client mode; it can be connected to an access point device.

**Notes:** The default SSID of DS-3WF01C-2N (T) and DS-3WF01C-2N (R) is Wireless-Bridge, and they can be directly interconnected and transmit audio and video or data, if there are other DS-3WF01C-2N equipment within 500 meters, you should change SSID to different one in order to avoid connection confusion, please refer to chapter 7 to see how to modify the SSID.

- 3、 Click **Save & Apply** button, the device will reboot and apply your configuration.

### CC-OpenWrt - Redirecting...

Wait a few minutes until you try to reconnect. It might be necessary to renew the address of your computer to reach the device again, depending on your settings.

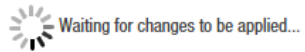

Figure 3-7 Complete wizard settings

## Chapter 4 Status



The status page is the first page after logging in, the page displays the current configuration and working status of the device. It is the first item in the menu bar, as shown in figure:

## Status

### System

Device Name	CC-DF6191
Router Model	HIKVISION DS-3WF01C-2N(T)
Ethernet MAC-Address	9C:B7:93:DF:61:91 9C:B7:93:E0:61:91
WiFi MAC-Address	9C:B7:93:E1:61:91
Firmware Version	1.0.7.446_20170207
Kernel Version	3.3.8
Local Time	2016-11-23 18:29:25
Uptime	0h 5m 41s
Load Average	1.14, 0.47, 0.19

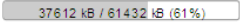
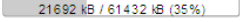
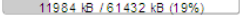
### Memory

Total Available	 37612 kB / 61432 kB (61%)
Free	 21692 kB / 61432 kB (35%)
Cached	 11984 kB / 61432 kB (19%)
Buffered	 3936 kB / 61432 kB (6%)

### DHCP Leases

Hostname	IPv4-Address	MAC-Address	Leasetime remaining
----------	--------------	-------------	---------------------

There are no active leases.

### DHCPv6 Leases

Hostname	IPv6-Address	DUID	Leasetime remaining
----------	--------------	------	---------------------

There are no active leases.

### Wireless

Generic Atheros 802.11gn (wifi0)	 SSID: Wireless-02071 100% Mode: Master (WDS) Channel: 77 (2.492 GHz) Bitrate: 144.4 Mbit/s Signal: -96 dBm Distance: < 10.0 km BSSID: 9C:B7:93:E1:61:91 Encryption: WPA2-PSK (CCMP)
----------------------------------	--

### Associated Stations

MAC-Address	Network	Device Name	IPv4-Address	Signal	Noise	RX Rate	TX Rate
-------------	---------	-------------	--------------	--------	-------	---------	---------

No information available

Figure 4-1 Status

**Overview:** Status->Overview, This page shows the current configuration information of the system, including the system, memory, network, DHCP leases, wireless, associated stations, active UPnP redirects.

**Firewall:** Status - > firewall, showing the device's current IPv4 and IPv6 firewall; please do not click on the "Reset Counters" and "Restart Firewall" without the guidance of network manager, so as to avoid unnecessary trouble.

**Routes:** Status - > Routes, this page display the active routes on the system.

**System log:** displaying the system log information of the device.

**Kernel log:** displaying the kernel log information of the device.

**Processes:** displaying the device system current process and its status information; please do not click "Hang Up", "Terminate", "Kill" without the guidance of network manager, so as to avoid unnecessary trouble.

**Real time Graphs:** display the real-time load, traffic, and link information of the device.

## Chapter 5 System

System page includes: System, Administration, Software, Startup, Scheduled Tasks, LED Configuration, Backup / Flash Firmware and Reboot sub-pages. The following are descriptions of the system, Administration, backup / upgrade and reboot sub-pages.

### 5.1 System

Here you can configure the basic aspects of your device like its hostname or the time zone.

**General Settings:** some basic information is supported to configure on this page, including time, log, language and interface style.

Click on the "general settings" page, click on "Sync with browser" to synchronize the local time to the device, and it will be displayed in the status page too. The time synchronization can help network administrator check equipment operation status and log information conveniently, and can also help tracking running status of the device.

Host name is corresponding to the Router Name of the status page; users can change it according to their own needs as shown in the figure.

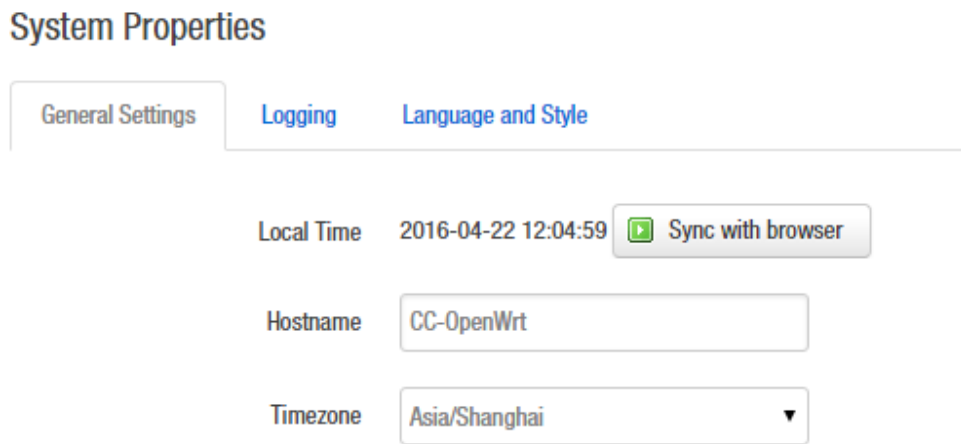

Figure 5-1 System Properties – General Settings

**Logging:** When Syslog is enabled, and the System Log server's IP is also set here, the log information will be output to the Syslog server automatically.

### System Properties

[General Settings](#) **Logging** [Language and Style](#)

System log buffer size   
kiB

External system log server

External system log server port

Log output level  ▼

Cron Log Level  ▼

Figure 5-2 System Properties - Logging

**Language and Style:** choose the language of the web page you want. You can modify the Language into English or Chinese. The default Design is bootstrap style, you can also choose openwrt style based on personal hobby.

### System Properties

[General Settings](#) [Logging](#) **Language and Style**

Language  ▼

Design  ▼

Figure 5-3 System Properties – Language and Style

**Time Synchronization:** when the device can surf the Internet, you can enable the NTP client and fill in the NTP server candidates. DS-3WF01C-2N will get time automatically from the NTP server and displayed in the status page. At this point you can also tick the Provide NTP server and make the device as a NTP server for other devices connected to the DS-3WF01C-2N to acquire time.

## Time Synchronization

Enable NTP client

Provide NTP server

NTP server candidates



cn.ntp.org.cn	
0.openwrt.pool.ntp.org	
1.openwrt.pool.ntp.org	

Figure 5-4 System Properties – Time Synchronization

## 5.2 Administration

Router Password: Changes the administrator password for accessing the device.

### Router Password

Changes the administrator password for accessing the device

Change password

Old password

New password

Confirm new password

Figure 5-5 Password

**SSH Access:** Drop bear offers SSH2 network shell access and an integrated SCP server. Here you can change the default SSH parameters.



## SSH Access

Dropbear offers SSH2 network shell access and an integrated SCP server

### Dropbear Instance

The screenshot shows the configuration page for the Dropbear instance. It includes the following settings:

- Interface:** Two radio buttons are present. The first is labeled 'lan:' and has a dropdown menu showing 'lan:'. The second is labeled 'unspecified' and is selected.
- Port:** A text input field contains the value '22'. Below it is a help icon and the text 'Specifies the listening port of this Dropbear instance'.
- Password authentication:** A checked checkbox is followed by a help icon and the text 'Allow SSH password authentication'.
- Allow root logins with password:** A checked checkbox is followed by a help icon and the text 'Allow the root user to login with password'.
- Gateway ports:** An unchecked checkbox is followed by a help icon and the text 'Allow remote hosts to connect to local SSH forwarded ports'.

Figure 5-6 SSH

**Note:** after saving the configuration of administration page, the device will automatically close telnet access, the user can login the device through more secure SSH.

System->Software, Startup and Scheduled Tasks pages: it is not recommended to operating, just keep the default configuration.

## 5.3 LED Configuration

Click on System->LED Configuration, in this page you can customize the behavior of the device LEDs if possible; it defines the value of the signal strength required for the light of the 3 LEDs, which works only on the client mode device.

Name	<input type="text" value="Weak"/>
LED Name	<input type="text" value="red:weak"/>
Default state	<input type="checkbox"/>
Trigger	<input type="text" value="rssi"/>
Min Quality (dBm)	<input type="text" value="-95"/>
Max Quality (dBm)	<input type="text" value="-1"/>

Figure 5-7 LED Settings

The red LED intensity value is the smallest of the 3 LEDs (red < yellow < green), the default range of red LED: -95~-1dBm, yellow: -71~-1dBm, green: -56~-1dBm. When the signal strength is higher than -95dB and below -71dBm, red light; when the signal strength is higher than -71dB and below -56dBm, both red and yellow light; when the signal strength is higher than -56dBm, all the 3 LEDs light.

## 5.4 Backup / Upgrade

System->Backup / Flash Firmware page is very simple to use. It is divided into the following 2 parts:

### **Backup / Restore**

Click "Generate archive" to download a tar archive of the current configuration files.

Click "Perform reset" to reset the firmware to its initial state.

To restore configuration files, you can upload a previously generated backup archive.

### Backup / Restore

Click "Generate archive" to download a tar archive of the current configuration files. To reset the firmware to its initial state, click "Perform reset" (only possible with squashfs images).

Download backup:

Reset to defaults:

To restore configuration files, you can upload a previously generated backup archive here.

Restore backup:

Diag the device information and running state for bug report.

Diag devcie info:

Figure 5-8 Backup / Restore

### Flash new firmware image

Upload a sysupgrade - compatible image here to replace the running firmware. Check "Keep settings" to retain the current configuration (requires an OpenWrt compatible firmware image).

#### Flash new firmware image

Upload a sysupgrade-compatible image here to replace the running firmware. Check "Keep settings" to retain the current configuration (requires an OpenWrt compatible firmware image).

Keep settings:

Image:

Figure 5-9 Flash new firmware image

## 5.5 Reboot

Click Perform reboot to reboot the operating system of your device.

### System

#### Reboot

Reboots the operating system of your device

[Perform reboot](#)

Figure 5-10 Reboot

## Chapter 6 Services

Services page is divided into dynamic DNS, SNMP, CAPWAP, WiFiDog and UPNP, the following lists only CAPWAP and SNMP instructions.

### 6.1 CAPWAP

**CAPWAP:** Control and Provisioning of Wireless Access Points Protocol Specification. CAPWAP settings page as shown in figure. Enable this feature; you need to use the AC management system.

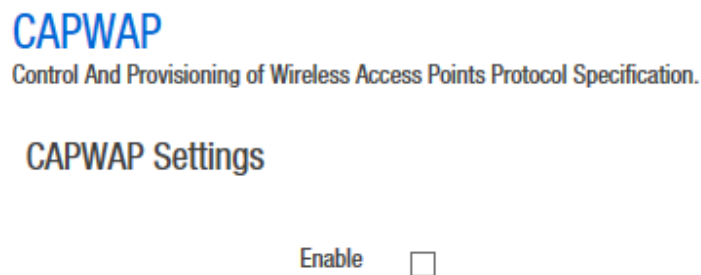

Figure 6-1 CAPWAP

**Interface:** the default option is LAN, the network administrator can choose it according to their own interface configuration.

**Location:** the location of the device on the AC, it can be modified in the AC according to your needs.

**Discovery mode:** choosing how to find the IP address of AC. When you choose Auto, AC IP can be automatically discovered by the device; when you choose manual, you need to fill in AC IP address. After CAPWAP feature is enabled, click on the save & application button, the device will apply AC configuration and restart, then the device will join the AC.

**Note:** If you want to set a client mode device to join AC successfully, the client should be connected to the access point device first, and the access point device has also opened the CAPWAP function and joined the same AC system.

## CAPWAP

Control And Provisioning of Wireless Access Points Protocol Specification.

### CAPWAP Settings

Enable	<input checked="" type="checkbox"/>
Interface	<input type="text" value="lan"/>
Location	<input type="text" value="shanghai"/>
Discovery mode	<input type="text" value="Auto"/>

Figure 6-2 CAPWAP Settings

## 6.2 SNMP

**SNMP:** When SNMP is enabled, you can check the working condition and information of the device by a SNMP tool.

## SNMP

Simple Network Management Protocol

### Basic Settings

SNMP Enable

### SNMPv3 Settings

SNMPv3 Enable

### Trap Settings

Trap Enable

Figure 6-3 SNMP

You can configure the SNMP parameters in Basic Settings part. Check SNMP Enable and fill in Location, Mail, Group; then you can manage the device through a SNMP tool in your computer.

## Basic Settings

SNMP Enable	<input checked="" type="checkbox"/>
Location	<input type="text" value="ShangHai"/>
Mail	<input type="text" value="snmp@creatcomm.com"/>
Group (read only)	<input type="text" value="public"/>
Group (read/write)	<input type="text" value="private"/>

Figure 6-4 Basic Settings

The device supports a higher level of SNMP protocol; you can choose to enable SNMPv3, with the corresponding SNMP management tools to use.

## SNMPv3 Settings

SNMPv3 Enable	<input checked="" type="checkbox"/>
User Name	<input type="text" value="user"/>
Group	<input type="text" value="RWPriv"/>
Authentication	<input type="text" value="SHA"/>
Password	<input type="password" value="....."/> 
Privacy	<input type="text" value="AES"/>
Password	<input type="password" value="....."/> 

Figure 6-5 SNMPv3 Settings

The device also supports trigger trap information; you can choose to enable Trap, fill in the trap server IP, then you will receive Trap information through the SNMP management tool in your computer.

## Trap Settings

Trap Enable	<input checked="" type="checkbox"/>
Trap Server IP	<input type="text" value="192.168.1.10"/>
Trap Server Port	<input type="text" value="162"/>

Figure 6-6 Trap Settings



# Chapter 7 Network

The network settings page is divided into the Interface, Wifi, DHCP and DNS, Hostnames, Static Routes, Diagnostics, Firewall, VLAN, Ping Watchdog, QoS. We will focus on the Interface, wireless, network diagnostics, firewall, Ping, Watchdog. VLAN.

The following will focus on the introduction of the Interface, Wifi, Diagnostics, Firewall, VLAN, Ping Watchdog.

## 7.1 Interfaces

### 7.1.1 Common Configuration

Open the network interface page; you'll see the overview of the current interface.

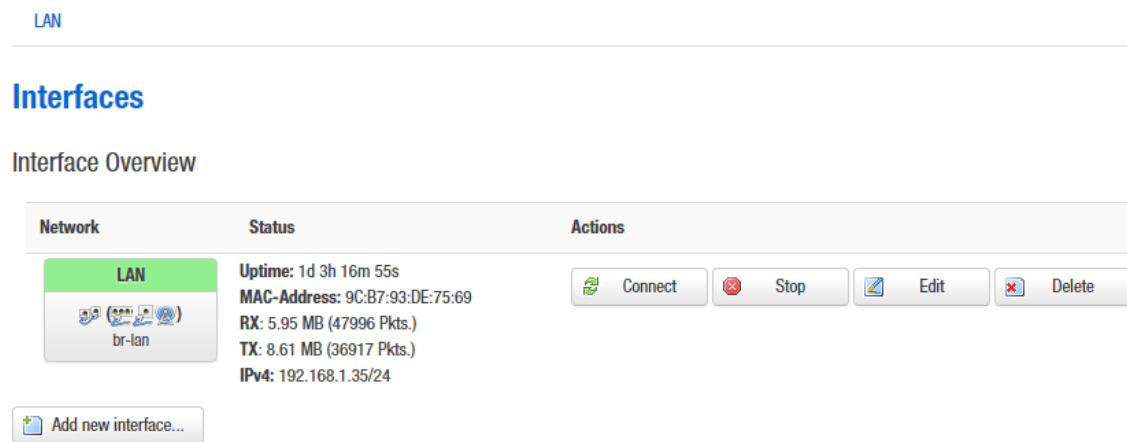

Figure 7-1 Interfaces

Click "Edit" button, you will enter the Interfaces-LAN page. On this page you can configure the network interfaces. You can bridge several interfaces by ticking the "bridge interfaces" field and enter the names of several network interfaces separated by spaces. You can also use VLAN notation INTERFACE.VLANNR (e.g.: eth0.1).

## Common Configuration



General Setup	Advanced Settings	Physical Settings	Firewall Settings
<p>Status </p> <p>br-lan</p> <p><b>Uptime:</b> 1d 3h 44m 54s  <b>MAC-Address:</b> 9C:B7:93:DE:75:69  <b>RX:</b> 6.27 MB (50505 Pkts.)  <b>TX:</b> 9.13 MB (38746 Pkts.)  <b>IPv4:</b> 192.168.1.35/24</p>			
Protocol	<input type="text" value="Static address"/> ▼		
IPv4 address	<input type="text" value="192.168.1.35"/>		
IPv4 netmask	<input type="text" value="255.255.255.0"/> ▼		
IPv4 gateway	<input type="text"/>		
IPv4 broadcast	<input type="text"/>		
Use custom DNS servers	<input type="text"/> 		
Accept router advertisements	<input type="checkbox"/>		
Send router solicitations	<input checked="" type="checkbox"/>		
IPv6 address	<input type="text"/>		
IPv6 gateway	<input type="text"/>		

Figure 7-2 General Setup

**Protocol:** the interface access IP address options, it divided into static address, DHCP client (to obtain the IP dynamically) and a variety of other ways. If you set a static IP, you need to set the IP, subnet mask, etc.; when set to DHCP client, the device can obtain IP from DHCP server automatically.

**IPv4 address:** IP address of this interface, you can configure it according to your own needs, but to ensure that IP cannot be the same as other devices in the same network, so as not to cause IP address conflict.

**IPv4 netmask:** the subnet mask of this interface, you can set it according to your own needs.

**Use custom DNS server:** It should be set to the value of the local DNS server.

Click on Physical settings of the “Interface – LAN” page, you can modify the current interface configuration which contains the wired interface and wireless interface.

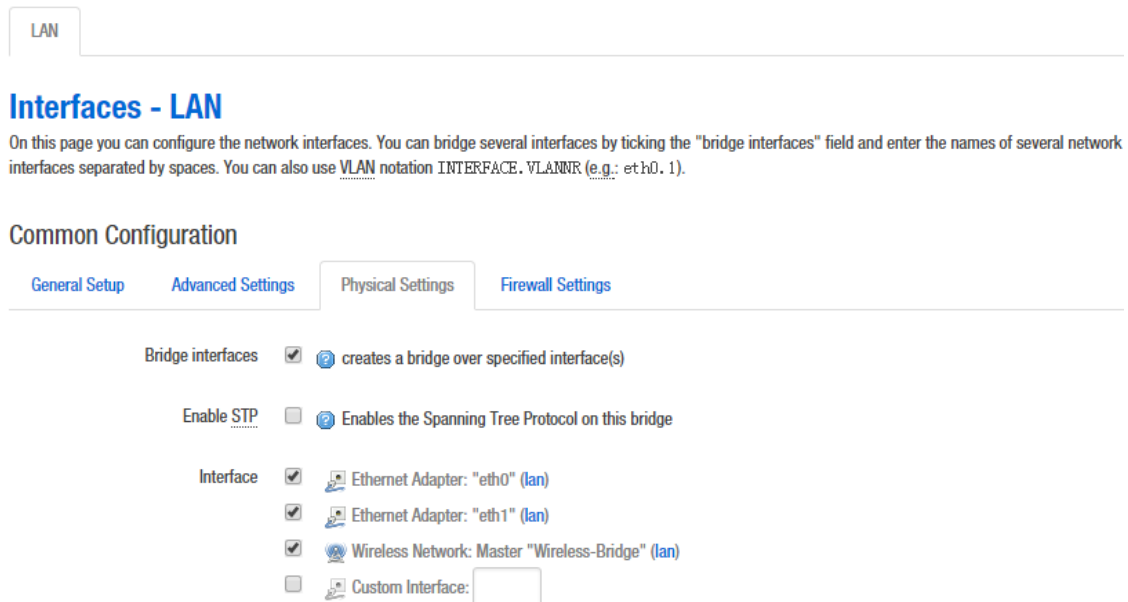

Figure 7-3 Physical Settings

**Bridge interfaces:** creates a bridge over specified interface(s). unchecking the Bridge interfaces and you could only choose one interface.

**Enable STP:** Enables the Spanning Tree Protocol on this bridge

**Interface:** Ethernet adapter "eth0" corresponds to the POE power supply LAN port of the device, Ethernet adapter "eth1" corresponds to the other two LAN port of the device.

Click to enter the firewall settings page. Choose the firewall zone you want to assign to this interface. Select unspecified to remove the interface from the associated zone or fill out the create field to define a new zone and attach the interface to it. please refer to the Manual Section 7.3 firewall.

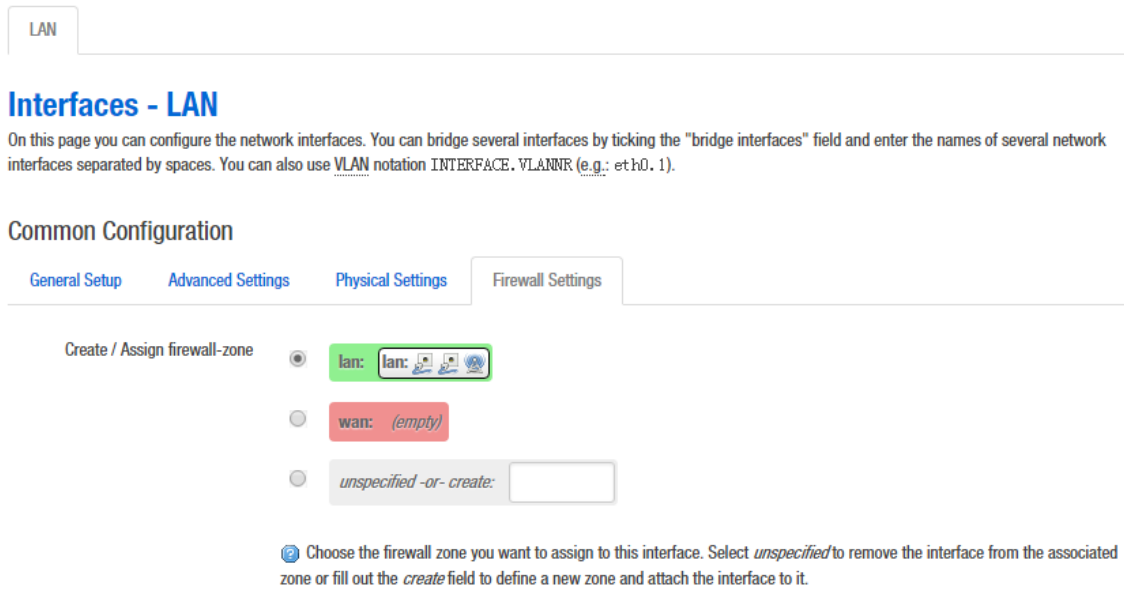

Figure 7-4 Firewall Settings

## 7.1.2 DHCP Server

Drop down the interface page; you can see the basic settings of the DHCP server.

## DHCP Server

General Setup    **Advanced Settings**

Ignore interface  [? Disable DHCP for this interface.](#)

Start   
[? Lowest leased address as offset from the network address.](#)

Limit   
[? Maximum number of leased addresses.](#)

Leasetime   
[? Expiry time of leased addresses, minimum is 2 Minutes \(2m\).](#)

Figure 7-5 DHCP Server

**DHCP:** Assign IP address to client device, such as phones, laptops etc. A device should enable DHCP client mode to get IP automatically.





### 7.1.3 Add New Interface

Click on the “Add new interface” button to add a new interface.

LAN

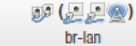
### Interfaces

Interface Overview

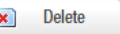
Network	Status	Actions
<b>LAN</b>  br-lan	<b>Uptime:</b> 1d 19h 54m 33s <b>MAC-Address:</b> 9C:B7:93:DE:75:69 <b>RX:</b> 8.45 MB (68826 Pkts.) <b>TX:</b> 11.65 MB (48152 Pkts.) <b>IPv4:</b> 192.168.1.35/24	 Connect  Stop  Edit  Delete



 Add new interface...

Figure 7-6 Add new interface

Fill in the name of the new interface, such as LAN2, select the Ethernet adapter eth1 interface, all of the configuration in this page can be modified again in the subsequent pages.

## Create Interface

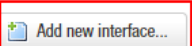
Name of the new interface

 The allowed characters are: **A-Z**, **a-z**, **0-9** and **\_**

Protocol of the new interface

Create a bridge over multiple interfaces

Cover the following interface





-  Ethernet Adapter: "eth0" (lan)
-  Ethernet Adapter: "eth1" (lan)
-  Wireless Network: Master "Wireless-Bridge" (lan)
-  Custom Interface:

Figure 7-7 Create Interface

Click Submit, will enter the new LAN2 interface configuration page. This page can be configured for all the existing interfaces, as shown below; you can still see the original LAN interface.

LAN2 LAN

### Interfaces - LAN2

On this page you can configure the network interfaces. You can bridge several interfaces by ticking the "bridge interfaces" field and enter the names of several network interfaces separated by spaces. You can also use VLAN notation INTERFACE.VLANNR (e.g.: eth0.1).

#### Common Configuration

General Setup **Advanced Settings** Physical Settings Firewall Settings



Status	 eth1	<b>Uptime:</b> 0h 0m 0s <b>MAC-Address:</b> 9C:B7:93:DF:75:69 <b>RX:</b> 10.57 MB (76425 Pkts.) <b>TX:</b> 13.56 MB (57038 Pkts.)
Protocol	Static address ▼	
IPv4 address	<input type="text"/>	
IPv4 netmask	255.255.255.0 ▼	
IPv4 gateway	<input type="text"/>	
IPv4 broadcast	<input type="text"/>	
Use custom DNS servers	<input type="text"/> 	

Figure 7-8 Create LAN2 interface

Please refer to chapter 7.1.1 to see how to configure the interface.

## 7.1.4 Router Mode

Routing mode DS-3WF01C-2N is equivalent to a router, it has a WAN port and LAN port. You should select an interface which needs to be removed from the default LAN interface for the WAN interface configuration.

Below we will set eth1 port to WAN as an example, introduces the configuration of the WAN. Please refer to the manual 7.1.1 Ethernet adapter "eth1" removed from the LAN interface.

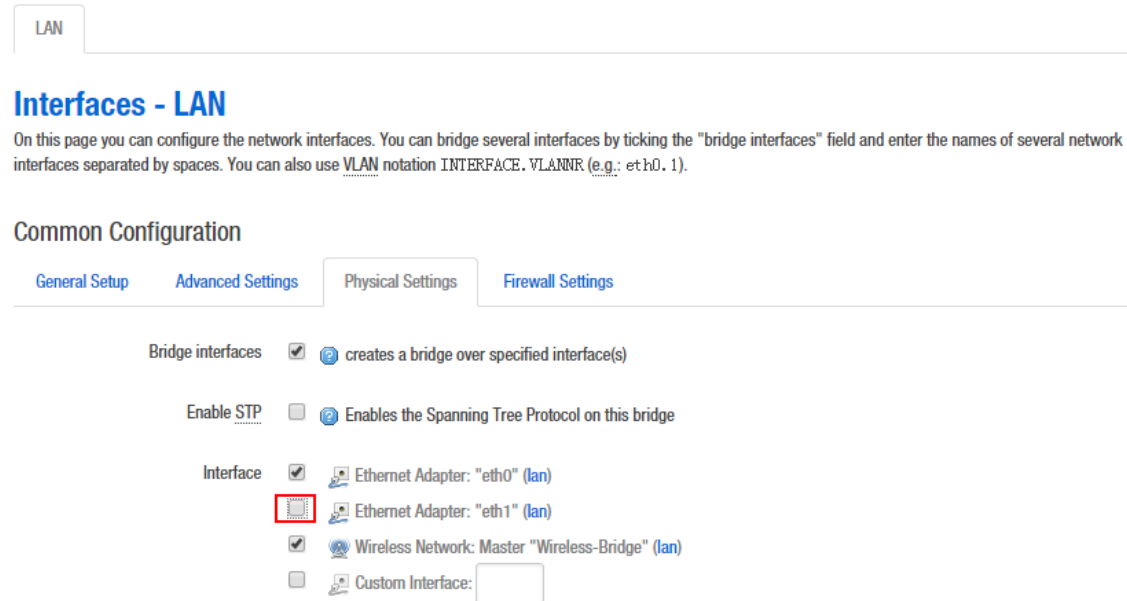

Figure 7-9 Router Interface – WAN Settings

Click the "Add new interface" of the Interfaces page, and fill in the name of the new interface, such as ETH1, you can choose a static address for the new interface protocol, all of the current page configuration can be modified in the subsequent page.

## Create Interface

The 'Create Interface' form contains the following fields and options: 'Name of the new interface' (text input with 'ETH1'), 'Protocol of the new interface' (dropdown menu with 'Static address'), 'Create a bridge over multiple interfaces' (checkbox, unchecked), and 'Cover the following interface' (radio button selection). The selected option is 'Ethernet Adapter: "eth1" (lan)'. Other options include 'Ethernet Adapter: "eth0" (lan)', 'Wireless Network: Master "Wireless-Bridge" (lan)', and 'Custom Interface:'. A help icon and character list are visible below the name field.

Figure 7-10 Router-Interface



Click "submit". Into the newly created interface configuration page, fill in the IPv4 address which should be different with LAN segments, such as 192.168.2.35.

ETH1 LAN

### Interfaces - ETH1

On this page you can configure the network interfaces. You can bridge several interfaces by ticking the "bridge interfaces" field and enter the names of several network interfaces separated by spaces. You can also use VLAN notation INTERFACE.VLANNR (e.g.: eth0.1).

#### Common Configuration

General Setup **Advanced Settings** Physical Settings Firewall Settings

Status  eth1 **Uptime:** 0h 0m 0s  
**MAC-Address:** 9C:B7:93:DF:3A:EE  
**RX:** 0.00 B (0 Pkts.)  
**TX:** 0.00 B (0 Pkts.)

Protocol Static address ▼

IPv4 address 192.168.2.35

IPv4 netmask 255.255.255.0 ▼

IPv4 gateway 192.168.2.254

IPv4 broadcast

Use custom DNS servers 114.114.114.114 ✖  
8.8.8.8 ➕

Figure 7-11 Router Interface – General Setup

IPv4 gateway: In general, the IPv4 gateway address and WAN IP address are in the same network.

In general setup - the firewall settings page, select the default wan firewall-zone, after saving the application, you will see ETH1 is set to the WAN zone, then routing mode setup is complete, eth1 port is set for the WAN port. Firewall rules modify please refer to the chapter 7.3 firewall chapters.

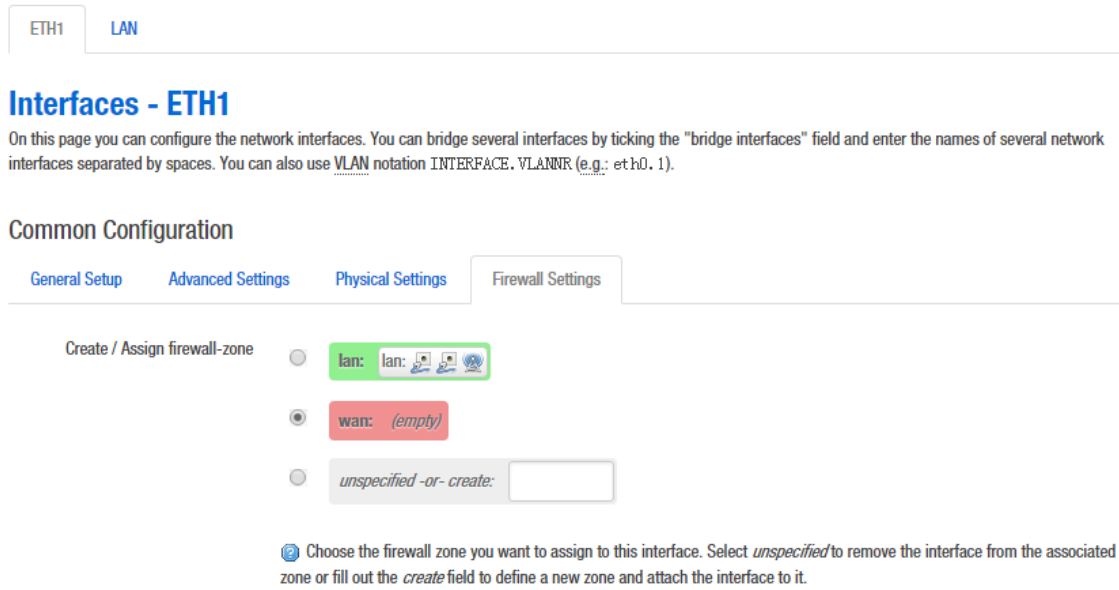

Figure 7-12 Router Interface - Firewall Settings

## 7.2 Wifi

### 7.2.1 Device Configuration

The Device Configuration section covers physical settings of the radio hardware such as channel, transmit power or antenna selection which is shared among all defined wireless networks (if the radio hardware is multi-SSID capable).

Open the Network -> Wifi page, you will see the current wireless profile and the information of associated stations.

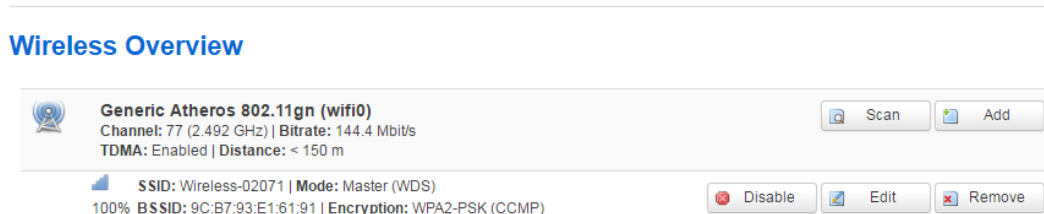

Figure 7-13 Wireless Overview

The device can scan the SSID nearby; you can connect to the corresponding wireless network according to your needs.

## Join Network: Wireless Scan

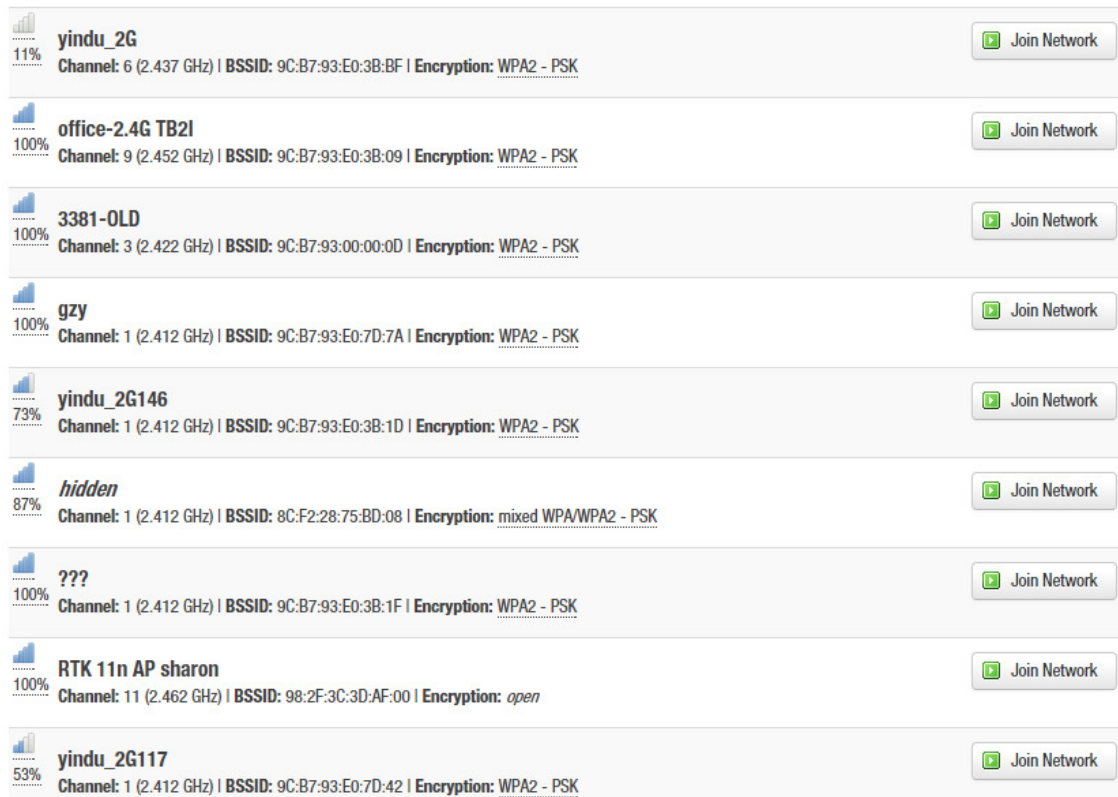

Figure 7-14 Scanning SSID

Click the SSID you need, here we select the "office-2.4G TB2I" as an example. Click on "Join Network", it will appear the following tips as shown below, and if you check "Replace the wireless configuration", click on the confirmation will cover all current wireless template settings, please choose carefully.

## Join Network: Settings

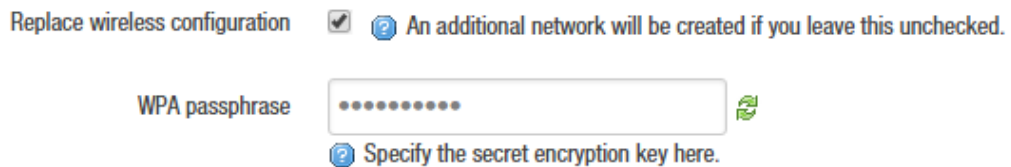

Figure 7-15 Join Network-1

Here we uncheck the "Replace wireless configuration", click "Submit", it will appear the following page below.

wifi0: Unknown "office-2.4G TB2I"    wifi0: Master "Wireless-Bridge"

### Wireless Network: Unknown "office-2.4G TB2I" (wifi0.network2)

The *Device Configuration* section covers physical settings of the radio hardware such as channel, transmit power or antenna selection which is shared among all defined wireless networks (if the radio hardware is multi-SSID capable). Per network settings like encryption or operation mode are grouped in the *Interface Configuration*.

#### Device Configuration

General Setup    **Advanced Settings**

Status 

Wireless network is enabled  **Disable**

Channel

Transmit Power   dBm

Mode

HT mode

Max Transmission Rate

#### Interface Configuration

General Setup    **Wireless Security**    Advanced Settings

ESSID

Mode

BSSID

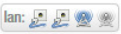
Network  lan:   create:

 Choose the network(s) you want to attach to this wireless interface or fill out the *create* field to define a new network.

Figure 7-16 Join Network – 2

Click "Save & Apply", wait a moment, and then Turn to Network->Wifi page, you will see the "office-2.4G TB2I" on the Associated Stations list.

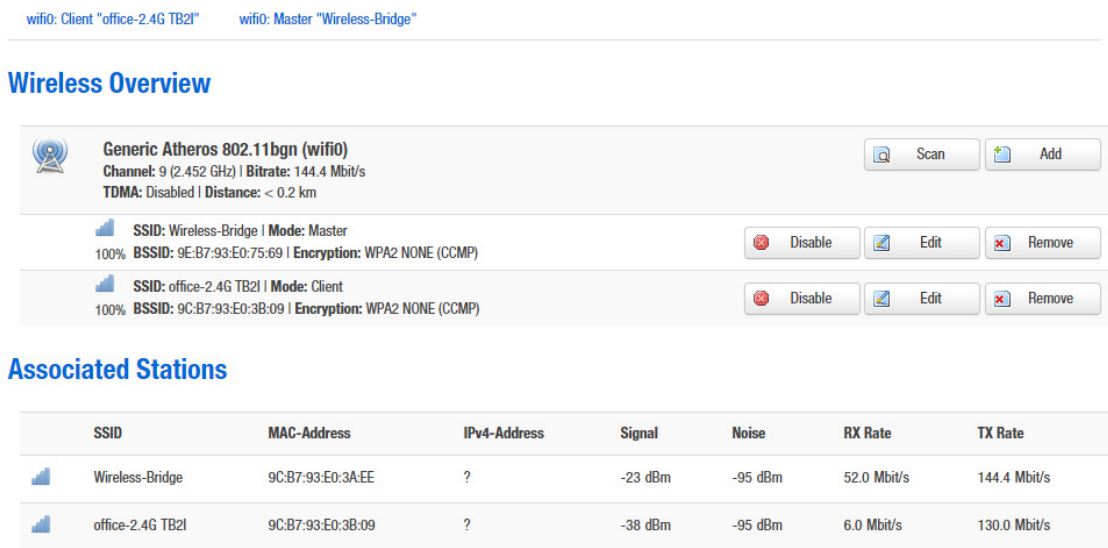

Figure 7-17 Join Network - 3

When the device has been added 8 wireless profiles, or there is a client mode wireless profile in the 8 profiles, click on Join Network will appear as follows.

### Join Network: Settings

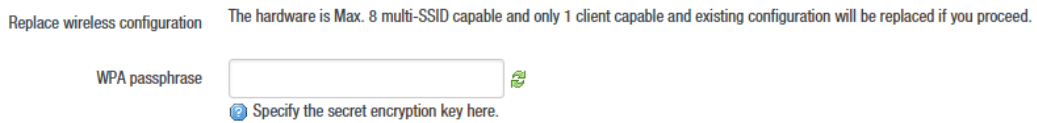

Figure 7-18 Join Network - 4

Click the Add button to add more wireless profiles, the device can add up to eight wireless profiles, and the device can only have one client mode profile, you can choose to enable or disable the added wireless profiles.

wifi0: Master "OpenWrt"    wifi0: Master "OpenWrt"    wifi0: Master "OpenWrt"    wifi0: Master "OpenWrt"    wifi0: Client "office-2.4G TB2l"

wifi0: Master "OpenWrt"    wifi0: Master "OpenWrt"    wifi0: Master "Wireless-Bridge"

---

### Wireless Overview

 **Generic Atheros 802.11bgn (wifi0)**









 <b>SSID: Wireless-Bridge   Mode: Master</b> 100% <i>Wireless is disabled or not associated</i>	<input type="button" value="Enable"/> <input type="button" value="Edit"/> <input type="button" value="Remove"/>
 <b>SSID: office-2.4G TB2l   Mode: Client</b> 100% <b>BSSID: 9C:B7:93:E0:3B:09   Encryption: WPA2 NONE (CCMP)</b>	<input type="button" value="Disable"/> <input type="button" value="Edit"/> <input type="button" value="Remove"/>
 <b>SSID: OpenWrt   Mode: Master</b> 100% <i>Wireless is disabled or not associated</i>	<input type="button" value="Enable"/> <input type="button" value="Edit"/> <input type="button" value="Remove"/>
 <b>SSID: OpenWrt   Mode: Master</b> 100% <i>Wireless is disabled or not associated</i>	<input type="button" value="Enable"/> <input type="button" value="Edit"/> <input type="button" value="Remove"/>
 <b>SSID: OpenWrt   Mode: Master</b> 100% <i>Wireless is disabled or not associated</i>	<input type="button" value="Enable"/> <input type="button" value="Edit"/> <input type="button" value="Remove"/>
 <b>SSID: OpenWrt   Mode: Master</b> 100% <i>Wireless is disabled or not associated</i>	<input type="button" value="Enable"/> <input type="button" value="Edit"/> <input type="button" value="Remove"/>
 <b>SSID: OpenWrt   Mode: Master</b> 100% <i>Wireless is disabled or not associated</i>	<input type="button" value="Enable"/> <input type="button" value="Edit"/> <input type="button" value="Remove"/>
 <b>SSID: OpenWrt   Mode: Master</b> 100% <i>Wireless is disabled or not associated</i>	<input type="button" value="Enable"/> <input type="button" value="Edit"/> <input type="button" value="Remove"/>

Figure 7-19 Add Wireless Profile

Click the Edit button; you can enter the wireless configuration page. The basic settings page as shown below.

## Device Configuration

General Setup | **Advanced Settings**

Status  **Mode:** Master (WDS) | **SSID:** Wireless-02071  
100% **BSSID:** 9C:B7:93:E1:61:91 | **Encryption:** WPA2-PSK (CCMP)  
**Channel:** 77 (2.492 GHz) | **Tx-Power:** 27 dBm  
**Signal:** -20(-20/-33) dBm | **Noise:** -95 dBm  
**Bitrate:** 144.4 Mbit/s | **Distance:** < 150 m

Wireless network is enabled  Disable

Channel: Auto

Auto channel list

- 247 (2.362 GHz)
- 248 (2.367 GHz)
- 249 (2.372 GHz)
- 250 (2.377 GHz)
- 251 (2.382 GHz)
- 252 (2.387 GHz)
- 253 (2.392 GHz)
- 254 (2.397 GHz)
- 255 (2.402 GHz)

Transmit Power: 27 dBm (501 mW)

Mode: 802.11g+n

HT mode: 20MHz

Max Transmission Rate: MCS15

Figure 7-20 General Setup

**Channel** : The channel can be modified when the device is configured to Access Point mode or WDS Access Point mode. The device can only work on one channel at the same time.

**Transmit Power** : The device output power. When the output power is increased, the signal distance and signal strength will be improved.

**Mode:** You can keep the default 802.11g+n mode to guarantee optimal transmission rate.

**HT Mode:** Channel width selection, the device supports 20/40+/40-MHz bandwidth. In general, the wider the bandwidth is, the greater the data throughput rate.

**Max Transmission Rate:** it can be used to limit the max transmission rate of a device.

Click on Device Configuration->Advanced Settings, you can configure the advanced settings of the device in this section.

**Device Configuration**

General Setup | **Advanced Settings**

Country: Compliance Test

Aggregation:

Aggregation Frames: 32

Aggregation Bytes: 65535

VAP Isolation:

TDMA Enable:  Enable TDMA feature for ap(ap-wds) mode.

TDMA Priority: High  
TDMA Priority for sta(sta-wds) mode.

Auto ACK-Timeout Adjust:

Figure 7-21 Advanced Settings

**Country Code :** Different countries allows different channels, you can choose the country code to allow the device works at the channels only permitted in the particular country. When you set Compliance Test mode, the frequency will extend to 2312-2732MHz.

**Aggregation:** It enables several data frames of 802.11 to be aggregated and transmitted out, thus improve the throughput. The larger the set value, the higher the throughput.



**VAP Isolation:** The device supports multiple VAP; if this feature is enabled, and when the client1 is connected to VAP1, the client1 will not be able to communicate the client2 which is connected to VAP2.

**TDMA :**

Currently, most of the outdoor bridge products are developed based on 802.11 protocols, however, it has the limitations of short-distance, hidden node problems, and poor point-to-multi-point performance.

XTrans technologies developed and patented by HIKVISION, utilizing a series of advanced technologies such as TDMA, intelligent rate control, Auto ACK Time-out Adjust, having the advantage of long transmission range, high data rate and robust transmission.

XTrans technology solves the problems of hidden-node problem in the 802.11 network infra-structure. Intelligent rate control algorithm can be adapted to quick channel quality variations, while stabilize the wireless throughput, thus suitable for long-distance transmission. ACK Time-out Auto Adjust can automatically detect the distances of the devices, and adjust the wireless parameters to achieve the best link quality.

To use the TDMA, the user needs to enable TDMA mode in the AP device, and set a priority level in the station device. When several stations are connected to one AP, different clients demand different throughput. If the client demands higher throughput, its priority level can be set to High, otherwise set to Low. When the client demands the same throughput, their priority level can be set to the same level.

**Note:** When using TDMA mode, the TDMA button need to be enabled at AP devices in the web-based configuration menu. The devices from other vendors cannot be connected to DS-3WF01C-2N in the TDMA mode. When TDMA is enabled, your phone or laptop cannot be able to connect to the device.

**Auto ACK-Timeout Adjust :** It is suggested to enable this function, so that the distance between 2 devices can be detected and all the related parameters can be optimized to achieve the best link quality.

## 7.2.2 Interface Configuration

Per network settings like encryption or operation mode are grouped in the Interface Configuration.

**Interface Configuration**

General Setup | **Wireless Security** | MAC-Filter | Advanced Settings

ESSID:

Mode:

Network:  ETH1:

lan:

create:

Choose the network(s) you want to attach to this wireless interface or fill out the *create* field to define a new network.

Hide ESSID:

Figure 7-22 Interface Configuration – General Setup

**ESSID:** Name of a wireless. It is used to control the access to the wireless network, only the same ESSID can communicate with each other to establish a local area network.

**Mode:** There are totally 4 wireless modes, including: Client, Access Point, Client (WDS) and Access Point (WDS).

**Access Point:** Access point.

**Client:** A client device that can connect to an AP.

**Client (WDS):** Use WDS feature to link multiple APs in a network, all associated stations from any AP can communicate with each other like in ad-hoc mode. Client (WDS) means this device is a client in WDS mode.

**Access Point (WDS) :** Use WDS feature to link multiple APs in a network, all associated stations from any AP can communicate with each other like in ad-hoc mode. WDS AP means this device is an AP in WDS mode.

**Network:** Choose the network(s) you want to attach to this wireless interface or fill out the create field to define a new network.

**Hide ESSID:** to hide the broadcast name of the wireless network to avoid being connected to others. Check this function; others will not be able to search the SSID.

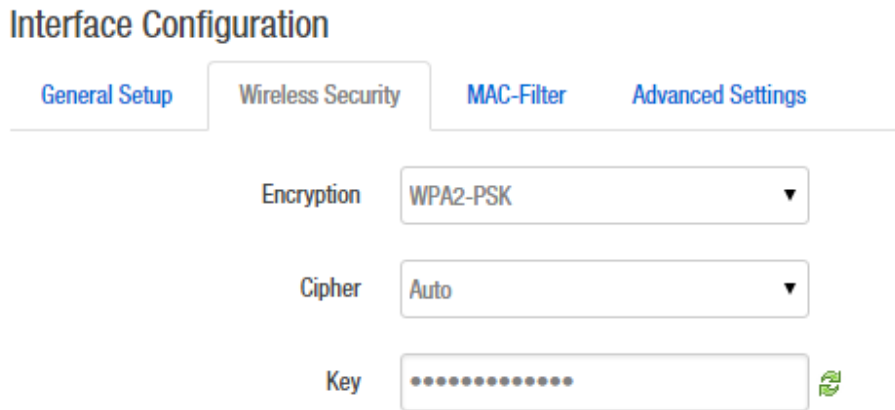

Figure 7-23 Interface Configuration – Wireless Security

**Security:** User can set the security based on needs to guarantee the wireless security. The wireless encryption of the device to be connected to each other must be set to the same encryption.

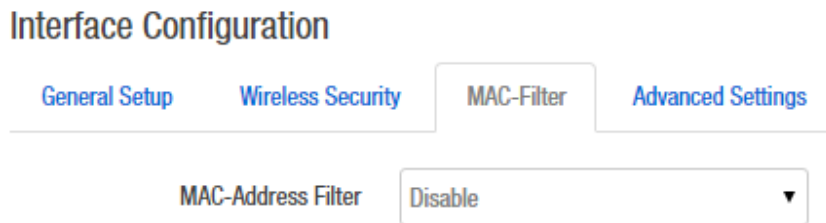

Figure 7-24 Interface Configuration – MAC Address

**MAC - Address Filter:** used to control communication between the device and other devices.

**Allow listed only:** only the list of devices that are allowed to connect to the access point and the other device does not allow access to the access point.

**Allow all except listed:** allow the device to connect to the access point outside the list, and the other device does not allow access to the access point.

## Interface Configuration

General Setup    Wireless Security    MAC-Filter    **Advanced Settings**

802.11h

Separate Clients  Prevents client-to-client communication

UAPSD Enable

WMM Mode

Multicast Rate

Max. Station Num   
(1-127)

Beacon Interval   
(100-3500) ms

IGMP Snooping

Accept All Multicast

Figure 7-25 Interface Configuration – Advanced Settings

**Station Isolation:** Enable this function, STA can't communicate with each other.

**Max Station Limit:** You can set the number of STA that connect to AP.

### 7.3 Firewall

The firewall creates zones over your network interfaces to control network traffic flow. The default settings of firewall zone as shown below.

General Settings   Port Forwards   Traffic Rules   Custom Rules

## Firewall - Zone Settings

The firewall creates zones over your network interfaces to control network traffic flow.

### General Settings

Enable SYN-flood protection

Drop invalid packets

Input

Output

Forward

### Zones

Zone ⇒ Forwardings	Input	Output	Forward	Masquerading	MSS clamping	
lan: lan: [ip icons] ⇒ wan	<input type="text" value="accept"/>	<input type="text" value="accept"/>	<input type="text" value="reject"/>	<input type="checkbox"/>	<input type="checkbox"/>	<input type="button" value="Edit"/> <input type="button" value="Delete"/>
wan: (empty) ⇒ REJECT	<input type="text" value="reject"/>	<input type="text" value="accept"/>	<input type="text" value="reject"/>	<input checked="" type="checkbox"/>	<input checked="" type="checkbox"/>	<input type="button" value="Edit"/> <input type="button" value="Delete"/>

Figure 7-26 Firewall

Click "modify" or "add" to define the generic properties of the zone. In the port trigger section, the forwarding rules for the current area and other areas can be modified.

For example, click on Edit button of LAN zone; as shown below, this section defines common properties of "lan". The input and output options set the default policies for traffic entering and leaving this zone while the forward option describes the policy for forwarded traffic between different networks within the zone. A covered network specifies which available networks are member of this zone.

### Zone "lan"

This section defines common properties of "lan". The *input* and *output* options set the default policies for traffic entering and leaving this zone while the *forward* option describes the policy for forwarded traffic between different networks within the zone. *Covered networks* specifies which available networks are member of this zone.

General Settings
Advanced Settings

Name

Input

Output

Forward

Masquerading

MSS clamping

Covered networks  lan: LAN WAN

*create:*

Figure 7-27 Zone

The options below control the forwarding policies between this zone (lan) and other zones. Destination zones cover forwarded traffic originating from "lan". Source zones match forwarded traffic from other zones targeted at "lan". The forwarding rule is unidirectional, e.g. a forward from lan to wan does not imply a permission to forward from wan to lan as well.

### Inter-Zone Forwarding

The options below control the forwarding policies between this zone (lan) and other zones. *Destination zones* cover forwarded traffic **originating from "lan"**. *Source zones* match forwarded traffic from other zones **targeted at "lan"**. The forwarding rule is *unidirectional*, e.g. a forward from lan to wan does *not* imply a permission to forward from wan to lan as well.

Allow forward to *destination zones*:  wan: (empty)

Allow forward from *source zones*:  wan: (empty)

Figure 7-28 Inter-Zone Forwarding

## 7.4 VLAN

VLANs are often used to separate different network segments. The VLAN function allows user to create multiple virtual local area network. As shown in figure, we add a VLAN on port ath0 (wireless network port). The VLAN ID is 10. The range of VLAN ID is 2~4094. Each VLAN ID represents a different VLAN.

## VLAN

VLANs are often used to separate different network segments.

### VLAN settings

Enable	Interface	VLAN ID	Notes	Sort
<input type="checkbox"/>	Wireless Network:Master "Wireless-Bridge" ▼	10	vlan10	<input type="button" value="↑"/> <input type="button" value="↓"/> <input type="button" value="Delete"/>

Figure 7-29 VLAN Settings

Bridge function is needed to use together with VLAN. As show below, we add VLAN 10 on port eth0 and ath0, they are eth0.10 and ath0.10

## VLAN

VLANs are often used to separate different network segments.

### VLAN settings

Enable	Interface	VLAN ID	Notes	Sort
<input type="checkbox"/>	Wireless Network:Master "Wireless-Bridge" ▼	10	vlan10	<input type="button" value="↑"/> <input type="button" value="↓"/> <input type="button" value="Delete"/>
<input type="checkbox"/>	Ethernet Switch: "eth0" ▼	10	vlan10	<input type="button" value="↑"/> <input type="button" value="↓"/> <input type="button" value="Delete"/>

Figure 7-30 Add VLAN ID

Then we create a new interface and put eth0.10 and ath0.10 into the same bridge in Network->Interfaces page as shown below.

## Create Interface

Name of the new interface

 The allowed characters are: **A-Z**, **a-z**, **0-9** and **\_**

Protocol of the new interface

Create a bridge over multiple interfaces

Interface type to use for this network

Cover the following interfaces







-  Ethernet Switch: "eth0" (lan)
-  VLAN Interface: "eth0.10"
-  Ethernet Adapter: "eth1" (lan)
-  Wireless Network: Master "Wireless-Bridge" (lan)
-  Wireless Adapter: "ath0.10"
-  Custom Interface:

Figure 7-31 Binding VLAN Interfaces

The packets from eth0.10 or ath0.10 will be added a VLAN label which ID is 10. That requires: the opposite wireless connection side must support VLAN 10, the device which connects with eth0 is also need to support VLAN 10 (such as a VLAN Switch).

Common connection mode as shown below:



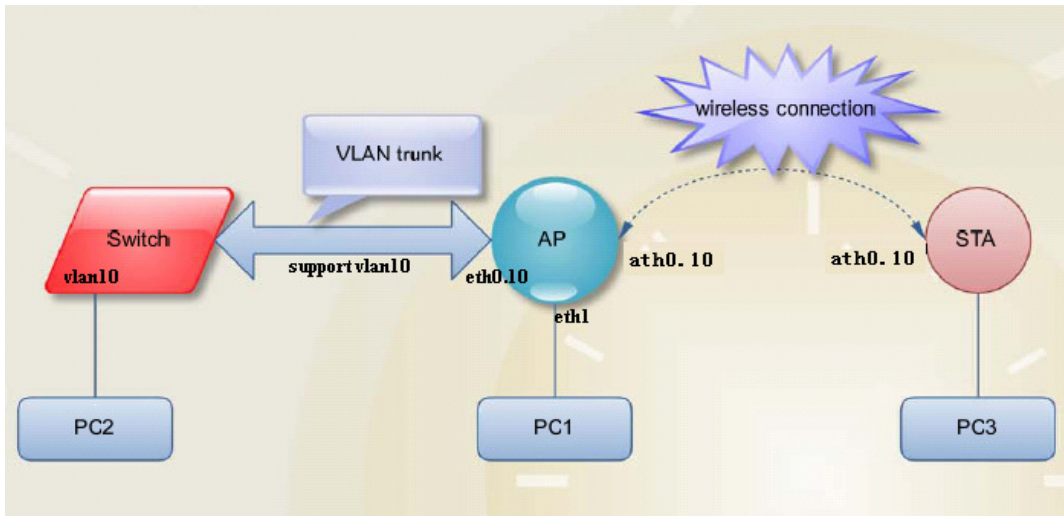

Figure 7-32 VLAN Settings

## 7.5 Ping Watchdog

**Ping Watchdog :** The ping watchdog sets the Device to continuously ping a user-defined IP address (for example, it can be the IP address of the AP the Client is connecting to). If it is unable to ping under the user defined constraints, the device will automatically reboot. It is highly recommended that users enable this feature at the side of “Station” and disable this feature at the side of “Access Point”.

## Ping Watchdog

### Settings

Enable

PING IP address

PING interval(s)   
[?](#) (3 - 86400)

Startup delay(s)   
[?](#) (20 - 86400)

Tries   
[?](#) (1 - 10000)

Figure 7-33 Ping Watchdog

**Ping IP Address** : Specify an IP address of the target which will be monitored by Ping Watchdog. If this feature is enabled at the side of “Client”, Ping IP Address should be the IP address of the AP the Client is connecting to.

**Ping Interval** : Specify time interval (in seconds) between the pings requests are sent by the Ping Watchdog

**Start-up Delay**: specify initial time delay (in seconds) until first ping request is sent by the Ping Watchdog

**Ping Failure** : Specify the number of ping replies. If the specified number of ping replies is not received continuously, the Ping Watchdog will reboot the device.

**Note** : If users want to modify the parameters of Ping Watchdog, please disable it first and then apply. When the web page shows that Ping Watchdog is really disabled, users can now re-enable it with modified parameters.

## Chapter 8 Logout

Click the logout button, it will logout the device and return to the login page.

## Chapter 9 FAQ

### 1. The device cannot be started after power on.

- ① The Ethernet cable between the device and the POE adaptor is more than 40 meters long.
- ② The Ethernet cable quality is not good enough, and it should be Cat 5e or even Cat 6 cable.
- ③ The RJ-45 plugs are not well connected.

### 2. Forgot the IP address of the device.

Please manually push the Reset button for 5~10 seconds and wait 2 or 3 minutes, then the user can log in the device by typing the default IP address 192.168.1.36/192.168.1.35.

### 3. How to modify the IP address of the device?

Please open the device page, followed by click Network -> interfaces -> select Edit button of the LAN interface ->Common Configuration ->General Setup ->IPv4 address; here you can set the IP address according to your own needs. But you should ensure the IP you edit is different with other devices, so as to avoid IP address conflict. <[Chapter 7.1.1](#)>

### 4. The signal level or the wireless TX/RX rate is low

- ① There is a large bunker between Client and access point. Please remove or bypass the bunker.

- ② The scale plate of the client is not directed at the access point. Please adjust the client and access point.
- ③ Switch to other wireless channel cause there are much interferences in this channel.

## **5. Multiple devices are installed at the same area, the packet loss is serious. Change channel can only improve the situation for a while.**

① Multiple devices are installed at the same area, and there is no plan for the frequency settings which will cause the same frequency interference. It is recommended to separate the frequency of the devices. If the channel width is 20M, the frequency difference between two devices should be more than 20MHz. For example, 2412MHz, 2432MHz, 2452MHz etc., or set to non-standard frequency: Click Network - > Wifi - > select the corresponding wireless network SSID and click Edit > Advanced Settings - > Country, select Compliance Test - > Click *Save & Apply* button, then click General Setup -> modify the basic channel and save the application. Please refer to manual *7.2.1 Device configuration* section.

② Multiple devices IP conflict with each other; you need to modify the IP address followed by click Network - > Interfaces -> General Setup ->IPv4 address. Please reference manual 7.1.1 Common Configuration section.

## **6. Mobile phones and computers cannot connect to AP**

TDMA function is not closed, please close the TDMA. Followed by click Network - > Wifi - > select corresponding SSID and click Edit button > Advanced Settings - > check off TDMA. For details, please reference manual *7.2.1 Device Configuration* section.

## **7. Clients often dropped, the speed is slow.**

④ There are too many clients connect to AP, please limit the number of access users.

⑤ AP signal is weak. Please improve AP transmission power or regulating the AP and the user's position.

⑥ Check the saturation of users and network bandwidth.

## **8. I don't want anyone to connect to my device.**

① Modify the password of the access point AP. Followed by click Network - > Wifi - > select corresponding SSID and click Edit - > interface configuration - > Wireless Security. For details, please reference manual 7.2.2 interface configuration section.

② To hide the ESSID of the AP. Followed by click Network - > Wifi - > select corresponding SSID and click Edit button - > interface configuration - > General Setup - > Hide ESSID, to turn off this feature. Please reference manual 7.2.2 interface configuration section.





[www.hikvision.com](http://www.hikvision.com)