

Wireless H3G-TA

ENGINEERING MANUAL



Hangzhou Huasu Jada Technology Co., Ltd

No.16, Xiyuan Wu Road, Westlake Tech-economy Zone, Hangzhou, China

TEL: 0086-571-87967915 FAX:0086-571-87968969

www.huasucn.com

Notice:

1. The wireless H3G-TA device may not cause harmful interference
2. The wireless H3G-TA device must accept any interference received, including interference that may cause undesired operation

This device complies with Part 15 of the FCC Rules. Operation is subject to the following two conditions:

- (1) This device may not cause harmful interference, and
- (2) This device must accept any interference received, including interference that may cause undesired operation.

Attention that changes or modification not expressly approved by the party responsible for compliance could void the user's authority to operate the equipment.

Note: This product has been tested and found to comply with the limits for a Class B digital device, pursuant to Part 15 of the FCC Rules. These limits are designed to provide reasonable protection against harmful interference in a residential installation. This product generates, uses, and can radiate radio frequency energy and, if not installed and used in accordance with the instructions, may cause harmful interference to radio communications. However, there is no guarantee that interference will not occur in a particular installation. If this product does cause harmful interference to radio or television reception, which can be determined by turning the equipment off and on, the user is encouraged to try to correct the interference by one or more of the following measures:

- Reorient or relocate the receiving antenna.
- Increase the separation between the equipment and receiver.
- Connect the equipment into an outlet on a circuit different from that to which the receiver is connected.
- Consult the dealer or an experienced radio/TV technician for help.

This equipment should be installed and operated with a minimum distance 20cm between the radiator and your body.

Hangzhou Huasu Jada Technology Co., Ltd

No.16, Xiyuan Wu Road, Westlake Tech-economy Zone, Hangzhou, China.

CELLCHECK BMS Engineering Manual, P/N HA-0024AAA1, REV.A2.

©2003-2014 HUASU, No.16, Xiyuan Wu Road, Westlake Tech-economy Zone, Hangzhou, China.





This manual may be copied in whole or in part.







Printed in china



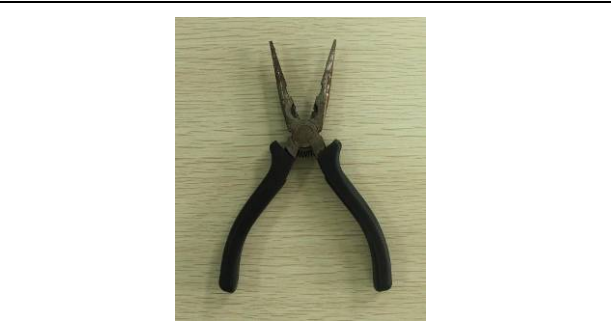

Table of Contents

Tools required for installation and Debugging.....	1
1 Overview.....	3
2 System Components and Module Description.....	5
2.1 System Components.....	5
2.2 TA Module.....	6
2.3 CM Module.....	7
2.4 TC Module.....	9
2.5 Wireless Converter.....	9
3 Installation and Mounting.....	11
3.1 Numbering the Batteries.....	11
3.2 Connecting TA Test Cable To A Battery.....	11
3.3 Mounting TA Module.....	13
Pastes the TA modules on a side of battery case, then plug the TA test cable in the port J1 on the modules (See (1)), the green LED will turn on.	
3.4 Address Setting For TA Module and TC modules.....	13
3.5 Address Setting For TC modules by CM Module.....	16
3.6 CT and TC Module Installation.....	17
3.7 CM Module Installation And Wiring.....	18
CM module can be mounted in a rack or on the battery rack as below:.....	
3.8 Wiring Notice.....	20
4 Settings.....	20
4.1 Easy Setup.....	20
4.2 Data Checking.....	20
4.3 Alarm Checking.....	21
4.4 Internal Resistance Test and Setting.....	21
4.5 Reading Accuracy Checking.....	22
5 Connecting BMS to a Remote Computer.....	22
5.1 Via RS485.....	22
5.2 Via LAN port.....	22
5.3 Via Dry Contact.....	22
6 Advanced Setting.....	23
6.1 Changing Alarm Limits.....	23
6.2 IR Setting.....	23
6.3 Connecting One More Strings To The Same Port On CM Module.....	23
6.4 Online Updating Firmware.....	23
6.5 Setting Capacity Estimation Function (Optional).....	25
7 Menu Description.....	25
8 Appendix 1: Table between Lead-Acid Battery Installation Hours and IR Value.....	26

Tools required for installation and Debugging

NO.	Picture	Description
Installation tools		
1		Socket wrench 12902 Socket head 12307/309/311
2		Multimeter VC9807A+
3		Clamp Meters VC3266D
4		Stripper 91108
5		Phillips-head screwdriver 61213

6	 A flat-head screwdriver with a black handle and a green grip at the end, lying horizontally on a light brown surface.	Flat-head screwdriver 61311
7	 A Phillips-head screwdriver with a red and yellow handle, lying vertically on a light brown surface.	Phillips-head screwdriver 61211
8	 A pair of needle nose pliers with black handles and long, thin jaws, lying vertically on a light brown surface.	Needle nose pliers 70124A
9	 A pair of diagonal pliers with black handles and short, angled jaws, lying vertically on a light brown surface.	Diagonal pliers 70221A
10	 A pair of wire pliers with black handles and a green grip, lying horizontally on a light brown surface.	Wire pliers CP-376TR
11	 A pair of scissors with black handles and silver blades, lying vertically on a light brown surface.	Scissors 03131

12		Wrench 47222
Debugging tools		
13		Lap top
14		485 Converter and wire
15		Engineering manual (this manual)

1 Overview

Wireless H3G-TA battery monitoring system is generally composed of wireless TA module, TC module, wireless converter and CM module. The CM module with LCD display and can upload data through RS485 or network port. In remote monitoring, a computer can be connected to battery monitoring equipment by network or serial port. The monitoring software should be installed on the computer to provide data viewing and remote control. In addition, according to some cases, the site may also needs the installation of cabinets.



Figure 1-1-1

The H3G-TA standard configuration has the following features and functionality:

- Online monitoring of cell voltage, internal resistance, cell temperature, overall voltage, charge and discharge current and ambient temperature.
- Automatic over-limit alarm
- Displays data on CM module
- Key data can be saved on CM module, and a remote computer or a device can access CM module to pool out the data through a RS485 port or Ethernet port
- Comes standard with two dry contact outputs on CM module

Optional features:

- 5.7 inch display

Huasu technology provides its users with easy step-by-step installation plans, engineering drawings, device configuration, wiring methods and wiring diagram.

Installation steps are as follows:









- Check inventory of equipment and accessories according to the packing list upon arrival.
- A detailed explanation of Installation plan with step by step instructions following the engineering drawings will be provided with on-site installation by a Huasu Engineer or Agent. Conditions will be determined at the installation location as well as the methods of alignment. Once the Engineer has properly installed and explained instructions of operation and maintenance to the user and client, approval is required by the client.
- Mounting equipment.
- Wiring.
- Testing.
- Check before approval.
- Training

The above contents will be described in detail below.

2 System Components and Module Description

2.1 System Components

Standard configuration below:

Part Number	Picture	Descriptive name
1		TA Module
2		CM Module
3		TC Module
4		Current Transfer (CT)
5		TA test cable
6		TC test cable
7		TA communication cable
8		Power cable

9		Wireless converter
---	--	--------------------

Optional parts:

Part number	Picture	Descriptive name
1		Monitoring Module

The system topology is below:

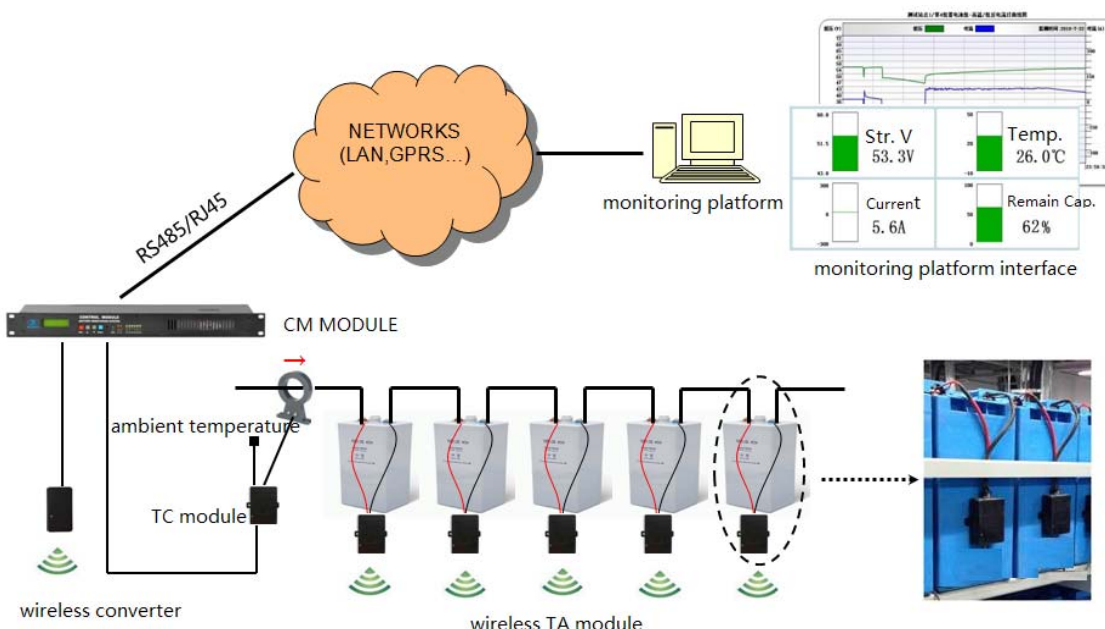

Figure 2-1-1

2.2 TA Module

The TA Module monitors cell voltage of a single battery, internal resistance and temperature and uploads data via the communications port. The TA Module doesn't have an alarm function. It is powered by monitored battery. The module comes in 2V type, with maximum current less than 40mA, for 6V and 12V type, with maximum current of less than 20mA. The module should only be used with its assigned battery type; otherwise, damage to the module may occur.

The module interface is described in the following figure below.

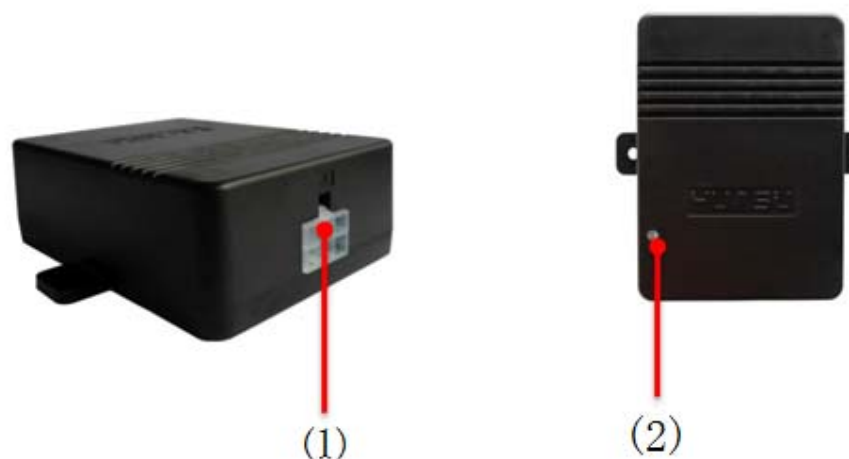

Figure 2-2-1

NO.	Name	Description
(1)	J1	Test port, connects with battery negative and positive poles.
(2)	LED	A double colors LED with a red and green light, the green light indicates power on, the red shows that communication is connected.

2.3 CM Module

The CM Module connects with TA modules and receives data including cell voltage, cell internal resistance and cell temperature. The CM Module displays all battery data. One CM module can manage up to 6 battery strings and each string is up to 300 batteries. The details of functionality are shown below:

- a、 Reads data from TA module.
- b、 Comes with an LCD Display that checks real-time monitoring data and shows history of alarm records.
- c、 Can set parameters for operation limitations.
- d、 Automatic alarm function. In the event of an alarm, an LED light will flash and a buzzer will sound, the corresponding dry contact will automatically shut off.
- e、 Connects to a host computer through an RS485 or a Ethernet port.

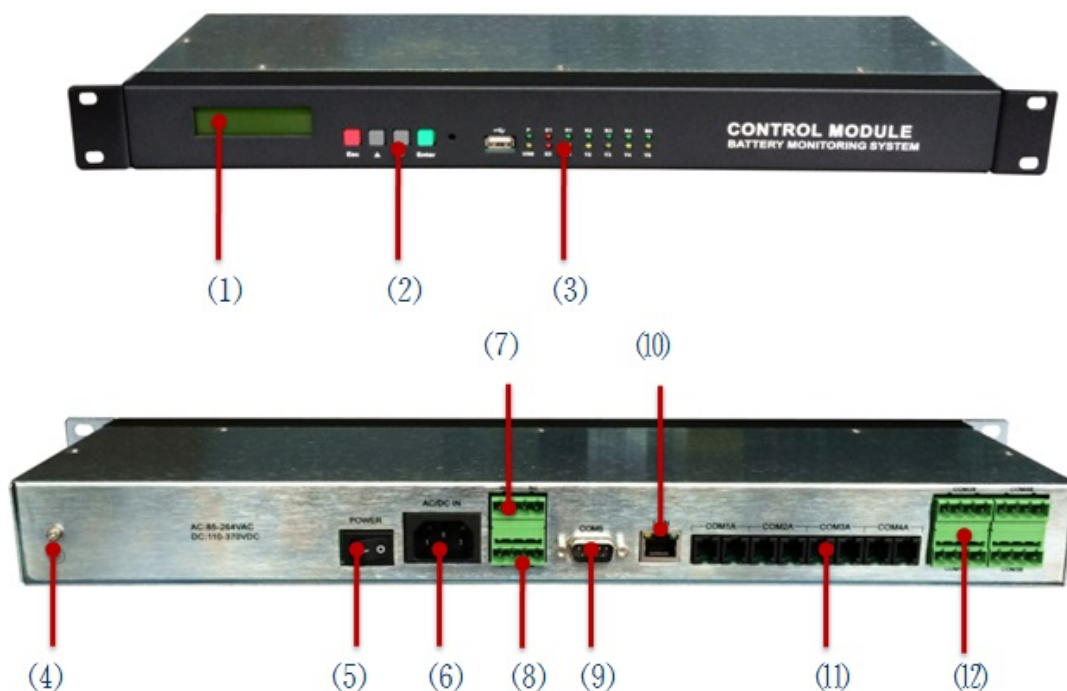

Figure 2-3-1

NO.	Name	Description
(1)	LCD display	Two lines of text are displayed, 122X32.
(2)	Button	Total of four buttons, “Esc” for exit, “▲”“▼”for page up/page down, “Enter” for confirmation.
(3)	LED	POWER: is the power light; E1:indicates a communication error; E2: indicates a battery alarm; Rx1/Tx1:COM1 is sending and receiving data; Rx2/Tx2、Rx3/Tx3、Rx4/Tx4、Rx5/Tx5: corresponds with COM2、COM3、COM4 and COM5 .
(4)	Ground	Connects to the ground.
(5)	Power switch	Controls CM Module power input.
(6)	Power Input	100~240VAC input, less than 15W for each CM module.
(7)	For future	-----
(8)	Dry Contact	J1 for module or communication error, J2 for battery alarm, DC220V/1A
(9)	COM5 port	Data upload port that connects to a remote computer through an RS485, Pin9 is - and Pin5 is +, the baud rate is 19200BPS.
(10)	LAN	10M/100M, RJ45,communicates with a LAN.
(11)	COM1A-COM4A	Connects to TA modules or a TC module, one port is able to communicate with 240 modules.
(12)	COM1B-COM4B	Supplies a 12 Volts power to CT module. Pin 3 is +, pin 4 is -.

2.4 TC Module

The TC Module monitors charge and discharge current and ambient temperature for one string. The TC Module communicates with the CM module through the COM1 and COM2 parallel port. One string needs one TC Module. The following details are shown below.

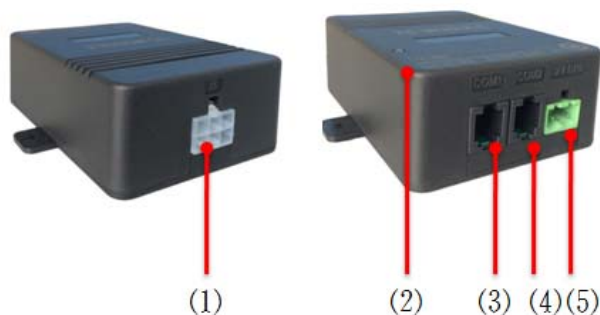

Figure 2-4-1

NO.	Name	Description
(1)	J1 port	Connects to the current transformer and the ambient temperature sensor.
(2)	LED	A double colors LED with a red and green light, the green light indicates power on, the red shows that communication is connected.
(3) (4)	COM1/COM2 port	This is an internal parallel UART Port, which are used in communication with a TA Module and a CM module.
(4)	VIN port	Power input, DC8-13V, where the left is + and right is -, Powered by the CM Module, where the maximum power is less than 2 watts.

2.5 Wireless Converter

The Wireless Converter is used for communicating with TA modules. It max connects 247 TA Modules.

The following details are shown below.



Figure 2-5-1

NO.	Name	Description
(1)	Communication Power Port	It's a 4 core for collecting the pins of COM1B~COM4B on CM module. From the left are B、A、 +、 -,where B is – of RS485, A is + of RS485, baud rate is 9600BPS, +/- is a 12VDC input with maximum 0.3W power dissipation.
(2)	LED	A double colors LED with a red and green light, the green light indicates power on, the red shows that communication is connected.

3 Installation and Mounting

3.1 Numbering the Batteries

Before connecting the TA Modules to the batteries, the batteries should be numbered and labeled correctly by using a label to paste on the surface of the battery where the labels are easy to be seen. The first battery, or, battery NO.1 must be the first one on the string positive terminal, the NO.2 is the battery following the NO.1 battery, and so on. The last battery is the one attached closest to the string negative terminal. The batteries must be numbered in accordance with this method.

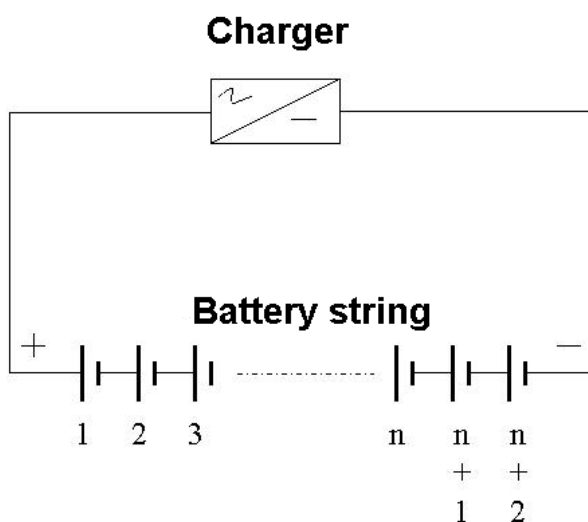

Figure 3-2-1



Figure 3-2-2

3.2 Connecting TA Test Cable To A Battery

Each battery should be connected to one TA test cable on its poles. Put the red wires on the positive pole of the battery (See (1)), and the black ones for the negative pole(See (2)).

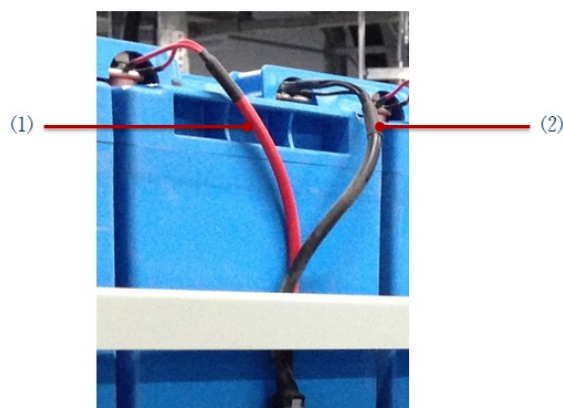

Figure 3-2-1

It is important to note that the TA test line must be installed on the outside of the battery connection bar (cable) and is not allowed to install between the battery pole and the connection bar. The following details are shown below.

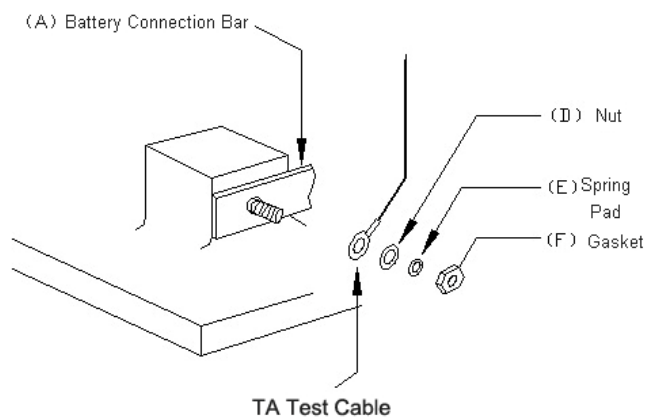

Figure 3-2-2

Notice: After all installation work is completed, each battery pole screw tightness must be checked and marked as follows:
Manually attempt to turn the sampling terminal on the battery pole to make sure that it is firmly tightened and marked on the screw with an oily marker as shown in the figure below.

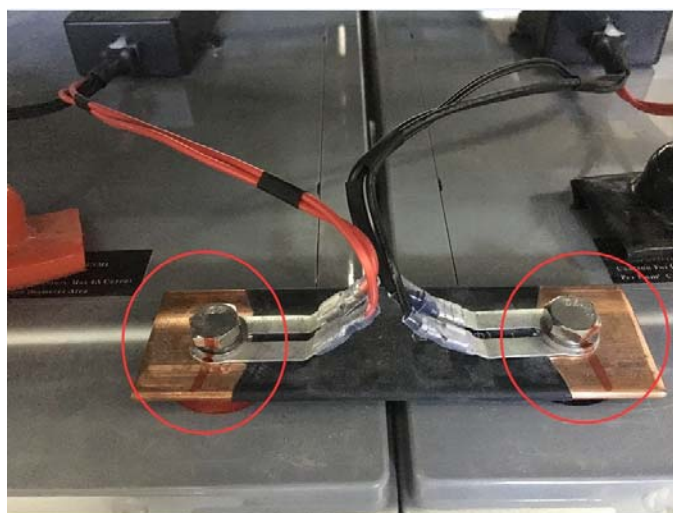

Figure 3-2-3

3.3 Mounting TA Module

Pastes the TA modules on a side of battery case, then plug the TA test cable in the port J1 on the modules (See (1)), the green LED will turn on.

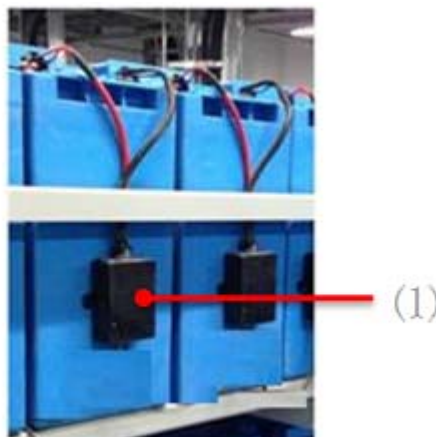

Figure 3-3-1

The TA module consumes only a small amount of current, but if the battery is not charged for a long time (more than a month) after installation, we suggest that the TA test line to be pulled out of the J1 port.

3.4 Address Setting For TA Module and TC modules

Way 1 Using address module to set TA module address

If a lot of modules need to be set, using a address module will be more convenient. Just connect the address module to the TA module's COM1, and set the new address on the address module then enter, the address will be changed to new one.

Set the 32 batteries of each group and total two strings as an example. In the first group, the TA addresses are set from 1 to 32, and the address of TC is: 241, (TA and TC default addresses are all 1), and the second group TA addresses are set from 1 to 32, TC is 241.

Address Setting For TA Module

Turn on the side switch and press the "ESC" button, then set the address by “▲▼” button → press "Enter" button to "H-A" interface → select "H-L" button by “▲▼” button → press "Enter" key to “000” modifying interface → set port number by “▲▼” button → press "Enter" key to address interface → press the "Enter" key to confirm the modification → connect the TA module with the battery test cable (this operation needs to be finished within 10 seconds), when the address of the address modifier is automatically added 1, and the ACTIVE light shows the green, it indicates that the modification is successful and you can continue to modify the next module.

Address Setting For TC Module

Turn on the side switch and use the communication line to connect the TC module → press the "ESC" button and setting address by “▲▼” button → press "Enter" button to "H-A" interface → select "H-C" by “▲▼” button → press "Enter" key to address interface → press "Enter" key to confirm the modification..

Notice:

- 1."H-L" means modifying TA address, "H-C" means modifying TC module address.
2. The port number starts from 000 and increments up in turn. All battery string port numbers in the field cannot be repeated.

3. When modifying the TA module address, you need to change one by one.
4. Each TA module / TC module needs to set the address separately, and the default address is 1.
5. For the same battery string, the TA module port number needs to be consistent with the wireless converter port number.



Figure 3-4-1

Modification method of wireless converter port number

The wiring diagram is as follows:

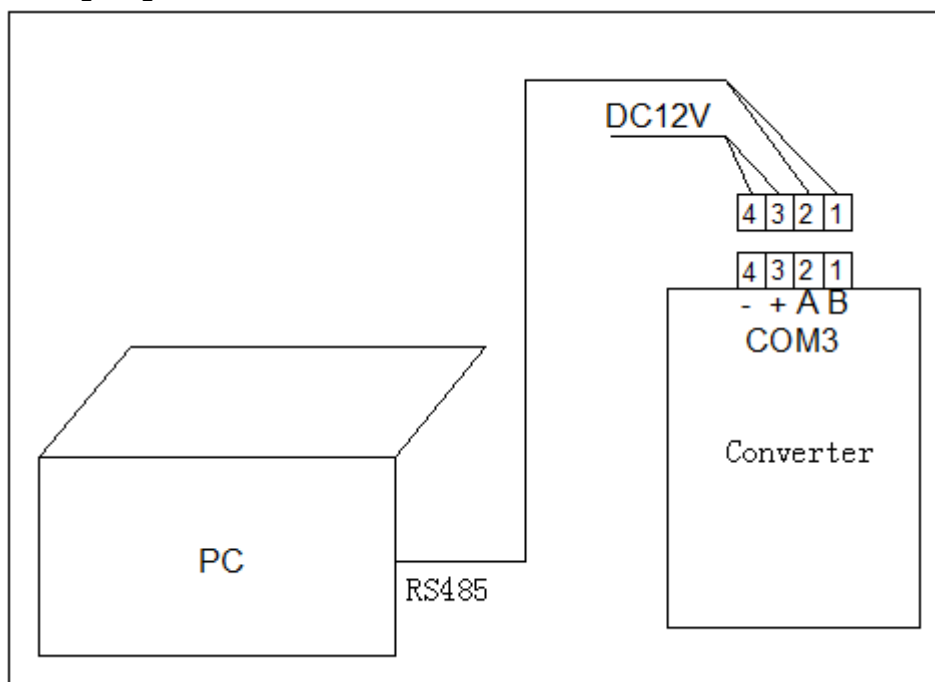

Opening serial port software and sending modification command according to protocol. Sending "AA55 01 06 00 1D 00 XX +CRC16" command to modify wireless converter port number and "XX" is the target port number, and the "01 06 00 1D 00 XX CRC16" command needs to be preceded by AA55 after verification.

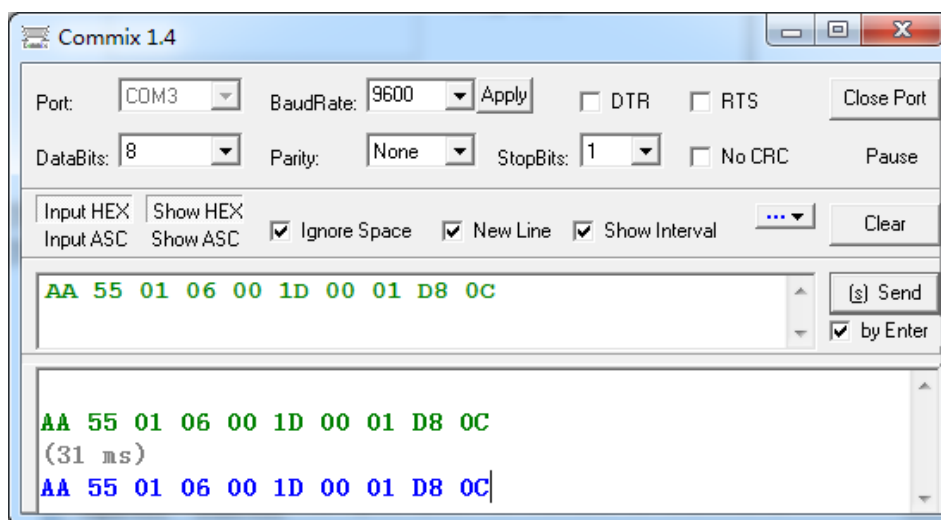

The TA address modifier can be used to modify TA and TC module addresses. This way for modifying is more conveniently and quickly, especially when modifying in large quantities. If you need a TA address modifier, you can contact us directly to buy.

Way 2 TA Module address and port number setting by serial port Software

Set the 32 batteries of each group and total 2 strings as an example. In the first group, the TA addresses are set from 1 to 32, and the address of TC is: 241, (TA and TC default addresses are all 1), and the second group TA addresses are set from 1 to 32, TC is 241.

Connection is below:

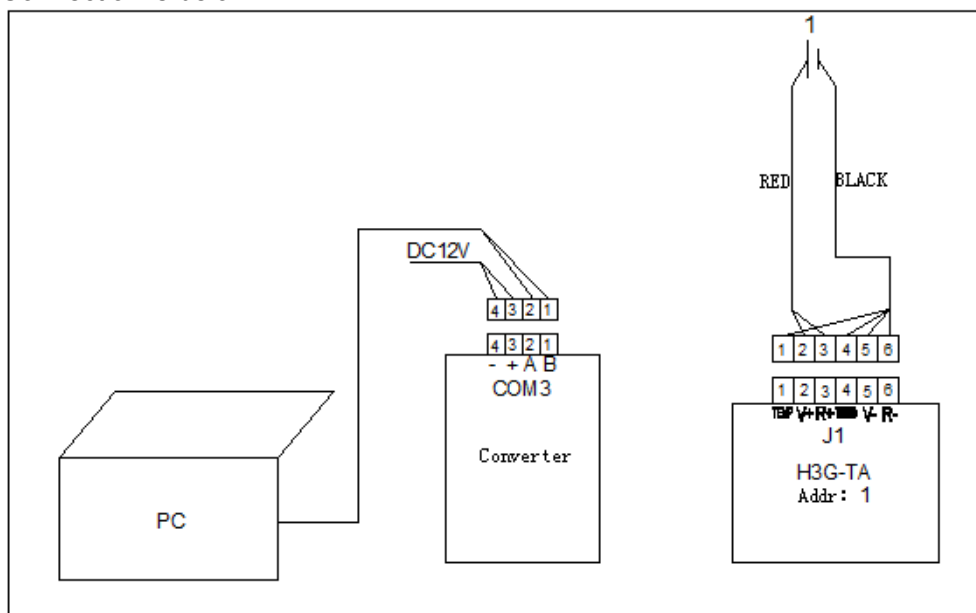

Address Setting For TA Module

Starting the serial port software and sending the modification commands according to the agreement. Sending "010600 0E 00 XX+CRC16" and XX is the target address.

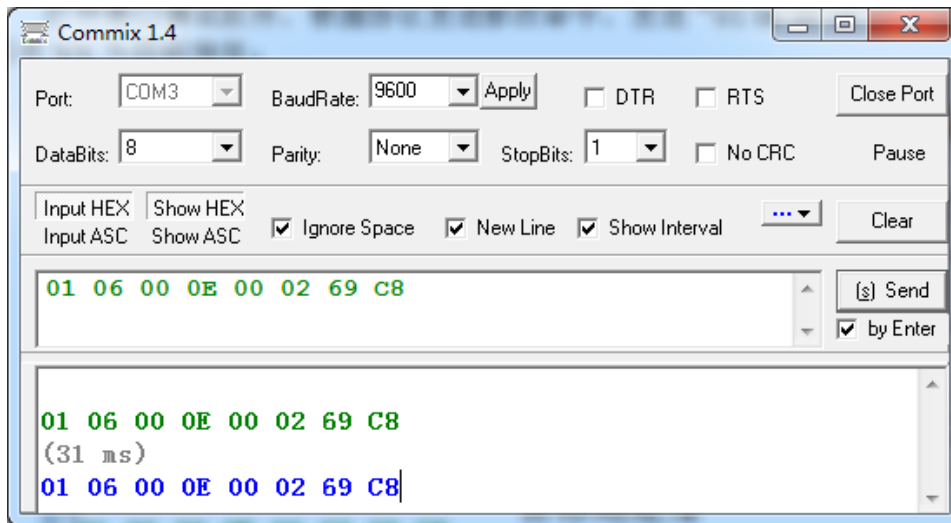

Port Number Setting for TA Module

Starting the serial port software and sending the modification commands "01 06 00 1D 00 XX+CRC16" and XX is the port number.

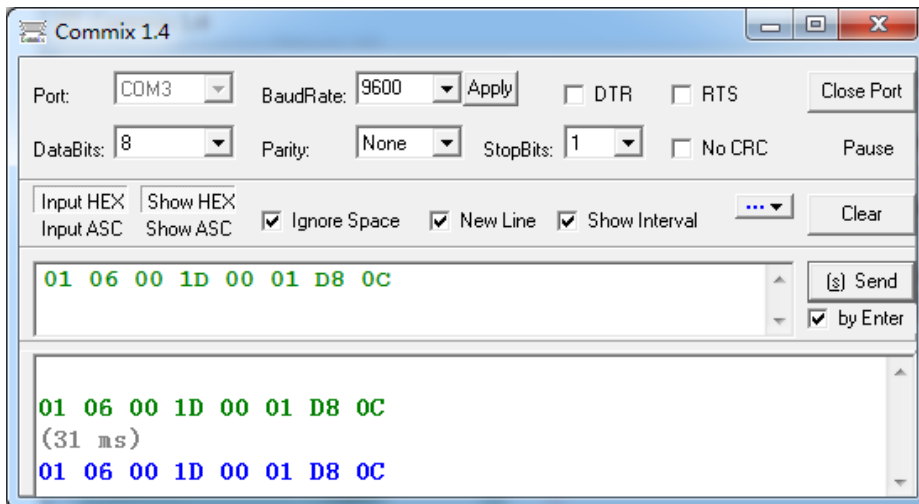

3.5 Address Setting For TC modules by CM Module

Connecting COM1 or COM2 port of the TC module to the COM1A port of the CM module, and the COM1B port cannot be connected to the wireless converter. Powering TC module with DC12V from the COM1B port 3 / 4 pin of the CM module, and then modifying as following:

ESC → C Setup (password: 2022) → 4 Mod → 4.3 Mod. Addr

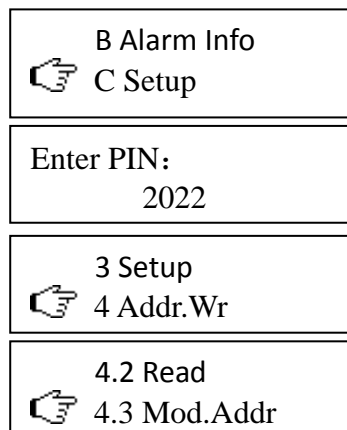

COM1, TC-Mod, 1
COM1, TC-Mod,241
COM1, TC-Mod,242 TC-Mod, 1→241

Notice: Modifying module type by “▲▼”

Notice:Module type is TC module, address is 241

Notice: 1→241 means address modifying is successful, 1 is modified to 241

3.6 CT and TC Module Installation

The Current Transfer (CT) should be mounted on a battery cable and let the cable go through the CT.



Figure 3-5-1

Keep the direction same between it showed on the CT and charge current flows.

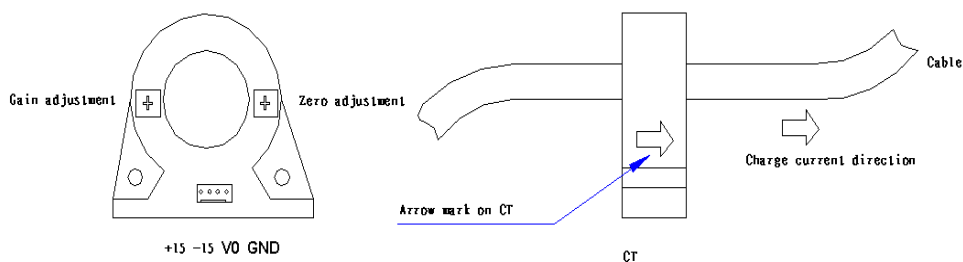

Figure 3-5-2

The TC module can be mounted on the battery rack near the CT, the cable (1) is a TC test cable, the other end of which connects to the CT, the communication cable (2) connects TC module and the first TA module, the cable (3) connects the TC module to a CM module. The power for the TC module is from the CM module through the cable (4).

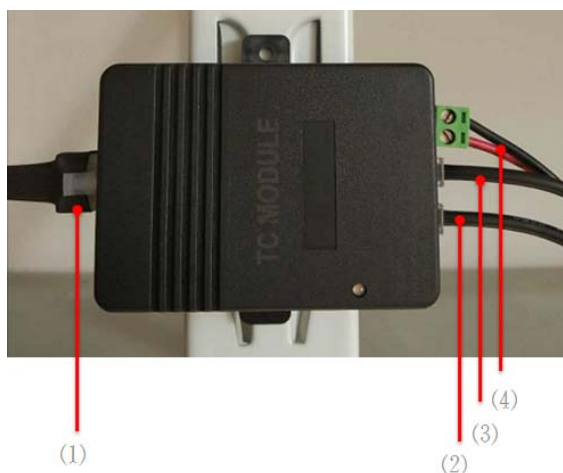

Figure 3-5-3

The default address for TC module is 1, which can be changed with the CM module or the address module like the way the TA module does. The address assigned to TC module is 241 by “Easy Setup”, so the TC module’s address should be changed to that address before connecting to CM module.

3.7 CM Module Installation And Wiring

CM module can be mounted in a rack or on the battery rack as below:



19 Cabinet

Figure 3-6-1



Battery Rack

Figure 3-6-2

The CM module combine with wireless converter to communicate with TA, and connecting TC modules via the ports COM1A, COM2A, COM3A and COM4A. Normally, connect one wireless converter with one battery string, then come to CM module’s COM1A and make a cycle like the drawing below. Also need a power supply from COM1B’s pin 3 and pin 4 for the TC module on VIN.

Connect the CM module on the port AC/DC IN to a power supply, the voltage range of which is required from 85V~264VAC or 110V~370VDC.

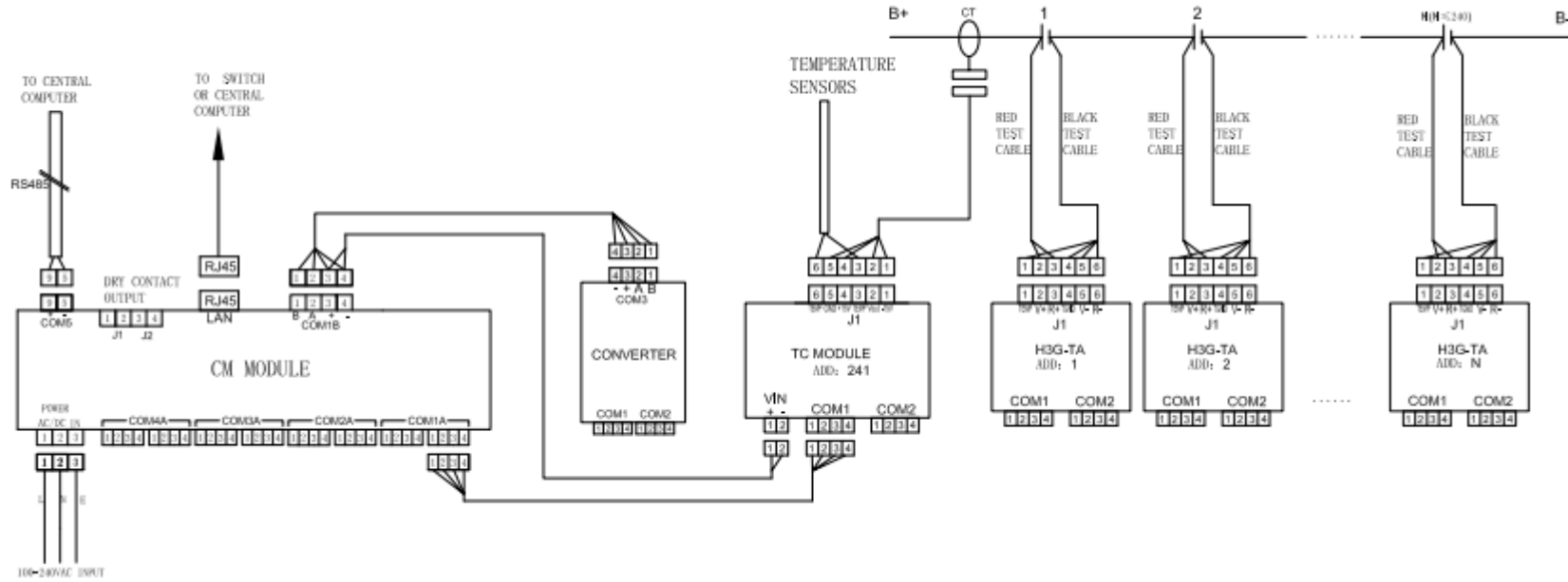

3.8 Wiring Notice

The wiring should be clear. The intuitive part should be horizontal and vertical as far as possible, and the part near the battery should be orderly which should not look disorderly (the direction of installation of the collecting wiring ring should be the same) Where there is a need to wire from a trench, it needs to ask the user if it is necessary to add a PVC tube to the harness.

4 Settings

Turn on the power switch on the rear panel of the CM module, press the button “Esc” after seconds, it will display the main interface on the LCD like below:

```
1#: OK  2#: --  3#: --
4#: --  5#: --  6#: --
```

4.1 Easy Setup

When it's the first time to run the CM module, strongly advise to use “1 Easy Setup” to finish parameter settings.

Press the button “Esc” on the main interface → “C. Setup” → Enter password 2022 → “1 Easy Setup”, then enter string number which could be up to 6:

```
Set→String Qty
      1
```

And basic information for each string, then CM module will set the rest parameters automatically. But resistance base values for each battery should be set manually, please follow the instructions in another item.

```
S1→Basic Set
      2V, 300AH, 40
```

That “Easy Setup” will assign each communication port on CM module for different string, for a sample, port COM1A for string1, port COM2A for string2, etc. So when you connect the TA and TC modules for each string, you must follow this rule and it means all TA and TC modules for string1 must be connected to the port COM1A.

The address assigned to TC module is 241 by “Easy Setup”, so the TC module's address should be changed to that address before connecting to CM module.

After getting above steps done, press the button “Esc” to go back to the main interface.

4.2 Data Checking

See all data on CM module to check if all wirings and parameters are correct. Enter the menu “A. Mon. Data” → Select string then press “Enter”:

```
S1 V-data time:
      2014-02-11 15: 04
```

The time is the last updated time for battery voltage values. Press “▼” :

```
S1 R-data time:
      2014-02-01 00: 04
```

The time is the last updated time for battery resistance values. Continue to press “▼” :

S1 V&C: 352.5V +0.1A

“V” means string voltage and “C” means string current. Continue to press “▼” :

S1-001#: +23.5 °C 13.235V 3256 uΩ

It is showed the temperature, voltage and IR for battery 1 of string 1. Continue to press “▼” and will see the data for each battery. At the last page the ambient temperatures will be displayed:

Ambient: +23.5°C +23.5 °C

If finding any incorrect values, need to check the wirings, parameters and others related.

4.3 Alarm Checking

Any alarm happened, a sign “!” will appear on the main interface and the lamps on the front panel will light up.

1#: !	2#: OK	3#: --
4#: --	5#: --	6#: --

Press “Enter” to see the details:

S1 C/V alarm S1 S/V alarm

S1: String 1
C/V: Cell voltage
S/V: String voltage

To see more detailed, enter the menu “B Alarm Info.” → “B.1 Curr. Alm.” → Choose a string → Use “▲” or “▼” to see all alarms.

In the menu “B.2 Alarm Rec.” all recovered alarms will be showed.

During alarming, the buzzer in CM module will turn on and press “Esc” twice to turn it off. Also it can be shut down in the menu “5.5 Beep Ctrl”.

4.4 Internal Resistance Test and Setting

The CM module will perform IR test once a month automatically, and for the first time to run it, IR test should be done manually for getting the base IR values for each battery.

In the menu “2 R Test”, choose a string then press “Enter” to start a IR test, which will take around 10 minutes to half hours depends on battery number. If you want to interrupt the process during IR test, just switch off the CM module.

After finishing a IR test, the setting for the base IR values should be done as below.

For New Batteries

After performing a resistance test, the values can be used as a standard resistance for those specific batteries. See the steps below to set a standard resistance setting.

“3 Setup”→“3.8 R Set”→Choose the string then press “Enter”, the last IR values will be saved as standard IR values. After that, CM will alarm if any IR value is higher 50% than the standard one during an IR test.

For Old Batteries

After performing a resistance test on the old batteries, work out the average value as a standard resistance. See the steps below to set a standard resistance setting for old batteries.

“3 Setup” → “3.7 Initial R”→Choose the string → Press “▲”to the page with “All”, then enter the average value.

4.5 Reading Accuracy Checking

Using a valid meter to measure each battery’s voltage and temperature, or just choose the 5 batteries with the highest values and the 5 batteries with the lowest values to measure, then compare the results with the readings on CM module and check if it is meet the requirements.

For IR, as the equipments with different IR test methods will get different results, so usually just to check the repeating accuracy. Perform IR test for 3 times and calculate the repeating accuracy. For most applications, 5% is acceptable for IR repeating accuracy.

In some projects, customers will require the IR values match to some IR meters from other companies. Our BMS can be done to close the values from that kind of meters in the menu “ 4 Addr. Wr.”→ “4.1 Addr. Wr.” → change the value in the register 464071.

5 Connecting BMS to a Remote Computer

5.1 Via RS485

The COM5 on the CM Module is used to connect to a remote computer. It complies with the MODBUS proposal.

Communication type: RS-485/2 wires

Baud rate: 19200 BPS

Pin layout: pin 9 is -, pin 5 is +

In the event that a device needs to connect two or more CM Modules through the same RS485 bus, the CM Module’s addresses need to be changed. The default address is 1, and follows the below steps to change it:

“3 Setup” → “3.3 GL Set” → Press “▼” to the page “Mod Addr” to enter a new address.

5.2 Via LAN port

The port LAN on the CM module supports the proposals like MODBUS/TCP and SNMP, the IP for the port can be set in the menu “3 Setup” → “3.3 GL Set” →Press “▼” to the page “IP Addr” , “Mask”, “Gateway” to finish the settings.

5.3 Via Dry Contact

There are two dry contacts on the rear panel on the CM module with J1 and J2, J1 for module or communication error and J2 for battery alarm. The contacts can stand the voltage DC220V with 1A current.

6 Advanced Setting

6.1 Changing Alarm Limits

In the menu “3 Setup” → “3.5 Str Set” → Choose a string then press “▼” to the page where you want to change the parameters.

6.2 IR Setting

Changing IR alarm limit

The default rate is 50% that means the battery IR is higher 50% than the standard one stored in the CM, CM will give an IR alarm.

That rate can be changed in the menu “3 Setup” → “3.5 Str Set” → Choose a string then press “▼” to the page “Times R”, enter a new one and save it.

Changing IR cycle's number

For one battery string, if the battery number is less than 60, the IR cycle's number is same as the battery one, if it is more than 60, the IR cycle's number is 60. On the page “Cycle Set” in the menu “3.5 Str Set”, the cycle number can be changed to one bigger than 10.

Changing IR interval time

Every month IR test will be performed automatically, which can be changed to one day or several days on the page “R Interval” in the menu “3.3 GL Set”.

6.3 Connecting One More Strings To The Same Port On CM Module

Each port of CM module is assigned for one string after a “Easy Setup”, if you want to connect another string's TA and TC modules to the same port, the below steps should be done.

“3 Setup” → “3.5 Str Set” → Choose a string then press “▼” to the page “DCM addr”, enter the port number and the address of the first TA module in the string.

Rd→S1→DCM addr
COM1, 1

6.4 Online Updating Firmware

CM module's firmware can be updated online on the port LAN via an Ethernet. Connect a computer to the CM module or both connect to an Ethernet. Run IE on the computer and enter the CM's address (192.168.0.105 from factory):

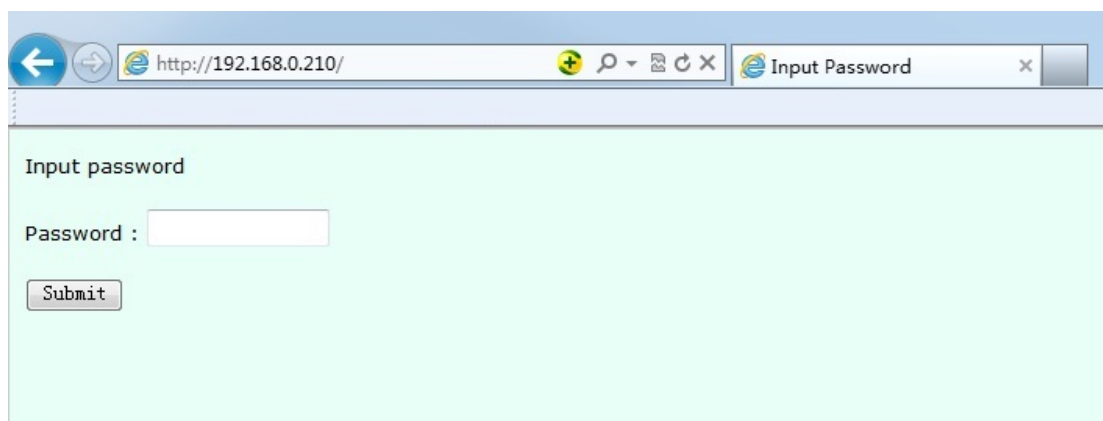

Enter 2022 in the password blank:

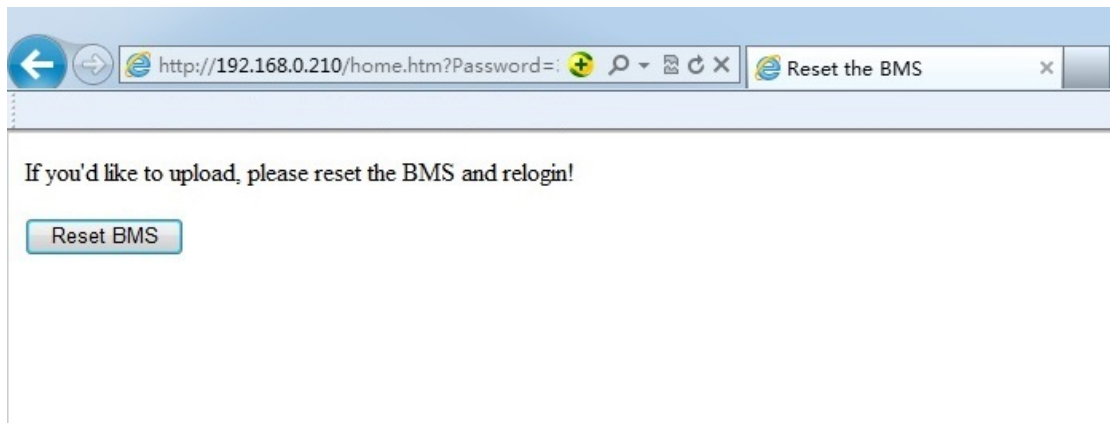

Click 'Reset BMS':

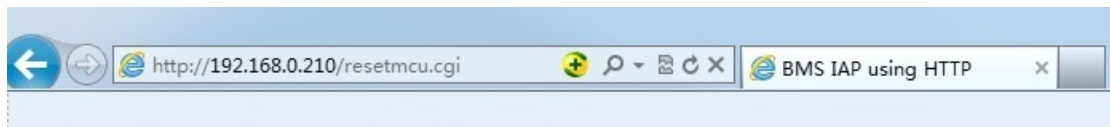

BMS Reset Done ! Please flash the webpage.

After reloading the web, enter admin in the User ID blank and 2022 in the Password blank:

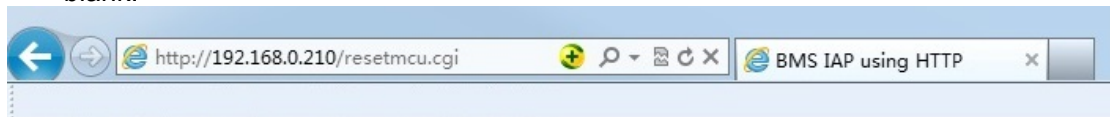

Login

Enter user ID and password:

User ID Password

Login

Choose a new firmware file and click 'Upload':

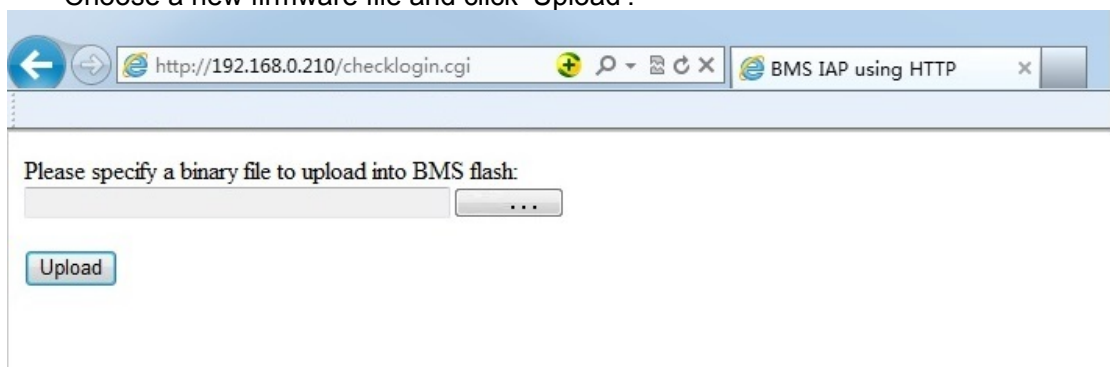

The updating process starts and will finish in few minutes.

6.5 Setting Capacity Estimation Function (Optional)

The capacity estimation function is optional. At present, the capacity estimated by this function is only for your reference and some models of H3G-TA cannot support this function. This function is turned off when you received and can be turned on by the CM Module menu. The step is as following,

3 Setup→3.4 Features /B.1 Sys Feat / Cap.Est/C1 and keep pressing Enter button to “Cap.Est”, and choose this function, then press “▼” button to “C1 Display/Cap.Est” and keep pressing Enter button to “Cap.Est”, then press “▼” to choose this function.

7 Menu Description

Menu name	Description
A.Mon.Data	View monitored battery data
B.Alarm Info.	View the last 100 alarm records
B.1 Curr. Alm.	Not recovered alarms
B.2 Alarm Rec.	recovered alarms
C.Setup	Set all parameters
1 Easy Setup	A easy way to set all parameters
2 R Test	Perform a resistance manually
3Setup	
3.1 Evt Hist	The last 50 event records
3.2 Alm Hist	The last 100 alarm records
3.3 GL Set	All general parameters
3.4 Features	Choose features
3.5 String Set	Set all parameters for a string
3.6 Mod Para	Change TA or TC module's address
3.7 Initial R	Standard resistance value for each battery
3.8 R Reset	Replace the standard IR values with the last measured ones
4 Addr. Wr.	
4.1 Addr. Wr.	Change the value in a register
4.2 Read	Read the value in a register
5 Tools	
5.1 Erase Data	Erase records in Main Module
5.2 Load Fac.	Recover all parameters to factory settings
5.3 Load Def.	Recover all parameters to default settings
5.4 Save Def.	Save the current settings as a default
5.5 Beep Ctrl	Turn on or off the beep
6 Reset	Restart CM module

8 Appendix 1: Table between Lead-Acid Battery Installation Hours and IR Value

Capacity (AH)	2V (mΩ)	6V (mΩ)	12V (mΩ)
100	1.55	4.65	9.30
150	1.15	3.45	6.90
200	0.85	2.55	5.10
320	0.57	1.71	---
410	0.39	1.17	---
510	0.32	0.96	---
750	0.25	---	---
1000	0.21	---	---
1680	0.16	---	---
2175	0.11	---	---

Description:

1. The appendix 1table refers to the data of the BATTCON Annual meeting for reference only.
2. Even if the same manufacturer has the same batch of products, there may be differences in internal resistance, so the measured internal resistance does not necessarily mean that the battery performance changes.

Records

- A0 (20130124) : Distribution edition
- A1 (20130801) : Added TA and TC module address modification method
- A2 (20140220) : Added a description of the address modifier
- A3 (20140422) : Modifying the instructions and menus for internal resistance cycle assignment for use in programs after version A 5
- A5 (20150326) : This version applies to the new CM module.
- A6 (20150710) : Added the method for modifying TA module address with new CM module.
- A7 (20150928) : Added instructions for the upgrade program
- A8 (20171108) : 1. Add wireless TAT TC address modification detailed method.
2. Some parameters were modified.