

PPSTRONG

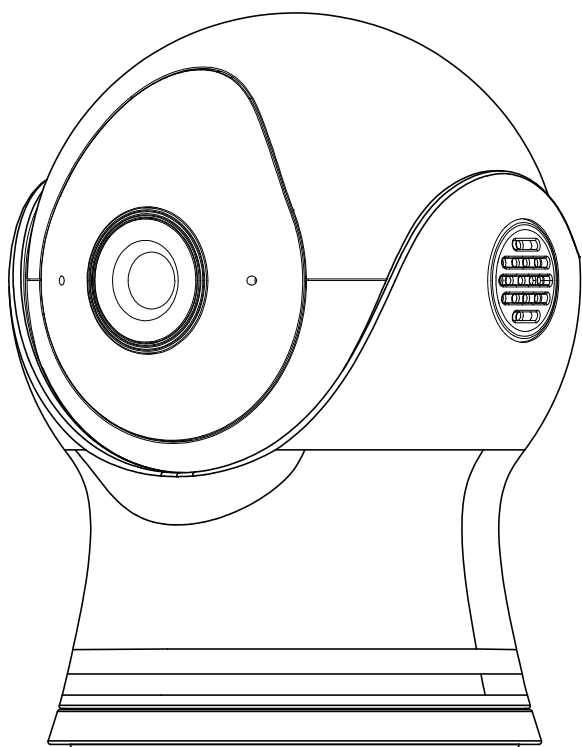

WiFi
Day & Night
Network Camera
Mini

Quick Install Guide

What's in the box

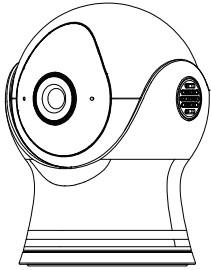

Camera

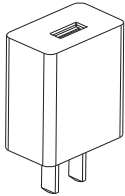

Power adapter

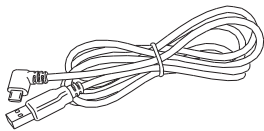

USB Cable

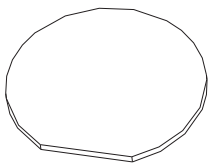

Adhesive tape

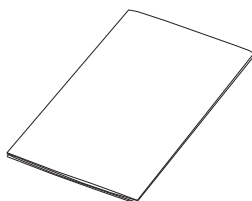

I/M

1 Install the App

Two ways to download

1. Visit the App Store, Google Play to search "[WeEye](#)" and download the free app on your smartphone.
2. Scan the following QR code to download.



Attention:

For Android, it might pop up the security warning of getting location permission. Just click "[Allow](#)" to continue.

Register / Log in

For the new user, you should register an account via your Email.

Step 1: Start the App and tap "Sign Up" at the bottom of the page.

Step 2: Key in your email address and password in the corresponding fields.

Step 3: Click on "OK" when it is be done.

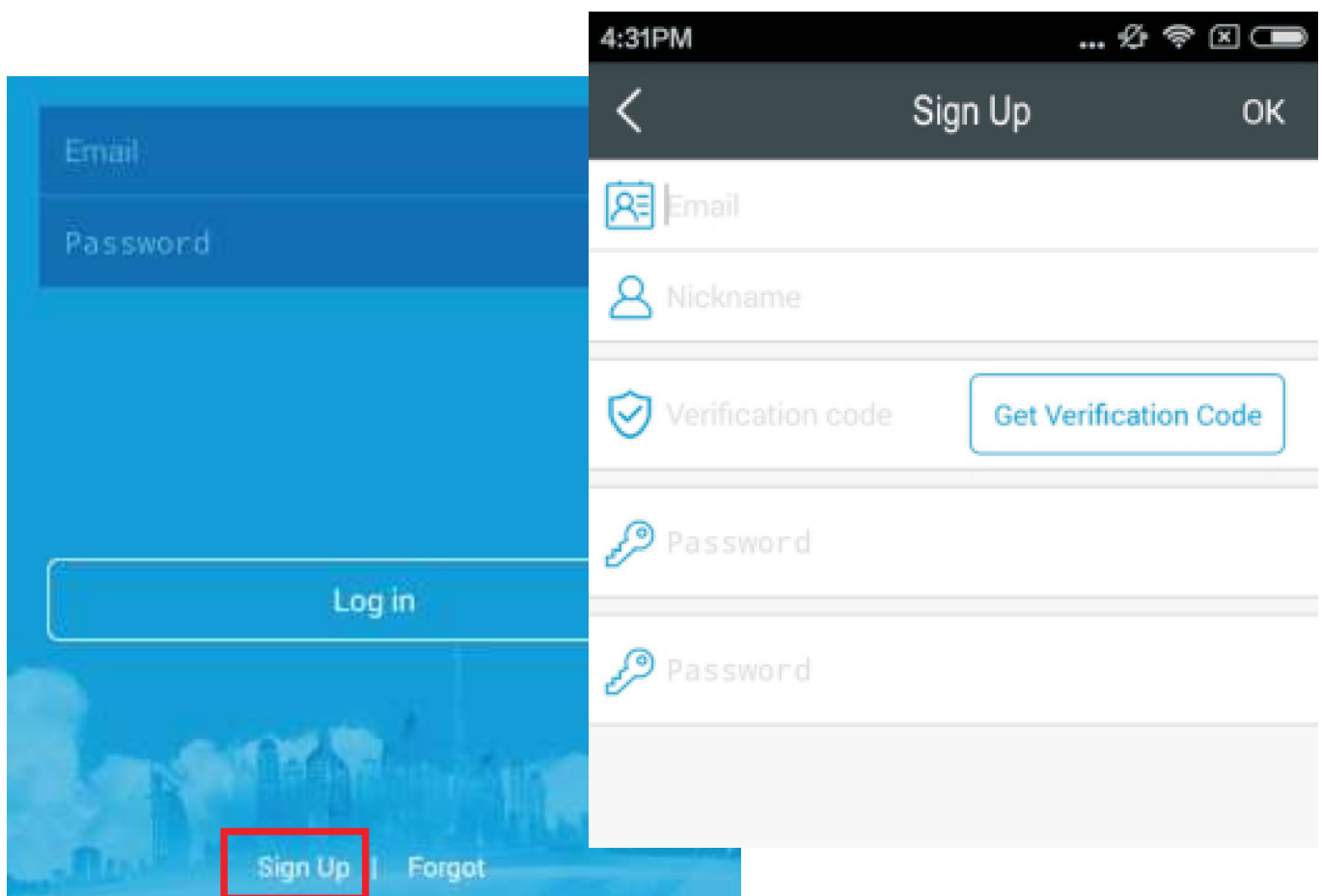

2 Set-up your camera

1. Set with Smart Wi-Fi

Step 1: Powered on the camera firstly, then wait for the voice of "Do-do", after few seconds the red light will blinked.

Step 2: Go onto the "Camera" page, click on the icon "+" and choose [WiFi Add](#).

Step 3: Enter the password of the Wi-Fi router that your smartphone connected. Then tap the "Next".

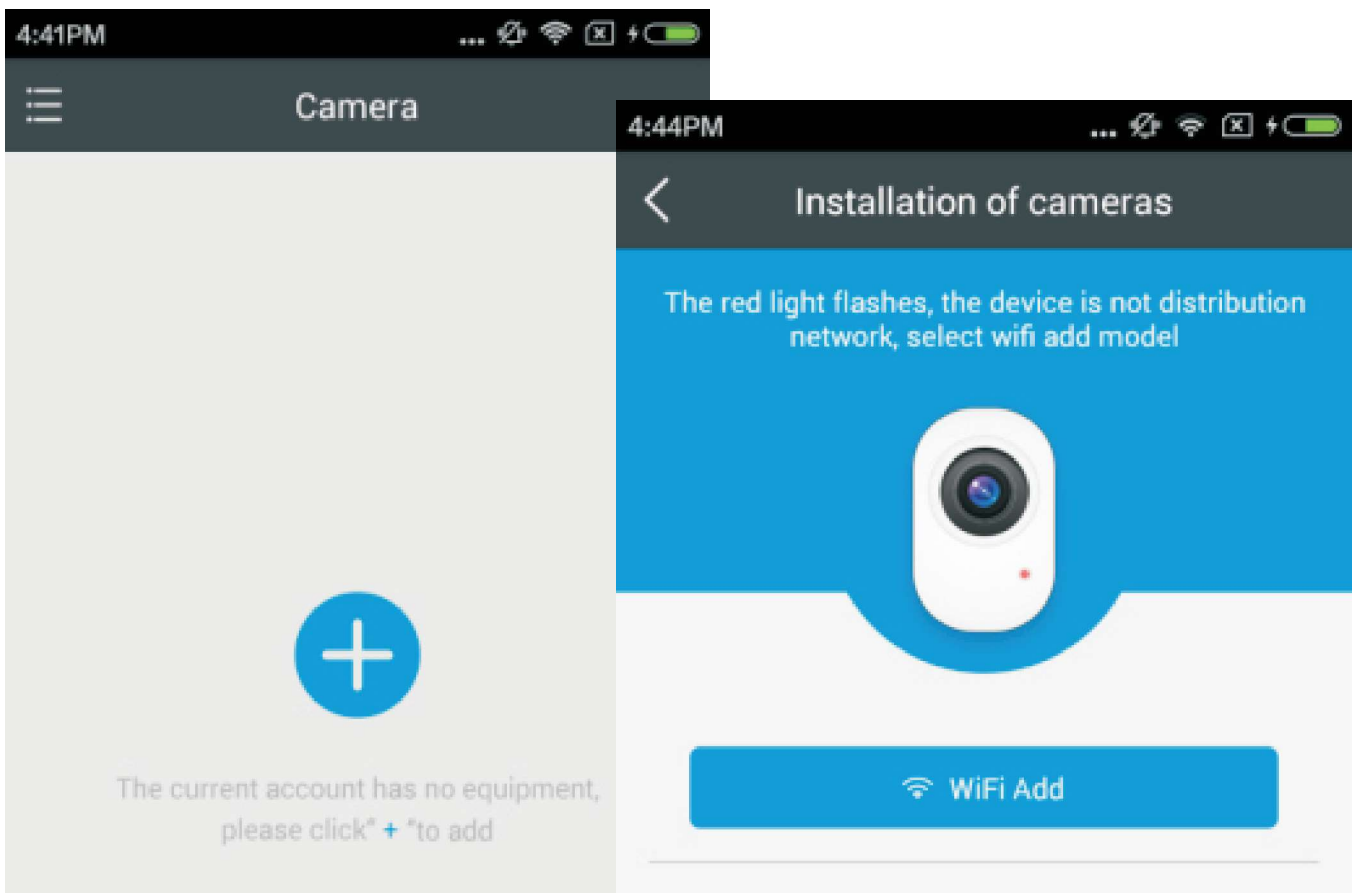

Step 4: Please back to camera list to check the real play after the light changed to blue.

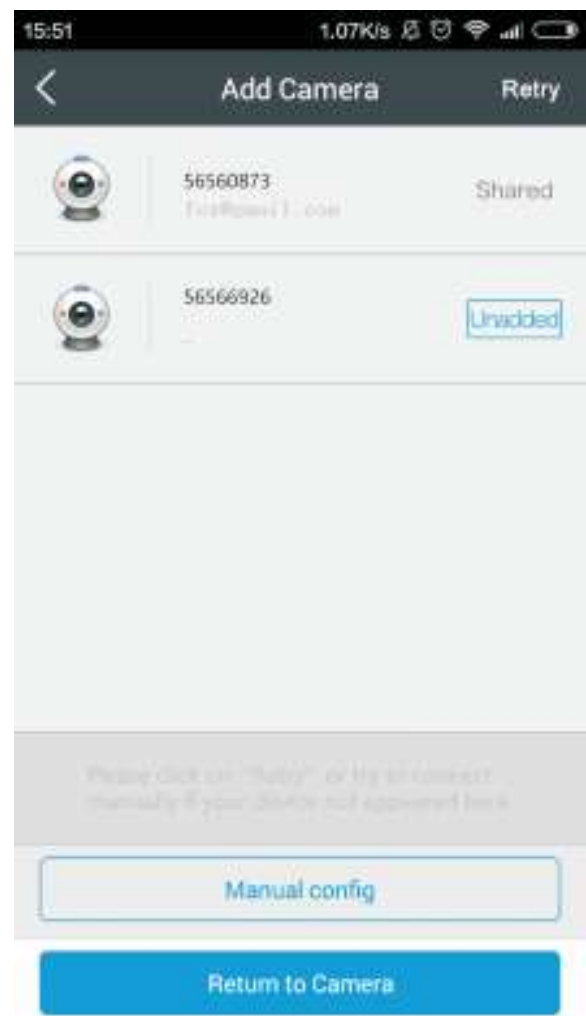
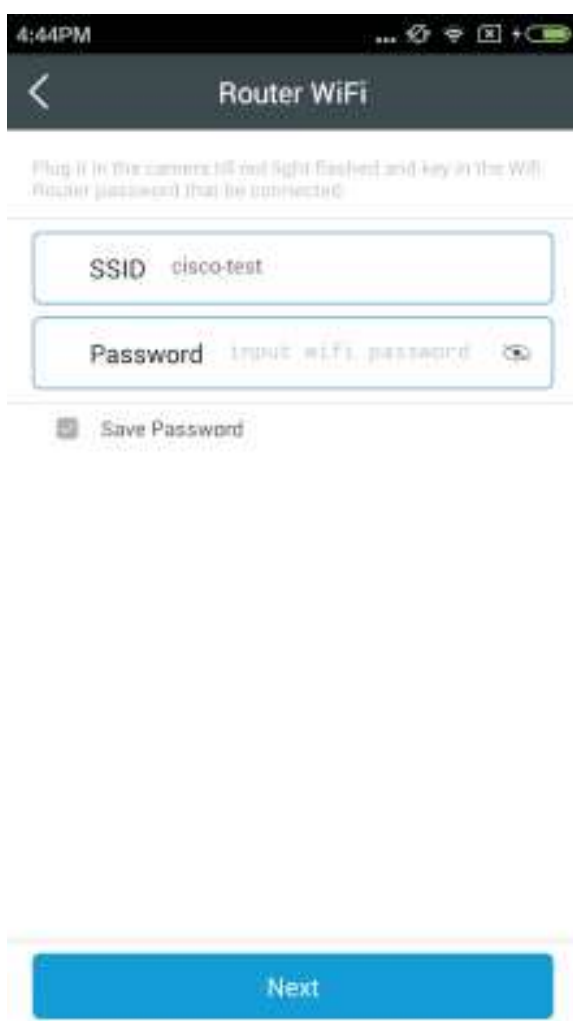

Camera light instruction

Red light on: network abnormal

Red light blinked: waiting for monitor

Blue light on: network normal

Blue light blinked: AP mode

If it failed to set-up the network, please reset the camera and try it once more, meanwhile please double check the following issues :

- 1) Check your wireless password.
- 2) Please ensure your Wi-Fi network broadcasts at 2.4GHz(802.11 b/g/n)
- 3) Move camera closer to your router. Camera out of Wi-Fi range cannot connect to network.
- 4) Restart your Wi-Fi router.

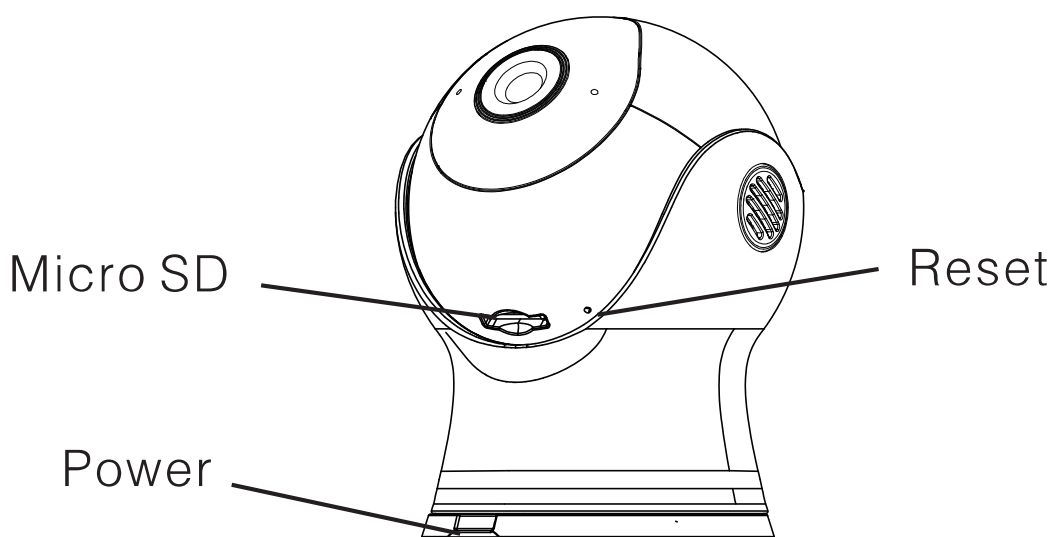

Reset: Press "Reset" (shown as the picture) with a Pin until hear a voice of "Do-do" and the camera red light is on.

2. Set Wi-Fi manually

Step 1: Press the "Reset" for 1 second, after a while the blue light blinked.

Step 2: Click on "Manual config" and follow the instructions there to set-up.

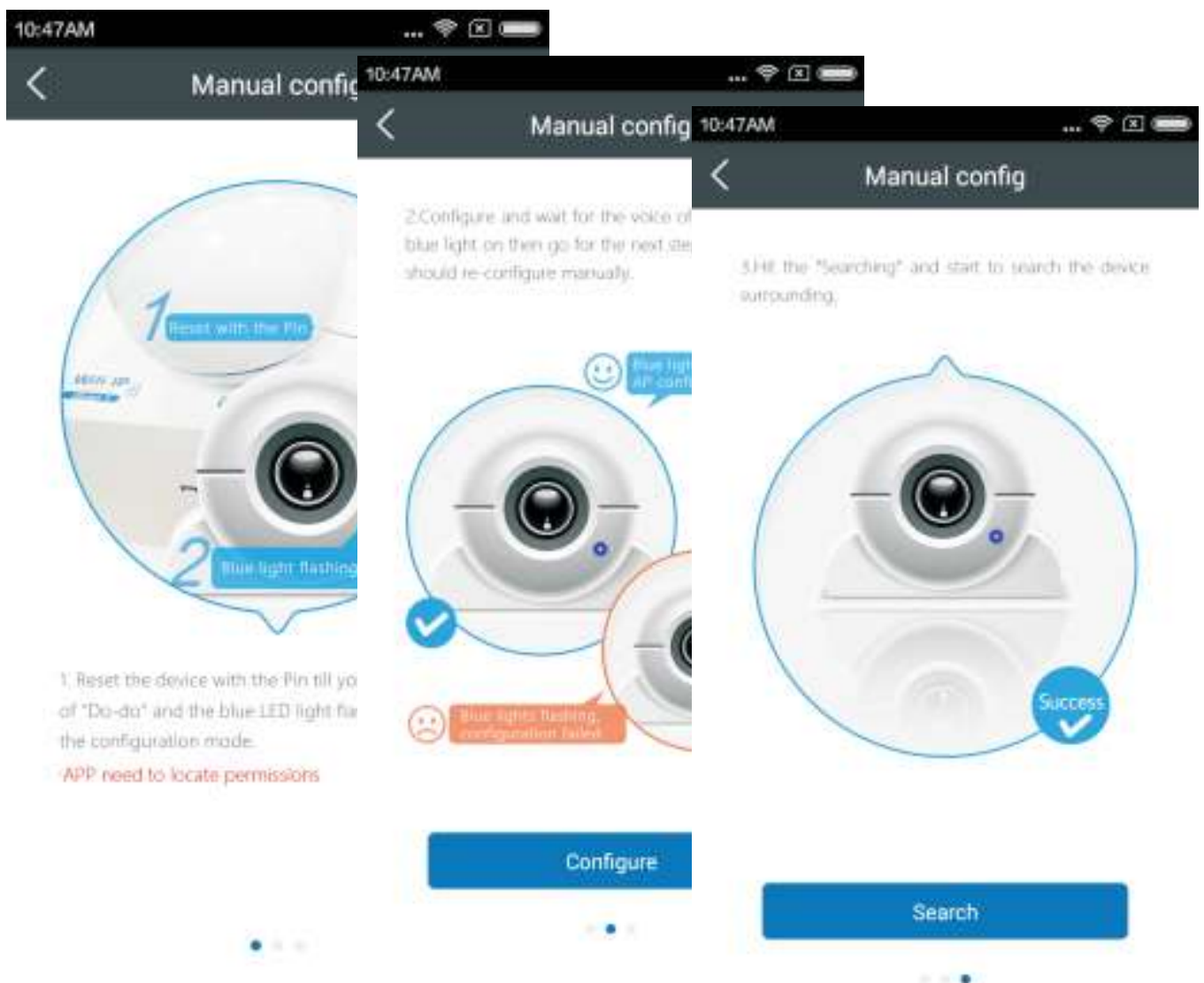

3 Start live play

Select the camera in the camera list to preview.

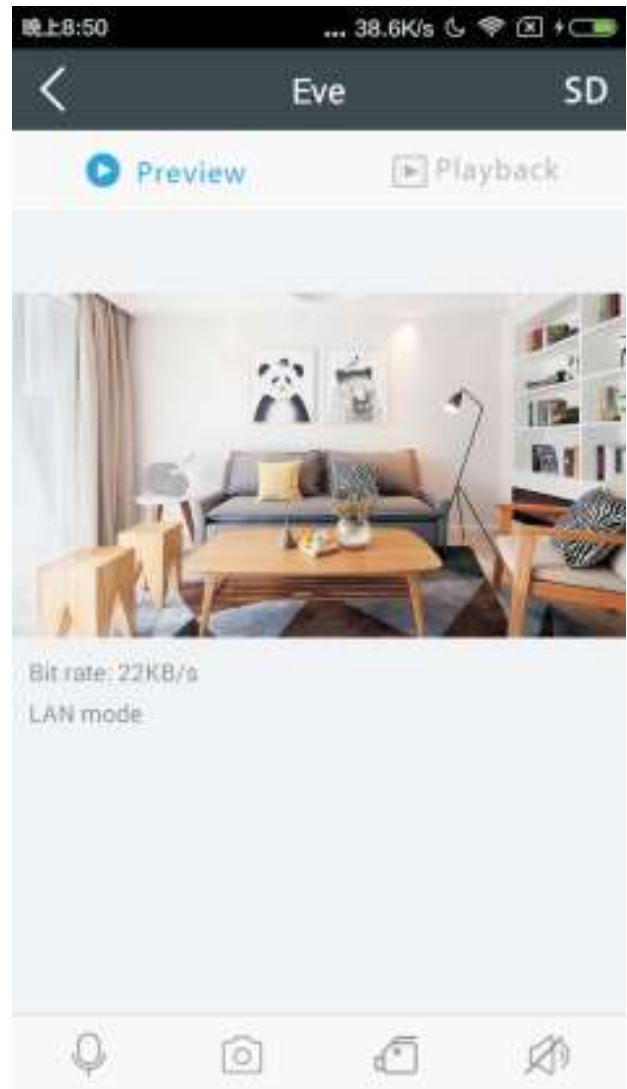
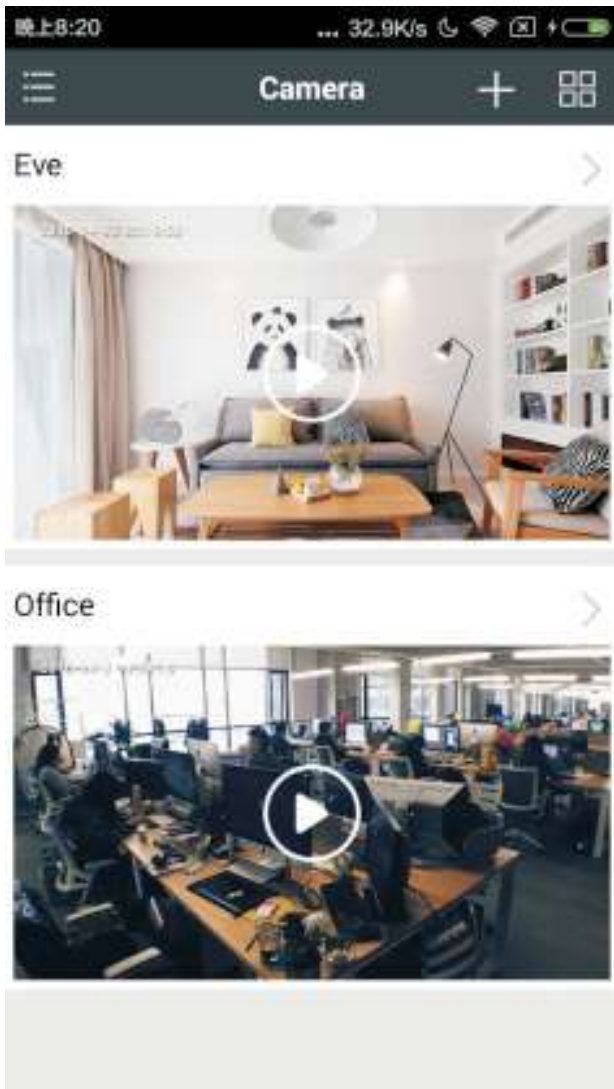

4 Device sharing

Share the device to your friend

Click on the "Friends" in the home page, Select the friend which be shared, and then tap the icon "Unshare" to be done.

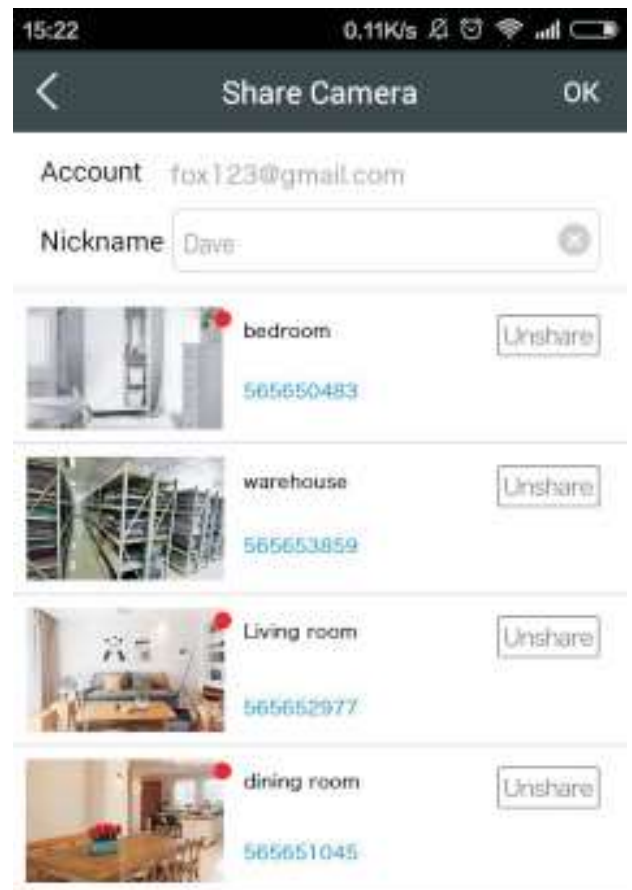
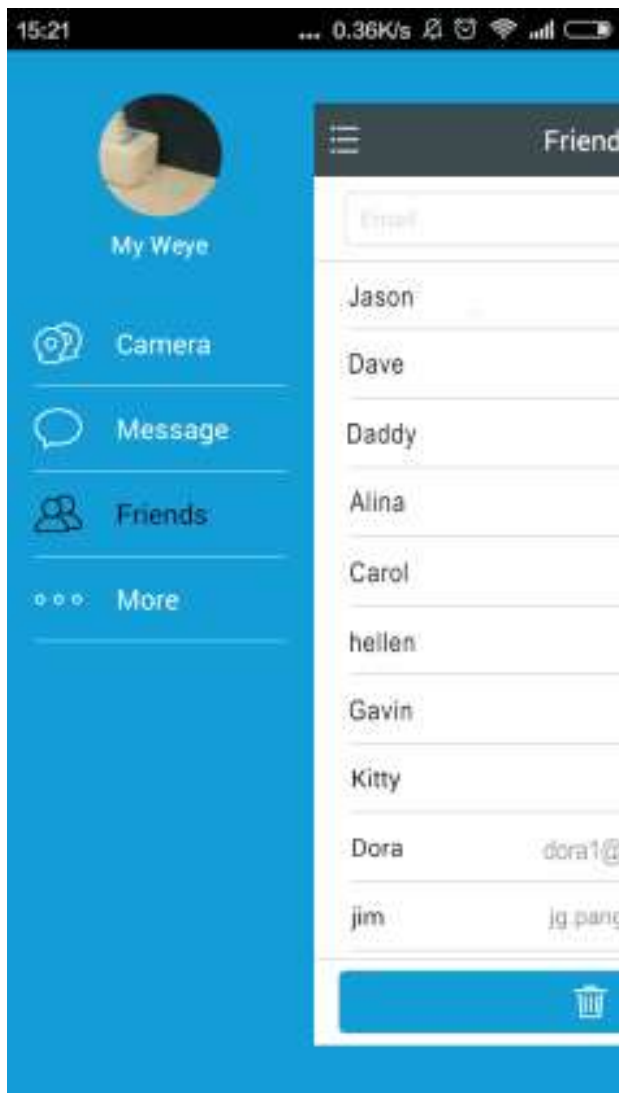

Request to share a device

Search the camera in the LAN by adding the camera, and tap the icon "Unshare" to wait for the approval.

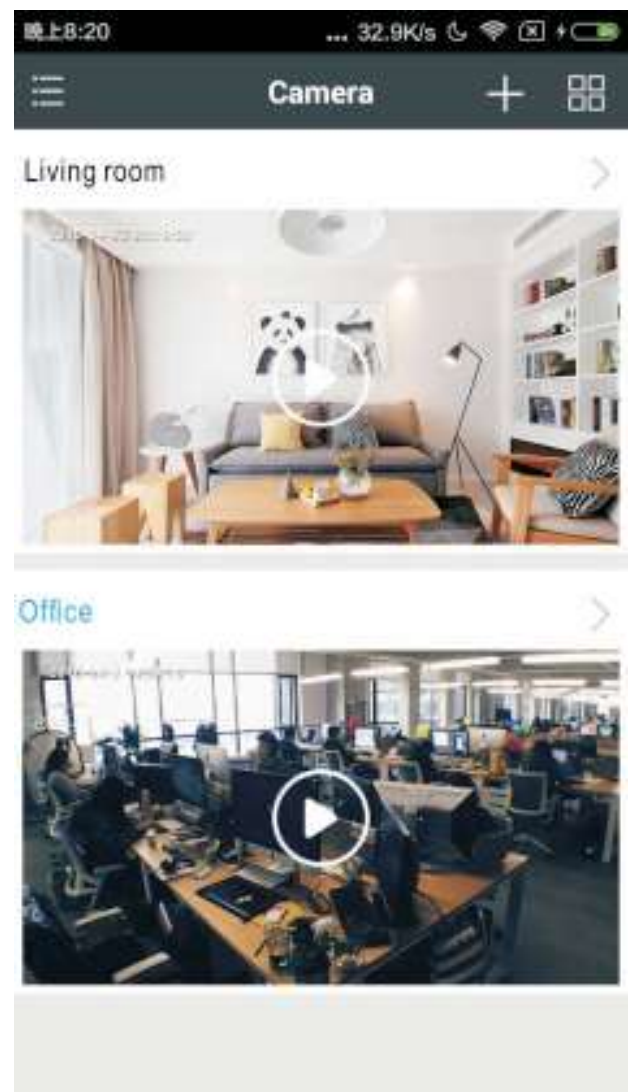

Attention: when access to device share from others, you cannot change its settings.

5 Motion detection

Just set by clicking the icon  on the up-right of the device and select the motion detection for [low/medium](#) /[high](#) standard.

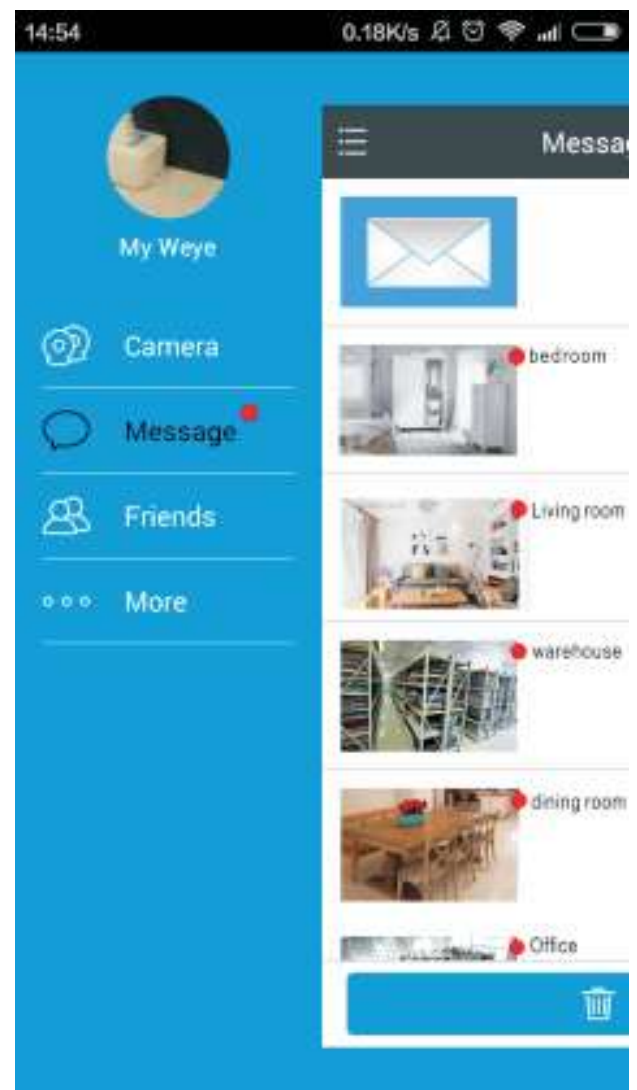
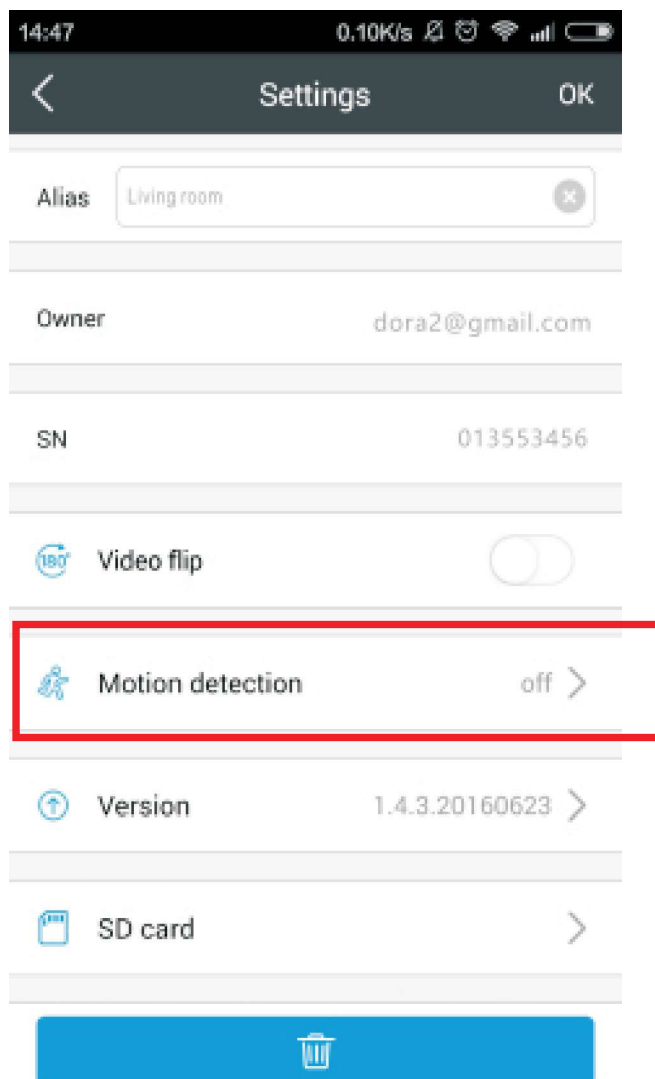

6 Playback

You can playback the video and check the moment what you missed after it is inserted the SD card.

Slide the timeline to view the image as you like.

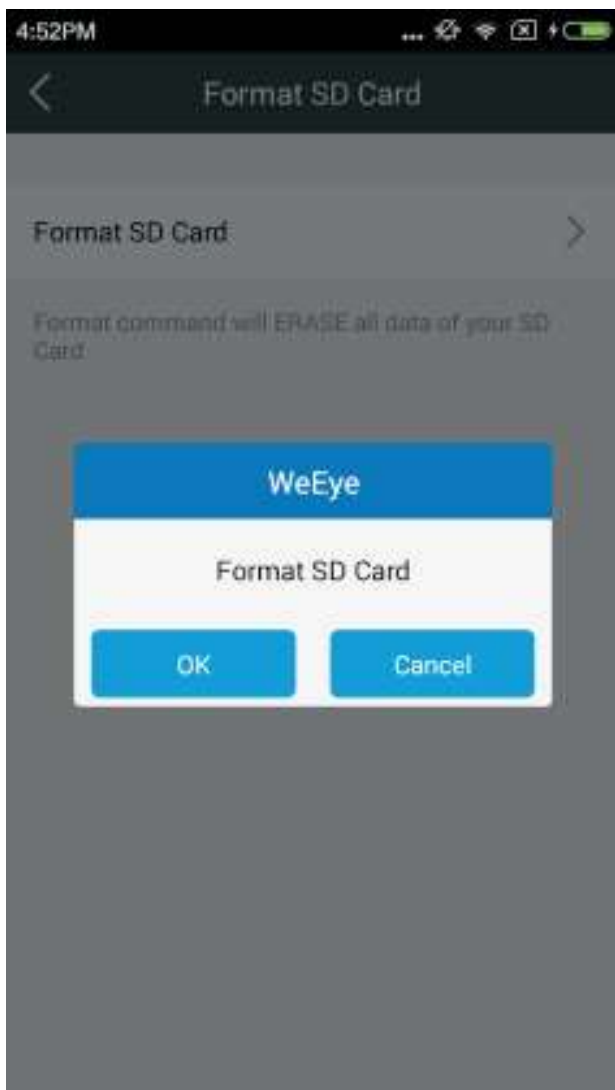

Information to user

Please pay more attention to the following restrictive clauses or exemption of liability.

1. We shall not bear any responsibility for you and the third persons personal injury or property loss if the product is interrupted or terminated caused by the following reasons:
Not strictly in accordance with the correct setup and usage;
In order to safeguard the interests of the state or the public;
Force majeure; By your own or the third party's problem (including but not limited to use the third party's product, software or components etc.)
2. We have never been to warranty by any express or implied this product suitable for the special purpose or application. The product is not intended for using in medical, safety equipment or other application may lead to the danger of life or personal injury. Any loss or liability caused by the above purposes will be bear by yourself.
3. We are not responsible for any indirect, incidental, special or punitive damages claim and any data or files missing. To the maximum extent permitted, our compensation liability does not exceed the payment amount what you purchased

Technical Support

If you have any question, please go to <http://www.ppstrong.com> for web support. You can also E-Mail to support@ppstrong.com for help.

Hangzhou PPStrong Technology Co., Ltd

Add: No.91, Chutian Road, Binjiang, Hangzhou

Tel: +86-0571-56565099

Fax: +86-0571-56565100

Website: www.ppstrong.com

Email: info@ppstrong.com

Federal Communications Commission (FCC) Interference Statement

This equipment has been tested and found to comply with the limits for a Class B digital device, pursuant to Part 15 of the FCC Rules.

These limits are designed to provide reasonable protection against harmful interference in a residential installation. This equipment generate, uses and can radiate radio frequency energy and, if not installed and used in accordance with the instructions, may cause harmful interference to radio communications.

However, there is no guarantee that interference will not occur in a particular installation. If this equipment does cause harmful interference to radio or television reception, which can be determined by turning the equipment off and on, the user is encouraged to try to correct the interference by one of the following measures:

- Reorient or relocate the receiving antenna.
- Increase the separation between the equipment and receiver.
- Connect the equipment into an outlet on a circuit different from that to which the receiver is connected.
- Consult the dealer or an experienced radio/TV technician for help.

This device complies with Part 15 of the FCC Rules. Operation is subject to the following two conditions:

(1) This device may not cause harmful interference, and (2) this device must accept any interference received, including interference that may cause undesired operation.

FCC Caution: Any changes or modifications not expressly approved by the party responsible for compliance could void the user's authority to operate this equipment.

RF exposure warning

This equipment complies with FCC radiation exposure limits set forth for an uncontrolled environment.

This equipment must be installed and operated in accordance with provided instructions and the antenna(s) used for this transmitter must be installed to provide a separation distance of at least 20 cm from all persons and must not be collocated or operating in conjunction with any other antenna or transmitter.