



BF8H-N Module Datasheet

Version: 20220303

Contents

1	Product overview	2
1.1	Features	2
1.2	Applications	2
1.3	Change history	2
2	Module interfaces	3
2.1	Dimensions and footprint	3
2.2	Pin definition	4
3	Electrical parameters	11
3.1	Absolute electrical parameters	11
3.2	Operating conditions	11
3.3	Power consumption in operating mode	12
4	RF parameters	13
4.1	Basic RF features	13
4.2	RF output power	13
4.3	RF receiving sensitivity	13
5	Audio CODEC parameters	14
5.1	Digital to analog converter (single channel)	14
5.2	Analog to digital converter (single channel)	14
6	Antenna information	16
6.1	Antenna type	16
6.2	Interference reduction	16
7	Packaging information and production instructions	18
7.1	Mechanical dimensions	18
7.2	Production instructions	23
7.3	Recommended oven temperature curve	25
7.4	Storage conditions	26
8	MOQ and packaging information	27
9	Appendix: Statement	28



BF8H-N is a low-power embedded Bluetooth audio module that Tuya has developed. It mainly consists of a highly integrated Bluetooth chip (FR8018HA) and a few peripheral circuits with the Bluetooth communication protocol stack and rich library functions inside.

1 Product overview

BF8H-N includes an ARM Cortex M3 32-bit processor, a Bluetooth LE 5.0/2.4G radio, a 512-KB flash memory, a 48-KB SRAM, 30 reusable I/O ports, charging management for a lithium battery, and a 16-bit single-channel audio CODEC.

1.1 Features

- 32-bit processor with the ARM Cortex M3 inside
- Operating voltage: 1.8 to 4.3V. If the voltage is between 1.8 and 2.4V, the module can start, but the optimal RF performance cannot be ensured. If the voltage is between 2.5 and 3.6V, the overall performance will be normal.
- Peripherals: 6 PWMs, 4 ADCs, 30 GPIOs, 2 UARTs, 1 SPI, 1 MIC, and 1 speaker
- Support Li-Ion/Li-Polymer battery, programmable charging current, current up to 200mA for fast charging
- Bluetooth RF features:
 - Bluetooth LE 5.0
 - The RF data rate can be up to 2 Mbps.
 - Transmit power: +4 dBm
 - Receiving sensitivity: -93 dBm@ 1 Mbps
 - Support hardware encryption (AES/CCM)
 - PCB antenna with a gain of 1.4 dBi
 - Operating temperature: -20°C to +85°C

1.2 Applications

- Outdoor
- Smart home

1.3 Change history

Update date	Updated content	Version after update
Feb. 14, 2022	This is the first release.	V1.0.0

2 Module interfaces

2.1 Dimensions and footprint

The dimensions of BF8H-N are 25 ± 0.35 mm (L) \times 18 ± 0.35 mm (W) \times 2.8 ± 0.15 mm (H). The thickness of the PCB is 0.8 ± 0.1 mm, which are shown below:

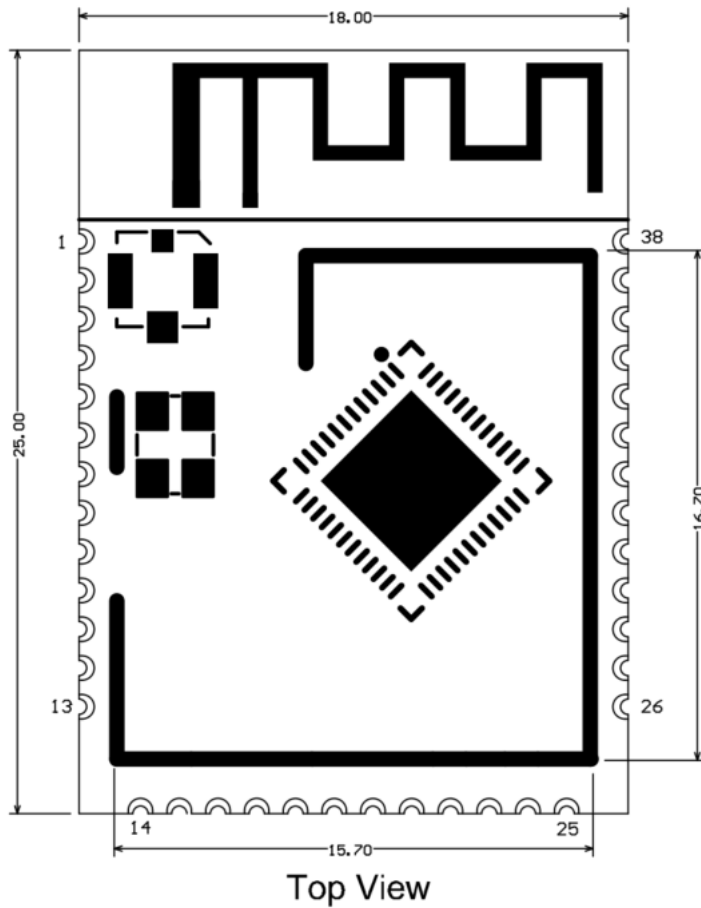

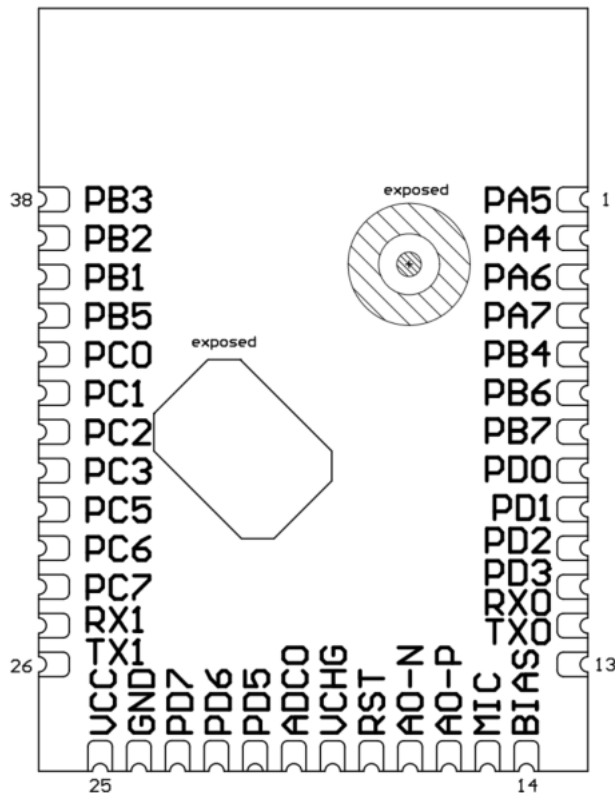

Bottom View

2.2 Pin definition

The definitions of pins are shown in the following table:

Pin number	Symbol	Pin type	Function
1	PA5	I/O	Common I/O interface, which corresponds to Pin 8 of the IC
2	PA4	I/O	Common I/O interface, which corresponds to Pin 7 of the IC

Pin number	Symbol	Pin type	Function
3	PA6	I/O	Common I/O interface, which corresponds to Pin 6 of the IC
4	PA7	I/O	Common I/O interface, which corresponds to Pin 5 of the IC
5	PB4	I/O	Common I/O interface, which corresponds to Pin 42 of the IC
6	PB6	I/O	Common I/O interface, which corresponds to Pin 43 of the IC
7	PB7	I/O	Common I/O interface, which corresponds to Pin 44 of the IC
8	PD0	I/O	Common I/O interface, which corresponds to Pin 41 of the IC
9	PD1	I/O	Common I/O interface, which corresponds to Pin 40 of the IC
10	PD2	I/O	Common I/O interface, which corresponds to Pin 39 of the IC

Pin number	Symbol	Pin type	Function
11	PD3	I/O	Common I/O interface, which corresponds to Pin 38 of the IC
12	RX0	I/O	Serial port UART0_RX, which can also be used as a common I/O interface and corresponds to Pin 4 of the IC chip
13	TX0	I/O	Serial port UART0_TX, which can also be used as a common I/O interface and corresponds to Pin 3 of the IC chip. It can be used to output logs.
14	BIAS	AO	MIC_BIAS, power supply for microphone, corresponds to Pin 13 of the IC.
15	MIC	AI	MIC_IN, microphone input, corresponds to Pin 14 of the IC. You should reserve an earth filter capacitor for the external microphone.

Pin number	Symbol	Pin type	Function
16	AO-P	AO	AOUT_P, audio differential output (positive), correspond to Pin 16 of the IC
17	AO-N	AO	AOUT_N, audio differential output (negative), correspond to Pin 17 of the IC
18	RST	AI	Hardware reset pin (high active), correspond to Pin 18 of the IC
19	VCHG	P	Charger, pin for charging, which corresponds to Pin 19 of the IC. It can be used to charge the external batteries
20	ADC0	I/O	Common I/O interface PD4, which can be configured to be 10 bit/s and corresponds to Pin 29 of the IC
21	PD5	I/O	Common I/O interface, which corresponds to Pin 28 of the IC

Pin number	Symbol	Pin type	Function
22	PD6	I/O	Common I/O interface, which corresponds to P 27 of the IC
23	PD7	I/O	Common I/O interface, which corresponds to Pin 26 of the IC
24	GND	P	Power supply reference ground
25	VCC	P	Power supply pin VCC (Typical value: 3.3V)
26	TX1	I/O	Default burning serial port, transmitting pin UART1_TX, which can also be used as a common I/O interface and corresponds to pin 1 of the IC
27	RX1	I/O	Default burning serial port, receiving pin UART1_RX, which can also be used as a common I/O interface and corresponds to Pin 2 of the IC

Pin number	Symbol	Pin type	Function
28	PC7	I/O	Common I/O interface, which corresponds to Pin 30 of the IC
29	PC6	I/O	Common I/O interface, which corresponds to Pin 31 of the IC
30	PC5	I/O	Common I/O interface, which corresponds to P32 of the IC
31	PC3	I/O	Common I/O interface, which corresponds to Pin 34 of the IC
32	PC2	I/O	Common I/O interface, which corresponds to Pin 35 of the IC
33	PC1	I/O	Common I/O interface, which corresponds to Pin 36 of the IC
34	PC0	I/O	Common I/O interface, which corresponds to Pin 37 of the IC
35	PB5	I/O	Common I/O interface, which corresponds to Pin 45 of the IC

Pin number	Symbol	Pin type	Function
36	PB1	I/O	Common I/O interface, which corresponds to Pin 46 of the IC
37	PB2	I/O	Common I/O interface, which corresponds to Pin 47 of the IC
38	PB3	I/O	Common I/O interface, which corresponds to Pin 48 of the IC

:::info

- The recommended voltage is 3.3V. The RF performance will be instable if the operating voltage is under 2.5V.
- P indicates a power supply pin, I/O indicates an input/output pin, and AI/AO indicates an analog input/output pin.
- If you have any special requirements on the light color controlled by the PWM output, please contact Tuya business personnel.
- The peripheral circuit of Charger is shown below for reference:

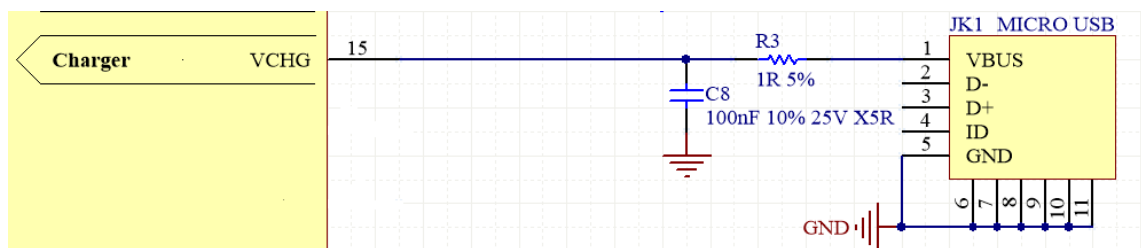

:::

3 Electrical parameters

3.1 Absolute electrical parameters

Parameter	Description	Minimum value	Maximum value	Unit
Ts	Storage temperature	-40	120	°C
I/O voltage	ALDO_OUT	1.6	3.3	V
VCC	Power supply voltage	1.8	4.3	V
ESD voltage (human body model)	TAMB-25°C	-	2	KV
ESD voltage (machine model)	TAMB-25°C	-	2	KV

3.2 Operating conditions

Parameter	Description	Minimum value	Typical value	Maximum value	Unit
Ta	Operating temperature	-20	-	85	°C
VCC	Operating voltage	1.8	3.3	4.3	V
V _{CHG}	Voltage for charger	4.75	5	5.25	V
V _{IL}	Voltage low input	-0.3	-	0.3* VDDIO	V
V _{IH}	Voltage high input	0.7*VDDIO	-	VDDIO+0.3	V

Parameter	Description	Minimum value	Typical value	Maximum value	Unit
V_{OL}	Voltage low output	-	-	0.33	V
V_{OH}	Voltage high output	1.8	-	-	V

The test condition for the above high/low voltage input/output is: $V_{DDI/O} = 3.3V$.

3.3 Power consumption in operating mode

Symbol	Conditions	Maximum value (Typical value)	Unit
I_{tx}	Constantly transmit with the output power of 40 dBm	14.3	mA
I_{rx}	Constantly receive	15.7	mA
IDC	Average value in mesh networking state	5	mA
IDC	Peak value in mesh networking state	21.2	mA
$I_{deepsleep}$	Average value in deep sleep state (reserve RAM)	6.2	uA

4 RF parameters

4.1 Basic RF features

Parameter	Description
Operating frequency	2.4 GHz ISM band
Wireless standard	Bluetooth LE 5.0
Data transmission rate	1 Mbps, 2 Mbps
Antenna type	PCB antenna

4.2 RF output power

Parameter	Minimum value	Typical value	Maximum value	Unit
Average RF output power	-20	4	5	dBm
Bandwidth of 20-dB modulation signal (1M)	-	2500	-	KHz

4.3 RF receiving sensitivity

Parameter	Minimum value	Typical value	Maximum value	Unit
Receiving sensitivity 1 Mbps	-	-96	-	dBm
Frequency offset error 1 Mbps	-250	-	+300	KHz

5 Audio CODEC parameters

5.1 Digital to analog converter (single channel)

Parameter	Condition	Minimum value	Typical value	Maximum value	Unit	
Converter precision	-	-	-	16	Bits	
Sampling rate (Fs)*	Synchronous clock signal	8	-	48	V	uA
SNR	-		92		dB	uA
Digital gain	1/48dB	-48	-	32	dB	uA
Analog gain	3dB	0	-	30	dB	uA
Full-scale output voltage	VDDA=2.9V		1500	-	mV	uA
Stopband attenuation		65	-	-	V	uA

info The test condition for sampling rate (Fs):

- Fin=1kHz
- B/W=20Hz–20KHz
- A-Weighted THD_N<0.01%
- Fs (8K, 16K, 32K, 44.1K, 48K) :::

5.2 Analog to digital converter (single channel)

Parameter	Condition	Minimum value	Typical value	Maximum value	Unit
Conversion precision	-	-	-	16	Bits
Sampling rate (Fs)*	Synchronous clock signal	8	-	48	V uA
SNR	Weighted/unweighted	-	79	-	dB uA
Digital gain	1/48dB	-48	-	32	dB uA
Analog gain	3dB	0	-	30	dB uA

6 Antenna information

6.1 Antenna type

BF8H-N uses the PCB antenna with a gain of 1.4 dBi.

6.2 Interference reduction

To ensure the best RF performance, it is recommended that the antenna be at least 15 mm away from other metal parts. If metal materials are wrapped around the antenna, the wireless signal will be greatly attenuated, thereby deteriorating the RF performance. When designing the finished product, please leave enough space for the antenna.

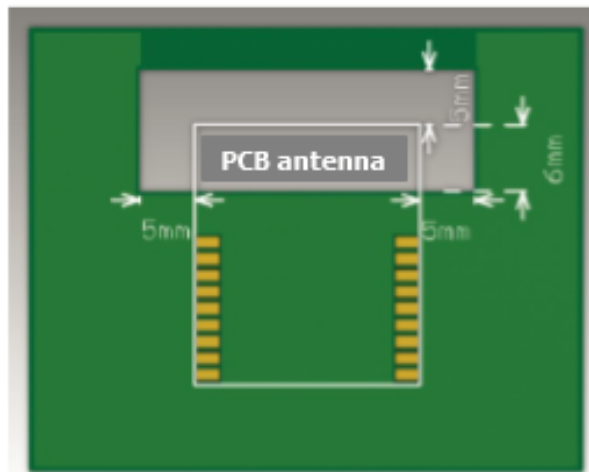
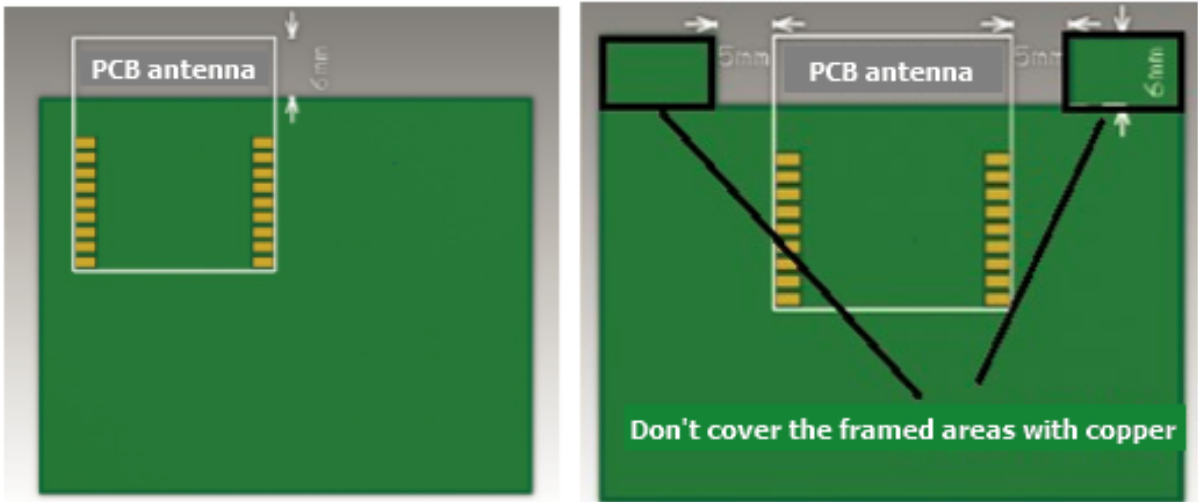

7 Packaging information and production instructions

7.1 Mechanical dimensions

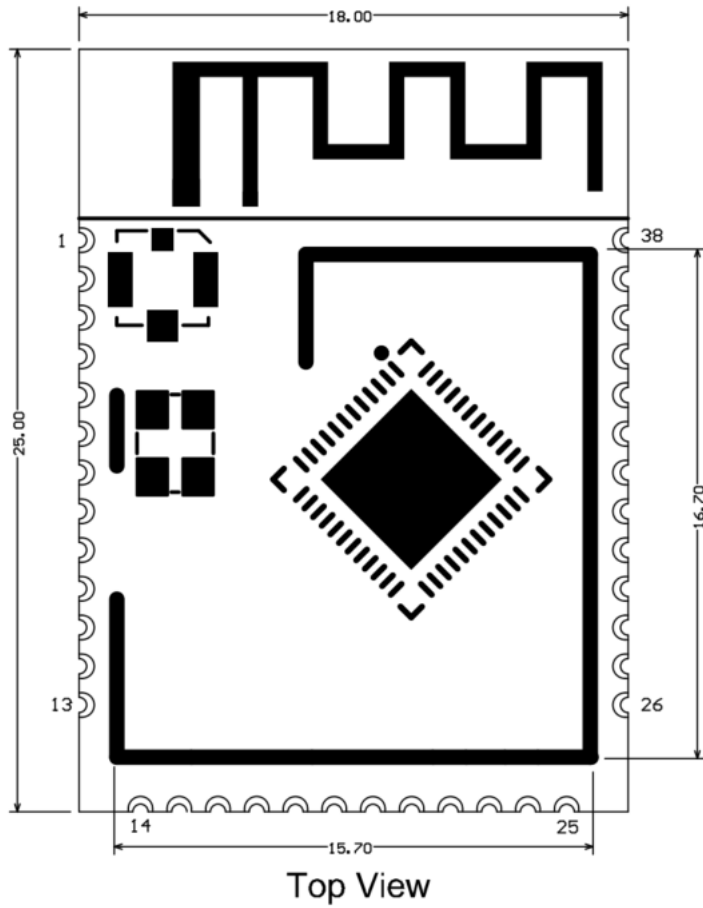

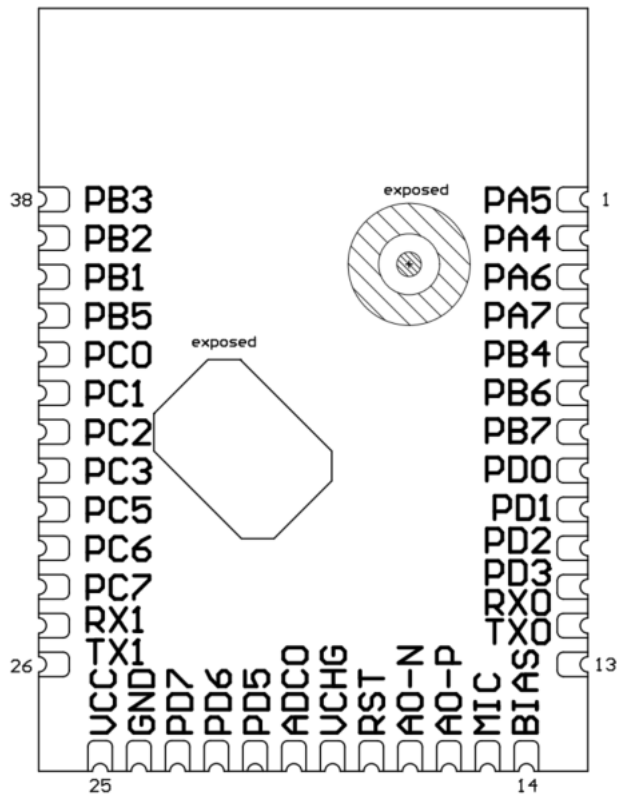

Bottom View



Unit: mm

Module form factor tolerance: $\pm 0.35\text{mm}$

PCB thickness tolerance: $\pm 0.1\text{mm}$

Shield cover height tolerance: $\pm 0.05\text{mm}$

Side View

The following is a schematic diagram of BF8H-N which shows how pins correspond to each other:

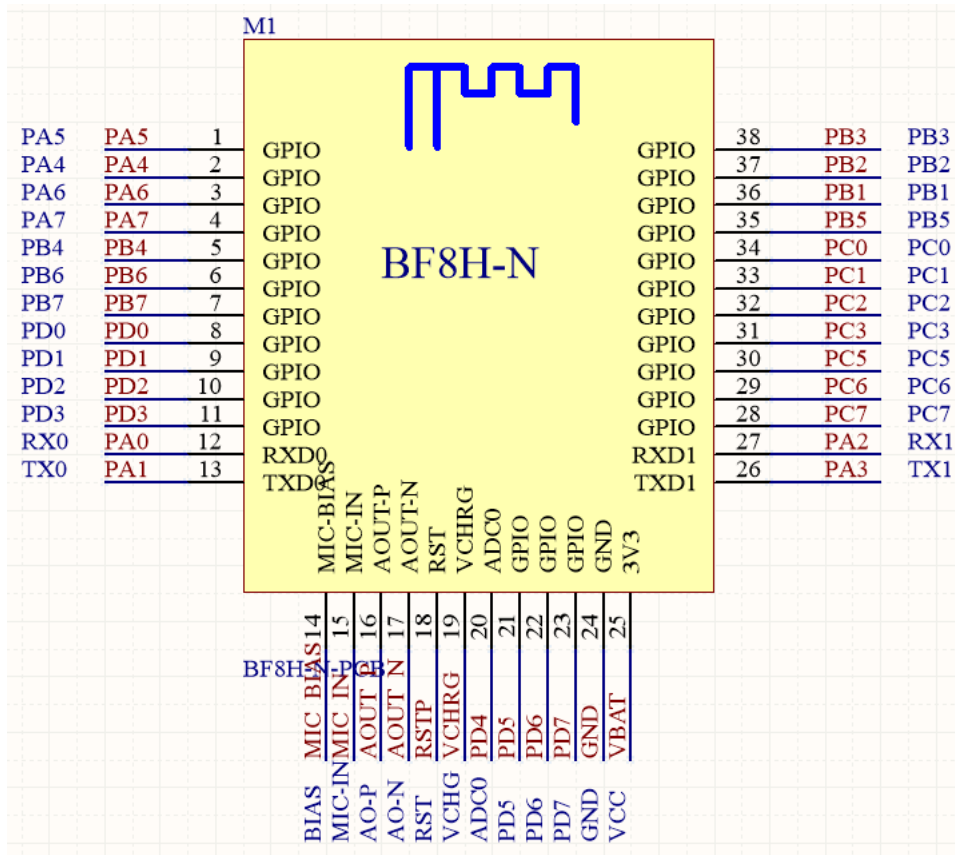

Recommended PCB footprint

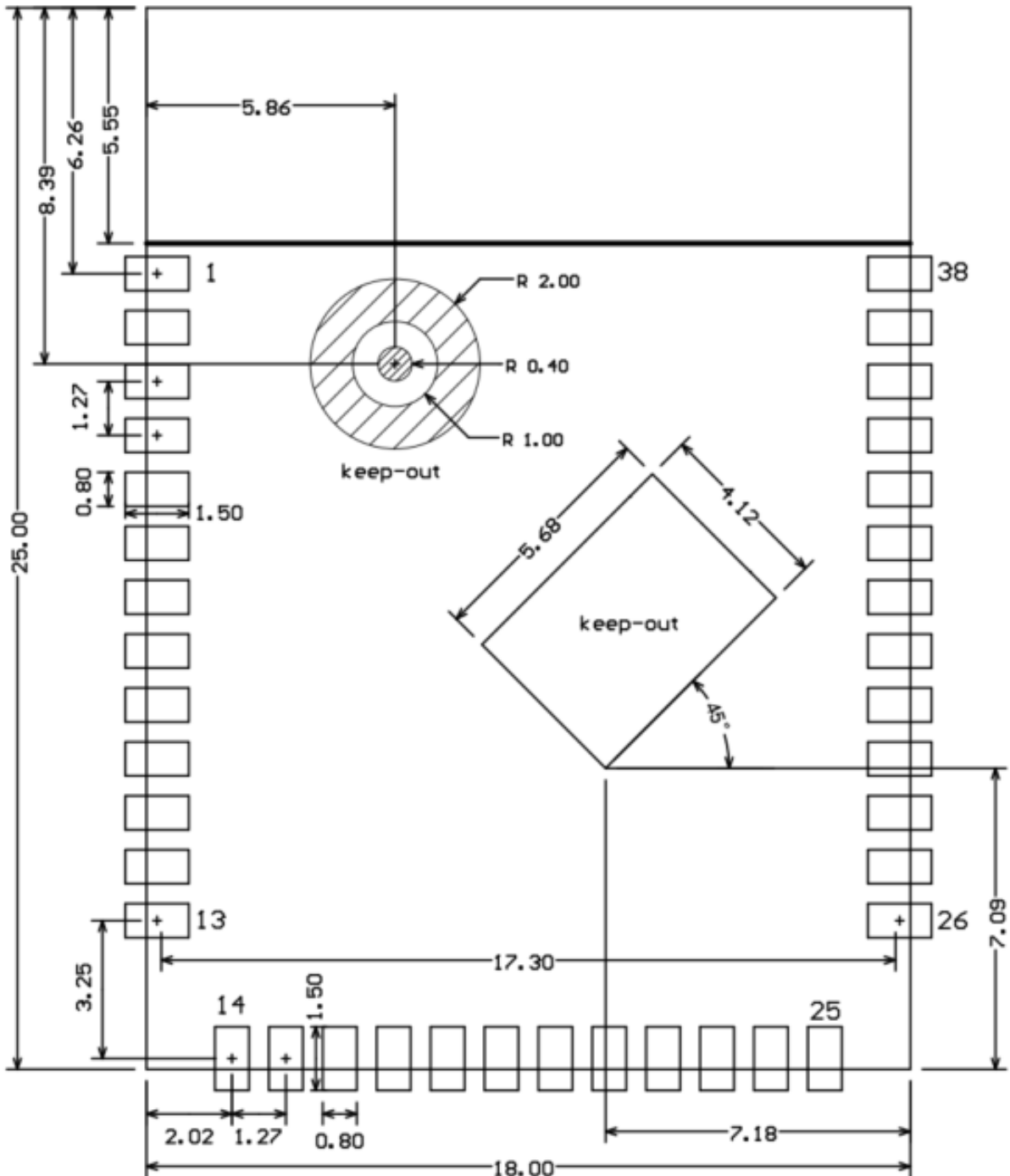

The default outline dimension tolerance is ± 0.35 mm, and the critical dimension

tolerance is ± 0.1 mm. If you have specific requirements on dimensions, specify them clearly in the datasheet after communication.

7.2 Production instructions

1. The Tuya SMT module should be mounted by the SMT device. After being unpacked, it should be soldered within 24 hours. Otherwise, it should be put into the drying cupboard where the RH is not greater than 10%; or it needs to be packaged under vacuum again and the exposure time needs to be recorded (the total exposure time cannot exceed 168 hours).

- SMT devices:
 - Mounter
 - SPI
 - Reflow soldering machine
 - Thermal profiler
 - Automated optical inspection (AOI) equipment
- Baking devices:
 - Cabinet oven
 - Anti-electrostatic and heat-resistant trays
 - Anti-electrostatic and heat-resistant gloves

2. Storage conditions for a delivered module:

- The moisture-proof bag must be placed in an environment where the temperature is below 40°C and the relative humidity is lower than 90%.
- The shelf life of a dry-packaged product is 12 months from the date when the product is packaged and sealed.
- There is a humidity indicator card (HIC) in the packaging bag.

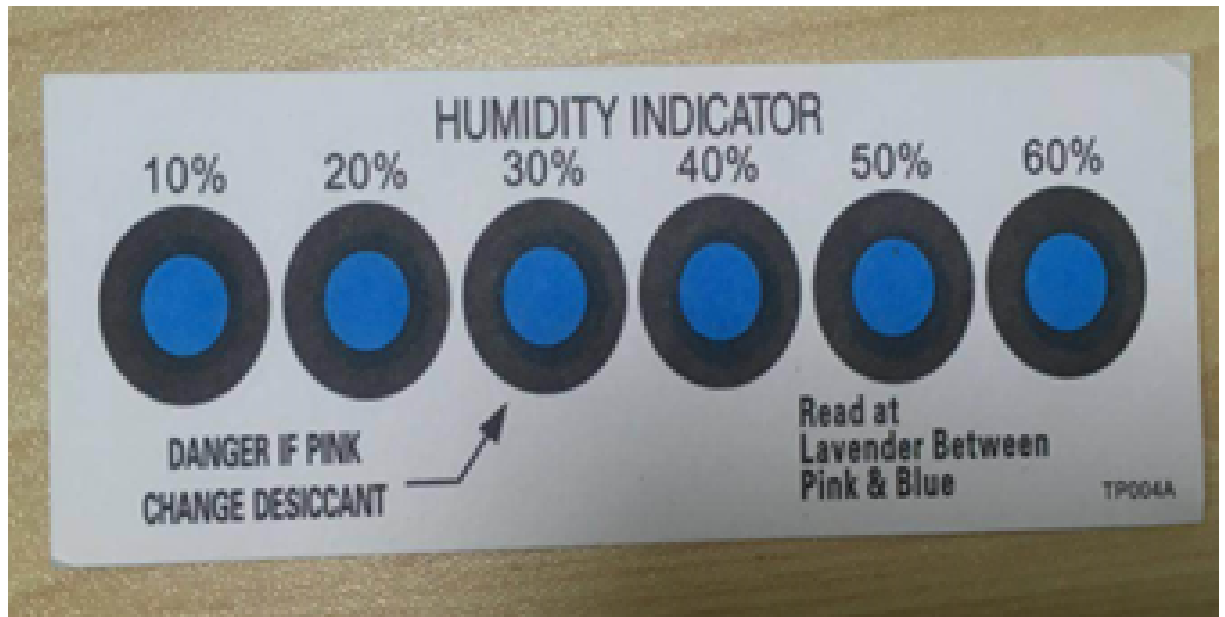

3. The module needs to be baked in the following cases:

- The packaging bag is damaged before unpacking.
- There is no HIC in the packaging bag.
- After unpacking, circles of 10% and above on the HIC become pink.
- The total exposure time has lasted for over 168 hours since unpacking.
- More than 12 months has passed since the sealing of the bag.

4. Baking settings:

- Temperature: 60°C and $\leq 5\%$ RH for reel package and 125°C and $\leq 5\%$ RH for tray package (please use the heat-resistant tray rather than plastic container)
- Time: 48 hours for reel package and 12 hours for tray package
- Alarm temperature: 65°C for reel package and 135°C for tray package
- Production-ready temperature after natural cooling: $< 36^\circ\text{C}$
- Re-baking situation: If a module remains unused for over 168 hours after being baked, it needs to be baked again.
- If a batch of modules is not baked within 168 hours, do not use the reflow soldering to solder them. Because these modules are Level-3 moisture-sensitive devices, they are very likely to get damp when exposed beyond the allowable time. In this case, if they are soldered at high temperatures, it may result in device failure or poor soldering.

5. In the whole production process, take electrostatic discharge (ESD) protective

measures.

- To guarantee the passing rate, it is recommended that you use the SPI and AOI to monitor the quality of solder paste printing and mounting.

7.3 Recommended oven temperature curve

Set oven temperatures according to the following temperature curve of reflow soldering. The peak temperature is 245°C.

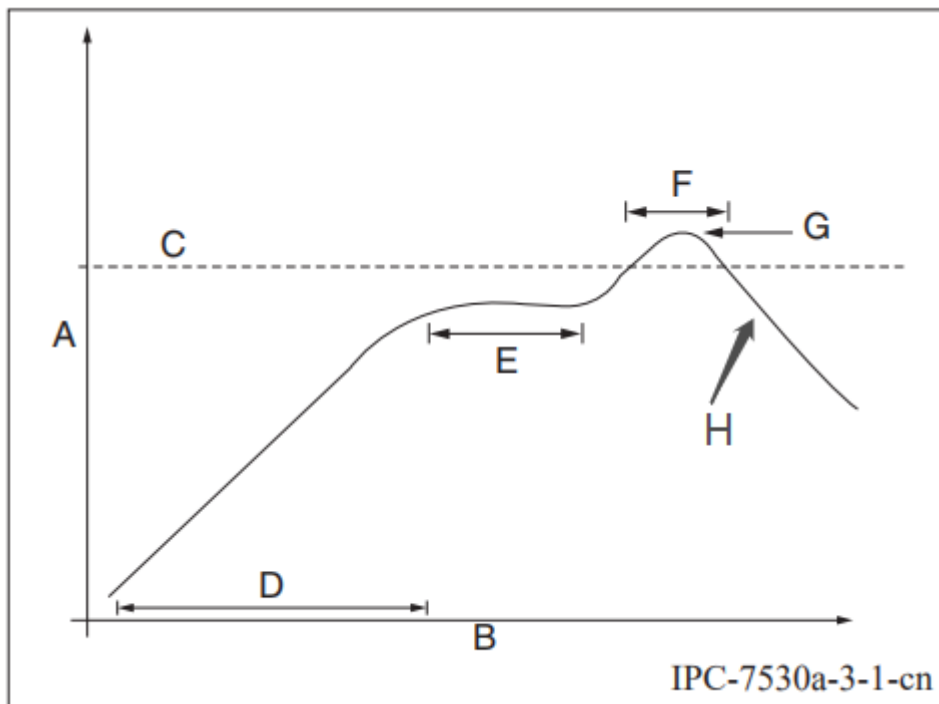

- A: Temperature axis
- B: Time axis
- C: Liquidus temperature: 217 to 220°C
- D: Ramp-up slope: 1 to 3°C/s
- E: Duration of constant temperature: 60 to 120s; the range of constant temperature: 150 to 200°C
- F: Duration above the liquidus: 50 to 70s
- G: Peak temperature: 235 to 245°C
- H: Ramp-down slope: 1 to 4°C/s

The above curve is just an example of the solder paste SAC305. For more details about other solder pastes, please refer to Recommended oven temperature curve

in the solder paste specifications.

7.4 Storage conditions

	<p>Caution This bag contains MOISTURE-SENSITIVE DEVICES</p>	<p>LEVEL</p> <div style="border: 1px solid black; padding: 5px; display: inline-block;"> <p>3</p> </div> <p><small>If blank, see adjacent bar code label</small></p>
<p>1. Calculated shelf life in sealed bag: 12 months at <math><40^{\circ}\text{C}</math> and <math><90\%</math> relative humidity (RH)</p>		
<p>2. Peak package body temperature: <u>260</u> °C <small>If blank, see adjacent bar code label</small></p>		
<p>3. After bag is opened, devices that will be subjected to reflow solder or other high temperature process must be</p>		
<p>a) Mounted within: <u>168</u> hours of factory conditions <small>If blank, see adjacent bar code label</small> ≤30°C/60% RH, or</p>		
<p>b) Stored per J-STD-033</p>		
<p>4. Devices require bake, before mounting, if:</p>		
<p>a) Humidity Indicator Card reads >10% for level 2a - 5a devices or >60% for level 2 devices when read at $23 \pm 5^{\circ}\text{C}$</p>		
<p>b) 3a or 3b are not met</p>		
<p>5. If baking is required, refer to IPC/JEDEC J-STD-033 for bake procedure</p>		
<p>See Production Date</p>		
<p>Bag Seal Date: _____ <small>If blank, see adjacent bar code label</small></p>		
<p>Note: Level and body temperature defined by IPC/JEDEC J-STD-020</p>		

8 MOQ and packaging information

Product model	MOQ (pcs)	Packaging method	The number of modules per reel	The number of reels per carton
BF8H-N	4000	Tape reel	1000	4

9 Appendix: Statement

FCC Caution: Any changes or modifications not expressly approved by the party responsible for compliance could void the user's authority to operate this device.

This device complies with Part 15 of the FCC Rules. Operation is subject to the following two conditions: (1) This device may not cause harmful interference, and (2) this device must accept any interference received, including interference that may cause undesired operation.

This device has been tested and found to comply with the limits for a Class B digital device, according to part 15 of the FCC Rules. These limits are designed to provide reasonable protection against harmful interference in a residential installation. This device generates, uses, and can radiate radio frequency energy and, if not installed and used following the instructions, may cause harmful interference to radio communications. However, there is no guarantee that interference will not occur in a particular installation.

If this device does cause harmful interference to radio or television reception, which can be determined by turning the device off and on, the user is encouraged to try to correct the interference by one or more of the following measures:

- Reorient or relocate the receiving antenna.
- Increase the separation between the device and receiver.
- Connect the device into an outlet on a circuit different from that to which the receiver is connected.
- Consult the dealer or an experienced radio/TV technician for help.

Radiation Exposure Statement

This device complies with FCC radiation exposure limits set forth for an uncontrolled rolled environment. This device should be installed and operated with a minimum distance of 20cm between the radiator and your body.

Important Note

This radio module must not be installed to co-locate and operating simultaneously with other radios in the host system except following FCC multi-transmitter product procedures. Additional testing and device authorization may be required to operate simultaneously with other radios.

The availability of some specific channels and/or operational frequency bands are country dependent and are firmware programmed at the factory to match the intended destination. The firmware setting is not accessible by the end-user.

The host product manufacturer is responsible for compliance with any other FCC rules that apply to the host not covered by the modular transmitter grant of certification. The final host product still requires Part 15 Subpart B compliance testing with the modular transmitter installed.

The end-user manual shall include all required regulatory information/warnings as shown in this manual, including “This product must be installed and operated with a minimum distance of 20 cm between the radiator and user body” .

This device has got an FCC ID: 2ANDL-BF8H-N. The end product must be labeled in a visible area with the following: “Contains Transmitter Module FCC ID: 2ANDL-BF8H-N” .

This device is intended only for OEM integrators under the following conditions:

The antenna must be installed such that 20cm is maintained between the antenna and users, and the transmitter module may not be co-located with any other transmitter or antenna.

As long as the 2 conditions above are met, further transmitter tests will not be required. However, the OEM integrator is still responsible for testing their end-product for any additional compliance requirements required with this module installed.

Declaration of Conformity European Notice



Hereby, Hangzhou Tuya Information Technology Co., Ltd declares that this module product is in compliance with essential requirements and other relevant provisions of Directive 2014/53/EU, 2011/65/EU. A copy of the Declaration of conformity can be found at <https://www.tuya.com>.



This product must not be disposed of as normal household waste, in accordance with the EU directive for waste electrical and electronic equipment (WEEE-2012/19/EU). Instead, it should be disposed of by returning it to the point of sale, or a municipal recycling collection point.

The device could be used with a separation distance of 20cm to the human body.