



CB3SE Module Datasheet

Version: 20210611

Contents

1	Product overview	2
1.1	Features	2
1.2	Applications	2
1.3	Change history	3
2	Module interfaces	3
2.1	Dimensions and footprint	3
2.2	Pin definition	4
2.3	Definitions on test points	7
3	Electrical parameters	8
3.1	Absolute electrical parameters	8
3.2	Normal working conditions	9
3.3	RF power consumption	9
3.4	Working current	10
4	RF parameters	12
4.1	Basic RF features	12
4.2	Wi-Fi transmission performance	12
4.3	Wi-Fi receiving performance	13
4.4	Bluetooth transmission performance	14
4.5	Bluetooth receiving performance	14
5	Antenna information	14
5.1	Antenna type	14
5.2	Antenna interference reduction	15
6	Packaging information and production instructions	18
6.1	Mechanical dimensions	18
6.2	Production instructions	22
6.3	Recommended oven temperature curve	23
6.4	Storage conditions	25
7	MOQ and packaging information	26

8 Appendix: Statement

26



Contents

CB3SE is an embedded low-power Wi-Fi module that Tuya has developed. It consists of a highly integrated RF chip BK7231N and a few peripherals. CB3SE not only supports the Wi-Fi AP and STA modes, but also supports the Bluetooth LE.

1 Product overview

CB3SE is built in with a 32-bit MCU whose running speed can be up to 120 MHz, 2-MB flash memory, and 256-KB RAM, so as to support the Tuya IoT cloud connection. The MCU instructions specially extended for signal processing can effectively implement audio encoding and decoding.

Besides, it has rich peripherals, such as PWM and UART. There are six 32-bit PWM outputs, making the chip very suitable for high-quality LED control.

1.1 Features

- Built in with the low-power 32-bit CPU, which can also function as an application processor
- The clock rate: 120 MHz
- Working voltage: 3.0 to 3.6V
- Peripherals: 15 PWMs and 1 UART
- Wi-Fi connectivity
 - 802.11 b/g/n
 - Channels 1 to 14@2.4 GHz
 - Support WEP, WPA/WPA2, and WPA/WPA2 PSK (AES) security modes
 - Up to +16 dBm output power in 802.11b mode
 - Support STA/AP/STA+AP working mode
 - Support SmartConfig and AP network configuration manners for Android and iOS devices
 - Onboard PCB antenna with a gain of 1.3 dBi
 - Working temperature: -40°C to 85°C
- Bluetooth connectivity
 - Support the transmit power of 6 dBm in the Bluetooth mode
 - Complete Bluetooth coexistence interface
 - Onboard PCB antenna with a gain of 1.3 dBi

1.2 Applications

- Intelligent building
- Smart household and home appliances

- Smart socket and light
- Industrial wireless control
- Baby monitor
- Network camera
- Intelligent bus

1.3 Change history

Update date	Updated content	Version after update
06/10/2021	This is the first release.	V1.0.0

2 Module interfaces

2.1 Dimensions and footprint

The dimensions of CB3SE are 16.00 ± 0.35 mm (W) \times 24.00 ± 0.35 mm (L) \times 2.8 ± 0.15 mm (H). The dimensions of CB3SE are as follows:

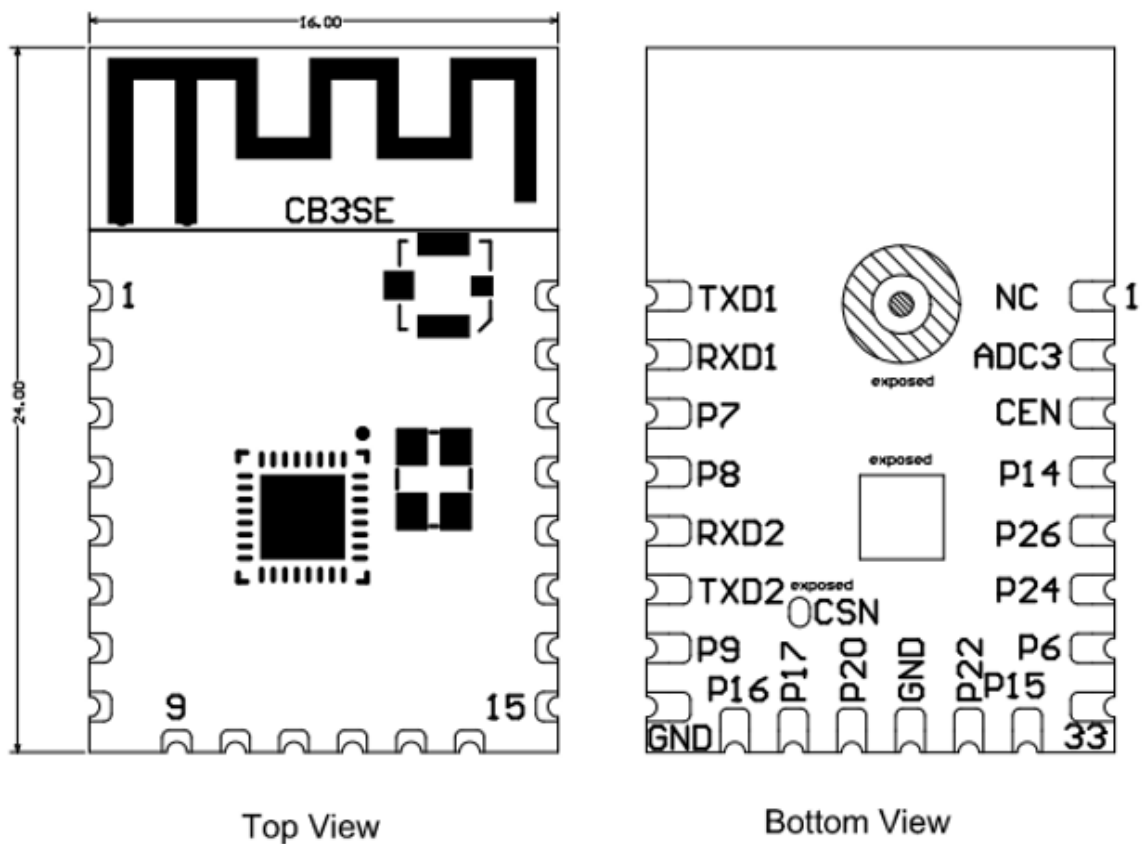

2.2 Pin definition

Pin number	Symbol	I/O type	Function
1	NC	I	Directly connected to Pin 3. Low level reset, high level active (the pin has been pulled high internally), correspond to CEN of the IC

Pin number	Symbol	I/O type	Function
2	ADC3	AI	ADC pin, which corresponds to P23 of the IC
3	CEN	I	Enabling pin, which is pulled high internally to be compatible with other modules
4	P14	I/O	A common GPIO interface, which corresponds to P14 of the IC
5	P26	I/O	GPIO_P_26, which corresponds to P26 of the IC, PWM 5
6	P24	I/O	GPIO_P_24, which corresponds to P24 of the IC, PWM 4
7	P6	I/O	GPIO_P_6, which corresponds to P6 of the IC, PWM 0
8	3V3	P	Power supply pin (3.3V)
9	P15	I/O	GPIO_P_15, which corresponds to P15 of the IC
10	P22	I/O	GPIO_P_22, which corresponds to P22 of the IC

Pin number	Symbol	I/O type	Function
11	GND	P	Power supply reference ground
12	P20	I/O	GPIOP_20, which corresponds to P20 of the IC
13	P17	I/O	GPIOP_17, which corresponds to P17 of the IC
14	P16	I/O	GPIOP_16, which corresponds to P16 of the IC
15	GND	P	Power supply reference ground
16	P9	I/O	GPIOP_9, which corresponds to P9 of the IC, PWM 3
17	TXD2	I/O	UART2_TXD (used to display the module internal information), which corresponds to P0 of the IC
18	RXD2	I/O	UART2_RXD, which corresponds to P1 on the internal IC
19	P8	I/O	GPIOP_8, which corresponds to P8 of the IC, PWM 2

Pin number	Symbol	I/O type	Function
20	P7	I/O	GPIOP_7, which corresponds to P7 of the IC, PWM 1
21	RXD1	I/O	UART1_RXD (User serial port), which corresponds to P10 of the IC Do not pull it up. By default, the docking serial port of the MCU needs to be in low level state or high impedance state.
22	TXD1	I/O	UART1_TXD (User serial port), which corresponds to P11 of the IC Do not pull it up. By default, the docking serial port of the MCU needs to be in low-level state or high-impedance state.

2.3 Definitions on test points

Pin number	Symbol	I/O type	Function
-	CSN	I/O	It's a mode selection pin. If it is connected to ground before being powered on, enter the firmware test mode. If it is not connected or connected to VCC before being powered on, enter the firmware application mode. Correspond to P21 of the IC

Note: P indicates a power supply pin, I/O indicates an input/output pin, and AI indicates an analog input pin. For the MCU solution, please refer to [CBx Module](#).

3 Electrical parameters

3.1 Absolute electrical parameters

Parameter	Description	Minimum value	Maximum value	Unit
Ts	Storage temperature	-55	125	°C
VBAT	Power supply voltage	-0.3	3.9	V

Parameter	Description	Minimum value	Maximum value	Unit
ESD voltage (human body model)	TAMB-25°C	-4	4	KV
ESD voltage (machine model)	TAMB-25°C	-200	200	V

3.2 Normal working conditions

Parameter	Description	Minimum value	Typical value	Maximum value	Unit
Ta	Working temperature	-40	-	85	°C
VBAT	Power supply voltage	3	3.3	3.6	V
VOL	I/O low level output	VSS	-	VSS+0.3	V
VOH	I/O high level output	VBAT-0.3	-	VBAT	V
I _{max}	I/O drive current	-	6	20	mA

3.3 RF power consumption

Working status	Mode	Rate	Transmit power/ Receive	Average value	Peak value (Typical value)	Unit
Transmit	11b	11Mbps	+16dBm	81	240	mA
Transmit	11g	54Mbps	+15dBm	82	238	mA
Transmit	11n	MCS7	+14dBm	85	234	mA
Receive	11b	11Mbps	Constantly receive	73	82	mA
Receive	11g	54Mbps	Constantly receive	75	82	mA
Receive	11n	MCS7	Constantly receive	75	82	mA

3.4 Working current

Working mode	Working status, Ta = 25°C	Average value	Maximum value (Typical value)	Unit
Quick network connection state (Bluetooth)	The module is in fast network connection state and the Wi-Fi indicator flashes fast	63	245	mA
Quick network connection state (AP)	The module is in hotspot network connection state and the Wi-Fi indicator flashes slowly	80	270	mA

Working mode	Working status, Ta = 25°C	Average value	Maximum value (Typical value)	Unit
Quick network connection state (EZ)	The module is in fast network connection state and the Wi-Fi indicator flashes fast	78	246	mA
Connected	The module is connected to the network and the Wi-Fi indicator is always on	25	342	mA
Weakly connected	The module and the hotspot are weakly connected and the Wi-Fi indicator is always on	205	350	mA
Disconnected	The module is disconnected and the Wi-Fi indicator is always off	63	242	mA
Module disabled	The CEN pin of the module is connected to the ground.	330	-	uA

4 RF parameters

4.1 Basic RF features

Parameter	Description
Working frequency	2.412 to 2.484 GHz
Wi-Fi standard	IEEE 802.11 b/g/n (channels 1 to 14)
Data transmission rate	11b: 1, 2, 5.5, 11 (Mbps); 11g: 6, 9, 12, 18, 24, 36, 48, 54 (Mbps); 11n: HT20 MCS 0 to 7; 11n: HT40 MCS 0 to 7
Antenna type	PCB antenna

4.2 Wi-Fi transmission performance

Parameter	Minimum value	Typical value	Maximum value	Unit
Average RF output power, 802.11b CCK Mode 11M	-	16	-	dBm
Average RF output power, 802.11g OFDM Mode 54M	-	15	-	dBm

Parameter	Minimum value	Typical value	Maximum value	Unit
Average RF output power, 802.11n OFDM Mode MCS7	-	14	-	dBm
Frequency error	-20	-	20	ppm

4.3 Wi-Fi receiving performance

Parameter	Minimum value	Typical value	Maximum value	Unit
PER<8%, RX sensitivity, 802.11b DSSS Mode 11M	-	-88	-	dBm
PER<10%, RX sensitivity, 802.11g OFDM Mode 54M	-	-74	-	dBm
PER<10%, RX sensitivity, 802.11n OFDM Mode MCS7	-	-73	-	dBm
PER<10%, RX sensitivity, Bluetooth LE 1M	-	-96	-	dBm

4.4 Bluetooth transmission performance

Parameter	Minimum value	Typical value	Maximum value	Unit
Working frequency	2402	-	2480	MHz
Air rate	-	1	-	Mbps
Transmit power	-20	6	20	dBm
Frequency error	-150	-	150	KHz

4.5 Bluetooth receiving performance

Parameter	Minimum value	Typical value	Maximum value	Unit
RX sensitivity	-	-96	-	dBm
Maximum RF signal input	-10	-	-	dBm
Inter-modulation	-	-	-23	dBm
Co-channel suppression ratio	-	10	-	dB

5 Antenna information

5.1 Antenna type

CB3SE uses the PCB antenna with the gain of 1.3 dBi.

5.2 Antenna interference reduction

To ensure the optimal Wi-Fi performance when the Wi-Fi module uses an onboard PCB antenna, it is recommended that the antenna be at least 15 mm away from other metal parts.

To prevent adverse impact on the antenna radiation performance, avoid copper or traces within the antenna area on the PCB.

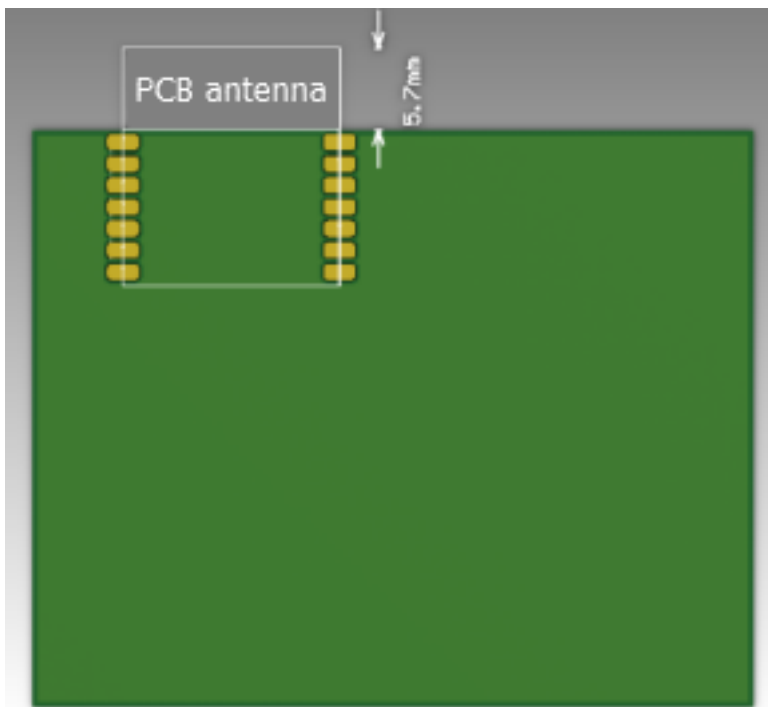

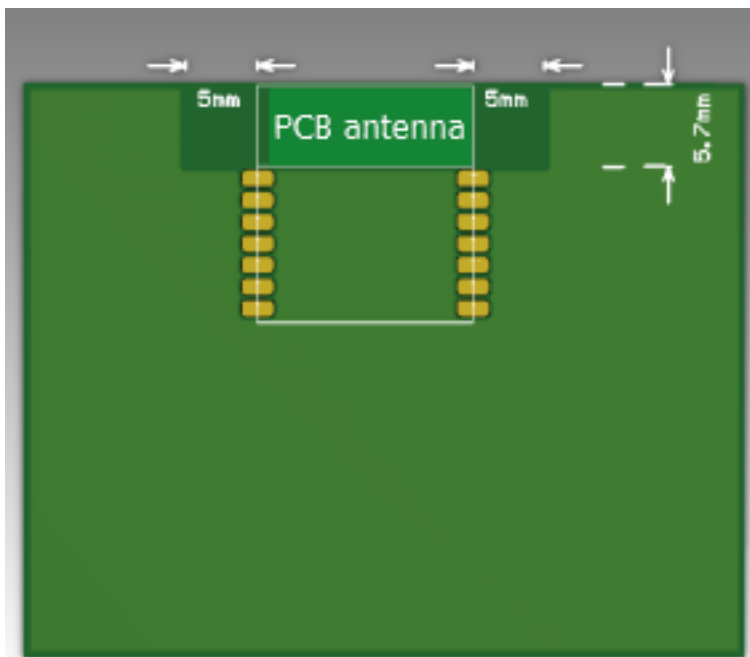
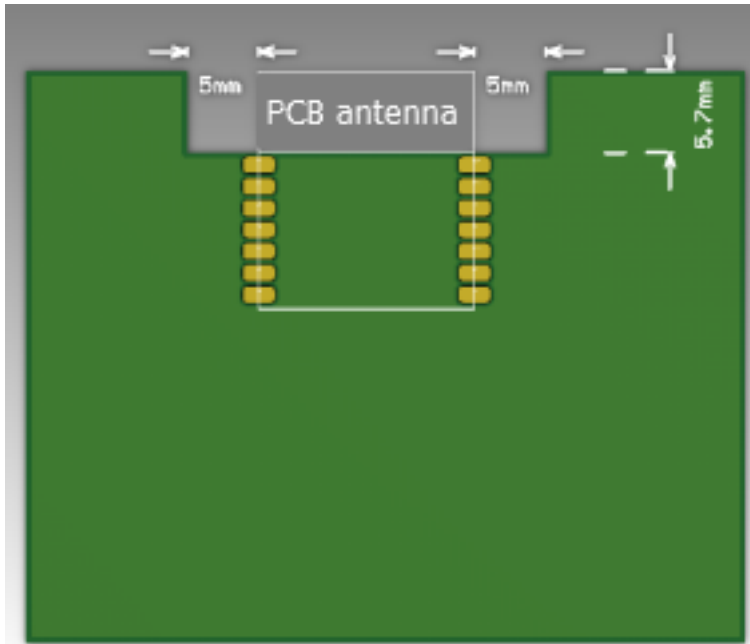

**Do not place any metal in the red area above the antenna.
The recommended diameter of the circular arc is greater than 3 cm.**

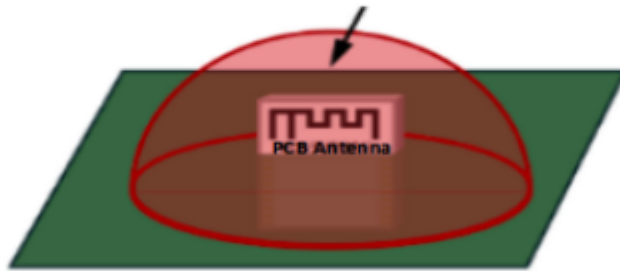

6 Packaging information and production instructions

6.1 Mechanical dimensions

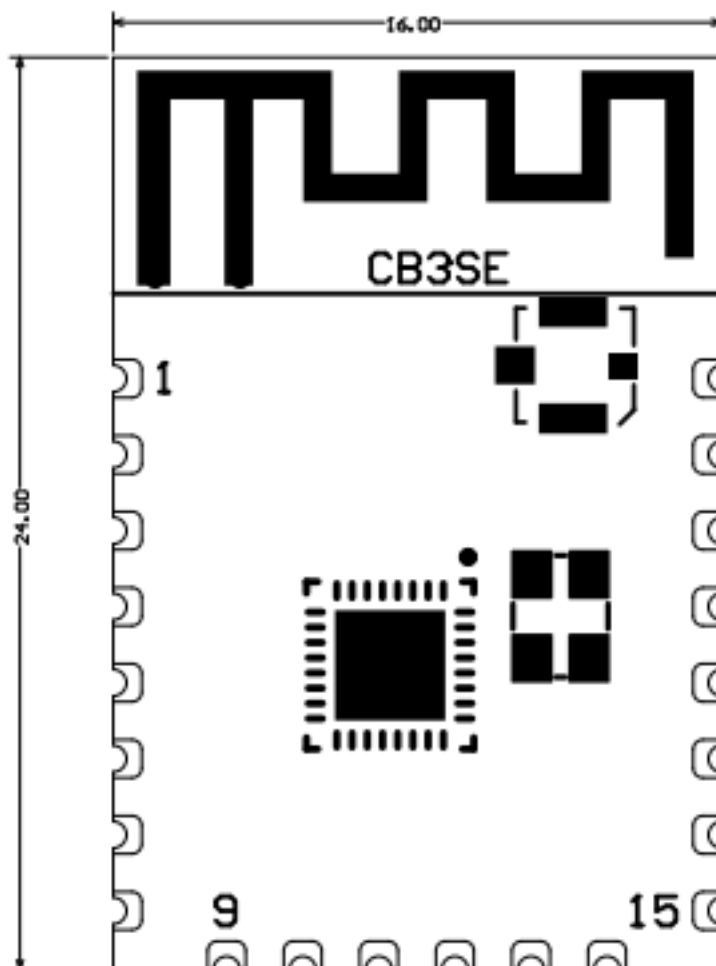

Top View

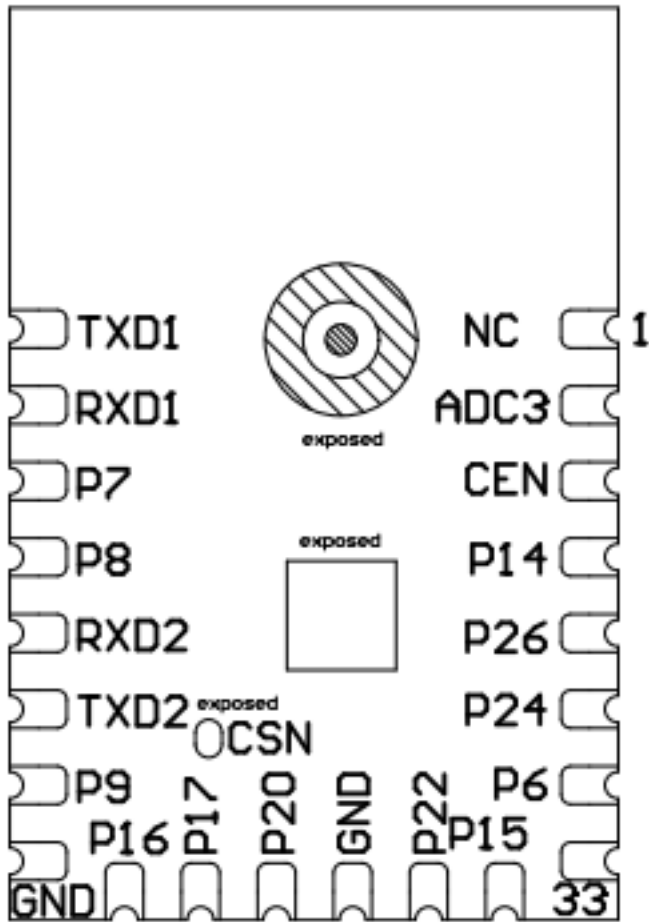

Bottom View



Unit: mm

Module form factor tolerance: $\pm 0.35\text{mm}$

PCB thickness tolerance: $\pm 0.1\text{mm}$

Shield cover height tolerance: $\pm 0.05\text{mm}$

Side View

6.2 Production instructions

1. The Tuya SMT module should be mounted by the SMT device. After being unpacked, it should be soldered within 24 hours. Otherwise, it should be put into the drying cupboard where the RH is not greater than 10%; or it needs to be packaged under vacuum again and the exposure time needs to be recorded (the total exposure time cannot exceed 168 hours).

- SMT devices:
 - Mounter
 - SPI
 - Reflow soldering machine
 - Thermal profiler
 - Automated optical inspection (AOI) equipment
- Baking devices:
 - Cabinet oven
 - Anti-electrostatic and heat-resistant trays
 - Anti-electrostatic and heat-resistant gloves

2. Storage conditions for a delivered module:

- The moisture-proof bag must be placed in an environment where the temperature is below 40°C and the relative humidity is lower than 90%.
- The shelf life of a dry-packaged product is 12 months from the date when the product is packaged and sealed.
- There is a humidity indicator card (HIC) in the packaging bag.

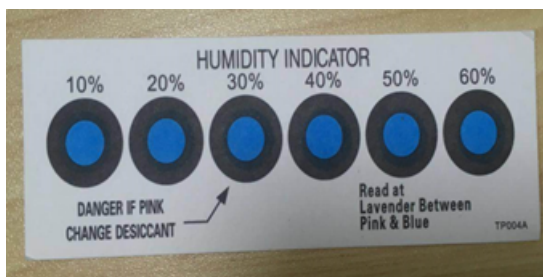

3. The module needs to be baked in the following cases:

- The packaging bag is damaged before unpacking.
- There is no HIC in the packaging bag.
- After unpacking, circles of 10% and above on the HIC become pink.
- The total exposure time has lasted for over 168 hours since unpacking.

- More than 12 months has passed since the sealing of the bag.

4. Baking settings:

- Temperature: 60°C and $\leq 5\%$ RH for reel package and 125°C and $\leq 5\%$ RH for tray package (please use the heat-resistant tray rather than plastic container)
- Time: 48 hours for reel package and 12 hours for tray package
- Alarm temperature: 65°C for reel package and 135°C for tray package
- Production-ready temperature after natural cooling: $< 36^\circ\text{C}$
- Re-baking situation: If a module remains unused for over 168 hours after being baked, it needs to be baked again.
- If a batch of modules is not baked within 168 hours, do not use the reflow soldering to solder them. Because these modules are Level-3 moisture-sensitive devices, they are very likely to get damp when exposed beyond the allowable time. In this case, if they are soldered at high temperatures, it may result in device failure or poor soldering.

5. In the whole production process, take electrostatic discharge (ESD) protective measures.

6. To guarantee the passing rate, it is recommended that you use the SPI and AOI to monitor the quality of solder paste printing and mounting.

6.3 Recommended oven temperature curve

Set oven temperatures according to the following temperature curve of reflow soldering. The peak temperature is 245°C.

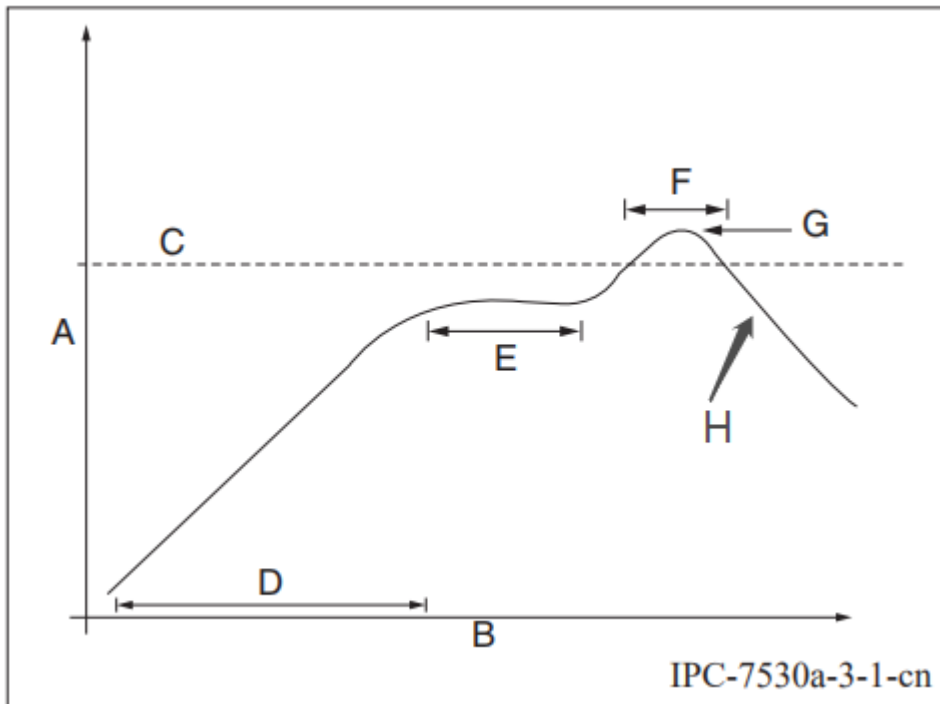

- A: Temperature axis
- B: Time axis
- C: Liquidus temperature: 217 to 220°C
- D: Ramp-up slope: 1 to 3°C/s
- E: Duration of constant temperature: 60 to 120s; the range of constant temperature: 150 to 200°C
- F: Duration above the liquidus: 50 to 70s
- G: Peak temperature: 235 to 245°C
- H: Ramp-down slope: 1 to 4°C/s

Note: The above curve is just an example of the solder paste SAC305. For more details about other solder pastes, please refer to Recommended oven temperature curve in the solder paste specifications.

7 MOQ and packaging information

Product number	MOQ (pcs)	Shipping packaging method	The number of modules per reel	The number of reels per carton
CB3SE	3600	Tape reel	900	4

8 Appendix: Statement

FCC Caution: Any changes or modifications not expressly approved by the party responsible for compliance could void the user’s authority to operate this device.

This device complies with Part 15 of the FCC Rules. Operation is subject to the following two conditions: (1) This device may not cause harmful interference, and (2) this device must accept any interference received, including interference that may cause undesired operation.

Note: This device has been tested and found to comply with the limits for a Class B digital device, according to part 15 of the FCC Rules. These limits are designed to provide reasonable protection against harmful interference in a residential installation. This device generates, uses, and can radiate radio frequency energy and, if not installed and used following the instructions, may cause harmful interference to radio communications. However, there is no guarantee that interference will not occur in a particular installation.

If this device does cause harmful interference to radio or television reception, which can be determined by turning the device off and on, the user is encouraged to try to correct the interference by one or more of the following measures:

- Reorient or relocate the receiving antenna.
- Increase the separation between the device and receiver.
- Connect the device into an outlet on a circuit different from that to which the receiver is connected.
- Consult the dealer or an experienced radio/TV technician for help.

Radiation Exposure Statement

This device complies with FCC radiation exposure limits set forth for an uncontrolled

rolled environment. This device should be installed and operated with a minimum distance of 20cm between the radiator and your body.

Important Note

This radio module must not be installed to co-locate and operating simultaneously with other radios in the host system except following FCC multi-transmitter product procedures. Additional testing and device authorization may be required to operate simultaneously with other radios.

The availability of some specific channels and/or operational frequency bands are country-dependent and are firmware programmed at the factory to match the intended destination. The firmware setting is not accessible by the end-user.

The host product manufacturer is responsible for compliance with any other FCC rules that apply to the host not covered by the modular transmitter grant of certification. The final host product still requires Part 15 Subpart B compliance testing with the modular transmitter installed.

The end-user manual shall include all required regulatory information/warnings as shown in this manual, including “This product must be installed and operated with a minimum distance of 20 cm between the radiator and user body”.

This device has got an FCC ID: 2ANDL-CB3SE. The end product must be labeled in a visible area with the following: “Contains Transmitter Module FCC ID: 2ANDL-CB3SE”.

This device is intended only for OEM integrators under the following conditions:

The antenna must be installed such that 20cm is maintained between the antenna and users, and the transmitter module may not be co-located with any other transmitter or antenna.

As long as the 2 conditions above are met, further transmitter tests will not be required. However, the OEM integrator is still responsible for testing their end-product for any additional compliance requirements required with this module installed.

Declaration of Conformity European Notice

Hereby, Hangzhou Tuya Information Technology Co., Ltd declares that this module product is in compliance with essential requirements and other relevant provisions

of Directive 2014/53/EU, 2011/65/EU. A copy of the Declaration of conformity can be found at <https://www.tuya.com>.



This product must not be disposed of as normal household waste, in accordance with the EU directive for waste electrical and electronic equipment (WEEE-2012/19/EU). Instead, it should be disposed of by returning it to the point of sale, or to a municipal recycling collection point.

The device could be used with a separation distance of 20cm to the human body.