

Metering

- If you cannot obtain suitable exposure conditions, you can change the metering method to take brighter pictures.

[MULTI] : Exposure will be calculated based on an average of the available light in the image area. However, the calculation will be biased towards the centre of the image area. This is suitable for general use.

[CENTER-WEIGHTED] : Exposure will be calculated based on an average of the available light in the image area. However, the calculation will be biased towards the centre of the image area. This is suitable for taking a picture of small object like a flower or insects.

[SPOT] : Only the rectangular area in the centre of the LCD monitor will be metered for light. This is suitable when the subject in the centre is exposed correctly, regardless of the back lighting.

- ※ If the subject is not the centre of the focus area, do not use the spot metering as this may result in an exposure error. In this circumstance, it is better to use exposure compensation.

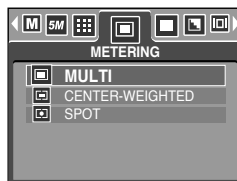

[PROGRAM mode]

Continuous shot

- You can select continuous shot, and AEB (Auto Exposure Bracketing).

- [SINGLE]: Take one picture only

- [CONTINUOUS]: Images will be taken continuously until the shutter button is released. The shooting capacity depends on the memory (Max : 4 shots).

- [AEB] : Take three pictures in a series in different exposures: short exposure (-0.5EV), standard exposure (0.0EV) and over exposure (+0.5EV). Use the mode if it is hard to decide exposure of the object.



[PROGRAM mode]

- ※ High resolution and picture quality increases file saving time, which increases stand-by time.
- ※ If the [CONTINUOUS] or [AEB] sub menu is selected, the flash will be off automatically.
- ※ If less than 3 pictures are available in the memory, the AEB shooting is not available.
- ※ It is best to use a tripod for the AEB shooting as the time to save each image file is longer and the blurring caused by camera shake may occur.
- ※ If the [TIFF] quality is selected, the [CONTINUOUS] or [AEB] menu can't be selected.

Sharpness

- You can adjust the sharpness of the picture you want to take. You cannot check the sharpness effect on the LCD monitor before you take a picture, because this function is applied only when the captured image is stored on the memory.

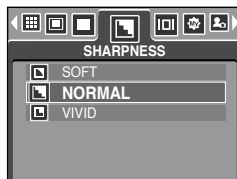

Sub menu	Icon	Description
SOFT		The edges of the image are softened. This effect is suitable for editing images on your PC.
NORMAL		The edges of the image are sharp. This is suitable for printing.
VIVID		The edges of the image are emphasized. The edges will appear sharp, but noise may occur in the recorded image.

OSD(On Screen Display) information

- In any mode with the exception of VOICE RECORDING mode, you can check the recording status in the LCD monitor.
- Idle mode : If you select the [SAVE MODE] and the camera isn't operated during the specified time(about 30 SEC.), the camera power will be idle (LCD monitor : OFF, Camera status lamp : Blinking) automatically.

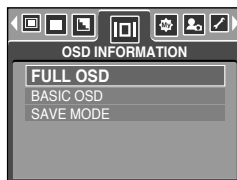

- To use the camera again, press any of the camera buttons except the power button.
- If there is no operation during the specified time, the camera power will be turned off automatically to save battery life. Refer to page 98 for more information about the auto power off function.



[Full information mode]



[Basic information mode]

Save / Load a specific camera configuration (MySET)

- Use the MySET mode to save frequently used camera settings (Save Myset) and use it later (Load Myset)
- Saving the camera configuration :
 1. Use the camera buttons and menu to set desired camera configuration.
 2. Select the Program mode and press the Menu button.
 3. Press the Left/Right buttons to select the [MYSET] menu tap.
 4. Select the [SAVE] menu by pressing the Up / Down button and press the Right button.
 5. Press the Up/Down buttons to select desired MySET slot number to save.
 6. Press the OK button to save the current configuration.

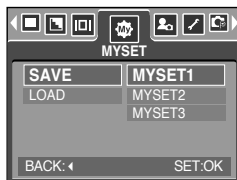

[PROGRAM mode]

- Loading the saved camera configuration:
 1. Select the Program mode and press the Menu button.
 2. Press the Left/Right buttons to select the [MYSET] menu tap.
 3. Select the [LOAD] menu by pressing the Up / Down button and press the Right button.
 4. Press the Up/Down buttons to select desired MySET slot number to load.
 5. Press the OK button to set the camera configuration as saved in the MySET slot.
- * The current MySET slot number is displayed in the top left of the LCD.

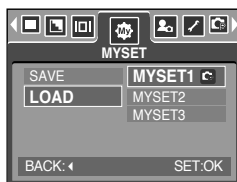

[PROGRAM mode]

INFORMATION

- Saving is available for the following camera functions.
 - Functions using the camera buttons - Macro, flash, white balance, ISO, RGB, Exposure value, Aperture value and Shutter speed.
 - Functions using the menu screen - Size, quality, metering, effect, sharpness and continuous shot.

Starting play mode

- If the memory card is inserted in the camera, all the camera functions apply only to the memory card.
- If the memory card is not inserted in the camera, all the camera functions apply only to the internal memory.
- If you have turned on the camera by pressing the POWER button, you can press the PLAY MODE button once to switch to Play mode and press it again to switch to Recording mode.
- You can turn the power on with the play mode button. The camera is turned on in play mode. Press the play mode button again and the camera will be turned off.
- You can set up the PLAY mode function by using the camera buttons and LCD monitor.

● Playing back a still image

1. Select the PLAY mode by pressing the play mode button ().



2. The last image stored on the memory is displayed on the LCD monitor.



3. Select an image that you want to play back by pressing the LEFT/ RIGHT button.

※ Press and hold the Left or Right button to fast forward the images played.



INFORMATION

- Manner mode : Pressing the play mode button for more than 3 seconds changes the buzzer and start-up sound setting to OFF, even though you may have set these to ON.
- Lightly press the shutter button in Play mode to switch to the currently set shooting mode.

Starting play mode

● Playing back a movie clip

Steps from 1-2 are the same as those to play back a still image.

3. Select the recorded movie clip that you want to play back by using the LEFT/ RIGHT button. If you select a movie clip, the movie clip indicator () will be displayed on the LCD monitor.

4. Press the play & pause button () to play back a movie clip file.

- To pause a movie clip file while playing it back, press the play & pause button again.

- Pressing the play & pause button again will cause the movie clip file will restart.

- To rewind the movie clip while it is playing, press the LEFT button. To fast forward the movie clip, press the RIGHT button.

- To stop playback of the movie clip, press the play & pause button, and then press the LEFT or RIGHT button.

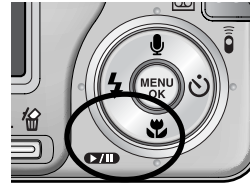

■ Movie clip capture function : capture still images from the movie clip.

● How to capture the movie clip

Steps 1-2 are the same as those for playing back a still image.

3. Select the recorded movie clip that you want to play back by using the LEFT/ RIGHT button.

4. Press the Play/ Pause button to play the movie clip

5. Press the Play/ Pause button while playing the movie clip. Then press the E button.

6. The paused movie clip is saved in a new file name.

※ The captured movie clip file has same size as the original movie clip.

- Normal angle mode : 640X480, 320X240, 160X120

- Wide angle mode : 640X360, 384X216, 256X144



[Paused]



[Pressing the E button]

Starting play mode

- On camera movie trimming : You can extract desired frames of movie clip during the movie clip play back.

1. Select a desired movie clip in the play mode.
2. Play back the movie clip by pressing the Play & Pause button.
3. Press the Pause button at the point of the movie clip that you want to start extracting.
4. Press the zoom T button.
5. Press the Play & Pause button and the extracted range will be displayed on the status bar.

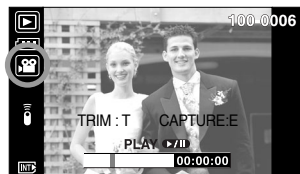

6. Press the Play & Pause button once more at the point where you wish the extracted file to stop.

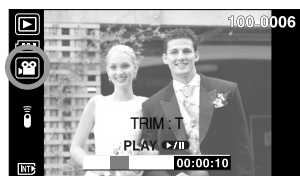

7. Press the zoom T button and a confirmation window will display.
8. Select a desired sub menu by pressing the Up/Down button and press the OK button.
[TRIM] : the extracted file will be saved.
[CANCEL] : cancels the extracting movie clip

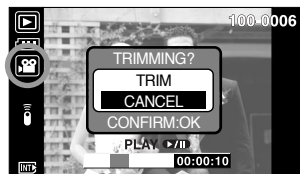

INFORMATION

- If the time line bar passes by the start point by pressing the REW(Left) button, the first frame of the movie clip will display.
- If you doesn't specify the ending point of the movie clip, the trimming confirmation window will display at the point of the last frame.

Starting play mode

- Playing back a recorded voice

Steps from 1-2 are the same as those to play back a still image.

3. Select the recorded voice that you want to play back by using the LEFT/ RIGHT button. If you select a recorded voice file, the voice indicator () will be displayed on the LCD monitor.

4. Press the play & pause button () to play back a recorded voice file.

- To pause a recorded voice file, while playing it back, press the play & pause button again.
- To resume playback of the voice file, press the play & pause button.
- To rewind the voice file while it is playing, press the LEFT button.
To fast forward the voice file, press the RIGHT button.
- To stop playback of the voice file, press the play & pause button, and then press the LEFT or RIGHT button.



LCD monitor indicator

- The LCD monitor displays shooting information about the displayed image.

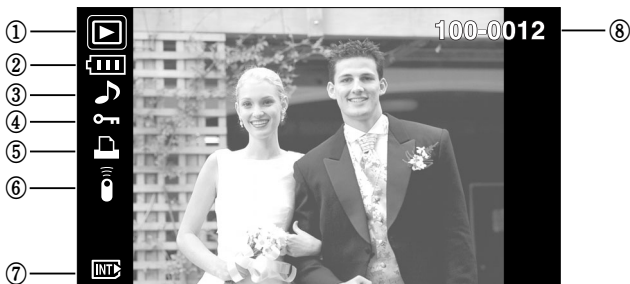

No.	Description	Icon	Page
1	Play mode		-
2	Battery		p.17
3	Movie clip / Voice memo		-
4	Protect indicator		p.85
5	DPOF indicator		p.86
6	Remote control indicator		-
7	Memory card indicator		-
8	Folder name and Stored image number	100-0012	-

- Select the [IMAGE INFORMATION] sub menu of the [OSD INFORMATION] menu and you can check the recording information.



SIZE : 2592X1944
AV : F3.3
TV : 1/60
ISO : 75
FLASH : OFF
DATE : 2005/08/01

SIZE : 2592X1944 Size
AV : F3.3 Aperture value
TV : 1/60 Shutter speed
ISO : 75 ISO sensitivity
FLASH : OFF Whether or not the flash is used
DATE : 2005/08/01 Recording date

Using the camera buttons to adjust the camera

- In Play mode, you can use the buttons on the camera to conveniently set up the Play mode functions.

Thumbnail() / Enlargement() button

- You can view multiple pictures, enlarge a selected picture, and crop and save a selected area of an image.
- Thumbnail display
 1. While an image is displayed full screen, press the thumbnail button.
 2. The thumbnail display will highlight the image that had been showing at the time the thumbnail mode was selected.
 3. Press the 5 function button to move to a desired image.
 4. To view an image separately, press the enlargement button.

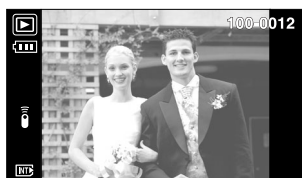

[Normal display mode]

Pressing the thumbnail button()



Pressing the enlargement button()

Highlighted image



[Thumbnail display mode]

● Image enlargement

1. Select an image that you want to enlarge and press the enlargement button.
2. Different parts of the image can be viewed by pressing the 5 function button.
3. Pressing the thumbnail button will zoom back to the original full sized image.
 - You can tell whether the image displayed is an enlarged view by checking the image enlargement indicator shown at the bottom left of the LCD monitor. (If the image is not an enlarged view, the indicator will not be displayed.) You can also check the area of enlargement.
 - Movie clips and WAV files can't be enlarged.
 - If an image is enlarged, a loss of quality may occur.

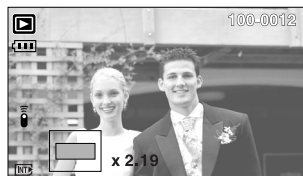
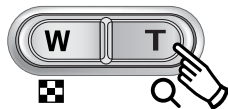

Thumbnail() / Enlargement() button

- The maximum enlargement rate in proportion to the image size.

Image size		5M	4M	3M	2M	1M	VGA
Maximum enlargement rate	Normal angle	X9.0	X6.45	X5.3	X5.0	X4.0	X3.3
	Wide angle	X4.6	X4.2	X3.6	X3.5	X2.5	X2.4

- Trimming : You can extract part of the image that you want and save it separately.
 1. Select an image that you want to enlarge and press the enlargement button.
 2. Different parts of the image can be viewed by pressing the 5 function button.
 3. Press the MENU button and a message will be displayed as shown alongside.
 4. Select a desired sub menu by pressing the UP/ DOWN button and press the OK button.
[TRIM] : The trimmed image will save as a new file name, and display on the LCD monitor.
[CANCEL]: The trimming menu will disappear.
 - ※ If there is little memory space to save the trimmed image, the image can't be trimmed.
 - ※ To delete the enlarged image during the trimming function, press the delete button.



Voice () memo / Up button

- When the menu is displayed on the LCD monitor, pressing the UP button makes the menu cursor move up.
 - When the menu is not displayed on the LCD monitor, the UP button operates as the voice memo button. You can add your voice to a stored still image.
- Adding a Voice Memo to a Still Image
 1. Press the LEFT/ RIGHT button to select an image that you wish to add sound to.
 2. Press the voice memo button () and the voice memo indicator will display. The camera is now ready to record a voice memo.

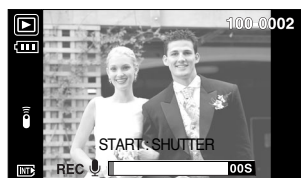

Voice () memo / Up button

3. Press the shutter button to start recording and voice will be recorded to the still image for 10 seconds. While the voice is recording, the recording status window will be displayed as shown alongside.



4. The recording can be stopped by pressing the shutter button again.

5. The () icon will be displayed on the LCD monitor after voice memo recording has finished.

- Voice memos can't be recorded onto movie clip and voice recording files.

- A distance of 40cm between you and the camera (microphone) is the best distance to record sound.

- The voice memo will be saved in *.wav format, but has the same file name as the still image to which it corresponds.

- If you add a new voice memo to the still image that already has a voice memo, the existing voice memo will be erased.



Play & Pause () / Down button

■ In Play mode, the play & pause/ down button works as follows:

- If the menu is displayed

Press the DOWN button to move from the main menu to a sub menu, or to move down the sub menu cursor.

- If a still image with a voice memo, a voice file, or a movie clip is playing

In Stop mode : Plays a still image with a voice memo, a voice file, or a movie clip.

During playback : Temporarily stops playback.

In Pause mode : Resumes playback



[Voice recording is stopped]

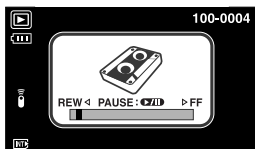

[Voice recording is playing]



[Voice recording is paused]

Delete () button

- This deletes images stored on the memory.
- **Deleting Images in Play Mode**
 1. Select an image that you want to delete by pressing the LEFT/ RIGHT button and press the DELETE() button.
 2. A message will display as shown alongside on the LCD monitor.
 3. Select the submenu values by pressing the UP/ DOWN button and then press the OK button.
If [DELETE] is selected : deletes the selected images.
If [CANCEL] is selected : cancels "Delete Image".

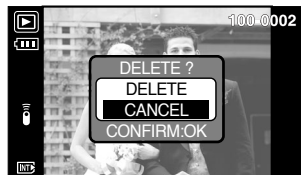
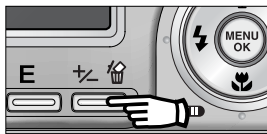

- **Deleting Images in Thumbnail Display Mode**
 1. Use the UP, DOWN, LEFT, and RIGHT buttons to select the image you want to delete, and then press the DELETE () button.
 2. The following message will be displayed on the LCD monitor.
 3. Select the submenu values by pressing the UP/DOWN button and then press the OK button.
If [DELETE] is selected : deletes the selected images.
If [CANCEL] is selected : cancels "Delete Image".



Press the delete button.



INFORMATION

- Before deleting images from the camera, you should protect or download images to your computer that you wish to keep.

Red eye / Printer button ()

- When an image that have Red-eye effect (When taking a people or animal with a photographic flash, the eye will be red) plays back, this button will remove the red colour.

1. In the Play mode, select an image that has red-eye effect by pressing the Left / Right button.
2. Press the Red eye button () and a menu bar for removing the red-eye effect will display.

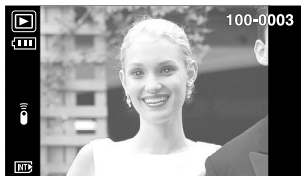

[An image that has red-eye effect]

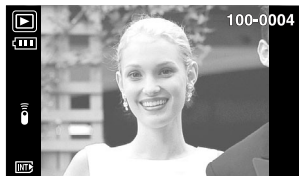

[An image removed the red-eye effect]

3. Press the OK button and the part of red-eyed image will appear more natural looking. Pressing the E button will cancel the menu.

- ※ This function can't be used with the TIFF file.
- ※ If the image size is VGA, the red-eye effect may not be removed.
- ※ According to the shooting conditions, this function may not activate. But, this is not the camera malfunction.

- If you selected [COMPUTER] sub menu of [USB] setup menu, when you connect the camera to your PictBridge printer, the [CONNECTING COMPUTER] message will display and the connection will not be established. In this case, press the Printer button and the camera is connected to the printer displaying the [CONNECTING PRINTER] message. But, the camera may not connect to the printer and turn off according to the printer manufacturer.

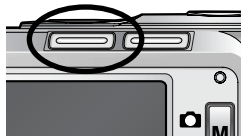

- After the connection, the Easy printing menu will display on the LCD monitor. To display PictBridge menu, press the Menu button. For more information about the PictBridge menu, refer to page 91.



Left / Right / Menu / OK button

- LEFT / RIGHT / MENU / OK buttons activate the following.
 - LEFT button : While the menu is showing, press the LEFT button to select the menu tab to the left of the cursor. While the menu is not showing, press the LEFT button to select the previous image.
 - RIGHT button : While the menu is showing, press the RIGHT button to select the menu tab to the right of the cursor, or to move an secondary menu. While the menu is not showing, press the RIGHT button to select the next image.
 - MENU button : When you press the MENU button, the play mode menu will be displayed on the LCD monitor. Pressing it again will return the LCD to the initial display.
 - OK button : When the menu is displayed on the LCD monitor, the OK button is used for confirming data that is changed by using the 5 function button.

Album button

- You can organise the captured still images (except for the TIFF file) into albums by using the Album button.
- This camera has 8 albums and each album can take up to 100 images.
- The album menu loading time depends on the memory card type.



■ How to use the album

● Selecting the album

1. In the play mode, press the Album button.

2. Select the ALBUM menu by pressing the Left/ Right button.

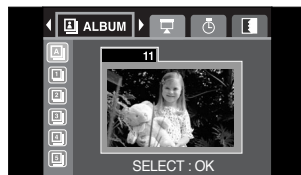

3. Select a desired album by pressing the Up/Down button.

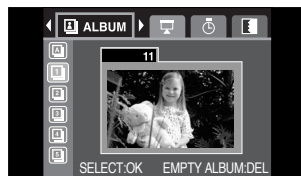

● Inserting still images into the album

1. Select (**A**) album.
2. Press the OK button and a window for inserting images will display.
3. Up/ Down button : select album for inserting images
Left/ Right button : select images for inserting.



Album button

4. Press the OK button and a confirmation window for inserting an image will display. Select a desired sub menu by Pressing the Up/Down button and press the OK button.

[YES] : inserts an image into the selected album.

[NO] : cancels the inserting image.



● Removing still images from the album

1. Select an album.
2. Press the delete button and a confirmation window will display.
3. Select a desired sub menu by pressing the Up/ Down button and press the OK button.

[YES] : Removes all images in the album

[NO] : Cancels the removing images



● Removing selected image

1. Select an album.
2. Press the OK button and a window for removing images will display.

Left/ Right button : select images

Delete button : A confirmation window will display.

Select a desired sub menu by pressing the Up/Down button and press the OK button.

[YES] : the selected image will be removed

[NO] : Cancels the removing image





INFORMATION

- If an image is deleted from the memory, the image doesn't display on an album.
- An image can be added into the different albums.

Album button



● Playing back the albums

⊙ Playing back all of the albums

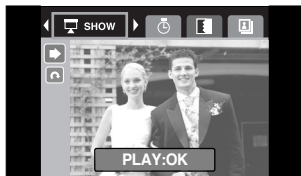
1. Select () album.
2. Select SHOW menu by pressing the Left/ Right button.
3. Select a desired sub menu by pressing the Up/ Down button. Press the OK button and the slide show will start.
() : The slide show is closed after one cycle.
() : The slide show is repeated until the OK button is pressed.



⊙ Playing a desired album

1. Select a desired album.
2. Select SHOW menu by pressing the Left/ Right button.
3. Select a desired sub menu by pressing the Up/ Down button. Press the OK button and the slide show will start.
() : The slide show is closed after one cycle.
() : The slide show is repeated until the OK button is pressed.





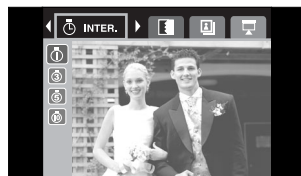





● Setting play interval: Set the slide show play interval.

1. Select a desired album.
2. Select INTER. menu by pressing the Left/ Right button.
3. Select a desired sub menu by pressing the Up/ Down button.



● Configure slide show effects

: Unique screen effects can be used for the slide show.

1. Select a desired album.
2. Select EFFECT menu by pressing the Left/ Right button.
3. Select a desired sub menu by pressing the Up/ Down button.
() : Normal display.
() : Image shows slowly.
() : Image is displayed slowly from the centre outwards.
() : Image moves from the top left.
() : The image slides diagonally from top left to bottom right.
() :    and  effects are applied in order.

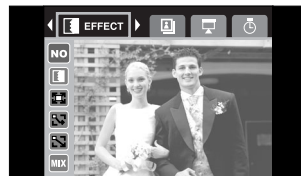

Remote control

- After connecting the camera with an external monitor, you can see the captured image by using the remote control.
- Remote control is optional in some countries.

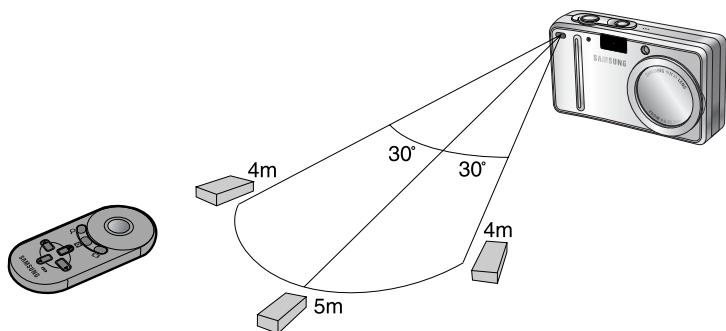

- In play mode, you can use the remote control to set up the play mode functions.

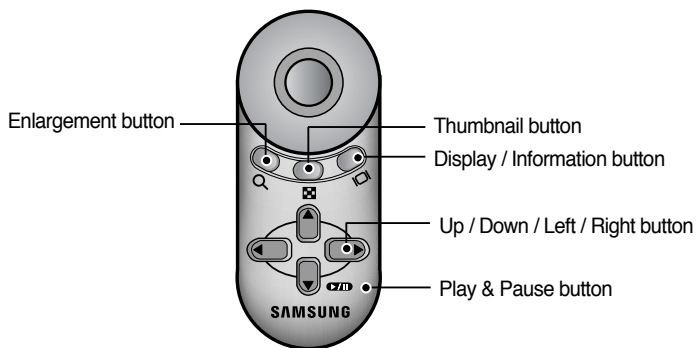







- See below for operation of buttons
 - Enlargement button : In play mode, this button enlarges the selected image.
 - Thumbnail button : If an image is enlarged, pressing this button will reduce the enlargement rate. In play mode, you can view multiple pictures by pressing this button.

Remote control

- Display / Information button : In play mode, you can view the information of the selected image by pressing this button.
- Up / Down/ Left / Right button : In play mode, you can select a still image or movie clip by pressing the Left/ Right button.
In play mode, different parts of the enlarged image can be viewed by pressing these buttons.
In the thumbnail mode, you can move to a desired image by pressing these buttons.
- Play & Pause button : If a still image with a voice memo or a movie clip is playing, pressing this button make the files play back or pause.



Setting up the play back function using the LCD monitor

- PLAY mode functions can be changed by using the LCD monitor. In the PLAY mode, pressing the MENU button displays the menu on the LCD monitor. The menus you can set up in Play mode are as follows. To capture an image after setting up the play menu, press the PLAY button.





Menu tab	Main menu	Sub menu	Secondary menu	Page
	ROTATE	RIGHT90°	-	p. 83
		LEFT90°	-	
		180°	-	
		HORIZONTAL	-	
		VERTICAL	-	
	RESIZE	Normal angle mode	Wide angle mode	p. 84
		2272X1704	2688X1512	
		2048X1536	2304X1296	
		1600X1200	1792X1008	
		1024X768	1280X720	
		640X480	768X432	
		USER IMAGE1,2	USER IMAGE1,2	
	PROTECT	SELECT	UNLOCK/LOCK	p. 85
		ALL	UNLOCK/LOCK	
	DELETE ALL	NO	-	p. 86
		YES	-	
	DPOF	STANDARD	ONE PIC/ALL PICS	p. 86
		INDEX	NO/ YES	
		PRINT SIZE	DEFAULT/3X5/4X6/5X7/8X10	
		CANCEL	STANDARD/INDEX/PRINT SIZE	
	OSD INFORMATION	FULL OSD		p. 89
		BASIC OSD	-	
		IMAGE INFORMATION	-	
	COPY TO CARD	NO	-	p. 90
		YES	-	

Setting up the play back function using the LCD monitor

- This menu is available while the camera is connected to a PictBridge supporting printer (direct connection to the camera, sold separately) with a USB cable.

Menu tab	Main menu	Sub menu	Secondary menu	Page
	IMAGES	ONE PIC	-	p. 92
		ALL PICS	-	
	AUTO SET	NO	-	p. 93
		YES	-	
	CUSTOM SET	SIZE	AUTO	p. 93
			POSTCARD	
			CARD	
			LETTER	
			4 X 6	
			L	
			2L	
			A4	
		A3		
		LAYOUT	AUTO	
			FULL	
			1	
			2	
			4	
			8	
			9	
16				
TYPE	AUTO			
	PLAIN			
	PHOTO			
	FAST PHO.			

Setting up the play back function using the LCD monitor

Menu tab	Main menu	Sub menu	Secondary menu	Page
	CUSTOM SET	QUALITY	AUTO	p. 93
			DRAFT	
			NORMAL	
			FINE	
		DATE	AUTO	
			OFF	
			ON	
		FILE NAME	AUTO	
			OFF	
ON				
	PRINT	STANDARD	-	p. 94
		INDEX	-	
	DPOF PRINT	NO	-	p. 94
		YES	-	
	RESET	NO	-	p. 95
		YES	-	

※ Menus are subject to change without prior notice.

Rotating an image

■ You can rotate the stored images by various degrees. Once the playback of the rotated picture is finished, it will switch back to the original state.

1. Press the play mode button and press the menu button.
2. Press the LEFT/ RIGHT button and select the [ROTATE] menu tab.
3. Select a desired sub menu by pressing the UP/ DOWN button.

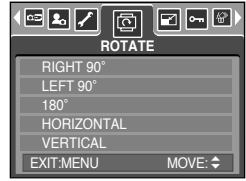

[RIGHT 90°] :
Rotate picture in a
clock-wise direction



[LEFT 90°] :
Rotate picture in a counter-
clock-wise direction



[180°] :
Rotate picture 180 degrees



[HORIZONTAL] :
Rotate picture horizontally



[VERTICAL] :
Rotate picture vertically

4. Press the OK button and the rotated image will be displayed.

If you display the rotated image on the LCD monitor, empty spaces may appear to the left and right of the image.

Resize

- Change the resolution (size) of pictures taken. Select [USER IMAGE] to save an image to be the start-up image. The resized image will have a new file name.

1. Press the play mode button and press the menu button.
2. Press the LEFT/ RIGHT button and select the [RESIZE] menu tab.
3. Select a desired sub menu by pressing the UP/ DOWN button and press the OK button.



● Image Resize Types

Resize	4M	3M	2M	1M	VGA	USER IMAGE
5M	O	O	O	O	O	O
4M	X	O	O	O	O	O
3M	X	X	O	O	O	O
2M	X	X	X	O	O	O
1M	X	X	X	X	O	O
VGA	X	X	X	X	X	O

INFORMATION

- A large sized image can be resized to a smaller sized image, but not vice versa.
- Only JPG images can be resized. MP4 (MOVIE), WAV (VOICE) and TIFF files can't be resized.
- You can change the resolution of only those files compressed in the JPEG 4:2:2 format.
- The resized image will have a new file name. The [USER IMAGE] image is stored not on the memory card but on the internal memory.
- Only two [USER IMAGE] images can be saved. If you save a new [USER IMAGE] image, the existing startup image will be deleted in order.
- If the memory capacity is insufficient to store the resized image, a [CARD FULL!] message will display on the LCD monitor and the resized image will not be stored.

Protecting images

- This is used to protect specific shots from being accidentally erased (LOCK). It also unprotects images that have been previously protected (UNLOCK).

● Protecting Images

1. Press the play mode button and press the menu button.
2. Press the LEFT/ RIGHT button and select the [PROTECT] menu tab.
3. Select a desired sub menu by pressing the UP/ DOWN button and press the OK button.

[SELECT] : Only an image that is displayed on the LCD monitor is protected or unprotected.

[ALL] : All of the stored images are protected or unprotected.



4. Select the desired secondary menu by pressing the UP/ DOWN button and press the OK button.

[UNLOCK] : Cancels the protect function.

[LOCK] : Sets up the protect function.

- If you select the [SELECT] sub menu at step 3, you can protect or unprotect another image by pressing the LEFT/ RIGHT button. If you press the SHUTTER button, the Image Protection menu will disappear.

- If you protect an image, the protect icon() will be displayed on the LCD monitor.

(An unprotected image has no indicator)

- An image in LOCK mode will be protected from delete or [DELETE ALL] functions, but will NOT be protected from the [FORMAT] function.



Deleting all images

- Of all the files stored in the memory card, the unprotected files in the DCIM subfolder will be deleted. Remember that this will permanently delete unprotected images. Important shots should be stored on a computer before deletion takes place. The startup image is stored in the camera's internal memory (i.e., not on the memory card) and it will not be deleted even if you delete all files on the memory card.

● Deleting all images

1. Press the play mode button and press the menu button.
2. Press the LEFT/ RIGHT button and select the [DELETE ALL] menu tab.
3. Select a desired sub menu by pressing the UP/ DOWN button and press the OK button.

Selecting [NO] : cancels "Delete All"

Selecting [YES] : Displays the dialogue box to confirm the delete.

- If [DELETE] is selected : press the OK button and all unprotected pictures are deleted.

- If [CANCEL] is selected : press the OK button and images are not deleted.



DPOF

- DPOF(Digital Print Order Format) allows you to embed printing information on your memory card's MISC folder. Select the pictures to be printed and how many prints to make.
- The DPOF indicator will display on the LCD monitor when an image that has DPOF information plays back. Images can then be printed on DPOF printers, or at an increasing number of photo labs.
- This function is not available for Movie clips and Voice recording files.
- When the wide angle image is printed as a real size, 8% of the left and right side of the image may not be printed. Check that your printer can support the wide angle image when you print the image. When you print the image on the photo labs, ask them the image has to be printed as a wide angle image. (Some photo labs may not support the wide angle size print.)

DPOF : STANDARD

- This function allows you to embed print quantity information on a stored image.

1. Press the play mode button and press the menu button.
2. Press the LEFT/ RIGHT button and select the [DPOF] menu tab.
3. Select the [STANDARD] menu by pressing the UP/ DOWN button and press the RIGHT button.
4. Use the UP and DOWN buttons to select [ONE PIC] or [ALL PICS], and then press the OK button. A window for selecting number of copies will display.

[ONE PIC] : Set the number of copies to print for the current picture only.

[ALL PICS] : Set the number of copies to print for each picture, excluding movie clips and voice recordings.

5. Use the UP and DOWN buttons to select the number of copies and then press the OK button.

- The DPOF icon () will appear by the pictures for which the number of copies to print is set.



DPOF : INDEX

- Images (except for movie clips and voice file) are printed as index type.

1. Press the play mode button and press the menu button.
2. Press the LEFT/ RIGHT button and select the [DPOF] menu tab.
3. Select the [INDEX] menu by pressing the UP/ DOWN button and press the RIGHT button.
4. Select a desired sub menu by pressing the UP/ DOWN button.

If [NO] is selected : The image will not be printed in index format.

If [YES] is selected : The image will be printed in index format.

5. Press the OK button to confirm the setting.
6. Press the menu button twice and the menu will disappear.



DPOF : PRINT SIZE

- You can specify the print size when printing images stored on the memory card.
The [PRINT SIZE] menu is available only for DPOF 1.1 compatible printers.

● Setting the Print Size

1. Press the play mode button and press the menu button.
2. Press the LEFT/ RIGHT button and select the [DPOF] menu tab.
3. Select the [PRINT SIZE] menu by pressing the UP/ DOWN button and press the RIGHT button.
4. Select a desired sub menu by pressing the UP/ DOWN button and press the OK button.

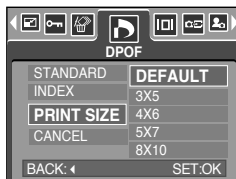

* PRINT SIZE : DEFAULT, 3X5, 4X6, 5X7, 8X10

* The [DEFAULT] print size varies depending on the printer manufacturer.

For your printer's default value, please refer to the user's guide that came with your printer.

DPOF : CANCEL

- You can cancel the [STANDARD], [INDEX], or [PRINT SIZE] settings. Cancel the setting to reset the value to its default.

1. Press the play mode button and press the menu button.
2. Press the LEFT/ RIGHT button and select the [DPOF] menu tab.
3. Select the [CANCEL] menu by pressing the UP/ DOWN button and press the RIGHT button.
4. Select a desired sub menu by pressing the UP/ DOWN button.

If [STANDARD] is selected : Cancels the standard print setting.

If [INDEX] is selected : Cancels the index print setting.

If [PRINT SIZE] is selected : Cancels the print size setting.

5. Press the OK button to confirm the setting.

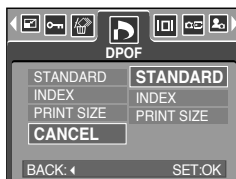

On Screen Display information

- You can check shooting information about the displayed image.

1. Press the play mode button and press the menu button.
2. Select the [OSD INFORMATION] menu tab by pressing the LEFT/ RIGHT button.
3. Select a desired sub menu by pressing the UP/ DOWN button.

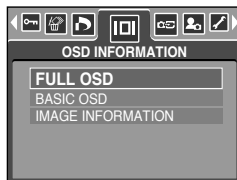

- [FULL OSD] : All information shown as below is displayed.
- [BASIC OSD] : Some information shown as below is displayed.
- [IMAGE INFORMATION] : Shooting information about the displayed image is displayed.

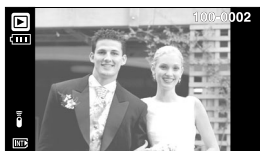

[FULL OSD]



[BASIC OSD]



[IMAGE INFORMATION]

4. Press the OK button to confirm the setting.

Copy To Card

- This enables you to copy image files, movie clips and voice recording files to the memory card.
- Copying to the Memory Card
 1. Press the play mode button and press the menu button.
 2. Select the [COPY TO CARD] menu tab by pressing the LEFT/ RIGHT button.
 3. Select a desired sub menu by pressing the UP/ DOWN button and press the OK button.
 - [NO] : Cancels "Copy to Card".
 - [YES]: All images, movie clips and voice recording files saved in the internal memory are copied to the memory card after the [Processing!] message is displayed. After copying has been completed, the screen will return to play mode.

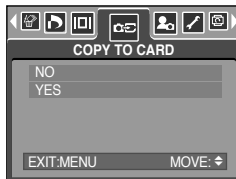

INFORMATION

- When this menu is selected without inserting a memory card, you can select the [COPY TO CARD] menu but the menu can't be run.
- If there is not enough space available in the memory card to copy saved images in the internal memory (24MB), the [COPY TO CARD] command will copy only some of the images and display [CARD FULL!] message. Then the system will return to the playback mode. Please be sure to delete any unnecessary files to free up space before inserting the memory card into the camera.
- When you move the images that are stored in the internal memory by doing [COPY TO CARD] to the card, the next number of file names will be created in the card to avoid duplication of the file name.
 - When the [RESET] of the [FILE] setup menu was set : The copied file names start from after the last stored file name.
 - When the [SERIES] of the [FILE] setup menu was set : The copied file names start from after the last captured file name. After completing [COPY TO CARD], the last stored image of the last copied folder is displayed on the LCD monitor.

PictBridge

- You can use the USB cable to connect this camera to a printer that supports PictBridge (sold separately) and print the stored images directly. Movie clips and voice files cannot be printed.

- Setting up the camera for connection with the printer
 1. In any mode with the exception of Voice Recording mode, press the MENU button.
 2. Press the LEFT/ RIGHT button and select [SETUP] menu tab.
 3. Select [USB] menu by pressing the UP/ DOWN button and press the RIGHT button.
 4. Select [PRINTER] menu by pressing the UP/ DOWN button and press the OK button.

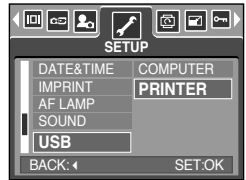

- Connecting the Camera to a Printer

- Using the USB cable with Cradle :

Connect the camera and the cradle. Connect the cradle to a printer's USB port with the supplied USB cable.

- Using the USB cable with Camera :

Connect the camera to a printer's USB port with the supplied USB cable.

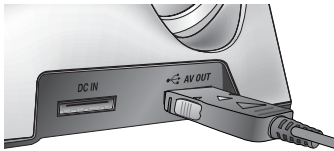

[Using the USB cable with Cradle]

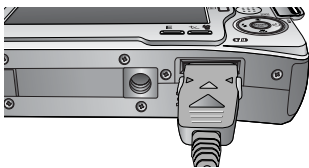

[Using the USB cable with Camera]

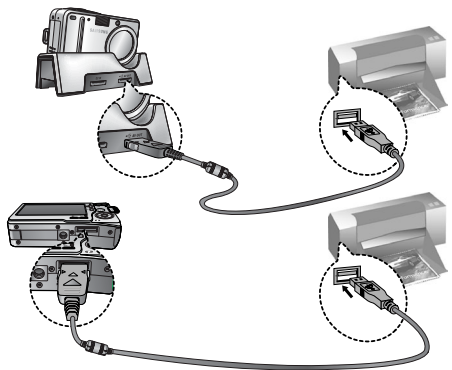

※ If you selected [COMPUTER] in Step 4, when you connect the camera to your printer, the [CONNECTING COMPUTER] message will display and the connection will not be established. In this case, disconnect the USB cable, and then follow the procedure from Step 2 and onward. Or, press the Printer button and the camera is connected to the printer displaying the [CONNECTING PRINTER] message. But, the camera may not connect to the printer and turn off according to the printer manufacturer.

PictBridge : Picture Selection

■ Easy printing

When you connect the camera to printer in the Play back mode, you can print a picture easily.

- Pressing the shutter button : Currently displayed image will be printed with the printer's default setting.
- Pressing the Left/ Right button : Selects a previous/ next image.

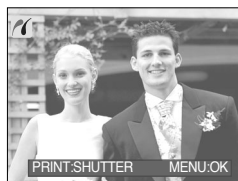

■ Select pictures to print

1. Press the Menu button.
2. The [IMAGES] menu will appear.
3. Use the UP and DOWN buttons to select the desired submenu value, and then press the OK button.

When [ONE PIC] is selected : The PictBridge function will be applied only to the picture currently displayed.

When [All PICS] is selected : The PictBridge function will be applied to all pictures, excluding movie clips and voice files.



● Setting the Number of Copies to Print

- Select [ONE PIC] or [All PICS]. A screen where you can set the number of copies to print will appear as shown below.



[When [ONE PIC] is selected]



[When [All PICS] is selected]

- Press the Up/ Down button to select the number of prints.
- When [ONE PIC] is selected : Use the Left/ Right button to select another picture and select the number of prints for another picture.
- After setting the number of prints, press the OK button to save.
- Press the Shutter button to return to the menu without setting the number of prints.

PictBridge : Print Setting

■ AUTO SET

1. Use the LEFT and RIGHT buttons to select the [AUTO SET] menu tab.
2. Use the UP and DOWN buttons to select the desired submenu value, and then press the OK button.
[NO] : [CUSTOM SET] values are kept.
[YES] : All values in the [CUSTOM SET] are automatically changed.

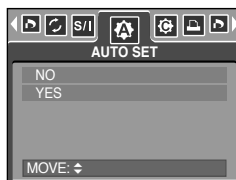

■ Custom Set : You can select the Paper Size, Print Format, Paper Type, Print Quality, Date Print, and File Name Print menus for printed pictures.

1. Use the LEFT and RIGHT buttons to select the [CUSTOM SET] menu tab.
2. Use the UP and DOWN buttons to select the desired submenu value, and then press the RIGHT button.
3. Use the UP and DOWN buttons to select the desired submenu value, and then press the OK button.



● The menus you can set up are as follows:

Menu	Function	Sub menu
SIZE	Setting the size of the printing paper	AUTO, POSTCARD, CARD, 4 X 6, L, 2L, LETTER, A4, A3
LAYOUT	Setting the number of pictures to be printed on a sheet of paper	AUTO, FULL, 1, 2, 4, 8, 9, 16
TYPE	Setting the quality of the printing paper	AUTO, PLAIN, PHOTO, FASTPHO.
QUALITY	Setting the quality of the picture to be printed	AUTO, DRAFT, NORMAL, FINE
DATE	Setting whether to print the date	AUTO, OFF, ON
FILE NAME	Setting whether to print the file name	AUTO, OFF, ON

- ※ Some menu options are not supported in all manufacturer and printer models.
If not supported, the menus are still displayed in the LCD, but are not selectable.
- ※ If the setting values are not changed in the automatic/ manual setting, the setting values are automatically kept.

PictBridge : Printing

- When the wide angle image is printed as a real size, 8% of the left and right side of the image may not be printed. Check that your printer can support the wide angle image when you print the image. When you print the image on the photo labs, ask them the image has to be printed as a wide angle image. (Some photo labs may not support the wide angle size print.)

■ Printing Pictures

1. Use the LEFT and RIGHT buttons to select the [PRINT] menu tab.

2. Use the UP and DOWN buttons to select the desired submenu value, and then press the OK button.

[STANDARD] : Print the pictures stored in the memory card in set numbers. One picture is printed on one piece of paper.

[INDEX] : Print multiple images on one sheet of paper.

3. The screen shown on the right will appear and the picture will be printed. If no picture is selected, the [NO IMAGE!] message will be displayed. Press the shutter button while printing to cancel the printing and the [IMAGES] menu is displayed.

- ※ Number of pictures in an index print varies depends on the printer used.

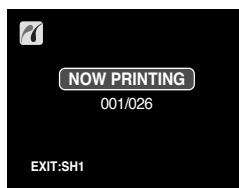

- DPOF Print : This allows you to directly print the files with DPOF information.

1. Use the LEFT and RIGHT buttons to select the [DPOF PRINT] menu tab.

2. Use the UP and DOWN buttons to select the desired submenu value, and then press the OK button.

[NO] : Cancel the printing

[YES] : Directly print the file with the DPOF information



- ※ Depending on the manufacturer and printer model, some menus may not be available.

With a printer without supporting the DPOF, the menu is still displayed but not available.

PictBridge : RESET

- Initialises user-changed configurations.

1. Use the LEFT and RIGHT buttons to select the [RESET] menu tab.
2. Use the UP and DOWN buttons to select the desired submenu value, and then press the OK button.

If [NO] is selected : Settings will not be reset.

If [YES] is selected : All print and image settings will be reset.



- ※ Default print setting varies depending on the printer manufacturer.

For your printer's default setting, refer to the user's guide that came with your printer.

Setup menu

- In this mode, you can set up basic settings. You can use the setup menu in all camera modes, except Voice Recording mode.
The items indicated by  are default settings.

Menu tab	Main menu	Sub menu	Secondary menu	Page	
	FILE	SERIES	-	p.97	
		RESET	-		
	PWR SAVE	OFF, 1, 3 , 5MIN	-	p.98	
	LANGUAGE	ENGLISH	한국어	FRANÇAIS	p.99
		DEUTSCH	ESPAÑOL	ITALIANO	
		简体中文	繁體中文	日本語	
		РУССКИЙ	PORTUGUÊS	DUTCH	
		DANSK	SVENSKA	SUOMI	
		ไทย	BAHASA	عربي	
		ČEŠTINA	POLSKI	MAGYAR	
	FORMAT	NO	-	p.99	
		YES	-		
	DATE&TIME	05/01/01 13:00	OFF	p.100	
		YYYY/MM/DD	-		
		DD/MM/YYYY	-		
		MM/DD/YYYY	-		
	IMPRINT	OFF	-	p.100	
		DATE	-		
		DATE&TIME	-		
	AF LAMP	OFF	-	p.101	
		ON	-		
	SOUND	OFF	-	p.101	
		LOW	-		
		MEDIUM	-		
		HIGH	-		
	USB	COMPUTER	-	p.102	
		PRINTER	-		

Setup menu

Menu tab	Main menu	Sub menu	Secondary menu	Page
	LCD	DARK	-	p.102
		NORMAL	-	
		BRIGHT	-	
	VIDEO	NTSC	-	p.103
		PAL	-	
	Q.VIEW	OFF, 0.5, 1, 3SEC	-	p.105
	RESET	NO	-	p.105
		YES	-	

※ Menus are subject to change without prior notice.

File name

■ This function allows the user to select the file naming format.

● Assigning File Names

1. In any mode with the exception of Voice Recording mode, press the MENU button.
2. Press the LEFT/ RIGHT button and select the [SETUP] menu tab.
3. Select the [FILE] menu by pressing the UP/ DOWN button and press the RIGHT button.
4. Select a desired sub menu by pressing the UP/ DOWN button and press the OK button.

[SERIES] : New files are named using numbers that follow the previous sequence, even when a new memory card is used, or after formatting, or after deleting all pictures.

[RESET] : After using the reset function, the next file name will be set from 0001 even after formatting, deleting all or inserting a new memory card.

5. Press the menu button twice and the menu will disappear.



File name

INFORMATION

- The first stored folder name is 100SSCAM, and the first file name is SL550001.
- File names are assigned sequentially from SL550001 → SL550002 → ~ → SL559999.
- The folder number is assigned sequentially from 100 to 999 as follows:
100SSCAM → 101SSCAM → ~ → 999SSCAM.
- The files used with the memory card conform to the DCF(Design rule for Camera File systems) format.

Auto power off

- This function switches the camera off after a set amount of time in order to prevent unnecessary battery drainage.

● Setting Power Off

1. In any mode with the exception of Voice Recording mode, press the MENU button.
2. Press the LEFT/ RIGHT button and select the [SETUP] menu tab.
3. Select the [PWR SAVE] menu by pressing the UP/ DOWN button and press the RIGHT button.
4. Select a desired sub menu by pressing the UP/ DOWN button and press the OK button.



[OFF]: The power off function will not operate.

[1, 3, 5 MIN] : The power will turn off automatically if not used for the period of time specified.

5. Press the menu button twice and the menu will disappear.

INFORMATION

- Even if the battery is removed and inserted again, the power off setting will be preserved.
- Note that the automatic power off function will not operate if the camera is in PC mode, slide show, playing back a voice recording and playing back a movie clip.

Language

- There is a choice of languages that can be displayed on the LCD monitor. Even if the battery is removed and inserted again, the language setting will be preserved.

● Setting Language

1. In any mode with the exception of Voice Recording mode, press the MENU button.
2. Press the LEFT/ RIGHT button and select the [SETUP] menu tab.
3. Select the [LANGUAGE] menu by pressing the UP/ DOWN button and press the RIGHT button.
4. Select a desired sub menu by pressing the UP/ DOWN button and press the OK button.



LANGUAGE sub menu : English, Korean, French, German, Spanish, Italian, S.Chinese, T.Chinese, Japanese, Russian, Portuguese, Dutch, Danish, Swedish, Finnish, Thai, BAHASA(MALAY/ INDONESIAN), Arabic, Hungarian, Czech and Polish.

5. Press the menu button twice and the menu will disappear.

Formatting a memory

- This is used for formatting the memory. If you run [FORMAT] on the memory, all images, including the protected images, will be deleted. Be sure to download important images to your PC before formatting the memory.

● Formatting a memory

1. In any mode other than Voice Recording mode, press the MENU button.
2. Press the LEFT/ RIGHT button and select the [SETUP] menu tab.
3. Select the [FORMAT] menu by pressing the UP/ DOWN button and press the RIGHT button.
4. Select a desired sub menu by pressing the UP/ DOWN button and press the OK button.



If [NO] is selected : The memory will not be formatted.
Press the menu button twice and the menu display will disappear.

If [YES] is selected : A confirmation window will display. Select the [FORMAT] message. A [PROCESSING!] message appears and the memory will be formatted. If you ran FORMAT in Play mode, a [NO IMAGE!] message will appear.

INFORMATION

- Be sure to run [FORMAT] on the following types of memory card.
 - A new memory card, or an unformatted memory card.
 - A memory card that has a file this camera can't recognise or one that has been taken from another camera.
- Always format the memory card using this camera. If you insert a memory card that has been formatted using other cameras, memory card readers, or PCs, you will get a [CARD ERROR!] message.

Setting up the Date / Time / Date type

- You can change the date and time that will be displayed on the captured images and set up the date type.
- Setting Date / Time & Selecting Date Format
 1. In any mode with the exception of Voice Recording mode, press the MENU button.
 2. Press the LEFT/ RIGHT button and select the [SETUP] menu tab.
 3. Select the [DATE&TIME] menu by pressing the UP/ DOWN button and press the RIGHT button.
 4. Use the UP, DOWN, LEFT, and RIGHT buttons to select the desired submenu value, and then press the OK button.
 - RIGHT button : Selects the year/ month/ day/ hour/ minute date type.
 - LEFT button : Moves the cursor to the [DATE&TIME] main menu if the cursor is at the first item of the date and time setup. In all other cases, the cursor will be shifted to the left of its current position.
 - UP and DOWN buttons : Changes the setting value.
 5. Press the menu button twice and the menu will disappear.



Imprinting the recording date

- There is an option to include DATE/ TIME on still images.
- Date Imprinting
 1. In any mode with the exception of Voice Recording mode, press the MENU button.
 2. Press the LEFT/ RIGHT button and select the [SETUP] menu tab.
 3. Select the [IMPRINT] menu by pressing the UP/ DOWN button and press the RIGHT button.
 4. Use the UP and DOWN buttons to select the desired date imprint type, and then press the OK button.
 - [OFF] : The DATE & TIME will not be imprinted on the image file.
 - [DATE] : Only the DATE will be imprinted on the image file.
 - [DATE&TIME] : The DATE & TIME will be imprinted on the image file.
 5. Press the menu button twice and the menu will disappear.
 - ※ The Date & Time are imprinted at the bottom right side of the still image.
 - ※ The date will be imprinted as a [DATE&TIME] setting.
 - ※ TIME is imprinted in the following way : [Hour : Minute] and hours are shown using the 24 hour clock.
 - ※ If you select the continuous shooting, the date doesn't be imprinted.



Auto Focus lamp

- You can turn on and off the Auto Focus lamp
- How to set up the lamp
 1. In any mode with the exception of Voice Recording mode, press the MENU button.
 2. Press the LEFT/ RIGHT button and select the [SETUP] menu tab.
 3. Select the [AF LAMP] menu by pressing the UP/ DOWN button and press the RIGHT button.
 4. Select a desired sub menu by pressing the UP/ DOWN button and press the OK button.
 - If [OFF] is selected : The AF lamp will not light up.
 - If [ON] is selected : The AF lamp will light up.



- ※ If you select [OFF] menu and take an image in poorly lit conditions or select the [NIGHT] scene mode, the camera may not take exact focus.

Sound

- If you set the operation sound to ON, various sounds will be activated for camera startup, when button are pressed, and if there is a card error, so that you can be aware of the camera operation status.
- Setting Operation Sounds
 1. In any mode with the exception of Voice Recording mode, press the MENU button.
 2. Press the LEFT/ RIGHT button and select the [SETUP] menu tab.
 3. Select the [SOUND] menu by pressing the UP/ DOWN button and press the RIGHT button.
 4. Select a desired sub menu by pressing the UP/ DOWN button and press the OK button.
 - [SOUND] sub menu : OFF/ LOW/ MEDIUM/ HIGH
 5. Press the menu button twice and the menu will disappear.



Connecting an External Device (USB)

- You can select an external device to which you want to connect the camera using the USB cable.

- Selecting an External Device

1. In any mode with the exception of Voice Recording mode, press the MENU button.
2. Press the LEFT/ RIGHT button and select the [SETUP] menu tab.
3. Select the [USB] menu by pressing the UP/ DOWN button and press the RIGHT button.
4. Select a desired sub menu by pressing the UP/ DOWN button and press the OK button.

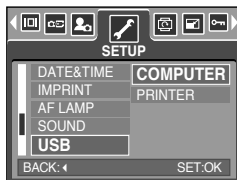

[COMPUTER] : Select this if you want to connect the camera to your PC.

Refer to page 127 for instructions on how to connect the camera to your PC.

[PRINTER] : Select this if you want to connect the camera to your printer.

Refer to page 91 for instructions on how to connect the camera to your printer.

5. Press the menu button twice and the menu will disappear.

LCD brightness

- You can adjust the LCD brightness.

- Adjusting LCD Brightness

1. In any mode with the exception of Voice Recording mode, press the MENU button.
2. Press the LEFT/ RIGHT button and select the [SETUP] menu tab.
3. Select the [LCD] menu by pressing the UP/ DOWN button and press the RIGHT button.
4. Select a desired sub menu by pressing the UP/ DOWN button and press the OK button.



[LCD] sub menu : DARK, NORMAL, BRIGHT

5. Press the menu button twice and the menu will disappear.

Selecting Video out type

- The Movie output signal from the camera can be NTSC or PAL.
Your choice of output will be governed by the type of device (monitor or TV, etc.) to which the camera is connected. PAL mode can support only BDGHI.

● Setting the Video Out Type

1. In any mode with the exception of Voice Recording mode, press the MENU button.
2. Press the LEFT/ RIGHT button and select the [SETUP] menu tab.
3. Select the [VIDEO] menu by pressing the UP/ DOWN button and press the RIGHT button.
4. Select a desired sub menu by pressing the UP/ DOWN button and press the OK button.
- [VIDEO] sub menu : NTSC, PAL
5. Press the menu button twice and the menu will disappear.

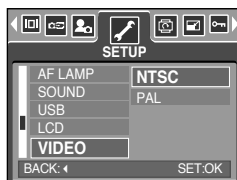

■ Connecting to an external monitor

- Using the AV cable with Cradle : Connect the camera and the cradle.
Connect the cradle to an external monitor with the supplied AV cable.
- Using the AV cable with Camera : Connect the camera to an external monitor with the supplied AV cable.

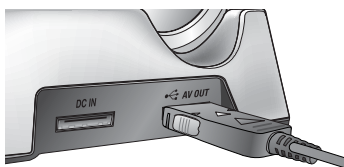

[Using the AV cable with Cradle]

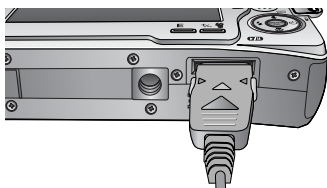

[Using the AV cable with Camera]

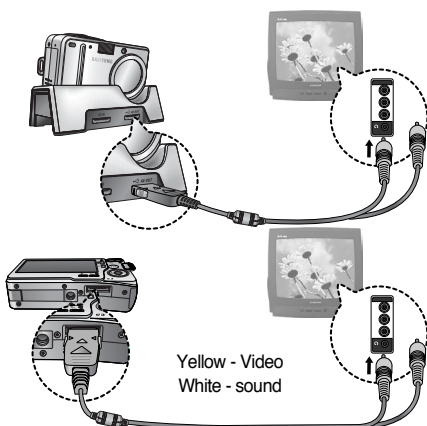

Selecting Video out type

INFORMATION

- NTSC : U.S.A, Canada, Japan, South Korea, Taiwan, Mexico.
- PAL : Australia, Austria, Belgium, China, Denmark, Finland, Germany, U.K., Holland, Italy, Kuwait, Malaysia, New Zealand, Singapore, Spain, Sweden, Switzerland, Thailand, Norway.
- When using a TV as an external monitor, you will need to select the external or AV channel of the TV.
- There will be a digital noise on the external monitor, but it is not a malfunction.
- If the image is not in the centre of the screen, use the TV controls to centre it.
- When the camera is connected to an external monitor, the menu will be visible on the external monitor and the menu functions are the same as those indicated on the LCD monitor.
- Selecting the PAL video out type, the TV monitor turns off and the LCD monitor of the camera turns on when you take a movie clip. After completing the recording, the TV monitor turns on and the LCD monitor of the camera turns off.

Quick view

- If you enable Quick View before capturing an image, you can view the image you just captured on the LCD monitor for the duration set in the [Q.VIEW] setup. Quick view is possible only with still images.

● Setting Quick View

1. In any mode with the exception of Voice Recording mode, press the MENU button.
2. Press the LEFT/ RIGHT button and select the [SETUP] menu tab.
3. Select the [Q.VIEW] menu by pressing the UP/ DOWN button and press the RIGHT button.
4. Select a desired sub menu by pressing the UP/ DOWN button and press the OK button.

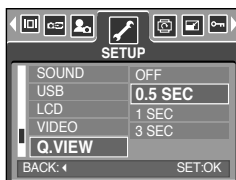

[OFF] : The quick view function can't be activated.

[0.5, 1, 3SEC] : The captured image is briefly displayed during the selected time.

5. Press the menu button twice and the menu will disappear.

Initialisation

- All camera menu and function settings will be restored to their default values. However, values for DATE/TIME, LANGUAGE, and VIDEO OUT will not be changed.

● Initialising the Camera

1. In any mode with the exception of Voice Recording mode, press the MENU button.
2. Press the LEFT/ RIGHT button and select the [SETUP] menu tab.
3. Select the [RESET] menu by pressing the UP/ DOWN button and press the RIGHT button.
4. Select a desired sub menu by pressing the UP/ DOWN button and press the OK button.



If [NO] is selected : Settings will not be restored to their defaults.

If [YES] is selected : A confirmation window will display. Select the [YES] menu and press the OK button. All settings will be restored to their defaults.

Setting up the Mycam menu

- You can set up a start up image, start up sound and shutter sound. Every camera working mode (with the exception of Voice recording mode) has the MyCAM menu. The items indicated by are default settings.

Menu tab	Main menu	Sub menu		Page
	S.IMAGE	OFF	LOGO	p.106
		USER IMAGE 1	USER IMAGE 2	
	S.SOUND	OFF	SOUND 1	p.107
		SOUND 2	SOUND 3	
	SH.SOUND	OFF	SH.SOUND 1	p.107
		SH.SOUND 2	SH.SOUND 3	

※ Menus are subject to change without prior notice.

Start up image

- You can select the image that is first displayed on the LCD monitor whenever the camera is turned on.
- Setting a Startup Image
 - In any mode with the exception of Voice Recording mode, press the MENU button.
 - Press the LEFT/ RIGHT button and select the [MYCAM] menu tab.
 - Select the [S.IMAGE] menu by pressing the UP/ DOWN button and press the RIGHT button.
 - Select a desired sub menu by pressing the UP/ DOWN button and press the OK button.
 - Press the menu button twice and the menu will disappear.

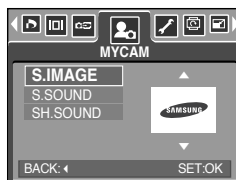

INFORMATION

- Use a saved image for the start-up image with the [USER IMAGE] in the [RESIZE] menu in the play mode.
- The start-up image will not be deleted by [DELETE ALL] or [FORMAT] menu.
- The User images will be deleted by [RESET] menu.

Start up sound

- You can select the sound that is activated whenever the camera is turned on.
- Setting the Startup Sound
 1. In any mode with the exception of Voice Recording mode, press the MENU button.
 2. Press the LEFT/ RIGHT button and select the [MYCAM] menu tab.
 3. Select the [S.SOUND] menu by pressing the UP/ DOWN button and press the RIGHT button.
 4. Select a desired sub menu by pressing the UP/ DOWN button and press the OK button.
 5. Press the menu button twice and the menu will disappear.

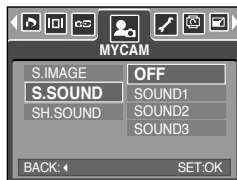

Shutter sound

- You can select the shutter sound.
- Selecting the Shutter Sound
 1. In any mode with the exception of Voice Recording mode, press the MENU button.
 2. Press the LEFT/ RIGHT button and select the [MYCAM] menu tab.
 3. Select the [SH.SOUND] menu by pressing the UP/ DOWN button and press the RIGHT button.
 4. Select a desired sub menu by pressing the UP/ DOWN button and press the OK button.
 5. Press the menu button twice and the menu will disappear.



Important notes

Be sure to observe the following precautions!

- This unit contains precision electronic components. Do not use or store this unit in the following locations.
 - Areas exposed to severe changes in temperature and humidity.
 - Areas exposed to dust and dirt.
 - Areas exposed to direct sunlight or the inside of a vehicle in hot weather.
 - Environments where there is high magnetism or excessive vibration.
 - Areas with high explosives or highly flammable materials.

- Do not leave this camera in places subject to dust, chemicals (like naphthalene and mothball), high temperature and high humidity.
Keep this camera with silica gel in a hermetically sealed box when not planning to use the camera for a long period of time

- Sand can be particularly troublesome to cameras.
 - Do not let sand get inside the unit when using it on beaches, coastal dunes, or other areas where there is lots of sand.
 - Doing so may result in failure or may permanently render the unit unusable.

- Handling the camera
 - Never drop the camera or subject it to severe shocks or vibrations.
 - Prevent the large size LCD monitor from an impact. When this camera is not used, keep this camera in the camera case.
 - Avoid obstructing the lens or the flash when you capture an image.
 - This camera is not waterproof.
To avoid dangerous electrical shocks, never hold or operate the camera with wet hands.
 - If you use this camera in wet places, such as beach or pool, do not let water or sand get inside the camera. Doing so may result in failure or may permanently damage the unit.

- Extremes in temperature may cause problems.
 - If the camera is transferred from a cold to a warm and humid environment, condensation can form on the delicate electronic circuitry. If this occurs, turn the camera off and wait for at least 1 hour until all moisture is dispersed. Moisture build up can also occur in the memory card. If this happens, turn off the camera and remove the memory card. Wait until the moisture has dispersed.

Important notes

■ Caution on Using the Lens

- If the lens is subjected to direct sunlight, it could result in discoloration and deterioration of the image sensor.
- Pay attention not to get fingerprints or foreign substances on the surface of the lens.
- When the lens cover opens, the outer lens that you can see is for auto focus. When using or cleaning this camera, handle the outer lens with care.

■ If the digital camera is not used for a long period, an electric discharge can occur.

It is a good idea to remove the battery and the memory card if you do not intend using the camera for an extended period of time.

■ If the camera is exposed to an electronic interference, it will turn itself off to protect the memory card.

■ Camera Maintenance

- Use a soft brush (available from photo stores) to gently clean the lens and LCD assemblies. If this does not work, lens-cleaning paper with lens cleaning fluid can be used. Clean the camera body with a soft cloth. Do not allow this camera to come into contact with solvent materials such as benzol, insecticide, thinners etc. This may damage the body shell of the camera and also affect its performance. Rough handling can damage the LCD monitor. Take care to avoid damage and keep the camera in its protective carry case at all times when not in use.

■ Do not attempt to disassemble or modify the camera.

■ Under certain conditions, static electricity can cause the flash unit to fire. This is not harmful to the camera and is not a malfunction.

■ When images are uploaded or downloaded(when the charger and USB cable are inserted into the cradle at the same time), the data transfer may be affected by static electricity. In this case, disconnect and re-connect the USB cable before trying the transfer again.

■ Before an important event or going on a trip, you should check the camera condition.

- Take a picture for testing the camera condition and prepare extra battery.
- Samsung cannot be held responsible for camera malfunctions.

Warning indicator

- There are several warnings that may appear on the LCD display

CARD ERROR!

- Memory card error
 - Turn off the camera power and turn it on again
 - Insert the memory card again
 - Insert the memory card and format the memory card (p.99)

MEMORY ERROR!

- Internal memory error
 - Turn off the camera power and turn it on again
 - Format the memory with the memory card removed. (p.99)

CARD LOCKED!

- The memory card is locked
 - SD memory card : Slide the write protect switch to the top of the memory card

CARD FULL!/ MEMORY FULL!

- There is insufficient memory capacity to take an image
 - Insert a new memory card
 - Delete unnecessary image files to free up some memory

NO IMAGE!

- There are no images stored on the memory
 - Take images
 - Insert a memory card that is holding some images

FILE ERROR!

- File error
 - Format the memory card
- Memory card error
 - Contact a camera service centre

LOW BATTERY!

- There is low battery capacity
 - Insert charged battery

Warning indicator

LOW LIGHT!

- When taking pictures in dark places
→ Take pictures in Flash Photography mode.

OUT OF NUMBER

- When selecting too many printing pages in the PictBridge menu.
→ Select printing page within the limitation.

Before contacting a service centre

- Please check the following

The camera doesn't switch on

- There is low battery capacity
→ Insert charged battery (p.17)
- Battery are inserted incorrectly with the polarities reversed
→ Insert the battery according to the polarity marks (+, -)
- The rechargeable battery is not inserted
→ Insert the battery and turn on the camera

The camera power ceases while in use

- The battery are exhausted
→ Insert charged battery
- The Camera is turned off automatically
→ Turn on the camera power again.

Battery drain quickly

- The Camera is being used in low temperatures
→ Keep the camera in warm conditions (i.e. inside a coat or jacket) and only remove it in order to take images

Before contacting a service centre

Camera does not take images when pressing the Shutter button

- There is insufficient memory capacity
 - Delete unnecessary image files
- The memory card has not been formatted
 - Format the memory card (p.99)
- The memory card is exhausted
 - Insert a new memory card
- The memory card is locked
 - Refer to [CARD LOCKED!] error message (p.110)
- The camera's power is off
 - Turn the camera power on
- The battery are exhausted
 - Insert charged battery.
- Battery is inserted incorrectly with the polarities reversed
 - Insert the battery according to the polarity marks (+, -)

The camera suddenly stops working while in use

- The camera was stopped due to a malfunction
 - Remove /re-insert battery and switch the camera on

The images are unclear

- A picture was taken the subject without setting an appropriate macro mode
 - Select an appropriate macro mode to take a clear image.
- The picture was taken with the subject beyond the flash range
 - Take a picture within the flash range
- The lens is smudged or dirty
 - Clean the lens

The flash does not fire

- Flash off mode has been selected
 - Dis-engage flash off mode
- The camera mode can't use the flash
 - Refer to the FLASH instruction (p.37)

Incorrect date and time is displayed

- The date and time have been set incorrectly or the camera has adopted the default settings
 - Reset the date and time correctly

Before contacting a service centre

The camera buttons do not operate

- Camera malfunction
 - Remove /re-insert battery and switch the camera on

A card error has occurred while the memory card is in the camera.

- Incorrect memory card format
 - Re-format the memory card

The images don't play back

- Incorrect file name (Violation of DCF format)
 - Do not change the image file name

Colour of image is different to the original scene

- White balance or effect setting is incorrect
 - Select appropriate White balance and effect

Images are too bright

- Exposure is excessive
 - Reset exposure compensation

No image on external monitor

- The external monitor has not been connected properly with the camera
 - Check the connection cables
- There are incorrect files in the memory card
 - Insert a memory card that has correct files

When using the PC's explorer, the [Removable Disk] file does not show

- Cable connection is incorrect
 - Check the connection
- The camera is off
 - Turn the camera on
- The operating system is not Windows 98, 98SE, 2000, ME, XP/ Mac OS 10.0 or later.
Alternatively the PC does not support USB
 - Install Windows 98, 98SE, 2000, ME, XP/ Mac OS 10.0 or later to PC that supports USB
- The camera driver is not installed
 - Install a [USB Storage Driver]

Specifications

Image Sensor	Type	1/2.5" CCD
	Effective Pixel	Approx. 5.0 Mega-pixel
	Total Pixel	Approx. 5.2 Mega-pixel
Lens	Focal Length	SHD Lens $f = 4.6 \sim 22.2\text{mm}$ (35mm film equivalent : 28~135 mm)
	F No.	F 3.3 ~ F 4.8
	Digital Zoom	Still Image mode : 1.0X ~ 5.0X, Movie Clip mode : 1.0X ~ 2.0X Play mode : 1.0X ~ 9.0X (depends on image size)
Viewfinder	LCD Monitor	2.8" Wide color TFT LCD (195,840 dot)
Focusing	Type	TTL auto focus
	Range	Normal : 80cm ~ infinity Macro : 2cm ~ 80cm (Wide), 14cm ~ 80cm (Tele) Auto Macro : 5cm ~ infinity (Wide), 14cm ~ infinity (Tele)
Shutter	Type	Mechanical and Electronic shutter
	Speed	1 ~ 1/2,000 sec. (Night Scene mode : 16 ~ 1/2,000 sec.)
Exposure	Control	Program AE Metering : Multi, Center-weighted, Spot
	Compensation	$\pm 2\text{EV}$ (1/3EV steps)
	ISO Equivalent	Auto, 50, 100, 200, 400
Flash	Modes	Auto, Auto & Red-eye reduction, Fill-in, Slow sync, Off
	Range	Wide : 0.3m~ 3.0m, Tele : 0.3m~ 2.0m
	Recharging Time	Approx. 5 sec.
Sharpness		Soft, Normal, Vivid
Effect		Normal, B&W, Sepia, Red, Green, Blue, Negative, RGB
White Balance		Auto, Daylight, Cloudy, Fluorescent_H, Fluorescent_L, Tungsten, Custom
Voice Recording		Voice Recording (max. 1 hour) Voice Memo in Still Image (max. 10 sec.)
Date Imprinting		Off, Date, Date&Time (user selectable)
Shooting	Still Image	Modes : Auto, Program, Scene * Scene : Night, Portrait, Children, Landscape, Text, Close-up, Sunset, Dawn, Backlight, Fireworks, Beach & Snow Continuous : Single, Continuous, AEB Self-timer : 2 sec., 10 sec., Double (10sec. & 2sec.), Remote control (optional)
	Movie Clip	With audio (recording time : memory capacity dependent) Size : Wide 640x360, 384x218, 256x144 STD 640x480, 320x240, 160x120 Frame rate : 30 fps, 15 fps Movie Stabiliser (user selectable) Movie Editing (embedded) : Pause during recording, Still Image capture, Time Trimming

Specifications

Storage	Media	Internal memory : Approx. 24MB flash memory External memory : SD Card/MMC (Up to 1GB guaranteed)		
	File Format	Still Image : JPEG (DCF), EXIF 2.2, DPOF 1.1, PictBridge 1.0 Movie Clip : MP4 (MPEG-4) Audio : WAV		
	Image Size	Wide	5M : 2944x1656	4M : 2688x1512
			3M : 2304x1296	2M : 1792x1008
		STD	1M : 1280x720	VGA : 768x432
5M : 2592x1944			4M : 2272x1704	
3M : 2048x1536	2M : 1600x1200			
1M : 1024x768	VGA : 640x480			
Capacity (24MB)	5M : TIFF 1, SUPER FINE 9, FINE 18, NORMAL 27 4M : TIFF 2, SUPER FINE 12, FINE 23, NORMAL 34 3M : TIFF 2, SUPER FINE 14, FINE 28, NORMAL 41 2M : TIFF 4, SUPER FINE 23, FINE 45, NORMAL 64 1M : TIFF 10, SUPER FINE 47, FINE 74, NORMAL 106 VGA : TIFF 24, SUPER FINE 99, FINE 148, NORMAL 185 * These figures are measured under Samsung's standard conditions and may vary depending on shooting conditions and camera settings.			
Image Play	Type	Single image, Thumbnails, Slide show, Movie Clip, Album		
	Editing	Trimming, Resizing, Rotating, Effect		
Interface	Digital output connector : USB 2.0 Audio : Mono Video output : NTSC, PAL (user selectable) DC power input connector : 4.2V			
Power Source	Rechargeable battery : 3.7V Li-ion battery (SLB-1237) AC Charger : DC 4.2V, 750mA (SAC-41) * Included power source may vary depending on sales region.			
Dimensions (WxHxD)	99 x 55 x 27mm (excluding the projecting parts of the camera)			
Weight	169g (without battery and card)			
Operating Temperature	0 ~ 40°C			
Operating Humidity	5 ~ 85%			
Software	Camera Driver	Storage Driver (Windows98/98SE/2000/ME/XP, Mac OS 10.0 or later)		
	Application	Digimax Master, Digimax Reader, QuickTime Player		
Special Features	5.0 Mega-pixel, 28mm wide-angle and optical 4.8X telephoto zoom The world's first*1 2.8" Wide TMR LCD The fast response – Booting 1.3 sec, Shot-to-shot 1.0 sec. Elegant design with full metal cover Easy Charging System			

* Specifications are subject to change without prior notice.

* All trademarks are the property of their respective owners.

* 1 : Among digital cameras , introduced by August of 2005.

Software Notes

Please ensure that you read the instruction manual carefully before use.

- The attached software is a camera driver and image editing software tool for Windows.
- Under no circumstances should all or part of either the software or the user manual be reproduced.
- Copyrights for software are licensed only for use with a camera.
- In the unlikely event of a manufacturing fault, we will repair or exchange your camera. We cannot, however, be held responsible in any way for damage caused by inappropriate use.
- Using a Hand-made PC or a PC and OS that has not been guaranteed by the manufacturer is not covered by the Samsung warranty.
- Before reading this manual, you should have a basic knowledge of computers and O/S (Operating Systems).

System Requirements

For Windows	For Macintosh
PC with processor better than Pentium II 450Mz (Pentium 700MHz recommended)	Power Mac G3 or later
Windows 98/98SE/2000/ME/XP	Mac OS 10.0 or later
Minimum 64MB RAM (XP : 128MB) 200MB of available hard disk space (1GB recommended)	Minimum 64MB RAM 110MB of available hard-disk space
USB port	USB port
CD-ROM drive	CD-ROM drive
1024x768 pixels, 16-bit colour display compatible monitor (24-bit colour display recommended)	QuickTime player

About the software

After inserting the software CD provided with this camera into the CD-ROM drive, the following window should automatically run.



Before connecting the camera to the PC, you should first install the camera driver.

■ **Camera driver : This enables images to transfer between the camera and PC.**

This camera uses the USB Storage Driver as the camera driver. You can use the camera as a USB card reader. After installing the driver and connecting this camera to the PC, you can find [Removable Disk] in [Windows Explorer] or [My computer]. A USB Storage Driver is provided only for Windows. A USB Driver for MAC is not included with the Application CD. You can use the camera with Mac OS 10.0 or later.

■ **QuickTime Player :** The program for playing back QuickTime movies (.MP4). It can also play video files compressed with MPEG4 codec.

■ **Digimax Master : This is the all-in-on multi media software solution**

You can download, view, edit and save your digital images and movie clips with this software. This software is only compatible with Windows.

■ **Digimax Reader : Text recognition program**

You can save an image file that was captured in the TEXT mode as a text file with this program. This software is only compatible with Windows.

INFORMATION

- Be sure to check the system requirements before installing the driver.
- You should allow 5~10 seconds for running the automatic setup program according to the capability of your computer. If the frame does not show, run the [Windows Explorer] and select [Samsung.exe] in the CD-ROM Drive root directory.

Setting up the application software

To use this camera with a PC, install the application software first.

After this has been done, the stored images in the camera can be moved to the PC and can be edited by an image editing program.

INFORMATION

- Close other programs before installing the application software.
- Before installing the application software, disconnect the USB connection.

You can visit the Samsung web-site through the internet.

<http://www.samsungcamera.com> : English

<http://www.samsungcamera.co.kr> : Korean

1. Click the [Install] menu in the Auto run frame.
The camera driver is installed automatically.

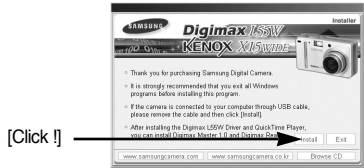

2. Installation is complete.
Click the [Finish] button.

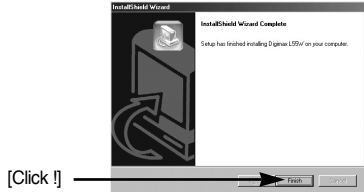

3. The Software License Agreement window for DirectX will be displayed.
If you agree to this, select [I accept the agreement] and click [Next >] button. the window will then move to the next step. If you disagree, select [I do not accept the agreement] and click [Cancel] button.

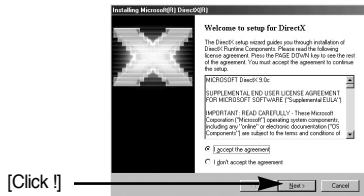

The installation program will be cancelled.

Setting up the application software

4. A window will open. Click the [Next(N) >] button.

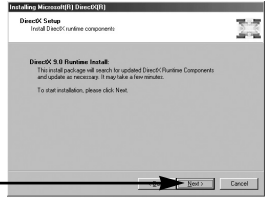

[클릭]

5. DirectX Installation is completed. Click the [Finish] button and then the QuickTime installation will be started.

- * The system will not reboot even if you click the [Finish] button.
- * The screen shot of step 5 can be different from the illustration depending on the system requirements.

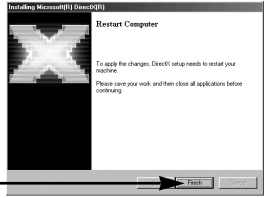

[Click]

6. Click [Next >] to begin installing QuickTime.

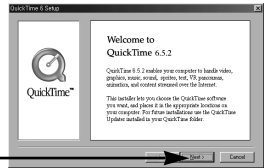

[Click]

7. A Welcome window will appear. Click [Next >] to proceed to the next screen.

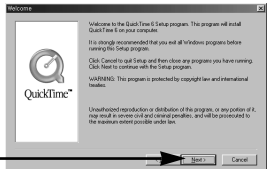

[Click]

Setting up the application software

8. The Software License Agreement window will open, asking you to agree to the licensing. Use the button on the bottom left to select the language of your choice, and then click [Agree] to accept the license agreement. The installation will proceed to the next stage. If you do not agree to the license agreement, click [Disagree]. The installation will be canceled. If the language of your choice is not listed, please select [English].

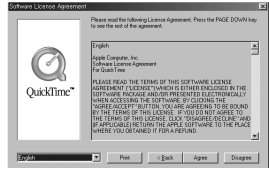

9. A window will open, asking you to select a destination folder where the files will be copied to. Click [Next >]. To copy the files to another folder, click [Browse...] Browse to a folder you want to copy the files to.

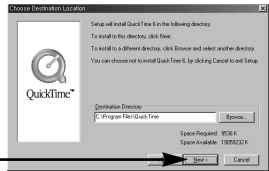

10. The Choose Installation Type window will open.

Click [Next >].

[Minimum] : Installs required files only.

[Recommended] : Installs required files and the most commonly used optional files.

[Custom] : Allows you to install only the components you choose.

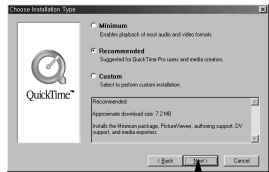

11. A window will open, asking you to choose a folder to which program icons will be added. Click [Next >].

If you want to add the program icons to a different folder, choose another folder, and then click [Next >].



12. The Enter Registration window appears.

Enter your name and organization in the respective fields, and then click [Next >].

You do not have to enter a registration number.

